

RS 175

Digital Wireless Headphone System



Instruction Manual

Contents

Important safety information	3
The RS 175 digital wireless headphone system	6
Package includes	7
Product overview	8
Overview of the HDR 175 headphones	8
Overview of the TR 175 transmitter	9
Overview of indicators	10
Putting the RS 175 into operation	13
Setting up the transmitter	13
Connecting the transmitter to an audio source	14
Connecting the transmitter to an AC wall outlet	18
Inserting and replacing the rechargeable batteries	19
Charging the rechargeable batteries	20
Adjusting the headband	21
Using your RS 175 headphone system	22
Switching your wireless headphone system on	22
Selecting an audio input	23
Adjusting the volume	23
Muting/unmuting the headphones	23
Activating/Deactivating the virtual surround sound	24
Activating/Deactivating the dynamic bass boost	25
Pairing headphones to the transmitter	26
Switching your wireless headphone system off	27
Cleaning and maintaining the RS 175	28
Replacing the ear pads	28
Troubleshooting	29
Sound problems	29
Other problems	30
Leaving the range of the transmitter	31
Clearing the pair settings on the headphones	31
Specifications	32
Manufacturer declarations	33



Important safety information

- ▶ Read this instruction manual carefully and completely before using the product.
- ▶ Always include this safety guide when passing the product on to third parties.
- ▶ Do not use an obviously defective product.

Preventing damage to health and accidents

- ▶ Protect your hearing from high volume levels. Permanent hearing damage may occur when headphones are used at high volume levels for long periods of time. Sennheiser headphones sound exceptionally good at low and medium volume levels. 
- ▶ Do not use the product in situations which require special attention (e.g. in traffic or when performing skilled jobs).
- ▶ Keep the headphones at least 10 cm/3.94" from cardiac pacemakers or implanted defibrillators. The headphones contain magnets that generate a magnetic field which could cause interference with cardiac pacemakers and implanted defibrillators.
- ▶ Do not use the product near water and do not expose it to rain or moisture to reduce the risk of fire or electric shock.
- ▶ Keep the product, accessories and packaging parts out of reach of children and pets to prevent accidents and choking hazards.
- ▶ Use only power supply units provided by Sennheiser.

Preventing damage to the product and malfunctions

- ▶ Always keep the product dry and do not expose it to extreme temperatures to avoid corrosion or deformation. The normal operating temperature is from 0 to 40°C/32 to 104°F.
- ▶ Use the product with care and store it in a clean, dust-free environment.
- ▶ Do not use the product if it is obviously defective, if it has been dropped or if liquids or objects have gotten inside the product. In this case, contact a qualified specialist workshop or your Sennheiser service partner to have the product checked.
- ▶ Switch the headphones off after use to conserve battery power. Remove the batteries if the product will not be used for extended periods of time.
- ▶ Unplug the power supply unit from the AC wall outlet
 - to completely disconnect the product from the power source,
 - during lightning storms, or
 - when unused for long periods of time.
- ▶ Ensure that the power supply unit is
 - in a safe operating condition and easily accessible,
 - properly plugged into the AC wall outlet,
 - operated only within the permissible temperature range,
 - not exposed to direct sunlight for longer periods of time in order to prevent heat accumulation.
- ▶ Do not place your headphones on a glass dummy head, chair armrest or similar objects for long periods as this can widen the headband and reduce the contact pressure of the headphones.

- ▶ Varnish or furniture polish may degrade the feet of the transmitter, which could stain your furniture. You should therefore place the transmitter on a non-slip pad to avoid potential staining of furniture.
- ▶ Do not operate the product near heat sources.
- ▶ Clean the product only with a soft, dry cloth.
- ▶ Use only attachments/accessories/spare parts supplied or recommended by Sennheiser.

Intended use/Liability

This wireless headphone system is suitable for use with hi-fi systems, TV sets, and home cinema systems and supports both analog and digital signals simultaneously.

This product is intended for private domestic use only. It is not suitable for commercial use. This product is also not intended to be used with portable audio devices.

It is considered improper use when this product is used for any application not named in this instruction manual and the associated product guides.

Sennheiser does not accept liability for damage arising from abuse or misuse of this product and its attachments/accessories.

Before putting devices into operation, please observe the respective country-specific regulations.

















Safety instructions for standard/rechargeable batteries



WARNING

In extreme cases, the standard/rechargeable batteries may leak and may cause the following hazards if abused or misused:

- explosion
- fire
- heat
- smoke/gas

	Keep away from children.		Do not heat above 70°C/158°F, e.g. do not expose to sunlight or throw into fire.
	Do not expose to moisture.		When not using rechargeable batteries for extended periods of time, charge them regularly (about every 3 months).
	Do not mutilate or dismantle.		When not using the product for extended periods of time, remove the standard/rechargeable batteries.
	Observe correct polarity.		Use only rechargeable batteries and chargers recommended by Sennheiser.
	Pack/store standard/charged rechargeable batteries so that the terminals cannot contact each other – danger of shorting out/ fire hazard.		Do not continue using defective standard/rechargeable batteries and dispose of them immediately.
	Switch battery-powered products off after use.		Immediately remove standard/rechargeable batteries from an obviously defective product.
	Charge rechargeable batteries at ambient temperatures between 10 and 40°C/50 and 104°F.		Dispose of standard/rechargeable batteries at special collection points or return them to your specialist dealer.
	Do not charge standard batteries.		Do not mix standard and rechargeable batteries in the battery compartments.

The RS 175 digital wireless headphone system

Taking home entertainment to the next level, Sennheiser's RS 175 offers an impressive range of features in a compact, ergonomic package, so that you can enjoy music and television to the fullest. The Bass Boost and Surround Sound listening modes will allow you to experience your home entertainment system like never before – the former increases the audio bass response while the two virtual surround modes offer a more spatial and livelier stereo sound.

What's more, the innovative digital wireless technology ensures that signal transmission remains clear and accurate as you move from room to room. Additionally, the user-friendly design makes it easy to set up and enjoy the RS 175. The main controls are located on the headphones, so nothing will distract you from an exciting audio experience, and the comfortable fit is ideal for extended periods of use.

Sennheiser's RS 175: Home entertainment just got more entertaining!

Features

- Closed, circumaural headphones with excellent digital wireless audio transmission
- Exceptional digital audio clarity and transmission range of up to 100 m/328 ft (line of sight)
- Enables switching between dynamic bass and virtual surround sound listening modes for situational sound customization
- Supports analog and digital audio inputs and allows toggling between the inputs
- Intelligently designed controls for maximum ease of use
- Multi-purpose transmitter – also functions as "easy-charge" cradle and docking station
- Multi-receiver transmission – transmitter supports up to two pairs of headphones simultaneously
- Ergonomic design for enhanced wearing comfort
- 2-year warranty



Package includes



HDR 175 headphones

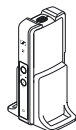

TR 175 transmitter



Power supply unit with multi-country adapters
(EU, UK, US, AU)

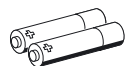

Low self-discharge NiMH rechargeable batteries, AAA size



Optical digital cable, 1.5 m



Stereo audio cable with 3.5 mm jack plugs, 2 m



Quick guide



Safety guide

Product overview

Overview of the HDR 175 headphones

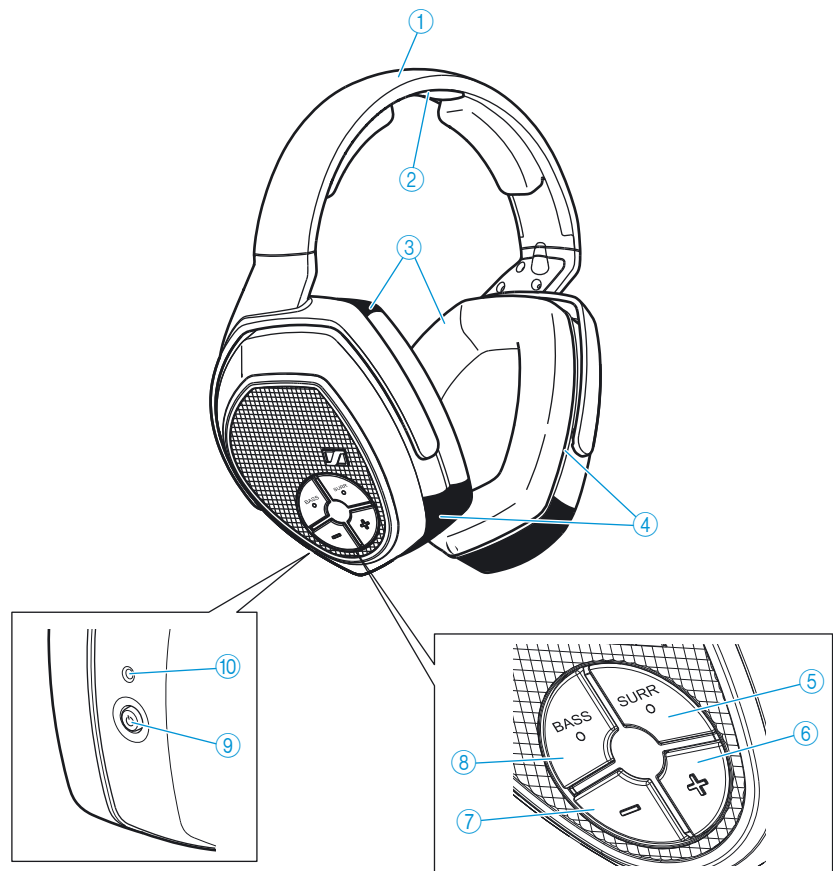

- ① Headband
- ② Charging contacts
- ③ Ear pads
- ④ Ear cups/Battery compartments
- ⑤ SURR Virtual surround sound button
- ⑥ Volume + button
- ⑦ Volume - button
- ⑧ BASS button
- ⑨ HDR power button 
- ⑩ HDR status LED

Overview of the TR 175 transmitter

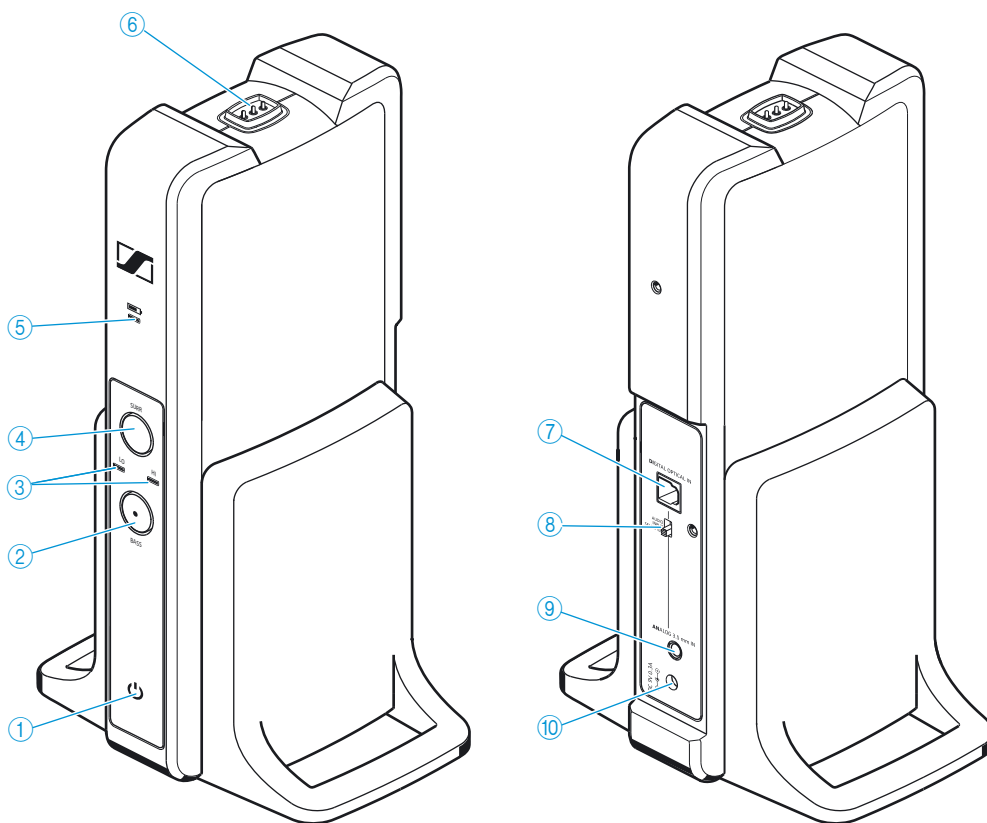

- ① TR status LED
- ② **BASS** button (with LED indicator)
- ③ Virtual surround sound LED indicators, low **LO** and high **HI**
- ④ **SURR** Virtual surround sound button
- ⑤ Charge status LED indicator
- ⑥ Charging contacts
- ⑦ **DIGITAL OPTICAL IN** Digital optical audio input
- ⑧ Input selection switch
- ⑨ **ANALOG 3.5 mm IN** Analog audio input (3.5 mm jack)
- ⑩ **DC 9V 0.3A** socket for the power supply unit

Overview of indicators

The LED indicators on the headphones and on the transmitter indicate the current operating state. If you are not using the headphones, the LED indicators automatically dim after approx. 30 seconds to not disturb you.

LED indicators on the headphones

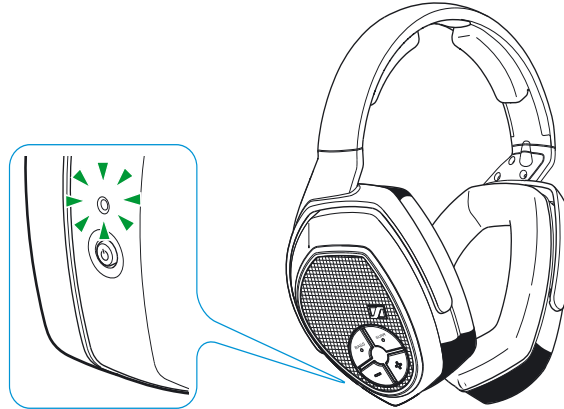

HDR status LED	Meaning
	The headphones are switched off.
	The transmitter and headphones are connected.
	The transmitter and headphones are connected and the rechargeable batteries are almost empty.
	The headphones are disconnected from or cannot connect to the transmitter.
	The headphones are disconnected from or cannot connect to the transmitter and the rechargeable batteries are almost empty.

LED indicators on the transmitter

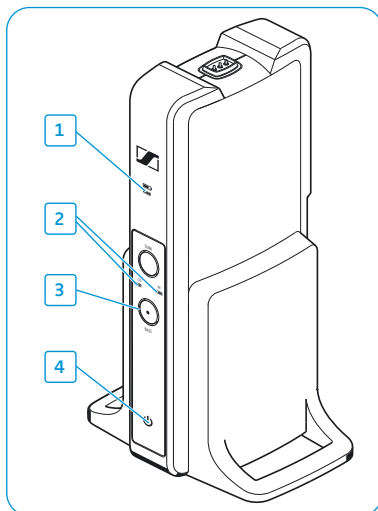





1	Charge status LED	Meaning
	○ ----- ...	The transmitter is not charging.
	 ----- ...	The rechargeable batteries are being charged.
	 ----- ...	The rechargeable batteries are fully charged.
	○ ○ ○ ○ ----- ...	A charging/battery fault has been detected.

After taking the headphones from the holder of the transmitter, the charge status LED indicates the approximate operating time of the headphones:

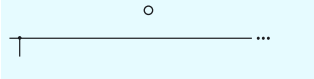
Charge status LED	Operating time	Battery capacity
○ -----	up to 4 hours	0 to 25%
○ ○ -----	approx. 4 to 9 hours	25 to 50%
○ ○ ○ -----	approx. 9 to 14 hours	50 to 75%
○ ○ ○ ○ -----	approx. 14 to 18 hours	75 to 100%

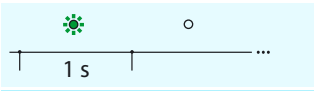
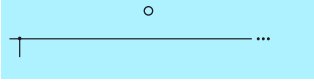
2	Surround sound LED	Meaning
	○ ----- ...	The surround sound is deactivated.
	 ----- ...	LO: Low surround sound mode is active. HI: High surround sound mode is active.

3	BASS LED	Meaning
		The dynamic bass boost is deactivated.
		The dynamic bass boost is activated.
4	TR status LED 	Meaning
		The transmitter is connected to the AC wall outlet.
		The transmitter is in standby mode.
		The transmitter and headphones are connected.
		The transmitter detects an incompatible digital audio streaming input (see page 29).

Putting the RS 175 into operation

Setting up the transmitter

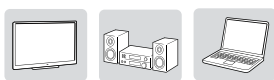

- ▶ Choose a suitable place near your audio source.
- ▶ Separate the transmitter and other wireless devices in a room by at least 50 cm/20" to avoid interference.
- ▶ Do not place the transmitter close to metal objects such as shelf bars, reinforced concrete walls, etc. as this can decrease the cover range of the transmitter.

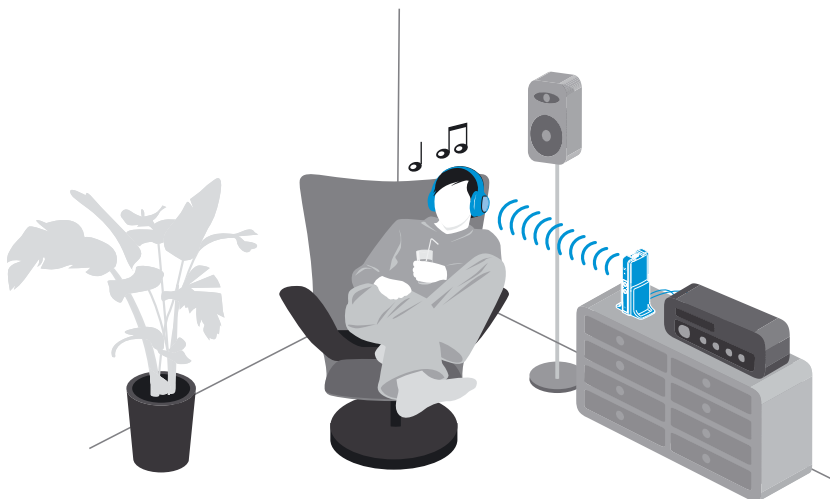

Connecting the transmitter to an audio source

You can simultaneously connect 2 different audio sources (e.g. a TV and a stereo hi-fi system) to the transmitter. The transmitter features a digital as well as an analog audio input. If you connect 2 audio sources, you can toggle between them using the **AUDIO INPUT SELECTION** switch (see page 23).

i You can also refer to the beginner's video guides on how to connect your digital wireless headphone system to a TV at www.sennheiser.com/how-to-videos.

- ▶ Switch your audio source off before connecting the transmitter.
- ▶ Check the connection options available for your audio source (audio output, usually marked "OUT").
- ▶ Select the corresponding connection cable and, if necessary, a suitable adapter.
- ▶ Depending on the connection option selected, go to the respective chapter and follow the instructions on how to connect the transmitter to an audio source.

Connection options available for your audio source	Connection cable	Page
A Optical (digital)	Optical digital cable	15
B 3.5 mm or 6.3 mm/1/4" jack socket (analog)	Stereo audio cable; in case of a 6.3 mm/ 1/4" jack socket: with adapter 3.5 mm jack socket to 6.3 mm/ 1/4" jack plug (to be ordered separately)	16
C RCA (analog)	Stereo audio cable with adapter 3.5 mm jack socket to 2 RCA plugs (to be ordered separately)	17

i You can purchase accessories and adapters from your local Sennheiser partner.

A

Connection option A: Optical (digital)

To achieve the best possible listening experience, we recommended that you connect your RS 175 headphone system to your home cinema or hi-fi system using the supplied optical digital cable.

Your wireless headphone system allows digital audio streaming using only PCM audio output from devices connected through the optical digital input **DIGITAL OPTICAL IN**. Refer to the sound menu or the instruction manual of your device to change from another audio stream (e.g. Bitstream) to PCM.

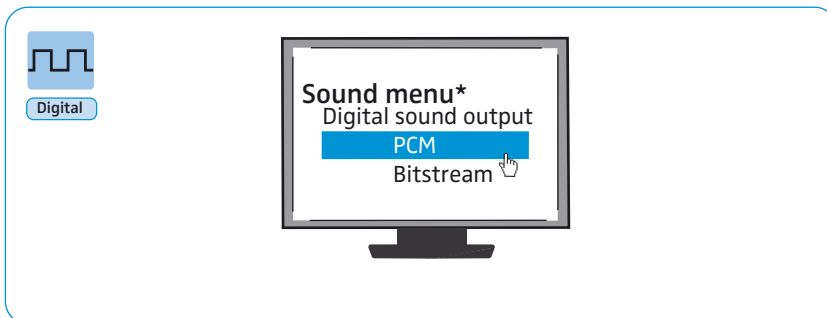

* The appearance of the Sound menu can vary depending on the device you are using.

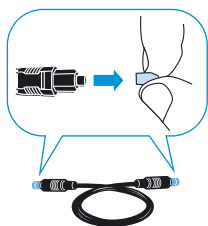

- ▶ Switch your audio source off before connecting the transmitter.
- ▶ Pull off the clear protective caps from both plugs before connecting the cable.
- ▶ Connect one end of the optical digital cable to the **DIGITAL OPTICAL IN** input of the transmitter and the other end to the optical output of your audio source.

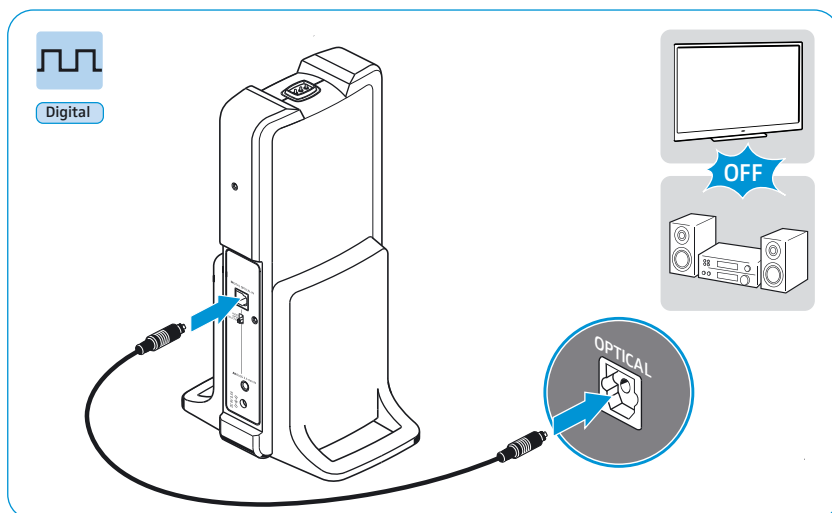

B

Connection option B: 3.5 mm or 6.3 mm/¼" jack socket (analog)

Some TV models mute the loudspeakers when you connect the transmitter to the headphone socket. Check in the menu of your TV to see if the muting function can be deactivated. Alternatively, connect the TV and the transmitter using a different option (A or C).

- ▶ Switch your audio source off before connecting the transmitter.
- ▶ If necessary, connect the adapter 6.3 mm/¼" jack plug onto the stereo audio cable.
- ▶ Connect the stereo audio cable to the 3.5 mm jack socket of the transmitter and to the headphone socket of your audio source.

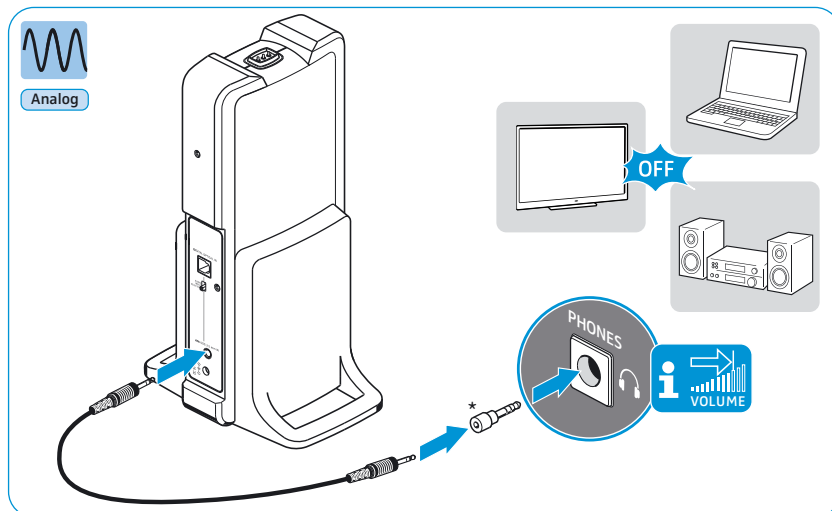

* optional accessory

i Adjust the volume of the headphone socket on your audio source to at least about the medium level.

C

Connection option C: RCA (analog)

- ▶ Switch your audio source off before connecting the transmitter.
- ▶ Plug the RCA adapter onto the stereo audio cable.
- ▶ Connect the stereo audio cable to the 3.5 mm jack socket of the transmitter.
- ▶ Connect the RCA plugs to the RCA outputs of your audio source (in most cases "AUDIO OUT"). Connect the red RCA plug to the red RCA socket and the white RCA plug to the white or black RCA socket.

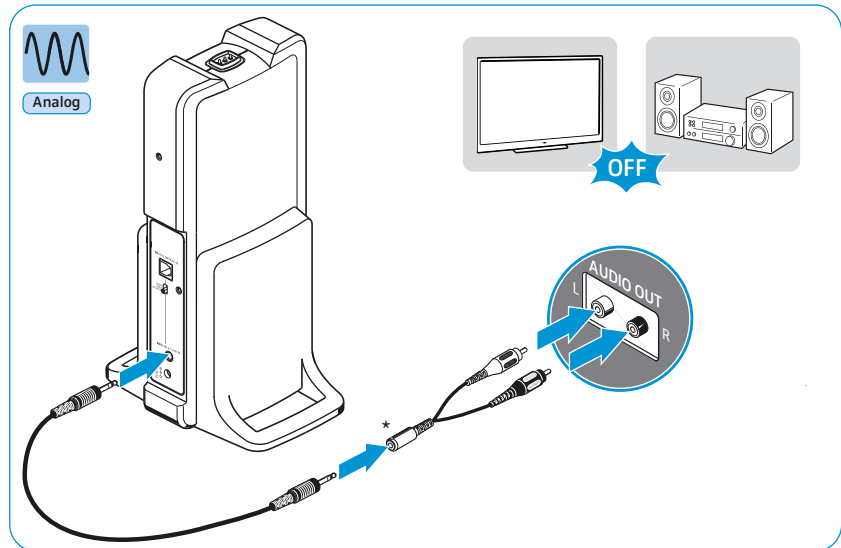

* optional accessory

Connecting the transmitter to an AC wall outlet

- 1 Select a suitable country adapter and slide it onto the power supply unit until it locks firmly in place.
- 2 Connect the power supply unit connector to the power input socket of the transmitter.
- 3 Plug the power supply unit into an AC wall outlet.
The TR status LED  lights up for a second. The transmitter is in standby mode.

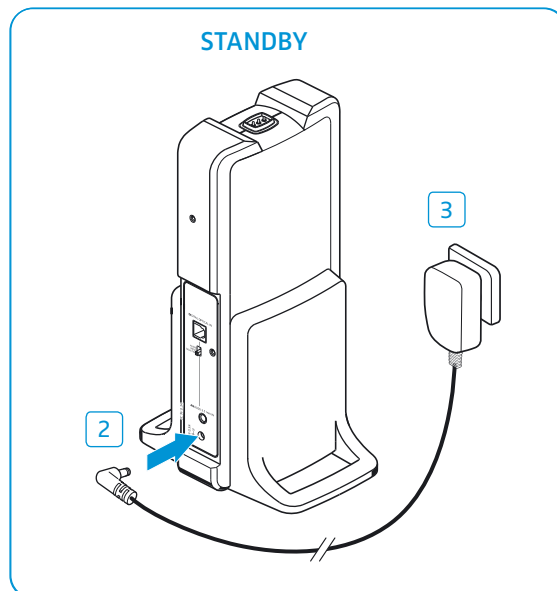
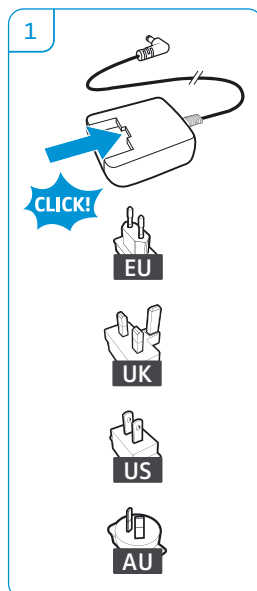

Inserting and replacing the rechargeable batteries

- 1 Lightly twist the ear pads counterclockwise until you overcome a slight resistance.
- 2 Lift the ear pads off the ear cups to reveal the battery compartments.
- 3 Insert the rechargeable batteries into the compartments. To replace the batteries, pull the batteries out of the compartments and insert the new ones. Be sure to observe correct polarity when inserting the batteries. Please dispose old batteries as special waste or return them to your specialist dealer.
- 4 Hook the ear pads onto the ear cups. As you put back the ear pads, observe the **L** (left) and **R** (right) markings on the rear of the ear pads.
- 5 Twist the ear pads clockwise until you hear a click sound. Ensure that they are locked firmly onto the ear cups.

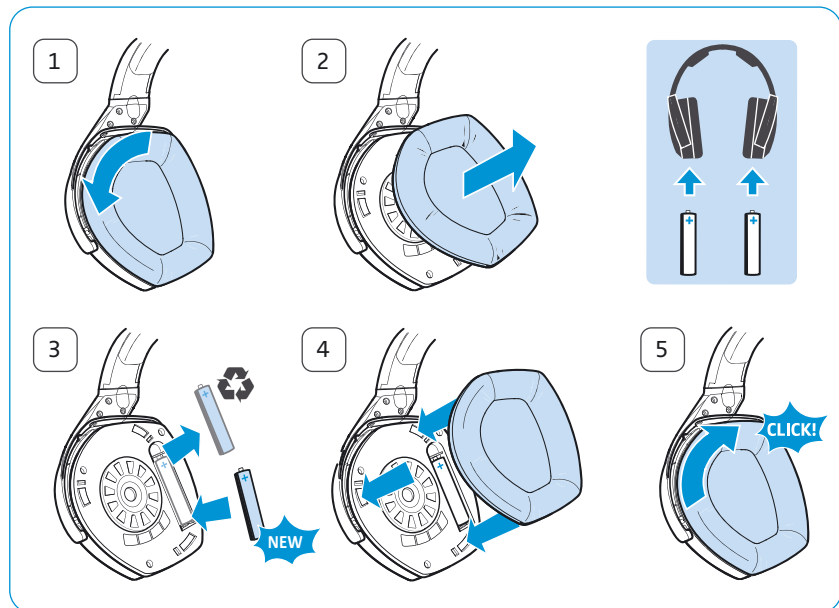

i You can also power the headphones using standard batteries (AAA size, 1.5 V). Note however, that standard batteries are not rechargeable, and if you are using non-rechargeable batteries, you must not place the headphones on the headphones holder.

Charging the rechargeable batteries

CAUTION Danger of damage to the headphones!



If you insert non-rechargeable batteries into the battery compartments, the batteries may leak during charging and can damage your headphones.

- ▶ Do not place the headphones on the headphones holder if you are using non-rechargeable batteries.



In general, a complete charging cycle takes about 8.5 hours. However, before using the headphones for the first time, charge the rechargeable batteries for at least 16 hours without interruption to optimize the performance of the batteries.

When the rechargeable batteries are almost empty, the HDR status LED turns red and you hear beeps in the headphones. The headphones switch off after few minutes.

- ▶ Place the headphones on the headphones holder of the transmitter. You may place the headphones on either side provided that the charging contacts of the headphones and the transmitter connect. The headphones automatically switch off and the Charge status LED  on the transmitter lights up red. When the rechargeable batteries are fully charged, the Charge status LED  turns green.

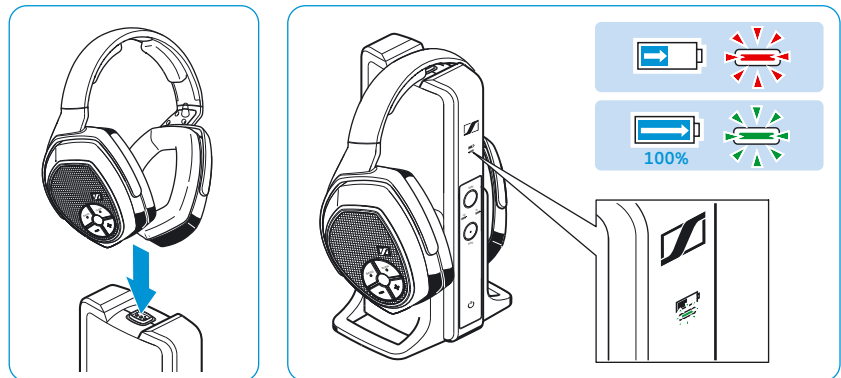

- i** When not in use, place the headphones on the headphones holder to ensure that batteries are fully charged when needed. The transmitter utilizes an intelligent battery charging technology that prevents overcharging.

After taking the headphones from the holder of the transmitter, the Charge status LED indicates the approximate operating time of the headphones (see page 11).

Adjusting the headband

For good sound quality and best possible wearing comfort, the headband has to be adjusted to properly fit your head. The headphones feature an adjustable headband with a snap-in locking mechanism for easy adjustment.

- ▶ Wear the headphones so that the headband runs over the top of your head. Observe the **L** (left) and **R** (right) markings on the outer headband when putting the headphones on.
- ▶ Adjust the length of the headband until
 - your ears are comfortably covered by the ear pads,
 - you feel even, gentle pressure around your ears,
 - a snug fit of the headband on the head is ensured.

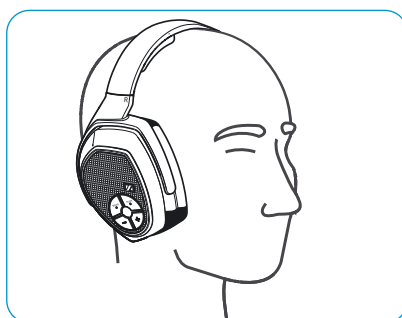

Using your RS 175 headphone system

Switching your wireless headphone system on



WARNING

Danger due to high volume levels!

Listening at high volume levels can lead to permanent hearing defects.

- ▶ Before putting the headphones on and before toggling between your audio inputs, adjust the volume on the headphones to a low level. Toggling between different inputs may cause enormous volume jumps that can damage your hearing.
- ▶ Do not expose yourself to high volume levels for long periods of time.

- 1 Switch your audio source on.



If you are using the headphone socket (see page 16) to connect to your audio source, adjust the volume of the headphone socket on your audio source (e.g. TV) to at least the medium level.

- 2 Push the **AUDIO INPUT SELECTION** switch up or down to select your audio source (see page 23).
The status LED  on the transmitter lights up green.

- 3 Press and hold the HDR power button  for approx. 2 seconds to switch the headphones on.

The transmitter in standby mode recognizes the active paired headphones and automatically transmits a signal. The status LEDs on the transmitter and the headphones light up green.

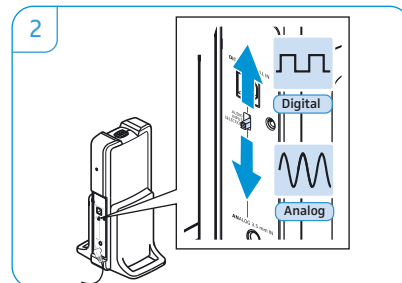
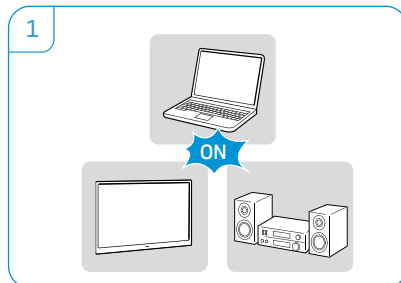

If the headphones are brought outside the transmission range or if there is no audio signal received from the transmitter for more than 5 minutes, the headphones switch off automatically.

Selecting an audio input

If both analog and digital audio inputs are connected to different audio sources, the headphone system enables you to toggle between the two inputs.

- ▶ Push the **AUDIO INPUT SELECTION** switch up to listen to an audio source connected to the digital optical input (see page 15).
- ▶ Push the **AUDIO INPUT SELECTION** switch down to listen to an audio source connected to the analog input (see pages 16 and 17).

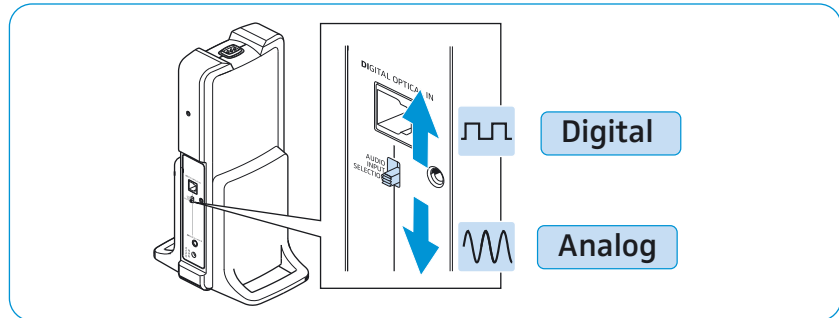

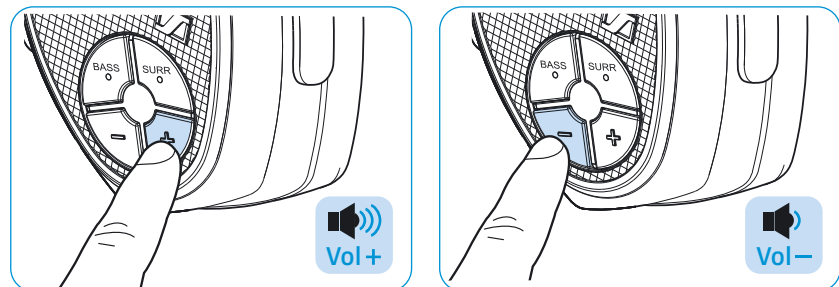

Adjusting the volume

- ▶ Press the Volume + button or the Volume – button repeatedly until the volume is adjusted to the desired level. When the minimum or maximum volume setting is reached, you hear a beep in the headphones.



Muting/unmuting the headphones

- ▶ Press the HDR power button  to mute the headphones.
- ▶ Press the HDR power button  or any of the Volume +/- buttons to cancel the muting.

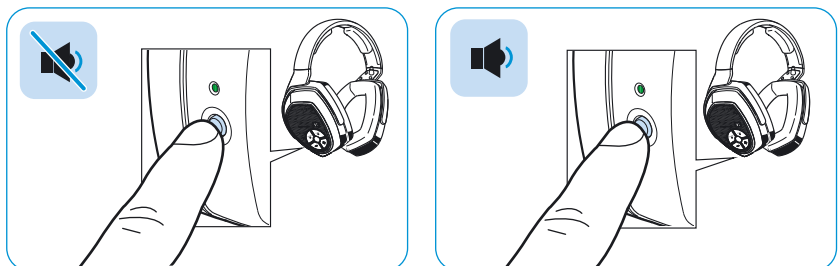

- i** If the headphones are muted for 15 minutes, the headphones switch off automatically to save energy.

Activating/Deactivating the virtual surround sound

The RS 175 headphone system offers two virtual surround modes (high **HI**/low **LO**) that simulate the sound generated by external stereo speakers, thus, producing spatial and livelier sound.

The intensity of the surround effect however differs according to the mode selected. Depending on your personal preference for spatial sound quality, you can set the mode to either high **HI** or low **LO**.

- ▶ Press the **SURR** button on the headphones or the transmitter. The surround effect toggles between off and the 2 surround sound modes, as indicated by the **LO**, **HI** LEDs.

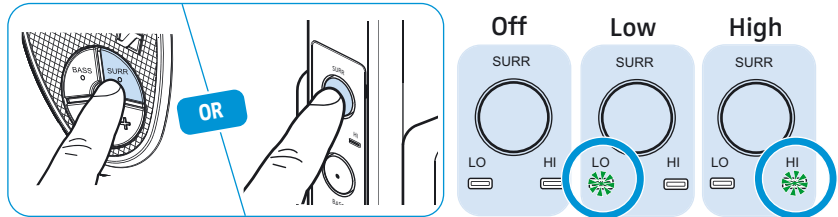



Surround sound LED	Meaning
	Virtual surround sound is off.
	Low LO virtual surround sound mode is active.
	High HI virtual surround sound mode is active.

Activating/Deactivating the dynamic bass boost

The dynamic bass boost increases the audio bass response.

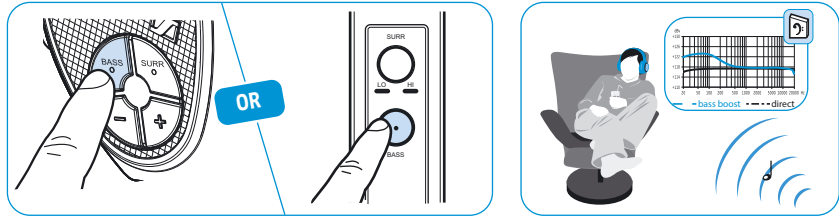
- ▶ Press the **BASS** button either on the headphones or the transmitter. The bass boost effect switches between on and off modes, as indicated by the **BASS** LED indicator.



BASS LED	Meaning
	The bass boost effect is active.
	The bass boost effect is inactive.

Pairing headphones to the transmitter

The headphones and the transmitter enclosed in this package have been paired from the factory. The following procedure is only necessary if you have cleared all pairing information from your wireless headphone system and you want to revive the lost pairing, or if you want to pair another set of headphones to the transmitter.

You can connect up to 2 paired headphones simultaneously with your TR 175 transmitter.

- ▶ Place the headphones on the headphones holder of the transmitter for a second.

The Charge status LED  on the transmitter lights up red. The headphones are paired to the transmitter.

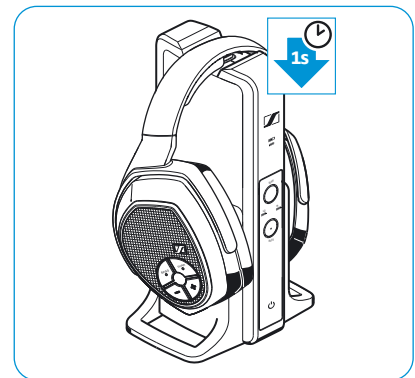

Switching your wireless headphone system off

There are two ways to switch your wireless headphone system off.

A

- ▶ Press and hold the HDR power button  for approx. 2 seconds. The headphones switch off. If no other pair of active wireless headphones is connected to the transmitter, the transmitter switches to standby mode. All LEDs are off.

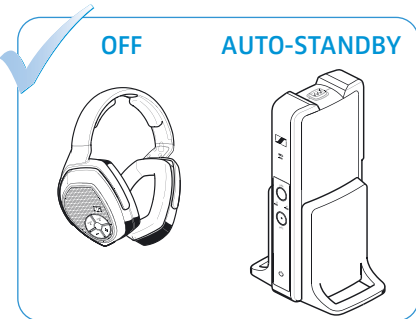
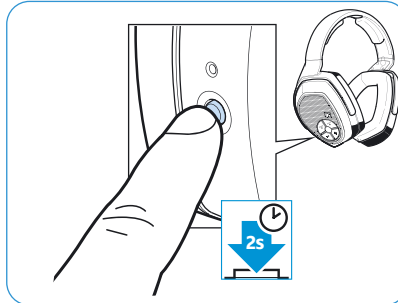

B

- ▶ Place the headphones on the headphones holder of the transmitter. The headphones switch off and the charging process starts (see page 20). If no other pair of active wireless headphones is connected to the transmitter, the transmitter switches to standby mode.

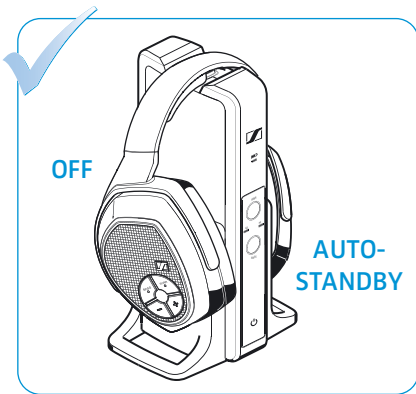

i To disconnect the transmitter from the power source, unplug the power supply unit from the AC wall outlet.

Cleaning and maintaining the RS 175

CAUTION

Liquids can damage the electronics of the product!

Liquids entering the housing of the product can cause a short-circuit and damage the electronics.

- ▶ Keep all liquids away from the product.
- ▶ Do not use any cleansing agents or solvents.

To clean the wireless headphone system:

- ▶ Switch your wireless headphone system off and disconnect the transmitter from the AC wall outlet before cleaning.
- ▶ Clean the product only with a soft, dry cloth.

Replacing the ear pads

For reasons of hygiene, you should replace the ear pads from time to time. Spare ear pads are available at your local Sennheiser partner.

- 1 Lightly twist the ear pads counterclockwise until you overcome a slight resistance.
- 2 Lift the ear pads off the ear cups and dispose of them properly.
- 3 Hook the new ear pads onto the ear cups. Observe the **L** (left) and **R** (right) markings on the rear of the ear pads.
- 4 Twist the ear pads clockwise until you hear a click sound. Ensure that they are locked firmly onto the ear cups.

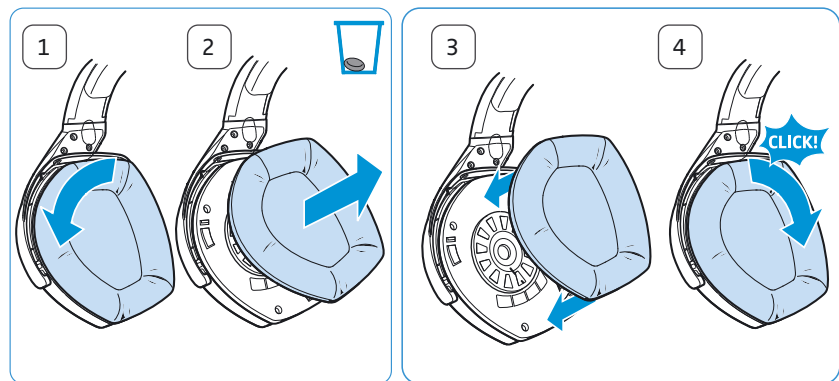

i You can have the headband padding replaced by the repair service. Please contact your Sennheiser partner.

Troubleshooting

Sound problems

Problem	Possible cause	Possible solutions	Page
No sound	Headphones are switched off.	Switch the headphones on.	22
	No power connection.	Check the connection of the power supply unit.	18
	Headphones are muted.	Deactivate the muting function.	23
	Audio plug is not properly connected.	Check the audio plug connection.	14
	Audio source is switched off.	Switch the audio source on.	–
	Volume of the analog audio source is either set to the minimum or is on mute.	Increase the volume on the audio source to at least a medium level/Deactivate the muting function from the audio source.	–
	Audio cable is defective.	Replace the audio cable.	–
	Headphones are not correctly paired with the transmitter (e.g. additional headphones).	Pair the headphones with the transmitter again.	26
	Wrong audio input is selected.	Select the other audio input.	23
	Digital audio connection uses incompatible data transmission settings.	Set the digital audio output of your device/audio source to "PCM", with a sampling rate of max. 96 kHz (see the instruction manual of your audio source).	–
Occasional sound dropouts	Headphones are out of the transmitter's range.	Reduce the distance between headphones and transmitter.	–
	Signal is shielded.	Remove obstacles between the transmitter and headphones.	–
	There are interfering devices (e.g. WLAN routers, Bluetooth devices or microwaves) in the vicinity.	Change the position of the transmitter or of the headphones. Ensure that the transmitter is separated from other wireless devices by at least 50 cm/20".	13 –
Sound is too low	Headphone volume is adjusted too low.	Increase the volume on the headphones.	23
	Volume of the analog audio source is adjusted too low.	Increase the volume on the analog audio source to at least a medium level.	–
Hear echoes and TV tone when using headphones	Some TVs can adjust a delay or latency of the audio signal for the digital audio output.	Check the audio output settings of your TV and set the latency to "0".	–
Sound only on one ear	Audio cable is not properly connected.	Check the plug connection.	14
	Audio cable is defective.	Replace the audio cable.	–
Sound is distorted	Signal of the audio source is distorted.	Reduce the volume of the audio source.	–
	Headphone volume is adjusted too high.	Reduce the volume on the headphones.	23
	Volume of the analog audio source is adjusted too high.	Decrease the volume of the analog audio source at least to a medium volume level.	–

Other problems

Problem	Possible cause	Possible solutions	Page
Transmitter does not turn on	No power connection.	Check the connection of the power supply unit.	18
Headphones do not turn on	The rechargeable batteries are almost empty.	Recharge the rechargeable batteries.	20
	No batteries inside the battery compartments.	Insert the rechargeable batteries.	19
	The rechargeable batteries are inserted the wrong way round.	Remove the rechargeable batteries from the headphones and reinsert them again. Observe correct polarity.	19
Operating time decreases	The rechargeable batteries are exhausted.	Replace the rechargeable batteries with new ones.	19
You hear beeps in the headphones	The rechargeable batteries are almost drained.	Recharge the rechargeable batteries.	20
Headphones cannot be connected to the transmitter	Distance to the transmitter is too large.	Reduce the distance to the transmitter.	–
	Headphones are not paired with the transmitter.	Pair the headphones with the transmitter.	26
	Another set of headphones is being charged so I can't pair my second headphones.	Perform a proximity pairing: 1. Place the headphones as close as possible to the transmitter. 2. Switch the headphones on. 3. Press the Volume +/- buttons simultaneously for about 7 seconds.	–
	Headphones are not compatible.	Use Sennheiser HDR 165, 175, 185, or 195 wireless headphones only.	–

If you encounter a problem that is not listed in the table, or if the solutions provided do not work, please visit the RS 175 product page at www.sennheiser.com for the most up-to-date list of frequently asked questions.

You may also contact your local Sennheiser service partner for assistance. To find a Sennheiser service partner in your country, visit www.sennheiser.com.



Leaving the range of the transmitter

The range of the transmitter largely depends on environmental conditions such as wall thickness, wall composition etc. If the headphones leave the range of the transmitter, the audio first cuts out occasionally until it finally cuts out completely.

If you re-enter the transmission range within 5 minutes, the connection is automatically re-established.

If you spend more than 5 minutes outside the transmission range, the headphones switch off automatically.

Clearing the pair settings on the headphones

- 1 Press the Volume +/- buttons simultaneously and hold for 2 seconds. The HDR status LED blinks red rapidly.
- 2 Press the HDR power button  while continuously holding the Volume +/- buttons. Release all 3 buttons. The HDR status LED lights up green or red, depending on the battery condition, and starts blinking slowly. The pair settings on the headphones are cleared.

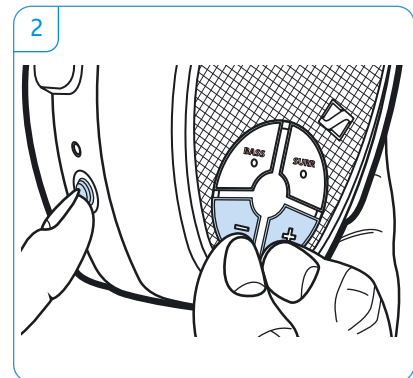
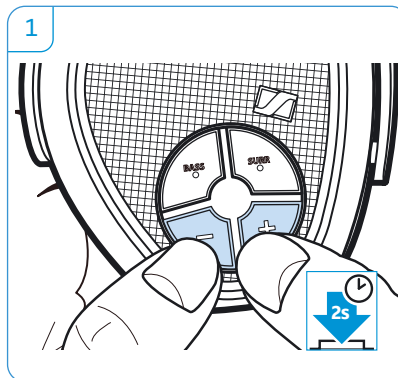

Specifications

RS 175 headphone system

Carrier frequency	2.40 to 2.48 GHz
Modulation	8-FSK Digital
SNR	analog input: typ. 85 dBA at 1 V _{rms} digital input: > 90 dBA
RF output power	max. 10 dBm
Transmission range	up to 100 m/328 ft line of sight
Max. number of simultaneously connected headphones	2
Temperature range	Operation: 0°C to +40°C/32°F to 104°F Storage: -25°C to +70°C/-13°F to 158°F
Relative humidity	Operation: 10 to 80%, non condensing Storage: 10 to 90%

HDR 175 headphones

Transducer principle	circumaural, closed
Transducer system	dynamic, neodymium magnets
Frequency response	17 Hz to 22 kHz
Max. SPL	max. 114 dB at 1 kHz, 3% THD
THD	< 0.5% at 1 kHz, 100 dB SPL
Operating time	up to 18 hours
Charging time of rechargeable batteries	up to 8 hours 30 min
Power supply	2 AAA size low self-discharge NiMH rechargeable batteries, 1.2 V, 820 mAh
Weight (incl. batteries)	approx. 310 g
Dimensions (W x H x D)	approx. 17 cm x 20 cm x 9.5 cm

TR 175 transmitter

Connections	Digital: optical Analog: 3.5 mm stereo jack socket
Power supply	9 V --- , 300 mA
Power consumption	Operation: typ. 4 W Standby mode: \leq 0.3 W (without charging)
Dimensions (W x H x D)	approx. 12.7 cm x 23.4 cm x 10 cm

Sennheiser NT 9-3AW power supply unit

Nominal input voltage/ current	100–240 V~/ 100 mA
Mains frequency	50–60 Hz
Nominal output voltage	9 V ---
Nominal output current	300 mA
Temperature range	Operation: 0 °C to +40 °C Storage: -40 °C to +85 °C
Relative humidity	Operation: 0 to 90 %, non condensing Storage: 0 bis 90 %

Manufacturer declarations

Warranty

Sennheiser electronic GmbH & Co. KG gives a warranty of 24 months on this product.

For the current warranty conditions, please visit our website at www.sennheiser.com or contact your Sennheiser partner.

FOR AUSTRALIA ONLY

Sennheiser goods come with guarantees that cannot be excluded under the Australian Consumer Law. You are entitled to a replacement or refund for a major failure and compensation for any other reasonably foreseeable loss or damage. You are also entitled to have the goods repaired or replaced if the goods fail to be of acceptable quality and the failure does not amount to a major failure.

This warranty is in addition to other rights or remedies under law. Nothing in this warranty excludes, limits or modifies any liability of Sennheiser which is imposed by law, or limits or modifies any remedy available to the consumer which is granted by law.

To make a claim under this warranty, contact Sennheiser Australia Pty Ltd, Unit 3, 31 Gibbes Street Chatswood NSW 2067, Australia; Phone: (02) 9910 6700, email: service@sennheiser.com.au

All expenses of claiming the warranty will be borne by the person making the claim.

The Sennheiser International Warranty is provided by Sennheiser Australia Pty Ltd (ABN 68 165 388 312), Unit 3, 31 Gibbes Street Chatswood NSW 2067, Australia.

In compliance with the following requirements

EU Declaration of Conformity



- ErP Directive (2009/125/EC)
- RoHS Directive (2011/65/EU)

Hereby, Sennheiser electronic GmbH & Co. KG declares that the radio equipment type RS 175 (TR 175, HDR 175) is in compliance with Directive 2014/53/EU.

The full text of the EU declaration of conformity is available at the following internet address: www.sennheiser.com/download.

Notes on disposal



- WEEE Directive (2012/19/EU)
- Battery Directive (2006/66/EC & 2013/56/EU)

The symbol of the crossed-out wheeled bin on the product, the battery/rechargeable battery and/or the packaging indicates that these products must not be disposed of with normal household waste, but must be disposed of separately at the end of their operational lifetime. For packaging disposal, please observe the legal regulations on waste segregation applicable in your country.

Further information on the recycling of these products can be obtained from your municipal administration, from the municipal collection points, or from your Sennheiser partner.

The separate collection of waste electrical and electronic equipment, batteries/rechargeable batteries and packagings is used to promote the reuse and recycling and to prevent negative effects caused by e.g. potentially hazardous substances contained in these products. Herewith you make an important contribution to the protection of the environment and public health.

Statements regarding FCC and Industry Canada

FCC Declaration of Conformity (DoC)	
 SENNHEISER Model No: TR 175, HDR 175	
We,	Sennheiser Electronic Corporation One Enterprise Drive • Old Lyme • CT 06371 • USA Tel: +1 (860) 434 9190 Fax: +1 (860) 434 1759
declare the above device comply with the requirements of Federal Communications Commission.	
This device complies with Part 15 of the FCC rules. Operation is subjected to the following two conditions:	
1) This device may not cause harmful interference, and	
2) This device must accept any interference received, including interference that may cause undesired operation.	
Responsible Party: Michael Lieske	

This device complies with Part 15 of the FCC Rules and with RSS-210 of Industry Canada. Operation is subject to the following two conditions: (1) this device may not cause harmful interference, and (2) this device must accept any interference received, including interference that may cause undesired operation.

This equipment has been tested and found to comply with the limits for a Class B digital device, pursuant to Part 15 of the FCC Rules. These limits are designed to provide reasonable protection against harmful interference in a residential installation. This equipment generates, uses and can radiate radio frequency energy and, if not installed and used in accordance with the instructions, may cause harmful interference to radio communications. However, there is no guarantee that interference will not occur in a particular installation. If this equipment does cause harmful interference to radio or television reception, which can be determined by turning the equipment off and on, the user is encouraged to try to correct the interference by one or more of the following measures:

- Reorient or relocate the receiving antenna.
- Increase the separation between the equipment and receiver.
- Connect the equipment into an outlet on a circuit different from that to which the receiver is connected.
- Consult the dealer or an experienced radio/TV technician for help.

CAN ICES-3 (B)/NMB-3(B)

RF Radiation Exposure Information

Since the radiated output power of this device is far below the FCC radio frequency exposure limits, it is not subjected to routine RF exposure evaluation as per Section 2.1093 of the FCC rules.

Trademarks

Sennheiser is a registered trademark of Sennheiser electronic GmbH & Co. KG. Other product and company names mentioned in this instruction manual may be the trademarks or registered trademarks of their respective holders.



Sennheiser electronic GmbH & Co. KG

Am Labor 1, 30900 Wedemark, Germany
www.sennheiser.com

Publ. 08/17, A04