



User Guide

© Copyright 2019 HP Development Company, L.P.

Bluetooth is a trademark owned by its proprietor and used by HP Inc. under license. DisplayPort™ and the DisplayPort™ logo are trademarks owned by the Video Electronics Standards Association (VESA®) in the United States and other countries. Intel, Celeron, Pentium, and Thunderbolt are trademarks of Intel Corporation or its subsidiaries in the U.S. and/or other countries. Lync, Office 365, Skype, and Windows are either registered trademarks or trademarks of Microsoft Corporation in the United States and/or other countries.

The information contained herein is subject to change without notice. The only warranties for HP products and services are set forth in the express warranty statements accompanying such products and services. Nothing herein should be construed as constituting an additional warranty. HP shall not be liable for technical or editorial errors or omissions contained herein.

First Edition: July 2019

Document Part Number: L66149-001

Product notice

This user guide describes features that are common to most models. Some features may not be available on your computer.

Not all features are available in all editions or versions of Windows. Systems may require upgraded and/or separately purchased hardware, drivers, software or BIOS update to take full advantage of Windows functionality. Windows 10 is automatically updated, which is always enabled. ISP fees may apply and additional requirements may apply over time for updates. See <http://www.microsoft.com>.

To access the latest user guides, go to <http://www.hp.com/support>, and follow the instructions to find your product. Then select **User Guides**.

Software terms

By installing, copying, downloading, or otherwise using any software product preinstalled on this computer, you agree to be bound by the terms of the HP End User License Agreement (EULA). If you do not accept these license terms, your sole remedy is to return the entire unused product (hardware and software) within 14 days for a full refund subject to the refund policy of your seller.

For any further information or to request a full refund of the price of the computer, please contact your seller.

Safety warning notice

 **WARNING!** To reduce the possibility of heat-related injuries or of overheating the computer, do not place the computer directly on your lap or obstruct the computer air vents. Use the computer only on a hard, flat surface. Do not allow another hard surface, such as an adjoining optional printer, or a soft surface, such as pillows or rugs or clothing, to block airflow. Also, do not allow the AC adapter to come into contact with the skin or a soft surface, such as pillows or rugs or clothing, during operation. The computer and the AC adapter comply with the user-accessible surface temperature limits defined by applicable safety standards.

Processor configuration setting (select products only)

 **IMPORTANT:** Select computer products are configured with an Intel® Pentium® N35xx/N37xx series or a Celeron® N28xx/N29xx/N30xx/N31xx series processor and a Windows® operating system. **If your computer is configured as described, do not change the processor configuration setting in msconfig.exe from 4 or 2 processors to 1 processor.** If you do so, your computer will not restart. You will have to perform a factory reset to restore the original settings.

Table of contents

1 Getting started	1
Finding information	2
2 Components	3
Locating hardware	3
Locating software	3
Right	4
Left	5
Display	6
Top	7
Bottom	9
Rear	9
Using the kickstand	11
Keyboard area (select products only)	12
Connecting the keyboard	12
Removing the keyboard	13
Connecting the leather folio keyboard	12
Removing the leather folio keyboard	15
Adjusting the leather folio keyboard	15
Touchpad settings	16
Lights	17
Special keys	18
Action keys	19
Hot keys (select products only)	21
Labels	21
Inserting a nano SIM card (select products only)	22
3 Network connections	24
Connecting to a wireless network	24
Using the wireless controls	24
Wireless button	24
Operating system controls	24
Connecting to a WLAN	25
Using HP Mobile Broadband (select products only)	25
Using GPS (select products only)	26
Using Bluetooth wireless devices (select products only)	26

Connecting Bluetooth devices	26
Using NFC to share information (select products only)	26
Sharing	27
Connecting to a wired network	27
Connecting to a local area network (LAN) (select products only)	27
Using HP LAN-Wireless Protection (select products only)	28
Turning on and customizing HP LAN-Wireless Protection	28
Using HP MAC Address Pass Through to identify your computer on a network (select products only)	29
Customizing MAC Address Pass Through	29
4 Navigating the screen	30
Using touchpad and touch screen gestures	30
Tap	30
Two-finger pinch zoom	31
Two-finger slide (touchpad and precision touchpad)	31
Two-finger tap (touchpad and precision touchpad)	31
Three-finger tap (touchpad and precision touchpad)	32
Four-finger tap (touchpad and precision touchpad)	32
Three-finger swipe (touchpad and precision touchpad)	33
Four-finger swipe (precision touchpad)	33
One-finger slide (touch screen)	34
Using an optional keyboard or mouse	34
Using an on-screen keyboard (select products only)	34
5 Entertainment features	35
Using a camera (select products only)	35
Using audio	35
Connecting speakers	35
Connecting headphones	35
Connecting headsets	36
Using sound settings	36
Using video	36
Connecting a DisplayPort device using a USB Type-C cable (select products only)	37
Connecting a Thunderbolt device using a USB Type-C cable (select products only)	38
Discovering and connecting wired displays using MultiStream Transport	39
Connect displays to computers with Intel graphics (with an optional hub)	39
Connect displays to computers with Intel graphics (with a built-in hub)	39
Discovering and connecting to Miracast-compatible wireless displays (select products only)	40
Discovering and connecting to Intel WiDi certified displays (select Intel products only)	40
Using data transfer	40
Connecting devices to a USB Type-C port (select products only)	41

6 Managing power	42
Using Sleep and Hibernation	42
Initiating and exiting Sleep	42
Initiating and exiting Hibernation (select products only)	43
Shutting down (turning off) the computer	43
Using the Power icon and Power Options	44
Running on battery power	44
Using HP Fast Charge (select products only)	44
Displaying battery charge	45
Finding battery information in HP Support Assistant (select products only)	45
Conserving battery power	45
Identifying low battery levels	45
Resolving a low battery level	46
Resolving a low battery level when external power is available	46
Resolving a low battery level when no power source is available	46
Resolving a low battery level when the computer cannot exit Hibernation	46
Factory-sealed battery	46
Running on external power	46
7 Security	48
Protecting the computer	48
Using passwords	48
Setting passwords in Windows	49
Setting passwords in Computer Setup	49
Managing a BIOS administrator password	50
Entering a BIOS administrator password	51
Using DriveLock Security Options	51
Selecting Automatic DriveLock (select products only)	52
Enabling Automatic DriveLock	52
Disabling Automatic DriveLock	52
Entering an Automatic DriveLock password	53
Selecting manual DriveLock	53
Setting a DriveLock master password	53
Enabling DriveLock and setting a DriveLock user password	54
Disabling DriveLock	55
Entering a DriveLock password	55
Changing a DriveLock password	55
Windows Hello (select products only)	56
Using antivirus software	56
Using firewall software	56



Installing software updates	57
Using HP Client Security (select products only)	57
Using HP Device as a Service (select products only)	57
Using an optional security cable (select products only)	57
Using a fingerprint reader (select products only)	57
Locating the fingerprint reader	58
8 Maintenance	59
Improving performance	59
Using Disk Defragmenter	59
Using Disk Cleanup	59
Using HP 3D DriveGuard (select products only)	60
Identifying HP 3D DriveGuard status	60
Updating programs and drivers	60
Cleaning your computer	60
Cleaning procedures	61
Cleaning the display	61
Cleaning the sides or cover	61
Cleaning the touchpad, keyboard, or mouse (select products only)	61
Traveling with or shipping your computer	61
9 Backing up, restoring, and recovering	63
Backing up information and creating recovery media	63
Using Windows tools	63
Using the HP Cloud Recovery Download Tool to create recovery media (select products only)	63
Restoring and recovery	64
Restoring, resetting, and refreshing using Windows tools	64
Recovering using HP Recovery media	64
Changing the computer boot order	64
Using HP Sure Recover (select products only)	65
10 Computer Setup (BIOS), TPM, and HP Sure Start	66
Using Computer Setup	66
Starting Computer Setup	66
Navigating and selecting in Computer Setup	66
Restoring factory settings in Computer Setup	66
Updating the BIOS	67
Determining the BIOS version	67
Downloading a BIOS update	67
Changing the boot order using the f9 prompt	68

TPM BIOS settings (select products only)	68
Using HP Sure Start (select products only)	69
11 Using HP PC Hardware Diagnostics	70
Using HP PC Hardware Diagnostics Windows (select products only)	70
Downloading HP PC Hardware Diagnostics Windows	70
Downloading the latest HP PC Hardware Diagnostics Windows version	71
Downloading HP Hardware Diagnostics Windows by product name or number (select products only)	71
Installing HP PC Hardware Diagnostics Windows	71
Using HP PC Hardware Diagnostics UEFI	71
Starting HP PC Hardware Diagnostics UEFI	72
Downloading HP PC Hardware Diagnostics UEFI to a USB flash drive	72
Downloading the latest HP PC Hardware Diagnostics UEFI version	72
Downloading HP PC Hardware Diagnostics UEFI by product name or number (select products only)	72
Using Remote HP PC Hardware Diagnostics UEFI settings (select products only)	73
Downloading Remote HP PC Hardware Diagnostics UEFI	73
Downloading the latest Remote HP PC Hardware Diagnostics UEFI version	73
Downloading Remote HP PC Hardware Diagnostics UEFI by product name or number	73
Customizing Remote HP PC Hardware Diagnostics UEFI settings	73
12 Specifications	75
Input power	75
Operating environment	76
13 Electrostatic discharge	77
14 Accessibility	78
HP and accessibility	78
Finding the technology tools you need	78
The HP commitment	78
International Association of Accessibility Professionals (IAAP)	78
Finding the best assistive technology	79
Assessing your needs	79
Accessibility for HP products	79
Standards and legislation	80
Standards	80
Mandate 376 – EN 301 549	80
Web Content Accessibility Guidelines (WCAG)	80

Legislation and regulations	80
Useful accessibility resources and links	82
Organizations	82
Educational institutions	82
Other disability resources	82
HP links	82
Contacting support	83
Index	84

1 Getting started

After you set up and register the computer, HP recommends the following steps to get the most out of your smart investment:

 **TIP:** To quickly return to the computer Start screen from an open app or the Windows desktop, press the Windows key  on your keyboard. Pressing the Windows key again returns you to the previous screen.

- **Connect to the Internet**—Set up your wired or wireless network so that you can connect to the Internet. For more information, see [Network connections on page 24](#).
- **Update your antivirus software**—Protect your computer from damage caused by viruses. The software is preinstalled on the computer. For more information, see [Using antivirus software on page 56](#).
- **Get to know your computer**—Learn about your computer features. See [Components on page 3](#) and [Navigating the screen on page 30](#) for additional information.
- **Find installed software**—Access a list of the software preinstalled on the computer:
Select the **Start** button.
– or –
Right-click the **Start** button, and then select **Apps and Features**.
- **Back up your hard drive**—Create recovery discs or a recovery USB flash drive to back up your hard drive. See [Backing up, restoring, and recovering on page 63](#).

Finding information

To locate resources that provide product details, how-to information, and more, use this table.

Table 1-1 Additional information

Resource	Contents
<i>Setup Instructions</i>	<ul style="list-style-type: none">• Overview of computer setup and features
HP support For HP support, go to http://www.hp.com/support , and follow the instructions to find your product.	<ul style="list-style-type: none">• Online chat with an HP technician• Support telephone numbers• Replacement parts videos (select products only)• Maintenance and service guides• HP service center locations
<i>Safety & Comfort Guide</i> To access this guide: ▲ Type HP Documentation in the taskbar search box, and then select HP Documentation . – or – ▲ Go to http://www.hp.com/ergo . IMPORTANT: You must be connected to the Internet to access the latest version of the user guide.	<ul style="list-style-type: none">• Proper workstation setup• Guidelines for posture and work habits that increase your comfort and decrease your risk of injury• Electrical and mechanical safety information
<i>Regulatory, Safety, and Environmental Notices</i> To access this document: ▲ Type HP Documentation in the taskbar search box, and then select HP Documentation .	<ul style="list-style-type: none">• Important regulatory notices, including information about proper battery disposal, if needed.
<i>Limited Warranty*</i> To access this document: ▲ Type HP Documentation in the taskbar search box, and then select HP Documentation . – or – ▲ Go to http://www.hp.com/go/orderdocuments . IMPORTANT: You must be connected to the Internet to access the latest version of the user guide.	<ul style="list-style-type: none">• Specific warranty information about this computer

*You can find your HP Limited Warranty located with the user guides on your product and/or on the CD or DVD provided in the box. In some countries or regions, HP might provide a printed warranty in the box. For countries or regions where the warranty is not provided in printed format, you can request a copy from <http://www.hp.com/go/orderdocuments>. For products purchased in Asia Pacific, you can write to HP at POD, PO Box 161, Kitchener Road Post Office, Singapore 912006. Include your product name, and your name, phone number, and postal address.

2 Components

Your computer features top-rated components. This chapter provides details about your components, where they are located, and how they work.

 **NOTE:** Actual computer color, features, feature locations, and icon labels may vary from the images depicted.

Locating hardware

To find out what hardware is installed on your computer:

- ▲ Type `device manager` in the taskbar search box, and then select the **Device Manager** app.

A list displays all the devices installed on your computer.

For information about system hardware components and the system BIOS version number, press `fn+esc` (select products only).

Locating software

To find out what software is installed on your computer:

- ▲ Right-click the **Start** button, and then select **Apps and Features**.

Right

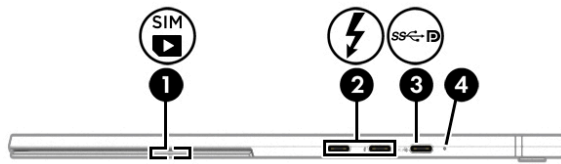

Table 2-1 Right-side components and their descriptions



Component		Description
(1)	 SIM Nano SIM card slot (select products only)	Supports a wireless subscriber identity module (SIM) card. NOTE: The nano SIM card slot is located under the kickstand.
(2)	 USB Type-C power connector and Thunderbolt™ ports with HP Sleep and Charge (2)	Connect AC adapters that have a USB Type-C connector, supplying power to the computer and, if needed, charging the computer battery. – and – Even when the computer is off, connect and charge most USB devices that have a Type-C connector, such as a cell phone, camera, activity tracker, or smartwatch, and provide high-speed data transfer. – and – Connect display devices that have a USB Type-C connector, providing DisplayPort™ output. NOTE: Your computer may also support a Thunderbolt docking station. NOTE: Cables and/or adapters (purchased separately) may be required.
(3)	 USB Type-C power connector port, SuperSpeed port, and DisplayPort connector	Connects an AC adapter that has a USB Type-C connector, supplying power to the computer and, if needed, charging the computer battery. – and – Connects a USB device that has a Type-C connector, such as a cell phone, camera, activity tracker, or smartwatch, and provides high-speed data transfer. – and – Connects a display device that has a USB Type-C connector, providing DisplayPort output. NOTE: Cables and/or adapters (purchased separately) may be required.
(4)	Battery light	When AC power is connected: <ul style="list-style-type: none"> • White: The battery charge is greater than 90 percent. • Amber: The battery charge is from 0 to 90 percent. • Off: The battery is not charging.

Table 2-1 Right-side components and their descriptions (continued)

Component	Description
	When AC power is disconnected (battery not charging): <ul style="list-style-type: none">Blinking amber: The battery has reached a low battery level. When the battery has reached a critical battery level, the battery light begins blinking rapidly.Off: The battery is not charging.

Left

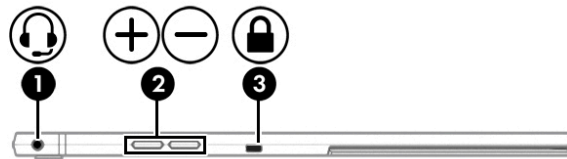





Table 2-2 Left-side components and their descriptions

Component	Description
(1)  Audio-out (headphone)/Audio-in (microphone) combo jack	Connects optional powered stereo speakers, headphones, earbuds, a headset, or a television audio cable. Also connects an optional headset microphone. This jack does not support optional standalone microphones. WARNING! To reduce the risk of personal injury, adjust the volume before putting on headphones, earbuds, or a headset. For additional safety information, see the <i>Regulatory, Safety, and Environmental Notices</i> . To access this guide: <ul style="list-style-type: none">▲ Type HP Documentation in the taskbar search box, and then select HP Documentation. NOTE: When a device is connected to the jack, the computer speakers are disabled.
(2)  Volume buttons	Control speaker volume on the computer.
(3)  Nano security cable slot	Attaches an optional security cable to the computer. NOTE: The security cable is designed to act as a deterrent, but it may not prevent the computer from being mishandled or stolen.

Display

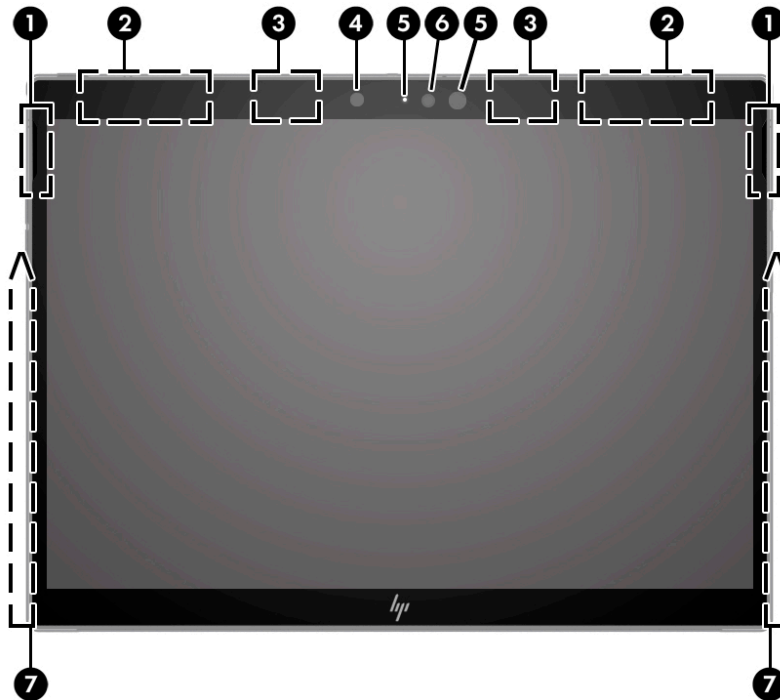

Table 2-3 Display components and their descriptions

Component	Description
(1) Speakers (2)	Produce sound.
(2) WWAN antennas (select products only)*	Send and receive wireless signals to communicate with wireless wide area networks (WWANs).
(3) WLAN antennas*	Send and receive wireless signals to communicate with wireless local area networks (WLANs).
(4) Ambient light sensor	Adjusts the brightness of the display, depending on the ambient light.
(5) Camera light(s)	On: One or more cameras are in use.
(6) Camera(s)	Allow(s) you to video chat, record video, and record still images. To use your camera, see Using a camera (select products only) on page 35 . Some cameras also allow a facial recognition logon to Windows, instead of a password logon. For more information, see Windows Hello (select products only) on page 56 . NOTE: Camera functions vary depending on the camera hardware and software installed on your product.
(7) Magnetic pen attachment area	Holds an optional pen. Place the pen tip up (facing the top of the computer) for optimal magnetic attachment. NOTE: For more information about the pen, see the documentation provided with the pen.

*The antennas are not visible from the outside of the computer. For optimal transmission, keep the areas immediately around the antennas free from obstructions.

For wireless regulatory notices, see the section of the *Regulatory, Safety, and Environmental Notices* that applies to your country or region.

Table 2-3 Display components and their descriptions (continued)

Component	Description
To access this guide:	
▲ Type <code>HP Documentation</code> in the taskbar search box, and then select HP Documentation .	

Top



Table 2-4 Top components and their descriptions



Component	Description
(1)	<p>Vents (2)</p> <p>Enable airflow to cool internal components.</p> <p>NOTE: The computer fan starts up automatically to cool internal components and prevent overheating. It is normal for the internal fan to cycle on and off during routine operation.</p>
(2)	<p> Internal microphones (2)</p> <p>Record sound.</p>
(3)	<p>Camera privacy cover</p> <p>Controls the front and rear facing cameras simultaneously. When facing the display side with the front-facing camera:</p> <ul style="list-style-type: none"> To reveal the camera, slide the cover to the left. To conceal the camera, slide the cover to the right.
(4)	<p> Power button</p> <ul style="list-style-type: none"> When the computer is off, press the button to turn on the computer. When the computer is on, press the button briefly to initiate Sleep. When the computer is in the Sleep state, press the button briefly to exit Sleep (select products only). When the computer is in Hibernation, press the button briefly to exit Hibernation. <p>CAUTION: Pressing and holding down the power button results in the loss of unsaved information.</p> <p>If the computer has stopped responding and shutdown procedures are ineffective, press and hold the power button for at least 5 seconds to turn off the computer.</p> <p>To learn more about your power settings, see your power options.</p>

Table 2-4 Top components and their descriptions (continued)

Component	Description
(5)	Power light
	<p>▲ Right-click the Power meter icon  and then select Power Options.</p>
	<ul style="list-style-type: none">• On: The computer is on.• Blinking (select products only): The computer is in the Sleep state, a power-saving state. The computer shuts off power to the display and other unneeded components.• Off: Depending on your computer model, the computer is off, in Hibernation, or in Sleep. Hibernation is the power-saving state that uses the least amount of power.

Bottom

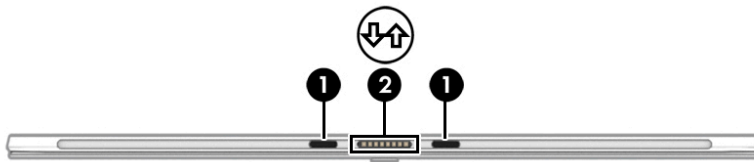



Table 2-5 Bottom components and their descriptions

Component		Description
(1)	Alignment connectors (2)	Connect to the alignment connectors on the keyboard (select products only).
(2)	 Keyboard connector	Connects the computer to the keyboard (select products only).

Rear

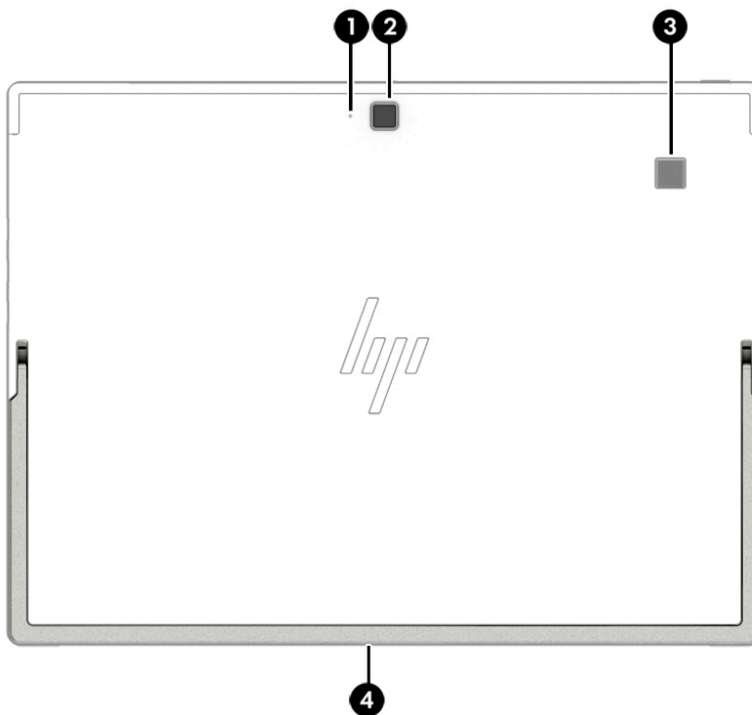

Table 2-6 Rear components and their descriptions

Component		Description
(1)	Rear internal microphone	Records sound.
(2)	Rear camera	Allows you to video chat, record video, and record still images. To use your camera, see Using a camera

Table 2-6 Rear components and their descriptions (continued)

Component	Description
(3) Fingerprint reader (select products only)	<p data-bbox="963 260 1422 390">(select products only) on page 35. Some cameras also allow a facial recognition logon to Windows, instead of a password logon. For more information, see Windows Hello (select products only) on page 56.</p> <p data-bbox="963 415 1422 489">NOTE: Camera functions vary depending on the camera hardware and software installed on your product.</p> <p data-bbox="963 512 1422 564">Allows a fingerprint logon to Windows, instead of a password logon.</p> <p data-bbox="963 590 1422 663">▲ Touch your finger to the fingerprint reader. See Windows Hello (select products only) on page 56 for details.</p> <p data-bbox="1011 688 1422 785">IMPORTANT: To prevent fingerprint logon issues, make sure when you register your fingerprint that all sides of your finger are registered by the fingerprint reader.</p> <p data-bbox="1011 810 1422 961">IMPORTANT: To verify that your computer has a fingerprint reader, type <code>Sign-in options</code> in the taskbar search box and follow the on-screen instructions. If Fingerprint reader is listed as an option, then your computer includes a fingerprint reader.</p>
(4) Kickstand	Changes the angle for the display.

Using the kickstand

To change the angle for the display, follow these steps:

1. Hold the computer with top edge up. (The speakers are on top.)
2. Slide the kickstand away from the computer and position the kickstand at the appropriate angle. The kickstand will hold at a midway point **(1)** of about 52° or at full stopping point **(2)** of about 165°.

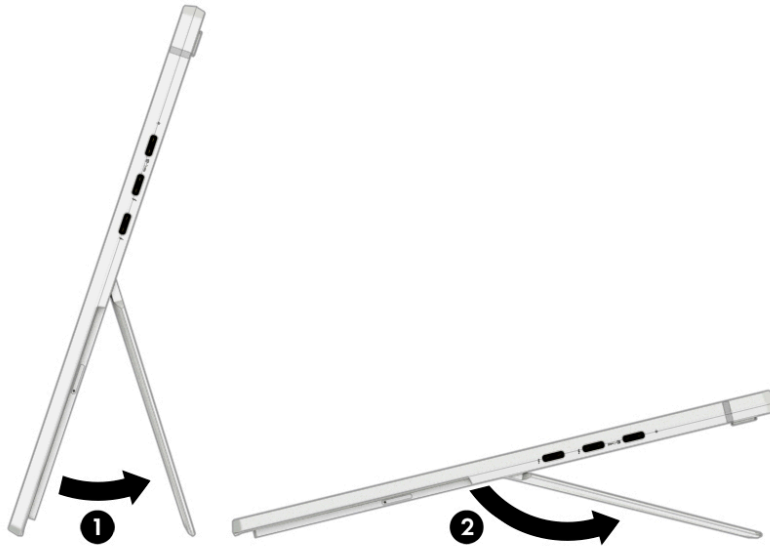

To close the kickstand, push the kickstand against the bottom of the computer until it is flush with the bottom.



Keyboard area (select products only)



NOTE: Your keyboard may look slightly different from the illustrations in this section.

Connecting the keyboard

- ▲ To connect the keyboard, lower the computer onto the keyboard until the connectors click into place.



Removing the keyboard

- ▲ To remove the computer from the keyboard, pull the computer away from the back of the keyboard.



Connecting the leather folio keyboard

- ▲ To connect the leather folio keyboard, lower the computer onto the keyboard **(1)** until the connectors click into place, and then attach the keyboard cover to the back of the computer **(2)** fitting the camera in the keyboard cutout.



Removing the leather folio keyboard

- ▲ To remove the computer from the leather folio keyboard, pull the computer away from the keyboard **(1)**, remove the back of the keyboard cover **(2)**, and then lift the computer away from the keyboard **(3)**.



Adjusting the leather folio keyboard

To change the angle of the display using the leather folio keyboard, follow these steps.

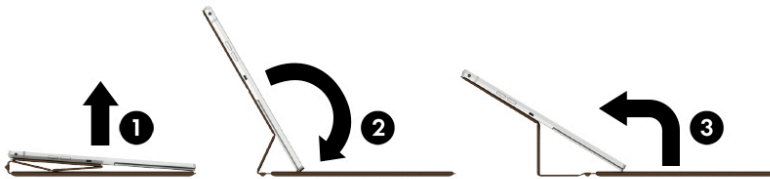

Touchpad settings

To adjust touchpad settings and gestures, or to turn off the touchpad:

1. Type `touchpad settings` in the taskbar search box, and then press [enter](#).
2. Choose a setting.

To turn on the touchpad:

1. Type `touchpad settings` in the taskbar search box, and then press [enter](#).
2. Using an external mouse, click the **Touchpad** button.

– or –

- ▲ Press the [Tab](#) key repeatedly until the pointer rests on the **Touchpad** button. Then press the [spacebar](#) to select the button.

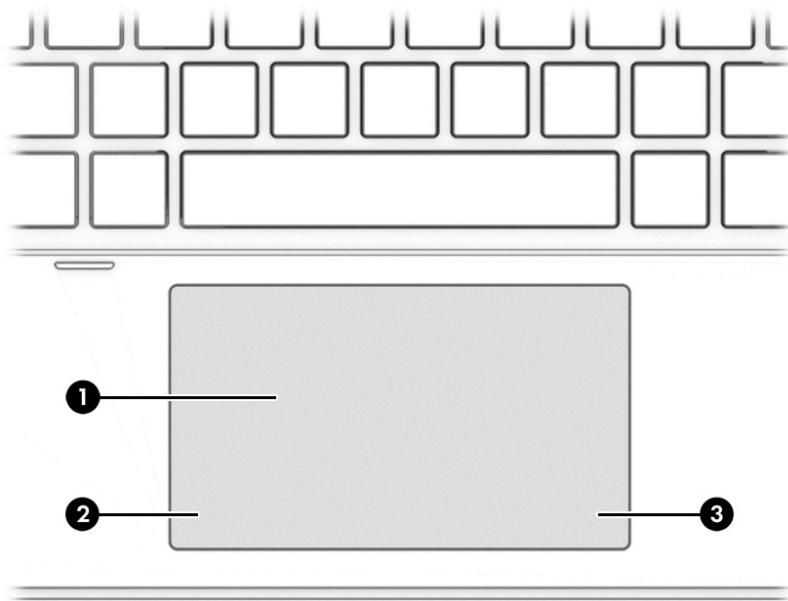

Table 2-7 Touchpad components and their descriptions

Component	Description
(1) Touchpad zone	Reads your finger gestures to move the pointer or activate items on the screen. NOTE: For more information, see Using touchpad and touch screen gestures on page 30 .
(2) Left touchpad button	Functions like the left button on an external mouse.
(3) Right touchpad button	Functions like the right button on an external mouse.

Lights

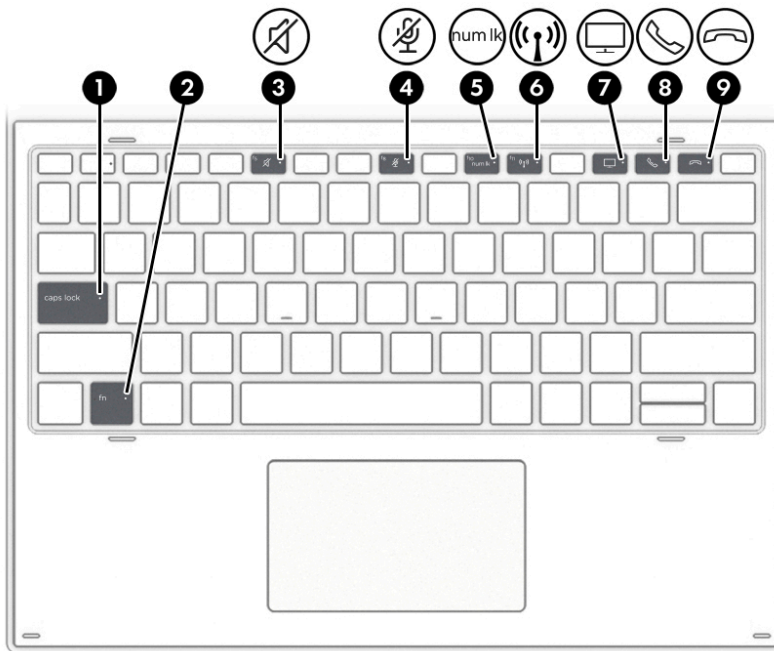









Table 2-8 Lights and their descriptions

Component	Description
(1) Caps lock light	On: Caps lock is on, which switches the key input to all capital letters.
(2) Fn lock light	On: The fn key is locked. For more information, see Hot keys (select products only) on page 21 .
(3)  Mute light	<ul style="list-style-type: none"> On: Computer sound is off. Off: Computer sound is on.
(4)  Microphone mute light	<ul style="list-style-type: none"> On: Microphone is off. Off: Microphone is on.
(5)  Num Lk light	On: Num lock is on.
(6)  Wireless light	<p>On: An integrated wireless device, such as a wireless local area network (WLAN) device and/or a Bluetooth® device, is on.</p> <p>NOTE: On some models, the wireless light is amber when all wireless devices are off.</p>
(7)  Sharing or presenting light	On: Sharing is on.
(8)  Call answer light	On: Call answer is on.
(9)  Call end light	On: Call end is on.

Special keys

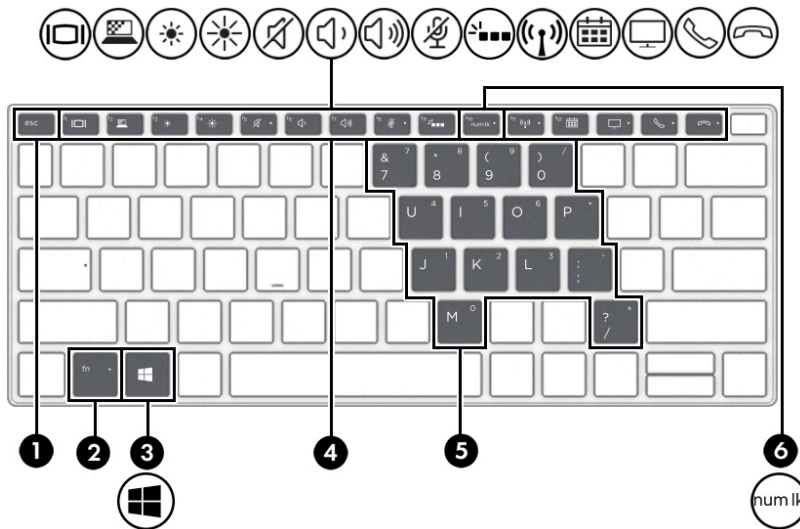



Table 2-9 Special keys and their descriptions

Component	Description
(1) <code>esc</code> key	Displays system information when pressed in combination with the <code>fn</code> key.
(2) <code>fn</code> key	Executes frequently used system functions when pressed in combination with another key. Such key combinations are called <i>hot keys</i> . See Hot keys (select products only) on page 21 .
(3)  Windows key	Opens the Start menu. NOTE: Pressing the Windows key again will close the Start menu.
(4) Action keys	Execute frequently used system functions. See Action keys on page 19 .
(5) Embedded numeric keypad	A numeric keypad superimposed over the keyboard alphabet keys. When <code>num lk</code> is pressed, the keypad can be used like an external numeric keypad. Each key on the keypad performs the function indicated by the icon in the upper-right corner of the key. NOTE: If the keypad function is active when the computer is turned off, that function is reinstated when the computer is turned back on.
(6) <code>num lk</code> key	Turns the embedded numeric keypad on and off.

Action keys

The action keys on your computer perform specific functions and vary by computer. To determine which keys are on your computer, look at the icons on your keyboard and match them to the descriptions in this table.

- ▲ To use an action key, press and hold the key.

Table 2-10 Action keys and their descriptions











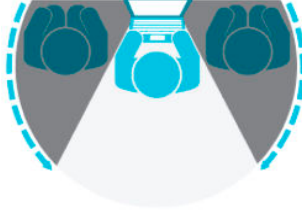











Icon	Description
	<p>On select products, helps prevent side-angle viewing from onlookers. If needed, decrease or increase brightness for well-lit or darker environments. Press the key again to turn off the privacy screen.</p> <p>NOTE: To quickly turn on the highest privacy setting, press fn+p.</p> 
	Decreases the screen brightness incrementally as long as you hold down the key.
	Increases the screen brightness incrementally as long as you hold down the key.
	Turns the keyboard backlight off or on. On select products, you can adjust the brightness of the keyboard backlight. Press the key repeatedly to adjust the brightness from high (when you first start up the computer), to low, to off. After you adjust the keyboard backlight setting, the backlight will revert to your previous setting each time you turn on the computer. The keyboard backlight will turn off after 30 seconds of inactivity. To turn the keyboard backlight back on, press any key or tap the touchpad (select products only). To conserve battery power, turn off this feature.
	Plays the previous track of an audio CD or the previous section of a DVD or a Blu-ray Disc (BD).
	Starts, pauses, or resumes playback of an audio CD, a DVD, or a BD.
	Plays the next track of an audio CD or the next section of a DVD or a BD.
	Stops audio or video playback of a CD, a DVD, or a BD.
	Decreases speaker volume incrementally while you hold down the key.
	Increases speaker volume incrementally while you hold down the key.
	Mutes the microphone.

Table 2-10 Action keys and their descriptions (continued)

Icon	Description
	Mutes or restores speaker sound.
	Turns the wireless feature on or off. NOTE: A wireless network must be set up before a wireless connection is possible.
	Turns the touchpad on or off.
	Turns the touchpad and touchpad light on and off.
	Switches the screen image among display devices connected to the system. For example, if a monitor is connected to the computer, repeatedly pressing the key alternates the screen image from computer display to monitor display to simultaneous display on both the computer and the monitor.
	Initiates Sleep, which saves your information in system memory. The display and other system components turn off and power is conserved. To exit Sleep, briefly press the power button. CAUTION: To reduce the risk of information loss, save your work before initiating Sleep.
	Provides quick access to your Skype for Business calendar. NOTE: This feature requires Skype® for Business or Lync® 2013 running on Microsoft Exchange or Office 365® servers.
	Turns the screen sharing function on or off. NOTE: This feature requires Skype for Business or Lync 2013 running on Microsoft Exchange or Office 365 servers.
	<ul style="list-style-type: none">• Answers a call.• Starts a call during a 1-on-1 chat.• Places a call on hold. NOTE: This feature requires Skype for Business or Lync 2013 running on Microsoft Exchange or Office 365 servers.
	<ul style="list-style-type: none">• Ends a call.• Declines incoming calls.• Ends screen sharing. NOTE: This feature requires Skype for Business or Lync 2013 running on Microsoft Exchange or Office 365 servers.

 **NOTE:** The action key feature is enabled at the factory. You can disable this feature by pressing and holding the **fn** key and the left **shift** key. The **fn** lock light will turn on. After you have disabled the action key feature, you can still perform each function by pressing the **fn** key in combination with the appropriate action key.

Hot keys (select products only)

A hot key is the combination of the **fn** key and another key.

To use a hot key:

- ▲ Press the **fn** key, and then press one of the keys listed in the following table.

Table 2-11 Hot keys and their descriptions

Key	Description
C	Turns on scroll lock.
E	Turns on the insert function.
R	Breaks the operation.
S	Sends a programing query.
W	Pauses the operation.

Labels

The labels affixed to the computer provide information you may need when you troubleshoot system problems or travel internationally with the computer. Labels may be in paper form or imprinted on the product.

 **IMPORTANT:** Check the following locations for the labels described in this section: the bottom of the computer, inside the battery bay, under the service door, on the back of the display, or on the bottom of a tablet kickstand.

- Service label—Provides important information to identify your computer. When contacting support, you may be asked for the serial number, the product number, or the model number. Locate this information before you contact support.

Your service label will resemble one of the examples shown below. Refer to the illustration that most closely matches the service label on your computer.

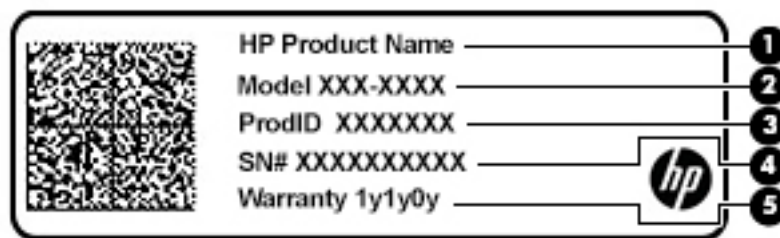

Table 2-12 Service label components

Component
(1) HP product name
(2) Model number
(3) Product ID
(4) Serial number
(5) Warranty period

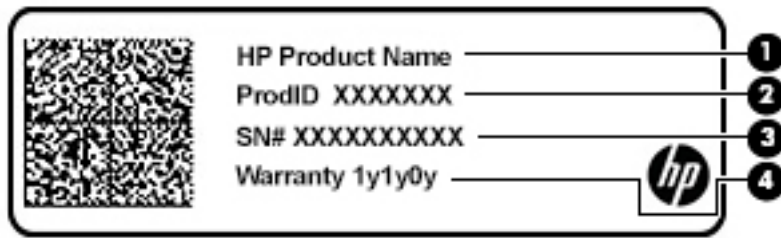

Table 2-13 Service label components

Component
(1) HP product name
(2) Product ID
(3) Serial number
(4) Warranty period

- Regulatory label(s)—Provide(s) regulatory information about the computer.
- Wireless certification label(s)—Provide(s) information about optional wireless devices and the approval markings for the countries or regions in which the devices have been approved for use.

Inserting a nano SIM card (select products only)

CAUTION: Inserting a SIM card of the wrong size could damage the SIM card or cause the SIM card to become stuck in the slot. The use of SIM card adapters is not recommended. To prevent damage to the SIM card or the connectors, use minimal force when inserting or removing a SIM card.

NOTE: Before purchasing a SIM card, follow these instructions to determine the correct SIM card size for your computer:

1. Go to <http://www.hp.com/support>, and then search for your computer by product name or number.
2. Select **Product Information**.
3. Refer to the listed options to determine which card to purchase.

To insert a SIM card, follow these steps:

1. Position the computer display-side up on a flat surface, and then lift up the kickstand.
2. Insert the removal tool or a small straightened paper clip **(1)** into the card tray access hole.
3. Press the tool or clip in gently until the card tray is ejected.
4. Remove the tray **(2)** from the computer and insert the card **(3)**.

5. Replace the tray in the computer. Press gently on the tray **(4)** until it is firmly seated.

 **NOTE:** The SIM card in your computer may look slightly different from the illustration in this section.

 **NOTE:** See the image on the back of the display to determine which way the SIM card should be inserted into your computer.

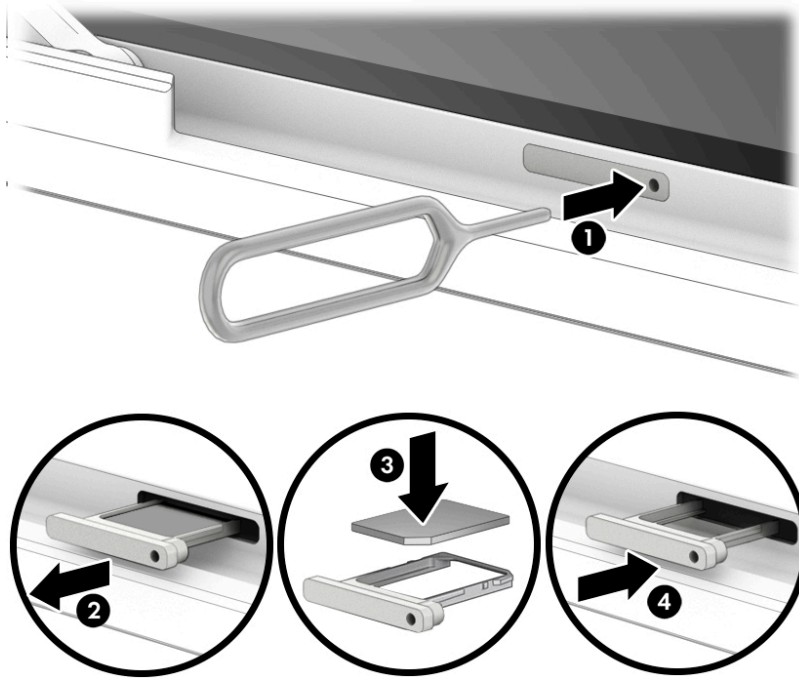

To remove a SIM card, reverse these steps.

3 Network connections

Your computer can travel with you wherever you go. But even at home, you can explore the globe and access information from millions of websites by using your computer and a wired or wireless network connection. This chapter will help you get connected to that world.

Connecting to a wireless network

Your computer may be equipped with one or more of the following wireless devices:

- **WLAN device**—Connects the computer to wireless local area networks (commonly referred to as Wi-Fi networks, wireless LANs, or WLANs) in corporate offices, your home, and public places such as airports, restaurants, coffee shops, hotels, and universities. In a WLAN, the mobile wireless device in your computer communicates with a wireless router or a wireless access point.
- **HP Mobile Broadband Module (select products only)**—A wireless wide area network (WWAN) device that gives you wireless connectivity over a much larger area. Mobile network operators install base stations (similar to cell phone towers) throughout large geographic areas, effectively providing coverage across entire states, regions, or even countries.
- **Bluetooth® device**—Creates a personal area network (PAN) to connect to other Bluetooth-enabled devices such as computers, phones, printers, headsets, speakers, and cameras. In a PAN, each device communicates directly with other devices, and devices must be relatively close together—typically within 10 meters (approximately 33 feet) of each other.

Using the wireless controls

You can control the wireless devices in your computer using one or more of these features:

- **Wireless button (also called airplane mode key or wireless key)** (referred to in this chapter as wireless button)
- **Operating system controls**

Wireless button

The computer may have a wireless button, one or more wireless devices, and one or two wireless lights. All the wireless devices on your computer are enabled at the factory.

The wireless light indicates the overall power state of your wireless devices, not the status of individual devices.

Operating system controls

The Network and Sharing Center allows you to set up a connection or network, connect to a network, and diagnose and repair network problems.

To use operating system controls:

1. Type `control panel` in the taskbar search box, and then select **Control Panel**.
2. Select **Network and Internet**, and then select **Network and Sharing Center**.

– or –

- ▲ On the taskbar, select the network status icon, and then select **Network & Internet settings**.

Connecting to a WLAN

 **NOTE:** When you are setting up Internet access in your home, you must establish an account with an Internet service provider (ISP). To purchase Internet service and a modem, contact a local ISP. The ISP will help set up the modem, install a network cable to connect your wireless router to the modem, and test the Internet service.

To connect to a WLAN, follow these steps:

1. Be sure that the WLAN device is on.
2. On the taskbar, select the network status icon, and then connect to one of the available networks.

If the WLAN is a security-enabled WLAN, you are prompted to enter a security code. Enter the code, and then select **Next** to complete the connection.

 **NOTE:** If no WLANs are listed, you may be out of range of a wireless router or access point.

 **NOTE:** If you do not see the WLAN you want to connect to:

1. On the taskbar, right-click the network status icon, and then select **Open Network & Internet settings**.

– or –

On the taskbar, select the network status icon, and then select **Network & Internet settings**.

2. Under the **Change your network settings** section, select **Network and Sharing Center**.
3. Select **Set up a new connection or network**.

A list of options is displayed, allowing you to manually search for and connect to a network or to create a new network connection.

-
3. Follow the on-screen instructions to complete the connection.

After the connection is made, select the network status icon at the far right of the taskbar, to verify the name and status of the connection.

 **NOTE:** The functional range (how far your wireless signals travel) depends on WLAN implementation, router manufacturer, and interference from other electronic devices or structural barriers such as walls and floors.

Using HP Mobile Broadband (select products only)

Your HP Mobile Broadband computer has built-in support for mobile broadband service. Your new computer, when used with a mobile operator's network, gives you the freedom to connect to the Internet, send e-mail, or connect to your corporate network without the need for Wi-Fi hotspots.

You might need the HP Mobile Broadband Module IMEI and/or MEID number to activate mobile broadband service. The number may be printed on a label located on the bottom of your computer, inside the battery bay, under the service door, or on the back of the display.

– or –

1. On the taskbar, select the network status icon.
2. Select **Network & Internet settings**.
3. Under the **Network & Internet** section, select **Cellular**, and then select **Advanced Options**.

Some mobile network operators require the use of a SIM card. A SIM card contains basic information about you, such as a personal identification number (PIN), as well as network information. Some computers include a SIM card that is preinstalled. If the SIM card is not preinstalled, it may be provided in the HP Mobile Broadband information provided with your computer or the mobile network operator may provide it separately from the computer.

For information about HP Mobile Broadband and how to activate service with a preferred mobile network operator, see the HP Mobile Broadband information included with your computer.

Using GPS (select products only)

Your computer may be equipped with a Global Positioning System (GPS) device. GPS satellites deliver location, speed, and direction information to GPS-equipped systems.

To enable GPS, make sure location is enabled under the Windows privacy setting.

1. Type `location` in the taskbar search box, and then select **Location privacy settings**.
2. Follow the on-screen instructions for using location settings.

Using Bluetooth wireless devices (select products only)

A Bluetooth device provides short-range wireless communications that replace the physical cable connections that traditionally link electronic devices such as the following:

- Computers (desktop, notebook)
- Phones (cellular, cordless, smartphone)
- Imaging devices (printer, camera)
- Audio devices (headset, speakers)
- Mouse
- External keyboard

Connecting Bluetooth devices

Before you can use a Bluetooth device, you must establish a Bluetooth connection.

1. Type `bluetooth` in the taskbar search box, and then select **Bluetooth and other devices settings**.
2. Turn on Bluetooth, if it is not already turned on.
3. Select **Add Bluetooth or other device**, and then in the **Add a device** dialog box, select **Bluetooth**.
4. Select your device from the list, and then follow the on-screen instructions.

 **NOTE:** If the device requires verification, a pairing code is displayed. On the device you are adding, follow the on-screen instructions to verify that the code on your device matches the pairing code. For more information, refer to the documentation provided with the device.

 **NOTE:** If your device does not appear in the list, be sure that Bluetooth on that device is turned on. Some devices may have additional requirements; refer to the documentation provided with the device.

Using NFC to share information (select products only)

Your computer supports Near Field Communication (NFC), which allows you to wirelessly share information between two NFC-enabled devices. Information is transferred by tapping the tapping area (antenna) of the

computer with the antenna of your phone or other device. With NFC and supported apps, you can share websites, transfer contact information, transfer payments, and print on NFC-enabled printers.

 **NOTE:** To locate the tapping area on your computer, see [Components on page 3](#).

Sharing

1. Confirm that the NFC function is enabled.
 - a. Type `wireless` in the taskbar search box, and then select **Turn wireless devices on or off**.
 - b. Confirm that the selection for NFC is **On**.
2. Tap the NFC tapping area with an NFC-enabled device. You may hear a sound when the devices connect.

 **NOTE:** To find the location of the antenna on the other NFC device, refer to your device instructions.

3. Follow any on-screen instructions to continue.

Connecting to a wired network

Select products may allow wired connections: local area network (LAN) and modem connection. A LAN connection uses a network cable and is much faster than a modem, which uses a telephone cable. Both cables are sold separately.

 **WARNING!** To reduce the risk of electric shock, fire, or damage to the equipment, do not plug a modem cable or telephone cable into an RJ-45 (network) jack.

Connecting to a local area network (LAN) (select products only)

Use a LAN connection if you want to connect the computer directly to a router in your home (instead of working wirelessly), or if you want to connect to an existing network at your office.

 **NOTE:** A feature called HP LAN-Wireless Protection may be enabled on your computer. It closes your wireless (Wi-Fi) or WWAN connection when you connect directly to a LAN. For more information about HP LAN-Wireless Protection, see [Using HP LAN-Wireless Protection \(select products only\) on page 28](#).

If there is no RJ-45 port on the computer, connecting to a LAN requires an 8-pin, RJ-45 network cable or an optional docking device or expansion product.

To connect the network cable, follow these steps:

1. Plug the network cable into the network jack **(1)** on the computer or on an optional docking device or expansion product.

2. Plug the other end of the network cable into a network wall jack **(2)** or router.

 **NOTE:** If the network cable contains noise suppression circuitry **(3)**, which prevents interference from TV and radio reception, orient the circuitry end of the cable toward the computer.

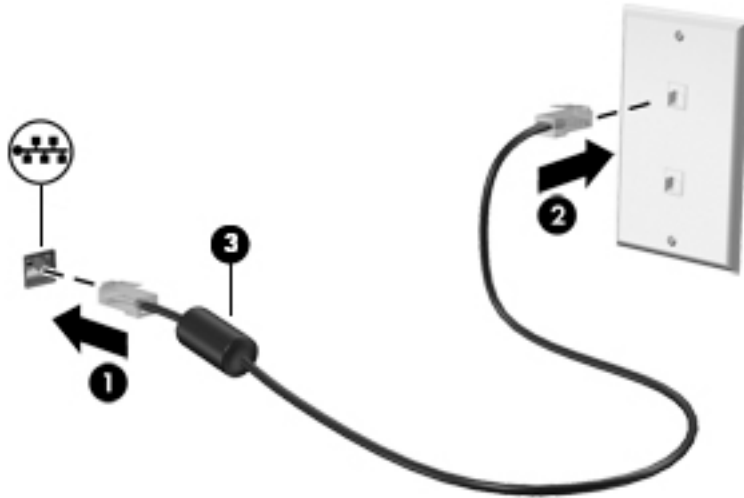

Using HP LAN-Wireless Protection (select products only)

In a LAN environment, you can set HP LAN-Wireless Protection to safeguard your LAN network from unauthorized wireless access. When HP LAN-Wireless Protection is enabled, the WLAN (Wi-Fi) or WWAN connection is turned off when the computer is connected directly to a LAN.

Turning on and customizing HP LAN-Wireless Protection

1. Connect a network cable to the network jack on the computer, or on an optional docking device or expansion product.
2. Start Computer Setup (BIOS).
 - Computers or tablets with keyboards:
 - ▲ Turn on or restart the computer, and when the HP logo appears, press **f10** to enter Computer Setup.
 - Tablets without keyboards:
 - ▲ Turn on or restart the tablet, and then quickly hold down the volume down button until the Startup menu is displayed. Tap **f10** to enter Computer Setup.
3. Select **Advanced**, and then select **Built-in Device Options**.
4. Select the check box for **LAN/WLAN Auto Switching** and/or **LAN/WWAN Auto Switching** to turn off WLAN and/or WWAN connections when connected to a LAN network.
5. To save your changes and exit Computer Setup, select **Main**, select **Save Changes and Exit**, and then select **Yes**.

 **NOTE:** If you are using arrow keys to highlight your choice, you must then press **enter**.

Your changes go into effect when the computer restarts.

Using HP MAC Address Pass Through to identify your computer on a network (select products only)

MAC Address Pass Through provides a customizable way of identifying your computer and its communications on networks. This system MAC address provides unique identification even when your computer is connected through an Ethernet adapter. This address is enabled by default.

Customizing MAC Address Pass Through

1. Start Computer Setup (BIOS).
 - Computers or tablets with keyboards:
 - ▲ Turn on or restart the computer, and when the HP logo appears, press **f10** to enter Computer Setup.
 - Tablets without keyboards:
 - ▲ Turn on or restart the tablet, and then quickly hold down the volume down button until the Startup menu is displayed. Tap **f10** to enter Computer Setup.
2. Select **Advanced**, and then select **MAC Address Pass Through**.
3. In the box to the right of **Host Based MAC Address**, select either **System Address** to enable MAC address Pass Through or **Custom Address** to customize the address.
4. If you selected Custom, select **MAC ADDRESS**, enter your customized system MAC address, and then press **enter** to save the address.
5. If the computer has an embedded LAN and you would like to use the embedded MAC address as the system MAC address, select **Reuse Embedded LAN Address**.

– or –

Select **Main**, select **Save Changes and Exit**, and then select **Yes**.



NOTE: If you are using arrow keys to highlight your choice, you must then press **enter**.

Your changes go into effect when the computer restarts.

4 Navigating the screen

Depending on your computer model, you can navigate the computer screen using one or more of the following methods:

- Use touch gestures directly on the computer screen.
- Use touch gestures on the touchpad.
- Use an optional mouse or keyboard (purchased separately).
- Use an on-screen keyboard.
- Use a pointing stick.

Using touchpad and touch screen gestures

The touchpad helps you navigate the computer screen and control the pointer using simple touch gestures. You can also use the left and right touchpad buttons as you would use the corresponding buttons on an external mouse. To navigate a touch screen (select products only), touch the screen directly using gestures described in this chapter.

To customize gestures and see videos of how they work, type `control panel` in the taskbar search box, select **Control Panel**, and then select **Hardware and Sound**. Under **Devices and Printers**, select **Mouse**.

Some products include a precision touchpad, which provides enhanced gesture functionality. To determine if you have a precision touchpad and find additional information, select **Start**, select **Settings**, select **Devices**, and then select **Touchpad**.

 **NOTE:** Unless noted, gestures can be used on both the touchpad and a touch screen.

Tap

Point to an item on the screen, and then tap one finger on the touchpad zone or touch screen to select the item. Double-tap an item to open it.



Two-finger pinch zoom

Use the two-finger pinch zoom to zoom out or in on images or text.

- Zoom out by placing two fingers apart on the touchpad zone or touch screen and then moving your fingers together.
- Zoom in by placing two fingers together on the touchpad zone or touch screen and then moving your fingers apart.



Two-finger slide (touchpad and precision touchpad)

Place two fingers slightly apart on the touchpad zone and then drag them up, down, left, or right to move up, down, or sideways on a page or image.

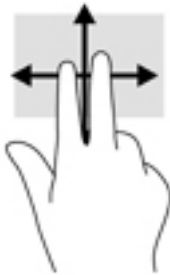

Two-finger tap (touchpad and precision touchpad)

Tap two fingers on the touchpad zone to open the options menu for the selected object.

 **NOTE:** The two-finger tap performs the same function as right-clicking with a mouse.



Three-finger tap (touchpad and precision touchpad)

By default, the three-finger tap opens Cortana, a voice-activated virtual assistant. Tap three fingers on the touchpad zone to perform the gesture.



To change the function of this gesture on a precision touchpad, select **Start**, select **Settings**, select **Devices**, and then select **Touchpad**. Under **Three-finger gestures**, in the **Taps** box, select a gesture setting.

Four-finger tap (touchpad and precision touchpad)

By default, the four-finger tap opens the Action Center. Tap four fingers on the touchpad zone to perform the gesture.



To change the function of this gesture on a precision touchpad, select **Start**, select **Settings**, select **Devices**, and then select **Touchpad**. Under **Four-finger gestures**, in the **Taps** box, select a gesture setting.

Three-finger swipe (touchpad and precision touchpad)

By default, the three-finger swipe switches between open apps and the desktop.

- Swipe 3 fingers away from you to see all open windows.
- Swipe 3 fingers toward you to show the desktop.
- Swipe 3 fingers left or right to switch between open windows.



To change the function of this gesture on a precision touchpad, select **Start**, select **Settings**, select **Devices**, and then select **Touchpad**. Under **Three-finger gestures**, in the **Swipes** box, select a gesture setting.

Four-finger swipe (precision touchpad)

By default, the four-finger swipe switches between open desktops.

- Swipe 4 fingers away from you to see all open windows.
- Swipe 4 fingers toward you to show the desktop.
- Swipe 4 fingers left or right to switch between desktops.



To change the function of this gesture, select **Start**, select **Settings**, select **Devices**, and then select **Touchpad**. Under **Four-finger gestures**, in the **Swipes** box, select a gesture setting.

One-finger slide (touch screen)

Use the one-finger slide to pan or scroll through lists and pages, or to move an object.

- To scroll across the screen, lightly slide one finger across the screen in the direction you want to move.
- To move an object, press and hold your finger on an object, and then drag your finger to move the object.

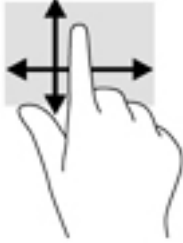

Using an optional keyboard or mouse

An optional keyboard or mouse allows you to type, select items, scroll, and perform the same functions as you do using touch gestures. The keyboard also allows you to use action keys and hot keys to perform specific functions.

Using an on-screen keyboard (select products only)

1. To display an on-screen keyboard, tap the keyboard icon in the notification area, at the far right of the taskbar.
2. Begin typing.



NOTE: Suggested words may be displayed above the on-screen keyboard. Tap a word to select it.



NOTE: Action keys and hot keys do not display or function on the on-screen keyboard.

5 Entertainment features

Use your HP computer for business or pleasure to meet with others via the camera, mix audio and video, or connect external devices like a projector, monitor, TV, or speakers. See [Components on page 3](#) to locate the audio, video and camera features on your computer.

Using a camera (select products only)

Your computer has a camera (integrated camera) that records video and captures photographs. Some models allow you to video conference and chat online using streaming video.

- ▲ To access the camera, type `camera` in the taskbar search box, and then select **Camera** from the list of applications.

Using audio

You can download and listen to music, stream audio content (including radio) from the web, record audio, or mix audio and video to create multimedia. You can also play music CDs on the computer (on select products) or attach an external optical drive to play CDs. To enhance your listening enjoyment, attach headphones or speakers.

Connecting speakers

You can attach wired speakers to your computer by connecting them to a USB port or to the audio-out (headphone)/audio-in (microphone) combo jack on your computer or on a docking station.

To connect wireless speakers to your computer, follow the device manufacturer's instructions. Before connecting speakers, lower the volume setting.

Connecting headphones

 **WARNING!** To reduce the risk of personal injury, lower the volume setting before putting on headphones, earbuds, or a headset. For additional safety information, see the *Regulatory, Safety, and Environmental Notices*.

To access this guide:

- ▲ Type `HP Documentation` in the taskbar search box, and then select **HP Documentation**.

You can connect wired headphones to the headphone jack or to the audio-out (headphone)/audio-in (microphone) combo jack on your computer.

To connect wireless headphones to your computer, follow the device manufacturer's instructions.

Connecting headsets

 **WARNING!** To reduce the risk of personal injury, lower the volume setting before putting on headphones, earbuds, or a headset. For additional safety information, see the *Regulatory, Safety, and Environmental Notices*.

To access this guide:

▲ Type `HP Documentation` in the taskbar search box, and then select **HP Documentation**.

Headphones combined with a microphone are called headsets. You can connect wired headsets to the audio-out (headphone)/audio-in (microphone) combo jack on your computer.

To connect wireless headsets to your computer, follow the device manufacturer's instructions.

Using sound settings

Use sound settings to adjust system volume, change system sounds, or manage audio devices.

To view or change sound settings:

▲ Type `control panel` in the taskbar search box, select **Control Panel**, select **Hardware and Sound**, and then select **Sound**.

Your computer may include an enhanced sound system by Bang & Olufsen, DTS, Beats audio, or another provider. As a result, your computer may include advanced audio features that can be controlled through an audio control panel specific to your audio system.

Use the audio control panel to view and control audio settings.

▲ Type `control panel` in the taskbar search box, select **Control Panel**, select **Hardware and Sound**, and then select the audio control panel specific to your system.

Using video

Your computer is a powerful video device that enables you to watch streaming video from your favorite websites and download video and movies to watch on your computer when you are not connected to a network.

To enhance your viewing enjoyment, use one of the video ports on the computer to connect an external monitor, projector, or TV.

 **IMPORTANT:** Be sure that the external device is connected to the correct port on the computer, using the correct cable. Follow the device manufacturer's instructions.

For information about using your video features, refer to HP Support Assistant.

Connecting a DisplayPort device using a USB Type-C cable (select products only)

 **NOTE:** To connect a USB Type-C DisplayPort device to your computer, you need a USB Type-C cable, purchased separately.

To see video or high-resolution display output on an external DisplayPort device, connect the DisplayPort device according to the following instructions:

1. Connect one end of the USB Type-C cable to the USB SuperSpeed port and DisplayPort connector on the computer.

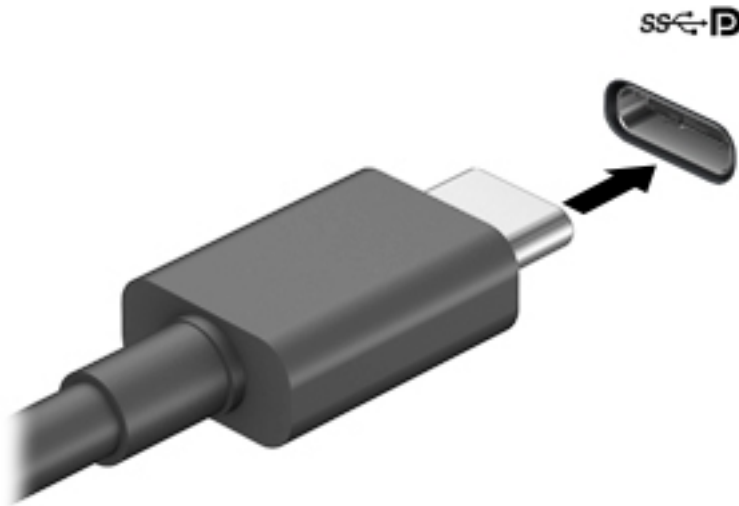

2. Connect the other end of the cable to the external DisplayPort device.
3. Press **f1** to cycle through four display states:
 - **PC screen only:** View the screen image on the computer only.
 - **Duplicate:** View the screen image simultaneously on both the computer and external device.
 - **Extend:** View the screen image extended across both the computer and external device.
 - **Second screen only:** View the screen image on the external device only.

Each time you press **f1** the display state changes.

 **NOTE:** For best results, especially if you choose the "Extend" option, increase the screen resolution of the external device, as follows. Select the **Start** button, select **Settings**, and then select **System**. Under **Display**, select the appropriate resolution, and then select **Keep changes**.

Connecting a Thunderbolt device using a USB Type-C cable (select products only)

 **NOTE:** To connect a USB Type-C Thunderbolt™ device to your computer, you need a USB Type-C cable, purchased separately.

To see video or high-resolution display output on an external Thunderbolt device, connect the Thunderbolt device according to the following instructions:

1. Connect one end of the USB Type-C cable to the USB Type-C Thunderbolt port on the computer.

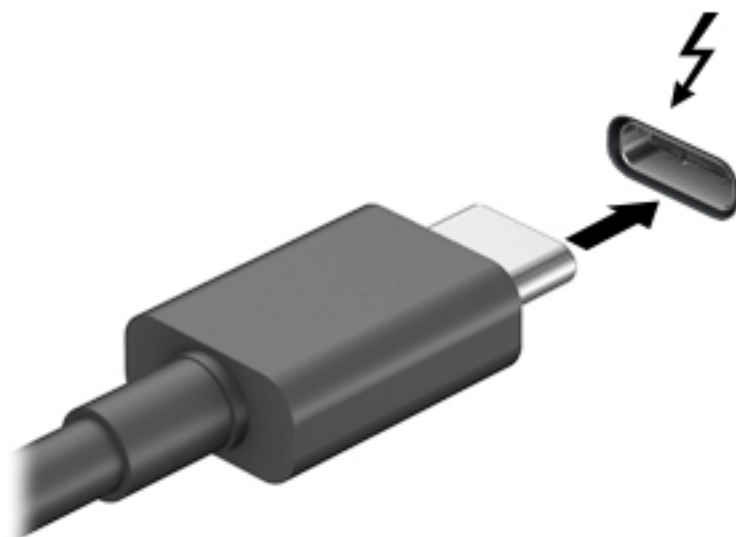

2. Connect the other end of the cable to the external Thunderbolt device.
3. Press **f1** to cycle through four display states:
 - **PC screen only:** View the screen image on the computer only.
 - **Duplicate:** View the screen image simultaneously on both the computer and external device.
 - **Extend:** View the screen image extended across both the computer and external device.
 - **Second screen only:** View the screen image on the external device only.

Each time you press **f1** the display state changes.

 **NOTE:** For best results, especially if you choose the "Extend" option, increase the screen resolution of the external device, as follows. Select the **Start** button, select **Settings**, and then select **System**. Under **Display**, select the appropriate resolution, and then select **Keep changes**.

Discovering and connecting wired displays using MultiStream Transport

MultiStream Transport (MST) allows you to connect multiple wired display devices to your computer by connecting to the VGA port or DisplayPort connectors on your computer and also to the VGA port or DisplayPort connectors on a hub or an external docking station. You can connect in several ways, depending on the type of graphics controller installed on your computer and whether or not your computer includes a built-in hub. Go to Device Manager to find out what hardware is installed on your computer.

- ▲ Type `device manager` in the taskbar search box, and then select the **Device Manager** app. A list displays all the devices installed on your computer.

Connect displays to computers with Intel graphics (with an optional hub)

 **NOTE:** With an Intel graphics controller and optional hub, you can connect up to 3 display devices.

To set up multiple display devices, follow these steps:

1. Connect an external hub (purchased separately) to the DisplayPort connector on your computer, using a DP-to-DP cable (purchased separately). Be sure that the hub power adapter is connected to AC power.
2. Connect your external display devices to the VGA port or DisplayPort connectors on the hub.
3. When Windows detects a monitor connected to the DisplayPort hub, the **DisplayPort Topology Notification** dialog box is displayed. Select the appropriate options to configure your displays. Multiple display choices include **Duplicate**, which mirrors your computer screen on all enabled display devices, or **Extend**, which extends the screen image across all enabled display devices.

 **NOTE:** If this dialog box does not appear, be sure that each external display device is connected to the correct port on the hub. Select the **Start** button, select **Settings**, and then select **System**. Under **Display**, select the appropriate resolution, and then select **Keep changes**.

Connect displays to computers with Intel graphics (with a built-in hub)

With your internal hub and Intel graphics controller, you can connect up to 3 display devices in the following configurations:

- Two 1920 × 1200 DisplayPort monitors connected to the computer and one 1920 × 1200 VGA monitor connected to an optional docking station
- One 2560 × 1600 DisplayPort monitor connected to the computer and one 1920 × 1200 VGA monitor connected to an optional docking station

To set up multiple display devices, follow these steps:

1. Connect your external display devices to the VGA port or DisplayPort connectors on the computer base or the docking station.
2. When Windows detects a monitor connected to the DisplayPort hub, the **DisplayPort Topology Notification** dialog box is displayed. Select the appropriate options to configure your displays. Multiple display choices include **Duplicate**, which mirrors your computer screen on all enabled display devices, or **Extend**, which extends the screen image across all enabled display devices.

 **NOTE:** If this dialog box does not appear, be sure that each external display device is connected to the correct port on the hub. Select the **Start** button, select **Settings**, and then select **System**. Under **Display**, select the appropriate resolution, and then select **Keep changes**.

Discovering and connecting to Miracast-compatible wireless displays (select products only)



NOTE: To learn what type of display you have (Miracast-compatible or Intel WiDi), refer to the documentation that came with your TV or secondary display.

To discover and connect to Miracast-compatible wireless displays without leaving your current apps, follow the steps below.

To open Miracast:

- ▲ Type `project` in the taskbar search box, and then select **Project to a second screen**. Select **Connect to a wireless display**, and then follow the on-screen instructions.

Discovering and connecting to Intel WiDi certified displays (select Intel products only)

Use Intel WiDi to wirelessly project individual files such as photos, music, or videos, or to duplicate your entire computer screen to a TV or a secondary display device.

Intel WiDi, a premium Miracast solution, makes it easy and seamless to pair your secondary display device; provides for full-screen duplication; and improves speed, quality, and scaling.

To connect to Intel WiDi certified displays:

- ▲ Type `project` in the taskbar search box, and then select **Project to a second screen**. Select **Connect to a wireless display**, and then follow the on-screen instructions.

To open Intel WiDi:

- ▲ Type `Intel WiDi` in the taskbar search box, and then select **Intel WiDi**.

Using data transfer

Your computer is a powerful entertainment device that enables you to transfer photos, videos, and movies from your USB devices to view on your computer.

To enhance your viewing enjoyment, use one of the USB Type-C ports on the computer to connect a USB device, such as a cell phone, camera, activity tracker, or smartwatch, and transfer the files to your computer.



IMPORTANT: Be sure that the external device is connected to the correct port on the computer, using the correct cable. Follow the device manufacturer's instructions.

For information about using your USB Type-C features, refer to HP Support Assistant.

Connecting devices to a USB Type-C port (select products only)

 **NOTE:** To connect a USB Type-C device to your computer, you need a USB Type-C cable, purchased separately.

1. Connect one end of the USB Type-C cable to the USB Type-C port on the computer.

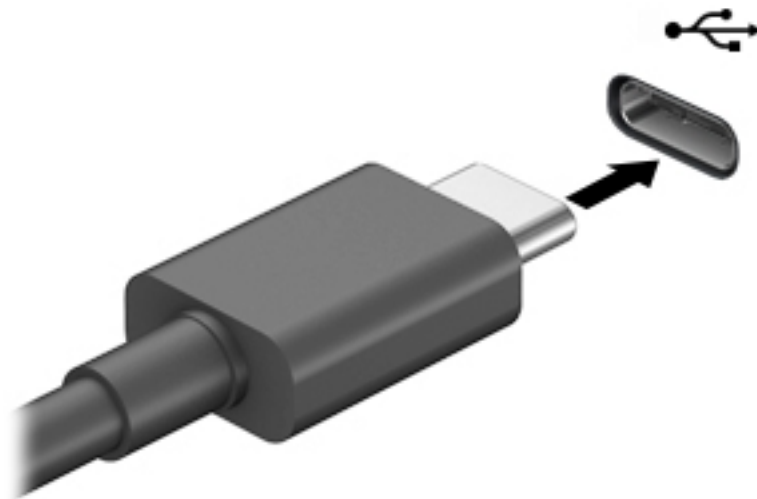

2. Connect the other end of the cable to the external device.

6 Managing power

Your computer can operate on either battery power or external power. When the computer is running on battery power and an external power source is not available to charge the battery, it is important to monitor and conserve the battery charge.

Some power management features described in this chapter might not be available on your computer.

Using Sleep and Hibernation

⚠ CAUTION: Several well-known vulnerabilities exist when a computer is in the Sleep state. To prevent an unauthorized user from accessing data on your computer, even encrypted data, HP recommends that you always initiate Hibernation instead of Sleep anytime the computer will be out of your physical possession. This practice is particularly important when you travel with your computer.

CAUTION: To reduce the risk of possible audio and video degradation, loss of audio or video playback functionality, or loss of information, do not initiate Sleep while reading from or writing to a disc or an external media card.

Windows has two power-saving states, Sleep and Hibernation.

- Sleep—The Sleep state automatically initiates after a period of inactivity. Your work is available in memory, allowing you to resume your work quickly. You can also initiate Sleep manually. For more information, see [Initiating and exiting Sleep on page 42](#). Depending on your computer model, the Sleep state might also support Modern Standby mode. This mode keeps some internal operations awake and enables your computer to receive web notifications, such as emails, while in Sleep.
- Hibernation—The Hibernation state is automatically initiated if the battery reaches a critical level or the computer has been in the Sleep state for an extended period of time. In the Hibernation state, your work is saved to a hibernation file and the computer powers down. You can also initiate Hibernation manually. For more information, see [Initiating and exiting Hibernation \(select products only\) on page 43](#).

Initiating and exiting Sleep

You can initiate Sleep in any of the following ways:

- Select the **Start** button, select the **Power** icon, and then select **Sleep**.
- Close the display (select products only).
- Press the Sleep hot key (select products only); for example, **fn+f1** or **fn+f12**.
- Briefly press the power button (select products only).

You can exit Sleep in any of the following ways:

- Briefly press the power button.
- If the computer is closed, raise the display (select products only).
- Press a key on the keyboard (select products only).
- Tap the touchpad (select products only).

When the computer exits Sleep, your work returns to the screen.



IMPORTANT: If you have set a password to be required on exiting Sleep, you must enter your Windows password before your work returns to the screen.

Initiating and exiting Hibernation (select products only)

You can enable user-initiated Hibernation and change other power settings and timeouts using Power Options.

1. Right-click the **Power** icon , and then select **Power Options**.
2. In the left pane, select **Choose what the power buttons do** (wording might vary by product).
3. Depending on your product, you can enable Hibernation for battery power or external power in any of the following ways:
 - **Power button**—Under **Power and sleep buttons and lid settings** (wording might vary by product), select **When I press the power button**, and then select **Hibernate**.
 - **Sleep button** (select products only)—Under **Power and sleep buttons and lid settings** (wording might vary by product), select **When I press the sleep button**, and then select **Hibernate**.
 - **Lid** (select products only)—Under **Power and sleep buttons and lid settings** (wording might vary by product), select **When I close the lid**, and then select **Hibernate**.
 - **Power menu**—Select **Change Settings that are currently unavailable**, and then, under **Shutdown settings**, select the **Hibernate** check box.

The Power menu can be accessed by selecting the **Start** button.

4. Select **Save changes**.
 - ▲ To initiate Hibernation, use the method that you enabled in step 3.
 - ▲ To exit Hibernation, briefly press the power button.



IMPORTANT: If you have set a password to be required on exiting Hibernation, you must enter your Windows password before your work returns to the screen.

Shutting down (turning off) the computer



CAUTION: Unsaved information is lost when the computer shuts down. Be sure to save your work before shutting down the computer.

The Shut down command closes all open programs, including the operating system, and then turns off the display and the computer.

Shut down the computer when it will be unused and disconnected from external power for an extended period.

The recommended procedure is to use the Windows Shut down command.



NOTE: If the computer is in the Sleep state or in Hibernation, first exit Sleep or Hibernation by briefly pressing the power button.



1. Save your work and close all open programs.
2. Select the **Start** button, select the **Power** icon, and then select **Shut down**.

If the computer is unresponsive and you are unable to use the preceding shutdown procedures, try the following emergency procedures in the sequence provided:

- Press **ctrl+alt+delete**, select the **Power** icon, and then select **Shut down**.
- Press and hold the power button for at least 10 seconds.
- If your computer has a user-replaceable battery (select products only), disconnect the computer from external power, and then remove the battery.

Using the Power icon and Power Options

The Power icon  is located on the Windows taskbar. The Power icon allows you to quickly access power settings and view the remaining battery charge.

- To view the percentage of remaining battery charge, place the mouse pointer over the **Power** icon .
- To use Power Options, right-click the **Power** icon , and then select **Power Options**.

Different Power icons indicate whether the computer is running on battery or external power. Placing the mouse pointer over the icon reveals a message if the battery has reached a low or critical battery level.

Running on battery power

 **WARNING!** To reduce potential safety issues, use only the battery provided with the computer, a replacement battery provided by HP, or a compatible battery purchased from HP.

When a charged battery is in the computer and the computer is not plugged into external power, the computer runs on battery power. When the computer is off and unplugged from external power, the battery in the computer slowly discharges. The computer displays a message when the battery reaches a low or critical battery level.

Computer battery life varies, depending on power management settings, programs running on the computer, screen brightness, external devices connected to the computer, and other factors.

 **NOTE:** When you disconnect external power, the display brightness is automatically decreased to conserve battery charge. Select computer products can switch between graphic controllers to conserve battery charge.

Using HP Fast Charge (select products only)

The HP Fast Charge feature allows you to quickly charge your computer battery. Charging time might vary by +/- 10%. Depending on your computer model and the HP AC adapter provided with your computer, HP Fast Charge operates in one or more of the following ways:

- When the remaining battery charge is between zero and 50%, the battery will charge to 50% of full capacity in no more than 30 to 45 minutes, depending on your computer model.
- When the remaining battery charge is between zero and 90%, the battery will charge to 90% of full capacity in no more than 90 minutes.

To use HP Fast Charge, shut down your computer, and then connect the AC adapter to your computer and to external power.

Displaying battery charge

To view the percentage of remaining battery charge, place the mouse pointer over the **Power** icon .

Finding battery information in HP Support Assistant (select products only)

To access battery information:

1. Type `support` in the taskbar search box, and then select the **HP Support Assistant** app.
– or –
Select the question mark icon in the taskbar.
2. Select **Troubleshooting and fixes**, and then in the **Diagnostics** section, select **HP Battery Check**. If HP Battery Check indicates that your battery should be replaced, contact support.

HP Support Assistant provides the following tools and information about the battery:

- HP Battery Check
- Information about battery types, specifications, life cycles, and capacity

Conserving battery power

To conserve battery power and maximize battery life:

- Lower the brightness of the display.
- Turn off wireless devices when you are not using them.
- Disconnect unused external devices that are not plugged into an external power source, such as an external hard drive connected to a USB port.
- Stop, disable, or remove any external media cards that you are not using.
- Before you leave your work, initiate Sleep or shut down the computer.

Identifying low battery levels

When a battery that is the sole power source for the computer reaches a low or critical battery level, the following behavior occurs:

- The battery light (select products only) indicates a low or critical battery level.

– or –

- The Power icon  shows a low or critical battery notification.



NOTE: For additional information about the Power icon, see [Using the Power icon and Power Options on page 44](#).

The computer takes the following actions for a critical battery level:

- If Hibernation is disabled and the computer is on or in the Sleep state, the computer remains briefly in the Sleep state and then shuts down and loses any unsaved information.
- If Hibernation is enabled and the computer is on or in the Sleep state, the computer initiates Hibernation.

Resolving a low battery level

Resolving a low battery level when external power is available

Connect one of the following to the computer and to external power:

- AC adapter
- Optional docking device or expansion product
- Optional power adapter purchased as an accessory from HP

Resolving a low battery level when no power source is available

Save your work and shut down the computer.

Resolving a low battery level when the computer cannot exit Hibernation

1. Connect the AC adapter to the computer and to external power.
2. Exit Hibernation by pressing the power button.

Factory-sealed battery

To monitor the status of the battery, or if the battery is no longer holding a charge, run HP Battery Check in the HP Support Assistant app (select products only).

1. Type `support` in the taskbar search box, and then select the **HP Support Assistant** app.
– or –
Select the question mark icon in the taskbar.
2. Select **Troubleshooting and fixes**, and then in the **Diagnostics** section, select **HP Battery Check**. If HP Battery Check indicates that your battery should be replaced, contact support.

The battery[ies] in this product cannot be easily replaced by users themselves. Removing or replacing the battery could affect your warranty coverage. If a battery is no longer holding a charge, contact support.

Running on external power

For information about connecting to external power, see the *Setup Instructions* poster provided in the computer box.

The computer does not use battery power when the computer is connected to external power with an approved AC adapter or an optional docking device or expansion product.

 **WARNING!** To reduce potential safety issues, use only the AC adapter provided with the computer, a replacement AC adapter provided by HP, or a compatible AC adapter purchased from HP.

 **WARNING!** Do not charge the computer battery while you are aboard aircraft.

Connect the computer to external power under any of the following conditions:

- When charging or calibrating a battery
- When installing or updating system software
- When updating the system BIOS
- When writing information to a disc (select products only)

- When running Disk Defragmenter on computers with internal hard drives
- When performing a backup or recovery

When you connect the computer to external power:

- The battery begins to charge.
- The screen brightness increases.
- The Power icon  changes appearance.

When you disconnect external power:

- The computer switches to battery power.
- The screen brightness automatically decreases to conserve battery charge.
- The Power icon  changes appearance.

7 Security

Protecting the computer

Standard security features provided by the Windows operating system and the Windows Computer Setup utility (BIOS, which runs under any operating system) can protect your personal settings and data from a variety of risks.





-  **NOTE:** Security solutions are designed to act as deterrents. These deterrents may not prevent a product from being mishandled or stolen.
-  **NOTE:** Before you send your computer for service, back up and delete confidential files, and remove all password settings.
-  **NOTE:** Some features listed in this chapter may not be available on your computer.
-  **NOTE:** Your computer supports Computrace, which is an online security-based tracking and recovery service available in select regions. If the computer is stolen, Computrace can track the computer if the unauthorized user accesses the Internet. You must purchase the software and subscribe to the service in order to use Computrace. For information about ordering the Computrace software, go to <http://www.hp.com>.

Table 7-1 Security solutions

Computer risk	Security feature
Unauthorized use of the computer	<ul style="list-style-type: none">• HP Client Security software, in combination with a password, smart card, contactless card, registered fingerprints, or other authentication credential• BIOS power-on password
Unauthorized access to Computer Setup (BIOS)	BIOS administrator password in Computer Setup*
Unauthorized access to the contents of a hard drive	DriveLock password (select products only) in Computer Setup*
Unauthorized startup from an optional external optical drive (select products only), optional external hard drive (select products only), or internal network adapter	Boot options feature in Computer Setup*
Unauthorized access to a Windows user account	Windows user password
Unauthorized access to data	Windows BitLocker
Unauthorized removal of the computer	Security cable slot (used with an optional security cable on select products only)

*Computer Setup is an embedded, ROM-based utility that can be used even when the operating system is not working or will not load. You can use a pointing device (touchpad, pointing stick, or USB mouse) or the keyboard to navigate and make selections in Computer Setup.

NOTE: On tablets without keyboards, you can use the touch screen.

Using passwords

A password is a group of characters that you choose to secure your computer information. Several types of passwords can be set, depending on how you want to control access to your information. Passwords can be set in Windows or in Computer Setup, which is preinstalled on the computer.

- BIOS administrator, power-on, and DriveLock passwords are set in Computer Setup and are managed by the system BIOS.
- Windows passwords are set only in the Windows operating system.
- If you forget both the DriveLock user password and the DriveLock master password set in Computer Setup, the hard drive that is protected by the passwords is permanently locked and can no longer be used.

You can use the same password for a Computer Setup feature and for a Windows security feature.

Use the following tips for creating and saving passwords:

- When creating passwords, follow requirements set by the program.
- Do not use the same password for multiple applications or websites, and do not reuse your Windows password for any other application or website.
- Use the Password Manager feature of HP Client Security to store your user names and passwords for your websites and applications. You can securely read them in the future if they cannot be remembered.
- Do not store passwords in a file on the computer.

The following tables list commonly used Windows and BIOS administrator passwords and describe their functions.

Setting passwords in Windows

Table 7-2 Types of Windows passwords and their functions

Password	Function
Administrator password*	Protects access to a Windows administrator-level account. NOTE: Setting the Windows administrator password does not set the BIOS administrator password.
User password*	Protects access to a Windows user account.

*For information about setting a Windows administrator password or a Windows user password, type `support` in the taskbar search box, and then select the **HP Support Assistant** app.

Setting passwords in Computer Setup

Table 7-3 Types of Computer Setup passwords and their functions

Password	Function
BIOS administrator password*	Protects access to Computer Setup. NOTE: If features have been enabled to prevent removing the BIOS administrator password, you may not be able to remove it until those features have been disabled.
Power-on password	<ul style="list-style-type: none"> • Must be entered each time you turn on or restart the computer. • If you forget your power-on password, you cannot turn on or restart the computer.
DriveLock master password*	Protects access to the internal hard drive that is protected by DriveLock, and is set under DriveLock Passwords during the

Table 7-3 Types of Computer Setup passwords and their functions (continued)

Password	Function
	enable process. This password is also used to remove DriveLock protection.
DriveLock user password*	Protects access to the internal hard drive that is protected by DriveLock, and is set under DriveLock Passwords during the enable process.

*For details about each of these passwords, see the following topics.

Managing a BIOS administrator password

To set, change, or delete this password, follow these steps:

Setting a new BIOS administrator password

1. Start Computer Setup.
 - Computers or tablets with keyboards:
 - ▲ Turn on or restart the computer, and when the HP logo appears, press **f10** to enter Computer Setup.
 - Tablets without keyboards:
 - ▲ Turn off the tablet. Press the power button in combination with the volume down button until the Startup menu is displayed, and then tap **f10** to enter Computer Setup.
2. Select **Security**, select **Create BIOS administrator password** or **Set Up BIOS administrator Password** (select products only), and then press **enter**.
3. When prompted, type a password.
4. When prompted, type the new password again to confirm.
5. To save your changes and exit Computer Setup, select **Main**, select **Save Changes and Exit**, and then select **Yes**.



NOTE: If you are using arrow keys to highlight your choice, you must then press **enter**.

Your changes go into effect when the computer restarts.

Changing a BIOS administrator password

1. Start Computer Setup.
 - Computers or tablets with keyboards:
 - ▲ Turn on or restart the computer, and when the HP logo appears, press **f10** to enter Computer Setup.
 - Tablets without keyboards:
 - ▲ Turn off the tablet. Press the power button in combination with the volume down button until the Startup menu is displayed, and then tap **f10** to enter Computer Setup.
2. Enter your current BIOS administrator password.
3. Select **Security**, select **Change BIOS administrator Password** or **Change Password** (select products only), and then press **enter**.

4. When prompted, type your current password.
5. When prompted, type your new password.
6. When prompted, type your new password again to confirm.
7. To save your changes and exit Computer Setup, select **Main**, select **Save Changes and Exit**, and then select **Yes**.



NOTE: If you are using arrow keys to highlight your choice, you must then press [enter](#).

Your changes go into effect when the computer restarts.

Deleting a BIOS administrator password

1. Start Computer Setup.
 - Computers or tablets with keyboards:
 - ▲ Turn on or restart the computer, and when the HP logo appears, press **f10** to enter Computer Setup.
 - Tablets without keyboards:
 - ▲ Turn off the tablet. Press the power button in combination with the volume down button until the Startup menu is displayed, and then tap **f10** to enter Computer Setup.
2. Enter your current BIOS administrator password.
3. Select **Security**, select **Change BIOS administrator Password** or **Change Password** (select products only), and then press [enter](#).
4. When prompted, type your current password.
5. When prompted for the new password, leave the field empty, and then press [enter](#).
6. When prompted to type your new password again, leave the field empty, and then press [enter](#).
7. To save your changes and exit Computer Setup, select **Main**, select **Save Changes and Exit**, and then select **Yes**.



NOTE: If you are using arrow keys to highlight your choice, you must then press [enter](#).

Your changes go into effect when the computer restarts.

Entering a BIOS administrator password

At the **BIOS administrator password** prompt, type your password (using the same kind of keys you used to set the password), and then press [enter](#). After two unsuccessful attempts to enter the BIOS administrator password, you must restart the computer and try again.

Using DriveLock Security Options

DriveLock protection prevents unauthorized access to the contents of a hard drive. DriveLock can be applied only to the internal hard drive(s) of the computer. After DriveLock protection is applied to a drive, the appropriate password must be entered to access the drive. The drive must be inserted into the computer or an advanced port replicator in order for it to be unlocked.

DriveLock Security Options offers the following features:

- **Automatic DriveLock**—See [Selecting Automatic DriveLock \(select products only\) on page 52](#).
- **Set DriveLock Master Password**—See [Selecting manual DriveLock on page 53](#).
- **Enable DriveLock**—See [Enabling DriveLock and setting a DriveLock user password on page 54](#).

Selecting Automatic DriveLock (select products only)

A BIOS administrator password must be set before you can enable Automatic DriveLock. When Automatic DriveLock is enabled, a random DriveLock user password and a DriveLock master password derived from the BIOS administrator password are created. When the computer is turned on, the random user password automatically unlocks the drive. If the drive is moved to another computer, you must enter the BIOS administrator password for the original computer at the DriveLock password prompt to unlock the drive.

Enabling Automatic DriveLock

To enable Automatic DriveLock, follow these steps:

1. Start Computer Setup.
 - Computers or tablets with keyboards:
 1. Turn off the computer.
 2. Press the power button, and when the HP logo appears, press **f10** to enter Computer Setup.
 - Tablets without keyboards:
 1. Turn off the tablet.
 2. Press the power button in combination with the volume down button until the Startup menu is displayed, and then tap **f10** to enter Computer Setup.
2. At the BIOS administrator password prompt, enter the BIOS administrator password, and then press **enter**.
3. Select **Security**, select **Hard Drive Utilities**, select **DriveLock/Automatic DriveLock**, and then press **enter**.
4. Use the **enter** key, left mouse click, or touch screen to select the **Automatic DriveLock** check box.
5. To save your changes and exit Computer Setup, select **Main**, select **Save Changes and Exit**, and then select **Yes**.



NOTE: If you are using arrow keys to highlight your choice, you must then press **enter**.

Disabling Automatic DriveLock

To disable Automatic DriveLock, follow these steps:

1. Start Computer Setup.
 - Computers or tablets with keyboards:
 1. Turn off the computer.
 2. Press the power button, and when the HP logo appears, press **f10** to enter Computer Setup.
 - Tablets without keyboards:

1. Turn off the tablet.
2. Press the power button in combination with the volume down button until the Startup menu is displayed, and then tap **F10** to enter Computer Setup.
2. At the BIOS administrator password prompt, enter the BIOS administrator password, and then press **enter**.
3. Select **Security**, select **Hard Drive Utilities**, select **DriveLock/Automatic DriveLock**, and then press **enter**.
4. Select an internal hard drive, and then press **enter**.
5. Use the **enter** key, left mouse click, or touch screen to clear the **Automatic DriveLock** check box.
6. To save your changes and exit Computer Setup, select **Main**, select **Save Changes and Exit**, and then select **Yes**.



NOTE: If you are using arrow keys to highlight your choice, you must then press **enter**.

Entering an Automatic DriveLock password

While Automatic DriveLock is enabled and the drive remains attached to the original computer, you will not be prompted to enter a DriveLock password to unlock the drive. However, if the drive is moved to another computer, or the system board is replaced on the original computer, you will be prompted to provide the DriveLock password.

If this happens, at the **DriveLock Password** prompt, type the BIOS administrator password for the original computer (using the same kind of keys you used to set the password), and then press **enter** to unlock the drive.

After three incorrect attempts to enter the password, you must shut down the computer and try again.

Selecting manual DriveLock



IMPORTANT: To prevent a DriveLock-protected hard drive from becoming permanently unusable, record the DriveLock user password and the DriveLock master password in a safe place away from your computer. If you forget both DriveLock passwords, the hard drive will be permanently locked and can no longer be used.

To manually apply DriveLock protection to an internal hard drive, a master password must be set, and DriveLock must be enabled in Computer Setup. Note the following considerations about using DriveLock protection:

- After DriveLock protection is applied to a hard drive, the hard drive can be accessed only by entering either the DriveLock user password or the master password.
- The owner of the DriveLock user password should be the day-to-day user of the protected hard drive. The owner of the DriveLock master password may be either a system administrator or the day-to-day user.
- The DriveLock user password and the DriveLock master password can be identical.

Setting a DriveLock master password

To set a DriveLock master password, follow these steps:

1. Start Computer Setup.
 - Computers or tablets with keyboards:

1. Turn off the computer.
2. Press the power button, and when the HP logo appears, press **f10** to enter Computer Setup.
 - Tablets without keyboards:
 1. Turn off the tablet.
 2. Press the power button in combination with the volume down button until the Startup menu is displayed, and then tap **f10** to enter Computer Setup.
2. Select **Security**, make the selection for **Hard Drive Utilities**, select **DriveLock/Automatic DriveLock**, and then press **enter**.
3. Select the hard drive you want to protect, and then press **enter**.
4. Select **Set DriveLock Master Password**, and then press **enter**.
5. Carefully read the warning.
6. Follow the on-screen instructions to set a DriveLock master password.



NOTE: You can enable DriveLock and set a DriveLock user password before exiting from Computer Setup. For more information, see [Enabling DriveLock and setting a DriveLock user password on page 54](#).

7. To save your changes and exit Computer Setup, select **Main**, select **Save Changes and Exit**, and then select **Yes**.



NOTE: If you are using arrow keys to highlight your choice, you must then press **enter**.

Enabling DriveLock and setting a DriveLock user password

To enable DriveLock, and set a DriveLock user password, follow these steps:

1. Start Computer Setup.
 - Computers or tablets with keyboards:
 1. Turn off the computer.
 2. Press the power button, and when the HP logo appears, press **f10** to enter Computer Setup.
 - Tablets without keyboards:
 1. Turn off the tablet.
 2. Press the power button in combination with the volume down button until the Startup menu is displayed, and then tap **f10** to enter Computer Setup.
2. Select **Security**, select **Hard Drive Utilities**, select **DriveLock/Automatic DriveLock**, and then press **enter**.
3. Select the hard drive you want to protect, and then press **enter**.
4. Select **Enable DriveLock** and then press **enter**.
5. Carefully read the warning.
6. Follow the on-screen instructions to set a DriveLock user password and enable DriveLock.
7. To save your changes and exit Computer Setup, select **Main**, select **Save Changes and Exit**, and then select **Yes**.



NOTE: If you are using arrow keys to highlight your choice, you must then press **enter**.

Disabling DriveLock

1. Start Computer Setup.
 - Computers or tablets with keyboards:
 1. Turn off the computer.
 2. Press the power button, and when the HP logo appears, press **f10** to enter Computer Setup.
 - Tablets without keyboards:
 1. Turn off the tablet.
 2. Press the power button in combination with the volume down button until the Startup menu is displayed, and then tap **f10** to enter Computer Setup.
2. Select **Security**, select **Hard Drive Utilities**, select **DriveLock/Automatic DriveLock**, and then press **enter**.
3. Select the hard drive you want to manage, and then press **enter**.
4. Select **Disable DriveLock**, and then press **enter**.
5. Follow the on-screen instructions to disable DriveLock.
6. To save your changes and exit Computer Setup, select **Main**, select **Save Changes and Exit**, and then select **Yes**.



NOTE: If you are using arrow keys to highlight your choice, you must then press **enter**.

Entering a DriveLock password

Be sure that the hard drive is inserted into the computer (not into an optional docking device or external MultiBay).

At the **DriveLock Password** prompt, type your DriveLock user or master password (using the same kind of keys you used to set the password), and then press **enter**.

After three incorrect attempts to enter the password, you must shut down the computer and try again.

Changing a DriveLock password

To change a DriveLock password in Computer Setup, follow these steps:

1. Turn off the computer.
2. Press the power button.
3. At the **DriveLock Password** prompt, type the current DriveLock user password or master password that you are changing, press **enter**, and then press or tap **f10** to enter Computer Setup.
4. Select **Security**, select **Hard Drive Utilities**, select **DriveLock/Automatic DriveLock**, and then press **enter**.
5. Select the hard drive you want to manage, and then press **enter**.
6. Make the selection for the DriveLock password that you want to change, and then follow the on-screen instructions to enter passwords.

 **NOTE:** The **Change DriveLock Master Password** option is visible only if the DriveLock master password was provided at the DriveLock Password prompt in step 3.

7. To save your changes and exit Computer Setup, select **Main**, select **Save Changes and Exit**, and then select **Yes**.

 **NOTE:** If you are using arrow keys to highlight your choice, you must then press **enter**.

Windows Hello (select products only)

On products equipped with a fingerprint reader or an infrared camera, you can use Windows Hello to sign in by swiping your finger or looking at the camera.

To set up Windows Hello:

1. Select the **Start** button, select **Settings**, select **Accounts**, and then select **Sign-in options**.
2. To add a password, select **Add**.
3. Select **Get Started**, and then follow the on-screen instructions to enroll your fingerprint or facial ID and set up a PIN.

 **IMPORTANT:** To prevent fingerprint logon issues, make sure when you register your fingerprint that all sides of your finger are registered by the fingerprint reader.

 **NOTE:** The PIN is not limited in length. The default setting is for numbers only. To include alphabetic or special characters, select the **include letters and symbols** check box.

Using antivirus software

When you use the computer to access e-mail, a network, or the Internet, you potentially expose it to computer viruses. Computer viruses can disable the operating system, programs, or utilities, or cause them to function abnormally.

Antivirus software can detect most viruses, destroy them, and, in most cases, repair any damage they have caused. To provide ongoing protection against newly discovered viruses, antivirus software must be kept up to date.

Windows Defender is preinstalled on your computer. It is strongly recommended that you continue to use an antivirus program in order to fully protect your computer.

For more information about computer viruses, access the HP Support Assistant.

Using firewall software

Firewalls are designed to prevent unauthorized access to a system or network. A firewall can be a software program you install on your computer and/or network, or it can be a solution made up of both hardware and software.

There are two types of firewalls to consider:

- Host-based firewalls—Software that protects only the computer it is installed on.
- Network-based firewalls—Installed between your DSL or cable modem and your home network to protect all the computers on the network.

When a firewall is installed on a system, all data sent to and from the system is monitored and compared with a set of user-defined security criteria. Any data that does not meet those criteria is blocked.

Your computer or networking equipment may already have a firewall installed. If not, firewall software solutions are available.

 **NOTE:** Under some circumstances a firewall can block access to Internet games, interfere with printer or file sharing on a network, or block authorized e-mail attachments. To temporarily resolve the problem, disable the firewall, perform the task that you want to perform, and then reenable the firewall. To permanently resolve the problem, reconfigure the firewall.

Installing software updates

HP, Windows, and third-party software installed on your computer should be regularly updated to correct security problems and improve software performance.

 **IMPORTANT:** Microsoft sends out alerts regarding Windows updates, which may include security updates. To protect the computer from security breaches and computer viruses, install all updates from Microsoft as soon as you receive an alert.

You can install these updates automatically.

To view or change the settings:

1. Select the **Start** button, select **Settings**, and then select **Update & Security**.
2. Select **Windows Update**, and then follow the on-screen instructions.
3. To schedule a time for installing updates, select **Advanced Options**, and then follow the on-screen instructions.

Using HP Client Security (select products only)

HP Client Security software is preinstalled on your computer. This software can be accessed through the HP Client Security icon at the far right of the taskbar or Windows Control Panel. It provides security features that help protect against unauthorized access to the computer, networks, and critical data. For more information, see the HP Client Security software Help.

Using HP Device as a Service (select products only)

HP DaaS is a cloud-based IT solution that enables businesses to effectively manage and secure their company assets. HP DaaS helps protect devices against malware and other attacks, monitors device health, and helps reduce time spent solving device and security issues. You can quickly download and install the software, which is highly cost effective relative to traditional in-house solutions. For more information, go to <https://www.hptouchpointmanager.com/>.

Using an optional security cable (select products only)

A security cable (purchased separately) is designed to act as a deterrent, but it may not prevent the computer from being mishandled or stolen. To connect a security cable to your computer, follow the device manufacturer's instructions.

Using a fingerprint reader (select products only)

Integrated fingerprint readers are available on select products. In order to use the fingerprint reader, you must enroll your fingerprints in HP Client Security's Credential Manager. For more information, see the HP Client Security software Help.

After you enroll your fingerprints in Credential Manager, you can use HP Client Security's Password Manager to store and fill in your user names and passwords in supported websites and applications.

Locating the fingerprint reader

The fingerprint reader is a small metallic sensor that is located in one of the following areas of your computer:

- Near the bottom of the touchpad
- On the right side of the keyboard
- On the upper-right side of the display
- On the left side of the display
- On the back of the display

Depending on your product, the reader may be oriented horizontally or vertically.

8 Maintenance

Performing regular maintenance keeps your computer in optimal condition. This chapter explains how to use tools like Disk Defragmenter and Disk Cleanup. It also provides instructions for updating programs and drivers, steps to clean the computer, and tips for traveling with (or shipping) the computer.

Improving performance

You can improve the performance of your computer by performing regular maintenance tasks with tools such as Disk Defragmenter and Disk Cleanup.

Using Disk Defragmenter

HP recommends using Disk Defragmenter to defragment your hard drive at least once a month.



NOTE: It is not necessary to run Disk Defragmenter on solid-state drives.

To run Disk Defragmenter:

1. Connect the computer to AC power.
2. Type `defragment` in the taskbar search box, and then select **Defragment and optimize your drives**.
3. Follow the on-screen instructions.

For additional information, access the Disk Defragmenter software Help.

Using Disk Cleanup

Use Disk Cleanup to search the hard drive for unnecessary files that you can safely delete to free up disk space and help the computer run more efficiently.

To run Disk Cleanup:

1. Type `disk` in the taskbar search box, and then select **Disk Cleanup**.
2. Follow the on-screen instructions.

Using HP 3D DriveGuard (select products only)

HP 3D DriveGuard protects a hard drive by parking the drive and halting data requests under either of the following conditions:

- You drop the computer.
- You move the computer with the display closed while the computer is running on battery power.

A short time after one of these events, HP 3D DriveGuard returns the hard drive to normal operation.

 **NOTE:** Only internal hard drives are protected by HP 3D DriveGuard. A hard drive installed in an optional docking device or connected to a USB port is not protected by HP 3D DriveGuard.

 **NOTE:** Because solid-state drives (SSDs) lack moving parts, HP 3D DriveGuard is unnecessary for these drives.

Identifying HP 3D DriveGuard status

The hard drive light on the computer changes color to show that the drive in a primary hard drive bay and/or the drive in a secondary hard drive bay (select products only) is parked.

Updating programs and drivers

HP recommends that you update your programs and drivers on a regular basis. Updates can resolve issues and bring new features and options to your computer. For example, older graphics components might not work well with the most recent gaming software. Without the latest driver, you would not be getting the most out of your equipment.

Go to <http://www.hp.com/support> to download the latest versions of HP programs and drivers. In addition, register to receive automatic notifications when updates become available.

If you would like to update your programs and drivers, follow these instructions:

1. Type `support` in the taskbar search box, and then select the **HP Support Assistant** app.
– or –
Select the question mark icon in the taskbar.
2. Select **My notebook**, select the **Updates** tab, and then select **Check for updates and messages**.
3. Follow the on-screen instructions.

Cleaning your computer

Use the following products to safely clean your computer:

- Alcohol-free glass-cleaning fluid
- Solution of water and mild soap
- Dry microfiber cleaning cloth or a chamois (static-free cloth without oil)
- Static-free cloth wipes

 **CAUTION:** Avoid strong cleaning solvents or germicidal wipes that can permanently damage your computer. If you are not sure that a cleaning product is safe for your computer, check the product contents to make sure that ingredients such as alcohol, acetone, ammonium chloride, methylene chloride, hydrogen peroxide, naphtha, and hydrocarbon solvents are not included in the product.

Fibrous materials, such as paper towels, can scratch the computer. Over time, dirt particles and cleaning agents can get trapped in the scratches.

Cleaning procedures

Follow the procedures in this section to safely clean your computer.

 **WARNING!** To prevent electric shock or damage to components, do not attempt to clean your computer while it is on.

1. Turn off the computer.
2. Disconnect AC power.
3. Disconnect all powered external devices.

 **CAUTION:** To prevent damage to internal components, do not spray cleaning agents or liquids directly on any computer surface. Liquids dripped on the surface can permanently damage internal components.

Cleaning the display

Gently wipe the display using a soft, lint-free cloth moistened with an alcohol-free glass cleaner. Be sure that a display is dry before you close the computer.

Cleaning the sides or cover

To clean the sides or cover, use a soft microfiber cloth or chamois moistened with one of the cleaning solutions listed previously, or use an acceptable disposable wipe.

 **NOTE:** When cleaning the cover of the computer, use a circular motion to aid in removing dirt and debris.

Cleaning the touchpad, keyboard, or mouse (select products only)

 **WARNING!** To reduce the risk of electric shock or damage to internal components, do not use a vacuum cleaner attachment to clean the keyboard. A vacuum cleaner can deposit household debris on the keyboard surface.

 **CAUTION:** To prevent damage to internal components, do not allow liquids to drip between the keys.

- To clean the touchpad, keyboard, or mouse, use a soft microfiber cloth or a chamois moistened with one of the cleaning solutions listed previously.
- To prevent keys from sticking and to remove dust, lint, and particles from the keyboard, use a can of compressed air with a straw extension.

Traveling with or shipping your computer

If you have to travel with or ship your computer, follow these tips to keep your equipment safe.

- Prepare the computer for traveling or shipping:
 - Back up your information to an external drive.
 - Remove all discs and all external media cards, such as memory cards.
 - Turn off and then disconnect all external devices.
 - Shut down the computer.
- Take along a backup of your information. Keep the backup separate from the computer.

- When traveling by air, carry the computer as hand luggage; do not check it in with the rest of your luggage.

 **CAUTION:** Avoid exposing a drive to magnetic fields. Security devices with magnetic fields include airport walk-through devices and security wands. Airport conveyer belts and similar security devices that check carry-on baggage use X-rays instead of magnetism and do not damage drives.

- If you plan to use the computer during a flight, listen for the in-flight announcement that tells you when you are allowed to use your computer. In-flight computer use is at the discretion of the airline.
- If you are shipping the computer or a drive, use suitable protective packaging and label the package “FRAGILE.”
- The use of wireless devices might be restricted in some environments. Such restrictions might apply aboard aircraft, in hospitals, near explosives, and in hazardous locations. If you are uncertain of the policy that applies to the use of a wireless device in your computer, ask for authorization to use your computer before you turn it on.
- If you are traveling internationally, follow these suggestions:
 - Check the computer-related customs regulations for each country or region on your itinerary.
 - Check the power cord and adapter requirements for each location in which you plan to use the computer. Voltage, frequency, and plug configurations vary.

 **WARNING!** To reduce the risk of electric shock, fire, or damage to the equipment, do not attempt to power the computer with a voltage converter kit sold for appliances.

9 Backing up, restoring, and recovering

This chapter provides information about the following processes, which are standard procedure for most products:

- **Backing up your personal information**—You can use Windows tools to back up your personal information (see [Using Windows tools on page 63](#)).
- **Creating a restore point**—You can use Windows tools to create a restore point (see [Using Windows tools on page 63](#)).
- **Creating recovery media** (select products only)—You can use the HP Cloud Recovery Download Tool (select products only) to create recovery media (see [Using the HP Cloud Recovery Download Tool to create recovery media \(select products only\) on page 63](#)).
- **Restoring and recovery**—Windows offers several options for restoring from backup, refreshing the computer, and resetting the computer to its original state (see [Using Windows tools on page 63](#)).

 **IMPORTANT:** If you will be performing recovery procedures on a tablet, the tablet battery must be at least 70% charged before you start the recovery process.

IMPORTANT: For a tablet with a detachable keyboard, connect the tablet to the keyboard base before beginning any recovery process.

Backing up information and creating recovery media

Using Windows tools

 **IMPORTANT:** Windows is the only option that allows you to back up your personal information. Schedule regular backups to avoid information loss.

You can use Windows tools to back up personal information and create system restore points and recovery media.

 **NOTE:** If computer storage is 32 GB or less, Microsoft System Restore is disabled by default.

For more information and steps, see the Get Help app.

1. Select the **Start** button, and then select the **Get Help** app.
2. Enter the task you want to perform.

 **NOTE:** You must be connected to the Internet to access the Get Help app.

Using the HP Cloud Recovery Download Tool to create recovery media (select products only)

You can use the HP Cloud Recovery Download Tool to create HP Recovery media on a bootable USB flash drive.

To download the tool:

- ▲ Go to the Microsoft Store and search for HP Cloud Recovery.

For details, go to <http://www.hp.com/support>, search for HP Cloud Recovery, and then select "HP PCs – Using the Cloud Recovery Tool (Windows 10, 7)."



NOTE: If you cannot create recovery media yourself, contact support to obtain recovery discs. Go to <http://www.hp.com/support>, select your country or region, and then follow the on-screen instructions.

Restoring and recovery

Restoring, resetting, and refreshing using Windows tools

Windows offers several options for restoring, resetting, and refreshing the computer. For details, see [Using Windows tools on page 63](#).

Recovering using HP Recovery media

HP Recovery media is used to recover the original operating system and software programs that were installed at the factory. On select products, it can be created on a bootable USB flash drive using the HP Cloud Recovery Download Tool. For details, see [Using the HP Cloud Recovery Download Tool to create recovery media \(select products only\) on page 63](#).



NOTE: If you cannot create recovery media yourself, contact support to obtain recovery discs. Go to <http://www.hp.com/support>, select your country or region, and then follow the on-screen instructions.

To recover your system:

- ▲ Insert the HP Recovery media, and then restart the computer.

Changing the computer boot order

If your computer does not restart using the HP Recovery media, you can change the computer boot order. This is the order of devices listed in BIOS where the computer looks for startup information. You can change the selection to an optical drive or a USB flash drive, depending on the location of your HP Recovery media.

To change the boot order:



IMPORTANT: For a tablet with a detachable keyboard, connect the tablet to the keyboard base before beginning these steps.

1. Insert the HP Recovery media.
2. Access the system **Startup** menu.

For computers or tablets with keyboards attached:

- ▲ Turn on or restart the computer or tablet, quickly press **esc**, and then press **f9** for boot options.

For tablets without keyboards:

- ▲ Turn on or restart the tablet, quickly hold down the volume up button, and then select **f9**.

– or –

Turn on or restart the tablet, quickly hold down the volume down button, and then select **f9**.

3. Select the optical drive or USB flash drive from which you want to boot, and then follow the on-screen instructions.

Using HP Sure Recover (select products only)

Select computer models are configured with HP Sure Recover, a PC OS recovery solution built into the hardware and firmware. HP Sure Recover can fully restore the HP OS image without installed recovery software.

Using HP Sure Recover, an administrator or user can restore the system and install:

- Latest version of the operating system
- Platform-specific device drivers
- Software applications, in the case of a custom image

To access the latest documentation for HP Sure Recover, go to <http://www.hp.com/support>. Select **Find your product**, and then follow the on-screen instructions.

10 Computer Setup (BIOS), TPM, and HP Sure Start

Using Computer Setup

Computer Setup, or Basic Input/Output System (BIOS), controls communication between all the input and output devices on the system (such as disk drives, display, keyboard, mouse, and printer). Computer Setup includes settings for the types of devices installed, the startup sequence of the computer, and the amount of system and extended memory.

 **NOTE:** Use extreme care when making changes in Computer Setup. Errors can prevent the computer from operating properly.

Starting Computer Setup

- ▲ Turn on or restart the computer, and when the HP logo appears, press **f10** to enter Computer Setup.

Navigating and selecting in Computer Setup

- To select a menu or a menu item, use the **tab** key and the keyboard arrow keys and then press **enter**, or use a pointing device to select the item.
- To scroll up and down, select the up arrow or the down arrow in the upper-right corner of the screen, or use the up arrow key or the down arrow key on the keyboard.
- To close open dialog boxes and return to the main Computer Setup screen, press **esc**, and then follow the on-screen instructions.

To exit Computer Setup, choose one of the following methods:

- To exit Computer Setup menus without saving your changes, select **Main**, select **Ignore Changes and Exit**, and then select **Yes**.

 **NOTE:** If you are using arrow keys to highlight your choice, you must then press **enter**.

- To save your changes and exit Computer Setup menus, select **Main**, select **Save Changes and Exit**, and then select **Yes**.

 **NOTE:** If you are using arrow keys to highlight your choice, you must then press **enter**.

Your changes go into effect when the computer restarts.

Restoring factory settings in Computer Setup

 **NOTE:** Restoring defaults will not change the hard drive mode.

To return all settings in Computer Setup to the values that were set at the factory, follow these steps:

1. Start Computer Setup. See [Starting Computer Setup on page 66](#).
2. Select **Main**, select **Apply Factory Defaults and Exit**, and then select **Yes**.

 **NOTE:** If you are using arrow keys to highlight your choice, you must then press **enter**.

 **NOTE:** On select products, the selections may display **Restore Defaults** instead of **Apply Factory Defaults and Exit**.

Your changes go into effect when the computer restarts.

 **NOTE:** Your password settings and security settings are not changed when you restore the factory settings.

Updating the BIOS

Updated versions of the BIOS may be available on the HP website.

Most BIOS updates on the HP website are packaged in compressed files called *SoftPaqs*.

Some download packages contain a file named *Readme.txt*, which contains information regarding installing and troubleshooting the file.

Determining the BIOS version

To decide whether you need to update Computer Setup (BIOS), first determine the BIOS version on your computer.

BIOS version information (also known as *ROM date* and *System BIOS*) can be accessed by pressing **fn+esc** (if you are already in Windows) or by using Computer Setup.

1. Start Computer Setup. See [Starting Computer Setup on page 66](#).
2. Select **Main**, and then select **System Information**.
3. To exit Computer Setup menus without saving your changes, select **Main**, select **Ignore Changes and Exit**, and then select **Yes**.

 **NOTE:** If you are using arrow keys to highlight your choice, you must then press **enter**.

To check for later BIOS versions, see [Downloading a BIOS update on page 67](#).

Downloading a BIOS update

 **CAUTION:** To reduce the risk of damage to the computer or an unsuccessful installation, download and install a BIOS update only when the computer is connected to reliable external power using the AC adapter. Do not download or install a BIOS update while the computer is running on battery power, docked in an optional docking device, or connected to an optional power source. During the download and installation, follow these instructions:

Do not disconnect power on the computer by unplugging the power cord from the AC outlet.

Do not shut down the computer or initiate Sleep.

Do not insert, remove, connect, or disconnect any device, cable, or cord.

1. Type `support` in the taskbar search box, and then select the HP Support Assistant app.
– or –
Select the question mark icon in the taskbar.
2. Select **Updates**, and then select **Check for updates and messages**.
3. Follow the on-screen instructions.
4. At the download area, follow these steps:

- a. Identify the most recent BIOS update and compare it to the BIOS version currently installed on your computer. Make a note of the date, name, or other identifier. You may need this information to locate the update later, after it has been downloaded to your hard drive.
- b. Follow the on-screen instructions to download your selection to the hard drive.

Make a note of the path to the location on your hard drive where the BIOS update is downloaded. You will need to access this path when you are ready to install the update.

 **NOTE:** If you connect your computer to a network, consult the network administrator before installing any software updates, especially system BIOS updates.

BIOS installation procedures vary. Follow any instructions that are displayed on the screen after the download is complete. If no instructions are displayed, follow these steps:

1. Type *file* in the taskbar search box, and then select **File Explorer**.
2. Select your hard drive designation. The hard drive designation is typically Local Disk (C:).
3. Using the hard drive path you recorded earlier, open the folder that contains the update.
4. Double-click the file that has an .exe extension (for example, *filename.exe*).

The BIOS installation begins.

5. Complete the installation by following the on-screen instructions.

 **NOTE:** After a message on the screen reports a successful installation, you can delete the downloaded file from your hard drive.

Changing the boot order using the f9 prompt

To dynamically choose a boot device for the current startup sequence, follow these steps:

1. Access the Boot Device Options menu:
 - Turn on or restart the computer, and when the HP logo appears, press **f9** to enter the Boot Device Options menu.
2. Select a boot device, press **enter**, and then follow the on-screen instructions.

TPM BIOS settings (select products only)

 **IMPORTANT:** Before enabling Trusted Platform Module (TPM) functionality on this system, you must ensure that your intended use of TPM complies with relevant local laws, regulations and policies, and approvals or licenses must be obtained if applicable. For any compliance issues arising from your operation/usage of TPM which violates the above mentioned requirement, you shall bear all the liabilities wholly and solely. HP will not be responsible for any related liabilities.

TPM provides additional security for your computer. You can modify the TPM settings in Computer Setup (BIOS).

 **NOTE:** If you change the TPM setting to Hidden, TPM is not visible in the operating system.

To access TPM settings in Computer Setup:

1. Start Computer Setup. See [Starting Computer Setup on page 66](#).
2. Select **Security**, select **TPM Embedded Security**, and then follow the on-screen instructions.

Using HP Sure Start (select products only)

Select computer models are configured with HP Sure Start, a technology that monitors the computer's BIOS for attacks or corruption. If the BIOS becomes corrupted or is attacked, HP Sure Start automatically restores the BIOS to its previously safe state, without user intervention.

HP Sure Start is configured and already enabled so that most users can use the HP Sure Start default configuration. The default configuration can be customized by advanced users.

To access the latest documentation on HP Sure Start, go to <http://www.hp.com/support>. Select **Find your product**, and then follow the on-screen instructions.

11 Using HP PC Hardware Diagnostics

Using HP PC Hardware Diagnostics Windows (select products only)

HP PC Hardware Diagnostics Windows is a Windows-based utility that allows you to run diagnostic tests to determine whether the computer hardware is functioning properly. The tool runs within the Windows operating system in order to diagnose hardware failures.

If HP PC Hardware Diagnostics Windows is not installed on your computer, first you must download and install it. To download HP PC Hardware Diagnostics Windows, see [Downloading HP PC Hardware Diagnostics Windows on page 70](#).

After HP PC Hardware Diagnostics Windows is installed, follow these steps to access it from HP Help and Support or HP Support Assistant.

1. To access HP PC Hardware Diagnostics Windows from HP Help and Support:

- a. Select the **Start** button, and then select **HP Help and Support**.
- b. Select **HP PC Hardware Diagnostics Windows**.

– or –

To access HP PC Hardware Diagnostics Windows from HP Support Assistant:

- a. Type `support` in the taskbar search box, and then select the **HP Support Assistant** app.

– or –

Select the question mark icon in the taskbar.

- b. Select **Troubleshooting and fixes**.
- c. Select **Diagnostics**, and then select **HP PC Hardware Diagnostics Windows**.

2. When the tool opens, select the type of diagnostic test you want to run, and then follow the on-screen instructions.

 **NOTE:** If you need to stop a diagnostic test at any time, select **Cancel**.

When HP PC Hardware Diagnostics Windows detects a failure that requires hardware replacement, a 24-digit Failure ID code is generated. The screen displays one of the following options:

- A Failure ID link is displayed. Select the link and follow the on-screen instructions.
- A Quick Response (QR) code is displayed. With a mobile device, scan the code and then follow the on-screen instructions.
- Instructions for calling support are displayed. Follow those instructions.

Downloading HP PC Hardware Diagnostics Windows

- The HP PC Hardware Diagnostics Windows download instructions are provided in English only.
- You must use a Windows computer to download this tool because only .exe files are provided.

Downloading the latest HP PC Hardware Diagnostics Windows version

To download HP PC Hardware Diagnostics Windows, follow these steps:

1. Go to <http://www.hp.com/go/techcenter/pcdiags>. The HP PC Diagnostics home page is displayed.
2. Select **Download HP Diagnostics Windows**, and then select a location on your computer or a USB flash drive.

The tool is downloaded to the selected location.

Downloading HP Hardware Diagnostics Windows by product name or number (select products only)

 **NOTE:** For some products, it may be necessary to download the software to a USB flash drive by using the product name or number.

To download HP PC Hardware Diagnostics Windows by product name or number, follow these steps:

1. Go to <http://www.hp.com/support>.
2. Select **Get software and drivers**, select your type of product, and then enter the product name or number in the search box that is displayed.
3. In the **Diagnostics** section, select **Download**, and then follow the on-screen instructions to select the specific Windows diagnostics version to be downloaded to your computer or USB flash drive.

The tool is downloaded to the selected location.

Installing HP PC Hardware Diagnostics Windows

To install HP PC Hardware Diagnostics Windows, follow these steps:

- ▲ Navigate to the folder on your computer or the USB flash drive where the .exe file was downloaded, double-click the .exe file, and then follow the on-screen instructions.

Using HP PC Hardware Diagnostics UEFI

 **NOTE:** For Windows 10 S computers, you must use a Windows computer and a USB flash drive to download and create the HP UEFI support environment because only .exe files are provided. For more information, see [Downloading HP PC Hardware Diagnostics UEFI to a USB flash drive on page 72](#).

HP PC Hardware Diagnostics UEFI (Unified Extensible Firmware Interface) allows you to run diagnostic tests to determine whether the computer hardware is functioning properly. The tool runs outside the operating system so that it can isolate hardware failures from issues that are caused by the operating system or other software components.

If your PC will not boot into Windows, you can use HP PC Hardware Diagnostics UEFI to diagnose hardware issues.

When HP PC Hardware Diagnostics Windows detects a failure that requires hardware replacement, a 24-digit Failure ID code is generated. For assistance in solving the problem:

- ▲ Select **Get Support**, and then use a mobile device to scan the QR code that displays on the next screen. The HP Customer Support - Service Center page displays, with your Failure ID and product number automatically filled in. Follow the on-screen instructions.

– or –

Contact support, and provide the Failure ID code.

 **NOTE:** To start diagnostics on a convertible computer, your computer must be in notebook mode, and you must use the attached keyboard.

 **NOTE:** If you need to stop a diagnostic test, press `esc`.

Starting HP PC Hardware Diagnostics UEFI

To start HP PC Hardware Diagnostics UEFI, follow these steps:

1. Turn on or restart the computer, and quickly press `esc`.
2. Press `f2`.

The BIOS searches three places for the diagnostic tools, in the following order:

- a. Connected USB flash drive

 **NOTE:** To download the HP PC Hardware Diagnostics UEFI tool to a USB flash drive, see [Downloading the latest HP PC Hardware Diagnostics UEFI version on page 72](#).

- b. Hard drive

- c. BIOS

3. When the diagnostic tool opens, select a language, select the type of diagnostic test you want to run, and then follow the on-screen instructions.

Downloading HP PC Hardware Diagnostics UEFI to a USB flash drive

Downloading HP PC Hardware Diagnostics UEFI to a USB flash drive can be useful in the following situations:

- HP PC Hardware Diagnostics UEFI is not included in the preinstall image.
- HP PC Hardware Diagnostics UEFI is not included in the HP Tool partition.
- The hard drive is damaged.

 **NOTE:** The HP PC Hardware Diagnostics UEFI download instructions are provided in English only, and you must use a Windows computer to download and create the HP UEFI support environment because only `.exe` files are provided.

Downloading the latest HP PC Hardware Diagnostics UEFI version

To download the latest HP PC Hardware Diagnostics UEFI version to a USB flash drive:

1. Go to <http://www.hp.com/go/techcenter/pcdiags>. The HP PC Diagnostics home page is displayed.
2. Select **Download HP Diagnostics UEFI**, and then select **Run**.

Downloading HP PC Hardware Diagnostics UEFI by product name or number (select products only)

 **NOTE:** For some products, it may be necessary to download the software to a USB flash drive by using the product name or number.

To download HP PC Hardware Diagnostics UEFI by product name or number (select products only) to a USB flash drive:

1. Go to <http://www.hp.com/support>.
2. Enter the product name or number, select your computer, and then select your operating system.
3. In the **Diagnostics** section, follow the on-screen instructions to select and download the specific UEFI Diagnostics version for your computer.

Using Remote HP PC Hardware Diagnostics UEFI settings (select products only)

Remote HP PC Hardware Diagnostics UEFI is a firmware (BIOS) feature that downloads HP PC Hardware Diagnostics UEFI to your computer. It can then execute the diagnostics on your computer, and it may upload results to a preconfigured server. For more information about Remote HP PC Hardware Diagnostics UEFI, go to <http://www.hp.com/go/techcenter/pcdiags>, and then select **Find out more**.

Downloading Remote HP PC Hardware Diagnostics UEFI



NOTE: HP Remote PC Hardware Diagnostics UEFI is also available as a Softpaq that can be downloaded to a server.

Downloading the latest Remote HP PC Hardware Diagnostics UEFI version

To download the latest Remote HP PC Hardware Diagnostics UEFI version, follow these steps:

1. Go to <http://www.hp.com/go/techcenter/pcdiags>. The HP PC Diagnostics home page is displayed.
2. Select **Download Remote Diagnostics**, and then select **Run**.

Downloading Remote HP PC Hardware Diagnostics UEFI by product name or number



NOTE: For some products, it may be necessary to download the software by using the product name or number.

To download HP Remote PC Hardware Diagnostics UEFI by product name or number, follow these steps:

1. Go to <http://www.hp.com/support>.
2. Select **Get software and drivers**, select your type of product, enter the product name or number in the search box that is displayed, select your computer, and then select your operating system.
3. In the **Diagnostics** section, follow the on-screen instructions to select and download the **Remote UEFI** version for the product.

Customizing Remote HP PC Hardware Diagnostics UEFI settings

Using the Remote HP PC Hardware Diagnostics setting in Computer Setup (BIOS), you can perform the following customizations:

- Set a schedule for running diagnostics unattended. You can also start diagnostics immediately in interactive mode by selecting **Execute Remote HP PC Hardware Diagnostics**.
- Set the location for downloading the diagnostic tools. This feature provides access to the tools from the HP website or from a server that has been preconfigured for use. Your computer does not require the traditional local storage (such as a disk drive or USB flash drive) to run remote diagnostics.

- Set a location for storing the test results. You can also set the user name and password settings used for uploads.
- Display status information about the diagnostics run previously.

To customize Remote HP PC Hardware Diagnostics UEFI settings, follow these steps:

1. Turn on or restart the computer, and when the HP logo appears, press **f10** to enter Computer Setup.
2. Select **Advanced**, and then select **Settings**.
3. Make your customization selections.
4. Select **Main**, and then **Save Changes and Exit** to save your settings.

Your changes take effect when the computer restarts.

12 Specifications

Input power

The power information in this section may be helpful if you plan to travel internationally with the computer.

The computer operates on DC power, which can be supplied by an AC or a DC power source. The AC power source must be rated at 100–240 V, 50–60 Hz. Although the computer can be powered from a standalone DC power source, it should be powered only with an AC adapter or a DC power source supplied and approved by HP for use with this computer.

The computer can operate on DC power within the following specifications. The voltage and current for your computer is located on the regulatory label.

Table 12-1 DC power specifications

Input Power	Rating
Operating voltage and current	5 V dc @ 2 A / 12 V dc @ 3 A / 15 V dc @ 3 A – 45 W USB-C
	5 V dc @ 3 A / 9 V dc @ 3 A / 12 V dc @ 3.75 A / 15 V dc @ 3 A – 45 W USB-C
	5 V dc @ 3 A / 9 V dc @ 3 A / 10 V dc @ 3.75 A / 12 V dc @ 3.75 A / 15 V dc @ 3 A / 20 V dc @ 2.25 A – 45 W USB-C
	5 V dc @ 3 A / 9 V dc @ 3 A / 12 V dc @ 5 A / 15 V dc @ 4.33 A / 20 V dc @ 3.25 A – 65 W USB-C
	5 V dc @ 3 A / 9 V dc @ 3 A / 10 V dc @ 5 A / 12 V dc @ 5 A / 15 V dc @ 4.33 A / 20 V dc @ 3.25 A – 65 W USB-C
	5 V dc @ 3 A / 9 V dc @ 3 A / 10 V dc @ 5 A / 12 V dc @ 5 A / 15 V dc @ 5 A / 20 V dc @ 4.5 A – 90 W USB-C
	19.5 V dc @ 2.31 A – 45 W
	19.5 V dc @ 3.33 A – 65 W
	19.5 V dc @ 4.62 A – 90 W
	19.5 V dc @ 6.15 A – 120 W
	19.5 V dc @ 6.9 A – 135 W
	19.5 V dc @ 7.70 A – 150 W
	19.5 V dc @ 10.3 A – 200 W
19.5 V dc @ 11.8 A – 230 W	
19.5 V dc @ 16.92 A – 330 W	



NOTE: This product is designed for IT power systems in Norway with phase-to-phase voltage not exceeding 240 V rms.

Operating environment

Table 12-2 Operating environment specifications

Factor	Metric	U.S.
Temperature		
Operating (writing to optical disc)	5°C to 35°C	41°F to 95°F
Nonoperating	-20°C to 60°C	-4°F to 140°F
Relative humidity (noncondensing)		
Operating	10% to 90%	10% to 90%
Nonoperating	5% to 95%	5% to 95%
Maximum altitude (unpressurized)		
Operating	-15 m to 3,048 m	-50 ft to 10,000 ft
Nonoperating	-15 m to 12,192 m	-50 ft to 40,000 ft

13 Electrostatic discharge

Electrostatic discharge is the release of static electricity when two objects come into contact—for example, the shock you receive when you walk across the carpet and touch a metal door knob.

A discharge of static electricity from fingers or other electrostatic conductors may damage electronic components.



IMPORTANT: To prevent damage to the computer, damage to a drive, or loss of information, observe these precautions:

- If removal or installation instructions direct you to unplug the computer, first be sure that it is properly grounded.
 - Keep components in their electrostatic-safe containers until you are ready to install them.
 - Avoid touching pins, leads, and circuitry. Handle electronic components as little as possible.
 - Use nonmagnetic tools.
 - Before handling components, discharge static electricity by touching an unpainted metal surface.
 - If you remove a component, place it in an electrostatic-safe container.
-

14 Accessibility

HP and accessibility

Because HP works to weave diversity, inclusion, and work/life into the fabric of the company, it is reflected in everything HP does. HP strives to create an inclusive environment focused on connecting people to the power of technology throughout the world.

Finding the technology tools you need

Technology can unleash your human potential. Assistive technology removes barriers and helps you create independence at home, at work, and in the community. Assistive technology helps increase, maintain, and improve the functional capabilities of electronic and information technology. For more information, see [Finding the best assistive technology on page 79](#).

The HP commitment

HP is committed to providing products and services that are accessible for people with disabilities. This commitment supports the company's diversity objectives and helps ensure that the benefits of technology are available to all.

The HP accessibility goal is to design, produce, and market products and services that can be effectively used by everyone, including people with disabilities, either on a stand-alone basis or with appropriate assistive devices.

To achieve that goal, this Accessibility Policy establishes seven key objectives to guide HP actions. All HP managers and employees are expected to support these objectives and their implementation in accordance with their roles and responsibilities:

- Raise the level of awareness of accessibility issues within HP, and provide employees with the training they need to design, produce, market, and deliver accessible products and services.
- Develop accessibility guidelines for products and services, and hold product development groups accountable for implementing these guidelines where competitively, technically, and economically feasible.
- Involve people with disabilities in the development of accessibility guidelines and in the design and testing of products and services.
- Document accessibility features, and make information about HP products and services publicly available in an accessible form.
- Establish relationships with leading assistive technology and solution providers.
- Support internal and external research and development that improves assistive technology relevant to HP products and services.
- Support and contribute to industry standards and guidelines for accessibility.

International Association of Accessibility Professionals (IAAP)

IAAP is a not-for-profit association focused on advancing the accessibility profession through networking, education, and certification. The objective is to help accessibility professionals develop and advance their careers and to better enable organizations to integrate accessibility into their products and infrastructure.

As a founding member, HP joined to participate with other organizations to advance the field of accessibility. This commitment supports HP's accessibility goal of designing, producing, and marketing products and services that people with disabilities can effectively use.

IAAP will make the profession strong by globally connecting individuals, students, and organizations to learn from one another. If you are interested in learning more, go to <http://www.accessibilityassociation.org> to join the online community, sign up for newsletters, and learn about membership options.

Finding the best assistive technology

Everyone, including people with disabilities or age-related limitations, should be able to communicate, express themselves, and connect with the world using technology. HP is committed to increasing accessibility awareness within HP and with our customers and partners. Whether it's large fonts that are easy on the eyes, voice recognition that lets you give your hands a rest, or any other assistive technology to help with your specific situation—a variety of assistive technologies make HP products easier to use. How do you choose?

Assessing your needs

Technology can unleash your potential. Assistive technology removes barriers and helps you create independence at home, at work, and in the community. Assistive technology (AT) helps increase, maintain, and improve the functional capabilities of electronic and information technology.

You can choose from many AT products. Your AT assessment should allow you to evaluate several products, answer your questions, and facilitate your selection of the best solution for your situation. You will find that professionals qualified to do AT assessments come from many fields, including those licensed or certified in physical therapy, occupational therapy, speech/language pathology, and other areas of expertise. Others, while not certified or licensed, can also provide evaluation information. You will want to ask about the individual's experience, expertise, and fees to determine if they are appropriate for your needs.

Accessibility for HP products

The following links provide information about accessibility features and assistive technology, if applicable, included in various HP products. These resources will help you select the specific assistive technology features and product(s) most appropriate for your situation.

- [HP Elite x3—Accessibility Options \(Windows 10 Mobile\)](#)
- [HP PCs—Windows 7 Accessibility Options](#)
- [HP PCs—Windows 8 Accessibility Options](#)
- [HP PC's—Windows 10 Accessibility Options](#)
- [HP Slate 7 Tablets—Enabling Accessibility Features on Your HP Tablet \(Android 4.1/Jelly Bean\)](#)
- [HP SlateBook PCs—Enabling Accessibility Features \(Android 4.3, 4.2/Jelly Bean\)](#)
- [HP Chromebook PCs—Enabling Accessibility Features on Your HP Chromebook or Chromebox \(Chrome OS\)](#)
- [HP Shopping—peripherals for HP products](#)

If you need additional support with the accessibility features on your HP product, see [Contacting support on page 83](#).

Additional links to external partners and suppliers that may provide additional assistance:

- [Microsoft Accessibility information \(Windows 7, Windows 8, Windows 10, Microsoft Office\)](#)
- [Google Products accessibility information \(Android, Chrome, Google Apps\)](#)

- [Assistive Technologies sorted by impairment type](#)
- [Assistive Technologies sorted by product type](#)
- [Assistive Technology vendors with product descriptions](#)
- [Assistive Technology Industry Association \(ATIA\)](#)

Standards and legislation

Standards

Section 508 of the Federal Acquisition Regulation (FAR) standards was created by the US Access Board to address access to information and communication technology (ICT) for people with physical, sensory, or cognitive disabilities. The standards contain technical criteria specific to various types of technologies, as well as performance-based requirements which focus on functional capabilities of covered products. Specific criteria cover software applications and operating systems, web-based information and applications, computers, telecommunications products, video and multimedia, and self-contained closed products.

Mandate 376 – EN 301 549

The EN 301 549 standard was created by the European Union within Mandate 376 as the basis for an online toolkit for public procurement of ICT products. The standard specifies the functional accessibility requirements applicable to ICT products and services, together with a description of the test procedures and evaluation methodology for each accessibility requirement.

Web Content Accessibility Guidelines (WCAG)

Web Content Accessibility Guidelines (WCAG) from the W3C's Web Accessibility Initiative (WAI) helps web designers and developers create sites that better meet the needs of people with disabilities or age-related limitations. WCAG advances accessibility across the full range of web content (text, images, audio, and video) and web applications. WCAG can be precisely tested, is easy to understand and use, and allows web developers flexibility for innovation. WCAG 2.0 has also been approved as [ISO/IEC 40500:2012](#).

WCAG specifically addresses barriers to accessing the web experienced by people with visual, auditory, physical, cognitive, and neurological disabilities, and by older web users with accessibility needs. WCAG 2.0 provides characteristics of accessible content:

- **Perceivable** (for instance, by addressing text alternatives for images, captions for audio, adaptability of presentation, and color contrast)
- **Operable** (by addressing keyboard access, color contrast, timing of input, seizure avoidance, and navigability)
- **Understandable** (by addressing readability, predictability, and input assistance)
- **Robust** (for instance, by addressing compatibility with assistive technologies)

Legislation and regulations

Accessibility of IT and information has become an area of increasing legislative importance. The links listed below provide information about key legislation, regulations, and standards.

- [United States](#)
- [Canada](#)
- [Europe](#)

- [United Kingdom](#)
- [Australia](#)
- [Worldwide](#)

Useful accessibility resources and links

The following organizations might be good resources for information about disabilities and age-related limitations.



NOTE: This is not an exhaustive list. These organizations are provided for informational purposes only. HP assumes no responsibility for information or contacts you encounter on the Internet. Listing on this page does not imply endorsement by HP.

Organizations

- American Association of People with Disabilities (AAPD)
- The Association of Assistive Technology Act Programs (ATAP)
- Hearing Loss Association of America (HLAA)
- Information Technology Technical Assistance and Training Center (ITTATC)
- Lighthouse International
- National Association of the Deaf
- National Federation of the Blind
- Rehabilitation Engineering & Assistive Technology Society of North America (RESNA)
- Telecommunications for the Deaf and Hard of Hearing, Inc. (TDI)
- W3C Web Accessibility Initiative (WAI)

Educational institutions

- California State University, Northridge, Center on Disabilities (CSUN)
- University of Wisconsin - Madison, Trace Center
- University of Minnesota computer accommodations program

Other disability resources

- ADA (Americans with Disabilities Act) Technical Assistance Program
- ILO Global Business and Disability network
- EnableMart
- European Disability Forum
- Job Accommodation Network
- Microsoft Enable

HP links

[Our contact webform](#)

[HP comfort and safety guide](#)

[HP public sector sales](#)

Contacting support



NOTE: Support is in English only.

- Customers who are deaf or hard of hearing who have questions about technical support or accessibility of HP products:
 - Use TRS/VRS/WebCapTel to call (877) 656-7058 Monday through Friday, 6 a.m. to 9 p.m. Mountain Time.
- Customers with other disabilities or age-related limitations who have questions about technical support or accessibility of HP products, choose one of the following options:
 - Call (888) 259-5707 Monday through Friday, 6 a.m. to 9 p.m. Mountain Time.
 - Complete the [Contact form for people with disabilities or age-related limitations](#).

Index

- A**
 - accessibility 78
 - accessibility needs assessment 79
 - action keys 19
 - identifying 19
 - keyboard backlight 19
 - mute 20
 - next 19
 - pause 19
 - play 19
 - privacy screen 19
 - screen brightness 19
 - speaker volume 19
 - stop 19
 - switch screen image 20
 - touchpad 20
 - using 19
 - wireless 20
 - administrator password 49
 - airplane mode key 24
 - ambient light sensor, identifying 6
 - antivirus software 56
 - assistive technology (AT)
 - finding 79
 - purpose 78
 - AT (assistive technology)
 - finding 79
 - purpose 78
 - audio 35
 - adjusting volume 19
 - headphones 35
 - headsets 36
 - sound settings 36
 - speakers 35
 - audio-out (headphone)/audio-in (microphone) combo jack, identifying 5
 - Automatic DriveLock
 - disabling 52
 - enabling 52
 - Automatic Drivelock 52
 - Automatic DriveLock password
 - entering 53
 - keyboard area 12
 - kickstand 11
 - left side 5
 - rear 9
 - right side 4
 - top 7
- B**
 - backup, creating 63
 - backups 63
 - battery
 - conserving power 45
 - discharging 45
 - factory-sealed 46
 - finding information 45
 - low battery levels 45
 - resolving low battery level 46
 - battery charge 45
 - battery information, finding 45
 - battery light 4
 - battery power 44
 - BIOS
 - determining version 67
 - downloading an update 67
 - updating 67
 - Bluetooth device 24, 26
 - Bluetooth label 22
 - boot order
 - changing using the f9 prompt 68
 - boot order, changing 64
 - bottom 22
 - buttons
 - left touchpad 16
 - power 7
 - right touchpad 16
 - volume 5
- C**
 - call answer light 17
 - call end light 17
 - camera 6, 9
 - identifying 6
 - using 35
 - camera light, identifying 6
 - camera privacy cover, identifying 7
 - caps lock light, identifying 17
 - caring for your computer 60
 - cleaning your computer 60
 - components
 - bottom 9
 - display 6
- D**
 - data transfer 40
 - Disk Cleanup software 59
 - Disk Defragmenter software 59
 - display components 6
 - DriveLock
 - description 53
 - disabling 55
 - enabling 54
 - DriveLock master password
 - changing 55
 - DriveLock password
 - changing 55
 - entering 55
 - setting 53
- E**
 - electrostatic discharge 77
 - embedded numeric keypad, identifying 18
 - esc key, identifying 18
 - external power, using 46
- F**
 - factory-sealed battery 46
 - fingerprint reader 57
 - fingerprint reader, identifying 10

- fingerprints, registering 56
- firewall software 56
- fn key, identifying 18
- fn lock light, identifying 17
- four-finger tap touchpad gesture 32

G
GPS 26

H
hardware, locating 3
headphones, connecting 35
headsets, connecting 36
Hibernation

- exiting 43
- initiated during critical battery level 45
- initiating 43

high-definition devices, connecting 40
hot keys

- break 21
- insert 21
- microphone mute 19
- pause 21
- programming query 21
- scroll lock 21
- using 21

HP 3D DriveGuard 60
HP Assistive Policy 78
HP Client Security 57
HP Device as a Service (HP DaaS) 57
HP Fast Charge 44
HP LAN-Wireless Protection 28
HP MAC Address Pass Through 29
HP PC Hardware Diagnostics UEFI

- downloading 72
- starting 72
- using 71

HP PC Hardware Diagnostics Windows

- downloading 70
- installing 71
- using 70

HP Recovery media

- recovery 64

HP resources 2
HP Sure Recover 65
HP Touchpoint Manager 57

I
initiating Sleep and Hibernation 42
input power 75
internal microphones, identifying 7
International Association of Accessibility Professionals 78

J
jacks

- audio-out (headphone)/audio-in (microphone) combo 5

K
keyboard

- connecting 12
- removing 13

keyboard and optional mouse

- using 34

keyboard backlight

- action key 19

keyboard connector, identifying 9
keypad

- embedded numeric 18

keys

- action 19
- esc 18
- fn 18
- num lock 18
- touchpad 20
- Windows 18

kickstand, identifying 10

L
labels

- Bluetooth 22
- regulatory 22
- serial number 21
- service 21
- wireless certification 22
- WLAN 22

leather folio keyboard

- adjusting 15
- connecting 14
- removing 15

left side components 5
lights

- AC adapter and battery 4
- battery 4
- call answer 17
- call end 17
- camera 6

- caps lock 17
- fn lock 17
- microphone mute 17
- num lock 17
- power 8
- sharing or presenting 17
- wireless 17

low battery level 45

M
magnetic pen attachment area, identifying 6
maintenance

- Disk Cleanup 59
- Disk Defragmenter 59
- updating programs and drivers 60

managing power 42
microphone mute key, identifying 19
microphone mute light, identifying 17
Miracast 40
Modern Standby mode 42
mute volume action key 20

N
nano security cable slot, identifying 5
nano SIM card, inserting 22
next track action key 19
NFC 26
num lock light 17

O
one-finger slide touch screen

- gesture 34

operating environment 76

P
passwords

- administrator 49
- BIOS administrator 50
- user 49

pause action key 19
play action key 19
ports

- USB Type-C 41
- USB Type-C DisplayPort 4
- USB Type-C power connector 4

- USB Type-C power connector and Thunderbolt port with HP Sleep and Charge 4
- USB Type-C SuperSpeed 4
- USB Type-C SuperSpeed port and DisplayPort 37
- USB Type-C Thunderbolt 38
- power
 - battery 44
 - external 46
- power button, identifying 7
- power connector
 - identifying 4
 - identifying USB Type-C 4
- power icon, using 44
- power lights 8
- power settings, using 44
- precision touchpad
 - using 30
- precision touchpad gestures
 - four-finger tap 32
 - three-finger swipe 33
 - three-finger tap 32
 - two-finger slide 31
 - two-finger tap 31
- privacy screen action key, identifying 19
- product name and number, computer 21
- public WLAN connection 25
- R**
- rear camera
 - identifying 9
- rear internal microphone, identifying 9
- recovery 63
 - discs 64
 - HP Recovery partition 64
 - media 64
 - USB flash drive 64
- recovery media
 - creating using HP Cloud Recovery Download Tool 63
 - creating using Windows tools 63
- regulatory information
 - regulatory label 22
 - wireless certification labels 22
- Remote HP PC Hardware Diagnostics
 - UEFI settings
 - customizing 73
 - using 73
- resources, accessibility 82
- restoring 63
- right side components 4
- S**
- screen brightness action keys 19
- Section 508 accessibility standards 80
- serial number, computer 21
- service labels, locating 21
- setup utility
 - navigating and selecting 66
 - restoring factory settings 66
- sharing or presenting light, identifying 17
- shipping the computer 61
- shutdown 43
- SIM card slot, identifying 4
- Sleep
 - exiting 42
 - initiating 42
- Sleep and Hibernation, initiating 42
- slots
 - nano security cable 5
 - SIM card 4
- software
 - antivirus 56
 - Disk Cleanup 59
 - Disk Defragmenter 59
 - firewall 56
- software installed, locating 3
- software updates, installing 57
- sound. *See* audio
- sound settings, using 36
- speaker volume action keys 19
- speakers
 - connecting 35
- speakers, identifying 6
- special keys, using 18
- standards and legislation, accessibility 80
- stop action key 19
- SuperSpeed port and DisplayPort connector, connecting USB Type-C 37
- Sure Start
 - using 69
- switch screen image action key 20
- system restore point, creating 63
- T**
- tap touchpad and touch screen gesture 30
- three-finger swipe touchpad gesture 33
- three-finger tap touchpad gesture 32
- Thunderbolt port with HP Sleep and Charge
 - identifying USB Type-C 4
- Thunderbolt, connecting USB Type-C 38
- touch screen gestures
 - one-finger slide 34
- touchpad
 - settings 16
 - using 30
- touchpad and touch screen gestures
 - tap 30
 - two-finger pinch zoom 31
- touchpad buttons
 - identifying 16
- touchpad gestures
 - four-finger tap 32
 - three-finger swipe 33
 - three-finger tap 32
 - two-finger slide 31
 - two-finger tap 31
- touchpad key 20
- touchpad zone, identifying 16
- TPM settings 68
- transfer data 40
- traveling with the computer 22, 61
- turning off the computer 43
- two-finger pinch zoom touchpad and touch screen gesture 31
- two-finger slide touchpad gesture 31
- two-finger tap touchpad gesture 31
- U**
- unresponsive system 43
- updating programs and drivers 60
- USB Type-C port, connecting 37, 38, 41

- USB Type-C power connector and Thunderbolt port with HP Sleep and Charge, identifying 4
- USB Type-C power connector port, identifying 4
- USB Type-C SuperSpeed port, identifying 4
- user password 49
- using the keyboard and optional mouse 34
- using the touchpad 30

V

- vents, identifying 7
- video 36
 - DisplayPort device 37
 - Thunderbolt Port device 38
 - USB Type-C 37, 38
 - wireless displays 40
- volume
 - adjusting 19
 - mute 20
- volume buttons, identifying 5

W

- Windows
 - backup 63
 - recovery media 63
 - system restore point 63
- Windows Hello
 - using 56
- Windows key, identifying 18
- Windows tools, using 63
- wireless action key 20
- wireless antennas, identifying 6
- wireless button 24
- wireless certification label 22
- wireless controls
 - button 24
 - operating system 24
- wireless key 24
- wireless light 24
- wireless light, identifying 17
- wireless network (WLAN)
 - connecting 25
 - corporate WLAN connection 25
 - functional range 25
 - public WLAN connection 25
- WLAN antennas, identifying 6
- WLAN device 22

- WLAN label 22
- WWAN antennas, identifying 6
- WWAN device 24, 25