



# Maintenance and Service Guide

HP ProDesk 600 G5 Desktop Mini

© Copyright 2018, 2019 HP Development Company, L.P.

AMD is a trademark of Advanced Micro Devices, Inc. Bluetooth is a trademark owned by its proprietor and used by HP Inc. under license. Intel, Celeron, and Pentium are trademarks of Intel Corporation in the U.S. and other countries. Microsoft and Windows are trademarks of the Microsoft group of companies.

The information contained herein is subject to change without notice. The only warranties for HP products and services are set forth in the express warranty statements accompanying such products and services. Nothing herein should be construed as constituting an additional warranty. HP shall not be liable for technical or editorial errors or omissions contained herein.

Second Edition: September 2019

First Edition: May 2018

Document Part Number: L21500-002

### **Product notice**

This user guide describes features that are common to most models. Some features may not be available on your computer.

Not all features are available in all editions of Windows. This computer may require upgraded and/or separately purchased hardware, drivers and/or software to take full advantage of Windows functionality. Go to <http://www.microsoft.com> for details.

### **Software terms**

By installing, copying, downloading, or otherwise using any software product preinstalled on this computer, you agree to be bound by the terms of the HP End User License Agreement (EULA). If you do not accept these license terms, your sole remedy is to return the entire unused product (hardware and software) within 14 days for a full refund subject to the refund policy of your seller.

For any further information or to request a full refund of the price of the computer, please contact your seller.

## Safety warning notice

---

 **WARNING!** To reduce the possibility of heat-related injuries or of overheating the device, do not place the device directly on your lap or obstruct the device air vents. Use the device only on a hard, flat surface. Do not allow another hard surface, such as an adjoining optional printer, or a soft surface, such as pillows or rugs or clothing, to block airflow. Also, do not allow the AC adapter to contact the skin or a soft surface, such as pillows or rugs or clothing, during operation. The device and the AC adapter comply with the user-accessible surface temperature limits defined by the International Standard for Safety of Information Technology Equipment (IEC 60950-1).

---



---

# Table of contents

<b>1 Product features</b>	<b>1</b>
Standard configuration features	1
Front panel components	1
Rear panel components	2
Serial number location	2
<b>2 Illustrated parts catalog</b>	<b>3</b>
Computer major components	3
Miscellaneous parts	5
<b>3 Routine care, SATA drive guidelines, and disassembly preparation</b>	<b>7</b>
Electrostatic discharge information	7
Generating static	7
Preventing electrostatic damage to equipment	8
Personal grounding methods and equipment	8
Grounding the work area	8
Recommended materials and equipment	9
Operating guidelines	9
Routine care	10
General cleaning safety precautions	10
Cleaning the computer case	10
Cleaning the keyboard	10
Cleaning the monitor	11
Cleaning the mouse	11
Service considerations	11
Tools and software requirements	11
Screws	11
Hard Drives	12
Lithium coin cell battery	12
SATA hard drives	12
<b>4 Removal and replacement procedures</b>	<b>13</b>
Warnings and cautions	13
Preparation for disassembly	14
Front bezel dust filter	14
Access panel	15

Front bezel .....	16
Hood sensor .....	17
Speaker .....	18
Hard drive .....	19
Hard drive connector .....	20
Drive cage .....	21
M.2 PCIe solid state drive (SSD) .....	22
WLAN module .....	23
Battery .....	24
Expansion connector board .....	26
Memory modules .....	27
Memory module specifications .....	27
Removing memory modules .....	27
Fan .....	30
Heat sink .....	31
Processor .....	33
System board .....	34
System board components .....	37
Internal WLAN antenna cables .....	38
Changing from desktop to tower configuration .....	40
<b>5 Computer Setup (F10) Utility .....</b>	<b>41</b>
Computer Setup (F10) Utilities .....	41
Using Computer Setup (F10) Utilities .....	41
Computer Setup—Main .....	43
Computer Setup—Security .....	45
Computer Setup—Advanced .....	48
Computer Setup—UEFI Drivers .....	52
Recovering the Configuration Settings .....	52
<b>6 Troubleshooting without diagnostics .....</b>	<b>53</b>
Safety and comfort .....	53
Before you call for technical support .....	53
Helpful hints .....	54
Solving general problems .....	55
Solving power problems .....	58
Solving hard drive problems .....	59
Solving media card reader problems .....	61
Solving display problems .....	62
Solving audio problems .....	66
Solving printer problems .....	67

Solving keyboard and mouse problems .....	68
Solving hardware installation problems .....	70
Solving network problems .....	71
Solving memory problems .....	73
Solving USB flash drive problems .....	75
Solving Internet access problems .....	75
Solving software problems .....	76
<b>7 POST error messages and diagnostic front panel LEDs and audible codes .....</b>	<b>78</b>
POST numeric codes and text messages .....	78
Interpreting system validation diagnostic front panel LEDs and audible codes .....	83
<b>8 Password security and resetting CMOS .....</b>	<b>85</b>
Resetting the password jumper .....	85
Clearing and resetting the BIOS .....	87
<b>9 Using HP PC Hardware Diagnostics .....</b>	<b>88</b>
Using HP PC Hardware Diagnostics Windows .....	88
Downloading HP PC Hardware Diagnostics Windows .....	88
Downloading the latest HP PC Hardware Diagnostics Windows version .....	89
Downloading HP Hardware Diagnostics Windows by product name or number (select products only) .....	89
Installing HP PC Hardware Diagnostics Windows .....	89
Using HP PC Hardware Diagnostics UEFI .....	89
Starting HP PC Hardware Diagnostics UEFI .....	90
Downloading HP PC Hardware Diagnostics UEFI to a USB flash drive .....	90
Downloading the latest HP PC Hardware Diagnostics UEFI version .....	90
Downloading HP PC Hardware Diagnostics UEFI by product name or number (select products only) .....	90
Using Remote HP PC Hardware Diagnostics UEFI settings (select products only) .....	91
Downloading Remote HP PC Hardware Diagnostics UEFI .....	91
Downloading the latest Remote HP PC Hardware Diagnostics UEFI version .....	91
Downloading Remote HP PC Hardware Diagnostics UEFI by product name or number .....	91
Customizing Remote HP PC Hardware Diagnostics UEFI settings .....	91
<b>Appendix A Power Cord Set Requirements .....</b>	<b>93</b>
General Requirements .....	93
Japanese Power Cord Requirements .....	93
Country-Specific Requirements .....	94

<b>Appendix B Statement of memory volatility .....</b>	<b>95</b>
Nonvolatile memory usage .....	97
Questions and answers .....	99
Using HP Sure Start (select models only) .....	100
 <b>Appendix C Specifications .....</b>	 <b>101</b>
 <b>Index .....</b>	 <b>102</b>



# 1 Product features

## Standard configuration features





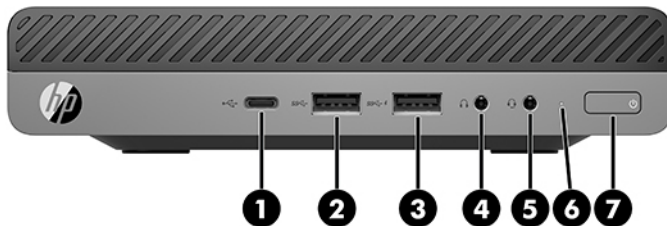

Features may vary depending on the model. For a complete listing of the hardware and software installed in the computer, run the diagnostic utility (included on some computer models only).

 **NOTE:** This computer model can be used in a tower orientation or a desktop orientation. The tower stand is sold separately.

## Front panel components



 **NOTE:** Your computer model may look slightly different from the illustration in this section.

Item	Icon	Component	Item	Icon	Component
1		USB 3.1 Gen 2 Type-C port	5		Audio-out (headphone)/Audio-in (microphone) combo jack
2		USB 3.1 Gen 2 port*	6		Main storage LED
3		USB 3.1 Gen 1 charging port*	7		Dual-state power button
4		Headphone jack			

\*When the computer is on, the USB port connects a USB device, provides high-speed data transfer, and even when the computer is off, charges products such as a cell phone, camera, activity tracker, or smartwatch.

**NOTE:** The main storage LED is normally white when the power is on. If it is flashing red, there is a problem with the computer and the main storage LED is displaying a diagnostic code. Refer to [Interpreting system validation diagnostic front panel LEDs and audible codes on page 83](#) to interpret the code.

## Rear panel components

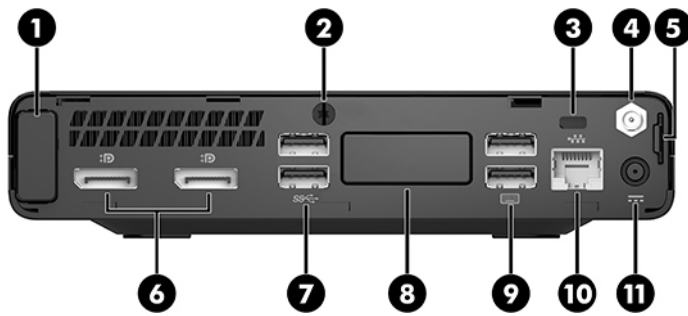

**NOTE:** Your computer model may look slightly different from the illustration in this section.

Item	Icon	Component	Item	Icon	Component
1		Antenna cover	7		USB 3.1 Gen 2 ports (2)
2		Thumbscrew	8		Optional port One of the following ports may be used: DisplayPort, HDMI, VGA, USB Type-C, or serial port
3		Security cable slot	9		USB 3.1 Gen 1 ports (2)
4		External antenna connector (optional)	10		RJ-45 (network) jack/status lights
5		Padlock loop	11		Power connector
6		Dual-Mode DisplayPort (2)			

## Serial number location

Each computer has a unique serial number and a product ID number that are located on the exterior of the computer. Keep these numbers available for use when contacting support for assistance.

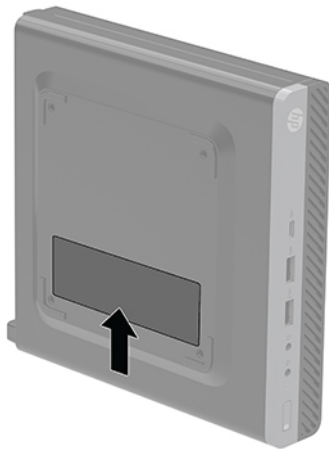

## 2 Illustrated parts catalog

 **NOTE:** HP continually improves and changes product parts. For complete and current information on supported parts for your computer, go to <http://partsurfer.hp.com>, select your country or region, and then follow the on-screen instructions.

### Computer major components

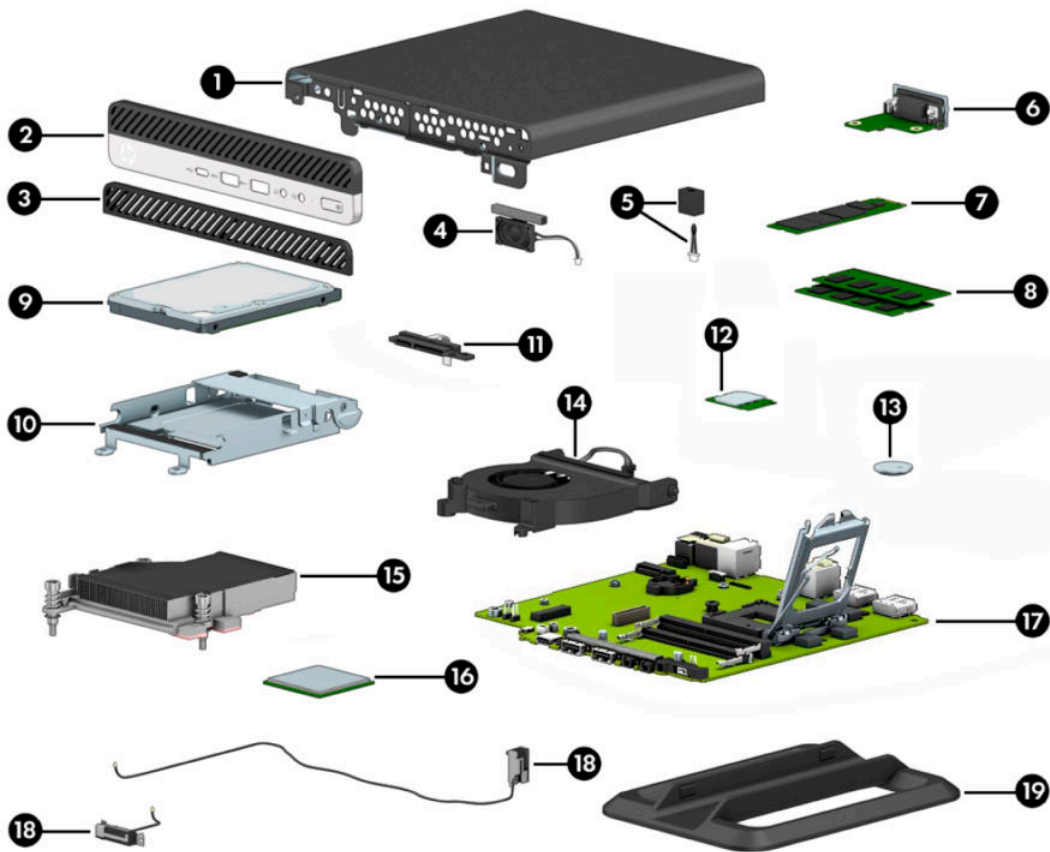

Item	Description
(1)	Access panel
(2)	Front bezel
(3)	Front bezel dust filter (for use only in 35 W models)
(4)	Speaker
(5)	Hood sensor
(6)	Option boards:
	HDMI option board
	DisplayPort option board

<b>Item</b>	<b>Description</b>
	VGA option board
	Serial port option board
	USB Type-C option board
<b>(7)</b>	<b>Solid-state drives, NVMe, M.2 2280, PCIe</b>
	1 TB, TLC
	512-GB, TLC
	512-GB
	256-GB, TLC
	128-GB, TLC
	128-GB
	<b>Optane memory module (16 GB)</b>
<b>(8)</b>	<b>Memory module (SODIMM, DDR4-2400)</b>
	16-GB
	8-GB
	4-GB
<b>(9)</b>	<b>Hard drives</b>
	1-TB, 7200-rpm, 9.5 mm
	1-TB, 5400-rpm, hybrid SSD, 9.5 mm
	500 GB, 7200 rpm, 7 mm
	500 GB, 7200 rpm, OPAL2, self-encrypting drive (SED), 7 mm
	500-GB, 5400-rpm, FIPS, 7 mm
	500-GB, 5400-rpm, hybrid SSD, 7 mm
	<b>Solid-state drives, 2.5-inch, SATA-3, TLC</b>
	512-GB, FIPS-140-2
	512-GB, OPAL 2, self-encrypting drive (SED)
	512-GB
	256-GB, FIPS-140-2
	256-GB, OPAL 2, self-encrypting drive (SED)
	256-GB
<b>(10)</b>	<b>Hard drive cage</b>
<b>(11)</b>	<b>Hard drive cable</b>
<b>(12)</b>	<b>WLAN modules</b>
	Intel 9560 802.11ac 2x2 with Bluetooth M.2 Combo Card vPro
	Intel 9560 802.11ac 2x2 with Bluetooth M.2 Combo Card non-vPro

Item	Description
	Realtek RTL8822BE 802.11ac 2x2 with Bluetooth M.2 Combo Card
	Realtek RTL8821CE 802.11ac 1x1 with Bluetooth M.2 Combo Card
<b>(13)</b>	<b>RTC battery</b>
<b>(14)</b>	<b>Fan</b>
<b>(15)</b>	<b>Heat sink (includes replacement thermal material)</b>
<b>(16)</b>	<b>Processor</b> (include replacement thermal material)
	Intel i7-8700T processor
	Intel i5-8600T processor
	Intel i3-8100T processor
	Intel Pentium G5400T processor
	Intel Celeron G4900T processor
<b>(17)</b>	<b>System board</b> (includes replacement thermal material)
<b>(18)</b>	<b>Antenna cable, wireless</b>
<b>(19)</b>	<b>Stand</b>

## Miscellaneous parts

Description
<b>AC adapter</b>
65 W, nPFC
<b>Sleeve Kits</b>
I/O sleeve
Hard drive sleeve
Optical drive sleeve
VESA sleeve
HP speaker phone security sleeve
<b>Quick release</b>
<b>EPS bracket</b>
<b>PC mounting bracket, B300</b>
<b>Antenna cover</b>
<b>Port cover</b>
<b>HP USB-Type C to USB Type-A Hub</b>
<b>DisplayPort cable</b>
<b>DVI monitor cable</b>

<b>Description</b>
<b>Adapters</b>
USB Type-C to USB 3.0
DisplayPort to VGA
DisplayPort to HDMI 2.0
DisplayPort to DVI
USB to serial port
<b>Keyboard</b>
Washable, PVC, USB/PS2
USB
USB, Essential
Conferencing, USB
USB, slim
Wireless keyboard and mouse
Slim, PCR, USB (Brazil and Latin America)
Smart card, slim, CCID, USB
Anti-microbial, slim
Grey, slim, USB
Collaboration, USB
Collaboration, wireless
Wireless, premium
Health care, wired, USB
Premium, wireless, keyboard and mouse
<b>Mouse</b>
USB, optical
USB, laser
USB
USB, premium
USB, antimicrobial
USB/PS2, washable
USB, hardened
USB, health care, wired
<b>Power cord</b>

# 3 Routine care, SATA drive guidelines, and disassembly preparation

This chapter provides general service information for the computer. Adherence to the procedures and precautions described in this chapter is essential for proper service.

**CAUTION:** When the computer is plugged into an AC power source, voltage is always applied to the system board. You must disconnect the power cord from the power source before opening the computer to prevent system board or component damage.

## Electrostatic discharge information

A sudden discharge of static electricity from your finger or other conductor can destroy static-sensitive devices or microcircuitry. Often the spark is neither felt nor heard, but damage occurs. An electronic device exposed to electrostatic discharge (ESD) may not appear to be affected at all and can work perfectly throughout a normal cycle. The device may function normally for a while, but it has been degraded in the internal layers, reducing its life expectancy.

Networks built into many integrated circuits provide some protection, but in many cases, the discharge contains enough power to alter device parameters or melt silicon junctions.

## Generating static

The following table shows that:

- Different activities generate different amounts of static electricity.
- Static electricity increases as humidity decreases.

Event	Relative Humidity		
	55%	40%	10%
Walking across carpet	7,500 V	15,000 V	35,000 V
Walking across vinyl floor	3,000 V	5,000 V	12,000 V
Motions of bench worker	400 V	800 V	6,000 V
Removing DIPs from plastic tube	400 V	700 V	2,000 V
Removing DIPs from vinyl tray	2,000 V	4,000 V	11,500 V
Removing DIPs from Styrofoam	3,500 V	5,000 V	14,500 V
Removing bubble pack from PCB	7,000 V	20,000 V	26,500 V
Packing PCBs in foam-lined box	5,000 V	11,000 V	21,000 V

These are then multi-packaged inside plastic tubes, trays, or Styrofoam.

**NOTE:** 700 volts can degrade a product.

## Preventing electrostatic damage to equipment

Many electronic components are sensitive to ESD. Circuitry design and structure determine the degree of sensitivity. The following packaging and grounding precautions are necessary to prevent damage to electric components and accessories.

- To avoid hand contact, transport products in static-safe containers such as tubes, bags, or boxes.
- Protect all electrostatic parts and assemblies with conductive or approved containers or packaging.
- Keep electrostatic sensitive parts in their containers until they arrive at static-free stations.
- Place items on a grounded surface before removing them from their container.
- Always be properly grounded when touching a sensitive component or assembly.
- Avoid contact with pins, leads, or circuitry.
- Place reusable electrostatic-sensitive parts from assemblies in protective packaging or conductive foam.

## Personal grounding methods and equipment

Use the following equipment to prevent static electricity damage to equipment:

- **Wrist straps** are flexible straps with a maximum of one-megohm  $\pm$  10% resistance in the ground cords. To provide proper ground, a strap must be worn snug against bare skin. The ground cord must be connected and fit snugly into the banana plug connector on the grounding mat or workstation.
- **Heel straps/Toe straps/Boot straps** can be used at standing workstations and are compatible with most types of shoes or boots. On conductive floors or dissipative floor mats, use them on both feet with a maximum of one-megohm  $\pm$  10% resistance between the operator and ground.

Static Shielding Protection Levels	
Method	Voltage
Antistatic plastic	1,500
Carbon-loaded plastic	7,500
Metallized laminate	15,000

## Grounding the work area

To prevent static damage at the work area, use the following precautions:

- Cover the work surface with approved static-dissipative material. Provide a wrist strap connected to the work surface and properly grounded tools and equipment.
- Use static-dissipative mats, foot straps, or air ionizers to give added protection.
- Handle electrostatic sensitive components, parts, and assemblies by the case or PCB laminate. Handle them only at static-free work areas.
- Turn off power and input signals before inserting and removing connectors or test equipment.
- Use fixtures made of static-safe materials when fixtures must directly contact dissipative surfaces.
- Keep work area free of nonconductive materials such as ordinary plastic assembly aids and Styrofoam.
- Use field service tools, such as cutters, screwdrivers, and vacuums, that are conductive.



## Recommended materials and equipment

Materials and equipment that are recommended for use in preventing static electricity include:

- Antistatic tape
- Antistatic smocks, aprons, or sleeve protectors
- Conductive bins and other assembly or soldering aids
- Conductive foam
- Conductive tabletop workstations with ground cord of one-megohm +/- 10% resistance
- Static-dissipative table or floor mats with hard tie to ground
- Field service kits
- Static awareness labels
- Wrist straps and footwear straps providing one-megohm +/- 10% resistance
- Material handling packages
- Conductive plastic bags
- Conductive plastic tubes
- Conductive tote boxes
- Opaque shielding bags
- Transparent metallized shielding bags
- Transparent shielding tubes

## Operating guidelines

To prevent overheating and to help prolong the life of the computer:

- Keep the computer away from excessive moisture, direct sunlight, and extremes of heat and cold.
- Operate the computer on a sturdy, level surface. Leave a 10.2-cm (4-inch) clearance on all vented sides of the computer and above the monitor to permit the required airflow.
- Never restrict the airflow into the computer by blocking any vents or air intakes. Do not place the keyboard, with the keyboard feet down, directly against the front of the desktop unit as this also restricts airflow.
- Occasionally clean the air vents on all vented sides of the computer. Lint, dust, and other foreign matter can block the vents and limit the airflow. Be sure to unplug the computer before cleaning the air vents.
- Never operate the computer with the cover or side panel removed.
- Do not stack computers on top of each other or place computers so near each other that they are subject to each other's re-circulated or preheated air.
- If the computer is to be operated within a separate enclosure, intake and exhaust ventilation must be provided on the enclosure, and the same operating guidelines listed above will still apply.
- Keep liquids away from the computer and keyboard.

- Never cover the ventilation slots on the monitor with any type of material.
- Install or enable power management functions of the operating system or other software, including sleep states.

## Routine care

### General cleaning safety precautions

1. Never use solvents or flammable solutions to clean the computer.
2. Never immerse any parts in water or cleaning solutions; apply any liquids to a clean cloth and then use the cloth on the component.
3. Always unplug the computer when cleaning with liquids or damp cloths.
4. Always unplug the computer before cleaning the keyboard, mouse, or air vents.
5. Disconnect the keyboard before cleaning it.
6. Wear safety glasses equipped with side shields when cleaning the keyboard.

### Cleaning the computer case

Follow all safety precautions in [General cleaning safety precautions on page 10](#) before cleaning the computer.

To clean the computer case, follow the procedures described below:

- To remove light stains or dirt, use plain water with a clean, lint-free cloth or swab.
- For stronger stains, use a mild dishwashing liquid diluted with water. Rinse well by wiping it with a cloth or swab dampened with clear water.
- For stubborn stains, use isopropyl (rubbing) alcohol. No rinsing is needed as the alcohol will evaporate quickly and not leave a residue.
- After cleaning, always wipe the unit with a clean, lint-free cloth.
- Occasionally clean the air vents on the computer. Lint and other foreign matter can block the vents and limit the airflow.

### Cleaning the keyboard

Follow all safety precautions in [General cleaning safety precautions on page 10](#) before cleaning the keyboard.

To clean the tops of the keys or the keyboard body, follow the procedures described in [Cleaning the computer case on page 10](#).

When cleaning debris from under the keys, review all rules in [General cleaning safety precautions on page 10](#) before following these procedures:

---

 **CAUTION:** Use safety glasses equipped with side shields before attempting to clean debris from under the keys.

---

- Visible debris underneath or between the keys may be removed by vacuuming or shaking.
- Canned, pressurized air may be used to clean debris from under the keys. Caution should be used as too much air pressure can dislodge lubricants applied under the wide keys.

- If you remove a key, use a specially designed key puller to prevent damage to the keys. This tool is available through many electronic supply outlets.

---

**⚠ CAUTION:** Never remove a wide leveled key (like the space bar) from the keyboard. If these keys are improperly removed or installed, the keyboard may not function properly.

---

- Cleaning under a key may be done with a swab moistened with isopropyl alcohol and squeezed out. Be careful not to wipe away lubricants necessary for proper key functions. Use tweezers to remove any fibers or dirt in confined areas. Allow the parts to air dry before reassembly.

## Cleaning the monitor

- Wipe the monitor screen with a clean cloth moistened with water or with a towelette designed for cleaning monitors. Do not use sprays or aerosols directly on the screen; the liquid may seep into the housing and damage a component. Never use solvents or flammable liquids on the monitor.
- To clean the monitor body follow the procedures in [Cleaning the computer case on page 10](#).

## Cleaning the mouse

Before cleaning the mouse, ensure that the power to the computer is turned off.

- Clean the mouse ball by first removing the retaining plate and the ball from the housing. Pull out any debris from the ball socket and wipe the ball with a clean, dry cloth before reassembly.
- To clean the mouse body, follow the procedures in [Cleaning the computer case on page 10](#).

## Service considerations

Listed below are some of the considerations that you should keep in mind during the disassembly and assembly of the computer.

## Tools and software requirements

To service the computer, you need the following:

- Torx T-15 screwdriver
- Flat-bladed screwdriver (may sometimes be used in place of the Torx screwdriver; not required)
- Phillips #1 screwdriver
- Diagnostics software

## Screws

The screws used in the computer are not interchangeable. They may have standard or metric threads and may be of different lengths. If an incorrect screw is used during the reassembly process, it can damage the unit. HP strongly recommends that all screws removed during disassembly be kept with the part that was removed, then returned to their proper locations.

---

**⚠ CAUTION:** Metric screws have a black finish. U.S. screws have a silver finish and are used on hard drives only.

**CAUTION:** As each subassembly is removed from the computer, it should be placed away from the work area to prevent damage.

---

## Hard Drives

Handle hard drives as delicate, precision components, avoiding all physical shock and vibration. This applies to failed drives as well as replacement spares.

- If a drive must be mailed, place the drive in a bubble-pack mailer or other suitable protective packaging and label the package “Fragile: Handle With Care.”
- Do not remove hard drives from the shipping package for storage. Keep hard drives in their protective packaging until they are actually mounted in the computer.
- Avoid dropping drives from any height onto any surface.
- If you are inserting or removing a hard drive, turn off the computer. Do not remove a hard drive while the computer is on or in standby mode.
- Before handling a drive, ensure that you are discharged of static electricity. While handling a drive, avoid touching the connector.
- Do not use excessive force when inserting a drive.
- Avoid exposing a hard drive to liquids, temperature extremes, or products that have magnetic fields such as monitors or speakers.

## Lithium coin cell battery

The battery that comes with the computer provides power to the real-time clock and has a minimum lifetime of about three years.

See the appropriate removal and replacement chapter for the chassis you are working on in this guide for instructions on the replacement procedures.

 **WARNING!** This computer contains a lithium battery. There is a risk of fire and chemical burn if the battery is handled improperly. Do not disassemble, crush, puncture, short external contacts, dispose in water or fire, or expose it to temperatures higher than 140°F (60°C). Do not attempt to recharge the battery.

 **NOTE:** Batteries, battery packs, and accumulators should not be disposed of together with the general household waste. In order to forward them to recycling or proper disposal, please use the public collection system or return them to HP, their authorized partners, or their agents.

## SATA hard drives

Serial ATA Hard Drive Characteristics	
Number of pins/conductors in data cable	7/7
Number of pins in power cable	15
Maximum data cable length	39.37 in (100 cm)
Data interface voltage differential	400-700 mV
Drive voltages	3.3 V, 5 V
Jumpers for configuring drive	N/A
Data transfer rate	6.0 Gb/s

---

## 4 Removal and replacement procedures

Adherence to the procedures and precautions described in this chapter is essential for proper service. After completing all necessary removal and replacement procedures, run the Diagnostics utility to verify that all components operate properly.

---

 **NOTE:** Not all features listed in this guide are available on all computers.

 **NOTE:** HP continually improves and changes product parts. For complete and current information on supported parts for your computer, go to <http://partsurfer.hp.com>, select your country or region, and then follow the on-screen instructions.

---

### Warnings and cautions

Before performing upgrades be sure to carefully read all of the applicable instructions, cautions, and warnings in this guide.

---

 **WARNING!** To reduce the risk of personal injury from electrical shock, hot surfaces, or fire:

Disconnect the power cord from the AC outlet and allow the internal system components to cool before you touch them.

Do not plug telecommunications or telephone connectors into the network interface controller (NIC) receptacles.

Do not disable the power cord grounding plug. The grounding plug is an important safety feature.

Plug the power cord into a grounded (earthed) AC outlet that is easily accessible at all times.

To reduce the risk of serious injury, read the *Safety & Comfort Guide*. The *Safety & Comfort Guide* also provides important electrical and mechanical safety information. The *Safety & Comfort Guide* is available on the web at <http://www.hp.com/ergo>.

 **WARNING!** Energized and moving parts inside.

Disconnect power to the equipment before removing the enclosure.

Replace and secure the enclosure before re-energizing the equipment.

 **IMPORTANT:** Static electricity can damage the electrical components of the computer or optional equipment. Before beginning these procedures, ensure that you are discharged of static electricity by briefly touching a grounded metal object. See [Electrostatic discharge information on page 7](#) for more information.

When the computer is plugged into an AC power source, voltage is always applied to the system board. To prevent damage to internal components, you must disconnect the power cord from the power source before opening the computer.

 **NOTE:** Your computer model may look slightly different from the illustrations in this chapter.

---

## Preparation for disassembly

See [Routine care, SATA drive guidelines, and disassembly preparation on page 7](#) for initial safety procedures.

1. Remove/disengage any security devices that prohibit opening the computer.
2. Remove all removable media, such as a USB flash drive, from the computer.
3. Turn off the computer properly through the operating system, then turn off any external devices.
4. Disconnect the power cord from the AC outlet and disconnect any external devices.

 **IMPORTANT:** Regardless of the power-on state, voltage is always present on the system board as long as the system is plugged into an active AC outlet. To prevent damage to internal components, you must disconnect the power cord from the power source before opening the computer.

5. If the computer is on a stand, remove the computer from the stand.

 **WARNING!** Beware of sharp edges inside the chassis.

## Front bezel dust filter

Some models are equipped with an optional front bezel dust filter. You must periodically clean the dust filter so that the dust collected on the filter does not impede air flow through the computer.

To remove, clean, and replace the dust filter:

1. Prepare the computer for disassembly ([Preparation for disassembly on page 14](#)).
2. To remove the dust filter, use your fingers to separate the filter from the front bezel at the tab locations shown below.

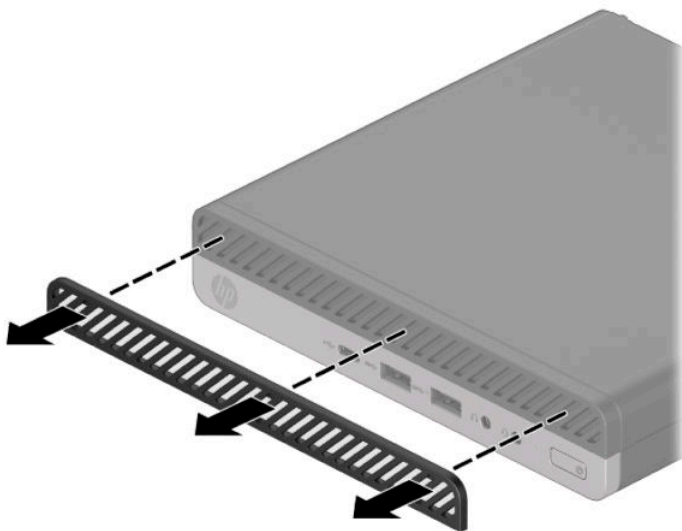

3. Use a soft brush or cloth to clean dust from the filter. If heavily soiled, rinse the filter clean with water.

To install the front bezel dust filter, reverse the removal procedure.

## Access panel

To access internal components, you must remove the access panel:

1. Prepare the computer for disassembly ([Preparation for disassembly on page 14](#)).
2. Loosen the thumbscrew on the rear of the computer **(1)**, and then slide the panel forward and lift it off the computer **(2)**.

---

 **NOTE:** If necessary, a Torx T15 or flat-bladed screwdriver can be used to loosen the thumbscrew.

---

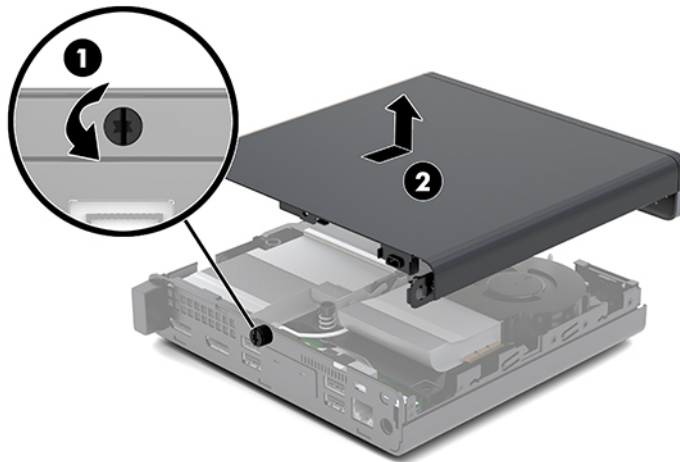

---

 **NOTE:** Your computer model may look slightly different from the illustration in this section. Some models have vent holes on the access panel.

---

## Front bezel

 **NOTE:** It is not necessary to remove the front bezel to access other components.

The front bezel is secured to the top cover by tabs.

1. Prepare the computer for disassembly ([Preparation for disassembly on page 14](#)).
2. Remove the access panel ([Access panel on page 15](#)).
3. Position the top cover upside-down so you can access the inside of the bezel.
4. Remove the two Phillips screws **(1)** that secure the bezel to the access panel.
5. Simultaneously press the two top tabs (not the four bottom tabs) to disengage the bezel **(2)**.
6. Rotate the top of the bezel downward **(3)**, and then remove it from the access panel **(4)**.

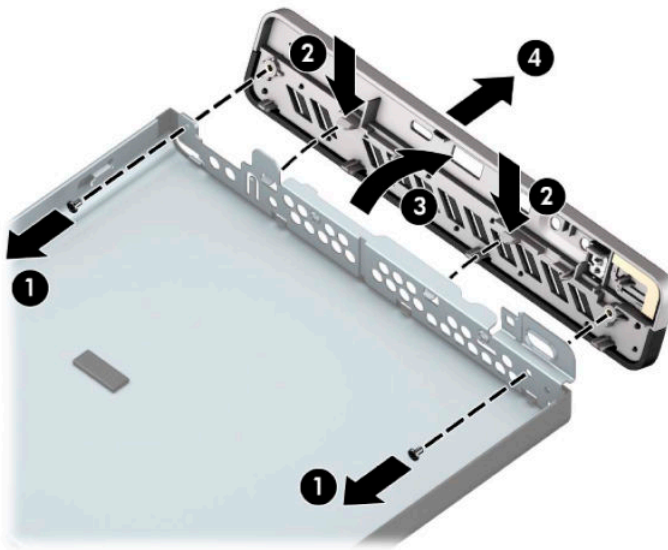

To install the front bezel, reverse the removal procedure.



## Hood sensor

The hood sensor is located near the front of the computer.

1. Prepare the computer for disassembly ([Preparation for disassembly on page 14](#)).
2. Remove the access panel ([Access panel on page 15](#)).
3. Lift the rubber cover from the hood sensor **(1)**.
4. Disconnect the cable from the system board, and then lift the hood sensor out of the computer **(2)**.

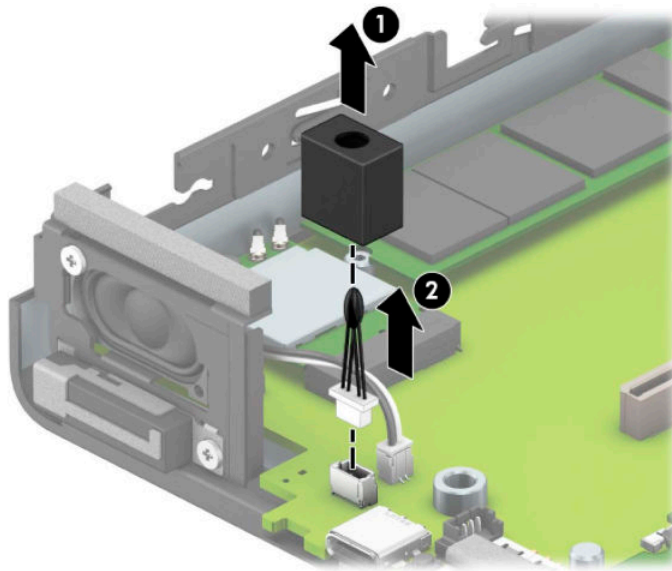

To install the hood sensor, reverse the removal procedure.

## Speaker

A single speaker is located on the left side of the computer behind the front bezel, inside the chassis. It is secured by a white peg that you pull out to release.

To remove the speaker:

1. Prepare the computer for disassembly ([Preparation for disassembly on page 14](#)).
2. Remove the access panel ([Access panel on page 15](#)).
3. Disconnect the speaker cable from the system board connector **(1)**.
4. From the front of the computer, remove the Phillips screw that secures the speaker to the chassis **(2)**.
5. Remove the insulator and tape from the top and inside of the speaker **(3)**.
6. Lift the speaker straight up and out of the bracket on the inside of the chassis **(4)**.

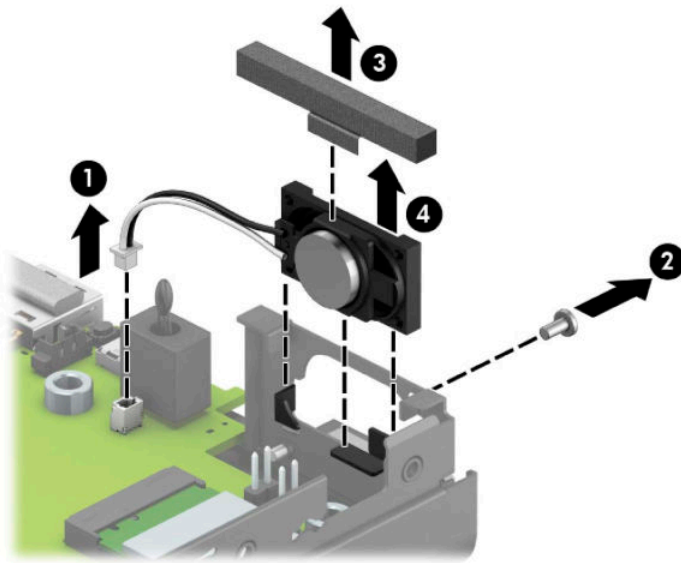

To install the speaker, reverse the removal procedures.

# Hard drive

For a list of available hard drives, see [Computer major components on page 3](#).

 **NOTE:** Before you remove the old hard drive, be sure to back up the data from the old hard drive so that you can transfer the data to the new hard drive.

1. Prepare the computer for disassembly ([Preparation for disassembly on page 14](#)).
2. Remove the access panel ([Access panel on page 15](#)).
3. Rotate the hard drive latch up **(1)** to disengage the hard drive from the cage. Then slide the drive toward the rear of the chassis until it stops, and then lift the hard drive up and out of the cage **(2)**.

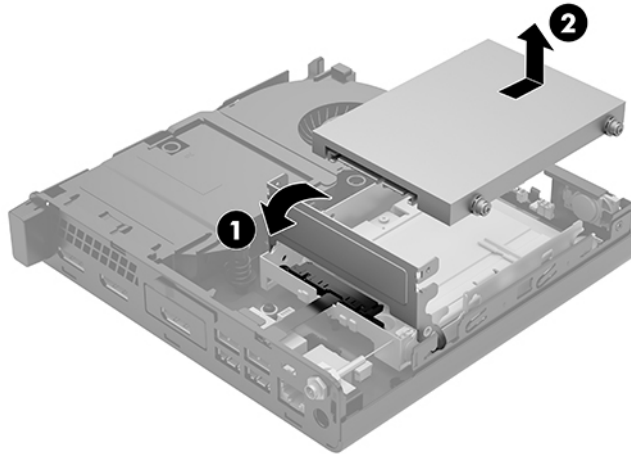

## Hard drive connector

The hard drive connector is installed in the hard drive cage and connects to the system board.

1. Prepare the computer for disassembly ([Preparation for disassembly on page 14](#)).
2. Remove the access panel ([Access panel on page 15](#)).
3. Remove the hard drive ([Hard drive on page 19](#)).
4. Disconnect the cable from the system board **(1)**.
5. Remove the two Torx T15 screws that secure the connector to the drive cage **(2)**.
6. Lift the hard drive connector out of the computer **(3)**.

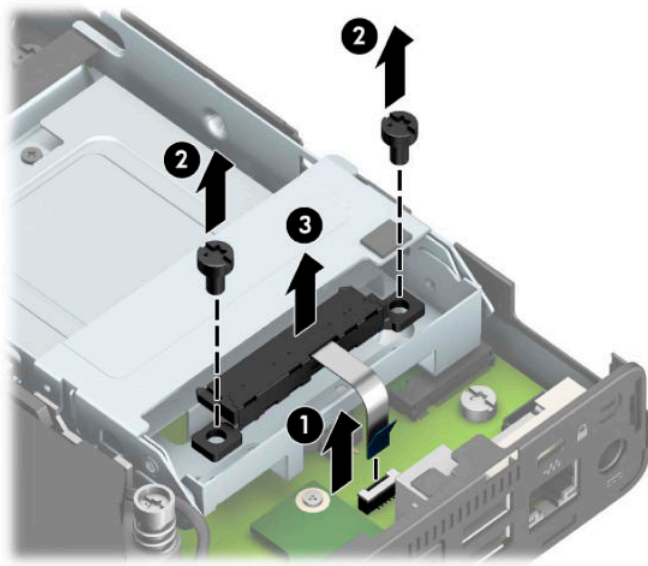

To install the hard drive connector, reverse the removal procedure.

## Drive cage

1. Prepare the computer for disassembly ([Preparation for disassembly on page 14](#)).
2. Remove the access panel ([Access panel on page 15](#)).
3. Remove the hard drive ([Hard drive on page 19](#)).
4. Lift the connector latch on the system board **(1)**, and then disconnect the hard drive cable using the pull tab on the cable **(2)**.
5. Remove the two Torx T15 screws **(3)** that secure the hard drive cage to the chassis.
6. Slide the hard drive cage back, and then lift it out of the chassis **(4)**.

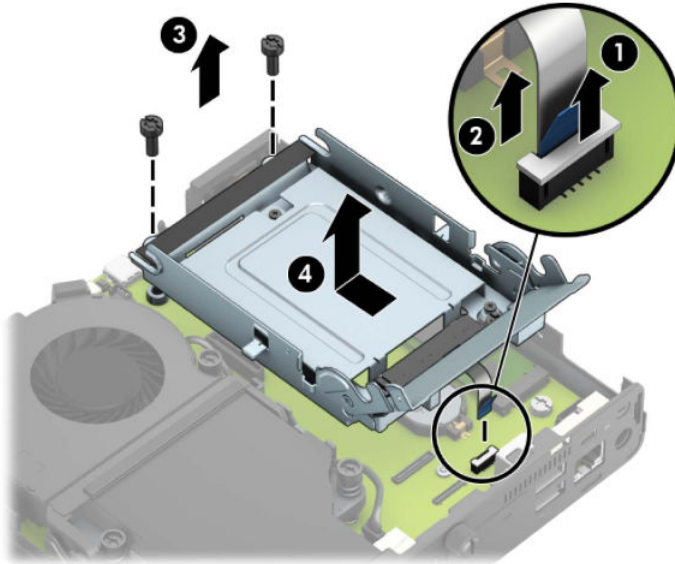

To install the drive cage, reverse the removal procedure.

## M.2 PCIe solid state drive (SSD)

For a list of available solid-state drives, see [Computer major components on page 3](#).

1. Prepare the computer for disassembly ([Preparation for disassembly on page 14](#)).
2. Remove the access panel ([Access panel on page 15](#)).
3. In models with a hard drive, remove the hard drive ([Hard drive on page 19](#)) and drive cage ([Drive cage on page 21](#)).
4. Locate the M.2 SSD on the system board.

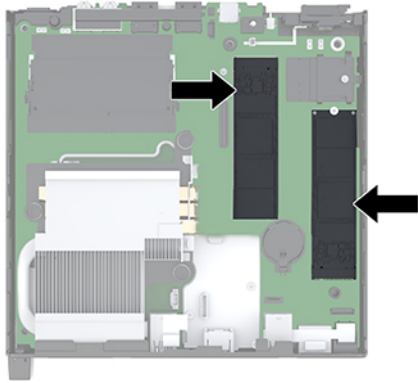

5. Remove the screw **(1)** securing the SSD to the system board, and then pull the SSD from the socket on the system board **(2)**.

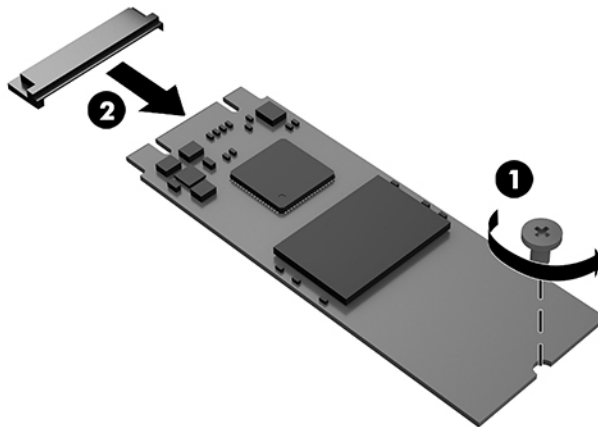

To replace the solid-state drive module, reverse the removal procedures.

## WLAN module

For a list of available WLAN modules, see [Computer major components on page 3](#).

1. Prepare the computer for disassembly ([Preparation for disassembly on page 14](#)).
2. Remove the access panel ([Access panel on page 15](#)).
3. In models with a hard drive, remove the hard drive ([Hard drive on page 19](#)) and drive cage ([Drive cage on page 21](#)).
4. Locate the WLAN module on the system board.

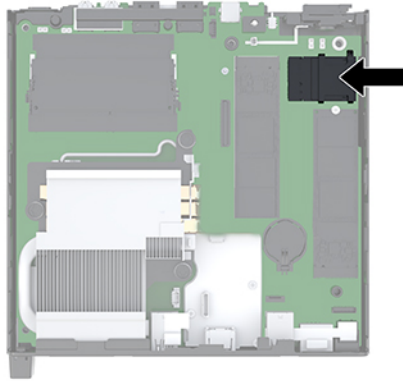

5. Disconnect both antenna cables (1) from the WLAN module.

 **NOTE:** You may need to use a small tool, such as a pair of tweezers or needle-nose pliers, to disconnect and connect the antenna cables.

6. Remove the screw (2) securing the WLAN module to the system board.
7. Grasp the WLAN module (3) by the sides and pull it out of the socket.

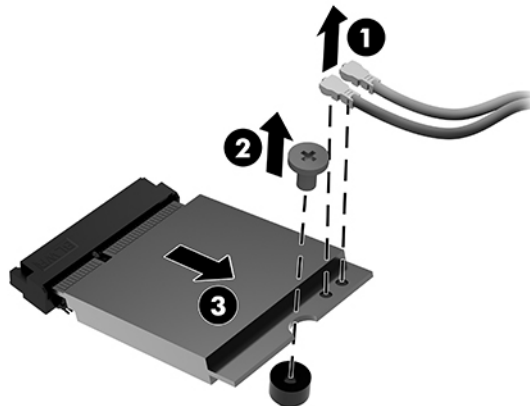

To replace the WLAN module, reverse the removal procedures.

## Battery

The battery that comes with the computer provides power to the real-time clock. When replacing the battery, use a battery equivalent to the battery originally installed in the computer. The computer comes with a 3-volt lithium coin cell battery.

---

**⚠ WARNING!** The computer contains an internal lithium manganese dioxide battery. There is a risk of fire and burns if the battery is not handled properly. To reduce the risk of personal injury:

Do not attempt to recharge the battery.

Do not expose to temperatures higher than 60°C (140°F).

Do not disassemble, crush, puncture, short external contacts, or dispose of in fire or water.

Replace the battery only with the HP spare designated for this product.

**⚠ CAUTION:** Before replacing the battery, it is important to back up the computer CMOS settings. When the battery is removed or replaced, the CMOS settings will be cleared.

Static electricity can damage the electronic components of the computer or optional equipment. Before beginning these procedures, ensure that you are discharged of static electricity by briefly touching a grounded metal object.

**📝 NOTE:** The lifetime of the lithium battery can be extended by plugging the computer into a live AC wall socket. The lithium battery is only used when the computer is NOT connected to AC power.

HP encourages customers to recycle used electronic hardware, HP original print cartridges, and rechargeable batteries. For more information about recycling programs, go to <http://www.hp.com/recycle>.

---

1. Prepare the computer for disassembly ([Preparation for disassembly on page 14](#)).
2. Remove the access panel ([Access panel on page 15](#)).
3. In models with a hard drive, remove the hard drive ([Hard drive on page 19](#)) and drive cage ([Drive cage on page 21](#)).
4. Locate the battery and battery holder on the system board.

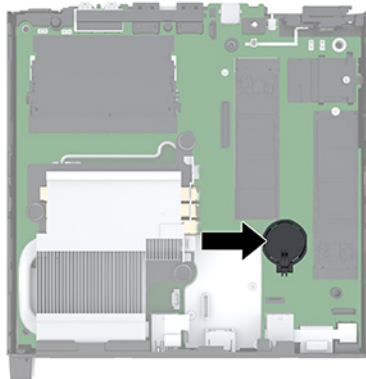

---

**📝 NOTE:** You may need to use a small tool, such as tweezers or needle-nose pliers, to remove and replace the battery.

---



5. Lift the battery out of the holder.



6. Slide the replacement battery into position, positive side up. The battery holder automatically secures the battery in the proper position.
7. Reassemble the computer.
8. Reset the date and time, your passwords, and any special system setups using Computer Setup.

## Expansion connector board

For a list of available expansion connector boards, see [Computer major components on page 3](#).

An expansion board can be installed near the back of the system board that provides an additional connector on the rear I/O panel. The board is secured with two screws and connects to the a connector on the system board.

To remove the expansion connector board:

1. Prepare the computer for disassembly ([Preparation for disassembly on page 14](#)).
2. Remove the access panel ([Access panel on page 15](#)).
3. In models with a hard drive, remove the hard drive ([Hard drive on page 19](#)) and drive cage ([Drive cage on page 21](#)).
4. Remove the two Phillips screws **(1)** that secure the board to the system board.
5. Lift to disengage the board from the system board connector, and then remove the expansion connector board from the computer **(2)**.

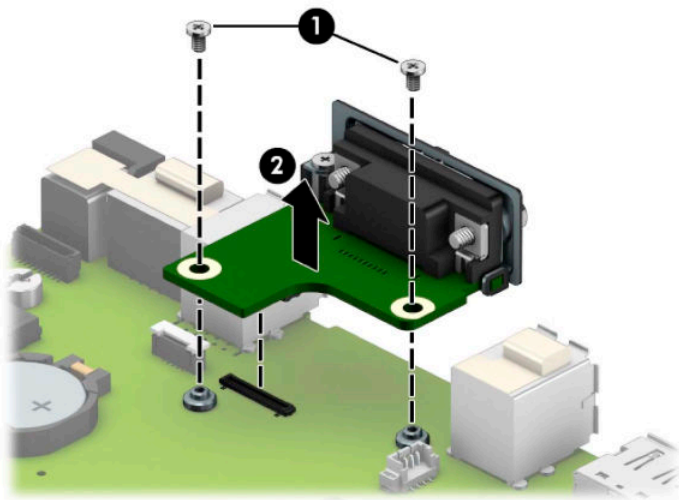

To install the expansion connector board, reverse the removal procedures.

# Memory modules

The computer comes with at least one small outline, dual in-line memory module (SODIMM). To achieve maximum memory support, you can populate the system board with up to 32 GB of memory.

## Memory module specifications

For proper system operation, the memory modules must meet the following qualifications:

Component	Specification
Memory modules	1.2 volt DDR4-SDRAM memory modules
Compliance	Unbuffered non-ECC PC4-17000 DDR4-2133 MHz-compliant
Pins	Industry-standard 260-pin containing the mandatory Joint Electronic Device Engineering Council (JEDEC) specification
Support	CAS latency 15 DDR4 2400 MHz (15-15-15 timing)
Slots	2
Maximum Memory	32 GB
Supported	2 Gbit, 4 Gbit, 8 Gbit, and 16 Gbit non-ECC memory technologies single-sided and double-sided memory modules

**NOTE:** The system does not operate properly if you install unsupported memory modules. Memory modules constructed with x8 and x16 DDR devices are supported; memory modules constructed with x4 SDRAM are not supported.

HP offers upgrade memory for this computer and advises that the consumer purchase it to avoid compatibility issues with unsupported third-party memory.

## Removing memory modules

For a list of available memory modules, see [Computer major components on page 3](#).

There are two memory module slots on the system board, with one slot per channel. The sockets are labeled DIMM1 and DIMM3. The DIMM1 slot operates in memory channel B. The DIMM3 slot operates in memory channel A.

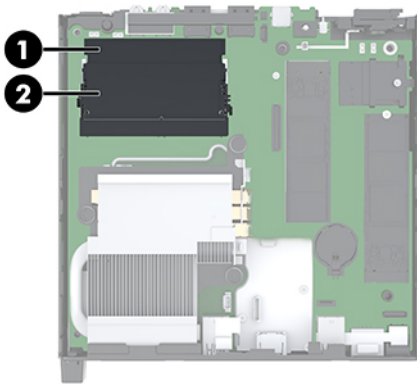

Item	Description	System Board Label	Slot Color
1	Memory module slot, Channel B	DIMM1	Black
2	Memory module slot, Channel A	DIMM3	Black

The system will automatically operate in single-channel mode, dual-channel mode, or flex mode, depending on how the memory modules are installed.

- The system will operate in single-channel mode if the memory module slots are populated in one channel only.
- The system will operate in a higher-performing dual-channel mode if the memory capacity of the memory module in Channel A is equal to the memory capacity of the memory module in Channel B.
- The system will operate in flex mode if the memory capacity of the memory module in Channel A is not equal to the memory capacity of the memory module in Channel B. In flex mode, the channel populated with the least amount of memory describes the total amount of memory assigned to dual-channel and the remainder is assigned to single-channel. If one channel will have more memory than the other, the larger amount should be assigned to channel A.
- In any mode, the maximum operational speed is determined by the slowest memory module in the system.



**IMPORTANT:** You must disconnect the power cord and wait approximately 30 seconds for the power to drain before adding or removing memory modules. Regardless of the power-on state, voltage is always supplied to the memory modules as long as the computer is plugged into an active AC outlet. Adding or removing memory modules while voltage is present may cause irreparable damage to the memory modules or system board.

The memory module slots have gold-plated metal contacts. When upgrading the memory, it is important to use memory modules with gold-plated metal contacts to prevent corrosion and/or oxidation resulting from having incompatible metals in contact with each other.

Static electricity can damage the electronic components of the computer or optional cards. Before beginning these procedures, ensure that you are discharged of static electricity by briefly touching a grounded metal object. For more information, see [Electrostatic discharge information on page 7](#).

When handling a memory module, be careful not to touch any of the contacts. Doing so may damage the module.

1. Prepare the computer for disassembly ([Preparation for disassembly on page 14](#)).
2. Remove the access panel ([Access panel on page 15](#)).

3. Tilt the fan up using the front tab and leave it in the up position.

 **NOTE:** It is not necessary to fully remove the fan to remove or install a memory module.

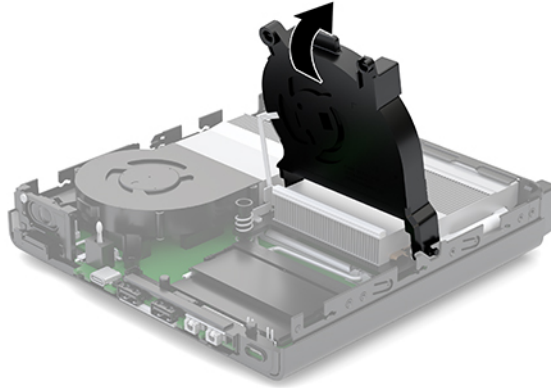

4. Locate the memory module locations **(1)** and **(2)** on the system board.

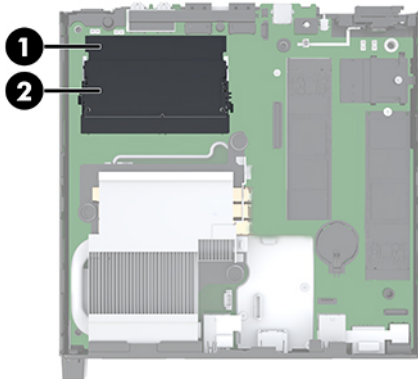

5. To remove a memory module, press outward on the two latches on each side of the memory module **(1)**, and then pull the memory module **(2)** out of the slot.



The computer automatically recognizes the new memory when you turn on the computer.

## Fan

1. Prepare the computer for disassembly ([Preparation for disassembly on page 14](#)).
2. Remove the access panel ([Access panel on page 15](#)).
3. Disconnect the fan cable from the system board **(1)**.
4. Remove the fan cable from the clips on the side of the heat sink **(2)**.
5. Lift fan up to about 30-45 degrees **(3)**, and then pull it away from the heat sink **(4)**.

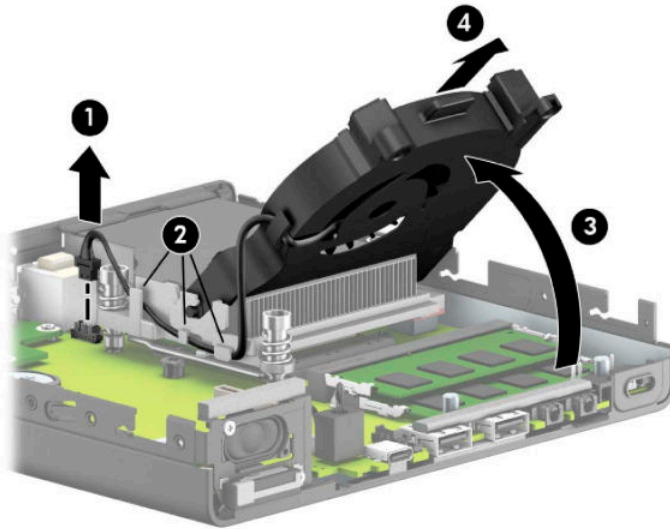

To install the fan, reverse the removal procedure.

# Heat sink

**⚠ CAUTION:** The bond between the heat sink and the processor may be very tight.

If the computer will power on, before removing the heat sink, turn on the computer until it warms the heat sink. Warming the fan sink lessens the bond between the heat sink and the processor, thereby making separating them easier.

Make sure not to pull the processor out of the socket when you lift the heat sink, especially if you cannot warm the fan sink prior to removal. Inadvertently removing the processor can damage the pins.

The heat sink is secured with three captive Torx screws.

order indicated on the heat sink.

1. Prepare the computer for disassembly ([Preparation for disassembly on page 14](#)).
2. Remove the access panel ([Access panel on page 15](#)).
3. Remove the fan ([Fan on page 30](#)).
4. Disconnect the fan cable from the system board **(1)**.
5. Loosen the three captive Torx screws **(2)** that secure the heat sink to the computer.
6. Remove the heat sink from the computer **(3)**.

**⚠ CAUTION:** Be sure the loosen the screws in the order indicated by the numbers stamped on the heat sink to avoid damaging the processor.

To reduce a degradation in thermal performance, be sure not to touch the thermal grease on the surface of the processor or the heat sink.

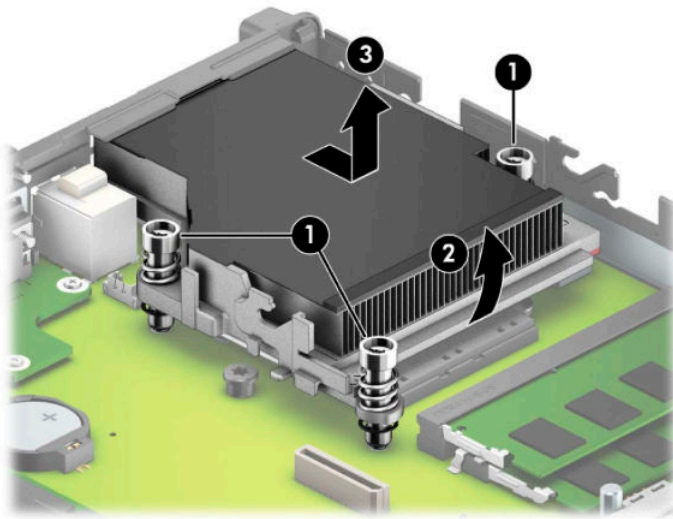

To replace the heat sink, reverse the removal procedures.

Thermal grease services the processor **(1)** and heat sink **(2)**. Thermal pads service the system board components **(3)** and heat sink **(4)**.

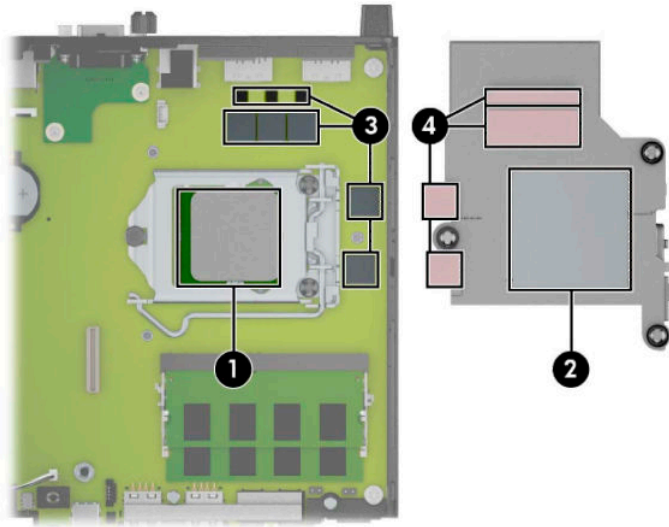



# Processor

For a list of available processors, see [Computer major components on page 3](#).

1. Prepare the computer for disassembly ([Preparation for disassembly on page 14](#)).
2. Remove the access panel ([Access panel on page 15](#)).
3. Remove the fan ([Fan on page 30](#)).
4. Remove the heat sink ([Heat sink on page 31](#)).
5. Unlatch the locking lever from the side of the processor socket (**1**).
6. Rotate the locking lever to its fully open position (**2**).
7. Raise and rotate the microprocessor retainer to its fully open position (**3**).
8. Lift the processor straight up to remove it (**4**).

**CAUTION:** Do NOT handle the pins in the processor socket. These pins are very fragile and handling them could cause irreparable damage. Once pins are damaged it may be necessary to replace the system board.

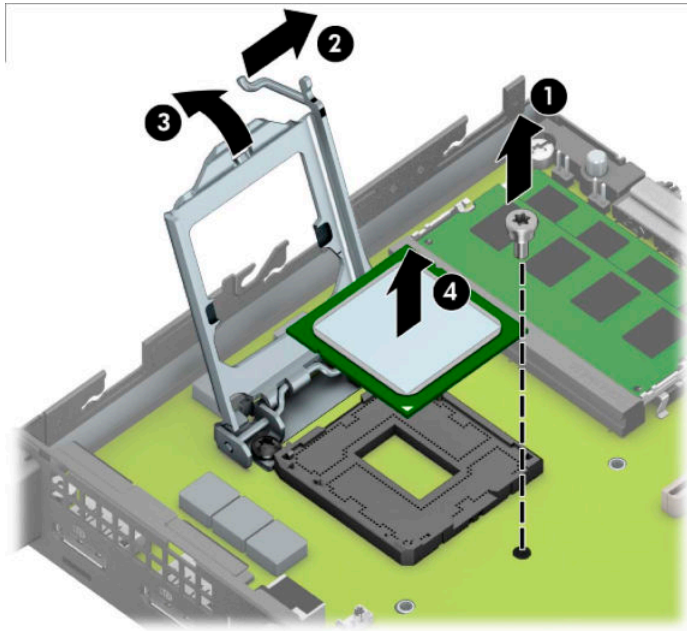

Reverse the removal procedure to install a new processor.

**NOTE:** After installing a new processor onto the system board, update the system ROM to ensure that the latest version of the BIOS is being used on the computer. The latest system BIOS can be found on the Web at: <http://h18000.www1.hp.com/support/files>.

# System board

 **NOTE:** All system board spare part kits include replacement thermal material.

 **NOTE:** System board appearance may vary.

1. Prepare the computer for disassembly ([Preparation for disassembly on page 14](#)).
2. Remove the access panel ([Access panel on page 15](#)).
3. In models with a hard drive, remove the hard drive ([Hard drive on page 19](#)) and drive cage ([Drive cage on page 21](#)).
4. Remove the fan ([Fan on page 30](#)).
5. Remove the heat sink ([Heat sink on page 31](#)).
6. When replacing the system board, make sure the following components are removed from the defective system board and installed on the replacement system board (as applicable):
  - Memory modules ([Memory modules on page 27](#))
  - M.2 solid-state drive ([M.2 PCIe solid state drive \(SSD\) on page 22](#))
  - Processor ([Processor on page 33](#))
  - WLAN module ([WLAN module on page 23](#))
  - Expansion connector board ([Expansion connector board on page 26](#))
7. To remove the system board:
  - a. On models with a hard drive, disconnect the speaker cable from the system board (**1**), and then remove the three Torx T15 screws (**2**) that secure the system board to the computer.

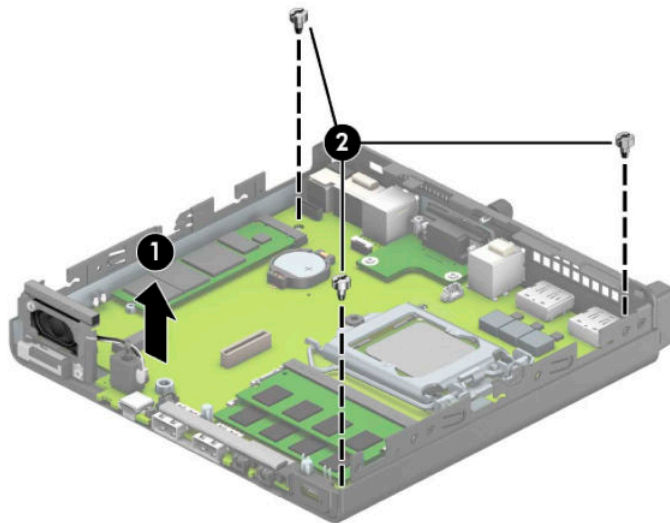

- b. On models without a hard drive, disconnect the speaker cable from the system board (1), and then remove the five Torx T15 screws (2) that secure the system board to the computer.

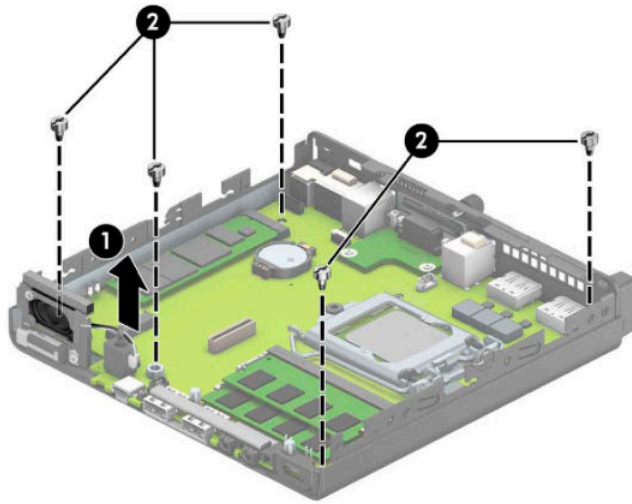

8. Lift the front of the system board (1), and then pull it out of the computer (2).

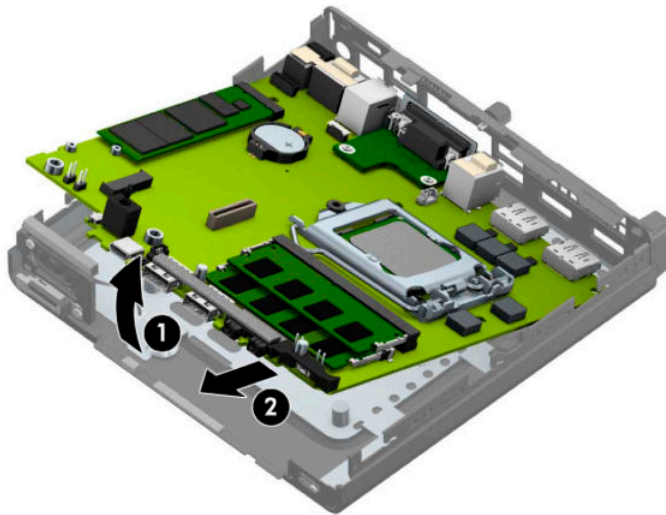

To install the system board, reverse the removal procedures.

When replacing a system board be sure to install a thermal pad to service the graphics processor on the system board (1) at the location on the chassis as shown by callout (2) in the following image.

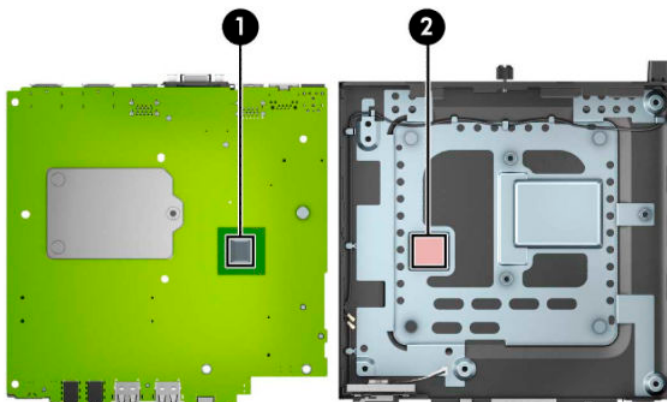



**NOTE:** When replacing the system board, you must change the chassis serial number in the BIOS.

### Updating SMBIOS Information

When replacing the system board, you must reprogram the SMBIOS information on the affected computer. Failure to reprogram the board will result in eventual failure, such as an activation failure (need to reactivate the system) or a system recovery failure.

To update SMBIOS information in Computer Setup:

1. Turn on or restart the computer.
2. Press **Esc** while the “Press the ESC key for Startup Menu” message is displayed at the bottom of the screen.



**NOTE:** If you do not press **Esc** at the appropriate time, you must restart the computer and again press **Esc** when the monitor light turns green to access the utility.

3. Press **F10** to enter Computer Setup.
4. Go to **Main > Set Machine Unique Data**.
5. If necessary, press **Ctrl+A** to initiate edit mode.
6. Edit the fields listed. If the feature byte has data or is not editable, then it was not cleared and cannot be edited.

### System ID Setup Page

Setup Field Name	Comment	Label
Product Name	Enter the Model name/number or marketing name.	Flexbuild
Serial Number	Enter the Serial Number of Unit.	Support
SKU Number	Enter the SKU or Product Number including Localization Code.	Support
Asset Tag	Enter the 18-byte identifier assigned to the computer.	Support
Feature Byte	<p>Enter the Feature Byte string. The feature byte string is case sensitive.</p> <p>The label includes spaces after every four characters. You can enter or ignore these spaces – their only purpose is to help with data entry. There is a character limitation of 40 bytes per line. When you reach this limit, go</p> <p>If you make an error during data entry, the data will not validate, and the computer asks you to correct your data input.</p>	Flexbuild
Build ID	The Build ID of the unit.	Flexbuild

## System board components

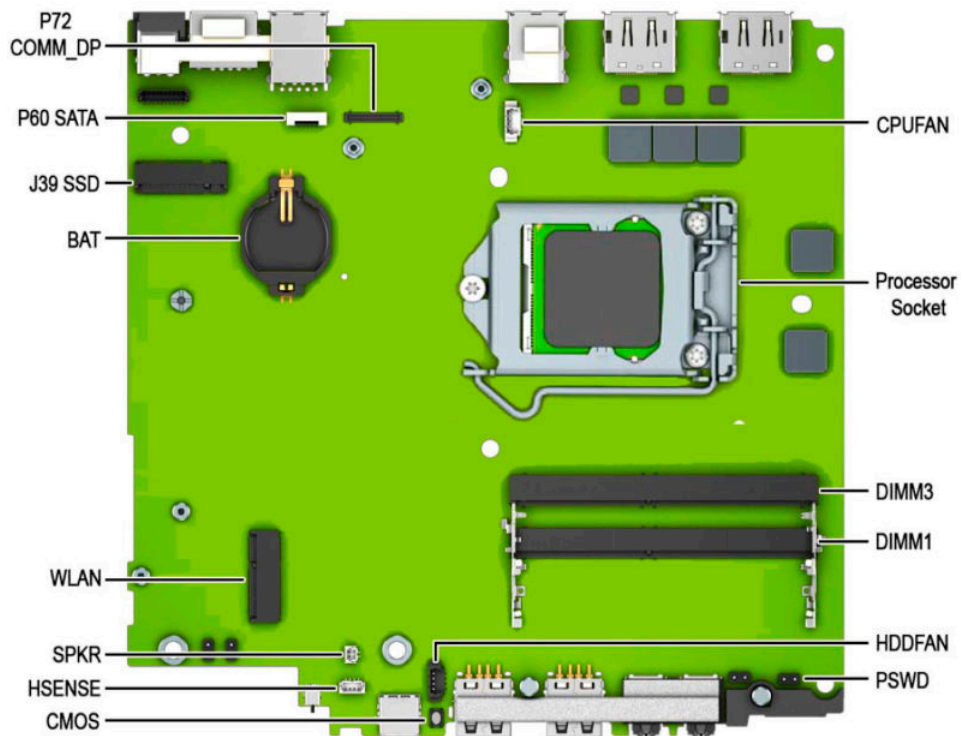

Sys Bd Label	Color	Component	Sys Bd Label	Color	Component
CPUFAN	White	Processor fan	HSENSE	White	Hood sensor
CPU	Black	Processor	SPKR	White	Speaker
DIMM3	Black	Secondary memory	WLAN	Black	WLAN module
DIMM1	Black	Primary memory	BAT	Black	RTC battery
HDDFAN	Black	Hard drive fan	SSD	Black	Solid-state module
PSWD	Black	Password header and jumper	P60 SATA	White	Hard drive
CMOS	Yellow	CMOS reset button	P72 COMM_DP	Black	Expansion board connector

## Internal WLAN antenna cables

The antennas route from the WLAN module to the cable connectors on the front and the rear of the computer.

To install the antennas:

1. Prepare the computer for disassembly ([Preparation for disassembly on page 14](#)).
2. Remove the access panel ([Access panel on page 15](#)).
3. Remove the hard drive ([Hard drive on page 19](#)).
4. Remove the drive cage ([Drive cage on page 21](#)).
5. Remove the fan ([Fan on page 30](#)).
6. Remove the heat sink ([Heat sink on page 31](#)).
7. If applicable, remove the expansion connector board ([Expansion connector board on page 26](#)).
8. Disconnect the antenna cables from the WLAN module ([WLAN module on page 23](#)).
9. Remove the system board ([System board on page 34](#)).
10. Remove the antenna cables from their routing paths along the interior sides of the computer chassis **(1)**.
11. On the rear of the computer, remove the antenna cover by pressing on the tab on the top of the cover **(2)**, and then rotating the top of the cover downward and off the computer **(3)**.



**NOTE:** One end of the antenna cover is slightly longer than the other, so make sure to correctly orientate the cover when replacing.

12. Pull the antenna off the chassis, and then pull the cable out of the computer **(4)**.

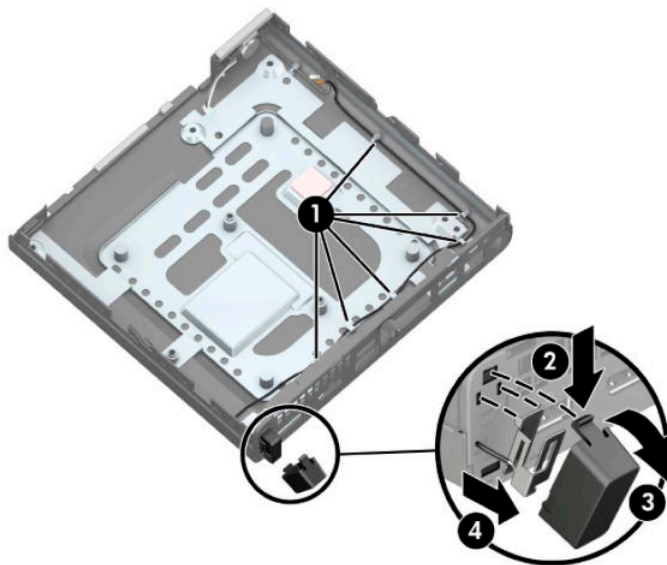

13. If the computer has dual antennas, from the front of the computer, remove the antenna cables from the clips in the chassis **(1)**.
14. Remove the Phillips screw **(2)** that secures the antenna to the chassis.

15. Rotate and remove the antenna (3), and then pull the cable out of the front of the chassis (4).

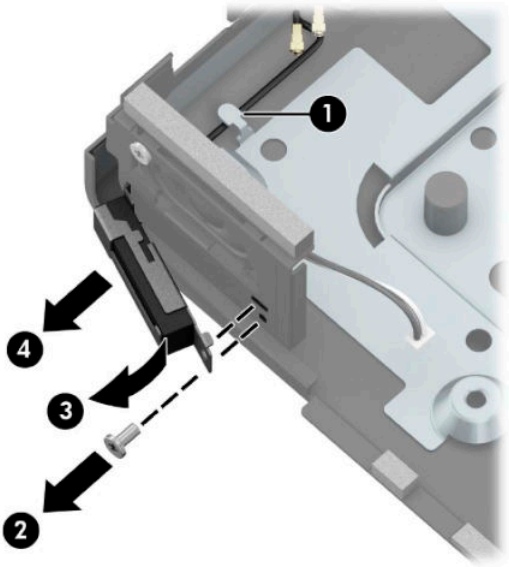

Reverse the removal procedure to install the WLAN antennas and cables.

## Changing from desktop to tower configuration

The computer can be used in a tower orientation with an optional tower stand that can be purchased from HP.

1. Prepare the computer for disassembly ([Preparation for disassembly on page 14](#)).
2. Orient the computer so that its right side is facing up and place the computer in the optional stand.

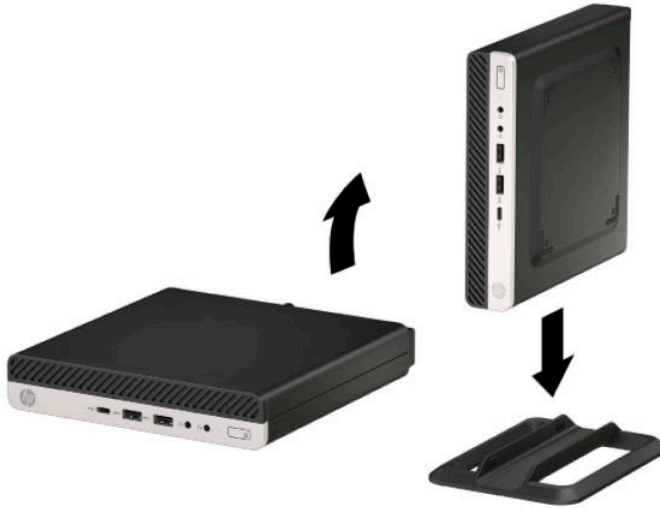

---

 **NOTE:** To stabilize the computer in a tower orientation, HP recommends the use of the optional tower stand.

---

3. Reconnect the AC power cord and any external devices, then turn on the computer.

 **NOTE:** Ensure at least 10.2 centimeters (4 inches) of space on all sides of the computer remains clear and free of obstructions.

---

4. Lock any security devices that were disengaged when the top cover was removed.



---

# 5 Computer Setup (F10) Utility

## Computer Setup (F10) Utilities

Use Computer Setup (F10) Utility to do the following:

- Change settings from the defaults or restore the settings to default values.
- View the system configuration, including settings for processor, graphics, memory, audio, storage, communications, and input devices.
- Modify the boot order of bootable devices such as hard drives, optical drives, or USB flash media devices.
- Enter the Asset Tag or property identification number assigned by the company to this computer.
- Enable the power-on password prompt during system restarts (warm boots) as well as during power-on.
- Establish an administrator password that controls access to the Computer Setup (F10) Utility and the settings described in this section.
- Establish minimum requirements for valid passwords, including length and required types of characters.
- Secure integrated I/O functionality, including the serial, USB, or audio, or embedded NIC, so that they cannot be used until they are unsecured.
- Enable or disable different types of boot sources.
- Configure features such as Secure Boot, power management, virtualization support, and language and keyboard type used in Setup and POST.
- Replicate the system setup by saving system configuration information on a USB device and restoring it on one or more computers.
- Enable or disable DriveLock security or securely erase a hard drive (when supported by drive).

## Using Computer Setup (F10) Utilities

Computer Setup can be accessed only by turning the computer on or restarting the system. To access the Computer Setup Utilities menu, complete the following steps:

1. Turn on or restart the computer.
2. Repeatedly press **F10** when the monitor light turns green to access the utility.

You can also press **Esc** to a menu that allows you to access different options available at startup, including the Computer Setup utility.

---

 **NOTE:** If you do not press **F10** at the appropriate time, you must restart the computer and again repeatedly press **F10** when the monitor light turns green to access the utility.

---

3. A choice of four headings appears in the Computer Setup Utilities menu: Main, Security, Advanced, and UEFI Drivers.

---

 **NOTE:** Selecting UEFI Drivers restarts the computer into the 3rd party option ROM management application. You can access this application directly by pressing **F3** during startup.

---

4. Use the arrow (left and right) keys to select the appropriate heading. Use the arrow (up and down) keys to select the option you want, then press **Enter**. To return to the Computer Setup Utilities menu, press **Esc**.
5. To apply and save changes, select **Main > Save Changes and Exit**.
  - If you have made changes that you do not want applied, select **Ignore Changes and Exit**.
  - To restore settings from the Advanced and Main menus to original values, select **Apply Factory Defaults and Exit**.
  - To restore settings from the Advanced and Main menus to those previously saved by **Save Custom Defaults**, select **Apply Custom Defaults and Exit**. If no custom defaults have been saved, then factory defaults are used.

---

 **NOTE:** Settings in the **Security** menu are not modified by **Apply Defaults**. Those values are reset by **Restore Security Settings to Factory Defaults** at the bottom of the **Security** menu.

 **NOTE:** Not all settings shown in the following sections are available for all models

---

 **CAUTION:** Do NOT turn the computer power OFF while the BIOS is saving the Computer Setup (F10) changes because the settings could become corrupted. It is safe to turn off the computer only after exiting the F10 Setup screen.

---

## Computer Setup—Main



**NOTE:** Support for specific Computer Setup options may vary depending on the hardware configuration.

**Table 5-1 Computer Setup—Main**

Option	Description
<b>System Information</b>	<p>Lists all information in following list if <b>Advanced System Information</b> is selected. Lists smaller subset if <b>Basic System Information</b> is selected.</p> <ul style="list-style-type: none"><li>• Product name</li><li>• Installed memory size</li><li>• <b>Processor</b><ul style="list-style-type: none"><li>Processor type</li></ul></li><li>• Processor cache size (L1/L2/L3)</li><li>• Processor speed</li><li>• MicroCode revision</li><li>• Processor stepping</li><li>• DIMM size (for each installed module)</li><li>• <b>Firmware</b><ul style="list-style-type: none"><li>System BIOS version</li></ul></li><li>• ME Firmware version (Intel only)</li><li>• Video BIOS version</li><li>• Reference code version</li><li>• Super I/O Firmware version</li><li>• USB Type-C controller(s) firmware version</li><li>• <b>Service</b><ul style="list-style-type: none"><li>Born on date</li></ul></li><li>• Serial number</li><li>• SKU number</li><li>• UUID (Universally Unique Identifier)</li><li>• Asset tracking number</li><li>• Feature byte</li><li>• Build ID</li><li>• Product family</li><li>• System board ID</li><li>• System board CT number</li><li>• <b>Communication</b><ul style="list-style-type: none"><li>Integrated MAC Address</li></ul></li></ul>
<b>System Diagnostics</b>	<p>If the hard drive has the HP Advanced Diagnostics installed, the application will launch. If HP Advanced Diagnostics is not installed, then a basic version built into the BIOS will provide the capability to perform the following functions:</p>

**Table 5-1 Computer Setup—Main (continued)**

Option	Description
	<ul style="list-style-type: none"> <li>• Provide detailed system information</li> <li>• Hardware subsystem tests</li> <li>• Component tests</li> <li>• Show test logs</li> <li>• Language selection</li> </ul>
<b>Update System BIOS</b>	<p>Lets you update the system BIOS from <a href="http://www.hp.com">www.hp.com</a> or another network server, from a removable USB drive, or from a file located on the hard drive.</p> <p>Displays current BIOS version information.</p> <ul style="list-style-type: none"> <li>• ‘Check HP.com for BIOS Updates’ or ‘Check the Network for BIOS Updates’</li> </ul> <p>The string that appears here depends on the setting in ‘BIOS Update Preferences’. This selection checks for the latest BIOS release revision on the network and lets you choose whether to download the BIOS image and update the computer.</p> <p><b>NOTE:</b> If MS Windows BitLocker Drive Encryption (BDE) is enabled, you must suspend BDE temporarily before flashing. Be sure to obtain the BDE recovery password or recovery PIN before suspending BDE. You can enable BDE after updating the BIOS.</p> <ul style="list-style-type: none"> <li>• BIOS Rollback Policy</li> </ul> <p>Lets you select whether a minimum BIOS version can be allocated. If ‘Restricted rollback to older BIOS’ is selected, ‘Minimum BIOS version’ becomes active. Select to enter the minimum BIOS version that can be rolled back to.</p> <ul style="list-style-type: none"> <li>■ Unrestricted rollback to older BIOS</li> <li>■ Restricted rollback to older BIOS</li> </ul> <ul style="list-style-type: none"> <li>• Allow BIOS updates using a network</li> <li>• BIOS Update Preferences</li> </ul> <p>Allows the administrator to select the source of network updates (<a href="http://www.hp.com">www.hp.com</a> or another network server) and allows configuration of a periodic check for updates, including policies for:</p> <ul style="list-style-type: none"> <li>■ Check for updates and prompt the user to accept or reject the update at that time</li> <li>■ Check for updates and install all new versions</li> <li>■ Check for updates and install only new versions marked important</li> </ul> <ul style="list-style-type: none"> <li>• Network Configuration Settings</li> </ul>
<b>Change Date and Time</b>	Allows you to set system time and date.
<b>System IDs</b>	<p>Lets you set the following values:</p> <ul style="list-style-type: none"> <li>• Asset Tracking Number</li> <li>• Ownership Tag</li> </ul>
<b>Replicated Setup</b>	<p><b>Backup current settings to USB device</b></p> <p>Saves system configuration to a formatted USB flash media device.</p> <p><b>Restore current settings from USB device</b></p> <p>Restores system configuration from a USB flash media device.</p>
<b>Save Custom Defaults</b>	Saves the current system configuration settings as the custom default set.

**Table 5-1 Computer Setup—Main (continued)**

Option	Description
<b>Apply Custom Defaults and Exit</b>	Applies the custom default settings to the computer after rebooting. Does not apply to options in the <b>Security</b> menu.
<b>Apply Factory Defaults and Exit</b>	Restores the factory system configuration settings to the computer after rebooting. Does not apply to options in the <b>Security</b> menu.
<b>Ignore Changes and Exit</b>	Exits Computer Setup without applying or saving any changes.
<b>Save Changes and Exit</b>	Saves changes to current system configuration, exits Computer Setup, and reboots.

## Computer Setup—Security



**NOTE:** Support for specific Computer Setup options may vary depending on the hardware configuration.

**Table 5-2 Computer Setup—Security**

Option	Description
<b>Create BIOS Administrator Password</b>	<p>Lets you set and enable a BIOS administrator password, which controls access to the following features:</p> <ul style="list-style-type: none"> <li>• Setup Menu (F10)</li> <li>• 3rd Party Option ROM Management (F3)</li> <li>• Update system ROM</li> <li>• WMI commands that change system settings</li> <li>• BIOS Configuration Utility (BCU)</li> <li>• Alternative power-on password</li> </ul> <p><b>NOTE:</b> Creating a BIOS user disables the Fast Boot option.</p> <p><b>NOTE:</b> If the password is set, it is required to change Computer Setup options, update the BIOS, and make changes to certain plug and play settings under Windows.</p>
<b>Change BIOS Administrator Password</b>  (This selection is active only if a BIOS administrator password is set.)	<p>Lets you change the BIOS administrator password.</p> <p>You must know the current password to be able to change it.</p>
<b>Create POST Power-On Password</b>	<p>Lets you set and enable a BIOS power-on password. The power-on password prompt appears after a power cycle or reboot. If the user does not enter the correct power-on password, the unit will not boot.</p> <p><b>NOTE:</b> Administrator password may be used at the power-on password prompt.</p>
<b>Change POST Power-On Password</b>  (This selection is active only if a POST Power-On password is set.)	<p>Lets you change the POST Power-On password.</p> <p>You must know the current password to be able to change it.</p>
<b>Password Policies</b>	<p>Let you set the guidelines for a valid password. Options include:</p> <ul style="list-style-type: none"> <li>• Password minimum length</li> <li>• Requires at least one symbol</li> <li>• Requires at least one number</li> </ul>

**Table 5-2 Computer Setup—Security (continued)**

Option	Description
	<ul style="list-style-type: none"> <li>• Requires at least one upper case character</li> <li>• Requires at least one lower case character</li> <li>• Allow spaces</li> </ul> <p><b>Clear Password Jumper</b></p> <p>Select 'Honor' to allow or 'Ignore' to not allow the absence of the password jumper to clear the passwords at boot up. Default is 'Honor'.</p>
<b>Security Configuration</b>	<p><b>TPM Embedded Security</b></p> <ul style="list-style-type: none"> <li>• <b>TPM Specification Version</b> Displays the current TPM version.</li> <li>• <b>TPM Device</b> Lets you set the Trusted Platform Module as available or hidden.</li> <li>• <b>TPM State</b> Select to enable the TPM's data store (default). Clear to disable the data store without affecting the data.</li> <li>• <b>ClearTPM</b> Select to clear the saved keys and data in the TPM's data store on the next boot. After rebooting this field is cleared.  <b>CAUTION:</b> Any services using the TPM (for example, Windows' Bitlocker encryption service) will lose functionality that depends on saved data.</li> </ul> <p><b>BIOS Sure Start</b></p> <ul style="list-style-type: none"> <li>• <b>Verify Boot Block on every boot.</b> Default is disabled.</li> <li>• <b>BIOS Data Recovery Policy.</b> Default is Automatic.  <b>IMPORTANT:</b> Only select Manual in situations in which forensic analysis is to be performed before HP Sure Start Recovery. When this policy is set to manual, HP Sure Start will not correct any issues that are found until the manual recovery key sequence is entered by the local user. This can result in a system that is unable to boot after inputting the manual recovery key sequence.</li> <li>• <b>Sure Start BIOS Settings Protection.</b> This setting requires setting the BIOS Administrator password. Default is disabled.</li> <li>• <b>Sure Start Secure Boot Keys Protection.</b> Default is enabled.</li> <li>• <b>Enhanced HP Firmware Runtime Intrusion Prevention and Detection.</b> Enables monitoring of firmware executing out of main memory while the operating system is running. Any anomalies detected in firmware that are active while the operating system is running results in generation of a Sure Start Security Event. Default is enabled.</li> <li>• <b>Sure Start Security Event Policy.</b> Controls HP Sure Start behavior upon identifying a critical security event (any modification to firmware) during operating system runtime. When set to <b>Log Event Only</b>, HP Sure Start logs all critical security events. When set to <b>Log Event and Notify User</b>, HP Sure Start notifies the user that a critical event has occurred. When set to <b>Log Event and Power Off System</b>, HP Sure Start powers off the system upon detecting a security event. Default is <b>Log Event Only</b>.</li> <li>• <b>Sure Start Security Event Boot Notification.</b> Default is <b>Require Acknowledgment</b>.</li> </ul> <p><b>HP Secure Platform Management (SPM)</b></p> <ul style="list-style-type: none"> <li>• <b>HP Sure Run Current State</b> (Inactive/Active)</li> <li>• <b>Deactivate HP Sure Run</b></li> </ul>

**Table 5-2 Computer Setup—Security (continued)**

Option	Description
	<ul style="list-style-type: none"> <li>● <b>SPM Current State</b> (Not provisioned/Provisioned)</li> <li>● <b>Unprovision SPM</b></li> </ul> <p><b>Physical Presence Interface.</b> Notifies the user upon system power up when changes are made to system security policy. The user must agree to the changes to confirm them. Default is enabled.</p> <p><b>Smart Cover</b></p> <ul style="list-style-type: none"> <li>● <b>Cover Lock.</b> Default is 'Unlock'.</li> <li>● <b>Cover Removal Sensor.</b> Lets you disable the cover sensor or configure what action is taken if the computer cover was removed. Default is 'Disabled'.</li> </ul> <p><b>NOTE:</b> <b>Notify user</b> alerts the user with a POST error on the first boot after the sensor detects removal of the cover. If the password is set, <b>Administrator Password</b> requires that the password be entered to boot the computer if the sensor detects that the cover has been removed.</p> <ul style="list-style-type: none"> <li>● <b>Trusted Execution Technology (TXT)</b></li> </ul> <p>Enabling this feature disables OS management of Embedded Security Device, prevents a reset of the Embedded Security Device, and prevents the configuration of VTx, VTd, and Embedded Security Device.</p> <ul style="list-style-type: none"> <li>● <b>Intel Software Guard Extensions (SGX)</b></li> </ul> <p>SGX protects select code and data from disclosure or modification.</p>
<b>Utilities</b>	<p><b>Hard Drive Utilities</b></p> <ul style="list-style-type: none"> <li>● <b>Save/Restore MBR of the system hard drive is only available with drives that have a Master Boot Record</b></li> </ul> <p><b>NOTE:</b> Windows 10 systems are generally not formatted to include an MBR. Instead they use GUID Partition Table (GPT) format, which better supports large hard drives.</p> <p>Enabling this feature will save the Master Boot Record (MBR) of the system hard drive. If the MBR gets changed, the user will be prompted to restore the MBR. Default is disabled.</p> <p>The MBR contains information needed to successfully boot from a disk and to access the data stored on the disk. Master Boot Record Security may prevent unintentional or malicious changes to the MBR, such as those caused by some viruses or by the incorrect use of certain disk utilities. It also allows you to recover the "last known good" MBR, should changes to the MBR be detected when the system is restarted.</p> <p><b>NOTE:</b> Most operating systems control access to the MBR of the current bootable disk; the BIOS cannot prevent changes that may occur while the operating system is running.</p> <p>Restores the backup Master Boot Record to the current bootable disk. Default is disabled.</p> <p>Only appears if all of the following conditions are true:</p> <ul style="list-style-type: none"> <li>– MBR security is enabled</li> <li>– A backup copy of the MBR has been previously saved</li> <li>– The current bootable disk is the same disk from which the backup copy was saved</li> </ul> <p><b>CAUTION:</b> Restoring a previously saved MBR after a disk utility or operating system has modified the MBR, may cause the data on the disk to become inaccessible. Only restore a previously saved MBR if you are confident that the current bootable disk's MBR has been corrupted or infected with a virus.</p> <ul style="list-style-type: none"> <li>● <b>Save/Restore GPT of System Hard Drive</b></li> </ul> <p>Enabling this feature will save the GUID Partition Table (GPT) of the system hard drive. If the GPT is subsequently changed, the user is prompted to choose whether to restore GPT.</p> <ul style="list-style-type: none"> <li>● <b>Boot Sector (MBR/GPT) Recovery Policy</b> Options include:</li> </ul>

**Table 5-2 Computer Setup—Security (continued)**

Option	Description
	Local user control - a prompt will appear to request user confirmation if recovery is necessary.
	Recover in the event of corruption - automatically recover with no prompting.
<b>System Management Command</b>	Allows authorized personnel to reset security settings during a service event. Default is enabled.
<b>Restore Security Settings to Default</b>	This action resets security devices, clears BIOS passwords (not including DriveLock), and restores settings in the <b>Security menu</b> to factory defaults.

## Computer Setup—Advanced



**NOTE:** Support for specific Computer Setup options may vary depending on the hardware configuration.

**Table 5-3 Computer Setup—Advanced (for advanced users)**

Option	Heading
<b>Display Language</b>	Lets you select the language of the menus in F10 Setup and the keyboard layout.
<b>Scheduled Power-On</b>	This feature wakes the system up from a powered off state at a specified date and time.
<b>Boot Options</b>	<p>Select the devices that the computer can boot from, as well as other options, including:</p> <ul style="list-style-type: none"> <li>• Startup Menu Delay(sec). Enabling this feature will add a user-specified delay to the POST process. One purpose for the delay is to provide additional time to activate hotkeys such as <b>Esc</b> for the Startup Menu or <b>F10</b> for Computer Setup.</li> <li>• Fast Boot. Default is enabled.</li> <li>• CD-ROM Boot. Default is enabled.</li> <li>• USB Storage Boot. Default is enabled.</li> <li>• Network (PXE) Boot. Default is enabled.</li> <li>• After Power Loss. Default is Power Off. <ul style="list-style-type: none"> <li>■ Power off—causes the computer to remain powered off when power is restored.</li> <li>■ Power on—causes the computer to power on automatically as soon as power is restored.</li> <li>■ Previous state—causes the computer to power on automatically as soon as power is restored, if it was on when power was lost.</li> </ul> </li> </ul> <p><b>NOTE:</b> If the system is configured to 'Power On from Keyboard Ports' (see Power Management Options), then this setting is forced to 'Power On'.</p> <ul style="list-style-type: none"> <li>• Audio Alerts During Boot. Default is enabled. When disabled, most audible beeps from errors, warnings, and password prompts during boot up are suppressed.</li> <li>• Prompt on Memory Size Change. Default is enabled.</li> <li>• Prompt on Fixed Storage Change. Default is disabled.</li> <li>• UEFI Boot Order. <p>Default is enabled. Specify the order in which UEFI boot sources (such as a internal hard drive, USB hard drive, USB optical drive, or internal optical drive) are checked for a bootable operating system image.</p> <p>UEFI boot sources always have precedence over legacy boot sources.</p> </li> </ul>



**Table 5-3 Computer Setup—Advanced (for advanced users) (continued)**

<b>Option</b>	<b>Heading</b>
<b>HP Sure Recover</b>	Provides the ability to automatically recover the operating system from a local recovery partition or from the network.
<b>Recovery from Network</b>	Allows network recovery as the primary source.
<b>Recover after Boot Failure</b>	Allows the system to initiate recovery after failing to find a valid boot source.
<b>Secure Boot Configuration</b>	<p><b>Configure Legacy Support and Secure Boot</b></p> <p>Lets you turn off all legacy support on the computer, including booting to DOS, running legacy graphics cards, booting to legacy devices, and so on.</p> <p>Lets you make sure an operating system is legitimate before booting to it, making Windows resistant to malicious modification from preboot to full OS booting, preventing firmware attacks. UEFI and Windows Secure Boot only allow code signed by pre-approved digital certificates to run during the firmware and OS boot process.</p> <ul style="list-style-type: none"><li>• Legacy Support Enable and Secure Boot Disable</li><li>• Legacy Support Disable and Secure Boot Enable</li><li>• Legacy Support Disable and Secure Boot Disable</li></ul> <p>Default is 'Legacy Support Disable and Secure Boot Disable'.</p> <p><b>Secure Boot Key Management</b></p> <p>Lets you manage the custom key settings.</p> <p><b>Import Custom Secure Boot keys</b></p> <p>Default is disabled.</p> <p><b>Clear Secure Boot Keys</b></p> <p>Lets you delete any previously loaded custom boot keys. Clearing keys will disable secure boot. Default is disabled.</p> <p><b>Reset Secure Boot keys to factory defaults</b></p> <p>Default is disabled.</p> <p><b>Enable MS UEFI CA key</b></p> <p>Disabling this setting alters the Secure Boot key list to further restrict the allowed software components. Set this option to 'disable' to support Device Guard.</p>
<b>System Options</b>	<p><b>Turbo boost</b></p> <p>Intel Turbo Boost Technology (TBT) automatically allows processor cores to run faster than the base operating frequency if it is operating below power, current, and temperature specification limits. Default is enabled.</p> <p><b>Hyperthreading</b> (enable/disable)</p> <p>Delivers two logical processors that can execute multiple tasks simultaneously using the shared hardware resources of a single processor core. Default is enabled.</p> <p><b>Multi-processor</b></p> <p>Use this option to disable multi-processor support under the operating system. Default is enabled.</p> <p><b>Virtualization Technology (VTx)</b> (Intel only)</p> <p>Controls the virtualization features of the processor. Changing this setting requires turning the computer off and then back on. Default is disabled.</p> <p><b>Virtualization Technology for Directed I/O (VTd)</b> (Intel only)</p>

**Table 5-3 Computer Setup—Advanced (for advanced users) (continued)**

Option	Heading
	<p>Controls virtualization DMA remapping features of the chipset. Changing this setting requires turning the computer off and then back on. Default is disabled.</p> <p><b>PCI Express Slot x</b> (enable/disable)</p> <p>Lets you disable individual expansion slots. Default is enabled.</p> <p><b>M.2 SSD</b></p> <p>Lets you disable the M.2 solid-state drive slot. Default is enabled.</p> <p><b>Allow PCIe/PCI SERR# Interrupt</b> (enable/disable)</p> <p>Allows PCI devices to report PCI/PCIe System Error signals, such as address parity errors, data parity errors, and critical errors other than parity. Default is enabled.</p> <p><b>Power Button Override</b> (disable/4 sec/15 sec/30 sec)</p> <p>Lets you disable or enable and select the number of seconds you have to hold down the power button for it to force the system to power off. Default is '4 sec'.</p> <p><b>USB Type-C Connector System Software Interface (UCSI)</b></p> <p>Select to enable communication of Type-C status and event notification to the operating system</p>
<b>Built-In Device Options</b>	<p><b>Embedded LAN Controller</b></p> <p>Select to show the device in the operating system. Default is enabled.</p> <p><b>Wake On LAN</b></p> <p>Lets you either disable the Wake On LAN feature, or configure where the computer boots, including the network or hard drive. Default is Boot to Network.</p> <p><b>Dust Filter</b></p> <p>Select to enable the Dust Filter replacement reminder, which can be set for 15, 30, 60, 90, 120, or 180 days. The reminder will show during POST after the reminder timer has expired.</p> <p><b>Video Memory Size</b></p> <p>Use this option to manage graphics memory allocation. The value you choose is allocated permanently to graphics and is unavailable to the operating system.</p> <p><b>Audio Device</b></p> <p>Select to show the device in the operating system. Default is enabled.</p> <p><b>Microphone</b></p> <p>Clear to disable microphone inputs to the audio subsystem. Default is enabled.</p> <p><b>Internal Speakers</b> (does not affect external speakers)</p> <p>Clear to disable the chassis speaker or speakers. This function is applicable to normal audio playback in the operating system and does not affect the error or warning beeps during POST. Default is enabled.</p> <p><b>Increase Idle Fan Speed(%)</b></p> <p>Sets idle fan speed percentage. This setting only changes the minimum fan speed. The fan is still automatically controlled.</p> <p><b>M.2 WLAN/BT</b></p> <p>Lets you disable the wireless module slot. Default is enabled.</p> <p><b>LAN/WLAN Auto Switching</b></p> <p>Select to enable control of WLAN function based on wired network connection status.</p>

**Table 5-3 Computer Setup—Advanced (for advanced users) (continued)**

Option	Heading
	<b>Wake on WLAN</b> Select to enable the WLAN device to wake the system from suspend states.
<b>Port Options</b>	Lets you disable the following ports (default is enabled):  Serial Port A (rear port optional component)  SATA 0  Front USB ports - front USB port 1 is the USB Type-C port.  Rear USB ports  USB Legacy Port Charging - enables USB charging port capability when the system is in hibernate or shutdown state. Supported by the right front USB port.  Rear USB Type-C Downstream Charging - enables USB charging port capability when the system is in hibernate or shutdown state. Rear panel optional component.  Front USB Type-C Downstream Charging - enables USB charging port capability when the system is in hibernate or shutdown state.
<b>Option ROM Launch Policy</b>	These policies control whether Legacy Option ROMs or UEFI drivers are loaded. Default is 'All UEFI' for Windows 10 or later.  <b>Configure Option ROM Launch Policy</b> <ul style="list-style-type: none"><li>• All legacy</li><li>• All UEFI</li><li>• All UEFI except video</li></ul>
<b>Power Management Options</b>	<b>Runtime Power Management</b> (enable/disable) Allows certain operating systems to reduce processor voltage and frequency when the current software load does not require the full capabilities of the processor. Default is enabled.  <b>Extended Idle Power States</b> (enable/disable) Allows certain operating systems to decrease the processors power consumption when the processor is idle. Default is enabled.  <b>S5 Maximum Power Savings</b> (enable/disable) Enabling this feature reduces the power of the system as much as possible in the S5 state. Power is removed from the wake up circuitry, the expansion slots, and any management features while in S5. Default is disabled.  <b>SATA Power Management</b> (enable/disable) Enables or disables SATA bus and/or device power management. Default is enabled.  <b>PCI Express Power Management</b> (enable/disable) Enabling this option permits the PCI Express links to use Active Power State Management (ASPM) to enter lower power states while not in use. Default is enabled.  <b>Unique Sleep State Blink Rates</b> (enable/disable) This feature is designed to provide a visual indication of what sleep state the system is in. Each sleep state has a unique blink pattern. Default is disabled.  <b>NOTE:</b> A normal shutdown goes to the S4 state for Windows 10 or later.  S0 (On) = Solid white LED.  S3 (Stand By)= 3 blinks at 1Hz (50% duty cycle) followed by a pause of 2 seconds (white LED) — repeated cycles of 3 blinks and a pause.

**Table 5-3 Computer Setup—Advanced (for advanced users) (continued)**

Option	Heading
	S4 (Hibernation)= 4 blinks at 1Hz (50% duty cycle) followed by a pause of 2 seconds (white LED) — repeated cycles of 4 blinks and a pause.
	S5 (Soft Off) = LED is off.
	<b>Power On from Keyboard Ports</b> (enable/disable)
	When enabled, this feature allows a key press to power on the system when it is off (S5 state). If using a USB keyboard, it must be plugged into one of the rear ports labeled with the keyboard icon. Default is disabled.

## Computer Setup—UEFI Drivers

Lets you restart the computer into the 3rd Party Option ROM Management application. You can start this application directly by pressing **F3** during startup.

## Recovering the Configuration Settings

This method of recovery requires that you first perform the **Save to Removable Media** command with the Computer Setup (F10) Utility before **Restore** is needed. (See [Computer Setup—Main on page 43](#) in the Computer Setup—File table.)

The **Save to Removable Media** option creates a file named HPSETUP.TXT on an inserted USB flash media device. This file can be edited to change the settings on Restore. An asterisk (\*) marks the selected option for a setting.



**NOTE:** It is recommended that you save any modified computer configuration settings to a USB flash media device and save the device for possible future use.

To restore the configuration, insert the USB flash media device with the saved configuration and perform the **Restore from Removable Media** command with the Computer Setup (F10) Utility. (See [Computer Setup—Main on page 43](#) in the Computer Setup—File table.)

---

## 6 Troubleshooting without diagnostics

This chapter provides information on how to identify and correct minor problems, such as USB devices, hard drive, optical drive, graphics, audio, memory, and software problems. If you encounter problems with the computer, refer to the tables in this chapter for probable causes and recommended solutions.

 **NOTE:** For information on specific error messages that may appear on the screen during Power-On Self-Test (POST) at startup, refer to [POST error messages and diagnostic front panel LEDs and audible codes on page 78](#).

---

### Safety and comfort

 **WARNING!** Misuse of the computer or failure to establish a safe and comfortable work environment may result in discomfort or serious injury. Refer to the *Safety & Comfort Guide* at <http://www.hp.com/ergo> for more information on choosing a workspace and creating a safe and comfortable work environment. For more information, refer to the *Safety & Regulatory Information guide*.

---

### Before you call for technical support

If you are having problems with the computer, try the appropriate solutions below to try to isolate the exact problem before calling for technical support.

- Run the HP diagnostic tool.
- Run the hard drive self-test in Computer Setup. Refer to [Computer Setup \(F10\) Utility on page 41](#) for more information.
- Check the Power LED on the front of the computer to see if it is flashing red. The flashing lights are error codes that will help you diagnose the problem. Refer to [POST error messages and diagnostic front panel LEDs and audible codes on page 78](#) for more information.
- If the screen is blank, plug the monitor into a different video port on the computer if one is available. Or, replace the monitor with a monitor that you know is functioning properly.
- If you are working on a network, plug another computer with a different cable into the network connection. There may be a problem with the network plug or cable.
- If you recently added new hardware, remove the hardware and see if the computer functions properly.
- If you recently installed new software, uninstall the software and see if the computer functions properly.
- Boot the computer to the Safe Mode to see if it will boot without all of the drivers loaded. When booting the operating system, use “Last Known Configuration.”
- Refer to the comprehensive online technical support at <http://www.hp.com/support>.
- Refer to [Helpful hints on page 54](#) in this guide.

To assist you in resolving problems online, HP Instant Support Professional Edition provides you with self-solve diagnostics. If you need to contact HP support, use HP Instant Support Professional Edition's online chat feature. Access HP Instant Support Professional Edition at: <http://www.hp.com/go/ispe>.

Access the Business Support Center (BSC) at <http://www.hp.com/go/bizsupport> for the latest online support information, software and drivers, proactive notification, and worldwide community of peers and HP experts.

If it becomes necessary to call for technical assistance, be prepared to do the following to ensure that your service call is handled properly:

- Be in front of your computer when you call.
- Write down the computer serial number, product ID number, and monitor serial number before calling.
- Spend time troubleshooting the problem with the service technician.
- Remove any hardware that was recently added to your system.
- Remove any software that was recently installed.
- Restore the system from the Recovery Disc Set that you created or restore the system to its original factory condition in System Software Requirement Disks (SSRD).

---

 **CAUTION:** Restoring the system will erase all data on the hard drive. Be sure to back up all data files before running the restore process.

 **NOTE:** For sales information and warranty upgrades (Care Packs), call your local authorized service provider or dealer.

---

## Helpful hints

If you encounter problems with the computer, monitor, or software, see the following list of general suggestions before taking further action:

- Check that the computer and monitor are plugged into a working electrical outlet.
- Check that the voltage select switch (some models) is set to the appropriate voltage for your region (115V or 230V).
- Check that the computer is turned on and the white power light is on.
- Check that the monitor is turned on and the green monitor light is on.
- Check the Power LED on the front of the computer to see if it is flashing red. The flashing lights are error codes that will help you diagnose the problem. Refer to [POST error messages and diagnostic front panel LEDs and audible codes on page 78](#) for more information.
- Turn up the brightness and contrast controls of the monitor if the monitor is dim.
- Press and hold any key. If the system beeps, then the keyboard should be operating correctly.
- Check all cable connections for loose connections or incorrect connections.
- Wake the computer by pressing any key on the keyboard or pressing the power button. If the system remains in suspend mode, shut down the computer by pressing and holding the power button for at least four seconds then press the power button again to restart the computer. If the system will not shut down, unplug the power cord, wait a few seconds, then plug it in again. The computer will restart if it is set to power on automatically as soon as power is restored in Computer Setup. If it does not restart, press the power button to start the computer.
- Reconfigure the computer after installing a non-plug and play expansion board or other option. See [Solving hardware installation problems on page 70](#) for instructions.
- Be sure that all the needed device drivers have been installed. For example, if you are using a printer, you need a driver for that model printer.
- Remove all bootable media (CD/DVD or USB device) from the system before turning it on.

- If you have installed an operating system other than the factory-installed operating system, check to be sure that it is supported on the system.
- If the system has multiple video sources (embedded, PCI, or PCI-Express adapters) installed (embedded video on some models only) and a single monitor, the monitor must be plugged into the monitor connector on the source selected as the primary VGA adapter. During boot, the other monitor connectors are disabled and if the monitor is connected into these ports, the monitor will not function. You can select which source will be the default VGA source in Computer Setup.

**CAUTION:** When the computer is plugged into an AC power source, there is always voltage applied to the system board. You must disconnect the power cord from the power source before opening the computer to prevent system board or component damage.

## Solving general problems

You may be able to easily resolve the general problems described in this section. If a problem persists and you are unable to resolve it yourself or if you feel uncomfortable about performing the operation, contact an authorized dealer or reseller.

**WARNING:** When the computer is plugged into an AC power source, voltage is always applied to the system board. To reduce the risk of personal injury from electrical shock and/or hot surfaces, be sure to disconnect the power cord from the wall outlet and allow the internal system components to cool before touching.

### Cannot access the Computer Setup (F10) Utility when booting the computer.

Cause	Solution
The Computer Setup (F10) Utility is set to “fast boot” causing the F10 access screen to display too briefly when booting the computer.	<p>Before turning on the computer, press and hold <b>F10</b>. Turn on the computer and continue to hold <b>F10</b> until the Computer Setup (F10) Utility is displayed.</p> <p>- or -</p> <p>Follow the Windows instructions for rebooting the computer into the Computer Setup (F10) Utility.</p>

### Computer appears locked up and will not turn off when the power button is pressed.

Cause	Solution
Software control of the power switch is not functional.	<ol style="list-style-type: none"> <li>1. Press and hold the power button for at least four seconds until the computer turns off.</li> <li>2. Disconnect the power cord from the electrical outlet.</li> </ol>

### Computer will not respond to keyboard or mouse.

Cause	Solution
Computer is in Sleep state.	<p>To resume from Sleep state, press the power button.</p> <p><b>CAUTION:</b> When attempting to resume from Sleep state, do not hold down the power button for more than four seconds. Otherwise, the computer will shut down and you will lose any unsaved data.</p>
System has locked up.	Restart computer.

### Computer date and time display is incorrect.

Cause	Solution
RTC (real-time clock) battery may need to be replaced. <b>NOTE:</b> Connecting the computer to a live AC outlet prolongs the life of the RTC battery.	Reset the date and time under <b>Control Panel</b> (Computer Setup can also be used to update the RTC date and time). If the problem persists, replace the RTC battery. See the Removal and Replacement section for instructions on installing a new battery, or contact an authorized dealer or reseller for RTC battery replacement.  To access Control Panel in Windows 10, type <code>control panel</code> in the taskbar search box, and then select Control Panel.

### There is no sound or sound volume is too low.

Cause	Solution
System volume may be set low or muted.	<ol style="list-style-type: none"><li>1. Check the Computer Setup settings to make sure the internal system speaker is not muted (this setting does not affect the external speakers).</li><li>2. Make sure the external speakers are properly connected and powered on and that the speakers' volume control is set correctly.</li><li>3. Use the system volume control available in the operating system to make sure the speakers are not muted or to increase the volume.</li></ol>

### Cannot remove computer cover or access panel.

Cause	Solution
Smart Cover Lock, featured on some computers, is locked.	Unlock the Smart Cover Lock using Computer Setup.  In case of forgotten password, power loss, or computer malfunction, you must manually disable the Smart Cover lock . A key to unlock the Smart Cover Lock is not available from HP. Keys are typically available from a hardware store.

### Poor performance.

Cause	Solution
Processor is too hot.	<ol style="list-style-type: none"><li>1. Make sure airflow to the computer is not blocked. Leave a 10.2-cm (4-inch) clearance on all vented sides of the computer and above the monitor to permit the required airflow.</li><li>2. Make sure fans are connected and working properly (some fans only operate when needed).</li><li>3. Make sure the processor heat sink is installed properly.</li></ol>
Hard drive is full.	Transfer data from the hard drive to create more space on the hard drive.
Low on memory.	Add more memory.



**Poor performance.**

<b>Cause</b>	<b>Solution</b>
Hard drive fragmented.	Defragment hard drive.
Program previously accessed did not release reserved memory back to the system.	Restart the computer.
Virus resident on the hard drive.	Run virus protection program.
Too many applications running.	<ol style="list-style-type: none"><li>1. Close unnecessary applications to free up memory.</li><li>2. Add more memory.</li><li>3. Some applications run in the background and can be closed by right-clicking on their corresponding icons in the task tray. To prevent these applications from launching at startup:  In Windows 10:<ol style="list-style-type: none"><li>a. Type <code>msconfig</code> in the taskbar search box, and then select <b>msconfig</b>.</li><li>b. On the <b>Startup</b> tab of the System Configuration Utility, click <b>Open Task Manager</b>.</li><li>c. Select applications that you do not want to launch automatically, and the click <b>Disable</b>.</li></ol></li></ol>
Some software applications, especially games, are stressful on the graphics subsystem.	<ol style="list-style-type: none"><li>1. Lower the display resolution for the current application or consult the documentation that came with the application for suggestions on how to improve performance by adjusting parameters in the application.</li><li>2. Add more memory.</li><li>3. Upgrade the graphics solution.</li></ol>
Cause unknown.	Restart the computer.

**Computer powered off automatically and the Power LED flashes red four times and then white two times.**

<b>Cause</b>	<b>Solution</b>
Processor thermal protection activated: A fan may be blocked or not turning. OR The heat sink is not properly attached to the processor.	<ol style="list-style-type: none"><li>1. Ensure that the computer air vents are not blocked and the processor cooling fan is running.</li><li>2. Open the access panel, press the power button, and see if the processor fan (or other system fan) spins. If the fan does not spin, make sure the fan cable is plugged onto the system board header.</li><li>3. If fan a plugged in and not spinning, replace it.</li></ol>

**System does not power on and the LEDs on the front of the computer are not flashing.**

<b>Cause</b>	<b>Solution</b>
System unable to power on.	Press and hold the power button for less than 4 seconds. If the hard drive LED turns white, then:

**System does not power on and the LEDs on the front of the computer are not flashing.**

Cause	Solution
	<ol style="list-style-type: none"><li>1. If equipped with a voltage selector, check that the voltage selector (located on the rear of the power supply) is set to the appropriate voltage. Proper voltage setting depends on your region.</li><li>2. Remove the expansion cards one at a time until the 5V_aux light on the system board turns on.</li><li>3. Replace the system board.</li></ol>
	OR
	Press and hold the power button for less than 4 seconds. If the hard drive LED does not turn on white then:
	<ol style="list-style-type: none"><li>1. Check that the unit is plugged into a working AC outlet.</li><li>2. Open the access panel and check that the power button cable is properly connected to the system board.</li><li>3. Check that the power supply cables are properly connected to the system board.</li><li>4. Check to see if the 5V_aux light on the system board is turned on. If it is turned on, then replace the power button assembly.</li><li>5. If the 5V_aux light on the system board is off, then replace the power supply.</li><li>6. Replace the system board.</li></ol>

## Solving power problems

Common causes and solutions for power problems are listed in the following table.

**Power supply shuts down intermittently.**

Cause	Solution
If equipped with a voltage selector, voltage selector switch on rear of computer chassis (some models) not switched to correct line voltage (115V or 230V).	Select the proper AC voltage using the selector switch.
Power supply will not turn on because of internal power supply fault.	Replace the power supply.

**Computer powered off automatically and the Power LED flashes Red two times, once every second, followed by a two second pause, and the computer beeps two times. (Beeps stop after fifth iteration but LEDs continue flashing.)**

**Computer powered off automatically and the Power LED flashes red four times and then white two times.**

Cause	Solution
Processor thermal protection activated: A fan may be blocked or not turning.	<ol style="list-style-type: none"><li>1. Ensure that the computer air vents are not blocked and the processor cooling fan is running.</li><li>2. Open the access panel, press the power button, and see if the processor fan (or other system fan) spins. If the fan does</li></ol>
OR	

**Computer powered off automatically and the Power LED flashes Red two times, once every second, followed by a two second pause, and the computer beeps two times. (Beeps stop after fifth iteration but LEDs continue flashing.)**

**Computer powered off automatically and the Power LED flashes red four times and then white two times.**

Cause	Solution
The heat sink is not properly attached to the processor.	not spin, make sure the fan cable is plugged onto the system board header.
	3. If fan a plugged in and not spinning, replace it.

## Solving hard drive problems

**Hard drive error occurs.**

Cause	Solution
Hard disk has bad sectors or has failed.	<ol style="list-style-type: none"><li>1. In Windows 10, type <code>file</code> in the taskbar search box, and then select <b>File Explorer</b> from the list of applications. In the left column, expand <b>This PC</b>, right-click on a drive, select <b>Properties</b>, and then select the <b>Tools</b> tab. Under <b>Error checking</b> click <b>Check</b>.</li><li>2. Use a utility to locate and block usage of bad sectors. If necessary, reformat the hard disk.</li></ol>

**Disk transaction problem.**

Cause	Solution
Either the directory structure is bad or there is a problem with a file.	In Windows 10, type <code>file</code> in the taskbar search box, and then select <b>File Explorer</b> from the list of applications. In the left column, expand <b>This PC</b> , right-click on a drive, select <b>Properties</b> , and then select the <b>Tools</b> tab. Under <b>Error checking</b> click <b>Check</b> .

**Drive not found (identified).**

Cause	Solution
Cable could be loose.	Check cable connections.
The system may not have automatically recognized a newly installed device.	See reconfiguration directions in the <a href="#">Solving hardware installation problems on page 70</a> section. If the system still does not recognize the new device, check to see if the device is listed within Computer Setup. If it is listed, the probable cause is a driver problem. If it is not listed, the probable cause is a hardware problem.  If this is a newly installed drive, run the Computer Setup utility and try adding a POST delay under <b>Advanced &gt; Boot Options</b> .
The device is attached to a SATA port that has been hidden in Computer Setup.	Run the Computer Setup utility and ensure <b>Device Available</b> is selected for the device's SATA port in <b>Advanced &gt; Port Options</b> .
Drive responds slowly immediately after power-up.	Run Computer Setup and increase the POST Delay in <b>Advanced &gt; Boot Options</b> .

### Nonsystem disk/NTLDR missing message.

Cause	Solution
The system is trying to start from the hard drive but the hard drive may have been damaged.	▲ Perform Drive Protection System (DPS) testing in system ROM.
System files missing or not properly installed.	<ol style="list-style-type: none"><li>1. Insert bootable media and restart the computer.</li><li>2. Boot to the windows installation media and select the recovery option. If only a restore kit is available, then select the <b>File Backup Program</b> option, and then restore the system.</li><li>3. Install system files for the appropriate operating system.</li></ol>
Hard drive boot has been disabled in Computer Setup.	Run the Computer Setup utility and enable the hard drive entry in the <b>Advanced &gt; Boot Options</b> list.
Bootable hard drive is not attached as first in a multi-hard drive configuration.	If attempting to boot from a hard drive, ensure it is attached to the system board dark blue SATA connector.
Bootable hard drive is not listed first in the Boot Order.	Run the Computer Setup utility and select <b>Advanced &gt; Boot Options</b> and ensure the bootable hard drive is listed immediately under the <b>Hard Drive</b> entry.

### Computer will not boot from hard drive.

Cause	Solution
The device is attached to a SATA port that has been hidden in Computer Setup.	<ol style="list-style-type: none"><li>1. Check SATA cable connections.</li><li>2. Run the Computer Setup utility and ensure <b>Device Available</b> is selected for the device's SATA port in <b>Advanced &gt; Port Options</b>.</li></ol>
Boot order is not correct.	Run the Computer Setup utility and change boot sequence in <b>Advanced &gt; Boot Options</b> .
Hard drive is damaged.	Observe if the front panel Power LED is blinking RED and if any beeps are heard. See <a href="#">POST error messages and diagnostic front panel LEDs and audible codes on page 78</a> to determine possible causes for the blinking red and beep codes.  See the Worldwide Limited Warranty for terms and conditions.

### Computer seems to be locked up.

Cause	Solution
Program in use has stopped responding to commands.	<ol style="list-style-type: none"><li>1. Use the task manager to close programs that do not respond.</li><li>2. Attempt the normal Windows "Shut Down" procedure. If this fails, press the power button for four or more seconds to turn off the power. To restart the computer, press the power button again.</li></ol>

# Solving media card reader problems

## Media card will not work in a digital camera after formatting it in Windows.

Cause	Solution
By default, Windows will format any media card with a capacity greater than 32MB with the FAT32 format. Some digital cameras use the FAT (FAT16 & FAT12) format and can not operate with a FAT32 formatted card.	Either format the media card in the digital camera or select FAT file system to format the media card in a computer with Windows.

## A write-protected or locked error occurs when attempting to write to the media card.

Cause	Solution
Media card is locked. Locking the media card is a safety feature that prevents writing to and deleting from an SD/Memory Stick/PRO card.	If using an SD card, make sure that the lock tab located on the right of the SD card is not in the locked position. If using a Memory Stick/PRO card, make sure that the lock tab located on the bottom of the Memory Stick/PRO card is not in the locked position.

## Can not write to the media card.

Cause	Solution
The media card is a read-only memory (ROM) card.	Check the manufacturer's documentation included with your card to see if it writable. Refer to the previous section for a list of compatible cards.
Media card is locked. Locking the media card is a safety feature that prevents writing to and deleting from an SD/Memory Stick/PRO card.	If using an SD card, make sure that the lock tab located on the right of the SD card is not in the locked position. If using a Memory Stick/PRO card, make sure that the lock tab located on the bottom of the Memory Stick/PRO card is not in the locked position.

## Unable to access data on the media card after inserting it into a slot.

Cause	Solution
The media card is not inserted properly, is inserted in the wrong slot, or is not supported.	Ensure that the card is inserted properly with the gold contact on the correct side. The green LED will light if inserted properly.

## Do not know how to remove a media card correctly.

Cause	Solution
The computer's software is used to safely eject the card.	In Windows 10, type <code>File</code> in the taskbar search box, and then select <b>File Explorer</b> from the list of applications. In the left column, expand <b>This PC</b> , right-click on the corresponding drive icon, and then select <b>Eject</b> . Pull the card out of the slot. <b>NOTE:</b> Never remove the card when the green LED is flashing

**After installing the media card reader and booting to Windows, the reader and the inserted cards are not recognized by the computer.**

Cause	Solution
The operating system needs time to recognize the device if the reader was just installed into the computer and you are turning the PC on for the first time.	Wait a few seconds so that the operating system can recognize the reader and the available ports, and then recognize the media inserted in the reader.

**After inserting a media card in the reader, the computer attempts to boot from the media card.**

Cause	Solution
The inserted media card has boot capability.	<ol style="list-style-type: none"><li>1. If you do not want to boot from the media card, remove it during boot or do not select the option to boot from the inserted media card during the boot process.</li><li>2. During POST (Power On Self-Test), press <b>F9</b> to modify the boot menu.</li><li>3. Change the boot sequence in F10 Computer Setup.</li></ol>

## Solving display problems

If you encounter display problems, see the documentation that came with the monitor and to the common causes and solutions listed in the following table.

**Blank screen (no video).**

Cause	Solution
Monitor is not turned on and the monitor light is not on.	Turn on the monitor and check that the monitor light is on.
Bad monitor.	Try a different monitor.
The cable connections are not correct.	Check the cable connection from the monitor to the computer and to the electrical outlet.
You may have a screen blanking utility installed or energy saver features are enabled.	Press any key or click the mouse button and type your password (if set).
System ROM is corrupted; system is running in Boot Block Emergency Recovery Mode (indicated by eight beeps).	Reflash the system ROM with the latest BIOS image.
You are using a fixed-sync monitor and it will not sync at the resolution chosen.	Be sure that the monitor can accept the same horizontal scan rate as the resolution chosen.
Computer is in Sleep state.	Press the power button to resume from Sleep state.  <b>CAUTION:</b> When attempting to resume from Sleep state, do not hold down the power button for more than four seconds. Otherwise, the computer will shut down and you will lose any unsaved data.
Monitor settings in the computer are not compatible with the monitor.	<ol style="list-style-type: none"><li>1. In Control Panel, select <b>Category</b> from the <b>View by</b> list, then under <b>Appearance and Personalization</b>, select <b>Adjust screen resolution</b>.  To access Control Panel in Windows 10, type <code>control panel</code> in the taskbar search box, and then select <b>Control Panel</b> from the list of applications.</li></ol>

**Blank screen (no video).**

Cause	Solution
	<ol style="list-style-type: none"><li>Expand the <b>Resolution</b> box, and then use the sliding control to reset the resolution.</li></ol>
Monitor is configured to use an input that is not active.	Use the monitor's on-screen menu controls to select the input that is being driven by the system. Refer to the monitor's user documentation for more information on the on-screen controls and settings.

**Blank screen and the power LED flashes Red five times, once every second, followed by a two second pause, and the computer beeps five times. (Beeps stop after fifth iteration but LEDs continue flashing.)**

Cause	Solution
Pre-video memory error.	<ol style="list-style-type: none"><li>Reseat DIMMs. Power on the system.</li><li>Replace DIMMs one at a time to isolate the faulty module.</li><li>Replace third-party memory with HP memory.</li><li>Replace the system board.</li></ol>

**Blank screen and the power LED flashes Red six times, once every second, followed by a two second pause, and the computer beeps six times. (Beeps stop after fifth iteration but LEDs continue flashing.)**

Cause	Solution
Pre-video graphics error.	For systems with a graphics card: <ol style="list-style-type: none"><li>Reseat the graphics card (if applicable). Power on the system.</li><li>Replace the graphics card (if applicable).</li><li>Replace the system board.</li></ol> For systems with integrated graphics, replace the system board.

**Blank screen and the power LED flashes Red seven times, once every second, followed by a two second pause, and the computer beeps seven times. (Beeps stop after fifth iteration but LEDs continue flashing.)**

Cause	Solution
System board failure (ROM detected failure prior to video).	Replace the system board.

**Monitor does not function properly when used with energy saver features.**

Cause	Solution
Monitor without energy saver capabilities is being used with energy saver features enabled.	Disable monitor energy saver feature.

**Dim characters.**

Cause	Solution
The brightness and contrast controls are not set properly.	Adjust the monitor brightness and contrast controls.
Cables are not properly connected.	Check that the graphics cable is securely connected to the graphics card (if applicable) or video connector and the monitor.

**Blurry video or requested resolution cannot be set.**

Cause	Solution
If the graphics controller was upgraded, the correct graphics drivers may not be loaded.	Install the video drivers included in the upgrade kit.
Monitor is not capable of displaying requested resolution.	Change requested resolution.
Graphics card is bad.	Replace the graphics card.

**The picture is broken up, rolls, jitters, or flashes.**

Cause	Solution
The monitor connections may be incomplete or the monitor may be incorrectly adjusted.	<ol style="list-style-type: none"><li>1. Be sure the monitor cable is securely connected to the computer.</li><li>2. In a two-monitor system or if another monitor is in close proximity, be sure the monitors are not interfering with each other's electromagnetic field by moving them apart.</li><li>3. Fluorescent lights or fans may be too close to the monitor.</li></ol>
Monitor needs to be degaussed.	Degauss the monitor. Refer to the documentation that came with the monitor for instructions.

**Image is not centered.**

Cause	Solution
Position may need adjustment.	Press the monitor's Menu button to access the OSD menu. Select <b>Image Control/ Horizontal Position</b> or <b>Vertical Position</b> to adjust the horizontal or vertical position of the image.

**"No Connection, Check Signal Cable" displays on screen.**

Cause	Solution
Monitor video cable is disconnected.	Connect the video cable between the monitor and computer. <b>CAUTION:</b> Ensure that the computer power is off while connecting the video cable.



**“Out of Range” displays on screen.**

Cause	Solution
Video resolution and refresh rate are set higher than what the monitor supports.	Restart the computer and enter Safe Mode. Change the settings to a supported setting then restart the computer so that the new settings take effect.  To enter Safe Mode in Windows 10: <ol style="list-style-type: none"><li>1. Log into the computer using an Administrator account.</li><li>2. Type <code>msconfig</code> in the taskbar search box, and then select <b>msconfig</b> from the list of applications.</li><li>3. Click the <b>Boot</b> tab, select <b>Safe boot</b> and then click <b>OK</b>.</li></ol>

**High pitched noise coming from inside a flat panel monitor.**

Cause	Solution
Brightness and/or contrast settings are too high.	Lower brightness and/or contrast settings.

**Fuzzy focus; streaking, ghosting, or shadowing effects; horizontal scrolling lines; faint vertical bars; or unable to center the picture on the screen (flat panel monitors using an analog VGA input connection only).**

Cause	Solution
Flat panel monitor's internal digital conversion circuits may be unable to correctly interpret the output synchronization of the graphics card.	<ol style="list-style-type: none"><li>1. Select the monitor's Auto-Adjustment option in the monitor's on-screen display menu.</li><li>2. Manually synchronize the Clock and Clock Phase on-screen display functions. To download a SoftPaq that will assist you with the synchronization, go to the following Web site, select the appropriate monitor, and download either SP32347 or SP32202: <a href="http://www.hp.com/support">http://www.hp.com/support</a></li></ol>
Graphics card is not seated properly or is bad (some models).	<ol style="list-style-type: none"><li>1. Reseat the graphics card.</li><li>2. Replace the graphics card.</li></ol>

**Certain typed symbols do not appear correct.**

Cause	Solution
The font you are using does not support that particular symbol.	Use the Character Map to locate and select the appropriate symbol. You can copy the symbol from the Character Map into a document.  In Windows 10, type <code>ch</code> in the taskbar search box, and then select <b>Character Map</b> from the list of applications.

## Solving audio problems

If the computer has audio features and you encounter audio problems, see the common causes and solutions listed in the following table.

### Sound cuts in and out.

Cause	Solution
Processor resources are being used by other open applications.	Shut down all open processor-intensive applications.

### Sound does not come out of the speaker or headphones.

Cause	Solution
Software volume control is turned down or muted.	Double-click the <b>Speaker</b> icon on the taskbar, then make sure that <b>Mute</b> is not selected and use the volume slider to adjust the volume.
Audio is hidden in Computer Setup.	Enable the audio in Computer Setup: <b>Advanced &gt; Built-in Device Options</b> .
The external speakers are not turned on.	Turn on the external speakers.
The audio device may be connected to the wrong jack.	Ensure that the device is connected to the correct jack on the computer. The rear audio jack output is the green receptacle. The speakers should be plugged into the line-out jack and the headphones should be plugged into the headphone jack.
External speakers plugged into the wrong audio jack on a recently installed sound card.	See the sound card documentation for proper speaker connection. The rear audio jack output is the green receptacle.
Headphones or devices connected to the line-out connector mute the internal speaker.	Turn on and use headphones or external speakers, if connected, or disconnect headphones or external speakers.
Computer is in Sleep state.	Press the power button to resume from Sleep state. <b>CAUTION:</b> When attempting to resume from Sleep state, do not hold down the power button for more than four seconds. Otherwise, the computer will shut down and you will lose any unsaved data.
Internal speaker is disabled in Computer Setup.	Enable the internal speaker in Computer Setup. Select <b>Advanced &gt; Built-in Device Options</b> .
The application is set to use a different audio device than speakers.	Some graphics cards support audio over the DisplayPort connection (if applicable), so multiple audio devices may be listed in Device Manager. Make sure the correct device is being used.  To access Device Manager in Windows 10, type <code>device manager</code> in the taskbar search box, and then select <b>Device Manager</b> from the list of applications.
Some applications can select which audio output device is used.	Make sure the application has selected the correct audio device.
The operating system controls may be set to use a different audio device as the default output device than what is expected.	Set the operating system to use the correct audio device.

### Sound from headphones is not clear or muffled.

Cause	Solution
Headphones are plugged into the rear audio output connector. The rear audio output connector is for powered audio devices and is not designed for headphone use.	Plug the headphones into the headphone connector on the front of the computer.

### Computer appears to be locked up while recording audio.

Cause	Solution
The hard disk may be full.	Before recording, make sure there is enough free space on the hard disk. You can also try recording the audio file in a compressed format.

### Line-in jack is not functioning properly.

Cause	Solution
Jack has been reconfigured in the audio driver or application software.	In the audio driver or application software, reconfigure the jack or set the jack to its default value.

### There is no sound or sound volume is too low.

Cause	Solution
The application is set to use a different audio device than speakers.	Some graphics cards support audio over the DisplayPort connection (if applicable), so multiple audio devices may be listed in Device Manager. Make sure the correct device is being used.  To access Device Manager in Windows 10, type <code>device manager</code> in the taskbar search box, and then select <b>Device Manager</b> from the list of applications.
Some applications can select which audio output device is used.	Make sure the application has selected the correct audio device.
The operating system controls may be set to use a different audio device as the default output device than what is expected.	Set the operating system to use the correct audio device.

## Solving printer problems

If you encounter printer problems, see the documentation that came with the printer and to the common causes and solutions listed in the following table.

### Printer will not print.

Cause	Solution
Printer is not turned on and online.	Turn the printer on and make sure it is online.
The correct printer drivers for the application are not installed.	<ol style="list-style-type: none"><li>1. Install the correct printer driver for the application.</li><li>2. Try printing using the MS-DOS command: <code>DIR C:\ &gt; [printer port]</code></li></ol>

### Printer will not print.

Cause	Solution
	where [printer port] is the address of the printer being used. If the printer works, reload the printer driver.  To run MS-DOS commands, press the Windows key + r, type cmd in the <b>Open</b> box, and then click <b>OK</b> .
If you are on a network, you may not have made the connection to the printer.	Make the proper network connections to the printer.
Printer may have failed.	Run printer self-test.

### Printer will not turn on.

Cause	Solution
The cables may not be connected properly.	Reconnect all cables and check the power cord and electrical outlet.

### Printer prints garbled information.

Cause	Solution
The correct printer driver for the application is not installed.	Install the correct printer driver for the application.
The cables may not be connected properly.	Reconnect all cables.
Printer memory may be overloaded.	Reset the printer by turning it off for one minute, then turn it back on.

### Printer will not print.

Cause	Solution
The printer may be out of paper.	Check the paper tray and refill it if it is empty.

## Solving keyboard and mouse problems

If you encounter keyboard or mouse problems, see the documentation that came with the equipment and to the common causes and solutions listed in the following table.

### A wireless keyboard/mouse is not working correctly. Symptoms include lagging mouse movement, jumpy mouse/keyboard, or no function of mouse/keyboard and external drive.

Cause	Solution
If your computer is equipped with USB 3.0 ports, connected USB 3.0 devices can interfere with the wireless keyboard USB receiver.	Connect the wireless keyboard USB receiver to a USB 2.0 port that is separated from ports with USB 3.0 devices. If you still experience interference, you may have to place the connectors farther apart using an external USB hub.

### Keyboard commands and typing are not recognized by the computer.

Cause	Solution
Keyboard connector is not properly connected.	Shut down the computer, reconnect the keyboard to the back of the computer, and then restart the computer.
Program in use has stopped responding to commands.	Shut down your computer using the mouse and then restart the computer.
Keyboard needs repairs.	See the Worldwide Limited Warranty for terms and conditions.
Computer is in Sleep state.	Press the power button to resume from Sleep state.  <b>CAUTION:</b> When attempting to resume from Sleep state, do not hold down the power button for more than four seconds. Otherwise, the computer will shut down and you will lose any unsaved data.

### Mouse does not respond to movement or is too slow.

Cause	Solution
Mouse connector is not properly plugged into the back of the computer.	Shut down the computer using the keyboard.  Windows 10: <ol style="list-style-type: none"><li>1. Press the <b>Ctrl</b> and <b>Esc</b> keys at the same time (or press the <b>Windows logo</b> key) to display the <b>Start</b> menu.</li><li>2. Use the <b>arrow</b> keys to scroll to and select the power icon at the top right on the menu, and then press <b>Enter</b>.</li><li>3. Use the <b>arrow</b> keys to select <b>Shut Down</b>, and then press <b>Enter</b>.</li><li>4. After the shutdown is complete, plug the mouse connector into the back of the computer (or the keyboard) and restart.</li></ol>
Program in use has stopped responding to commands.	Shut down the computer using the keyboard then restart the computer.
Mouse may need cleaning.	Remove the roller ball cover on the mouse and clean the internal components.
Mouse may need repair.	See the Worldwide Limited Warranty for terms and conditions.
Computer is in Sleep state.	Press the power button to resume from Sleep state.  <b>CAUTION:</b> When attempting to resume from Sleep state, do not hold down the power button for more than four seconds. Otherwise, the computer will shut down and you will lose any unsaved data.

### Mouse will only move vertically, horizontally, or movement is jerky.

Cause	Solution
Mouse roller ball or the rotating encoder shafts that make contact with the ball are dirty.	Remove roller ball cover from the bottom of the mouse and clean the internal components with a mouse cleaning kit available from most computer stores.

## Solving hardware installation problems

You may need to reconfigure the computer when you add or remove hardware, such as an additional drive or expansion card. If you install a plug and play device, Windows automatically recognizes the device and configures the computer. If you install a non-plug and play device, you must reconfigure the computer after completing installation of the new hardware. In Windows, use the **Add Hardware Wizard** and follow the instructions that appear on the screen.

To open the Add Hardware Wizard, open a Command Prompt and open hdwwiz.exe.

**⚠ WARNING!** When the computer is plugged into an AC power source, voltage is always applied to the system board. To reduce the risk of personal injury from electrical shock and/or hot surfaces, be sure to disconnect the power cord from the wall outlet and allow the internal system components to cool before touching.

### A new device is not recognized as part of the system.

Cause	Solution
Device is not seated or connected properly.	Ensure that the device is properly and securely connected and that pins in the connector are not bent down.
Cable(s) of new external device are loose or power cables are unplugged.	Ensure that all cables are properly and securely connected and that pins in the cable or connector are not bent down.
Power switch of new external device is not turned on.	Turn off the computer, turn on the external device, then turn on the computer to integrate the device with the computer system.
When the system advised you of changes to the configuration, you did not accept them.	Reboot the computer and follow the instructions for accepting the changes.
A plug and play board may not automatically configure when added if the default configuration conflicts with other devices.	Use Windows Device Manager to deselect the automatic settings for the board and choose a basic configuration that does not cause a resource conflict. You can also use Computer Setup to reconfigure or disable devices to resolve the resource conflict.  To access Device Manager in Windows 10, type <code>device manager</code> in the taskbar search box, and then select <b>Device Manager</b> from the list of applications.
USB ports on the computer are disabled in Computer Setup.	Run the Computer Setup utility and ensure that <b>Device available</b> is selected for appropriate USB ports under <b>Advanced &gt; Port Options</b> .

### Computer will not start.

Cause	Solution
Wrong memory modules were used in the upgrade or memory modules were installed in the wrong location.	<ol style="list-style-type: none"><li>1. Review the documentation that came with the system to determine if you are using the correct memory modules and to verify the proper installation.  <b>NOTE:</b> DIMM1 or XMM1 must always be installed. DIMM1 must be installed before DIMM2, and DIMM3 must be installed before DIMM4.</li><li>2. Observe the beeps and LED lights on the front of the computer. Beeps and flashing LEDs are codes for specific problems.</li><li>3. If you still cannot resolve the issue, contact Customer Support.</li></ol>

**Power LED flashes Red three times and then white two times.**

Cause	Solution
Memory is installed incorrectly or is bad.	<p><b>CAUTION:</b> To avoid damage to the DIMMs or the system board, you must unplug the computer power cord before attempting to reseat, install, or remove a DIMM module.</p> <ol style="list-style-type: none"><li>1. Reseat DIMMs. Power on the system.</li><li>2. Replace DIMMs one at a time to isolate the faulty module.</li></ol> <p><b>NOTE:</b> DIMM1 or XMM1 must always be installed. DIMM1 must be installed before DIMM2, and DIMM3 must be installed before DIMM4</p> <ol style="list-style-type: none"><li>3. Replace third-party memory with HP memory.</li><li>4. Replace the system board.</li></ol>

## Solving network problems

Some common causes and solutions for network problems are listed in the following table. These guidelines do not discuss the process of debugging the network cabling.

**Network driver does not detect network controller.**

Cause	Solution
Network controller is disabled.	<ol style="list-style-type: none"><li>1. Run Computer Setup and enable network controller.</li><li>2. Enable the network controller in the operating system using Device Manager.</li></ol> <p>To access Device Manager in Windows 10, type <code>device manager</code> in the taskbar search box, and then select <b>Device Manager</b> from the list of applications.</p>
Incorrect network driver.	Check the network controller documentation for the correct driver or obtain the latest driver from the manufacturer's Web site.

**Network status link light never flashes.**

**NOTE:** The network status light is supposed to flash when there is network activity.

Cause	Solution
No active network is detected.	Check cabling and network equipment for proper connection.
Network controller is not set up properly.	<p>Check for the device status within Windows, such as Device Manager for driver load and the Network Connections applet within Windows for link status.</p> <p>To access Device Manager in Windows 10, type <code>device manager</code> in the taskbar search box, and then select <b>Device Manager</b> from the list of applications.</p>
Network controller is disabled.	<ol style="list-style-type: none"><li>1. Run Computer Setup and enable network controller.</li><li>2. Enable the network controller in the operating system using Device Manager.</li></ol>

**Network status link light never flashes.**

**NOTE:** The network status light is supposed to flash when there is network activity.

Cause	Solution
	To access Device Manager in Windows 10, type <code>device manager</code> in the taskbar search box, and then select <b>Device Manager</b> from the list of applications.
Network driver is not properly loaded.	Reinstall network drivers.
System cannot autosense the network.	Disable auto-sensing capabilities and force the system into the correct operating mode.

**Diagnostics reports a failure.**

Cause	Solution
The cable is not securely connected.	Ensure that the cable is securely attached to the network connector and that the other end of the cable is securely attached to the correct device.
The cable is attached to the incorrect connector.	Ensure that the cable is attached to the correct connector.
There is a problem with the cable or a device at the other end of the cable.	Ensure that the cable and device at the other end are operating correctly.
The network controller is defective.	Contact an authorized service provider.

**Diagnostics passes, but the computer does not communicate with the network.**

Cause	Solution
Network drivers are not loaded, or driver parameters do not match current configuration.	Make sure the network drivers are loaded and that the driver parameters match the configuration of the network controller. Make sure the correct network client and protocol is installed.
The network controller is not configured for this computer.	Select the <b>Network and Sharing Center</b> icon in the <b>Control Panel</b> and configure the network controller. To access Control Panel in Windows 10, type <code>control panel</code> in the taskbar search box, and then select <b>Control Panel</b> from the list of applications.

**Network controller stopped working when an expansion board was added to the computer.**

Cause	Solution
The network controller requires drivers.	Verify that the drivers were not accidentally deleted when the drivers for a new expansion board were installed.



#### Network controller stops working without apparent cause.

Cause	Solution
The cable is not securely connected.	Ensure that the cable is securely attached to the network connector and that the other end of the cable is securely attached to the correct device.
The network controller is defective.	Contact an authorized service provider.

#### New network card will not boot.

Cause	Solution
New network card may be defective or may not meet industry-standard specifications.	Install a working, industry-standard NIC, or change the boot sequence to boot from another source.

#### Cannot connect to network server when attempting Remote System Installation.

Cause	Solution
The network controller is not configured properly.	Verify Network Connectivity, that a DHCP Server is present, and that the Remote System Installation Server contains the NIC drivers for your NIC.

#### System setup utility reports unprogrammed EEPROM.

Cause	Solution
Unprogrammed EEPROM.	Contact an authorized service provider.

## Solving memory problems

If you encounter memory problems, some common causes and solutions are listed in the following table.

 **CAUTION:** Power may still be supplied to the DIMMs when the computer is turned off (depending on the Management Engine (ME) settings). To avoid damage to the DIMMs or the system board, you must unplug the computer power cord before attempting to reseat, install, or remove a memory module.

For those systems that support ECC memory, HP does not support mixing ECC and non-ECC memory. Otherwise, the computer will not boot the operating system.

 **NOTE:** The memory count will be affected by configurations with the Management Engine (ME) enabled. The ME uses 8MB of system memory in single channel mode or 16MB of memory in dual-channel mode to download, decompress, and execute the ME firmware for Out-of-Band (OOB), third-party data storage, and other management functions.

**System will not boot or does not function properly after installing additional memory modules.**

Cause	Solution
A memory module is not installed in the DIMM1 or XMM1 socket.	Ensure that a memory module is installed in the DIMM1 or XMM1 socket on the system board. This socket must be populated with a memory module.
Memory module is not the correct type or speed grade for the system or the new memory module is not seated properly.	Replace module with the correct industry-standard device for the computer. On some models, ECC and non-ECC memory modules cannot be mixed.

**Out of memory error.**

Cause	Solution
You have run out of memory to run the application.	Check the application documentation to determine the memory requirements.

**Memory count during POST is wrong.**

Cause	Solution
The memory modules may not be installed correctly.	Check that the memory modules have been installed correctly and that proper modules are used.
Integrated graphics may use system memory.	No action required.

**Insufficient memory error during operation.**

Cause	Solution
Too many Terminate and Stay Resident programs (TSRs) are installed.	Delete any TSRs that you do not need.
You have run out of memory for the application.	Check the memory requirements for the application or add more memory to the computer.

**Power LED flashes Red five times, once every second, followed by a two second pause, and the computer beeps five times. (Beeps stop after fifth iteration but LEDs continue flashing.)**

Cause	Solution
Memory is installed incorrectly or is bad.	<ol style="list-style-type: none"><li>1. Reseat DIMMs. Power on the system.</li><li>2. Replace DIMMs one at a time to isolate the faulty module.</li><li>3. Replace third-party memory with HP memory.</li><li>4. Replace the system board.</li></ol>

## Solving USB flash drive problems

If you encounter USB flash drive problems, common causes and solutions are listed in the following table.

### USB flash drive is not seen as a drive letter in Windows.

Cause	Solution
The drive letter after the last physical drive is not available.	Change the default drive letter for the flash drive in Windows.

### USB flash drive not found (identified).

Cause	Solution
The device is attached to a USB port that has been hidden in Computer Setup.	Run the Computer Setup utility and enable USB ports in <b>Advanced &gt; Port Options</b> .
The device was not properly seated before power-up.	Ensure the device is fully inserted into the USB port before applying power to the system

### System will not boot from USB flash drive.

Cause	Solution
Boot order is not correct.	Run the Computer Setup utility and change boot sequence in <b>Advanced &gt; Boot Options</b> .
Removable Media Boot is disabled in the Computer Setup utility.	Run the Computer Setup utility and enable booting to removable media in <b>Advanced &gt; Boot Options</b> . Ensure USB is enabled in <b>Storage &gt; Boot Order</b> .

### The computer boots to DOS after making a bootable flash drive.

Cause	Solution
Flash drive is bootable.	Install the flash drive only after the operating system boots.
Flash drive is defective.	Try a different flash drive.

## Solving Internet access problems

If you encounter Internet access problems, consult your Internet Service Provider (ISP) or refer to the common causes and solutions listed in the following table.

### Unable to connect to the Internet.

Cause	Solution
Internet Service Provider (ISP) account is not set up properly.	Verify Internet settings or contact your ISP for assistance.
Web browser is not set up properly.	Verify that the Web browser is installed and set up to work with your ISP.
Cable/DSL modem is not plugged in.	Plug in cable/DSL modem. You should see a "power" LED light on the front of the cable/DSL modem.

### Unable to connect to the Internet.

Cause	Solution
Cable/DSL service is not available or has been interrupted due to bad weather.	Try connecting to the Internet at a later time or contact your ISP. (If the cable/DSL service is connected, the "cable" LED light on the front of the cable/DSL modem will be on.)
The CAT5 UTP cable is disconnected.	Connect the CAT5 UTP cable between the cable modem and the computer's RJ-45 connector. (If the connection is good, the "PC" LED light on the front of the cable/DSL modem will be on.)
IP address is not configured properly.	Contact your ISP for the correct IP address.
Cookies are corrupted. (A "cookie" is a small piece of information that a Web server can store temporarily with the Web browser. This is useful for having the browser remember some specific information that the Web server can later retrieve.)	Windows 10: <ol style="list-style-type: none"><li>1. Type <code>control panel</code> in the taskbar search box, and then select <b>Control Panel</b> from the list of applications.</li><li>2. Click <b>Internet Options</b>.</li><li>3. In the <b>Browsing history</b> section, click the <b>Delete</b> button.</li><li>4. Select the <b>Cookies and website data</b> check box and click the <b>Delete</b> button.</li></ol>

### Cannot automatically launch Internet programs.

Cause	Solution
You must log on to your ISP before some programs will start.	Log on to your ISP and launch the desired program.

## Solving software problems

Most software problems occur as a result of the following:

- The application was not installed or configured correctly.
- There is insufficient memory available to run the application.
- There is a conflict between applications.
- Be sure that all the needed device drivers have been installed.
- If you have installed an operating system other than the factory-installed operating system, check to be sure it is supported on the system.

If you encounter software problems, see the applicable solutions listed in the following table.

### Computer will not continue and the HP logo does not display.

Cause	Solution
ROM issue - POST error has occurred.	Observe the beeps and LED lights on the front of the computer. See <a href="#">POST error messages and diagnostic front panel LEDs and audible codes on page 78</a> to determine possible causes.  See the Worldwide Limited Warranty for terms and conditions.

**“Illegal Operation has Occurred” error message is displayed.**

<b>Cause</b>	<b>Solution</b>
Software being used is not Microsoft-certified for your version of Windows.	Verify that the software is certified by Microsoft for your version of Windows (see program packaging for this information).
Configuration files are corrupt.	If possible, save all data, close all programs, and restart the computer.

# 7 POST error messages and diagnostic front panel LEDs and audible codes

This appendix lists the error codes, error messages, and the various indicator light and audible sequences that you may encounter during Power-On Self-Test (POST) or computer restart, the probable source of the problem, and steps you can take to resolve the error condition.

POST Message Disabled suppresses most system messages during POST, such as memory count and non-error text messages. If a POST error occurs, the screen will display the error message. To manually switch to the POST Messages Enabled mode during POST, press any key (except **F10**, **F11**, or **F12**). The default mode is POST Message Disabled.

The speed at which the computer loads the operating system and the extent to which it is tested are determined by the POST mode selection.

Quick Boot is a fast startup process that does not run all of the system level tests, such as the memory test. Full Boot runs all of the ROM-based system tests and takes longer to complete.

Full Boot may also be enabled to run every 1 to 30 days on a regularly scheduled basis. To establish the schedule, reconfigure the computer to the Full Boot Every x Days mode, using Computer Setup.

 **NOTE:** For more information on Computer Setup, see [Computer Setup \(F10\) Utility on page 41](#).

## POST numeric codes and text messages

This section covers those POST errors that have numeric codes associated with them. The section also includes some text messages that may be encountered during POST.

 **NOTE:** The computer will beep once after a POST text message is displayed on the screen.

Control panel message	Description	Recommended action
002-Option ROM Checksum Error	System ROM or expansion board option ROM checksum.	<ol style="list-style-type: none"><li>1. Verify the correct ROM.</li><li>2. Flash the ROM if needed.</li><li>3. If an expansion board was recently added, remove it to see if the problem remains.</li><li>4. Clear CMOS. (See <a href="#">Password security and resetting CMOS on page 85</a>.)</li><li>5. If the message disappears, there may be a problem with the expansion card.</li><li>6. Replace the system board.</li></ol>
003-System Board Failure	DMA or timers.	<ol style="list-style-type: none"><li>1. Clear CMOS. (See <a href="#">Password security and resetting CMOS on page 85</a>.)</li><li>2. Remove expansion boards.</li><li>3. Replace the system board.</li></ol>
005-Real-Time Clock Power Loss	Invalid time or date in configuration memory.	Reset the date and time under <b>Control Panel</b> (Computer Setup can also be used). If the

Control panel message	Description	Recommended action
	RTC (real-time clock) battery may need to be replaced.	problem persists, replace the RTC battery. See the Removal and Replacement section for instructions on installing a new battery.
008–Microcode Patch Error	Processor is not supported by the BIOS.	<ol style="list-style-type: none"> <li>1. Upgrade BIOS to proper version.</li> <li>2. Change the processor.</li> </ol>
009–PMM Allocation Error during MEBx Download	Memory error during POST execution of the Management Engine (ME) BIOS Extensions option ROM.	<ol style="list-style-type: none"> <li>1. Reboot the computer.</li> <li>2. Unplug the power cord, re-seat the memory modules, and reboot the computer.</li> <li>3. If the memory configuration was recently changed, unplug the computer, restore the original memory configuration, and reboot the computer.</li> <li>4. If the error persists, replace the system board.</li> </ol>
00A–Product Information Not Valid	The product information programmed into the system board is missing or invalid.	Use Computer Setup to update this information.
00B–MEBx Module did not checksum correctly	Memory error during POST execution of the Management Engine (ME) BIOS Extensions option ROM.	<ol style="list-style-type: none"> <li>1. Reboot the computer.</li> <li>2. Unplug the power cord, re-seat the memory modules, and reboot the computer.</li> <li>3. If the memory configuration was recently changed, unplug the power cord, restore the original memory configuration, and reboot the computer.</li> <li>4. If the error persists, replace the system board.</li> </ol>
00C–PMM Deallocation Error during MEBx Cleanup	Memory error during POST execution of the Management Engine (ME) BIOS Extensions option ROM.	<ol style="list-style-type: none"> <li>1. Reboot the computer.</li> <li>2. Unplug the power cord, re-seat the memory modules, and reboot the computer.</li> <li>3. If the memory configuration was recently changed, unplug the power cord, restore the original memory configuration, and reboot the computer.</li> <li>4. If the error persists, replace the system board.</li> </ol>
00D–Setup Error during MEBx Execution	MEBx selection or exit resulted in a setup failure.	<ol style="list-style-type: none"> <li>1. Reboot the computer.</li> <li>2. Unplug the power cord, re-seat the memory modules, and reboot the computer.</li> <li>3. If the memory configuration was recently changed, unplug the power cord, restore the original memory configuration, and reboot the computer.</li> <li>4. If the error persists, replace the system board.</li> </ol>

Control panel message	Description	Recommended action
00E-Inventory Error during MEBx Execution	BIOS information passed to the MEBx resulted in a failure.	<ol style="list-style-type: none"> <li>1. Reboot the computer.</li> <li>2. If the error persists, update to the latest BIOS version.</li> <li>3. If the error still persists, replace the system board.</li> </ol>
00F-Interface Error during MEBx Execution	MEBx operation experienced a hardware error during communication with the ME.	<ol style="list-style-type: none"> <li>1. Reboot the computer.</li> <li>2. If the error persists, update to the latest BIOS version.</li> <li>3. If the error still persists, replace the system board.</li> </ol>
100-Front Audio Not Connected	Front audio cable has been detached or unseated from system board.	Reconnect or replace front audio cable.
2E1-MemorySize Error	Memory amount has changed since the last boot (memory added or removed).	The system memory size is different from the last startup. The most common reason is the removal of memory from the system board. Press the <b>F1</b> key to save the memory changes. If this message persists, verify that the memory modules are installed correctly.
2E2-Memory Error	Memory module configuration failed during boot up.	<ol style="list-style-type: none"> <li>1. Ensure memory modules are correctly installed.</li> <li>2. Verify proper memory module type.</li> <li>3. Remove and replace the identified faulty memory module(s).</li> <li>4. If the error persists after replacing memory modules, replace the system board.</li> </ol>
2E3-Incompatible Memory Module in Memory Socket(s) X, X, ...	A memory module in memory socket identified in the error message is missing critical SPD information, or is incompatible with the chipset.	<ol style="list-style-type: none"> <li>1. Verify proper memory module type.</li> <li>2. Try another memory socket.</li> <li>3. Replace with a supported module.</li> </ol>
2E4-DIMM Configuration Warning	The current memory configuration is not optimized.	Rearrange the DIMMs so that each channel has the same amount of memory.
2E5-ECC Memory Module Detected on Unsupported Platform	Recently added memory module(s) support ECC memory error correction.	<ol style="list-style-type: none"> <li>1. If additional memory was recently added, remove it to see if the problem remains.</li> <li>2. Check product documentation for memory support information.</li> </ol>
2E6-Memory Not Configured Correctly for Proper MEBx Execution	DIMM1 is not installed.	Make sure there is a memory module in the DIMM1 socket and that it is properly seated.
300-Configuration Change Warning	The storage device configuration will be updated as shown.	Not applicable
301-Hard Disk 1: SMART Hard Drive Detects Imminent Failure	Hard drive is about to fail. (Some hard drives have a hard drive firmware patch that will fix an erroneous error message.)	<ol style="list-style-type: none"> <li>1. Determine if hard drive is giving correct error message. Run the Drive Protection System test under using F2 Diagnostics when booting the computer.</li> <li>2. Apply hard drive firmware patch if applicable. (Available at <a href="http://www.hp.com/support">http://www.hp.com/support</a>.)</li> </ol>



Control panel message	Description	Recommended action
302-Hard Disk 2: SMART Hard Drive Detects Imminent Failure	Hard drive is about to fail. (Some hard drives have a hard drive firmware patch that will fix an erroneous error message.)	<ol style="list-style-type: none"> <li>1. Determine if hard drive is giving correct error message. Run the Drive Protection System test under using F2 Diagnostics when booting the computer.</li> <li>2. Apply hard drive firmware patch if applicable. (Available at <a href="http://www.hp.com/support">http://www.hp.com/support</a>.)</li> <li>3. Back up contents and replace hard drive.</li> </ol>
309 – 30C: Hard Disk 3–6: SMART Hard Drive Detects Imminent Failure	Hard drive is about to fail. (Some hard drives have a hard drive firmware patch that will fix an erroneous error message.)	<ol style="list-style-type: none"> <li>1. Determine if hard drive is giving correct error message. Run the Drive Protection System test under using F2 Diagnostics when booting the computer.</li> <li>2. Apply hard drive firmware patch if applicable. (Available at <a href="http://www.hp.com/support">http://www.hp.com/support</a>.)</li> <li>3. Back up contents and replace hard drive.</li> </ol>
3F0–Boot Device Not Found	Boot device not found.	Insert boot device or load operating system.
3F1–Hard Disk 1 Error	Hard disk 1 error.	<ol style="list-style-type: none"> <li>1. Check and/or replace cables.</li> <li>2. Clear CMOS. (See <a href="#">Password security and resetting CMOS on page 85</a>.)</li> <li>3. Replace the hard disk drive.</li> </ol>
3F2–Hard Disk 2 Error	Hard disk 2 error.	<ol style="list-style-type: none"> <li>1. Check and/or replace cables.</li> <li>2. Clear CMOS. (See <a href="#">Password security and resetting CMOS on page 85</a>.)</li> <li>3. Replace the hard disk drive.</li> </ol>
400–Serial Port A Address Conflict Detected	Both external and internal serial ports are assigned to the same resources.	<ol style="list-style-type: none"> <li>1. Remove any serial port expansion cards.</li> <li>2. Clear CMOS. (See <a href="#">Password security and resetting CMOS on page 85</a>.)</li> <li>3. Reconfigure card resources and/or run Computer Setup or Windows utilities.</li> </ol>
401–Serial Port B Address Conflict Detected	Both external and internal serial ports are assigned to the same resources.	<ol style="list-style-type: none"> <li>1. Remove any serial port expansion cards.</li> <li>2. Clear CMOS. (See <a href="#">Password security and resetting CMOS on page 85</a>.)</li> <li>3. Reconfigure card resources and/or run Computer Setup or Windows utilities.</li> </ol>
402–Serial Port C Address Conflict Detected	Both external and internal serial ports are assigned to the same resources.	<ol style="list-style-type: none"> <li>1. Remove any serial port expansion cards.</li> <li>2. Clear CMOS. (See <a href="#">Password security and resetting CMOS on page 85</a>.)</li> <li>3. Reconfigure card resources and/or run Computer Setup or Windows utilities.</li> </ol>
403–Serial Port D Address Conflict Detected	Both external and internal serial ports are assigned to the same resources.	<ol style="list-style-type: none"> <li>1. Remove any serial port expansion cards.</li> <li>2. Clear CMOS. (See <a href="#">Password security and resetting CMOS on page 85</a>.)</li> </ol>

Control panel message	Description	Recommended action
		<ol style="list-style-type: none"> <li>3. Reconfigure card resources and/or run Computer Setup or Windows utilities.</li> </ol>
419-Out of Memory Space for Option ROMs	Recently added PCI expansion card contains an option ROM too large to download during POST.	<p>▲ If a PCI expansion card was recently added, remove it to see if the problem remains.</p>
41A-Front USB1/USB2 Not Connected	Front USB cable has been detached or unseated from system board.	Reconnect or replace front USB cable.
41B-Device in PCI Express Slot Failed To Initialize	There is an incompatibility or problem with a PCIe device and the system or PCIe link could not be configured to a valid bus width or speed.	Try rebooting the system. If the error reoccurs, the device may not work with this system
43A-USB Type-C I2C Not Connected	Cable is required between I2C on card and USB-C on the system board.	Install cable between I2C on card and USB-C on the system board.
43B-More Than One USB type-C Cards Are Installed	More than one USB type-C card is installed.	Remove USB type-C card so only one is installed.
500-BIOS Recovery	A system BIOS recovery has occurred.	Not applicable.
70x-Wireless Mode Not Supported	The system has detected a wireless module installed in the system that is not supported and has been disabled.	Replace with a supported module.
800-Keyboard Error	Keyboard failure.	<ol style="list-style-type: none"> <li>1. Reconnect keyboard with computer turned off.</li> <li>2. Check connector for bent or missing pins.</li> <li>3. Ensure that none of the keys are depressed.</li> <li>4. Replace keyboard.</li> </ol>
801-Keyboard or System Unit Error	Keyboard failure.	<ol style="list-style-type: none"> <li>1. Reconnect the keyboard with computer turned off.</li> <li>2. Ensure that none of the keys are depressed.</li> <li>3. Replace the keyboard.</li> <li>4. Replace the system board.</li> </ol>
900-CPU Fan Not Detected	CPU fan is not connected or may have malfunctioned.	<ol style="list-style-type: none"> <li>1. Reseat CPU fan.</li> <li>2. Reseat fan cable.</li> <li>3. Replace CPU fan.</li> </ol>
901-Chassis, Rear Chassis, or Front Chassis Fan not Detected	Chassis, rear chassis, or front chassis fan is not connected or may have malfunctioned.	<ol style="list-style-type: none"> <li>1. Reseat chassis, rear chassis, or front chassis fan.</li> <li>2. Reseat fan cable.</li> <li>3. Replace chassis, rear chassis, or front chassis fan.</li> </ol>
903-Computer Cover Has Been Removed Since Last System Startup		N/A
904-SATA Cabling Error	One or more SATA devices are improperly attached. For optimal performance, the SATA 0 and SATA 1 ports should be used for hard drives before other ports.	Ensure SATA connectors are used in ascending order. For one device, use SATA 0. For two devices, use SATA 0 and SATA 1. For three devices, use SATA 0, SATA 1, and SATA 2.

Control panel message	Description	Recommended action
90B-Fan Failure	The system has detected that a cooling fan is not operating correctly.	<ol style="list-style-type: none"> <li>1. Reseat fan.</li> <li>2. Reseat fan cable.</li> <li>3. Replace fan.</li> </ol>
90D-System Temperature	Thermal shutdown occurred. The system BIOS has detected your machine was previously shut down to avoid overheating. Overheating may occur if the cooling vents are blocked or the operating temperature exceeds the system specifications. The machine should return to normal operation once the situation is resolved.	Make sure system has proper airflow.
90E-Power Supply Fan Not detected	Power supply fan is not connected or may have malfunctioned.	<ol style="list-style-type: none"> <li>1. Reseat power supply fan.</li> <li>2. Reseat fan cable.</li> <li>3. Replace power supply fan.</li> </ol>
910-Filter Warning	Airflow filter is dirty.	Replace the airflow filter.

## Interpreting system validation diagnostic front panel LEDs and audible codes

During the system validation phase that occurs at system startup, the BIOS validates the functionality of the following subsystems and conditions:

- AC adapter
- System board power
- Processor failure
- BIOS corruption
- Memory failure
- Graphics failure
- System board failure
- BIOS authentication failure

If an error is detected, specific patterns of long and short blinks, accompanied by long and short beeps (where applicable) are used to identify the error. These patterns will make up a two part code:

- Major – the category of the error
- Minor – the specific error within the category



**NOTE:** Single beep/blink codes are not used.

Number of long beeps/blinks	Error category
1	Not used
2	BIOS
3	Hardware

Number of long beeps/blinks	Error category
4	Thermal
5	System board

Patterns of blink/beep codes are determined by using the following parameters:

- 1 second pause occurs after the last major blink.
- 2 second pause occurs after the last minor blink.
- Beep error code sequences occur for the first 5 iterations of the pattern and then stop.
- Blink error code sequences continue until the computer is unplugged or the power button is pressed.



**NOTE:** Not all diagnostic lights and audible codes are available on all models.

The red LED blinks to represent the major error category (long blinks). The white LED blinks to represent the minor error category (short blinks). For example, '3.5' indicates 3 long red blinks and 5 short white blinks to communicate the processor is not detected.

Category	Major/minor code	Description
BIOS	2.2	The main area (DXE) of BIOS has become corrupted and there is no recovery binary image available.
	2.3	The embedded controller policy requires the user to enter a key sequence.
	2.4	The embedded controller is checking or recovering the boot block.
Hardware	3.2	The embedded controller has timed out waiting for BIOS to return from memory initialization.
	3.3	The embedded controller has timed out waiting for BIOS to return from graphics initialization.
	3.4	The system board displays a power failure (crowbar).*
	3.5	The processor is not detected.*
	3.6	The processor does not support an enabled feature.
	4.2	A processor over temperature condition has been detected.*
Thermal	4.3	An ambient temperature over temperature condition has been detected.
	4.4	An MXM over temperature condition has been detected.
	5.2	The embedded controller cannot find valid firmware.
System board	5.3	The embedded controller has timed out waiting for the BIOS.
	5.4	The embedded controller has timed out waiting for BIOS to return from system board initialization.
	5.5	The embedded controller rebooted the system after a possible lockup condition had been detected through the use of a System Health Timer, Automated System Recovery Timer, or other mechanism.

\* Indicates hardware triggered event; all other events are controlled by the BIOS.

---

## 8 Password security and resetting CMOS

This computer supports security password features, which can be established through the Computer Setup Utilities menu.

This computer supports two security password features that are established through the Computer Setup Utilities menu: administrator password and power-on password. When you establish only an administrator password, any user can access all the information on the computer except Computer Setup. When you establish only a power-on password, the power-on password is required to access Computer Setup and any other information on the computer. When you establish both passwords, only the administrator password will give you access to Computer Setup.

When both passwords are set, the administrator password can also be used in place of the power-on password as an override to log in to the computer. This is a useful feature for a network administrator.

If you forget one or both passwords, you can clear all passwords by powering off the system, opening the cover, temporarily removing the PSWD jumper, and booting once. This will erase the administrator and power-on passwords. You must restore the jumper to create new passwords.

---

 **CAUTION:** Pushing the CMOS button with power removed will reset the BIOS settings to factory defaults. It may be useful to back up the BIOS settings or save them as custom defaults before resetting them in case they are needed later. Back up can be performed in Computer Setup or using the BiosConfigUtility tool available from [www.hp.com](http://www.hp.com). See [Computer Setup \(F10\) Utility on page 41](#) for information on backing up the BIOS settings.

---

### Resetting the password jumper

---

 **CAUTION:** Stringent security is a mode where there is no physical bypass of the password function. If enabled, removing the password jumper will be ignored. To enable this mode, change the security setting **Clear Password Jumper** in Password Policies to **Ignore**.

If you lose or forget the password when in stringent security mode, the system can only be reset by System Management Command. This is a way for HP Service and Support to provide a secure method to access the BIOS and command a password reset for a specifically identified unit under the direction of the owner. This scenario may not be covered under warranty.

To prevent needing a customer service event to restore access to the system, record your configured administrator and power-on passwords in a safe place away from your computer.

---

To disable the power-on or administrator password features, or to clear the power-on or administrator passwords, complete the following steps:

1. Shut down the operating system properly, then turn off the computer and any external devices, and disconnect the power cord from the power outlet.
2. With the power cord disconnected, press the power button again to drain the system of any residual power.

---

 **WARNING!** To reduce the risk of personal injury from electrical shock and/or hot surfaces, be sure to disconnect the power cord from the wall outlet, and allow the internal system components to cool before touching.

 **CAUTION:** When the computer is plugged in, the power supply always has voltage applied to the system board even when the unit is turned off. Failure to disconnect the power cord can result in damage to the system.

Static electricity can damage the electronic components of the computer or optional equipment. Before beginning these procedures, ensure that you are discharged of static electricity by briefly touching a grounded metal object. See the *Safety & Regulatory Information* guide for more information.

---

3. Remove the access panel.
4. Locate the header and jumper.

---

 **NOTE:** The password jumper is green so that it can be easily identified. For assistance locating the password jumper and other system board components, see the system board components image at [System board on page 34](#).

---

5. Remove the jumper from pins 1 and 2.
6. Place the jumper on either pin 1 or 2, but not both, so that it does not get lost.
7. Replace the access panel and reconnect the external equipment.
8. Plug in the computer and turn on power. Allow the operating system to start. This clears the current passwords and disables the password features.
9. Shut down the computer, unplug the power, and disconnect the external equipment.
10. Remove the access panel.
11. Place the jumper on pins 1 and 2.
12. Replace the access panel.
13. Reconnect the external equipment and plug in the computer.

## Clearing and resetting the BIOS

The CMOS button resets BIOS settings to default, but does not clear the passwords or affect any of the other Security settings. On Intel systems with advanced manageability features, the CMOS button will also partially unprovision AMT.

1. Turn off the computer and any external devices, and disconnect the power cord from the power outlet.
2. Disconnect the keyboard, monitor, and any other external equipment connected to the computer.

**⚠ WARNING!** To reduce the risk of personal injury from electrical shock and/or hot surfaces, be sure to disconnect the power cord from the wall outlet, and allow the internal system components to cool before touching.

**⚠ CAUTION:** When the computer is plugged in, the power supply always has voltage applied to the system board even when the unit is turned off. Failure to disconnect the power cord can result in damage to the system.

Static electricity can damage the electronic components of the computer or optional equipment. Before beginning these procedures, ensure that you are discharged of static electricity by briefly touching a grounded metal object. See the *Safety & Regulatory Information* guide for more information.

3. Remove the access panel.

**⚠ CAUTION:** Pushing the CMOS button will reset CMOS values to factory defaults. It is important to back up the computer CMOS settings before resetting them in case they are needed later. Back up is easily done through Computer Setup. See [Computer Setup \(F10\) Utility on page 41](#) for information on backing up the CMOS settings.

4. Locate, press, and hold the CMOS button in for five seconds.

**📝 NOTE:** Make sure you have disconnected the AC power cord from the wall outlet. The CMOS button will not clear CMOS if the power cord is connected.



**📝 NOTE:** For assistance locating the CMOS button and other system board components, see the system board components image at [System board on page 34](#).

5. Replace the access panel.
6. Reconnect the external devices.
7. Plug in the computer and turn on power.

**📝 NOTE:** You will receive POST error messages after clearing CMOS and rebooting advising you that configuration changes have occurred. Use Computer Setup to reset any special system setups along with the date and time.

For instructions on Computer Setup, see [Computer Setup \(F10\) Utility on page 41](#).

---

# 9 Using HP PC Hardware Diagnostics

## Using HP PC Hardware Diagnostics Windows

HP PC Hardware Diagnostics Windows is a Windows-based utility that allows you to run diagnostic tests to determine whether the computer hardware is functioning properly. The tool runs within the Windows operating system in order to diagnose hardware failures.

If HP PC Hardware Diagnostics Windows is not installed on your computer, first you must download and install it. To download HP PC Hardware Diagnostics Windows, see [Downloading HP PC Hardware Diagnostics Windows on page 88](#).

After HP PC Hardware Diagnostics Windows is installed, follow these steps to access it from HP Help and Support or HP Support Assistant.

1. To access HP PC Hardware Diagnostics Windows from HP Help and Support:
    - a. Select the **Start** button, and then select **HP Help and Support**.
    - b. Right-click **HP PC Hardware Diagnostics Windows**, select **More**, and then select **Run as administrator**.

– or –

To access HP PC Hardware Diagnostics Windows from HP Support Assistant:

    - a. Type `support` in the taskbar search box, and then select the **HP Support Assistant** app.

– or –

Select the question mark icon in the taskbar.

    - b. Select **Troubleshooting and fixes**.
    - c. Select **Diagnostics**, and then select **HP PC Hardware Diagnostics Windows**.
  2. When the tool opens, select the type of diagnostic test you want to run, and then follow the on-screen instructions.
- 
-  **NOTE:** If you need to stop a diagnostic test at any time, select **Cancel**.
3. When HP PC Hardware Diagnostics Windows detects a failure that requires hardware replacement, a 24-digit Failure ID code is generated. For assistance in correcting the problem, contact support, and then provide the Failure ID code.

## Downloading HP PC Hardware Diagnostics Windows

- The HP PC Hardware Diagnostics Windows download instructions are provided in English only.
- You must use a Windows computer to download this tool because only .exe files are provided.



## Downloading the latest HP PC Hardware Diagnostics Windows version

To download HP PC Hardware Diagnostics Windows, follow these steps:

1. Go to <http://www.hp.com/go/techcenter/pcdiags>. The HP PC Diagnostics home page is displayed.
2. In the **HP PC Hardware Diagnostics** section, select **Download**, and then select the installation location:  
To run the tool on your computer, download it to the computer desktop.  
– or –  
To run the tool from a USB flash drive, download it to a USB flash drive.
3. Select **Run**.

## Downloading HP Hardware Diagnostics Windows by product name or number (select products only)



**NOTE:** For some products, it may be necessary to download the software to a USB flash drive by using the product name or number.

To download HP PC Hardware Diagnostics Windows by product name or number (select products only), follow these steps:

1. Go to <http://www.hp.com/support>.
2. Select **Get software and drivers**, and then enter the product name or number.
3. In the **HP PC Hardware Diagnostics** section, select **Download**, and then select the installation location:  
To run the tool on your computer, download it to the computer desktop.  
– or –  
To run the tool from a USB flash drive, download it to a USB flash drive.
4. Select **Run**.

## Installing HP PC Hardware Diagnostics Windows

To install HP PC Hardware Diagnostics Windows, follow these steps:

- ▲ Navigate to the folder on your computer or the flash drive where the .exe file was downloaded, double-click the .exe file, and then follow the on-screen instructions.

## Using HP PC Hardware Diagnostics UEFI

HP PC Hardware Diagnostics UEFI (Unified Extensible Firmware Interface) allows you to run diagnostic tests to determine whether the computer hardware is functioning properly. The tool runs outside the operating system so that it can isolate hardware failures from issues that are caused by the operating system or other software components.

If your PC will not boot into Windows, you can use HP PC Hardware Diagnostics UEFI to diagnose hardware issues.

When HP PC Hardware Diagnostics UEFI detects a failure that requires hardware replacement, a 24-digit Failure ID code is generated. For assistance in correcting the problem, contact support, and provide the Failure ID code.



**NOTE:** To start diagnostics on a convertible computer, your computer must be in notebook mode, and you must use the attached keyboard.

 **NOTE:** If you need to stop a diagnostic test, press *esc*.

---

## Starting HP PC Hardware Diagnostics UEFI

To start HP PC Hardware Diagnostics UEFI, follow these steps:

1. Turn on or restart the computer, and quickly press *esc*.
2. Press *f2*.

The BIOS searches three places for the diagnostic tools, in the following order:

- a. Connected USB flash drive

 **NOTE:** To download the HP PC Hardware Diagnostics UEFI tool to a USB flash drive, see [Downloading the latest HP PC Hardware Diagnostics UEFI version on page 90](#).

---

- b. Hard drive

- c. BIOS

3. When the diagnostic tool opens, select the type of diagnostic test you want to run, and then follow the on-screen instructions.

## Downloading HP PC Hardware Diagnostics UEFI to a USB flash drive

Downloading HP PC Hardware Diagnostics UEFI to a USB flash drive can be useful in the following situations:

- HP PC Hardware Diagnostics UEFI is not included in the preinstall image.
- HP PC Hardware Diagnostics UEFI is not included in the HP Tool partition.
- The hard drive is damaged.

 **NOTE:** The HP PC Hardware Diagnostics UEFI download instructions are provided in English only, and you must use a Windows computer to download and create the HP UEFI support environment because only .exe files are provided.

---

## Downloading the latest HP PC Hardware Diagnostics UEFI version

To download the latest HP PC Hardware Diagnostics UEFI version to a USB flash drive:

1. Go to <http://www.hp.com/go/techcenter/pcdiags>. The HP PC Diagnostics home page is displayed.
2. In the **HP PC Hardware Diagnostics UEFI** section, select **Download UEFI Diagnostics**, and then select **Run**.

## Downloading HP PC Hardware Diagnostics UEFI by product name or number (select products only)

 **NOTE:** For some products, it may be necessary to download the software to a USB flash drive by using the product name or number.

---

To download HP PC Hardware Diagnostics UEFI by product name or number (select products only) to a USB flash drive:

1. Go to <http://www.hp.com/support>.
2. Enter the product name or number, select your computer, and then select your operating system.
3. In the **Diagnostics** section, follow the on-screen instructions to select and download the specific UEFI Diagnostics version for your computer.

## Using Remote HP PC Hardware Diagnostics UEFI settings (select products only)

Remote HP PC Hardware Diagnostics UEFI is a firmware (BIOS) feature that downloads HP PC Hardware Diagnostics UEFI to your computer. It can then execute the diagnostics on your computer, and it may upload results to a preconfigured server. For more information on Remote HP PC Hardware Diagnostics UEFI, go to <http://www.hp.com/go/techcenter/pcdiags>, and then select **Find out more**.

### Downloading Remote HP PC Hardware Diagnostics UEFI



**NOTE:** HP Remote PC Hardware Diagnostics UEFI is also available as a Softpaq that can be downloaded to a server.

### Downloading the latest Remote HP PC Hardware Diagnostics UEFI version

To download the latest Remote HP PC Hardware Diagnostics UEFI version, follow these steps:

1. Go to <http://www.hp.com/go/techcenter/pcdiags>. The HP PC Diagnostics home page is displayed.
2. In the **HP PC Hardware Diagnostics UEFI** section, select **Download Remote Diagnostics**, and then select **Run**.

### Downloading Remote HP PC Hardware Diagnostics UEFI by product name or number



**NOTE:** For some products, it may be necessary to download the software by using the product name or number.

To download HP Remote PC Hardware Diagnostics UEFI by product name or number, follow these steps:

1. Go to <http://www.hp.com/support>.
2. Select **Get software and drivers**, enter the product name or number, select your computer, and then select your operating system.
3. In the **Diagnostics** section, follow the on-screen instructions to select and download the **Remote UEFI** version for the product.

## Customizing Remote HP PC Hardware Diagnostics UEFI settings

Using the Remote HP PC Hardware Diagnostics setting in Computer Setup (BIOS), you can perform the following customizations:

- Set a schedule for running diagnostics unattended. You can also start diagnostics immediately in interactive mode by selecting **Execute Remote HP PC Hardware Diagnostics**.
- Set the location for downloading the diagnostic tools. This feature provides access to the tools from the HP website or from a server that has been preconfigured for use. Your computer does not require the traditional local storage (such as a disk drive or USB flash drive) to run remote diagnostics.

- Set a location for storing the test results. You can also set the user name and password settings used for uploads.
- Display status information about the diagnostics run previously.

To customize Remote HP PC Hardware Diagnostics UEFI settings, follow these steps:

1. Turn on or restart the computer, and when the HP logo appears, press **f10** to enter Computer Setup.
2. Select **Advanced**, and then select **Settings**.
3. Make your customization selections.
4. Select **Main**, and then **Save Changes and Exit** to save your settings.

Your changes take effect when the computer restarts.

---

# A Power Cord Set Requirements

The power supplies on some computers have external power switches. The voltage select switch feature on the computer permits it to operate from any line voltage between 100-120 or 220-240 volts AC. Power supplies on those computers that do not have external power switches are equipped with internal switches that sense the incoming voltage and automatically switch to the proper voltage.

The power cord set received with the computer meets the requirements for use in the country where you purchased the equipment.

Power cord sets for use in other countries must meet the requirements of the country where you use the computer.

## General Requirements

The requirements listed below are applicable to all countries:

1. The power cord must be approved by an acceptable accredited agency responsible for evaluation in the country where the power cord set will be installed.
2. The power cord set must have a minimum current capacity of 10A (7A Japan only) and a nominal voltage rating of 125 or 250 volts AC, as required by each country's power system.
3. The diameter of the wire must be a minimum of 0.75 mm<sup>2</sup> or 18AWG, and the length of the cord must be between 1.8 m (6 feet) and 3.6 m (12 feet).

The power cord should be routed so that it is not likely to be walked on or pinched by items placed upon it or against it. Particular attention should be paid to the plug, electrical outlet, and the point where the cord exits from the product.

---

 **WARNING!** Do not operate this product with a damaged power cord set. If the power cord set is damaged in any manner, replace it immediately.

---

## Japanese Power Cord Requirements

For use in Japan, use only the power cord received with this product.

---

 **CAUTION:** Do not use the power cord received with this product on any other products.

---

## Country-Specific Requirements

Additional requirements specific to a country are shown in parentheses and explained below.

Country	Accrediting Agency	Country	Accrediting Agency
Australia (1)	EANSW	Italy (1)	IMQ
Austria (1)	OVE	Japan (3)	METI
Belgium (1)	CEBC	Norway (1)	NEMKO
Canada (2)	CSA	Sweden (1)	SEMKO
Denmark (1)	DEMKO	Switzerland (1)	SEV
Finland (1)	SETI	United Kingdom (1)	BSI
France (1)	UTE	United States (2)	UL
Germany (1)	VDE		

1. The flexible cord must be Type H05VV-F, 3-conductor, 0.75mm<sup>2</sup> conductor size. Power cord set fittings (appliance coupler and wall plug) must bear the certification mark of the agency responsible for evaluation in the country where it will be used.
2. The flexible cord must be Type SVT or equivalent, No. 18 AWG, 3-conductor. The wall plug must be a two-pole grounding type with a NEMA 5-15P (15A, 125V) or NEMA 6-15P (15A, 250V) configuration.
3. Appliance coupler, flexible cord, and wall plug must bear a “T” mark and registration number in accordance with the Japanese Dentori Law. Flexible cord must be Type VCT or VCTF, 3-conductor, 0.75 mm<sup>2</sup> conductor size. Wall plug must be a two-pole grounding type with a Japanese Industrial Standard C8303 (7A, 125V) configuration.

## B Statement of memory volatility

The purpose of this chapter is to provide general information regarding nonvolatile memory in HP Business computers. This chapter also provides general instructions for restoring nonvolatile memory that can contain personal data after the system has been powered off and the hard drive has been removed.

HP Business computer products that use Intel®-based or AMD®-based system boards contain volatile DDR memory. The amount of nonvolatile memory present in the system depends upon the system configuration. Intel-based and AMD-based system boards contain nonvolatile memory subcomponents as originally shipped from HP, assuming that no subsequent modifications have been made to the system and assuming that no applications, features, or functionality have been added to or installed on the system.

Following system shutdown and removal of all power sources from an HP Business computer system, personal data can remain on volatile system memory (DIMMs) for a finite period of time and will also remain in nonvolatile memory. Use the steps below to remove personal data from the computer, including the nonvolatile memory found in Intel-based and AMD-based system boards.

---

 **NOTE:** If your tablet has a keyboard base, connect to the keyboard base before beginning steps in this chapter.

---

### Current BIOS steps

1. Follow steps (a) through (l) below to restore the nonvolatile memory that can contain personal data. Restoring or reprogramming nonvolatile memory that does not store personal data is neither necessary nor recommended.
  - a. Turn on or restart the computer, and then press **esc** while the “Press the ESC key for Startup Menu” message is displayed at the bottom of the screen.

---

 **NOTE:** If the system has a BIOS administrator password, enter the password at the prompt.
  - b. Select **Main**, select **Apply Factory Defaults and Exit**, and then select **Yes** to load defaults.  
The computer will reboot.
  - c. During the reboot, press **esc** while the “Press the ESC key for Startup Menu” message is displayed at the bottom of the screen.

---

 **NOTE:** If the system has a BIOS administrator password, enter the password at the prompt.
  - d. Select the **Security** menu, select **Restore Security Settings to Factory Defaults**, and then select **Yes** to restore security level defaults.  
The computer will reboot.
  - e. During the reboot, press **esc** while the “Press the ESC key for Startup Menu” message is displayed at the bottom of the screen.

---

 **NOTE:** If the system has a BIOS administrator password, enter the password at the prompt.
  - f. If an asset or ownership tag is set, select the **Security** menu and scroll down to the **Utilities** menu. Select **System IDs**, and then select **Asset Tracking Number**. Clear the tag, and then make the selection to return to the prior menu.

- g. If a DriveLock password is set, select the **Security** menu, and scroll down to **Hard Drive Utilities** under the **Utilities** menu. Select **Hard Drive Utilities**, select **DriveLock**, then uncheck the checkbox for **DriveLock password on restart**. Select **OK** to proceed.
- h. Select the **Main** menu, and then select **Reset BIOS Security to factory default**. Click **Yes** at the warning message.  
The computer will reboot.
- i. During the reboot, press **esc** while the “Press the ESC key for Startup Menu” message is displayed at the bottom of the screen.



---

**NOTE:** If the system has a BIOS administrator password, enter the password at the prompt.

---

- j. Select the **Main** menu, select **Apply Factory Defaults and Exit**, select **Yes** to save changes and exit, and then select **Shutdown**.
  - k. Reboot the system. If the system has a Trusted Platform Module (TPM) and/or fingerprint reader, one or two prompts will appear—one to clear the TPM and the other to Reset Fingerprint Sensor; press or tap **F1** to accept or **F2** to reject.
  - l. Remove all power and system batteries for at least 24 hours.
2. Complete one of the following:
- Remove and retain the storage drive.
  - or –
  - Clear the drive contents by using a third party utility designed to erase data from an SSD.
  - or –
  - Clear the contents of the drive by using the following BIOS Setup Secure Erase command option steps:



---

**IMPORTANT:** If you clear data using Secure Erase, it cannot be recovered.

---

- a. Turn on or restart the computer, and then press **esc** while the “Press the ESC key for Startup Menu” message is displayed at the bottom of the screen.
- b. Select the **Security** menu and scroll down to the **Utilities** menu.
- c. Select **Hard Drive Utilities**.
- d. Under **Utilities**, select **Secure Erase**, select the hard drive storing the data you want to clear, and then follow the on-screen instructions to continue.



## Nonvolatile memory usage

Nonvolatile Memory Type	Amount (Size)	Does this memory store customer data?	Does this memory retain data when power is removed?	What is the purpose of this memory?	How is data input into this memory?	How is this memory write-protected?
HP Sure Start flash (select models only)	8 MBytes	No	Yes	Provides protected backup of critical System BIOS code, EC firmware, and critical computer configuration data for select platforms that support HP Sure Start.  For more information, see <a href="#">Using HP Sure Start (select models only) on page 100</a> .	Data cannot be written to this device via the host processor. The content is managed solely by the HP Sure Start Embedded Controller.	This memory is protected by the HP Sure Start Embedded Controller.
Real Time Clock (RTC) battery backed-up CMOS configuration memory	256 Bytes	No	Yes	Stores system date and time and noncritical data.	RTC battery backed-up CMOS is programmed using the Computer Setup (BIOS), or changing the Microsoft Windows date & time.	This memory is not write-protected.
Controller (NIC) EEPROM	64 KBytes (not customer accessible)	No	Yes	Stores NIC configuration and NIC firmware.	NIC EEPROM is programmed using a utility from the NIC vendor that can be run from DOS.	A utility is required to write data to this memory and is available from the NIC vendor. Writing data to this ROM in an inappropriate manner will render the NIC non-functional.
DIMM Serial Presence Detect (SPD) configuration data	256 Bytes per memory module, 128 Bytes programmable (not customer accessible)	No	Yes	Stores memory module information.	DIMM SPD is programmed by the memory vendor.	Data cannot be written to this memory when the module is installed in a computer. The specific write-protection method varies by memory vendor.
System BIOS	9 MBytes	Yes	Yes	Stores system BIOS code and computer configuration data.	System BIOS code is programmed at the factory. Code is updated when the system BIOS is updated. Configuration data and settings are input using the Computer Setup (BIOS) or a custom utility.	<b>NOTE:</b> Writing data to this ROM in an inappropriate manner can render the computer non-functional.  A utility is required for writing data to this memory and is available on the HP website; go to <a href="http://www.hp.com/support">http://www.hp.com/support</a> . Select <b>Find your</b>

Nonvolatile Memory Type	Amount (Size)	Does this memory store customer data?	Does this memory retain data when power is removed?	What is the purpose of this memory?	How is data input into this memory?	How is this memory write-protected?
Intel Management Engine Firmware (present only in select Elite or Z models. For more information, go to <a href="http://www.hp.com/support">http://www.hp.com/support</a> . Select <b>Find your product</b> , and then follow the on-screen instructions.)	1.5 MBytes or 7 MBytes	Yes	Yes	Stores Management Engine Code, Settings, Provisioning Data and iAMT third-party data store.	Management Engine Code is programmed at the factory. Code is updated via Intel secure firmware update utility. Unique Provisioning Data can be entered at the factory or by an administrator using the Management Engine (MEBx) setup utility. The third party data store contents can be populated by a remote management console or local applications that have been registered by an administrator to have access to the space.	<b>product</b> , and then follow the on-screen instructions.  The Intel chipset is configured to enforce hardware protection to block all direct read/write access to this area. An Intel utility is required for updating the firmware. Only firmware updates digitally signed by Intel can be applied using this utility.
Bluetooth flash (select products only)	2 Mbit	No	Yes	Stores Bluetooth configuration and firmware.	Bluetooth flash is programmed at the factory. Tools for writing data to this memory are not publicly available but can be obtained from the silicon vendor.	A utility is required for writing data to this memory and is made available through newer versions of the driver whenever the flash requires an upgrade.
802.11 WLAN EEPROM	4 Kbit to 8 Kbit	No	Yes	Stores configuration and calibration data.	802.11 WLAN EEPROM is programmed at the factory. Tools for writing data to this memory are not made public.	A utility is required for writing data to this memory and is typically not made available to the public unless a firmware upgrade is necessary to address a unique issue.
Webcam (select products only)	64 Kbit	No	Yes	Stores webcam configuration and firmware.	Webcam memory is programmed using a utility from the device manufacturer that can be run from Windows.	A utility is required for writing data to this memory and is typically not made available to the public unless a firmware upgrade is necessary to address a unique issue.
Fingerprint reader (select products only)	512 KByte flash	Yes	Yes	Stores fingerprint templates.	Fingerprint reader memory is programmed by user enrollment in HP ProtectTools Security Manager.	Only a digitally signed application can make the call to write to the flash.

# Questions and answers

## 1. How can the BIOS settings be restored (returned to factory settings)?

 **IMPORTANT:** Restore defaults does not securely erase any data on your hard drive. See question and answer 6 for steps to securely erase data.

Restore defaults does not reset the Custom Secure Boot keys. See question and answer 7 for information about resetting the keys.

- a. Turn on or restart the computer, and then press **esc** while the “Press the ESC key for Startup Menu” message is displayed at the bottom of the screen.
- b. Select **Main**, and then select **Apply Factory Defaults and Exit**.
- c. Follow the on-screen instructions.
- d. Select **Main**, select **Save Changes and Exit**, and then follow the on-screen instructions.

## 2. What is a UEFI BIOS, and how is it different from a legacy BIOS?

The Unified Extensible Firmware Interface (UEFI) BIOS is an industry-standard software interface between the platform firmware and an operating system (OS). It is a replacement for the older BIOS architecture, but supports much of the legacy BIOS functionality.

Like the legacy BIOS, the UEFI BIOS provides an interface to display the system information and configuration settings and to change the configuration of your computer before an OS is loaded. BIOS provides a secure run-time environment that supports a Graphic User Interface (GUI). In this environment, you can use either a pointing device (Touchscreen, TouchPad, pointing stick, or USB mouse) or the keyboard to navigate and make menu and configuration selections. The UEFI BIOS also contains basic system diagnostics.

The UEFI BIOS provides functionality beyond that of the legacy BIOS. In addition, the UEFI BIOS works to initialize the computer’s hardware before loading and executing the OS; the run-time environment allows the loading and execution of software programs from storage devices to provide more functionality, such as advanced hardware diagnostics (with the ability to display more detailed system information) and advanced firmware management and recovery software.

HP has provided options in Computer Setup (BIOS) to allow you to run in legacy BIOS, if required by the operating system. Examples of this requirement would be if you upgrade or downgrade the OS.

## 3. Where does the UEFI BIOS reside?

The UEFI BIOS resides on a flash memory chip. A utility is required to write to the chip.

## 4. What kind of configuration data is stored on the DIMM Serial Presence Detect (SPD) memory module? How would this data be written?

The DIMM SPD memory contains information about the memory module, such as size, serial number, data width, speed/timing, voltage, and thermal information. This information is written by the module manufacturer and stored on an EEPROM. This EEPROM cannot be written to when the memory module is installed in a computer. Third-party tools do exist that can write to the EEPROM when the memory module is not installed in a computer. Various third-party tools are available to read SPD memory.

## 5. What is meant by “Restore the nonvolatile memory found in Intel-based system boards”?

This message relates to clearing the Real Time Clock (RTC) CMOS memory that contains computer configuration data.

## 6. How can the BIOS security be reset to factory defaults and data erased?

---

 **IMPORTANT:** Resetting will result in the loss of information.

These steps will not reset Custom Secure Boot Keys. See question and answer 7 for information about resetting the keys.

---

- a. Turn on or restart the computer, and then press **esc** while the “Press the ESC key for Startup Menu” message is displayed at the bottom of the screen.
- b. Select **Main**, and then select **Reset Security to Factory Defaults**.
- c. Follow the on-screen instructions.
- d. Select **Main**, select **Save Changes and Exit**, and then follow the on-screen instructions.

#### 7. How can the Custom Secure Boot Keys be reset?

Secure Boot is a feature to ensure that only authenticated code can start on a platform. If you enabled Secure Boot and created Custom Secure Boot Keys, simply disabling Secure Boot will not clear the keys. You must also select to clear the Custom Secure Boot Keys. Use the same Secure Boot access procedure you used to create the Custom Secure Boot Keys, but make the selection to clear or delete all Secure Boot Keys.

- a. Turn on or restart the computer, and then press **esc** while the “Press the ESC key for Startup Menu” message is displayed at the bottom of the screen.
- b. Select the **Security** menu, select **Secure Boot Configuration**, and then follow the on-screen instructions.
- c. At the **Secure Boot Configuration** window, select **Secure Boot**, select **Clear Secure Boot Keys**, and then follow the on-screen instructions to continue.

## Using HP Sure Start (select models only)

Select computer models are configured with HP Sure Start, a technology that continuously monitors your computer's BIOS for attacks or corruption. If the BIOS becomes corrupted or is attacked, HP Sure Start restores the BIOS to its previously safe state, without user intervention. Those select computer models ship with HP Sure Start configured and enabled. HP Sure Start is configured and already enabled so that most users can use the HP Sure Start default configuration. The default configuration can be customized by advanced users.

To access the latest documentation on HP Sure Start, go to <http://www.hp.com/support>. Select **Find your product**, and then follow the on-screen instructions.

# C Specifications

	<b>U.S.</b>	<b>Metric</b>
<b>Dimensions</b>		
Height	6.89 in	175 mm
Width	6.97 in	177 mm
Depth	1.35 in	34.2 mm
<b>Approximate Weight</b>	2.74 lb	1.25 kg
<b>Temperature Range</b>		
Operating	41° to 113°F	5° to 45°C
Nonoperating	-40° to 151°F	-40° to 66°C
<b>Relative Humidity (noncondensing)</b>		
Operating	5-90%	5-90%
Nonoperating (38.7°C max wet bulb)	5-90%	5-90%
<b>Maximum Altitude (unpressurized)</b>		
Operating	16,404 ft	5000 m
Nonoperating	50,000 ft	15,240 m
<b>Power Supply</b>		
<b>Standard efficiency</b>	65W, 89% efficient	
Operating voltage range	90-264 VAC	
Rated voltage range	100-240 VAC	
Rated line frequency	50-60 Hz	
Operating line frequency	47-63 Hz	
Rated input current	65W $\leq$ 1.6A	
<b>DC output</b>	+19.5V	

---

# Index

- A**
  - access panel
    - illustrated 3
    - locked 56
    - removal 15
  - administrator password 85
  - antenna connector, external 2
  - antenna cover 2
  - audible codes 83
  - audio problems 66
  - audio-out (headphone)/audio-in (microphone) combo jack 1
- B**
  - battery
    - disposal 12
    - installation 24
    - removal 24
  - battery replacement 24
  - beep codes 83
  - BIOS
    - clearing and resetting 87
  - booting options
    - Full Boot 78
    - Quick Boot 78
  - buttons
    - power 1
- C**
  - cautions
    - AC power 7
    - electrostatic discharge 7
    - keyboard cleaning 10
    - keyboard keys 11
  - cleaning
    - computer 10
    - mouse 11
    - safety precautions 10
  - CMOS
    - backing up 85
  - computer
    - specifications 101
  - computer cleaning 10
  - Computer Setup
    - access problem 55
  - connectors
    - external antenna 2
    - power 2
  - country power cord set requirements 94
  - Customer Support 53
- D**
  - disassembly preparation 14
  - DisplayPort 2
  - drive cage
    - removal and replacement 21
  - Dual-Mode DisplayPort 2
- E**
  - electrostatic discharge (ESD) 7
    - preventing damage 8
  - error
    - codes 78, 83
    - messages 78
  - expansion connector board
    - removal and replacement 26
- F**
  - F10 Setup
    - access problem 55
  - fan
    - illustrated 5
    - removal and replacement 30
  - flash drive problems 75
  - flashing LEDs 83
  - front bezel
    - illustrated 3
    - removal and replacement 16
  - front bezel dust filter
    - illustrated 3
    - removal and replacement 14
  - front panel components 1
- G**
  - general problems 55
  - grounding methods 8
- H**
  - hard drive
    - installation 19
    - proper handling 12
    - removal 19
    - SATA characteristics 12
  - hard drive connector
    - removal and replacement 20
  - hard drive problems 59
  - hard drives
    - sizes 4
  - hardware installation problems 70
  - headphone jack 1
  - heat sink
    - illustrated 5
    - removal and replacement 28, 31, 33
  - helpful hints 54
  - hood sensor
    - removal and replacement 17
  - HP PC Hardware Diagnostics UEFI
    - downloading 90
    - starting 90
    - using 89
  - HP PC Hardware Diagnostics Windows
    - downloading 88
    - installing 89
    - using 88
  - HP Sure Start 100
- I**
  - installation guidelines 13
  - installing
    - battery 24
    - hard drive 19
    - memory modules 27
    - solid state drive 22
    - WLAN module 23
  - Internet access problems 75
- J**
  - jacks
    - audio-out (headphone)/audio-in (microphone) combo 1

- headphone 1
- RJ-45 (network) 2
- K**
- keyboard
  - cleaning 10
  - keyboard problems 68
- L**
- LED, main storage 1
- M**
- main storage LED 1
- media card reader
  - problems 61
- memory
  - nonvolatile 95
  - problems 73
  - volatile 95
- memory modules
  - installation 27
  - maximum 27
  - removal 27
  - slots 27
  - specifications 27
- monitor problems 62
- mouse
  - cleaning 11
  - problems 68
- N**
- network problems 71
- nonvolatile memory 95
- numeric error codes 78
- O**
- operating guidelines 9
- overheating, prevention 9
- P**
- padlock loop 2
- password
  - administrator 85
  - clearing 85
  - power-on 85
- ports
  - DisplayPort 2
  - Dual-Mode DisplayPort 2
  - HDMI 2
  - serial 2
  - USB 1, 2
- USB SuperSpeed port with HP
  - Sleep and Charge\* 1
- USB Type-C alternate mode 2
- USB Type-C SuperSpeed with HP
  - Sleep and Charge 1
- VGA 2
- POST error messages 78
- power button, dual-state 1
- power connector 2
- power cord set requirements
  - country specific 94
- power problems 58
- power supply
  - operating voltage range 101
- power-on password 85
- printer problems 67
- problems
  - audio 66
  - Computer Setup 55
  - F10 Setup 55
  - flash drive 75
  - general 55
  - hard drive 59
  - hardware installation 70
  - Internet access 75
  - keyboard 68
  - Media Card Reader 61
  - memory 73
  - monitor 62
  - mouse 68
  - network 71
  - power 58
  - printer 67
  - software 76
- processors
  - illustrated 5
- product ID location 2
- R**
- rear panel components 2
- Remote HP PC Hardware Diagnostics
  - UEFI settings
    - customizing 91
    - using 91
- removal and replacement
  - drive cage 21
  - expansion connector board 26
  - fan 30
  - front bezel 16
  - front bezel dust filter 14
- hard drive connector 20
- heat sink 28, 31, 33
- hood sensor 17
- speaker 18
- system board 34
- WLAN antennas 38
- removing
  - access panel 15
  - battery 24
  - hard drive 19
  - memory modules 27
  - solid state drive 22
  - WLAN module 23
- removing personal data from volatile
  - system memory 95
- resetting
  - CMOS 85
  - password jumper 85
- RJ-45 (network) jack 2
- S**
- safety and comfort 53
- safety precautions
  - cleaning 10
- SATA
  - connectors on system board 12
  - hard drive characteristics 12
- screws, correct size 11
- security cable slot 2
- serial number location 2
- service considerations 11
- slots
  - security cable 2
- software
  - problems 76
  - servicing computer 11
- solid state drive
  - installation 22
  - removal 22
- solid-state drives
  - sizes 4
- speaker
  - illustrated 3
  - removal and replacement 18
- specifications
  - computer 101
- specifications, memory modules 27
- static electricity 7
- status lights
  - RJ-45 (network) 2

- system board
  - illustrated 5
  - removal and replacement 34
  - SATA connectors 12
- system memory, removing personal data from volatile 95

## T

- temperature control 9
- thumbscrew 2
- tools, servicing 11
- Torx T15 screwdriver 11
- tower conversion 40

## U

- USB ports 2
- USB SuperSpeed port 1, 2
- USB SuperSpeed port with HP Sleep and Charge\* 1
- USB Type-C SuperSpeed port with HP Sleep and Charge 1

## V

- ventilation, proper 9

## W

- WLAN antennas
  - removal and replacement 38
- WLAN module
  - installation 23
  - removal 23