

Grandstream Networks, Inc.

GRP2612/GRP2612P/GRP2612W

GRP2613 & GRP2614 & GRP2615

Carrier-Grade IP Phones

User Guide



GRP2612
GRP2612P
GRP2612W



GRP2613



GRP2614



GRP2615



COPYRIGHT

©2019 Grandstream Networks, Inc. <http://www.grandstream.com>

All rights reserved. Information in this document is subject to change without notice. Reproduction or transmittal of the entire or any part, in any form or by any means, electronic or print, for any purpose without the express written permission of Grandstream Networks, Inc. is not permitted.

The latest electronic version of this guide is available for download here:

<http://www.grandstream.com/support>

Grandstream is a registered trademark and Grandstream logo is trademark of Grandstream Networks, Inc. in the United States, Europe and other countries.

CAUTION

Changes or modifications to this product not expressly approved by Grandstream, or operation of this product in any way other than as detailed by this guide, could void your manufacturer warranty.

WARNING

Please do not use a different power adaptor with devices as it may cause damage to the products and void the manufacturer warranty.



U.S. FCC Part 68 Regulatory Information

This equipment complies with Part 68 of the FCC rules. Located on the equipment is a label that contains, among other information, the ACTA registration number and ringer equivalence number (REN). If requested, this information must be provided to the telephone company.

The REN is used to determine the quantity of devices which may be connected to the telephone line. Excessive REN's on the telephone line may result in the devices not ringing in response to an incoming call. In most, but not all areas, the sum of the REN's should not exceed five (5.0). To be certain of the number of devices that may be connected to the line, as determined by the total REN's contact the telephone company to determine the maximum REN for the calling area.

This equipment cannot be used on the telephone company-provided coin service. Connection to Party Line Service is subject to State Tariffs.

If this equipment causes harm to the telephone network, the telephone company will notify you in advance that temporary discontinuance of service may be required. If advance notice isn't practical, the telephone company will notify the customer as soon as possible. Also, you will be advised of your right to file a complaint with the FCC if you believe it is necessary.

The telephone company may make changes in its facilities, equipment, operations, or procedures that could affect the operation of the equipment. If this happens, the telephone company will provide advance notice in order for you to make the necessary modifications in order to maintain uninterrupted service.

If trouble is experienced with this equipment, please contact (Agent in the US):

Company Name: Grandstream Networks, Inc.

Address: 126 Brookline Ave, 3rd Floor Boston, MA 02215, USA

Tel: 1-617-5669300

Fax: 1-617-2491987

If the trouble is causing harm to the telephone network, the telephone company may request you to remove the equipment from the network until the problem is resolved.

This equipment uses the following USOC jacks: RJ45C.

It is recommended that the customer install an AC surge arrester in the AC outlet to which this device is connected. This is to avoid damaging the equipment caused by local lightning strikes and other electrical surges.

Since this device has the HAC function, the earpiece is easy to absorb small, please take care to avoid scratching.



U.S. FCC Part 15 Regulatory Information

This device complies with part 15 of the FCC Rules. Operation is subject to the following two conditions:

(1) This device may not cause harmful interference, and (2) this device must accept any interference received, including interference that may cause undesired operation.

Any Changes or modifications not expressly approved by the party responsible for compliance could void the user's authority to operate the equipment.

Note: This equipment has been tested and found to comply with the limits for a Class B digital device, pursuant to part 15 of the FCC Rules. These limits are designed to provide reasonable protection against harmful interference in a residential installation. This equipment generates, uses and can radiate radio frequency energy and, if not installed and used in accordance with the instructions, may cause harmful interference to radio communications. However, there is no guarantee that interference will not occur in a particular installation. If this equipment does cause harmful interference to radio or television reception, which can be determined by turning the equipment off and on, the user is encouraged to try to correct the interference by one or more of the following measures:

- Reorient or relocate the receiving antenna.
- Increase the separation between the equipment and receiver.
- Connect the equipment into an outlet on a circuit different from that to which the receiver is connected.
- Consult the dealer or an experienced radio/TV technician for help.

This equipment complies with FCC radiation exposure limits set forth for an uncontrolled environment. This equipment should be installed and operated with minimum distance 20cm between the radiator& your body. This transmitter must not be co-located or operating in conjunction with any other antenna or transmitter.



Directive 2014/53/EU Regulatory Information

This applies to GRP2615/GRP2614 only

Operating Frequency Band (RF)	Max Power	
2402-2480MHz (TX&RX)	BT-EDR	8.15dBm
2402-2480MHz (TX&RX)	BT-BLE	7.21dBm
2412-2472MHz (TX&RX)	802.11b	18.15dBm
	802.11g	18.42dBm
	802.11n-20	19.06dBm
5150-5250MHz (TX&RX)	802.11a	19.28dBm
	802.11n-20	18.78dBm
	802.11n-40	19.10dBm
	802.11ac20	18.89dBm
	802.11ac40	18.66dBm
	802.11ac80	15.80dBm
5250-5350MHz (TX&RX)	802.11a	18.63dBm
	802.11n-20	18.60dBm
	802.11n-40	18.93dBm
	802.11ac20	18.59dBm
	802.11ac40	18.38dBm
	802.11ac80	15.85dBm
5470-5725MHz (TX&RX)	802.11a	18.19dBm
	802.11n-20	18.32dBm
	802.11n-40	18.34dBm
	802.11ac20	18.44dBm
	802.11ac40	17.72dBm
	802.11ac80	15.45dBm



Caution: Exposure to Radio Frequency Radiation

This equipment complies with EU radiation exposure limits set forth for an uncontrolled environment. This equipment should be installed and operated with minimum distance of 20 cm between the radiator and your body.

CE Authentication



AT	BE	CY	CZ	DK	EE	FI
FR	DE	EL	HU	IE	IT	LV
LT	LU	MT	NL	PL	PT	SK
SI	ES	SE	UK	BG	RO	HR

In all EU member states, operation of 5150 - 5350 MHz is restricted to indoor use only.

Hereby, Grandstream Networks, Inc. declares that the radio equipment GRP2612W, GRP2614 and GRP2615 are in compliance with Directive 2014/53/EU.

The full text of the EU declaration of conformity is available at the following internet address:

<http://www.grandstream.com/support/resources/>

GNU GPL INFORMATION

GRP26XX firmware contains third-party software licensed under the GNU General Public License (GPL). Grandstream uses software under the specific terms of the GPL. Please see the GNU General Public License (GPL) for the exact terms and conditions of the license.

Grandstream GNU GPL related source code can be downloaded from Grandstream web site from:

http://www.grandstream.com/sites/default/files/Resources/grp_gpl_color.tar.gz



Table of Content

DOCUMENT PURPOSE	13
CHANGE LOG	14
Firmware Version 1.0.1.7	14
Firmware Version 1.0.0.31	14
Firmware Version 1.0.0.16	14
WELCOME	15
PRODUCT OVERVIEW	16
Feature Highlights	16
Technical Specifications	17
GETTING STARTED.....	23
Equipment Packaging	23
Connecting and Setting Up the GRP26XX	24
Using the Phone Stand	24
Using the Slots for Wall Mounting	24
Connecting the GRP26XX	25
GETTING TO KNOW GRP26XX.....	26
Idle Screen	26
Using the Keypad	30
Configuration via Keypad.....	32
MPK LCD (Available on GRP2614 only).....	39
TELEPHONY FEATURES	41
Make Phone Calls	41
<i>Handset, Speaker and Headset Mode.....</i>	<i>41</i>
<i>Multiple SIP Accounts and Lines</i>	<i>41</i>
<i>Completing Calls</i>	<i>41</i>
<i>Making Calls Using IP Addresses.....</i>	<i>45</i>



Answering Phone Calls.....	46
<i>Receiving Calls</i>	46
<i>Do Not Disturb</i>	47
Call Hold.....	49
Call Transfer.....	50
Conference Call.....	53
<i>3-way conferencing</i>	53
<i>Easy Conference Mode</i>	55
UCM Conference.....	56
<i>Participate in UCM Conference Room</i>	56
<i>Conference Call Menu (CCM)</i>	57
<i>Conference Call Operations</i>	57
Call Forwarding.....	59
Voice Mail.....	61
<i>Virtual Voice Mail</i>	61
Instant Messages.....	61
Call Features.....	62
ADVANCED FEATURES.....	65
Virtual Multi-Purpose Keys.....	65
Predictive Dialing.....	71
<i>Search in Call History</i>	71
<i>Search in Broadsoft Directories</i>	72
VPK Paging Support inside the LCD Call Screen.....	74
Active VPK Page.....	74
Line Switching in Call Screen.....	75
Shared Call Appearance (SCA).....	75
Configuring Eventlist BLF.....	76
Screenshots.....	76
Diagnosis.....	76
CONTACTS.....	78
Local Contacts.....	78



Add a single Contact.....	78
Phonebook.....	78
<i>XML Phonebook syntax</i>	78
<i>Dialed Numbers Filtering</i>	80
Contact search mode.....	81
<i>Quick Match</i>	81
<i>Exact Matching</i>	81
LDAP.....	82
Broadsoft Directories.....	82
CALL HISTORY.....	84
Local Call History.....	84
Missed Calls Indication.....	85
CONNECTING TO DEVICES.....	86
EHS Headset.....	86
Bluetooth (GRP2615/GRP2614 only).....	86
WiFi (GRP2615/GRP2614/GRP2612W only).....	89
RESTORE FACTORY DEFAULT SETTINGS.....	92
Restore factory settings using LCD menu.....	92
EXPERIENCING GRP26XX.....	93



Table of Figures

Figure 1: GRP26XX Package Content	23
Figure 2: phone Stand and Mounting Slots on the GRP26XX	24
Figure 3: Tab on the Handset Cradle.....	24
Figure 4: GRP26XX Back / Side View	25
Figure 5: GRP26XX Idle Screen	26
Figure 6: GRP2612/GRP2612P/GRP2612W Keyboard	30
Figure 7: GRP2613 Keyboard.....	30
Figure 8: GRP2614 Keyboard.....	30
Figure 9: GRP2615 Keyboard.....	31
Figure 10: GRP26XX Menu	38
Figure 11: GRP2614 MPK LCD.....	39
Figure 12: Phone LCD Configuration (MPK1).....	39
Figure 13: MPK LCD Configuration (MPK1)	40
Figure 14: On hook dialing	42
Figure 15: Off hook dialing	42
Figure 16: Call using Paging/Intercom	44
Figure 17: Direct IP Call.....	46
Figure 18: Multiple incoming calls	47
Figure 19: Do Not Disturb	48
Figure 20: Call Muted	48
Figure 21: Black/White List from Web GUI	49
Figure 22: Black/White List from LCD	49
Figure 23: On hold duration	50
Figure 24: Dynamic Attended Transfer	51
Figure 25: “Split” softkey	51
Figure 26: “Target” softkey under Transfer Action Page	52
Figure 27: Target - Local Call Log Page	52
Figure 28: Transfer from Information While Ringing and During Incoming Call.....	53
Figure 29: Established Conference	53
Figure 30 : Establish a Conference Call on the GRP2613	54
Figure 31 : Split conference	55
Figure 32: Join UCM Conference.....	56
Figure 33: List of Conference Room Users.....	57
Figure 34: UCM Conference Menu - Invite User.....	57
Figure 35 : UCM Conference room - Kick user.....	58
Figure 36 : UCM Conference room – Mute/ Unmute user.....	58
Figure 37: UCM Conference Menu - Bridge Conference	59



Figure 38 : UCM Conference Menu - More.....	59
Figure 39: Disabled Call Forward.....	60
Figure 40: Enable Call Forward	60
Figure 41: Diversion Information	60
Figure 42: Instant Messages sub-menu	61
Figure 43: Sending an Instant Message.....	62
Figure 44: IM Sent Successfully.....	62
Figure 45 : Feature Codes List.....	64
Figure 46: VPK Page.....	65
Figure 47: Edit VPK - Fixed VPK.....	65
Figure 48: Edit VPK - Dynamic VPK.....	66
Figure 49: Line Key as Transfer Mode	68
Figure 50: VPK - LCD Indication	68
Figure 51: toggle between screens in call screen	71
Figure 52: Predictive Dialing	72
Figure 53: Broadsoft XSI web configuration	73
Figure 54: Predictive Dialing from BS XSI Directories.....	74
Figure 55: VPK Paging	74
Figure 56: Active VPK Page.....	75
Figure 57: Line Switching.....	75
Figure 58: Screenshots.....	76
Figure 59: Factory Functions	77
Figure 60: New contact.....	78
Figure 61: Local Phonebook - Contact Information.....	79
Figure 62: Local Phonebook - Company/Title/Job Fields	80
Figure 63: Contact Numbers with Special Characters.....	80
Figure 64: Call with Filtered Characters	80
Figure 65: Before Search.....	81
Figure 66: QuickMatch.....	81
Figure 67: ExactMatch.....	82
Figure 68: LDAP search.....	82
Figure 69: Search in Broadsoft Directories	83
Figure 70: Call History Screen Page	84
Figure 71: Missed Calls	85
Figure 72: Headset enabled.....	86
Figure 73: Bluetooth feature.....	87
Figure 74: Bluetooth Scan	87
Figure 75: GRP2615/GRP2614 Pairing Process	87
Figure 76: Successful Bluetooth pairing	88
Figure 77: Bluetooth Status	88
Figure 78: Pairing Request	88
Figure 79: WiFi feature	89
Figure 80; Enable WiFi	89



Figure 81: WiFi Scanning.....	90
Figure 82: Nearby WiFi networks.....	90
Figure 83: WiFi password required.....	90
Figure 84: Failed/Successful WiFi connection.....	91
Figure 85: WiFi Status.....	91
Figure 86 : Current connection.....	91
Figure 87: Factory Reset using LCD Menu.....	92

Table of Tables

Table 1: GRP2612/GRP2612P/GRP2612W/GRP2613/GRP2614/GRP2615 Features in a glance.....	16
Table 2: GRP26XX Comparison Guide.....	17
Table 3: GRP2612/GRP2612P/GRP2612W Technical Specifications.....	18
Table 4: GRP2613 Technical Specifications.....	19
Table 5: GRP2614 Technical Specifications.....	20
Table 6: GRP2615 Technical Specifications.....	21
Table 8: Equipment Packaging.....	23
Table 9: LCD Display Definitions.....	26
Table 10: GRP26XX LCD icons.....	28
Table 11: GRP26XX Keypad Buttons.....	31
Table 12: Configuration Menu.....	32
Table 13: Call Features.....	62
Table 14: VPK Modes in String Format.....	66
Table 15: VPK Modes Icon Indications.....	69



DOCUMENT PURPOSE

This document describes how to configure the GRP26XX via phone's LCD menu and web UI menu to fully manipulate phone's features. To learn advanced functions of GRP26XX, please visit <http://www.grandstream.com/support> to download the latest "GRP26XX Administration Guide".

This guide covers following topics:

- [Product Overview](#)
- [Getting started](#)
- [Getting to know GRP26XX](#)
- [Telephony features](#)
- [Advanced features](#)
- [Contacts](#)
- [Call History](#)
- [Connecting to devices](#)
- [Restore to factory default settings](#)



CHANGE LOG

This section documents significant changes from previous versions of user manuals for GRP26XX. Only major new features or major document updates are listed here. Minor updates for corrections or editing are not documented here.

Firmware Version 1.0.1.7

- Added support for GRP2615
- Added support of Bluetooth handsfree feature. [Bluetooth]
- Improved Feature of blacklist and whitelist in Contact. [Black/White Listing]

Firmware Version 1.0.0.31

- Added support for more MPK/VPK modes [VIRTUAL MULTI-PURPOSE KEYS]
- UCM conference room updates [UCM CONFERENCE]

Firmware Version 1.0.0.16

- This is the initial version for GRP26XX.



WELCOME

Thank you for purchasing Grandstream GRP26XX Carrier-Grade IP Phones.

GRP2612/GRP2612P/GRP2612W is featuring 4 dual-color line keys (can be digitally programmed as up to 16 provisionable BLF/fast-dial keys), 2.4" (320x240) TFT color LCD, 4 programmable context-sensitive soft keys, 100M network ports, integrated PoE (GRP2612P & GRP2612W only), integrated dual-band WiFi (GRP2612W only), 3-way conference, and Electronic Hook Switch (EHS).

GRP2613 is featuring 6 dual-color line keys (can be digitally programmed as up to 24 provisionable BLF/fast-dial keys), 2.8" (320x240) TFT color LCD, 4 programmable context-sensitive soft keys, 1000M network ports, integrated PoE, 3-way conference, and Electronic Hook Switch (EHS).

GRP2614 is featuring 4 dual-color line keys (can be digitally programmed as up to 16 provisionable BLF/fast-dial keys), 2.8" (320x240) TFT color LCD, 4 programmable context-sensitive soft keys, 2.4" (320x240) additional screen dedicated to up to 24 multi-purpose keys, 1000M network ports, integrated PoE, Wi-Fi and Bluetooth support, 3-way conference and Electronic Hook Switch (EHS).

GRP2615 is featuring 10 dual-color line keys (can be digitally programmed as up to 40 provisionable BLF/fast-dial keys), 4.3" (480x272) TFT color LCD, 5 programmable context-sensitive soft keys, 1000M network ports, integrated PoE, Wi-Fi and Bluetooth support, 3-way conference and Electronic Hook Switch (EHS).

The GRP26XX series deliver superior HD audio quality, rich and leading-edge telephony features, protection for privacy, and broad interoperability with most 3rd party SIP devices and leading SIP/NGN/IMS platforms. GRP26XX series is the perfect choice for enterprise users looking for a high quality, feature rich multi-line executive IP phone with advanced functionalities and performance.







PRODUCT OVERVIEW

Feature Highlights

The following tables contain the major features of the GRP26XX:

Table 1: GRP2612/GRP2612P/GRP2612W/GRP2613/GRP2614/GRP2615 Features in a glance

	<p>GRP2612 GRP2612P GRP2612W</p>	<ul style="list-style-type: none"> • 4 dual-color line keys (can be digitally programmed as up to 16 provisionable BLF/fast-dial keys). • 2.4" (320x240) TFT color LCD. • 4 programmable context-sensitive soft keys. • 100M network ports. • Integrated PoE (GRP2612P & GRP2612W only). • 3-way conference. • Electronic Hook Switch (EHS). • Wi-Fi support (GRP2612W only).
	<p>GRP2613</p>	<ul style="list-style-type: none"> • 6 dual-color line keys (can be digitally programmed as up to 24 provisionable BLF/fast-dial keys). • 2.8" (320x240) TFT color LCD. • 4 programmable context-sensitive soft keys. • 1000M network ports. • integrated PoE. • 3-way conference. • Electronic Hook Switch (EHS).
	<p>GRP2614</p>	<ul style="list-style-type: none"> • 4 dual-color line keys (can be digitally programmed as up to 16 provisionable BLF/fast-dial keys). • 2.8" (320x240) TFT color LCD. • 4 programmable context-sensitive soft keys. • 2.4" (320x240) additional screen dedicated to up to 24 multi-purpose keys. • 1000M network ports. • Integrated PoE. • Wi-Fi and Bluetooth support. • 3-way conference. • Electronic Hook Switch (EHS).



GRP2615

- 10 dual-color line keys (can be digitally programmed as up to 40 provisionable BLF/fast-dial keys).
- 4.3" (480x272) TFT color LCD.
- 5 programmable context-sensitive soft keys.
- 1000M network ports.
- Integrated PoE.
- Wi-Fi and Bluetooth support.
- 3-way conference.
- Electronic Hook Switch (EHS).

Table 2: GRP26XX Comparison Guide

Features	GRP2612 GRP2612P GRP2612W	GRP2613	GRP2614	GRP2615
LCD Display	320x240	320x240	320x240	480x272
LCD Backlight	Yes	Yes	Yes	Yes
Electronic Hook Switch	Yes	Yes	Yes	Yes
Number of Lines	4	6	4	10
Programmable Hard Keys	16	24	16	40
Programmable Soft Keys	4	4	4	5
MPK LCD	No	No	Yes	No
PoE	GRP2612P only	Yes	Yes	Yes
Network ports	100M	1000M	1000M	1000M
Conference	3-way	3-way	3-way	3-way
Bluetooth	No	No	Yes	Yes
WiFi	GRP2612W only	No	Yes	Yes

Technical Specifications

The following table resumes all the technical specifications including the protocols / standards supported, voice codecs, telephony features, languages and upgrade/provisioning settings for the GRP26XX series.



Table 3: GRP2612/GRP2612P/GRP2612W Technical Specifications

Protocols/Standards	SIP RFC3261, TCP/IP/UDP, RTP/RTCP/RTCP-XR, HTTP/HTTPS, ARP, ICMP, DNS (A record, SRV, NAPTR), DHCP, PPPoE, SSH, TFTP, FTP/FTPS, NTP, STUN, SIMPLE, LLDP, LDAP, TR-069, 802.1x, TLS, SRTP, IPv6
Network Interfaces	Dual switched auto-sensing 10/100 Mbps Ethernet ports, with integrated PoE (only GRP2612P/GRP2612W)
Graphic Display	2.4 inch (320x240) TFT color LCD
Feature Keys	4 line keys with up to 2 SIP accounts, 4 programmable contexts sensitive Softkeys, 5 navigation/menu keys, 9 dedicated function keys for: MESSAGE (with LED indicator), TRANSFER, HOLD, HEADSET, MUTE, SEND/REDIAL, SPEAKERPHONE, VOLUME+, VOLUME-
Voice Codec	Support for G.729A/B, G723.1, G.711 μ /a-law, G.726, G.722 (wide-band), ILBC, OPUS and in-band and out-of-band DTMF (in audio, RFC2833, SIP INFO)
Auxiliary Ports	RJ9 headset jack (allowing EHS with Plantronics headsets)
Telephony Features	Hold, transfer, forward, 3-way conference, call park, call pickup, shared-call-appearance (SCA), bridged-line-appearance (BLA), downloadable phonebook (XML, LDAP, up to 1000 items), call waiting, call log (up to 2000 records), customization of screen, off-hook auto dial, auto answer, click-to-dial, flexible dial plan, hot desking, personalized music ringtones and music on hold, server redundancy and fail-over
HD audio	Yes, both on handset and full-duplex handsfree speakerphone
Base Stand	Yes, allow 2 angle positions
Wall Mountable	Yes
QoS	Layer 2 (802.1Q, 802.1p) and Layer 3 (ToS, DiffServ, MPLS) QoS
Security	User and administrator level passwords, MD5 and MD5-sess based authentication, AES based secure configuration file, SRTP, TLS, 802.1x media access control
Multi-language	English, Arabic, Chinese, Croatian, Czech, Dutch, German, French, Hebrew, Hungarian, Italian, Japanese, Korean, Polish, Portuguese, Russian, Slovenia, Spanish, Turkish
Upgrade/Provisioning	Firmware upgrade via TFTP/FTP/FTPS/HTTP/HTTPS, mass provisioning using TR-069 or encrypted XML configuration file
Power & Green Energy Efficiency	Universal power adapter included: Input:100-240 VAC; Output: +5VDC, 0.5A; Integrated Power-over-Ethernet (802.3af)
Physical	Dimension : 203mm x 193mm x 52.1mm Unit weight:554g Package weight:936g
Temperature and Humidity	32-104°F / 0~40°C, 10-90% (non- condensing)



Package Content	GRP2612/GRP2612P/GRP2612W phone, handset with cord, base stand, universal power supply (except GRP2612P), network cable, Quick Installation Guide
Compliance	<p>GRP2612/GRP2612P: FCC: FCC Part 15B, Class B; FCC Part 68 HAC. CE: EN 55032; EN 55035; EN 61000-3-2; EN 61000-3-3; EN 62368-1. RCM: AS/NZS CISPR 32; AS/NZS 62368.1; AS/CA S004.</p> <p>GRP2612W: FCC: FCC Part 15B, Class B; FCC Part 15 Subpart C; FCC Part 15 Subpart E; FCC Part 68 HAC. CE: EN 55032; EN 55035; EN 61000-3-2; EN 61000-3-3; EN 62368-1; EN 301 489-1/-17; EN 300 328; EN 301 893; EN 62311; RCM: AS/NZS CISPR 32; AS/NZS 62368.1; AS/NZS 4268; AS/CA S004.</p>

Table 4: GRP2613 Technical Specifications

Protocols/Standards	SIP RFC3261, TCP/IP/UDP, RTP/RTCP/RTCP-XR, HTTP/HTTPS, ARP, ICMP, DNS (A record, SRV, NAPTR), DHCP, PPPoE, SSH, TFTP, FTP/FTPS NTP, STUN, SIMPLE, LLDP, LDAP, TR-069, 802.1x, TLS, SRTP, IPv6
Network Interfaces	Dual switched auto-sensing 10/100/1000 Mbps Ethernet ports with integrated PoE
Graphic Display	2.8 inch (320x240) TFT color LCD
Feature Keys	6 line keys with up to 3 SIP accounts, 5 navigation/menu keys, 9 dedicated function keys for: MESSAGE (with LED indicator), TRANSFER, HOLD, HEADSET, MUTE, SEND/REDIAL, SPEAKERPHONE, VOLUME+, VOLUME-
Voice Codec	Support for G.723.1, G.729A/B, G.711 μ /a-law, G.726, G.722 (wide-band), OPUS, iLBC and in-band and out-of-band DTMF (in audio, RFC2833, SIP INFO)
Auxiliary Ports	RJ9 headset jack (allowing EHS with Plantronics headsets).
Telephony Features	Hold, transfer, forward, 3-way conference, call park, call pickup, shared-call-appearance (SCA)/bridged-line-appearance (BLA), downloadable phonebook (XML, LDAP, up to 1000 items), call waiting, call log (up to 2000 records), customization of screen, off-hook auto dial, auto answer, click-to-dial, flexible dial plan, hot desking, personalized music ringtones and music on hold, server redundancy and fail-over
HD audio	Yes, both on handset and full-duplex handsfree speakerphone
Base Stand	Yes, allow 2 angle positions
Wall Mountable	Yes
QoS	Layer 2 (802.1Q, 802.1p) and Layer 3 (ToS, DiffServ, MPLS) QoS
Security	User and administrator level passwords, MD5 and MD5-sess based authentication, AES based secure configuration file, SRTP, TLS, 802.1x media access control



Multi-language	English, Arabic, Chinese, Croatian, Czech, Dutch, German, French, Hebrew, Hungarian, Italian, Japanese, Korean, Polish, Portuguese, Russian, Slovenia, Spanish, Turkish
Upgrade/Provisioning	Firmware upgrade via TFTP/FTP/FTPS/HTTP/HTTPS, mass provisioning using TR-069 or encrypted XML configuration file
Power & Green Energy Efficiency	Universal power adapter included: Input:100-240 VAC; Output: +5VDC, 0.5A; Integrated Power-over-Ethernet (802.3af) Max power consumption 6W.
Physical	Dimension : 203mm x 193mm x 52.1mm Unit weight:554g Package weight:936g
Temperature and Humidity	32-104°F / 0~40°C, 10-90% (non- condensing)
Package Content	GRP2613 phone, handset with cord, base stand, universal power supply, network cable, Quick Installation Guide
Compliance	FCC: FCC Part 15B, Class B; FCC Part 68 HAC. CE: EN 55032; EN 55035; EN 61000-3-2; EN 61000-3-3; EN 62368-1. RCM: AS/NZS CISPR 32; AS/NZS 62368.1; AS/CA S004.

Table 5: GRP2614 Technical Specifications

Protocols/Standards	SIP RFC3261, TCP/IP/UDP, RTP/RTCP/RTCP-XR, HTTP/HTTPS, ARP, ICMP, DNS (A record, SRV, NAPTR), DHCP, PPPoE, SSH, TFTP, FTP/FTPS, NTP, STUN, SIMPLE, LLDP, LDAP, TR-069, 802.1x, TLS, SRTP, IPv6
Network Interfaces	Dual switched auto-sensing 10/100/1000 Mbps Ethernet ports with integrated PoE
Graphic Display	2.8 inch (320x240) TFT color LCD – 2.4 inch MPK color LCD
Bluetooth	Yes, Bluetooth 5
Wi-Fi	Yes, dual-band
Feature Keys	4 line keys with up to 4 SIP accounts, 24 speed-dial/BLF extension keys with dual-color LED, 4 programmable contexts sensitive Softkeys, 5 navigation/menu keys, 11 dedicated function keys for: MESSAGE (with LED indicator), PHONEBOOK, TRANSFER, CONFERENCE, HOLD, HEADSET, MUTE, SEND/REDIAL, SPEAKERPHONE, VOLUME+, VOLUME-
Voice Codec	Support for G.729A/B, G.711μ/a-law, G.726, G.722 (wide-band), OPUS, iLBC and in-band and out-of-band DTMF (in audio, RFC2833, SIP INFO)
Auxiliary Ports	RJ9 headset jack (allowing EHS with Plantronics headsets).
Telephony Features	Hold, transfer, forward, 3-way conference, call park, call pickup, shared-call-appearance (SCA)/bridged-line-appearance (BLA), downloadable phonebook (XML, LDAP, up to 2000 items), call waiting, call log (up to 2000 records), customization of screen, off-hook auto dial, auto answer, click-to-dial, flexible dial

	plan, Hot Desking, personalized music ringtones and music on hold, server redundancy and fail-over
HD audio	Yes, both on handset and full-duplex handsfree speakerphone
Base Stand	Yes, allow 2 angle positions
Wall Mountable	Yes
QoS	Layer 2 (802.1Q, 802.1p) and Layer 3 (ToS, DiffServ, MPLS) QoS
Security	User and administrator level passwords, MD5 & MD5-sess based authentication, AES based secure configuration file, SRTP, TLS, 802.1x media access control
Multi-language	English, Arabic, Chinese, Croatian, Czech, Dutch, German, French, Hebrew, Hungarian, Italian, Japanese, Korean, Polish, Portuguese, Russian, Slovenia, Spanish, Turkish
Upgrade/Provisioning	Firmware upgrade via TFTP/FTP/FTPS/HTTP/HTTPS, mass provisioning using TR-069 or encrypted XML configuration file
Power & Green Energy Efficiency	Universal power adapter included: Input:100-240V; Output: +12V, 0.5A; Integrated Power-over-Ethernet (802.3af) Max power consumption: 6W
Physical	Dimension : 234mm x 213mm x 82.2mm Unit weight: 950g Package weight: 1460g
Temperature and Humidity	32-104°F / 0~40°C, 10-90% (non- condensing)
Package Content	GRP2614 phone, handset with cord, base stand, universal power supply, network cable, Quick Installation Guide
Compliance	FCC: FCC Part 15B, Class B; FCC Part 15 Subpart C; FCC Part 15 Subpart E; FCC Part 68 HAC. CE: EN 55032; EN 55035; EN 61000-3-2; EN 61000-3-3; EN 62368-1; EN 301 489-1/-17; EN 300 328; EN 301 893; EN 62311; RCM: AS/NZS CISPR 32; AS/NZS 60950.1; AS/NZS 4268; AS/CA S004.

Table 6: GRP2615 Technical Specifications

Protocols/Standards	SIP RFC3261, TCP/IP/UDP, RTP/RTCP/RTCP-XR, HTTP/HTTPS, ARP, ICMP, DNS (A record, SRV, NAPTR), DHCP, PPPoE, SSH, TFTP, FTP/FTPS, NTP, STUN, SIMPLE, LLDP, LDAP, TR-069, 802.1x, TLS, SRTP, IPv6
Network Interfaces	Dual switched auto-sensing 10/100/1000 Mbps Ethernet ports with integrated PoE
Graphic Display	4.3 inch (480x272) TFT color LCD
Bluetooth	Yes, Bluetooth version 5
Wi-Fi	Yes, dual-band
Feature Keys	10 line keys with up to 16 SIP accounts, 24 speed-dial/BLF extension keys with dual-color LED, 5 programmable contexts sensitive Softkeys, 5 navigation/menu



	keys, 11 dedicated function keys for: MESSAGE (with LED indicator), TRANSFER, HOLD, HEADSET, MUTE, SEND/REDIAL, SPEAKERPHONE, VOLUME+, VOLUME-
Voice Codec	Support for G.729A/B, G.711 μ /a-law, G.726, G.722 (wide-band), OPUS, iLBC and in-band and out-of-band DTMF (in audio, RFC2833, SIP INFO)
Auxiliary Ports	RJ9 headset jack (allowing EHS with Plantronics headsets), USB port.
Telephony Features	Hold, transfer, forward, 3-way conference, call park, call pickup, shared-call-appearance (SCA)/bridged-line-appearance (BLA), downloadable phonebook (XML, LDAP, up to 2000 items), call waiting, call log (up to 2000 records), customization of screen, off-hook auto dial, auto answer, click-to-dial, flexible dial plan, Hot Desking, personalized music ringtones and music on hold, server redundancy and fail-over
HD audio	Yes, both on handset and full-duplex handsfree speakerphone
Extension Module	Yes, can power up to 4 GBX20 modules which features 4.3" Color LCD, 20 quick-dial/BLF keys which dual-color LED, 2 navigation keys.
Base Stand	Yes, allow 2 angle positions
Wall Mountable	Yes
QoS	Layer 2 (802.1Q, 802.1p) and Layer 3 (ToS, DiffServ, MPLS) QoS
Security	User and administrator level passwords, MD5 & MD5-sess based authentication, AES based secure configuration file, SRTP, TLS, 802.1x media access control
Multi-language	English, Arabic, Chinese, Croatian, Czech, Dutch, German, French, Hebrew, Hungarian, Italian, Japanese, Korean, Polish, Portuguese, Russian, Slovenia, Spanish, Turkish
Upgrade/Provisioning	Firmware upgrade via TFTP/FTP/FTPS/HTTP/HTTPS, mass provisioning using TR-069 or encrypted XML configuration file
Power & Green Energy Efficiency	Universal power adapter included: Input:100-240V; Output: +12V, 0.5A; Integrated Power-over-Ethernet (802.3af)
Physical	Dimensions : 243mm x 210mm x 82.3mm Unit weight:970g Package weight:1480g
Temperature and Humidity	32-104°F / 0~40°C, 10-90% (non- condensing)
Package Content	GRP2615 phone, handset with cord, base stand, universal power supply, network cable, Quick Installation Guide
Compliance	FCC: FCC Part 15B, Class B; FCC Part 15 Subpart C; FCC Part 15 Subpart E; FCC Part 68 HAC. CE: EN 55032; EN 55035; EN 61000-3-2; EN 61000-3-3; EN 62368-1; EN 301 489-1/-17; EN 300 328; EN 301 893; EN 62311; RCM: AS/NZS CISPR 32; AS/NZS 60950.1; AS/NZS 4268; AS/CA S004.



GETTING STARTED

This chapter provides basic installation instructions including the list of the packaging contents and also information for obtaining the best performance with the GRP26XX phone.

Equipment Packaging

Table 7: Equipment Packaging

GRP26XX
<ul style="list-style-type: none"> • 1 x GRP26XX Main Case. • 1 x Handset. • 1 x Phone Stand. • 1 x Ethernet Cable. • 1 x Power Adapter. • 1 x Phone cord. • 1 x Quick Installation Guide. • 1 x GPL License.

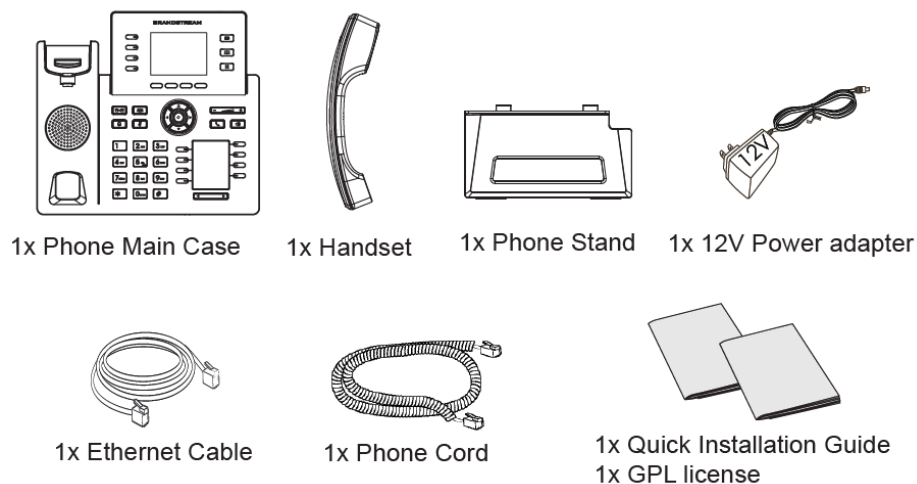

Figure 1: GRP26XX Package Content

Note:

Check the package before installation. If you find anything missing, contact your system administrator.

Connecting and Setting Up the GRP26XX

The GRP26XX phones can be installed on the desktop using the phone stand or attached on the wall using the slots for wall mounting.

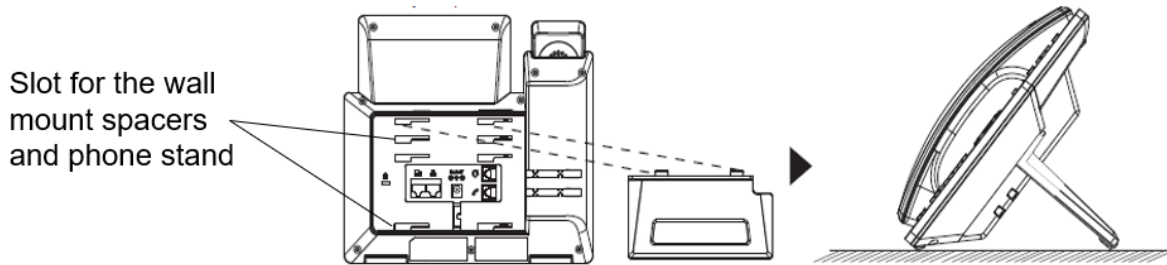

Figure 2: phone Stand and Mounting Slots on the GRP26XX

Using the Phone Stand

To install the phone on the table with the phone stand, attach the phone stand to the bottom of the phone through the phone stand slot. (Upper half, bottom part).

Using the Slots for Wall Mounting

1. Attach the wall mount spacers to the slot for wall mount spacers on the back of the phone.
2. Attach the phone to the wall via the wall mount hole.
3. Pull out the tab from the handset cradle (See figure below).
4. Rotate the tab and plug it back into the slot with the extension up to hold the handset while the phone is mounted on the wall (See figure below).

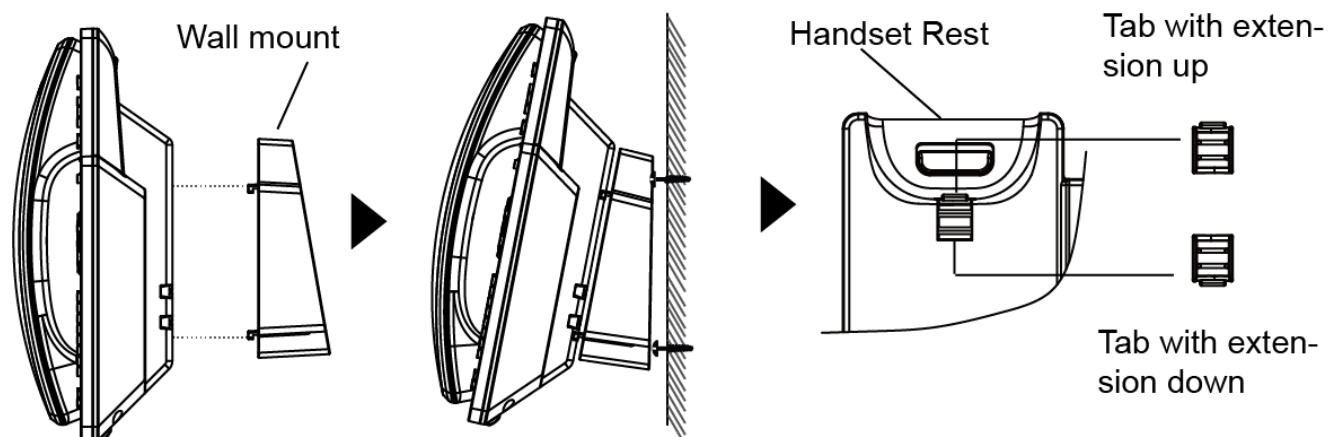

Figure 3: Tab on the Handset Cradle

Connecting the GRP26XX

To setup the GRP26XX, follow the steps below:

1. Connect the handset and main phone case with the phone cord.
2. Connect the LAN port of the phone to the RJ-45 socket of a hub/switch or a router (LAN side of the router) using the Ethernet cable.
3. Connect the PSU output plug to the power jack on the phone; plug the power adapter into an electrical outlet. If PoE switch is used in step 2, this step could be skipped.
4. The LCD will display provisioning or firmware upgrade information. Before continuing, please wait for the date/time display to show up.
5. Using the phone embedded web server or keypad configuration menu, you can further configure the phone using either a static IP or DHCP.

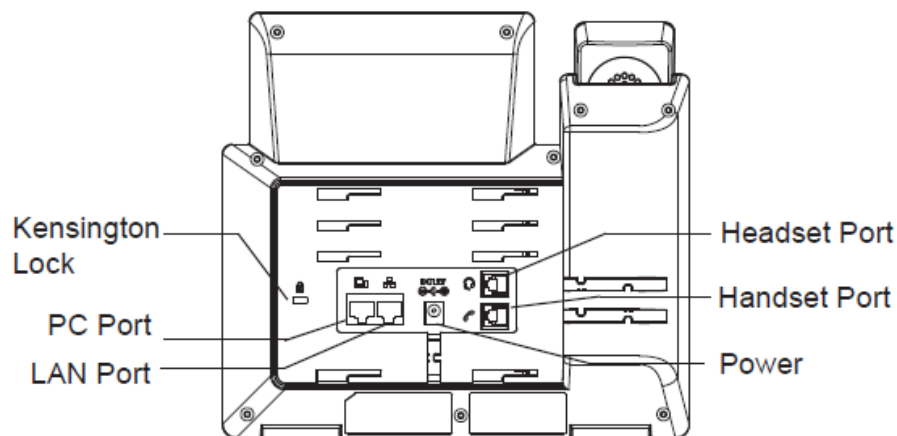

Figure 4: GRP26XX Back / Side View

GETTING TO KNOW GRP26XX

Idle Screen

GRP26XX screen displays differently depending on whether the phone is idle or in use (active). The following figures show the idle screen of GRP2612/GRP2612P/GRP2612W/GRP2613/GRP2614 /GRP2615.



Figure 5: GRP26XX Idle Screen

The following table describes the items displayed on the GRP26XX idle screen:

Table 8: LCD Display Definitions

Date and Time	Displays the current date and time. It can be synchronized with Internet time servers.
Network icon	Shows the status of network. It will indicate whether the network is down or starting.
Status icon	Shows the status of the phone for registration status, call features and etc, using icons as shown in the next table.
Line status indicator	Displays the name of the account that is in use.
Softkeys in idle screen	<p>The softkeys are context sensitive and will change depending on the status of the phone. Typical functions assigned to softkeys are:</p> <ul style="list-style-type: none"> • SwitchSCR/NEXTSCR Toggles between different idle screens: Press the most left softkey (or RIGHT/LEFT arrow buttons) to switch screens. • ForwardAll Unconditionally forwards the phone line (account 1) to another phone.

Softkeys in call screen











- **MissedCalls**
Shows up unanswered calls to this phone.
- **Redial**
Redials the last dialed number









The softkeys are context sensitive and will change depending on the call status of the phone. Here are the main softkeys in call screen.

- **Redial**
Redials the last dialed number after off hook when there is existed call log.
- **Dial**
Dials the call out after off hook and entering the number.
- **AnswerCall**
Answers the incoming call when the phone is ringing.
- **RejectCall**
Rejects the incoming call when the phone is ringing.
- **EndCall**
Ends the active call.
- **Transfer**
Transfer softkey will show up after pressing TRAN button and entering transfer target number. Press Transfer softkey to do blind transfer.
- **Split**
In auto-attended transfer mode, after establishing the second call, press Split to quit transfer and go back to normal talking status.
- **ConfCall**
Conferences the active calls.
- **ReConf**
Re-establish the conference among the calls on hold.



Table 9: GRP26XX LCD icons

	Network Status. OFF - Network connection is up ON - Network connection is down
	DND Status. OFF - Do Not Disturb disabled ON - Do Not Disturb enabled
	Call Forward All Status. OFF - Call Forward All feature disabled ON - Call Forward All feature enabled
	Call Forward Busy Status. OFF - Call Forward Busy feature disabled ON - Call Forward Busy feature enabled
	Call Forward No Answer Status. OFF - Call Forward No Answer feature disabled ON - Call Forward No Answer feature enabled
	Call Forward Busy and Call Forward No Answer Status. OFF - Call Forward All and Call Forward No Answer feature disabled ON - Call Forward All and Call Forward No Answer feature enabled
	Missed Call Status. OFF - No missed call ON - New missed call
	Handset Status. OFF - Handset is not in use ON - Handset is in use
	Headset Status. OFF - Headset is not in use ON - Headset is in use
	Microphone MUTE Status. OFF - No muted ON - Muted

	<p>Bluetooth Status. (GRP2614/GRP2615 only)</p> <p>OFF - Bluetooth icon disappears</p> <p>ON - Bluetooth icon appears</p> <p>Paired – Bluetooth icon turns bright</p>
	<p>Incoming Call.</p> <p>The current call is an incoming call</p>
	<p>Outgoing Call.</p> <p>The current call is an outgoing call</p>
	<p>Call On Hold.</p> <p>OFF - No call on hold</p> <p>ON – Call on hold</p>
	<p>Call Connect.</p> <p>OFF - No call</p> <p>ON - Call connected</p>
	<p>IP Call Status</p> <p>The current call is an IP call.</p>
	<p>SIP Call</p> <p>Enter number for initiate call. The current call is a SIP call.</p>
	<p>Ringtone Volume</p> <p>Call screen icon.</p>
	<p>Ringtone Volume mute</p> <p>Call screen icon. The volume of ringtone is mute</p>

Using the Keypad

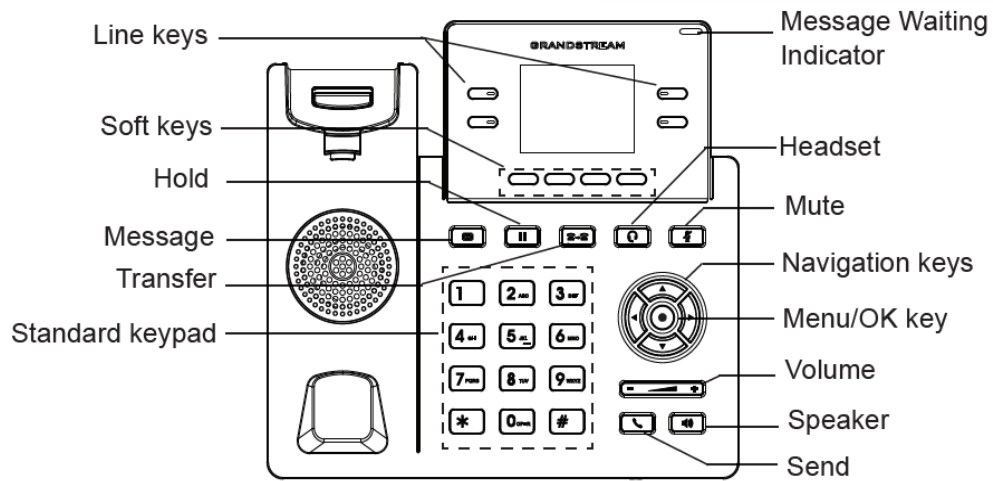

Figure 6: GRP2612/GRP2612P/GRP2612W Keyboard

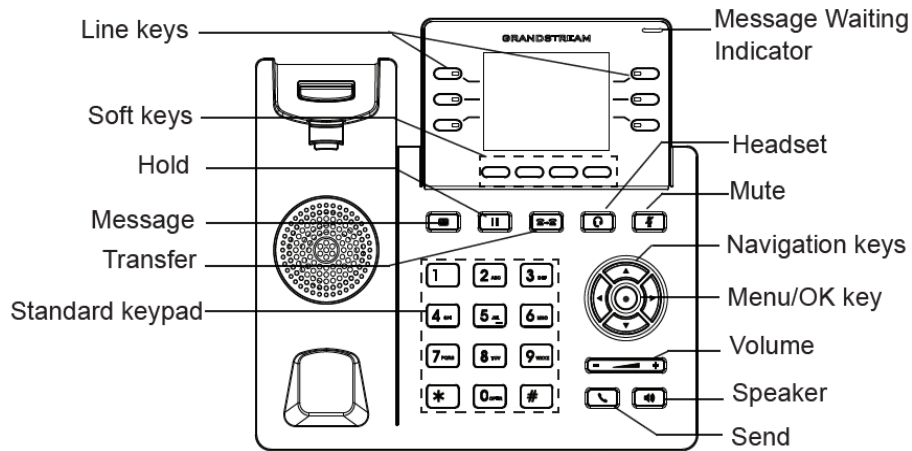

Figure 7: GRP2613 Keyboard

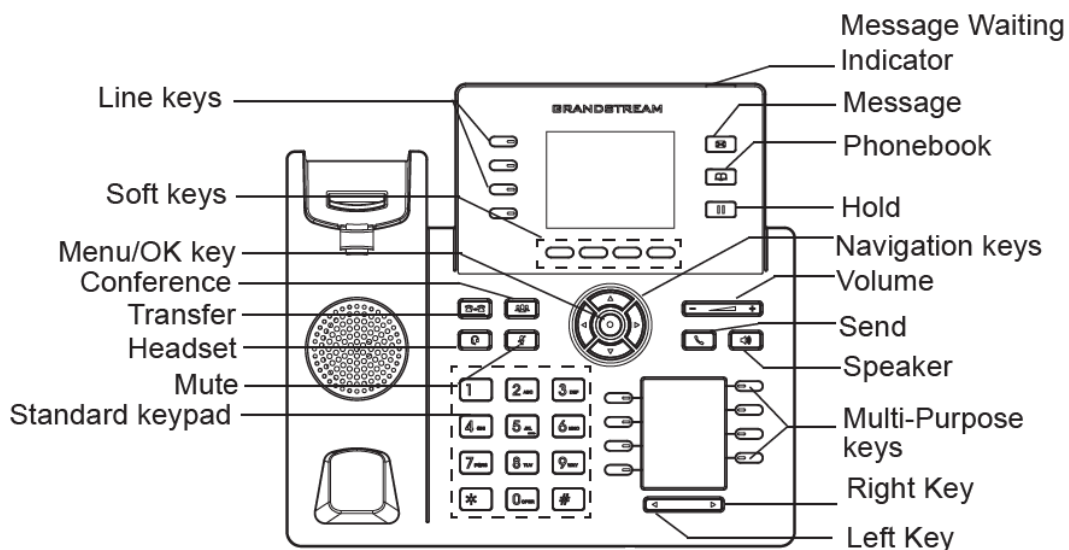

Figure 8: GRP2614 Keyboard



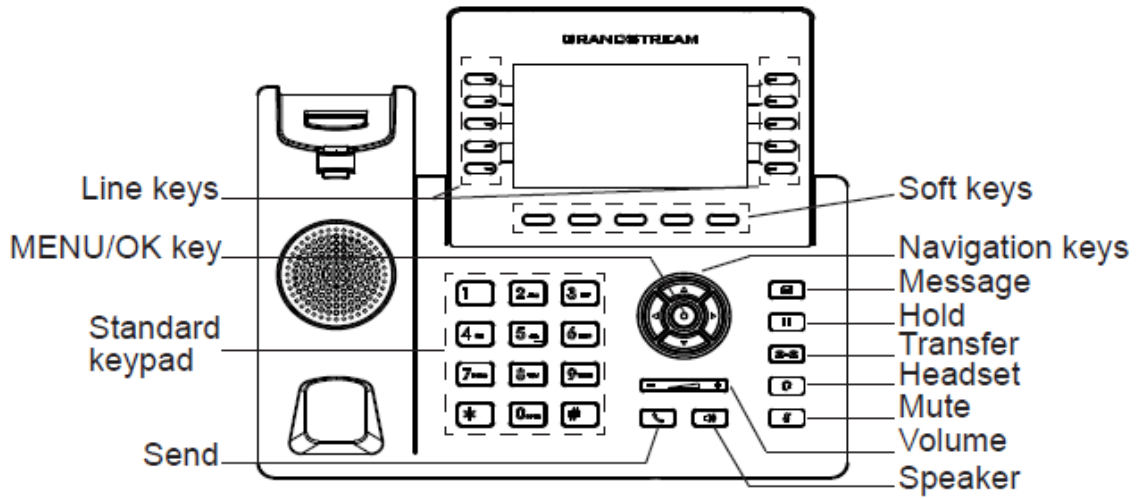









Figure 9: GRP2615 Keyboard

Table 10: GRP26XX Keypad Buttons

	Contacts. Press to view and edit contact information.
	Hold. Press to put call on hold or resume the call.
	Mute. Press to mute or unmute the call.
	Headset. Press to switch to headset mode.
	Message. Press to view voicemail messages.
	Transfer. Press to transfer call.
	Conference. Press to conference call.
	Speaker.
	Send/Redial.
	Volume.
	Up Navigation key. In idle screen, press for 3 seconds to see the IP.
	MENU button

Configuration via Keypad

To configure the LCD menu using the phone's keypad, follow the instructions below:

- **Enter MENU options.** When the phone is in idle, press the round MENU button to enter the configuration menu.
- **Navigate in the menu options.** Press the arrow keys up/down/left/right to navigate in the menu options.
- **Enter/Confirm selection.** Press the round MENU button or "Select" Softkey to enter the selected option.
- **Exit.** Press "Exit" Softkey to exit to the previous menu.
- **Return to Home page.**

In the Main menu, press Home Softkey to return home screen.

In sub menu, press and hold "Exit" Softkey until Exit Softkey changes to Home Softkey, then release the Softkey.

- The phone automatically exits MENU mode with an incoming call, when the phone is off hook or the MENU mode if left idle for more than 60 seconds.
- When the phone is in idle, pressing and holding the UP-navigation key for 3 seconds to see the phone's IP address, IP setting, MAC address and software address.

The MENU options are listed in the following table.

Table 11: Configuration Menu

Call History	Displays Local call logs: All Calls/Answered Calls/Dialed Calls/Missed Calls/Transferred Calls
Status	Displays account status, network status, software version number and Hardware <ul style="list-style-type: none"> • Account status. • Network status. Press to enter the sub menu for MAC address, IP setting information (DHCP/Static IP/PPPoE), Ipv4 address, Ipv6 address, Subnet Mask, Gateway and DNS server. <ul style="list-style-type: none"> • System Information Press to enter the sub menu for Hardware version, P/N number. Boot, Core, Base, Prog version and IP Geographic Information. <ul style="list-style-type: none"> • Provider Status Shows the provider's status based on the Special Feature set on each account. It provides also functions related to that specific provider.
Contacts	Contacts sub menu includes the following options: <ul style="list-style-type: none"> • Local Phonebook



	<ul style="list-style-type: none"> • Local Group • LDAP Directory <p>Contacts sub menu is for Local Phonebook, Local Group, LDAP Directory and Broadsoft Phonebooks. User could configure phonebooks/groups/LDAP options here, download phonebook XML to the phone and search phonebook/LDAP directory.</p>
Messages	<p>Message sub menu include the following options:</p> <ul style="list-style-type: none"> • Instant Message <p>Displays received instant messages;</p> <ul style="list-style-type: none"> • Voice Mails <p>Displays voicemail message information in the format below: new messages/all messages (urgent messages/all urgent messages).</p>
Preference	<p>Preference sub menu includes the following options:</p> <ul style="list-style-type: none"> • Do Not Disturb <p>Enables/disables Do Not Disturb on the phone.</p> <ul style="list-style-type: none"> • Keypad Lock <p>Turns on/off keypad lock feature and configures keypad lock password. The default keypad lock password is null. If user enabled Star Key lock without configuring password, user can unlock keypad by holding * key 4 seconds and pressing "OK" button.</p> <ul style="list-style-type: none"> • Sounds <ul style="list-style-type: none"> ○ Ring Tone <p>Configures different ring tones for incoming call.</p> <ul style="list-style-type: none"> ○ Ring Volume <p>Adjusts ring volume by pressing left/right arrow key.</p> • Appearance <ul style="list-style-type: none"> ○ Active LCD Brightness <p>Adjusts active LCD brightness by pressing left/right arrow key</p> <ul style="list-style-type: none"> ○ Idle LCD Brightness <p>Adjusts idle LCD brightness by pressing left/right arrow key</p> <ul style="list-style-type: none"> ○ Active LCD Timeout <p>Adjusts the minute of active backlight timeout.</p> <ul style="list-style-type: none"> ○ Screensaver <p>Enables/Disables Screensaver</p> <ul style="list-style-type: none"> ○ Screensaver Timeout <p>Configures the minutes of idle before the screensaver activates.</p>



Valid range is 3 to 60.

- **MPK LCD Settings (Available on GRP2614 only)**

- **MPK LCD Display Order**

Choose MPK LCD Display Order whether to be Sequential or Alternating

- **Display Contact on MPK LCD**

Enable / Disable Display Contact on MPK Order

- **Language and Input**

- **Display Language**

Selects the language to be displayed on the phone's LCD. Users could select Automatic for local language based on IP location if available. By default, it is Auto.

- **Default Input Selection**

Selects the Input mode from **Multi-Tap** and **Shiftable**. By default, it is **Multi-Tap**.

- **Multi-Tap:** User may tap the same key multiple times to switch to the desired character.
 - **Shiftable:** After pressing the number button, user will see the IDs of the characters that matching to the button. User can select the desired character by entering the corresponding ID on keypad.

- **Date Time**

- **Allow DHCP Option 42 to override NTP server**

- **Allow DHCP Option 2 to override Time Zone setting**

- **Time Settings**

It is used to configure date and time on the phone.

- **Search Mode**

Specifies the phonebook search mode to **QuickMatch** or **ExactMatch**. By default, it is **QuickMatch**.

Phone

Phone sub menu includes the following options:

- **SIP**

Configures SIP Proxy, Outbound Proxy, SIP User ID, SIP Auth ID, SIP Password, SIP Transport and Audio information to register SIP account on the phone.

- **Call Features**

Configures call forward features for Forward All, Forward Busy, Forward No Answer and No Answer Timeout.



System sub menu includes the following options:

- **Network**

- **Internet Protocol**

Selects Prefer IPv4 / Prefer IPv6 / IPv4 only or IPv6 only. The default setting is “IPv4 only”.

- **IP Setting**

Selects IP mode (DHCP/Static IP/PPPoE); Configures PPPoE account ID and password; Configures static IP address, Netmask, Gateway, DNS Server 1 and DNS Server 2.

- **802.1X**

Enables/Disables 802.1X mode; Configures 802.1x identity and MD5 password.

- **Layer 2 QoS**

Configures 802.1Q/VLAN Tag and priority value. Select “Reset VLAN Config” to reset VLAN configuration.

- **Wi-Fi Settings (GRP2612W & GRP2614 & GRP2615 only)**

- **Enable/disable**

Enables/disables Wi-Fi.

- **Scan**

Scan available Wi-Fi networks.

- **Bluetooth Settings (GRP2614/GRP2615 only)**

- **Bluetooth Status**

Displays the status of Bluetooth

- **Bluetooth MAC**

Displays the GRP phone’s Bluetooth MAC address.

(Bluetooth MAC address is GRP phone’s MAC address plus 1)

- **Power**

Turns on/off the Bluetooth feature.

- **Handsfree Mode**

Enables/Disables Handsfree mode

- **Bluetooth Name**

Specifies GRP phone name when discovered by other Bluetooth devices.

- **Start Scan**

Starts to scan other Bluetooth devices around the phone. If found, user could press “Pair” Softkey, and enter Pin code to pair to other devices.

- **Web Access**
 - **Web Access Mode**
 - **HTTP web port**
 - **HTTPs web port**

- **Upgrade**
 - **Firmware Server**

Configures firmware server for upgrading the phone.
 - **Config Server**

Configures config server for provisioning the phone.
 - **Upgrade Via**

Specifies upgrade/provisioning via TFTP/FTP/FTPS/HTTP/HTTPS.
 - **Start Provision**

Starts Provision immediately.

- **Language Download**
 - **Auto Language Download**
 - **Language Download**

- **Factory Functions**
 - **Diagnostic Mode**

All LEDs will light up. All keys' name will display in red on LCD screen before diagnosing. Press any key on the keypad to diagnose the key's function. When done, the key's name will display in blue on LCD. Lift and put back the handset to exit diagnostic mode.
 - **Audio Loopback**

Speak to the phone using speaker/handset/headset. If you can hear your voice, your audio is working fine. Press "Exit" Softkey to exit audio loopback mode.
 - **LCD on/off**

Selects this option to turn off LCD. Press any button to turn on LCD.
 - **LCD Diagnostic**

Enters this option and press Left/Right Navigation key to do LCD Diagnostic. Press "Exit" Softkey to quit.



- **Certificate Verification**

This is used to validate certificate chain for the server's certificate.

- **UCM Detect**

Detect/connect UCM server to process auto-provision. Manually input the IP and port of the UCM server phone wants to bind with; Or select from the available UCM server in network.

- **Authentication**

- **Admin Password**

This is used to change the admin password for Web UI access.

- **End User Password**

This is used to change end user password for Web UI access.

- **Settings**

Turns on/off Test Password Strength feature. This will allow only passwords with some constraints to ensure better security.

- **Operations**

- **Factory Reset**

It is used to restore the phone to factory default settings.

- **Ping and Traceroute**

It is used to show the route taken by packets across to an URL.

- **Alternative firmware**

It is used to show current and alternative firmware versions available on the phone. Users can “rollback” to alternative firmware from this menu.

Reboot

Reboots the phone.



The following picture shows the keypad MENU configuration flow:

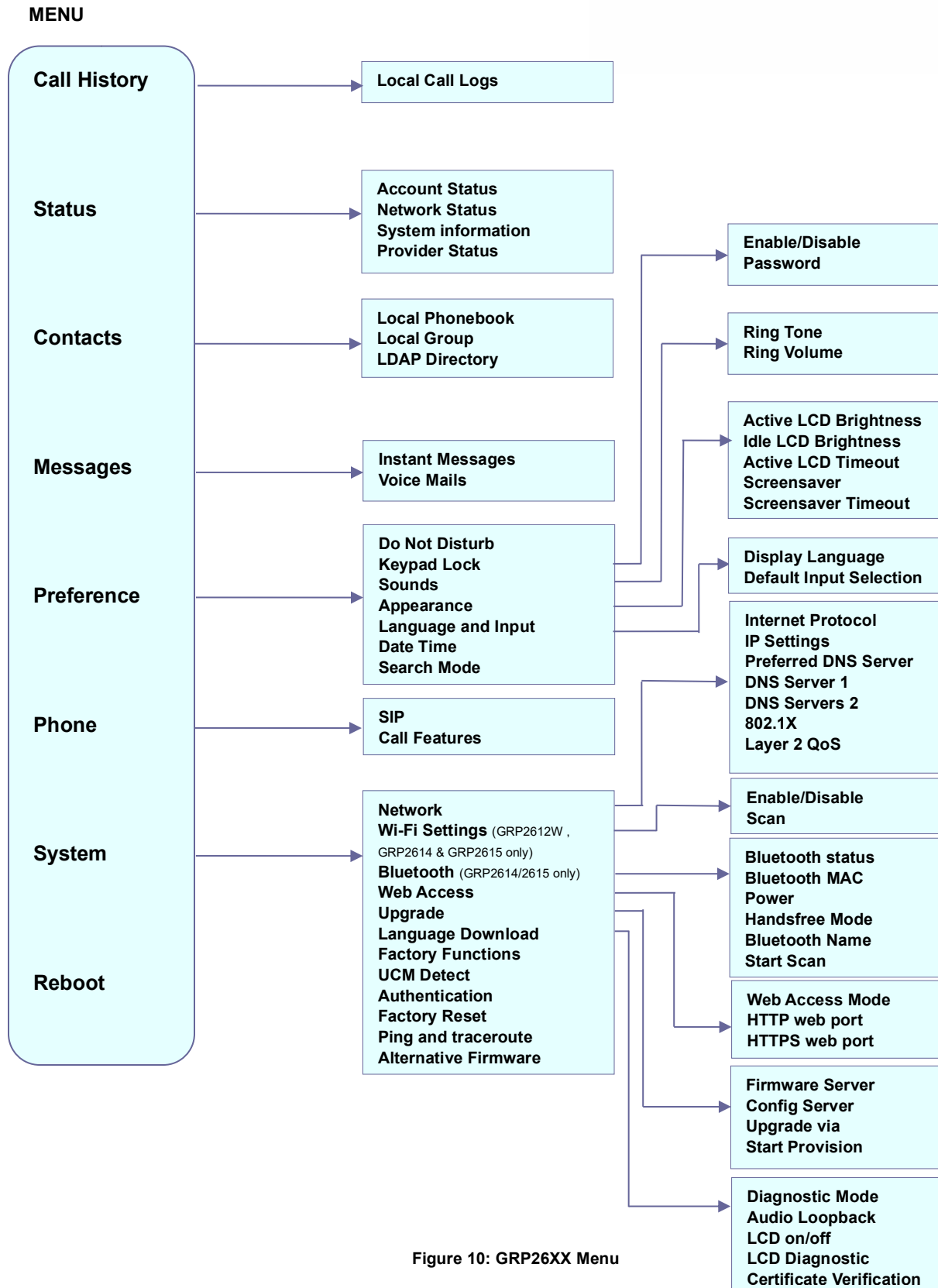

MPK LCD (Available on GRP2614 only)

The GRP2614 supports MPK LCD with 8 physical MPKs and 3 pages, allowing to configure up to 24 fully programmable phone extensions to the phone.

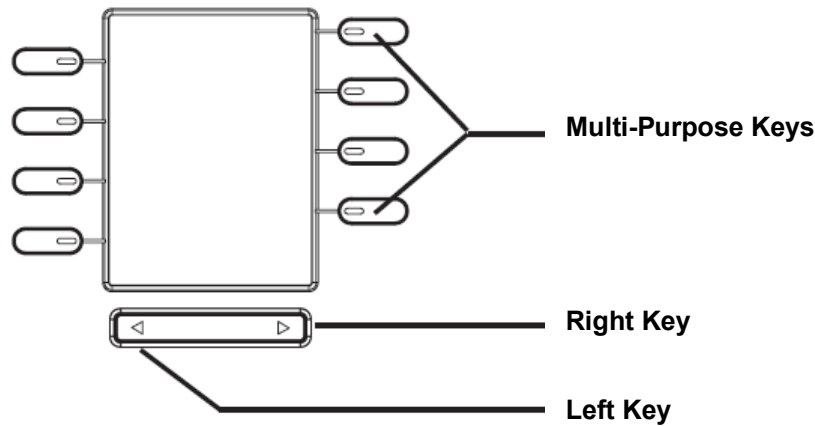

Figure 11: GRP2614 MPK LCD

The MPKs can be configured via:

- Web GUI **Settings** → **Programmable Keys** → **Physical Multi-Purpose Keys**.
- Or from phone directly; by pressing and holding for 5 seconds the MPK button to configure. The phone LCD and MPK LCD will display related settings as shown below:

Multi Purpose Key 1	
Mode	◀ None ▶
Account	6003
Description	
Value	
🏠 Save	

Figure 12: Phone LCD Configuration (MPK1)

Mode	NONE
Account	1
Description	
Value	
	MPK Detail

Figure 13: MPK LCD Configuration (MPK1)

After finishing the configuration, press Left or Right button at the bottom to browse all the MPK's status in the different pages.



For more information please refer to the admin guide:

http://www.grandstream.com/sites/default/files/Resources/GRP26XX_administration_guide.pdf

TELEPHONY FEATURES

Make Phone Calls

Handset, Speaker and Headset Mode

The GRP26XX allows users to switch among handset, speaker or headset when making calls. Press the Hook Switch to switch to handset; press the Headset button  to switch to headset; or press the Speaker button  to switch to speaker.

Multiple SIP Accounts and Lines

GRP2612/GRP2612P/GRP2612W support up to 2 SIP accounts with 4 line keys; GRP2613 supports up to 3 SIP accounts with 6 line keys and GRP2614 supports up to 4 SIP accounts with 4 line keys. GRP2615 supports up to 16 SIP accounts with 10 line keys. Each account is capable of independent SIP server, user and NAT settings. Each of the line buttons is "virtually" mapped to an individual SIP account. In off hook state, select an idle line and the dial tone will be heard.

To make a call, select the line you wish to use. The corresponding LINE LED will light up in green. The user can switch lines before dialing any number by pressing the LINE buttons.

For example: If 2 independent accounts are registered on GRP26XX, when LINE 1 is pressed, the LINE 1 LED will light up in green. If LINE 2 is pressed, the LINE 2 LED will light up in green and the subsequent call will be made through SIP account 2.

Incoming calls to a specific account will attempt to use its corresponding LINE if it is not in use. When the "virtually" mapped line is in use, the phone will flash the other available LINE in red. A line is ACTIVE when it is in use and the corresponding LED is red.

Completing Calls

There are several ways to complete a call.

- **On hook dialing.** Enter the number when the phone is on hook and then send out.
 1. When the phone is in idle, enter the number to be dialed out;
 2. Take handset off hook, or Press Speaker button, or Press Headset button with headset plugged in, or Select an available LINE key.
 3. The call will be dialed out.



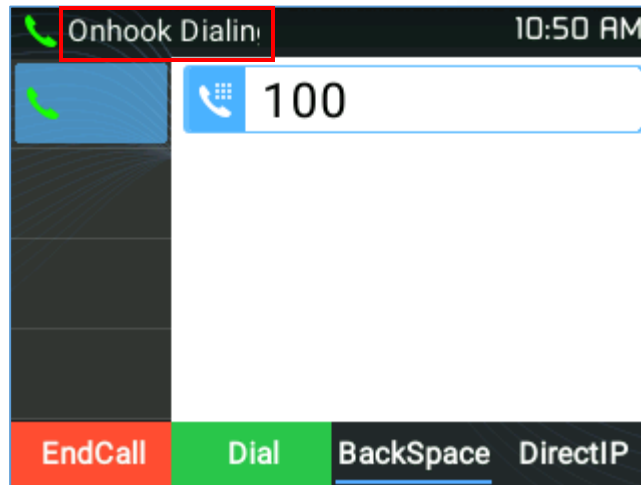

Figure 14: On hook dialing

- **Off hook and dial.** Off hook the phone, enter the number and send out.
 1. Take handset off hook; or
 - Press Speaker button; or
 - Press Headset button with headset plugged in; or
 - Press an available LINE key to activate speaker;
 2. You shall hear dial tone after off hook;
 3. Enter the number;
 4. Press SEND, * or # keys to dial out.



Figure 15: Off hook dialing

- **Predictive dialing.** When dialing numbers, based on the entered digit or digits, the phone will predict and list the candidates of target number.

If the target number is already saved in phonebook, when entering the first several digits, the phone will display a list of matching numbers. If the target number appears on the list, user could select the number using Up/Down key and dial out. GRP26XX has predefined call feature code (the first digit is *). When user enters * as the first digit of the target number, the phone will list all the available feature codes.

- **Redial.** Redial the last dialed number.
 1. Take handset off hook; or
 - Press Speaker button; or
 - Press Headset button with headset plugged in; or
 - Press an available LINE key to activate speaker; or
 - When the phone is in idle state;
 2. Press SEND key, or the REDIAL softkey.

- **Via Call History.** Dial the number logged in phone's call history.
 1. Press MENU button to bring up the main menu then enter Call History; or
 2. Press “**History**” soft key when the phone is in idle state;
 3. Select the entry you would like to call using the navigation arrow keys;
 4. Press SEND button to dial out.

- **Via Phonebook.** Dial the number from the phonebook.
 1. Press MENU button to bring up the main menu then enter Contacts; or
Press Contacts button;
 2. Enter Local Phonebook/ Broadsoft Phonebook using the navigation arrow keys;
 3. Select the contact you would like to call
Note: Pressing the **MENU** button, users can edit the phone number and choose which account to dial that number by clicking “**Edit / Dial**” soft key.
 4. Press SEND button to dial the selected contact.

- **Speed Dial from Line Key.** Dial the number configured as Speed Dial on Line Key.
 1. Go to phone's Web GUI → **Settings** → **Programmable Keys**, configure the Line Key Mode as Speed Dial. Select the account to dial from, enter the extension number to be dialed out in Value. Click on



"Save VPK" at the bottom of the Web GUI page;

2. Off hook the phone, or directly press the Speed Dial key to dial out.
- **Call Return.** Dial the last answered call.
 1. Go to phone's Web GUI→**Settings**→**Programmable Keys**, configure the Line Mode as Call Return.
Select the account to dial from, no Value must be set for Call Return;
 2. Off hook the phone, or directly press the Call Return key to dial out.
 - **Via Paging/Intercom.**
 1. Take handset off hook; or
 - Press Speaker button; or
 - Press Headset button with headset plugged in; or
 Press an available LINE key to activate speaker;
 2. You shall hear dial tone after off hook;
 3. Press MENU button to switch from "Dialing" to "Paging" (top left of the LCD screen);
 4. Enter the number;
 5. Press SEND, * or # keys to dial out.

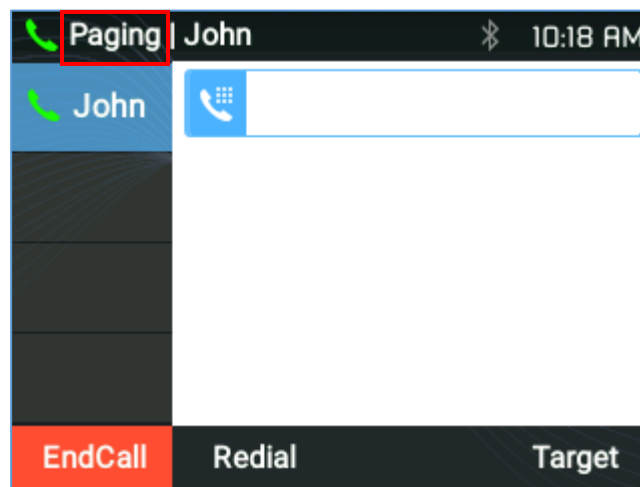

Figure 16: Call using Paging/Intercom

Notes:

- After entering the number, the phone waits for the No Key Entry Timeout (Default timeout is 4 seconds, configurable via Web GUI) before dialing out. Press SEND or # key to override the No Key Entry Timeout;

- If digits have been entered after taking the handset off hook, the SEND key will work as SEND instead of showing the history of Dialed extensions;
- By default, # can be used as SEND. Users could disable it by setting "User # as Dial Key" to "No" from Web GUI → **Account X** → **Call Settings**.
- For Paging/Intercom, if the SIP Server/PBX supports the feature and has Paging/Intercom feature code set up already, users do not necessarily need to switch to paging mode in the call screen. Simply dial the feature code with extension as a normal call.
- When a call is dialed out via paging, users can see the "call-info" header contains "answer-after=0" and "the "alert-info" header contains "info=alert-autoanswer;delay=0" in the outgoing INVITE.
- During an active call, users can see the call info on LCD:
 - The call lasting time
 - Contact information if the number is already saved in phonebook.
 - When dialing DTMF, user can press round Menu button to switch to call info page.
- It is possible to mute the call at dialing stage by composing a number, dialing the call and pressing the mute button before the call is answered.

Making Calls Using IP Addresses

Direct IP Call allows two phones to talk to each other in an ad-hoc fashion without a SIP proxy. VoIP calls can be made between two phones if:

- Both phones have public IP addresses; or
- Both phones are on the same LAN/VPN using private or public IP addresses; or
- Both phones can be connected through a router using public or private IP addresses (with necessary port forwarding or DMZ).

To make a direct IP call, please follow the steps below:

1. When phone is at idle state, press any number key or * key to bring up "Onhook Dialing" page;
2. Press round MENU key or "**DirectIP**" softkey
3. Input the target IP address (Please see example below);
4. Press "**Dial**" softkey to dial.

Note: When completing direct IP call, "Use Random Port" option should be set to "No".

For example:

If the target IP address is 192.168.1.60 and the port is 5062 (i.e., 192.168.1.60:5062), input the following: 192*168*1*60#5062. The * key represents the dot (.), the # key represents colon (:).

When only dialing the IP address (example: 192*168*1*60) the call will automatically go through the default port 5060.





Figure 17: Direct IP Call

Answering Phone Calls

Receiving Calls

- Single incoming call.**

Phone rings with the selected ring tone. The corresponding LINE key will flash in red. Answer call by taking handset off hook, or using Speaker/Headset, or pressing flashing LINE key;

Note:

Users can choose when receiving a call to either ring from their headset, ring from both headset and the speaker, or only ring from the speaker. This option can be enabled from the Web GUI under **Settings** → **Preferences** → **Audio Control** and configure “**Always Ring Speaker**”.

- Multiple incoming calls.**

When another call comes in while having an active call, the phone will produce a Call Waiting tone (stutter tone). The other LINE key will flash in red. Answer the incoming call by pressing the flashing LINE key. The current active call will be put on hold automatically.

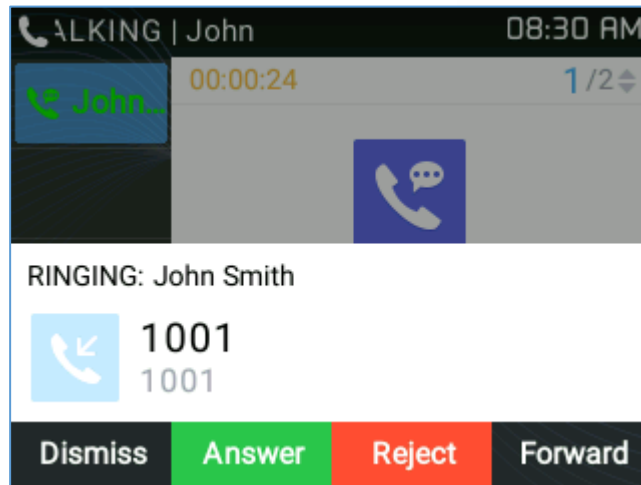

Figure 18: Multiple incoming calls

Notes:

- When there is an ongoing call, users can disable incoming call notification pop up. This way users will not get disrupted by unexpected popup call but still get notified by the flashing LED. This option can be enabled from the Web GUI under **Settings → Call Features**.
- For further information, please refer to the admin guide.

□ Ring Group Call

If the phone is member of a Ring Group, when the SIP server receives a call to the Ring Group extension, all the phones will start ringing, once a phone answers the call, a missed call notification will be showing on all the other phones. The GRP26XX Series support reason header, which allows the phones not to log a missed call if it is answered elsewhere. The following message will be included in the CANCEL SIP message received by the phone for notifying it that another user answers the call.

Reason: SIP; cause=200;text="Call completed elsewhere"

Do Not Disturb

Do Not Disturb can be enabled/disabled from phone's LCD by following the steps below:

1. Press the Menu button and select "**Preference**" using navigation keys;
2. Press Menu button again to get into Preference options;
3. When "**Do Not Disturb**" is highlighted, press Left/Right key to disable/enable DND;
4. Press "**Save**" softkey to save the change

Users could also enabled/disable DND quickly by pressing the Mute button 



Figure 19: Do Not Disturb

Notes:

- The mute button function can be set also to idle Mute, or be disabled under the web GUI option **Settings → Call features → Mute Key Function While Idle**.
- During an active call, press the MUTE button to mute/unmute the microphone. The LCD will show the Mute icon on the top of screen, when the call is muted.

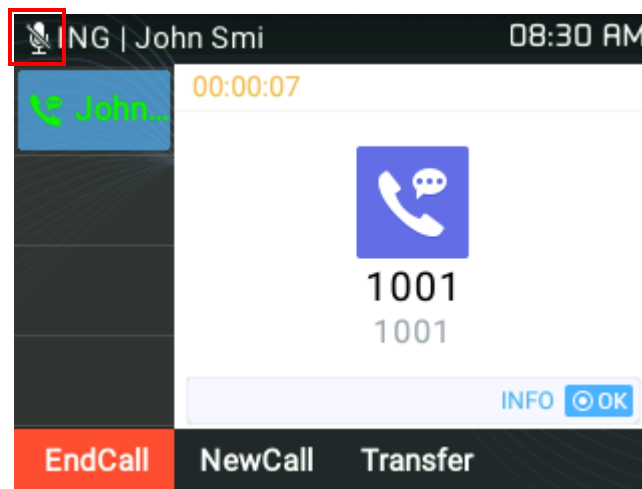
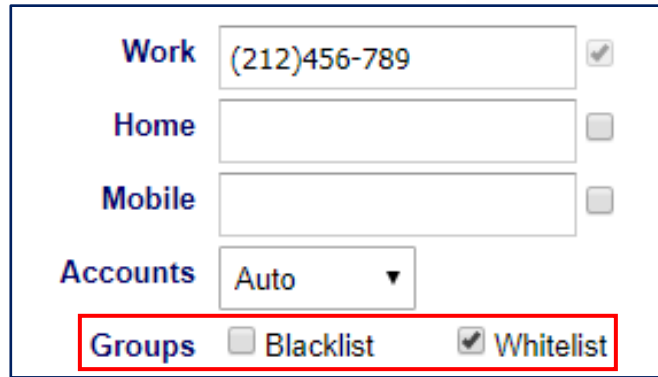

Figure 20: Call Muted

- **Black/White listing:** If the contact number belongs to Blacklist group, the call from that number will always be blocked. If the contact number belongs to Whitelist group, the call will be allowed even in DND mode.

This can be configured from the web GUI, under “**Directory → Contacts**” by adding a user into either the “Blacklist” or “whitelist” group as shown below:



Work (212)456-789
Home
Mobile
Accounts Auto ▾
Groups Blacklist Whitelist

Figure 21: Black/White List from Web GUI

Or from the phone's LCD under **Menu → Contacts → Local Phonebook** as shown below:

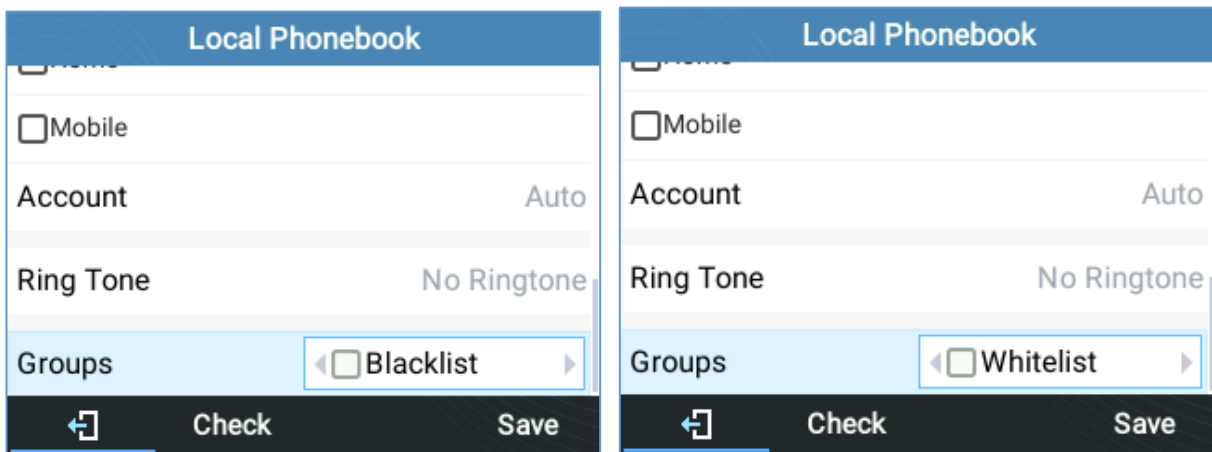

Figure 22: Black/White List from LCD

Call Hold

Place a call on hold by pressing the HOLD button . The active LINE key will blink in green.

Notes:

- If “**On Hold Reminder Tone**” is Enabled under web GUI “**Account X → Call Settings**” then a reminder tone will be played to notify the user that he has a call on hold.
- **Resume.** Resume call by pressing the blinking LINE key.
- **Multiple calls.** Automatically place active call on hold or switch between calls by pressing the LINE key. Call waiting tone (stutter tone) will be audible on new incoming call during the active call.
- **Call hold duration.** The phone will show the call hold duration as shown on figure below. The hold duration will be displayed only if there are two calls on hold or more and user can use the up/down arrows to check the hold duration of each call.

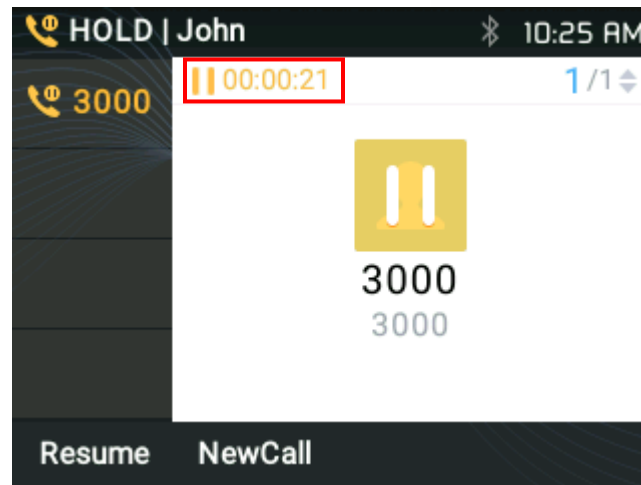

Figure 23: On hold duration

Call Transfer

GRP26XX series support Blind Transfer and Attended Transfer. This feature can be disabled from the web GUI menu under “**Settings → Call features → Disable Transfer**”.

❑ **Blind Transfer:**

1. During the first active call, press TRANSFER and dial the number to transfer to;
2. Press SEND key or # to complete transfer of active call.

❑ **Attended Transfer:**

• When set to “Static”

1. During the first active call, open a new LINE
The first call will be automatically put on hold
2. Enter the number for the second call in the new line and establish the call;
3. Press TRANSFER;
4. Press the other LINE key, which is on hold to transfer the call.

• When set to “Dynamic”

1. During the first active call, press TRANSFER.
2. A new line will be brought up and the first call will be automatically placed on hold;
3. Dial the number and press “**AttTrnf**” soft key to make a second call.
4. Press TRANSFER again. The call will be transferred.



Figure 24: Dynamic Attended Transfer

Note:

- For Auto-Attended Transfer, after dialing out the number for the second call, a **"Split"** soft key will show. If the second call is not established yet (ringing), pressing **"Split"** will hang up the second call. If the second call is established (answered), pressing **"Split"** will resume the second call and keep the first call on hold.

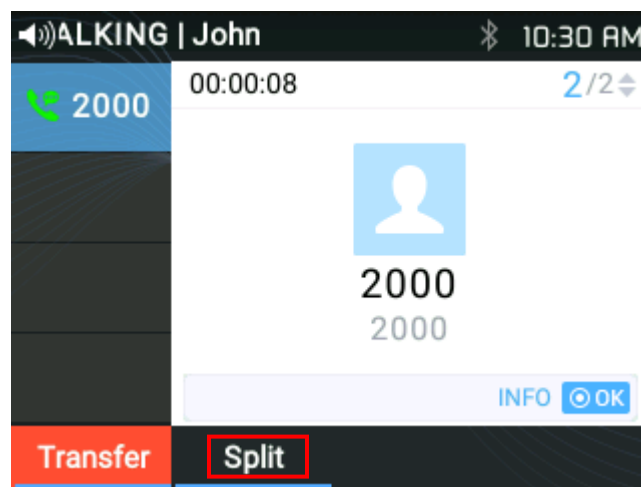

Figure 25: "Split" softkey

- Clicking the Red highlighted **"Transfer"** Key would force a Blind Transfer.

Target Selection

Using the target selection feature, users can use the following function:

- 1) Add a new softkey **"Target"** under transfer/conference LCD action screen.
- 2) When click on the softkey, it will take user to a target selection page in which user can choose other possible transfer/conference targets (e.g. Local/BS Phonebook, Local/BS Call Logs, LDAP...)
- 3) When accessing Local/BS Phonebook and Local/BS Call History page, the softkey will show limited options (e.g. Dial) if the phone is under busy state to make it easier for users to perform the dialing task.

- 4) When accessing Smart VPK List, the phone will display the list of the VPK targets which are allowed to be used as the transfer/conference target based on the current account.
- 5) When accessing Line, the phone will list the lines which are available for transfer/conference.

Example:

- Under Transfer screen:

A new softkey **“Target”** is added under transfer/conference action page.

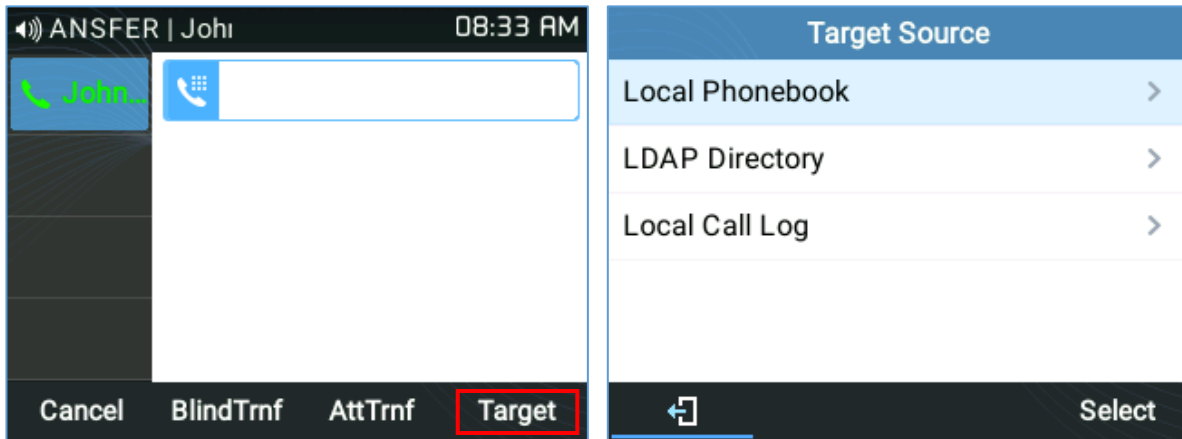

Figure 26: “Target” softkey under Transfer Action Page

Users can use navigation keys to select a target from the list and use Menu button or **“Select”** softkey to dial out. By selecting Local/Broadsoft Phonebook, Local/Broadsoft Call Log or LDAP Directory, LCD will display the according screen page with limited options (e.g. Dial) to make it easier for users to perform the dialing task.

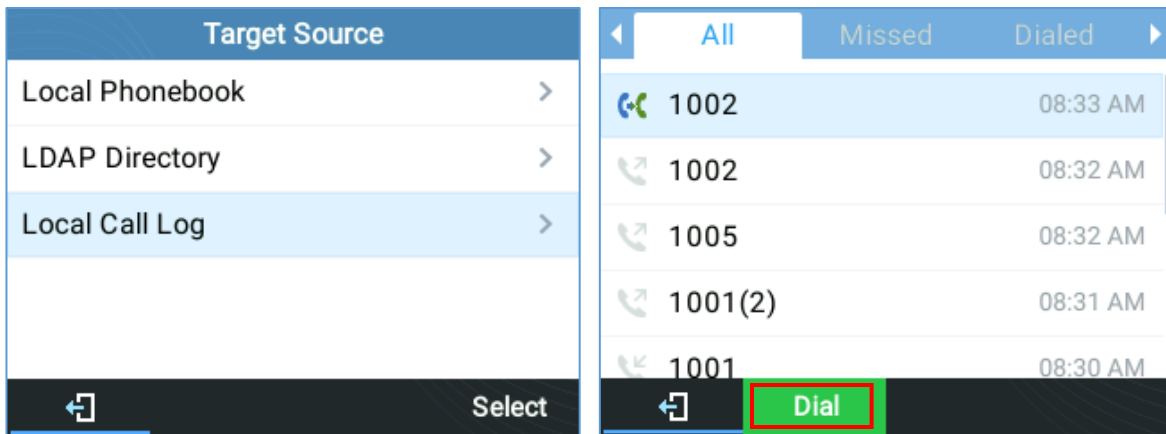

Figure 27: Target - Local Call Log Page

Transfer Information:

The phone displays Transfer information so users can see who transferred the call...

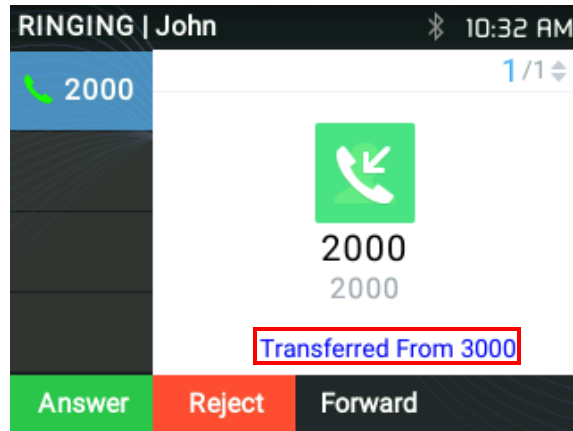

Figure 28: Transfer from Information While Ringing and During Incoming Call

Conference Call

3-way conferencing

GRP2612/GRP2612P/GRP2612W/GRP2613/GRP2614/GRP2615 can host a 3-way conference call with other parties (PCMU/PCMA). Users can disable/enable conference call feature from the phone's web GUI under menu **Settings** → **Call features** → **Disable Conference**.

❑ Initiate a conference call:

1. Establish calls with 1 or 2 parties respectively;
2. While 1 call is active, the other call will be put on hold with its LINE key blinking in green;
3. Press CONF key;
 - On the **GRP2613**: Click on “**ConfCall**” SoftKey
4. The conference will be established after pressing the desired LINE key on hold;
 - On the **GRP2613**: Press the “**UP arrow**” key. Then, click on “**ConfCall**” SoftKey.

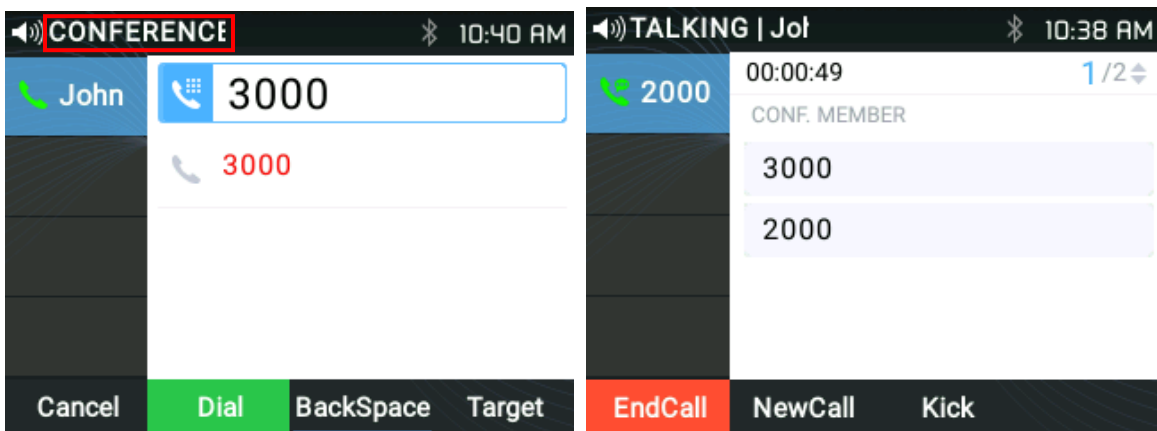

Figure 29: Established Conference

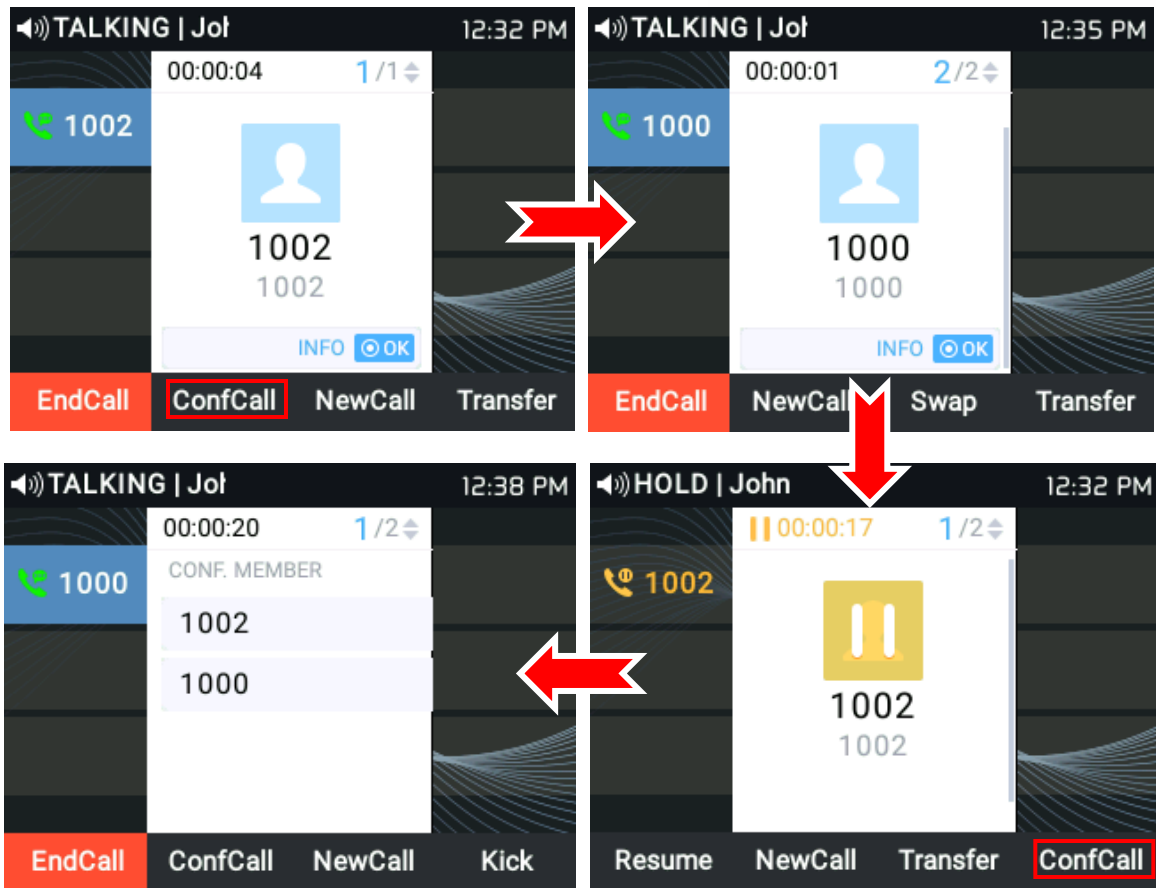

Figure 30 : Establish a Conference Call on the GRP2613

NOTE: Users may click the “Swap” Softkey to toggle between active calls.

❑ **Cancel Conference:**

1. If after pressing the CONF key, the user decides to cancel the conference, press “Cancel” softkey or the current active LINE key (LED in solid green);
2. This will resume the 2-way conversation with the current line.

❑ **Kick:**

Users can remove an extension from the ongoing conference by pressing “Kick” soft key, specifying which extension/number to be kicked out then clicking on “Submit” soft key.

❑ **Split and Re-conference:**

1. During the conference, press HOLD key. The conference call will be split, and the calls will be put on hold separately with the LINE keys blinking in green;
2. Press a LINE key to resume the 2-way conversation;



- If users would like to re-establish conference call. Press the “ReConf” softkey right after the conference call is split

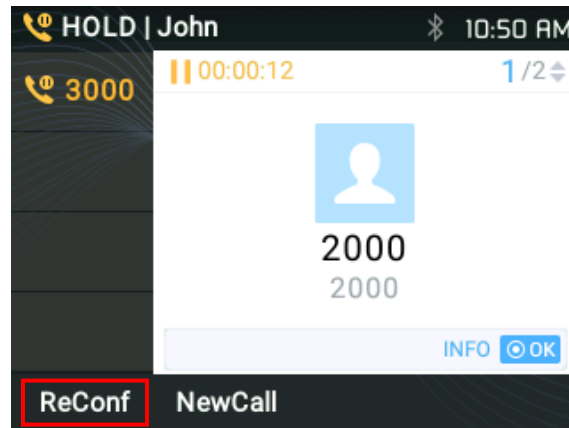

Figure 31 : Split conference

End Conference:

- Press HOLD key to split the conference call. The conference call will be ended with both calls on hold; Or
- Users could press the “EndCall” softkey or simply hang up to terminate the conference call.

Easy Conference Mode

GRP2612/GRP2612P/GRP2612W/GRP2613/GRP2614/GRP2615 supports **Easy Conference Mode**, which can be used combined with the traditional way to establish the conference.

Initiate a conference call.

- Establish 1 call;
- Press CONF key and a new line will be brought up using the same account;
- Dial the number and press SEND key to establish the second call;
- Press CONF key or press the “ConfCall” softkey to establish the conference.

Split and Re-conference.

- During the conference, press HOLD key. The conference call will be split and both calls will be put on hold separately with 2 LINE keys blinking in green;
- Press a LINE key to resume the 2-way conversation;
- If users would like to re-establish conference call, before 1 separate LINE is selected, press the “ReConf” softkey right after the conference call is split.

❑ **Cancel Conference.**

1. If user decides to cancel the conference after establishing the second call, press “**EndCall**” softkey instead of the “**ConfCall**” softkey/CONF key;
2. This will end the second call and the screen will show the first call on hold.

❑ **End Conference.**

1. Press HOLD key to split the conference call. The conference call will be ended with both calls on hold; Or
2. Users could press the “**EndCall**” softkey or simply hang up to terminate the conference call.

Notes:

- The party that starts the conference call must remain in the conference for its entire duration, you can put the party on mute, but it must remain in the conversation. In addition, this is not applicable when the feature "Transfer on Conference Hang-up" is turned on. Under **Web GUI → Accounts → AccountX → Call settings**
- The option "Disable Conference" must be set to "No" **Web UI → Settings → Call Features** to establish a conference call.
- Users can limit the ability for the phone to cross conferencing different accounts. This option can be found under device **web UI → Settings → Call Features**.

For more information, please refer to admin guide.

http://www.grandstream.com/sites/default/files/Resources/GRP26XX_administration_guide.pdf

UCM Conference

Participate in UCM Conference Room

Users could dial the UCM conference room extension to join the conference. If password is required, enter the password to join the conference either as a normal user, or as an administrator.

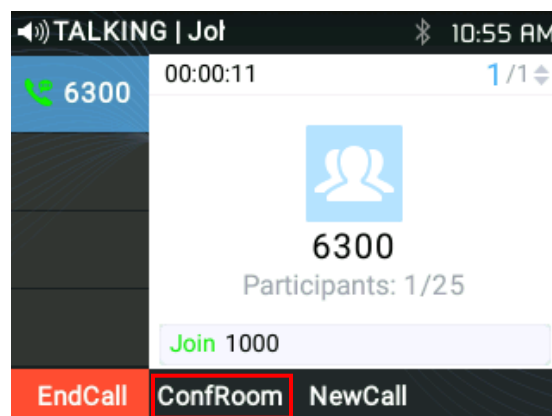

Figure 32: Join UCM Conference

- Follow the Interactive Voice Response (IVR) instructions.

Conference Call Menu (CCM)

During a UCM conference, only conference Administrators can press on the **ConfRoom** softkey to view/invite members, bridge conference, remove bridge, mute, unmute and lock the conference.

Conference Room Participants		
1	1000	1000
2	4000	4000
3	3000	3000
5	2000	2000

←
Invite
Bridge
...

Figure 33: List of Conference Room Users

Conference Call Operations

- **Invite User:**

Press the **Invite** softkey, specify the target extension number then click **OK**. The phone will note the operation by displaying **[Join User_Extension]** on the conference home screen.

Conference Room Participants			Invite User	
1	1000	1000	Number	4000
3	3000	3000	Prompt	Yes
5	2000	2000		

←

Invite

Bridge
...

←
OK
BackSpace
1Bc

Figure 34: UCM Conference Menu - Invite User

- **Kick User:**

Select the user's extension then press **Kick**. The phone will note the operation by displaying **[Exit User_Extension]** on the conference home screen. Then the user won't be available among the Conference Room Participants List.



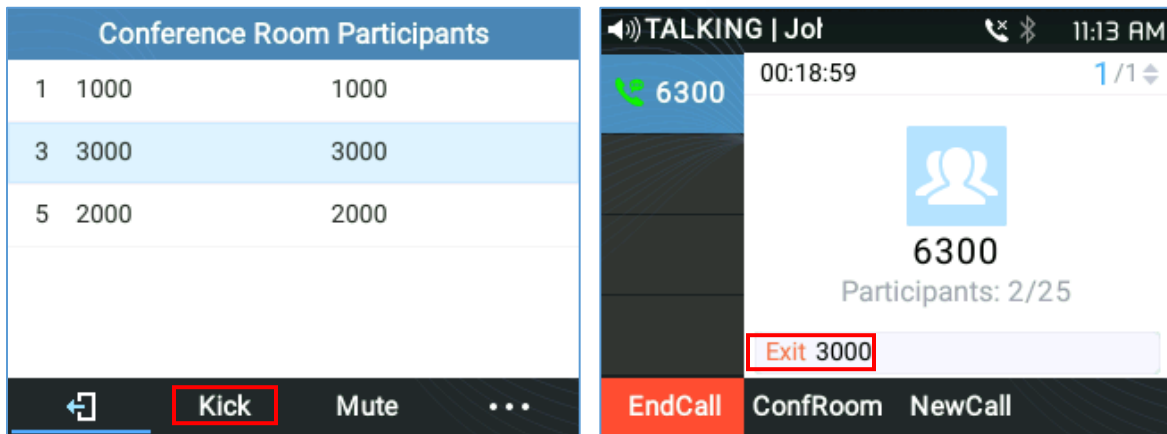

Figure 35 : UCM Conference room - Kick user

- **Mute/Unmute User:**

Select the user's extension then press **Mute**. The phone will note the operation by displaying [**Exit User_Extension**] on the conference home screen. But the user will still be available on the Conference Room Participants List.

An **Unmute** softkey will show to cancel the operation.

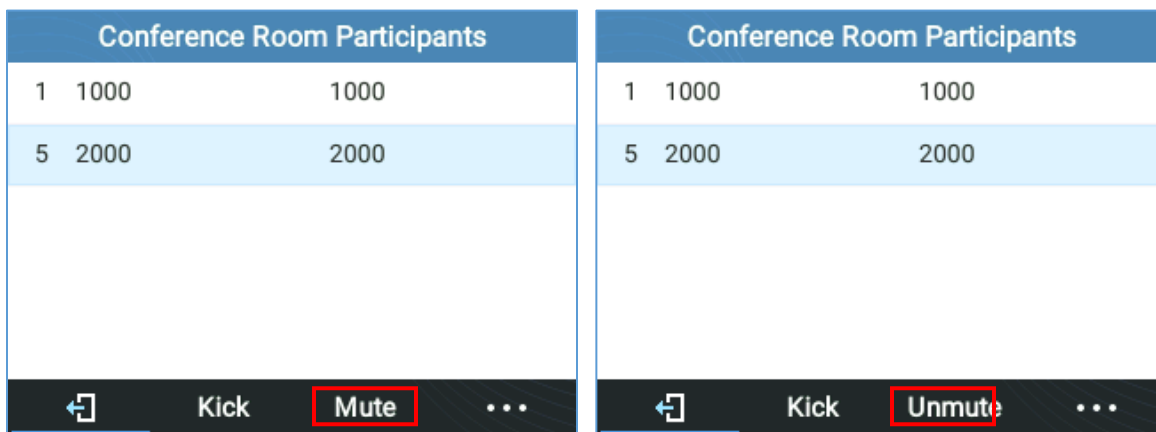

Figure 36 : UCM Conference room – Mute/ Unmute user

- **Conference Bridge:**

To bridge another conference, enter the conference number and password and Bridge request will be sent.

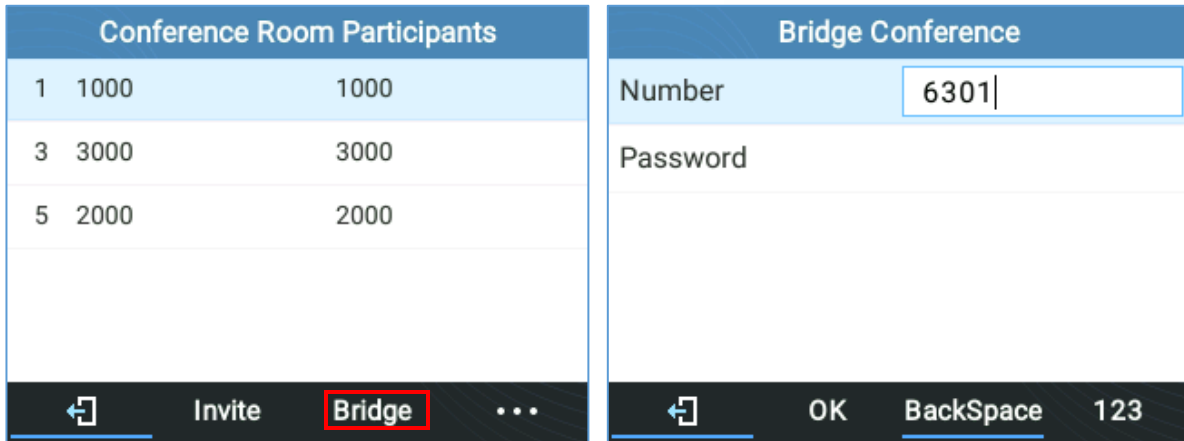

Figure 37: UCM Conference Menu - Bridge Conference

- **More:**

Press [...] for more conference room operations. Users can choose to **Lock/ Unlock** the conference, **Kick All** or **Mute/ Unmute All** participants.

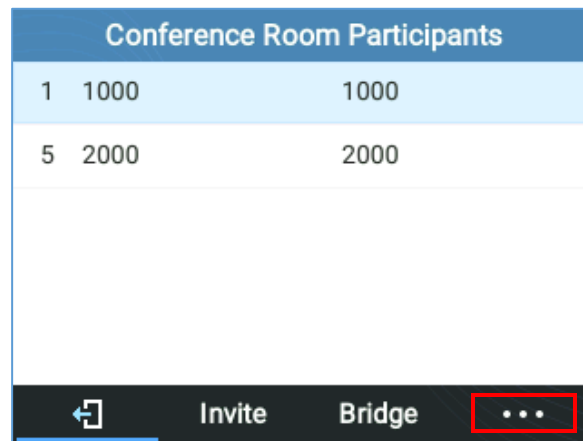

Figure 38 : UCM Conference Menu - More

Call Forwarding

Under **Menu (OK)** → **Phone** → **Call Features** → **Account X**.

- When disabled the LCD screen will look like the following figure:

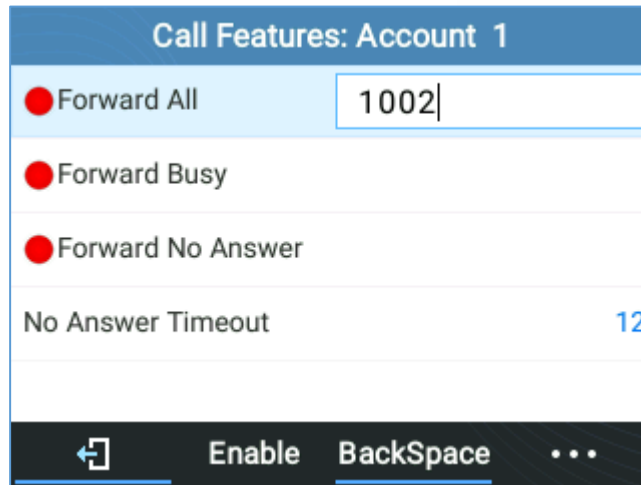

Figure 39: Disabled Call Forward

- When the feature is enabled, the phone's LCD screen will show the following figure.

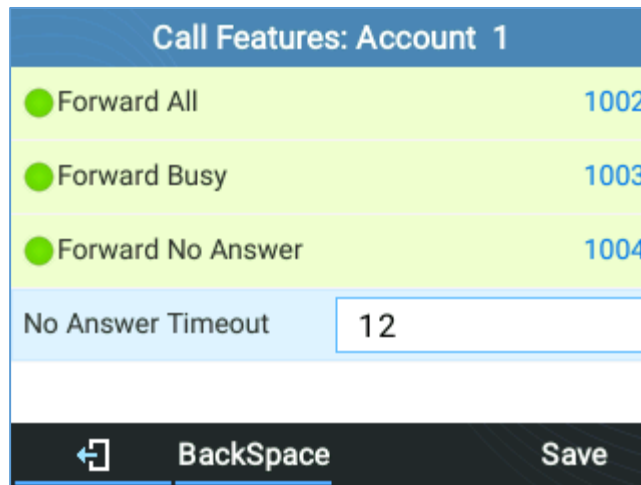

Figure 40: Enable Call Forward

- When forwarding a call, the recipient will display a "diverted from" message.



Figure 41: Diversion Information

- A Call Forward using BLF can also be performed by pressing the BLF key set on VPK/MPK as forward destination. You only need to Subscribe to a valid BLF and press Forward Key then the BLF key to perform the call forward.

Voice Mail

A blinking red MWI (Message Waiting Indicator) on the top right corner of the phone indicates a message is waiting. Check the voicemail box to retrieve the message by entering the voice mail number of the server; Or by pressing the Voicemail button; or from the Phone's **Menu > Messages > Voice Mails**

Notes:

- Voice Mail User ID and the voice mail number must be properly configured: under **Web GUI→Account X→General Settings**.
- An IVR will prompt the user through the process of message retrieval.

Virtual Voice Mail

With this feature, phone downloads the voicemail into a .wav file and stores it. Users don't have to dial feature codes and go to the BroadSoft server to listen to their voice mails. Also, they can pause/resume their voicemail messages at any time they want.

For more information, please refer to admin guide.

http://www.grandstream.com/sites/default/files/Resources/GRP26XX_administration_guide.pdf

Instant Messages

The GRP2612/GRP2612P/GRP2612W/GRP2613/GRP2614/GRP2615 allows users to send instant messages through the phone's LCD. Under **MENU (OK) → Messages → Instant Messages**

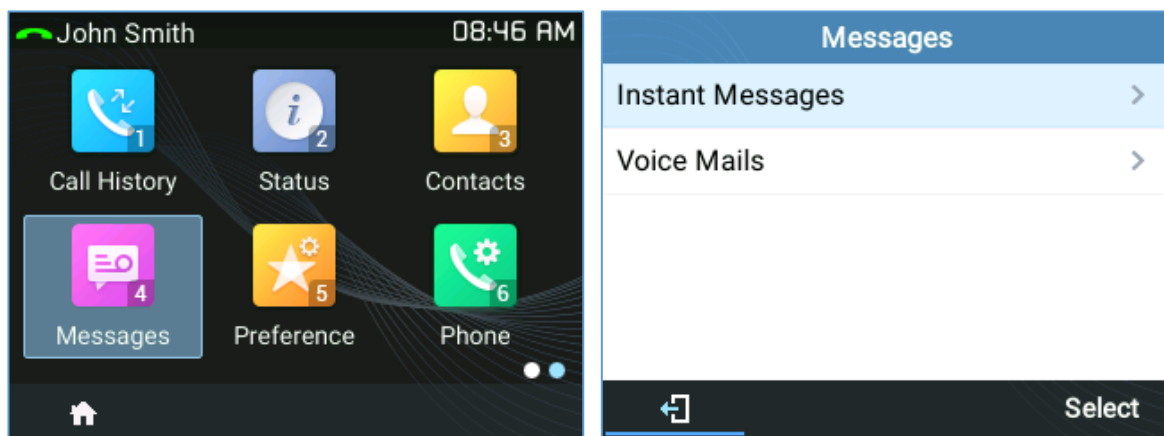

Figure 42: Instant Messages sub-menu

Users can press “New” soft key, then specify the Account, the recipient and the contents of the IM.

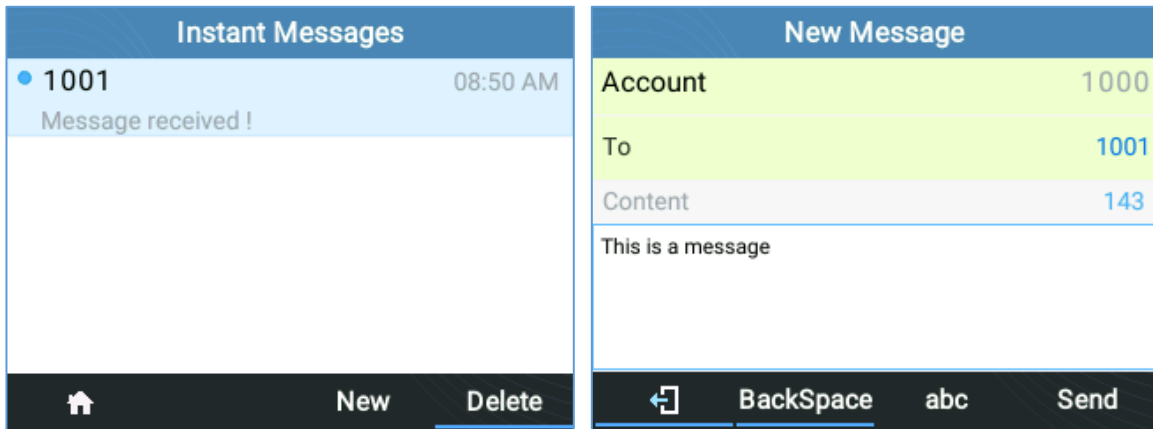

Figure 43: Sending an Instant Message

After pressing “Send” soft key, a “Sent successfully” message will pop up to indicate that the operation was successful.

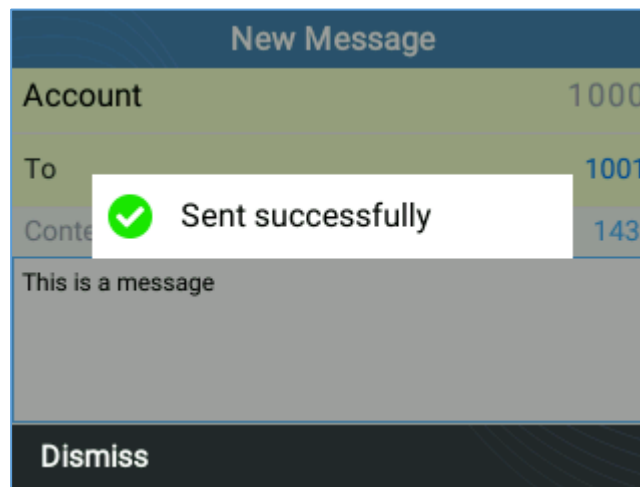

Figure 44: IM Sent Successfully

Call Features

The GRP2612/GRP2612P/GRP2612W/GRP2613/GRP2614/GRP2615 supports traditional and advanced telephony features including caller ID, caller ID with caller Name, call forward etc.

Table 12: Call Features

*30	Block Caller ID (for all subsequent calls) <ul style="list-style-type: none"> • Off hook the phone; • Dial *30.
*31	Send Caller ID (for all subsequent calls) <ul style="list-style-type: none"> • Off hook the phone; • Dial *31.

*50	Disable Call Waiting <ul style="list-style-type: none"> • Off hook the phone; • Dial *50.
*51	Enable Call Waiting <ul style="list-style-type: none"> • Off hook the phone; • Dial *51.
*67	Call with Caller ID Blocked (per call) <ul style="list-style-type: none"> • Off hook the phone; • Dial *67 and then enter the number to dial out.
*82	Call with Caller ID Enabled (per call) <ul style="list-style-type: none"> • Off hook the phone; • Dial *82 and then enter the number to dial out.
*70	Call with Call Waiting Disable (per call) <ul style="list-style-type: none"> • Off hook the phone; • Dial *70 and then enter the number to dial out.
*71	Call with Call Waiting Enabled (per call) <ul style="list-style-type: none"> • Off hook the phone; • Dial *71 and then enter the number to dial out.
*72	Unconditional Call Forward. To set up unconditional call forward: <ul style="list-style-type: none"> • Off hook the phone; • Dial *72 and then enter the number to forward the call; • Press OK softkey or SEND key.
*73	Cancel Unconditional Call Forward. To cancel the unconditional call forward: <ul style="list-style-type: none"> • Off hook the phone; • Dial *73; • Hang up the call.
*90	Busy Call Forward. To set up busy call forward: <ul style="list-style-type: none"> • Off hook the phone; • Dial *90 and then enter the number to forward the call; • Press OK softkey or SEND key.



*91	<p>Cancel Busy Call Forward. To cancel the busy call forward:</p> <ul style="list-style-type: none"> • Off hook the phone; • Dial *91; • Hang up the call.
*92	<p>Delayed Call Forward. To set up delayed call forward:</p> <ul style="list-style-type: none"> • Off hook the phone; • Dial *92 and then enter the number to forward the call; • Press OK softkey or SEND key.
*93	<p>Cancel Delayed Call Forward. To cancel the delayed call forward:</p> <ul style="list-style-type: none"> • Off hook the phone; • Dial *93; • Hang up the call.

User may proceed as below:

1. Dial Star key (*): A list of all available feature codes will be displayed on the screen
2. Browse the codes using the UP/Down arrow keys
3. Select an option by pressing the MENU key; Or, Click "Dial" Softkey.

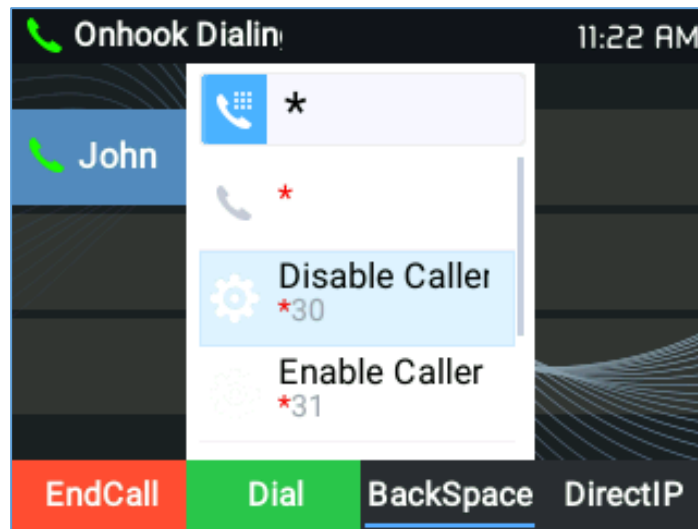

Figure 45 : Feature Codes List

ADVANCED FEATURES

Virtual Multi-Purpose Keys

Web UI Configuration

Users can find Virtual Multi-Purpose Keys (VPK) configuration under phone's web UI→**Settings**→**Programmable Keys**→**Virtual Multi-Purpose Keys** tab. It is recommended to select "Reset" on this page before configuring VPK here. By default, all fixed VPKs are listed.

Virtual Multi-Purpose Keys						
Order	Mode	Account	Description	Value	Locked	
1	Default	1				Edit VPK
2	Default	2				Edit VPK
3	Default	3				Edit VPK
4	Default	4				Edit VPK

[Add VPK](#)
[Reset](#)
[Save VPK](#)

Figure 46: VPK Page

Click on "**Edit VPK**" for the line (fixed VPK) you would like to configure. A new window will pop up for VPK configuration. Users can configure Mode, Account, Description and Value for the VPK. Up to 33 mode options can be selected for the VPK. Once done, press "**Save**" on this window and press "**Save VPK**" on the bottom of the Virtual Multi-Purpose Keys page again to apply the changes.

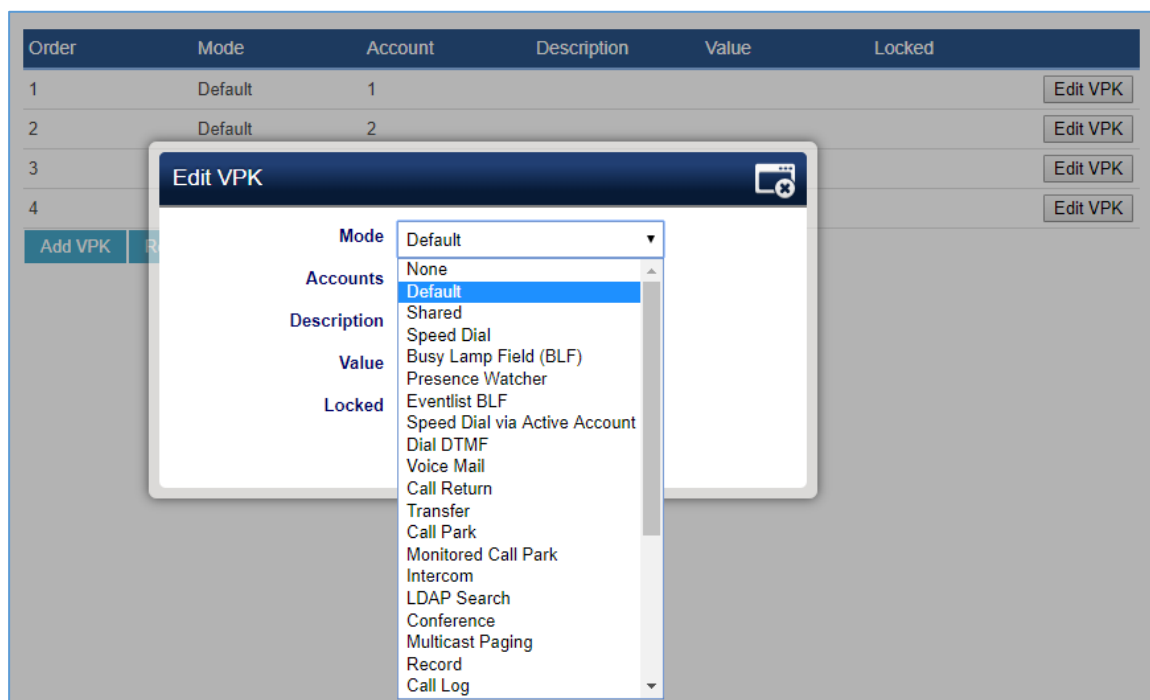

Figure 47: Edit VPK - Fixed VPK

If users would like to configure more VPKs than the ones displayed on the page, they can click on “**Add VPK**” to configure dynamic VPK. The dynamic VPK supports up to 30 mode options.

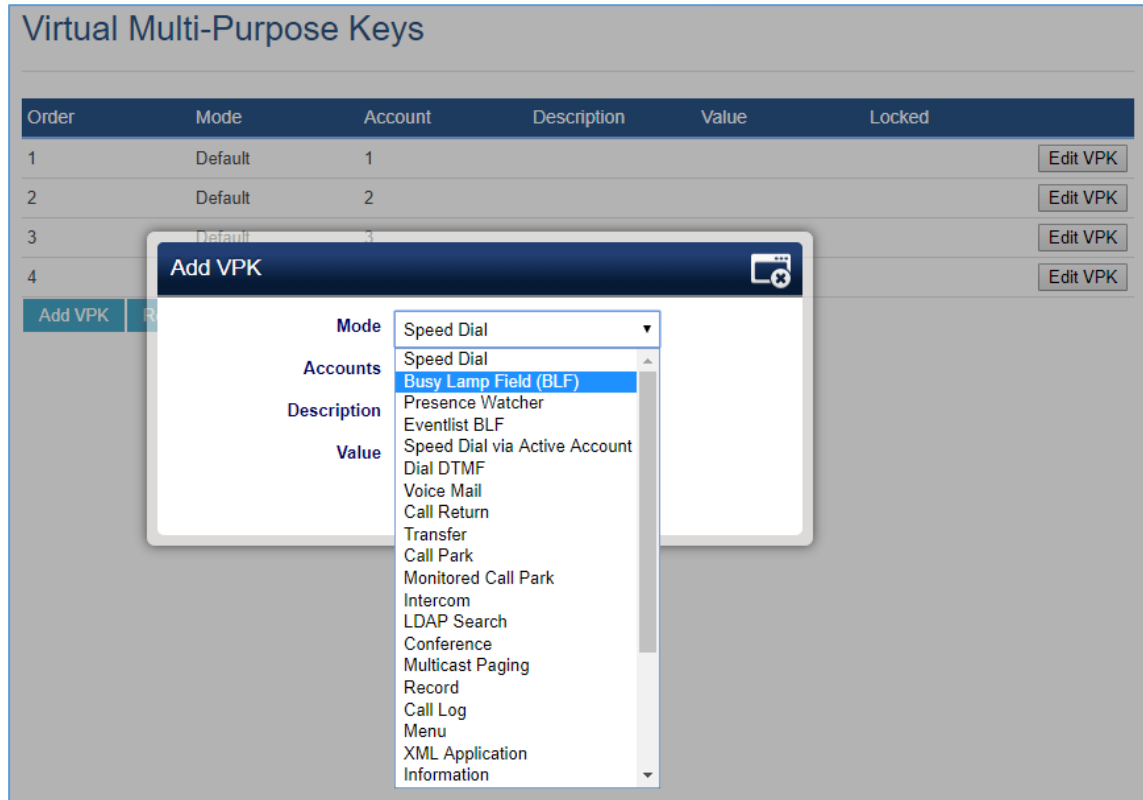

Figure 48: Edit VPK - Dynamic VPK

Please note:

1. Dynamic VPK does not support “Default” and “Shared” mode. These two mode options are only available for fixed VPKs.
2. Dynamic VPK does not support NONE mode. If users do not need this VPK, click on “**Edit VPK**” for it and select “**Delete**” to remove it..
3. All settings require user to click on “**Save**” on the prompted window and “**Save VPK**” button on the bottom of Virtual Multi-Purpose Keys page to take effect.
4. It’s recommended to have at least two lines in **Default** mode, to be able to bring up another line during a call and perform whether a call pickup, an attended transfer or a conference call.

P-Value for VPK Mode in String Format:

Table 13: VPK Modes in String Format

Mode Name	Mode String	Mode P-Value
None	None	-1
Default	Line	31
Shared	Shared line	32
Speed Dial	Speed dial	0
Busy Lamp Field	BLF	1



Presence Watcher	presencewatcher	2
Eventlist BLF	eventlistblf	3
Speed Dial via Active Account	speeddialaa	4
Dial DTMF	dialdtmf	5
Voice Mail	voicemail	6
Call Return	callreturn	7
Transfer	transfer	8
Call Park	callpark	9
Monitored Call Park	Monitoredcp	16
Intercom	Intercom	10
LDAP search	Ldap Search	11
Conference	Conference	12
Multicast Paging	Multicast paging	13
Record	Record	14
Call Log	Call log	15
Menu	Menu	17
XML Application	Xmlapp	18
Information	Information	19
Message	message	20
Forward	forward	21
DND	DND	22
Redial	redial	23
Instant Messages	instant messages	24
Multicast Listen Address	multicast listen address	25
Keypad Lock	keypad lock	26
GDS OpenDoor	gds opendoor	27
Presence EventList	presence eventList	28
Provision	provision	29

The string could be capital or lower-case letters, but there must be no “space” in between. For example, in the cfg.xml, “Transfer” or “transfer” is the same as “8”, it will configure Virtual Multi-Purpose Key 3 as transfer mode.

```

<?xml version="1.0" encoding="UTF-8" ?>
<gs_provision version="1">
  <config version="1">
    .....
    <P1363>transfer</P1363>
    <P1364>2</P1364>
    <P1465>TEST</P1465>
    <P1466>7777</P1466>

    </config>
  </gs_provision>
  
```

Figure 49: Line Key as Transfer Mode

LCD Indication and Configuration:

The configured fixed VPKs are displayed next to the corresponding line. If dynamic VPKs are configured, the users can see a page number shown on the bottom left corner of the LCD.

The following figures show page 1 and page 2 of the VPKs on LCD. Pressing “RIGHT” arrow key will switch to the next page; pressing “LEFT” arrow key will switch back to the previous page.

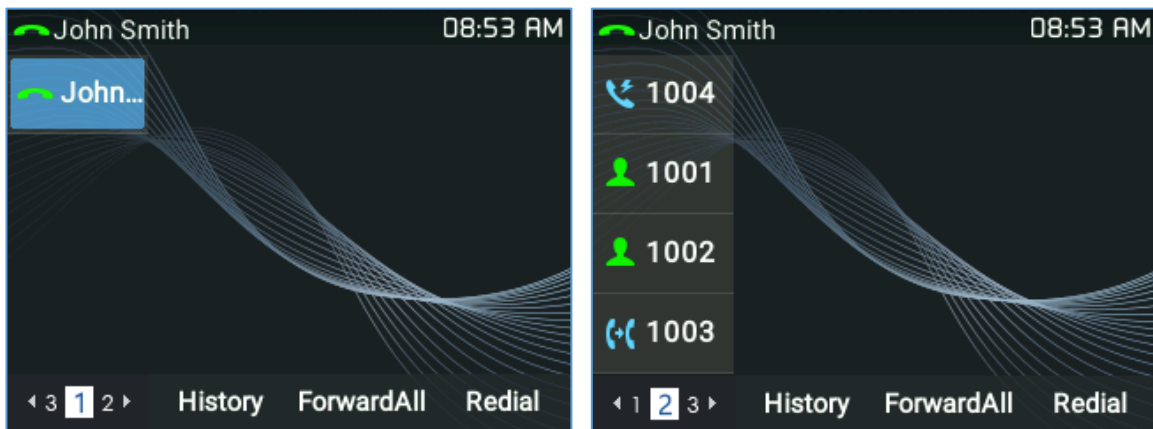

Figure 50: VPK - LCD Indication

The users could also edit and add VPK from LCD.

1. To edit (fixed) VPK, press and hold the line key for about 4 seconds, a configuration window will pop up for the user to configure.
2. To add (dynamic) VPK, press and hold the RIGHT arrow key for about 4 seconds, a configuration window will pop up for the user to configure.

Up to 30 modes can be supported on fixed VPK and up to 27 modes can be supported on dynamic VPK. Each mode is indicated by a different icon on the LCD and the icon will be different when in different status. Please find the icon indications below for different mode of VPK:







Table 14: VPK Modes Icon Indications

VPK Mode	Description	Default	Reverse
LINE	Unregistered		
	Registered		
	Call Forward		
	Dial_1_open_voicemail		
	Dial_2_open_voicemail		
	Account_1_open_voicemail		
	Account_2_open_voicemail		
SCA	Connect		
	Hold		
	Idle		
	Ringing		
	Seized		
	Error		
	Invalid		
	Unknown		
BLF	Away		
	Available		
	Unavailable		
	Busy		
	Chat		
	Connect		
	DND		
	Ringing		



	Unknown		
	User def		
Speed Dial	Speed Dial		
Dial DTMF	Dial DTMF		
Call Return	Call Return		
Transfer	Call transfer		
Call Park	Call Park		
	Call Park Busy		
	Call Park Online		
	Call Park Offline		
Intercom	Intercom		
	Multicast Intercom		
	Paging Call		
LDAP Search	LDAP Search		
Multicast Paging	Multicast Listen Address		
Record	Recording		
Menu	Menu		
Message	Message		
Conference	Conference		
Information	Information		
Keypad Lock	Keypad Lock		
DND	Do Not Disturb		
XML	XML		
Phonebook	Phonebook		
Call History	Call History		



Instant Message	Instant Message		
Redial	Redial		
GDS OpenDoor	GrandStream OpenDoor System		
Forward	Forward		
Provision	Provision		
Voice Mail	Voice Mail		
	Voice Mail New		

When the user is in call screen (during a call), he can press Right/Left arrow key to toggle between screens and choose which VPK to use.

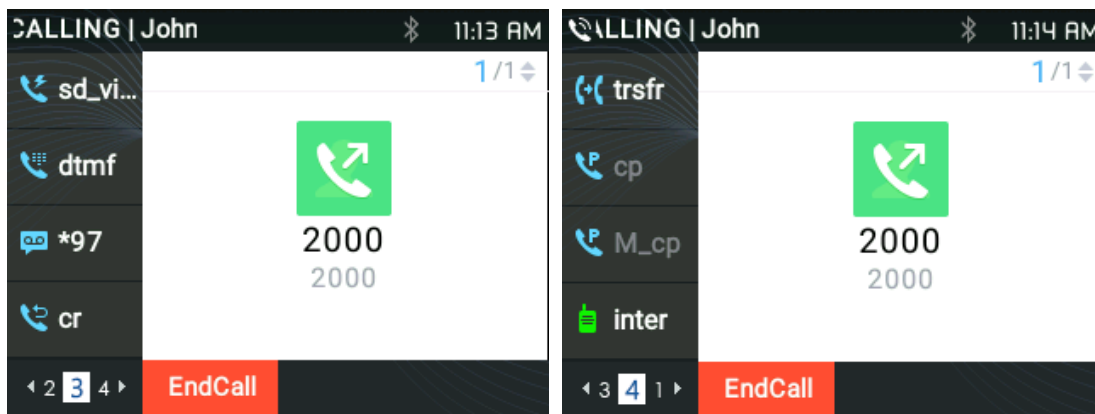

Figure 51: toggle between screens in call screen

Notes :

- If a call is parked via VPK call park, the display on the VPK will change between CID of the active call and the parking number.
- When changing the VPK information that requires subscription, the phone will perform unsubscribe first, then perform a new subscription. This way server will know that previous subscription has been void.

Predictive Dialing

Search in Call History

Functionality

If the user dials digits matching some call history entries, a list of entries should be displayed with corresponding names.



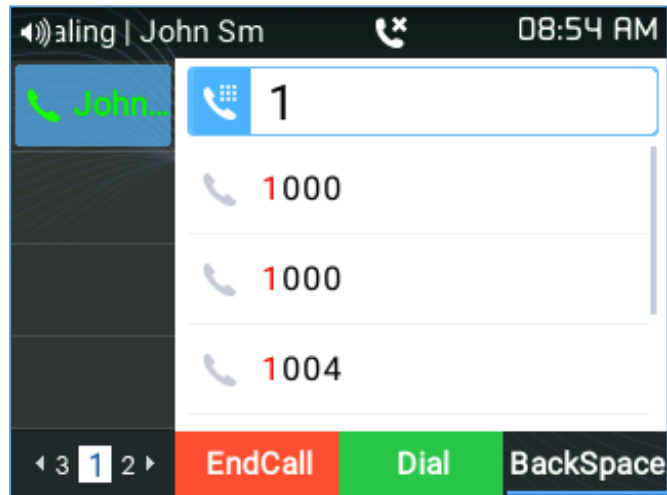

Figure 52: Predictive Dialing

Note:

Users can Disable the Predictive Dialing Feature from Web GUI under **Settings** → **Call Features**.

Search in Broadsoft Directories

Web configuration

Users can configure Broadsoft XSI directories correctly from Web GUI under **Settings** → **Broadsoft** → **Broadsoft Directories**.

Settings

- General Settings
- Broadsoft
- Broadsoft XSI**
- Broadsoft IM&P
- External Service
- Call Features
- Multicast Paging
- Outbound Notification
- Preferences
- Programmable Keys
- Web Service
- XML Applications
- Voice Monitoring

Broadsoft XSI

XSI

Server	<input type="text"/>
Port	<input type="text"/>
XSI Actions Path	<input type="text"/>
Broadsoft Contact Download Interval	<input type="text" value="4320"/>
XSI Authentication Type	<input type="text" value="Login Credentials"/>

Login Credentials

Login Username	<input type="text"/>
Login Password	<input type="text"/>

SIP Credentials

SIP UserName	<input type="text"/>
SIP User ID	<input type="text"/>
SIP Password	<input type="text"/>

Sort Phonebook by Last Name First Name

Network Directories

Type	Status	Name
Group Directory	<input type="text" value="Disabled"/>	<input type="text"/>
Enterprise Directory	<input type="text" value="Disabled"/>	<input type="text"/>
Group Common	<input type="text" value="Disabled"/>	<input type="text"/>
Enterprise Common	<input type="text" value="Disabled"/>	<input type="text"/>
Personal Directory	<input type="text" value="Disabled"/>	<input type="text"/>
Missed Call Log	<input type="text" value="Disabled"/>	<input type="text"/>
Placed Call Log	<input type="text" value="Disabled"/>	<input type="text"/>
Received Call Log	<input type="text" value="Disabled"/>	<input type="text"/>

Figure 53: Broadsoft XSI web configuration



Functionality

Phone can predict possible contacts information from Broadsoft XSI directories when users dials a number. Users can select from the list of predicted numbers that will show if Broadsoft XSI directory information is loaded after pressing the related number



Figure 54: Predictive Dialing from BS XSI Directories

VPK Paging Support inside the LCD Call Screen

Users can use their preconfigured VPK mode while in call screen. Such as Speed Dial, BLF..., as shown in the figure below:

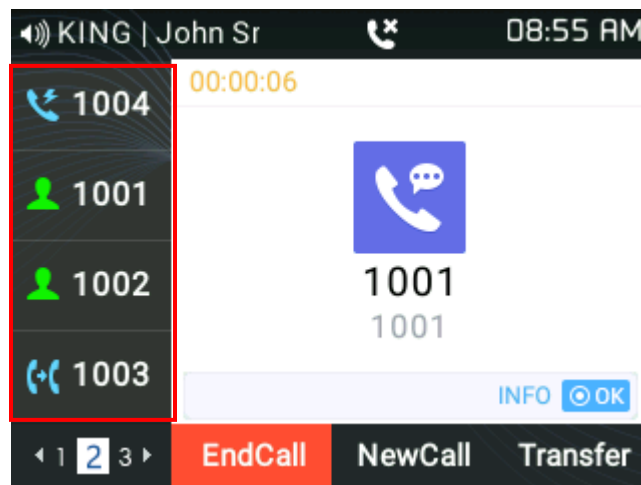

Figure 55: VPK Paging

Active VPK Page

If “**Active VPK page**” is enabled, when a monitored BLF number is called, the LCD screen will indicate the VPK Page that contains the VPK key as below



Figure 56: Active VPK Page

You can see the page number blinking in red, which means that this page is an active VPK page. Users can Enable/Disable this option under device **web UI → Settings → Call Features**

Line Switching in Call Screen

When having two lines (or more) active users will be able to switch between the calls by pressing up/down, arrow keys, this will allow users to manipulate calls through the phones arrow keys as shown below:

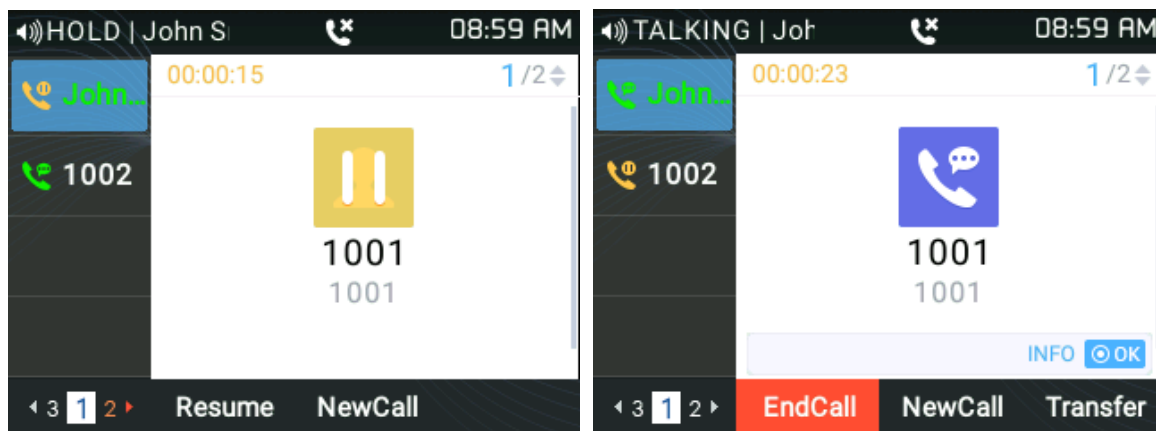

Figure 57: Line Switching

Shared Call Appearance (SCA)

The GRP2612/GRP2612P/GRP2612W/GRP2613/GRP2614/GRP2615 phone supports shared call appearance by Broadsoft standard. This feature allows members of the SCA group to shared SIP lines and provides status monitoring (idle, active, progressing, hold) of the shared line.

To enable shared call appearance, the user needs to register the shared line account on the phone. In addition to configuring the SCA parameters under **Settings → Programmable Keys** on the web UI and setting the line key mode as "Shared Line".

For more information please refer to the SCA guide:

http://www.grandstream.com/sites/default/files/Resources/SCA_guide.pdf



Configuring Eventlist BLF

Grandstream GRP2612/GRP2612P/GRP2612W/GRP2613/GRP2614/GRP2615 Carrier-Grade IP Phones support both Grandstream UCM Busy Lamp Filed and Event List BLF features and allows end users, such as attendant, to monitor the call status of users in the list. GRP26XX supports this feature by sending out the subscription request to the UCM and changing the indicator status of the Line keys, MPKs, or virtual MPKs that associated with the monitored users.

Additionally, the phone is also able to display the original caller's call ID and to pick up the calls to the monitored extensions by using a pre-defined feature code called BLF- Call-pickup Prefix.

For more details on Eventlist BLF configuration guide, please refer to:

http://www.grandstream.com/sites/default/files/Resources/GRP2600_Eventlist_BLF_Guide.pdf

Screenshots

Users can take screenshots of the GRP2612/GRP2612P/GRP2612W/GRP2613/GRP2614/GRP2615 Screen, by pressing and holding the “**HOLD**” key and then the “**MENU**” key, the output will be shown on the phone's Web GUI under “Status → System Info” as shown in the figure below:

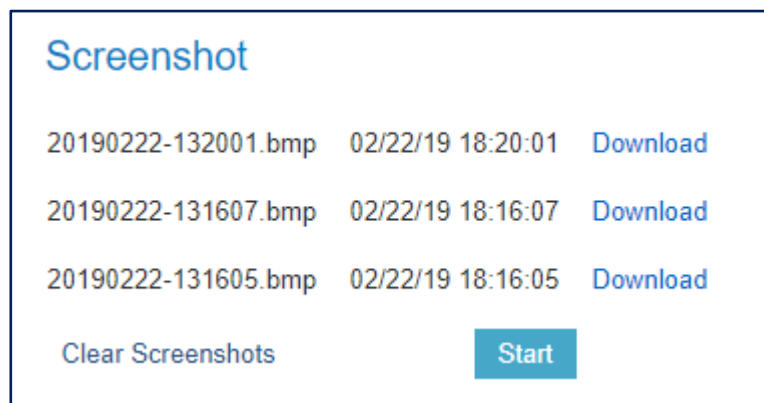

Figure 58: Screenshots

- Users can “Download” then view the screenshot.
- Users can clear the available Screenshots by pressing “Start”

Diagnosis

Users could access factory functions menu in order to diagnosis the phone's hardware/software. To do so please access to LCD menu under **System → Factory Functions** or use the shortcut by pressing the “HOLD” Key and the “Up-arrow” key at the same time.

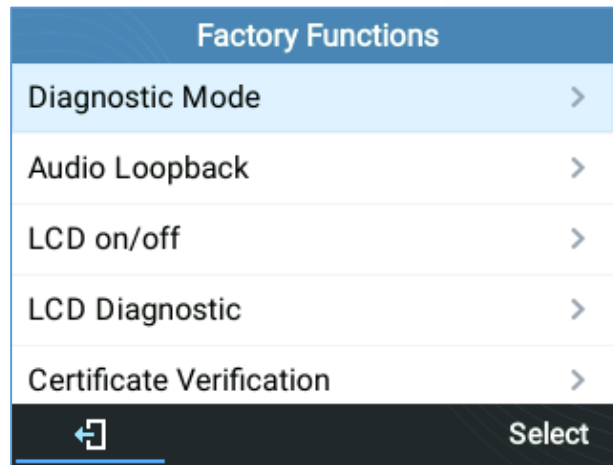

Figure 59: Factory Functions

These tools can be used to check the hardware and software status of the phone like verifying the LED, keypad buttons, LCD and certificates verification ...etc.

CONTACTS

Local Contacts

The local contacts can save up to 1000 entries. Users can manage contacts by adding, deleting and modifying single contacts, downloading contacts from HTTP/TFTP server, importing contacts from external storage and exporting contacts to external storage.

For more details please refer to the admin Guide:

http://www.grandstream.com/sites/default/files/Resources/GRP26XX_administration_guide.pdf

Add a single Contact

On the Local Contacts menu, select Local Phonebook then press “New” soft key. The phone will display the following:

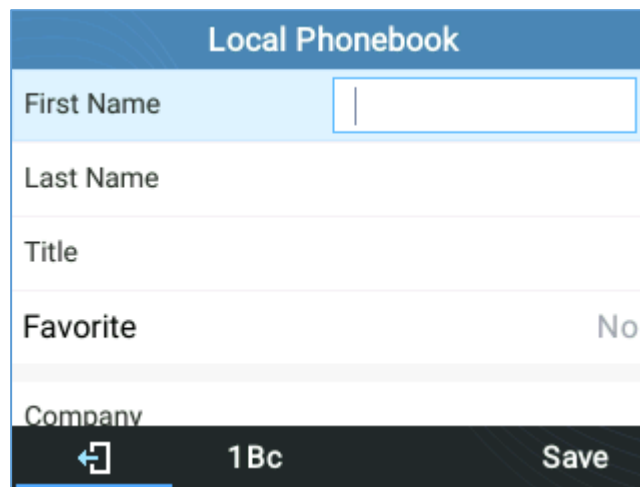

Local Phonebook	
First Name	<input type="text"/>
Last Name	<input type="text"/>
Title	<input type="text"/>
Favorite	No
Company	<input type="text"/>

← 1 Bc Save

Figure 60: New contact

Input the contact details then press “Save” soft key. The new contact will be added to your local phonebook.

Phonebook

XML Phonebook syntax

User can add contacts using the below syntax in phonebook.xml file:

```
<AddressBook>
<Contact>
<id>1</id>
<FirstName>abc</FirstName>
<LastName>def</LastName>
<JobTitle>jobtitle</JobTitle>
<Frequent>0</Frequent>
<Phone type="Work">
<phonenumber>1111</phonenumber>
```

```

<accountindex>0</accountindex>
</Phone>
<Phone type="Home">
<phonenumber>2222</phonenumber>
<accountindex>0</accountindex>
</Phone>
<Phone type="Mobile">
<phonenumber>3333</phonenumber>
<accountindex>0</accountindex>
</Phone>
<Primary>1</Primary>
<Department>department</Department>
<Job>job</Job>
<Title>title</Title>
<Company>company</Company>
</Contact>
</AddressBook>

```

On the LCD screen, under Contacts. The phone will display the following:



Figure 61: Local Phonebook - Contact Information

User can also input the “Company”, “Title”, “Job” fields on the phonebook.xml like the previous example or through the phone’s LCD by pressing the “Edit” soft key, as below:

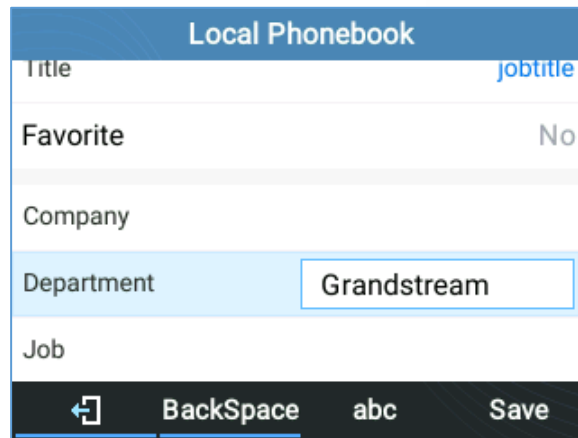

Figure 62: Local Phonebook - Company/Title/Job Fields

Dialed Numbers Filtering

After downloading phonebook, when dialing a number from the contacts, the number may include special characters such as “()”, “-”, or space in between numbers.

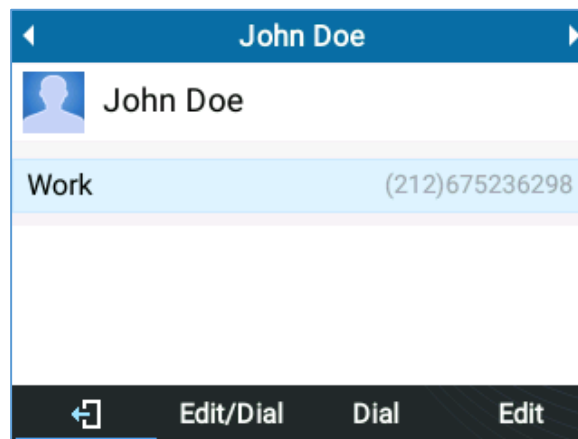

Figure 63: Contact Numbers with Special Characters

When pressing Dial softkey, the phone will filter the special characters and make the calls send out properly.

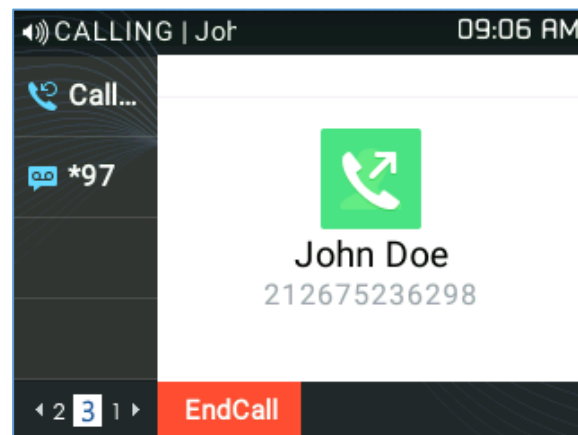

Figure 64: Call with Filtered Characters

Contact search mode

Quick Match

The quick search feature allows users to search parts and strings of the entries. For instance, if users only remember the first name, last name or parts of the name / phone number, they can use the string in the search bar as displayed on the following screenshots:

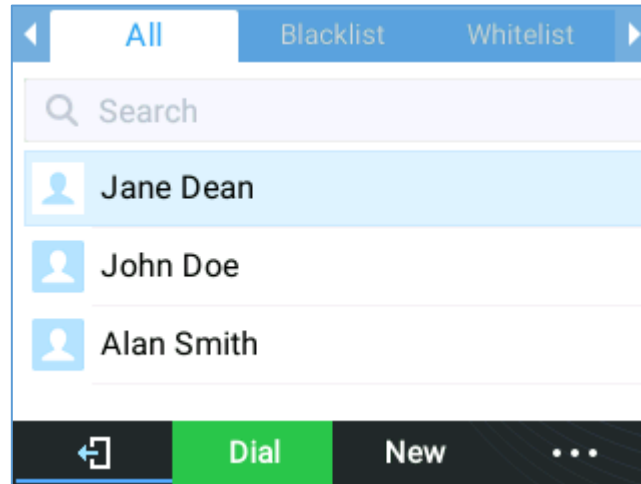

Figure 65: Before Search

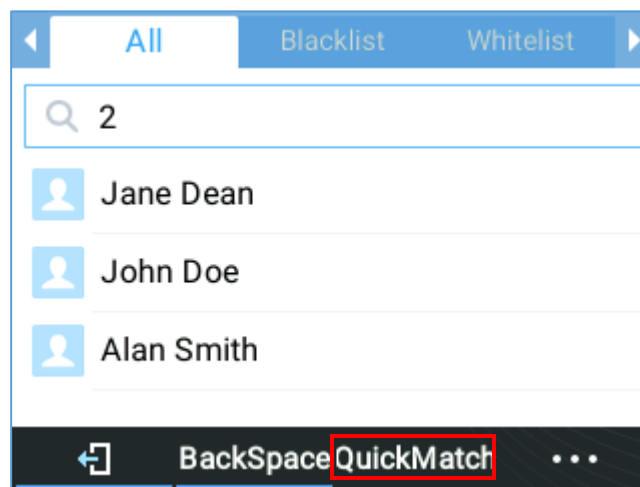

Figure 66: QuickMatch

Exact Matching

Users can search their contacts using alphabets in the exact mode which allows them to find their contacts even if they forget the numbers. To perform this type of search, make sure that search type is set to “ExactMatch” as shown on the following figure, then you can enter the exact name of the contact for lookup.

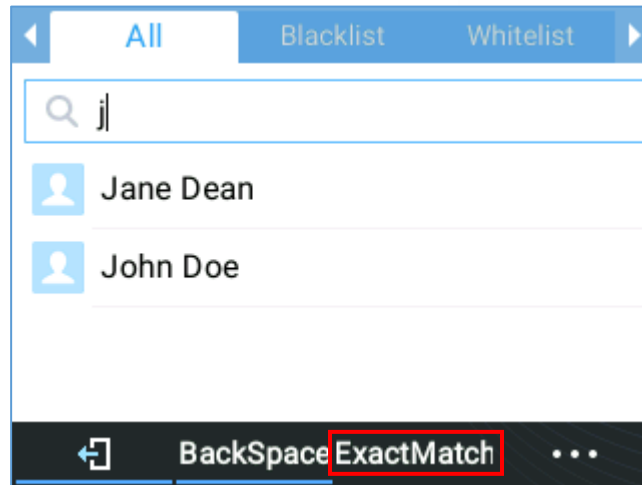

Figure 67: ExactMatch

LDAP

Functionality

Users can search contacts on the LDAP server from Contacts Menu, under LDAP Directory. This option can be configured under device **web UI** → **Phonebook** → **LDAP**. For further information, please refer to the admin guide.

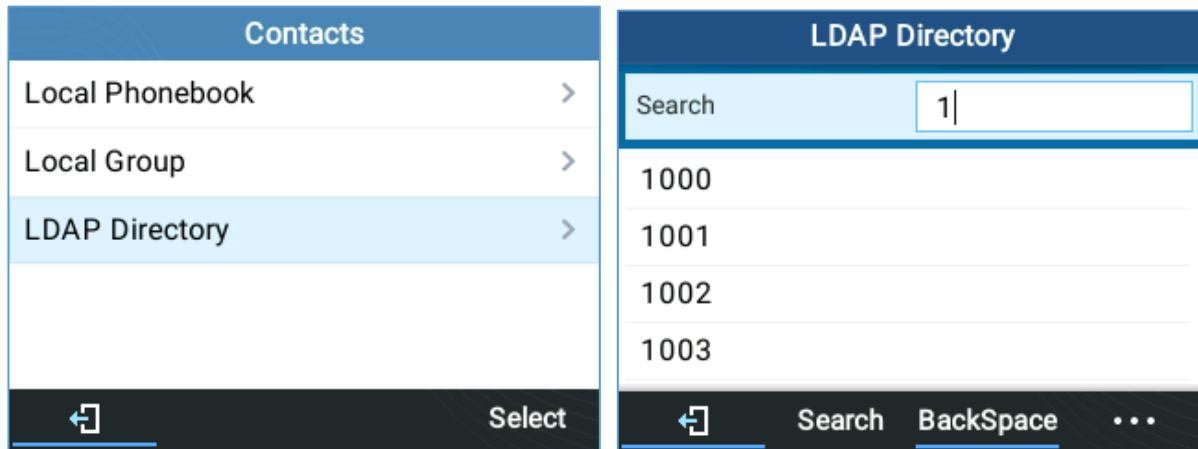

Figure 68: LDAP search

Broadsoft Directories

Functionality

Users can also search from the Broadsoft directories by entering target content in the search form. This option can be configured under device **web UI** → **Settings** → **Broadsoft**. For further information, please refer to the admin guide.



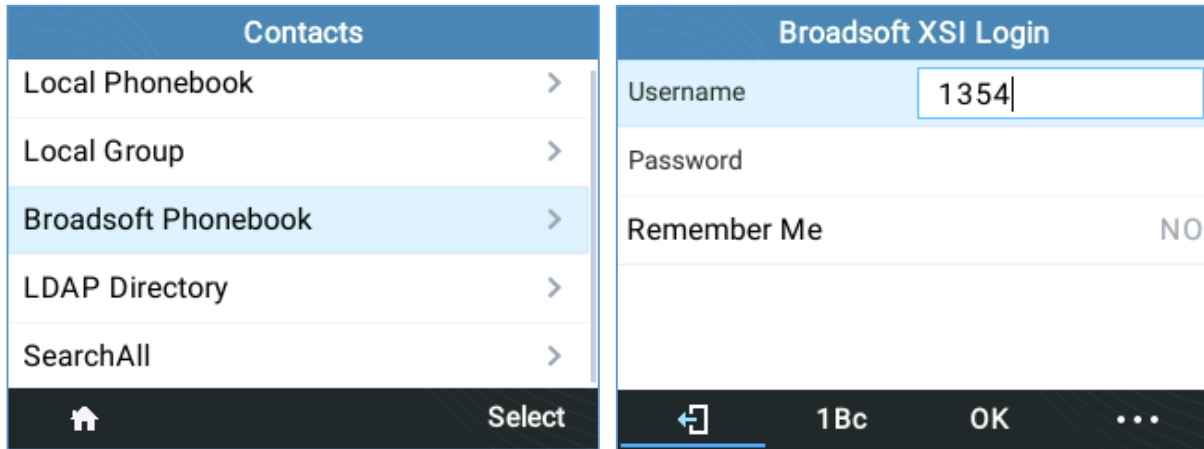







Figure 69: Search in Broadsoft Directories

CALL HISTORY

Local Call History

There are five different categories in the local call history. Users could use the navigation keys to browse call logs:

- **All** : 
- **Missed** : 
- **Dialed** : 
- **Answered** : 
- **Transferred** : 

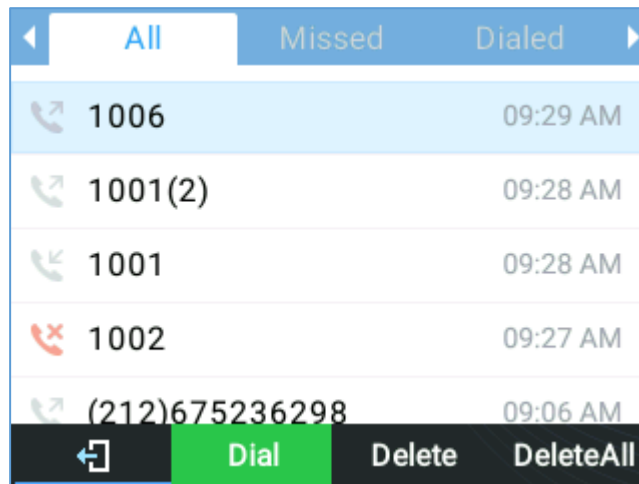

Figure 70: Call History Screen Page

- **Dial:** Tap on one of the call history entry to call this number directly. The phone will use the same account as the call log when dialing out.
- **Delete:** Select an entry then press “Delete” soft key
- **DeleteAll:** Clear the call history

Missed Calls Indication

When users miss a call, the GRP2612/GRP2612P/GRP2612W/GRP2613/GRP2614/GRP2615 will show the notification on the LCD screen as shown below:

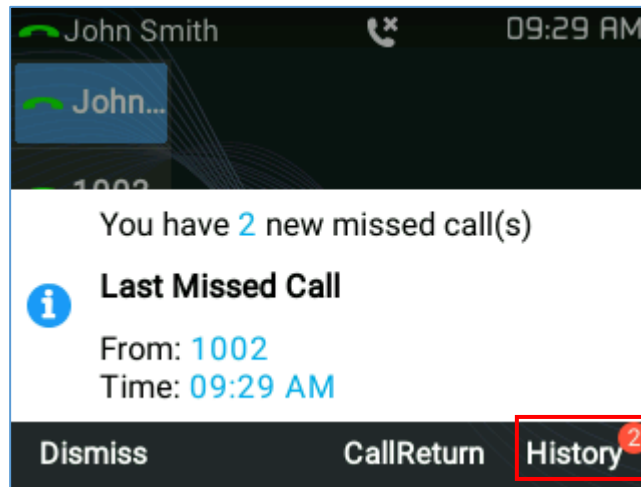

Figure 71: Missed Calls

Users have the option to return the call immediately by clicking the “**CallReturn**” Softkey.

Note:

Users can set the phone to turn off LCD backlight while having a missed call. This option can be found under device **web UI** → **Settings** → **Preferences** → **LCD Display** → **disable missed call backlight**. If users want to have missed call notification, select yes, bug flash MWI LED.

CONNECTING TO DEVICES

EHS Headset

The GRP2612/GRP2612P/GRP2612W/GRP2613/GRP2614/GRP2615 supports normal RJ11 headset and Plantronics EHS headset.

To use Plantronics EHS headset, go to the web GUI→**Settings**→**Audio Control**: Headset Type. Select "Plantronics EHS" then reboot the phone.

1. Connect EHS Headset (Plantronics) to the phone. Insert headset connector into the RJ11 headset port on the back of GRP2612/GRP2612P/GRP2612W/GRP2613/GRP2614/GRP2615.

2. To use headset mode, press headset button . A headset icon  will show on the LCD.

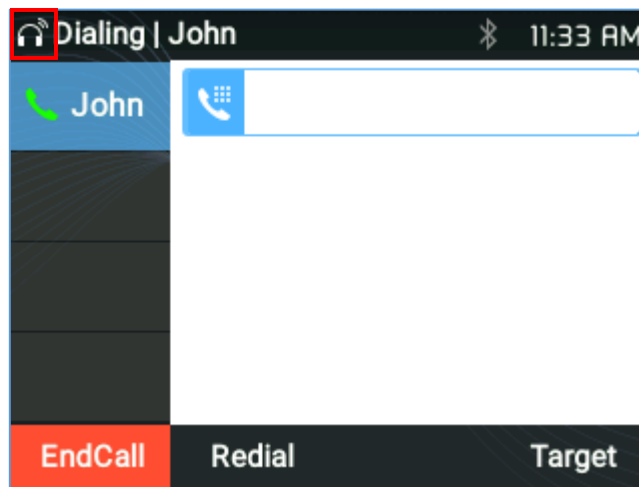

Figure 72: Headset enabled

Bluetooth (GRP2615/GRP2614 only)

GRP2614/GRP2615 is also capable to connect to Bluetooth devices. supporting Bluetooth version 5. Users could connect to cellphones (supporting Bluetooth) via hands free mode or use Bluetooth headset for making calls.

To connect to a Bluetooth device, turn on the Bluetooth radio first. The first time when using a new Bluetooth device with the GRP2614/GRP2615, "pair" the device with the phone so that both devices know how to connect securely to each other. After that, users could simply connect to a paired device.

Bluetooth related settings are under Phone's LCD **Menu** → **System** → **Bluetooth**.

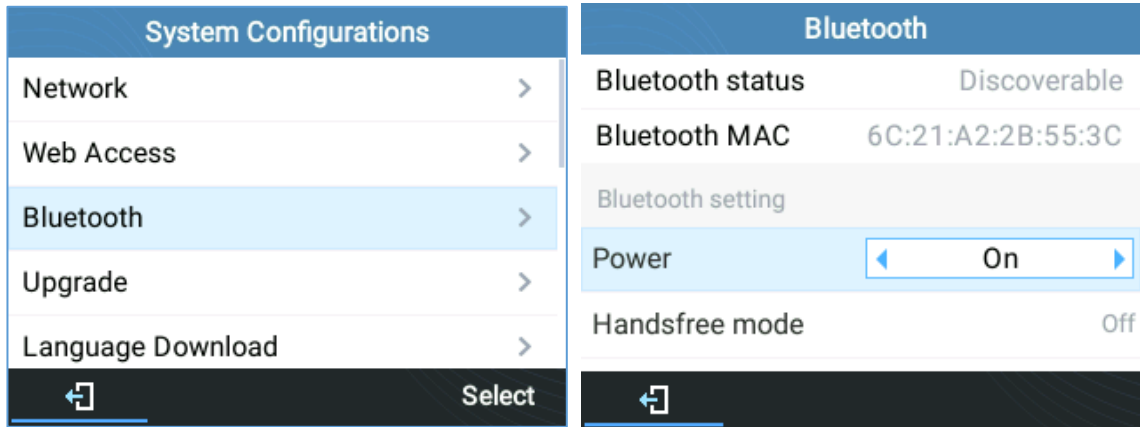

Figure 73: Bluetooth feature

There are two ways to pair the GRP2614/GRP2615 using the Bluetooth feature:

❑ **From the GRP2615/GRP2614**

1. Select “Start Scan” to search nearby Bluetooth devices

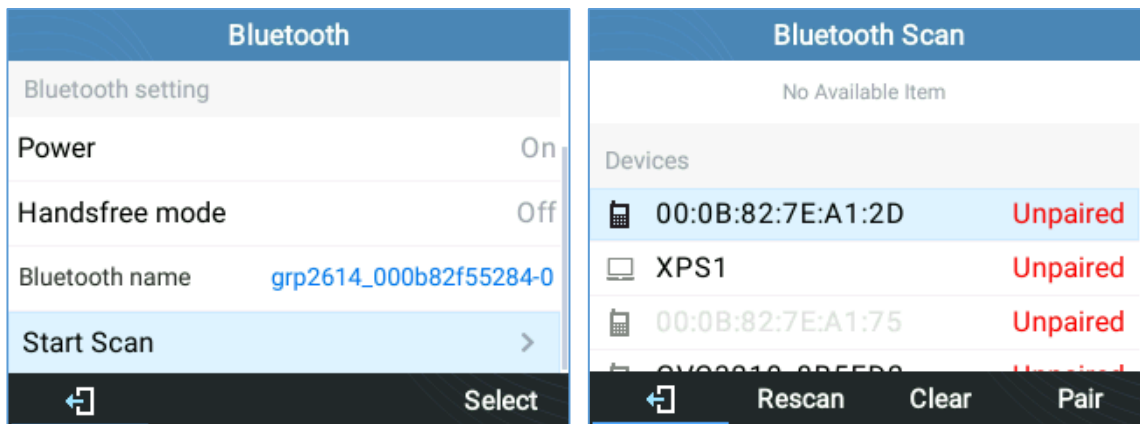

Figure 74: Bluetooth Scan

2. Choose a device then select “Pair”. The phone will then start the pairing process

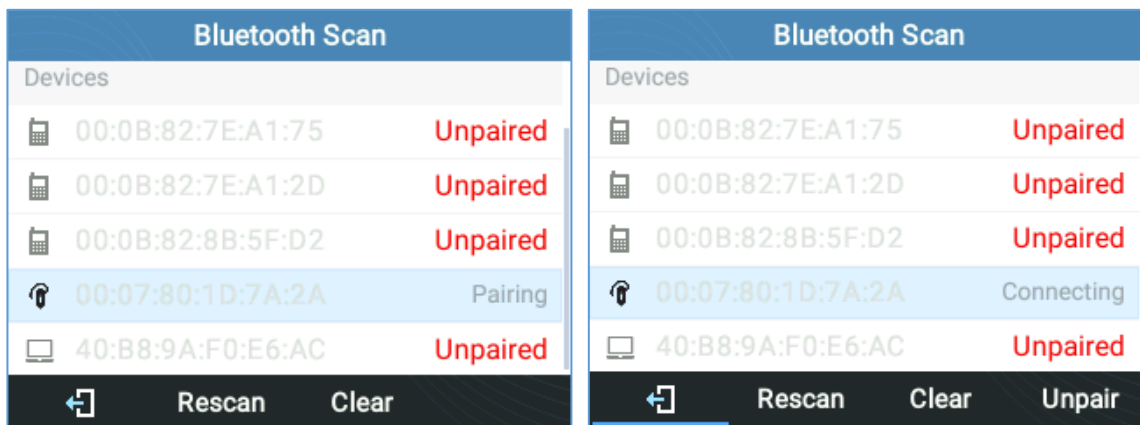

Figure 75: GRP2615/GRP2614 Pairing Process

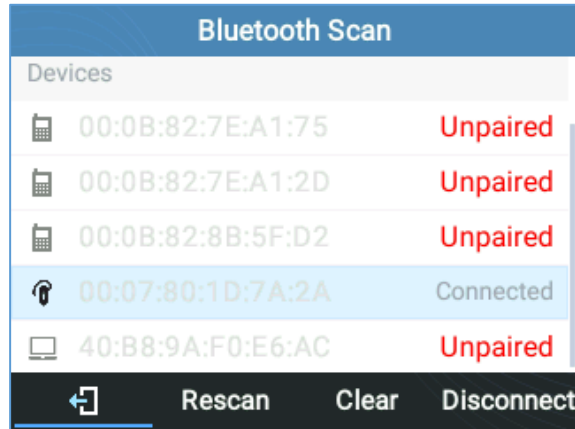

Figure 76: Successful Bluetooth pairing

- If the pairing succeeds, users will see "Connected" next to the name of the Bluetooth device.

❑ From a Bluetooth different device:

- Make sure the Bluetooth is powered on and shows "Discoverable" under "Bluetooth status"

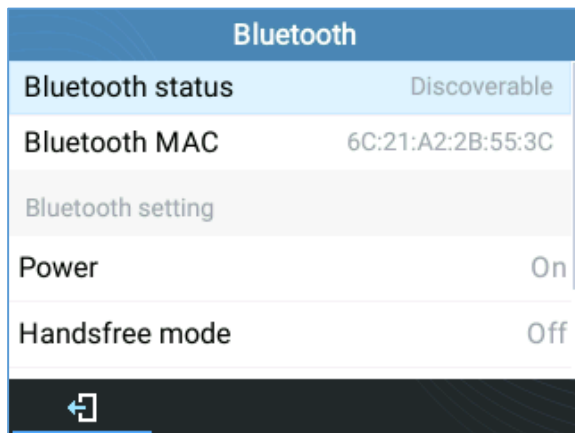

Figure 77: Bluetooth Status

- Press "YES" to accept the pairing request

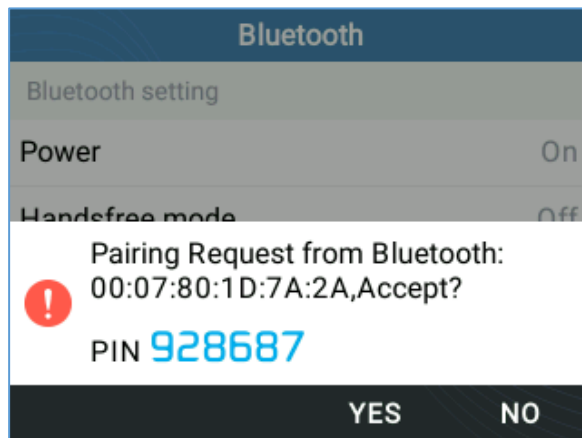

Figure 78: Pairing Request

Notes:

- Turn off Bluetooth if it is not used.
- For more details on the Bluetooth features, please refer to:

http://www.grandstream.com/sites/default/files/Resources/GRP2600_Bluetooth_Guide.pdf

WiFi (GRP2615/GRP2614/GRP2612W only)

To connect the GRP2615/GRP2614/GRP2612W to a WiFi Network through the keypad menu. Please follow the below steps:

1. On LCD **MENU**, navigate to **System → WiFi settings**.

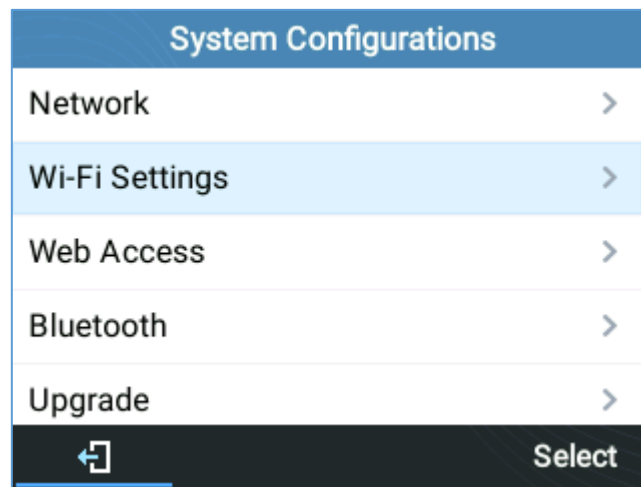

Figure 79: WiFi feature

2. Set WiFi to “Enabled” and press “Save” button.

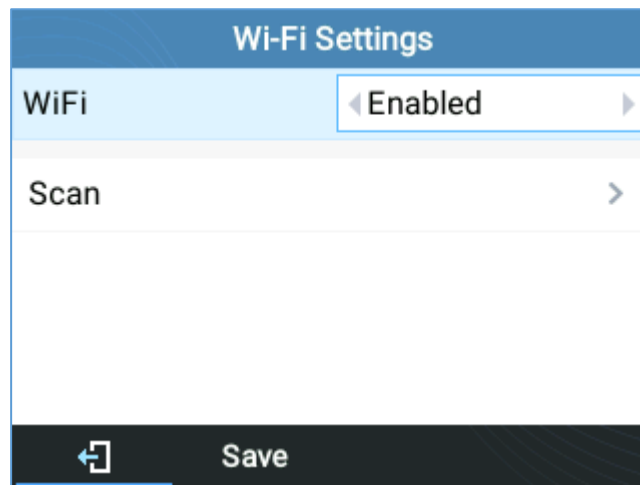

Figure 80; Enable WiFi

3. Select “Scan”.

The device will automatically start scanning for WiFi access points within the range

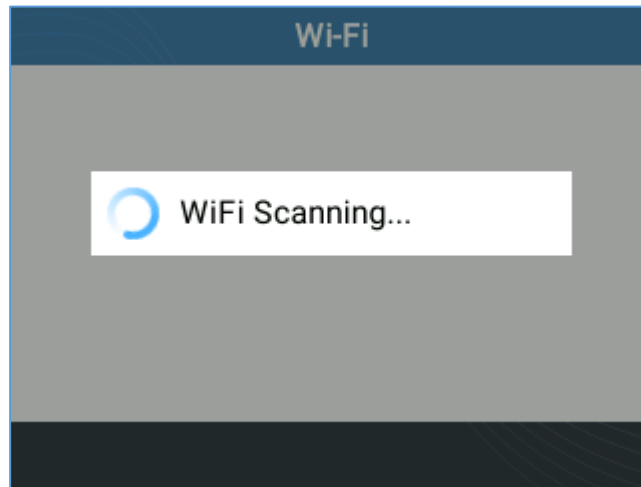

Figure 81: WiFi Scanning

- A list of available WiFi networks will be displayed. Select the desired network,

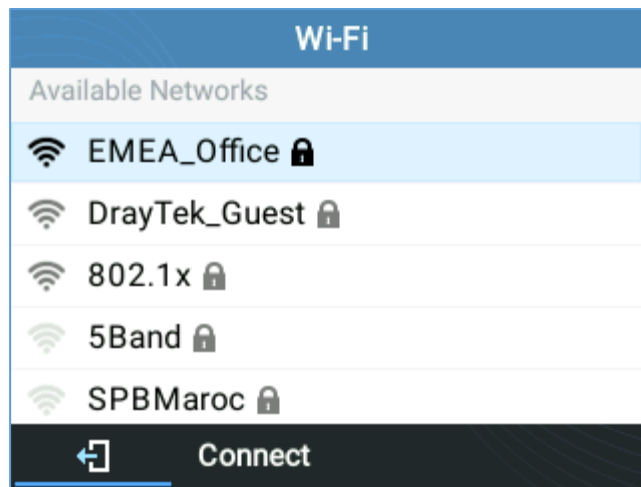

Figure 82: Nearby WiFi networks

- If required, enter the password to connect.

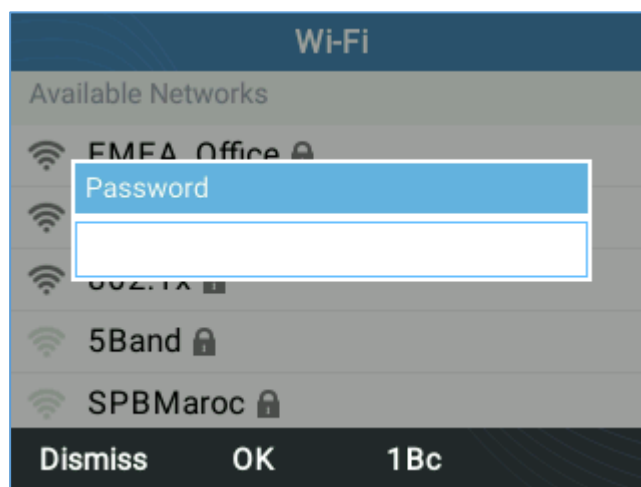

Figure 83: WiFi password required

- An incorrect password will trigger an error message “Cannot connect to the selected network”.



- If the connection is successful a “WiFi NetWork Connected” message will display on screen

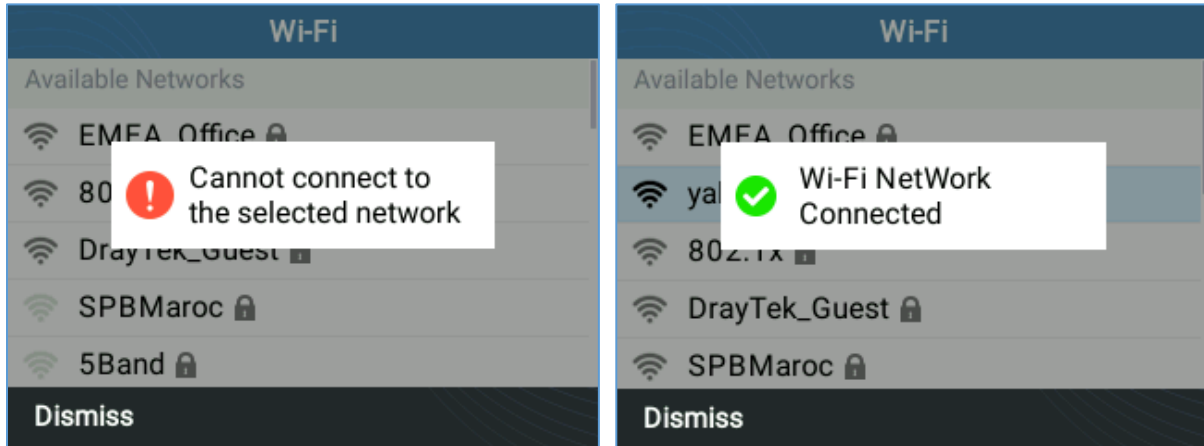

Figure 84: Failed/Successful WiFi connection

7. Check the Wi-Fi icon on idle screen to verify if the WiFi network is properly connected

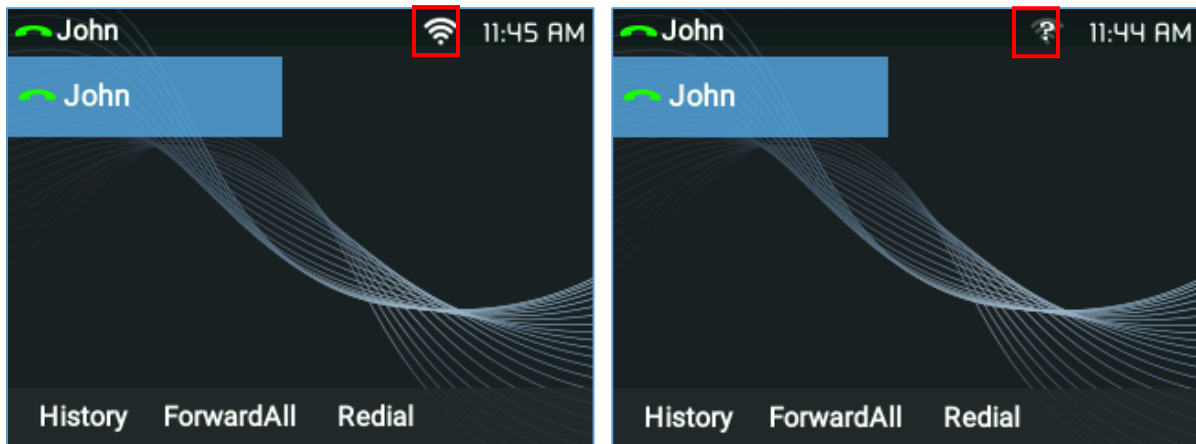

Figure 85: WiFi Status

8. A new section “Current Connection” will show under **System** → **WiFi settings**.

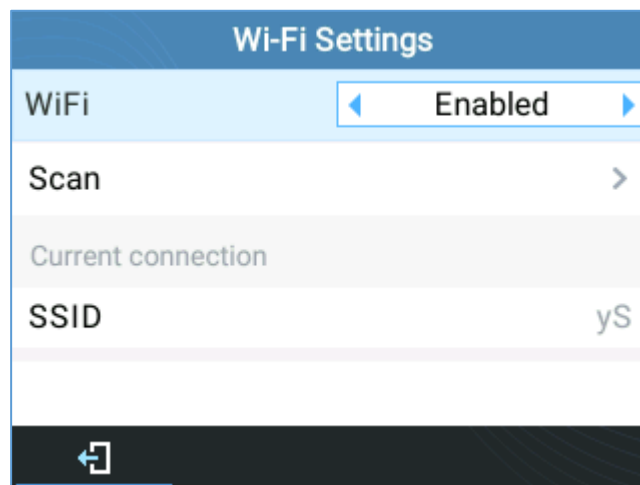

Figure 86 : Current connection

9. Selecting “Scan”, Users may choose to “Forget” the current connection and establish a new one.

RESTORE FACTORY DEFAULT SETTINGS

 **Warning:**

Restoring the Factory Default Settings will delete all configuration information on the phone. Please backup or print all the settings before you restore to the factory default settings. Grandstream is not responsible for restoring lost parameters and cannot connect your device to your VoIP service provider.

Restore factory settings using LCD menu

Please follow the instructions below to reset the phone:

1. Press MENU button to bring up the keypad configuration menu.
2. Select "System" and enter.
3. Select "Operations - Factory Reset".
4. A warning window will pop out to make sure a reset is requested and confirmed.

Press the "Yes" Softkey to confirm and the phone will reboot, or "No" Softkey to cancel the Reset.

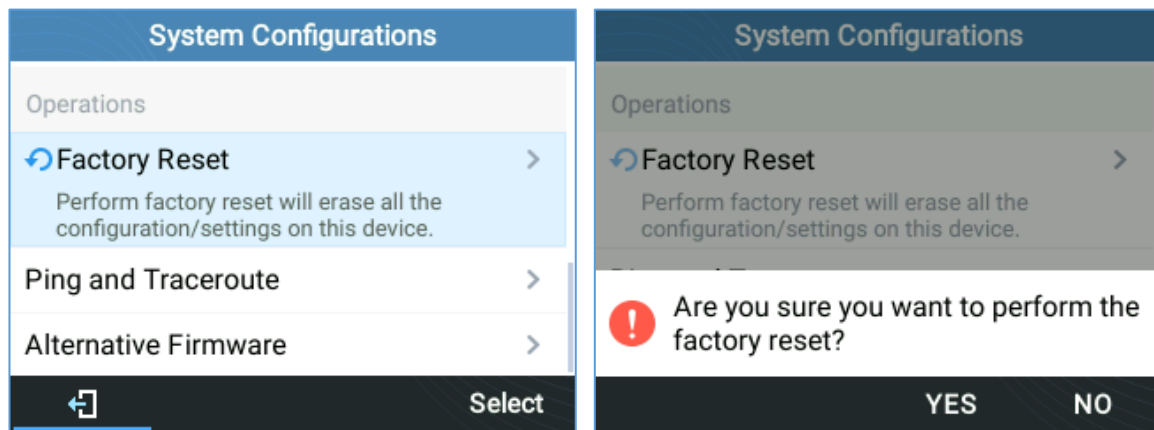

Figure 87: Factory Reset using LCD Menu

EXPERIENCING GRP26XX

Please visit our website: <http://www.grandstream.com> to receive the most up- to-date updates on firmware releases, additional features, FAQs, documentation and news on new products.

We encourage you to browse our [product related documentation](#), [FAQs](#) and [User and Developer Forum](#) for answers to your general questions. If you have purchased our products through a Grandstream Certified Partner or Reseller, please contact them directly for immediate support.

Our technical support staff is trained and ready to answer all your questions. Contact a technical support member or [submit a trouble ticket online](#) to receive in-depth support.

Thank you again for purchasing Grandstream IP phone, it will be sure to bring convenience and color to both your business and personal life.

