



Maintenance and Service Guide

HP ProBook x360 11 G4 Education Edition

IMPORTANT! This document is intended for HP authorized service providers only.

© Copyright 2019 HP Development Company, L.P.

Bluetooth is a trademark owned by its proprietor and used by HP Inc. under license. Intel and Core are trademarks of Intel Corporation in the U.S. and other countries. MicroSD, SDHC, and SDXC are trademarks or registered trademarks of SD-3C in the United States, other countries or both. Windows is either a registered trademark or trademark of Microsoft Corporation in the United States and/or other countries.

The information contained herein is subject to change without notice. The only warranties for HP products and services are set forth in the express warranty statements accompanying such products and services. Nothing herein should be construed as constituting an additional warranty. HP shall not be liable for technical or editorial errors or omissions contained herein.

First Edition: March 2019

Document Part Number: L60735-001

Product notice

This guide describes features that are common to most models. Some features may not be available on your computer.

Not all features are available in all editions or versions of Windows. Systems may require upgraded and/or separately purchased hardware, drivers, software or BIOS update to take full advantage of Windows functionality. Windows 10 is automatically updated, which is always enabled. ISP fees may apply and additional requirements may apply over time for updates. Go to <http://www.microsoft.com> for details.

To access the latest user guides, go to <http://www.hp.com/support>, and follow the instructions to find your product. Then select **User Guides**.

Software terms

By installing, copying, downloading, or otherwise using any software product preinstalled on this computer, you agree to be bound by the terms of the HP End User License Agreement (EULA). If you do not accept these license terms, your sole remedy is to return the entire unused product (hardware and software) within 14 days for a full refund subject to the refund policy of your seller.

For any further information or to request a full refund of the price of the computer, please contact your seller.

Safety warning notice

 **CAUTION:** To reduce the possibility of heat-related injuries or of overheating the device, do not place the device directly on your lap or obstruct the device air vents. Use the device only on a hard, flat surface. Do not allow another hard surface, such as an adjoining optional printer, or a soft surface, such as pillows or rugs or clothing, to block airflow. Also, do not allow the AC adapter to contact the skin or a soft surface, such as pillows or rugs or clothing, during operation. The device and the AC adapter comply with the user-accessible surface temperature limits defined by applicable safety standards.

Table of contents

1 Product description	1
2 Components	4
Right	4
Left	5
Display	7
Keyboard area	8
Touchpad	8
Lights	9
Keyboard webcam	10
Special keys	11
Bottom	12
Labels	13
3 Illustrated parts catalog	14
Computer major components	14
Miscellaneous parts	16
Bracket Kit	17
Cable Kit	18
4 Removal and replacement procedures preliminary requirements	19
Tools required	19
Service considerations	19
Plastic parts	19
Cables and connectors	19
Drive handling	20
Workstation guidelines	20
Electrostatic discharge information	20
Generating static electricity	21
Preventing electrostatic damage to equipment	21
Personal grounding methods and equipment	22
Grounding the work area	22
Recommended materials and equipment	22
Packaging and transporting guidelines	23

5 Removal and replacement procedures for Authorized Service Provider parts	24
Component replacement procedures	24
Preparation for disassembly	24
Keyboard/top cover	24
Touchpad	27
Second webcam and webcam transfer board	29
Battery	31
Solid-state drive	32
WLAN module	33
RTC battery	35
Speakers	36
USB board	37
Audio board	38
Power connector cable (DC-in)	40
System board	41
Heat sink	44
Display assembly	46
6 Computer Setup (BIOS), TPM, and HP Sure Start	48
Using Computer Setup	48
Starting Computer Setup	48
Navigating and selecting in Computer Setup	48
Restoring factory settings in Computer Setup	48
Updating the BIOS	49
Determining the BIOS version	49
Downloading a BIOS update	49
Changing the boot order using the f9 prompt	50
TPM BIOS settings (select products only)	50
Using HP Sure Start (select products only)	51
7 Backing up, restoring, and recovering	52
Backing up information and creating recovery media	52
Using Windows tools	52
Using the HP Cloud Recovery Download Tool to create recovery media (select products only)	52
Restoring and recovery	53
Restoring, resetting, and refreshing using Windows tools	53
Recovering using HP Recovery media	53
Changing the computer boot order	53

8 Using HP PC Hardware Diagnostics	54
Using HP PC Hardware Diagnostics Windows (select products only)	54
Downloading HP PC Hardware Diagnostics Windows	54
Downloading the latest HP PC Hardware Diagnostics Windows version	55
Downloading HP Hardware Diagnostics Windows by product name or number (select products only)	55
Installing HP PC Hardware Diagnostics Windows	55
Using HP PC Hardware Diagnostics UEFI	55
Starting HP PC Hardware Diagnostics UEFI	56
Downloading HP PC Hardware Diagnostics UEFI to a USB flash drive	56
Downloading the latest HP PC Hardware Diagnostics UEFI version	56
Downloading HP PC Hardware Diagnostics UEFI by product name or number (select products only)	56
Using Remote HP PC Hardware Diagnostics UEFI settings (select products only)	57
Downloading Remote HP PC Hardware Diagnostics UEFI	57
Downloading the latest Remote HP PC Hardware Diagnostics UEFI version	57
Downloading Remote HP PC Hardware Diagnostics UEFI by product name or number	57
Customizing Remote HP PC Hardware Diagnostics UEFI settings	57
 9 Specifications	 59
Computer specifications	59
 10 Statement of memory volatility	 60
Nonvolatile memory usage	62
Questions and answers	64
Using HP Sure Start (select models only)	65
 11 Power cord set requirements	 66
Requirements for all countries	66
Requirements for specific countries and regions	67
 12 Recycling	 69
 Index	 70

1 Product description

Table 1-1 Product components and their descriptions

Category	Description
Product Name	HP ProBook x360 11 G4 Education Edition
Processors	Intel® Core® i5-8200Y 1.3 GHz (turbo up to 3.9 GHz) dual core processor, 1866 MHz FSB, 4 MB L3 cache, 5 W (Intel UHD Graphics 615) Intel Core m3-8100Y 1.1 GHz (turbo up to 3.4 GHz) dual core processor, 1866 MHz FSB, 4 MB L3 cache, 5 W (Intel UHD Graphics 615)
Graphics	Intel Universal Memory Architecture (UMA) Intel HD Graphics 615 Support for DirectX 12
Panel	29.46 cm (11.6 in), high-definition (HD) (1366 × 768), light-emitting diode (LED), EDP, slim, 220 nits, touch display with HD camera <ul style="list-style-type: none">• SVA• UWVA
Memory module	Support for up to 8 GB, LPDDR3-1866, on-board system memory in the following configurations: <ul style="list-style-type: none">• 8 GB• 4 GB
Storage	Solid-state drive (M.2) 256 GB, PCIe, value 128 GB, SATA-3, TLC
Audio and video	Front-facing camera: 1 MP high definition (HD) @ 1280 × 720p Second camera: 5 MP full high-definition (FHD) @ 2560 × 1920p (select models only) Integrated dual digital microphones HP HD audio Dual speakers Realtek ALC3247
RJ-45 (network) jack	Realtek GBE Ethernet (Non-DASH, QFN32) Support for S3/S4/S5 wake on LAN (via out of band): HP USB-C Universal Dock Support for S0/S3/S4/S5 MAPT (via out of band): HP USB-C Universal Dock BIOS Support RTXMAC for MAPT via in-band
Wireless	Integrated WLAN options with dual antennas (M.2 2230 socket PCIe/USB) <ul style="list-style-type: none">• Intel Wireless-AC 9260 802.11ac 2 × 2 Wi-Fi + Bluetooth® 5.0• Realtek RTL8822BE 802.11ac 2 × 2 Wi-Fi + Bluetooth 4.2 Combo Adapter

Table 1-1 Product components and their descriptions (continued)

Category	Description
	Static Wi-Fi BIOS SAR support for Intel Wireless-AC 9260
	Support for Turbo Lite Wi-Fi
	Wireless antennas configured at top of display
	Support for Miracast
	Support for WoWLAN S3/S4 (AC only)
	Support for HP LAN wireless protection (WLAN/LAN switching)
	Support for HP Connection Optimizer with data analytics
Media card reader	Support for microSD™/SDHC™/SDXC™ up to UHS-104
	Push-push insertion/removal
Ports	Headphone/microphone combo jack
	AC Smart Pin adapter plug
	HDMI v1.4b supporting up to 3840 × 2160 @ 30 Hz
	Auto adjust panel resolution to fit embedded panel and external monitor connected
	USB 3.1 Gen 1 port with Type-A connector (2)
	USB 3.1 port with Type-C connector (data and power)
Sensors	Combination chip
	Accelerometer
	Magnetometer
	Gyroscope
Keyboard	Keyboard
	Full-sized, chiclet-style keyboard
	Pick-resistant
	Spill resistant
	Touchpad requirements
	Multitouch gestures enabled
	Support for Windows® 10 trackpad gestures
	Taps enabled as default
	Default on 2-finger scroll, pinch
Pen input	Wacom AES pen with loop (select models only)
	Support for passive pen
Power requirements	Battery
	3-cell, 48 Whr, long-life lithium polymer soft pack battery
	HP Fast Charge Technology

Table 1-1 Product components and their descriptions (continued)

Category	Description
	Supports long battery life (1,000 charging cycles)
	AC adapter
	65 W HP Smart AC adapter (non-PFC, EM, 4.5 mm)
	45 W HP Smart AC adapter (non-PFC, 4.5 mm)
	45 W USB Type-C straight, nPFC
	Power cord
	1.0 m convention power cord
Security	Nano security slot
Operating system	Preinstalled
	Windows 10 Enterprise 64
	Windows 10 Home 64
	Windows 10 Home 64 Single Language
	Windows 10 Home 64 Chinese Market CPPP
	Windows 10 Home 64 Single Language APAC EM PPP
	Windows 10 Home 64 Single Language India Market PPP
	Windows 10 Home 64 Single Language Indonesia Market PPP
	Windows 10 Pro 64
	Windows 10 Pro 64 CBB 1803
	Windows 10 Pro 64 Chinese Market
	Windows 10 Pro 64 StF MSNA
	Windows 10 Pro S 64 StF MSNA Standard
	Restore media
	Windows 10 Driver DVD
	Windows 10 Professional 64-bit OS DVD
	Web support OS
	Windows 10 Enterprise 64
	Win 10 Pro 64 CBB 1803
	Certified
	Microsoft WHQL
Serviceability	End user replaceable part
	AC adapter
	Pen

2 Components

Your computer features top-rated components. This chapter provides details about your components, where they are located, and how they work.

Right

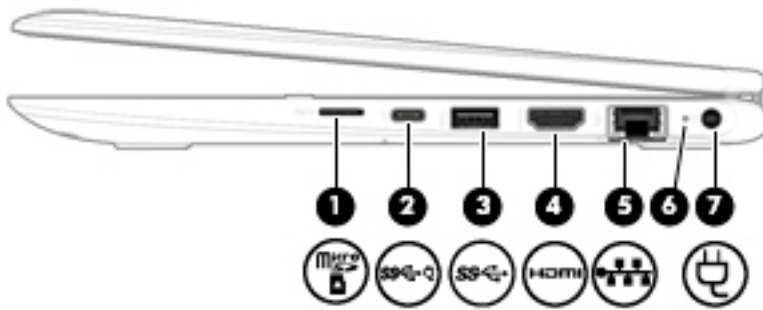

Table 2-1 Right-side components and their descriptions







Component	Description
(1)  MicroSD memory card reader	Reads optional memory cards that store, manage, share, or access information. To insert a card: <ol style="list-style-type: none">1. Hold the card label-side up, with the connectors facing the computer.2. Insert the card into the memory card reader, and then press in on the card until it is firmly seated. To remove a card: <ul style="list-style-type: none">▲ Press in on the card, and then remove it from the memory card reader.
(2)  USB Type-C port	Connects a USB device, such as a cell phone, camera, activity tracker, or smartwatch, and provides data transfer. NOTE: Cables and/or adapters (purchased separately) may be required.
(3)  USB SuperSpeed port	Connects a USB device, such as a cell phone, camera, activity tracker, or smartwatch, and provides high-speed data transfer.
(4)  HDMI port	Connects an optional video or audio device, such as a high-definition television, any compatible digital or audio component, or a high-speed High Definition Multimedia Interface (HDMI) device.
(5)  RJ-45 (network) jack/status lights	Connects a network cable. <ul style="list-style-type: none">• Green (left): The network is connected.• Amber (right): Activity is occurring on the network.
(6) Battery light	When AC power is connected:

Table 2-1 Right-side components and their descriptions (continued)

Component	Description
	<ul style="list-style-type: none"> White: The battery charge is greater than 90 percent. Amber: The battery charge is from 0 to 90 percent. Off: The battery is not charging. <p>When AC power is disconnected (battery not charging):</p> <ul style="list-style-type: none"> Blinking amber: The battery has reached a low battery level. When the battery has reached a critical battery level, the battery light begins blinking rapidly. Off: The battery is not charging.
(7) 	<p>Power connector</p> <p>Connects an AC adapter.</p>

Left

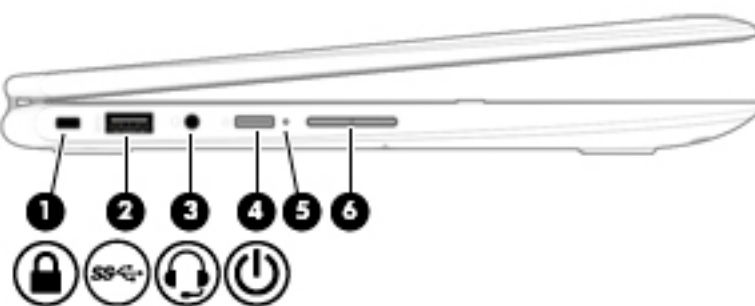

Table 2-2 Left-side components and their descriptions





Component	Description
(1) 	<p>Security cable slot</p> <p>Attaches an optional security cable to the computer.</p> <p>NOTE: The security cable is designed to act as a deterrent, but it may not prevent the computer from being mishandled or stolen.</p>
(2) 	<p>USB SuperSpeed port</p> <p>Connects a USB device, such as a cell phone, camera, activity tracker, or smartwatch, and provides high-speed data transfer.</p>
(3) 	<p>Audio-out (headphone)/Audio-in (microphone) combo jack</p> <p>Connects optional powered stereo speakers, headphones, earbuds, a headset, or a television audio cable. Also connects an optional headset microphone. This jack does not support optional standalone microphones.</p> <p>WARNING! To reduce the risk of personal injury, adjust the volume before putting on headphones, earbuds, or a headset. For additional safety information, see the <i>Regulatory, Safety, and Environmental Notices</i>.</p> <p>To access this guide:</p> <ul style="list-style-type: none"> Select the Start button, select HP Help and Support, and then select HP Documentation.

Table 2-2 Left-side components and their descriptions (continued)

Component	Description
<p>(4)  Power button</p>	<p>NOTE: When a device is connected to the jack, the computer speakers are disabled.</p> <ul style="list-style-type: none"> • When the computer is off, press the button to turn on the computer. • When the computer is on, press the button briefly to initiate Sleep. • When the computer is in the Sleep state, press the button briefly to exit Sleep (select products only). • When the computer is in Hibernation, press the button briefly to exit Hibernation. <p>CAUTION: Pressing and holding down the power button results in the loss of unsaved information.</p> <p>If the computer has stopped responding and shutdown procedures are ineffective, press and hold the power button for at least 5 seconds to turn off the computer.</p> <p>To learn more about your power settings, see your power options.</p> <p>▲ Right-click the Power meter icon  and then select Power Options.</p>
(5) Power light	<ul style="list-style-type: none"> • On: The computer is on. • Blinking: The computer is in the Sleep state, a power-saving state. The computer shuts off power to the display and other unneeded components. • Off: The computer is off or in Hibernation. Hibernation is a power-saving state that uses the least amount of power.
(6) Volume button	Controls speaker volume on the computer.

*The antennas are not visible from the outside of the computer. For optimal transmission, keep the areas immediately around the antennas free from obstructions.

For wireless regulatory notices, see the section of the *Regulatory, Safety, and Environmental Notices* that applies to your country or region.

To access this guide:

▲ Select the **Start** button, select **HP Help and Support**, and then select **HP Documentation**.

Display



Table 2-3 Display components and their descriptions

Component	Description
(1) WLAN antennas*	Send and receive wireless signals to communicate with wireless local area networks (WLANs).
(2) Internal microphones	Record sound.
(3) Camera light	On: The camera is in use.
(4) Camera	Allows you to video chat, record video, and record still images. Some cameras also allow a facial recognition logon to Windows, instead of a password logon. NOTE: Camera functions vary depending on the camera hardware and software installed on your product.

*The antennas are not visible from the outside of the computer. For optimal transmission, keep the areas immediately around the antennas free from obstructions.

For wireless regulatory notices, see the section of the *Regulatory, Safety, and Environmental Notices* that applies to your country or region.

To access this guide:

- ▲ Select the **Start** button, select **HP Help and Support**, and then select **HP Documentation**.

Keyboard area

Touchpad

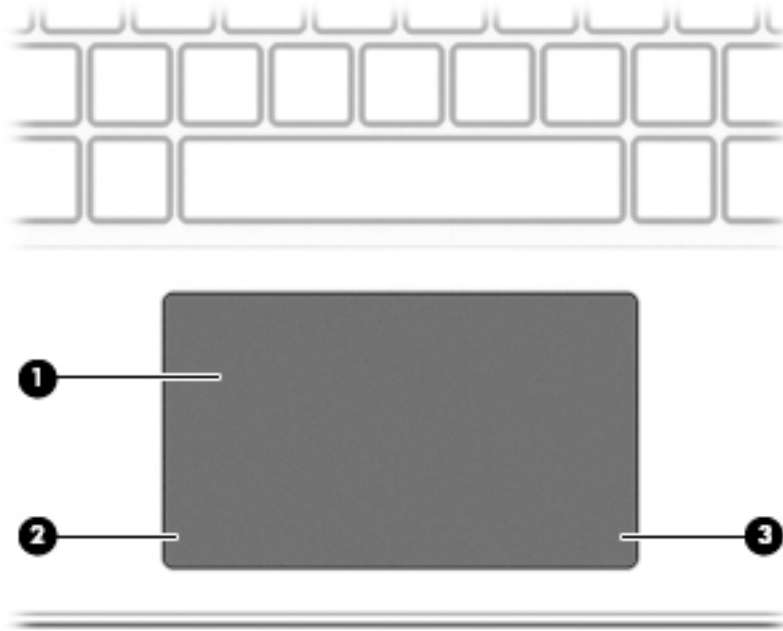

Table 2-4 Touchpad components and their descriptions

Component	Description
(1) Touchpad zone	Reads your finger gestures to move the pointer or activate items on the screen.
(2) Left touchpad button	Functions like the left button on an external mouse.
(3) Right touchpad button	Functions like the right button on an external mouse.

Lights

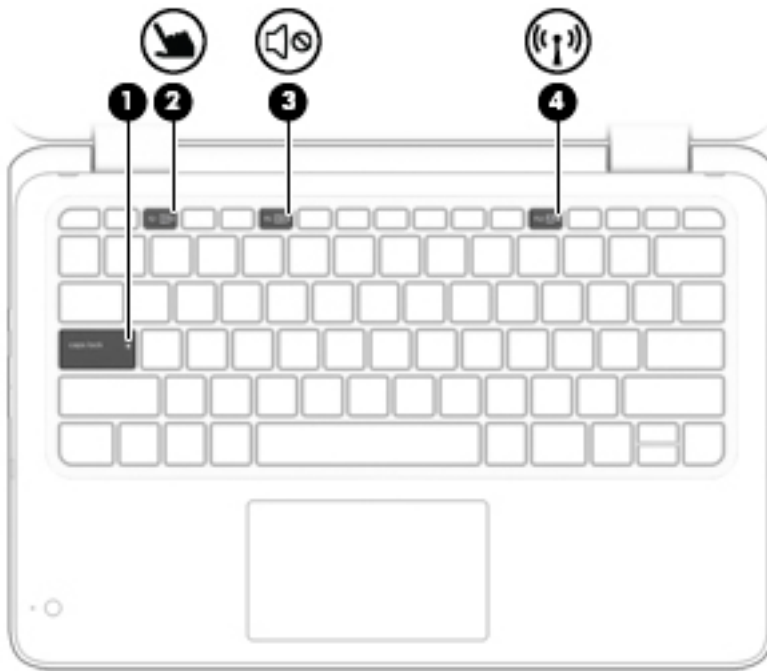



Table 2-5 Lights and their descriptions

Component	Description
(1) Caps lock light	On: Caps lock is on, which switches the key input to all capital letters.
(2) Touchpad light	<ul style="list-style-type: none">On: The touchpad is off.Off: The touchpad is on.
(3) Mute light	<ul style="list-style-type: none">On: Computer sound is off.Off: Computer sound is on.
(4)  Wireless light	On: An integrated wireless device, such as a wireless local area network (WLAN) device and/or a Bluetooth® device, is on. NOTE: On some models, the wireless light is amber when all wireless devices are off.

Keyboard webcam

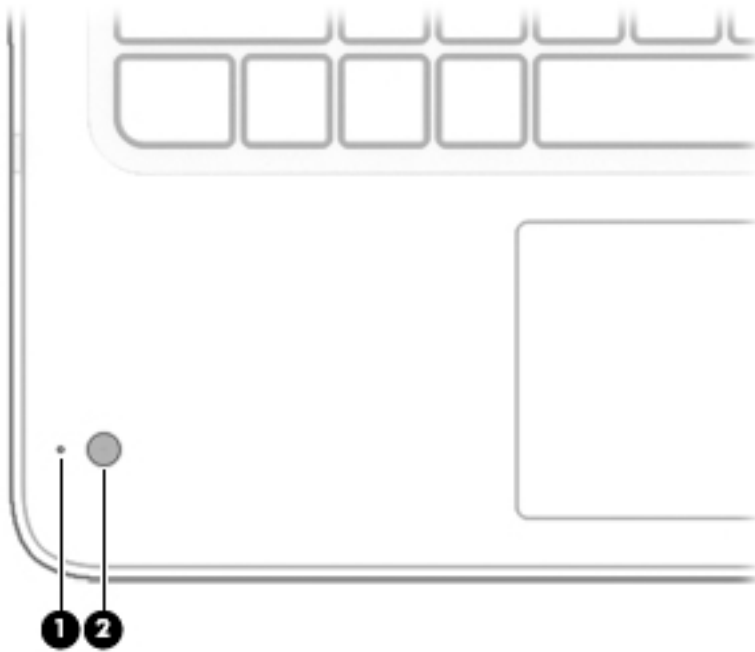

Table 2-6 Keyboard webcam components and their descriptions

Component	Description
(1) Camera light	On: The camera is in use.
(2) Camera	Allows you to video chat, record video, and record still images. Some cameras also allow a facial recognition logon to Windows, instead of a password logon. NOTE: Camera functions vary depending on the camera hardware and software installed on your product.

Special keys

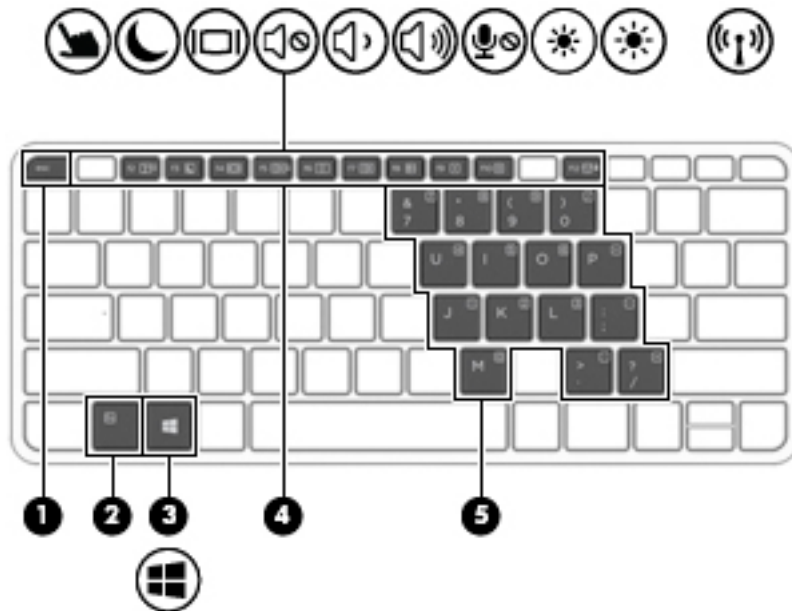



Table 2-7 Special keys and their descriptions

Component	Description
(1) <code>esc</code> key	Displays system information when pressed in combination with the <code>fn</code> key.
(2) <code>fn</code> key	Executes frequently used system functions when pressed in combination with another key. Such key combinations are called <i>hot keys</i> .
(3)  Windows key	Opens the Start menu. NOTE: Pressing the Windows key again will close the Start menu.
(4) Action keys	Execute frequently used system functions.
(5) Embedded numeric keypad	A numeric keypad superimposed over the keyboard alphabet keys. When <code>fn+num lk</code> is pressed, the keypad can be used like an external numeric keypad. Each key on the keypad performs the function indicated by the icon in the upper-right corner of the key. NOTE: If the keypad function is active when the computer is turned off, that function is reinstated when the computer is turned back on.

Bottom

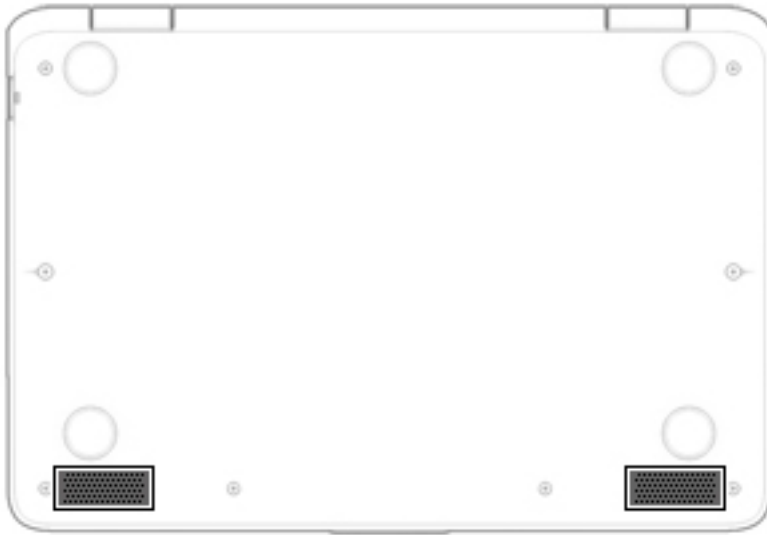



Table 2-8 Bottom components and their descriptions

Component	Description
Speakers (2)	Produce sound.

Labels

The labels affixed to the computer provide information you may need when you troubleshoot system problems or travel internationally with the computer. Labels may be in paper form or imprinted on the product.

 **IMPORTANT:** Check the following locations for the labels described in this section: the bottom of the computer, inside the battery bay, under the service door, on the back of the display, or on the bottom of a tablet kickstand.

- Service label—Provides important information to identify your computer. When contacting support, you may be asked for the serial number, the product number, or the model number. Locate this information before you contact support.

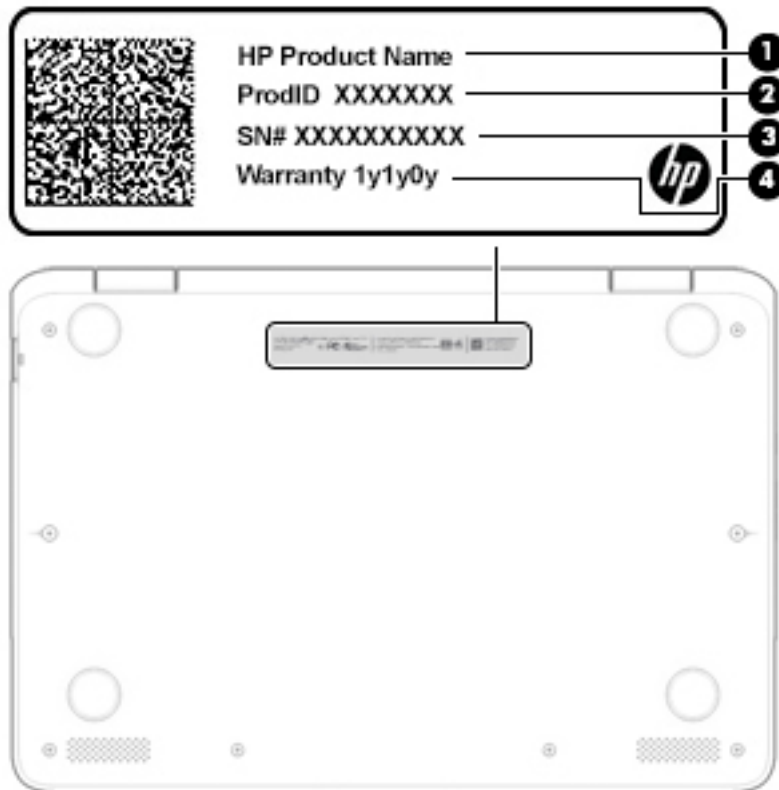

Table 2-9 Service label components

Component
(1) HP product name
(2) Product ID
(3) Serial number
(4) Warranty period

- Regulatory label(s)—Provide(s) regulatory information about the computer.
- Wireless certification label(s)—Provide(s) information about optional wireless devices and the approval markings for the countries or regions in which the devices have been approved for use.

3 Illustrated parts catalog

 **NOTE:** HP continually improves and changes product parts. For complete and current information on supported parts for the computer, go to <http://partsurfer.hp.com>, select the country or region, and then follow the on-screen instructions.

Computer major components

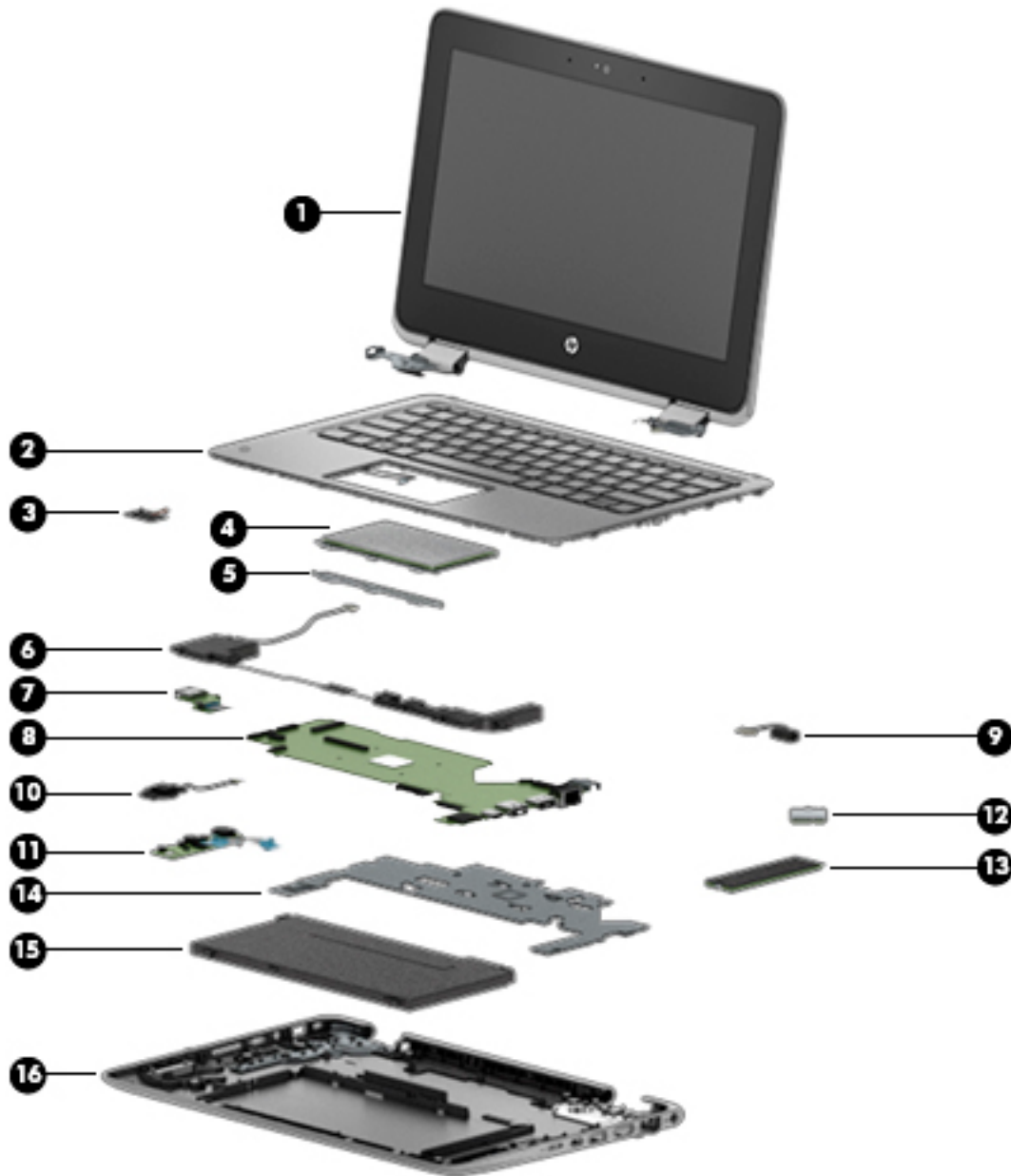

Table 3-1 Computer major components and their descriptions

Item	Component	Spare part number
(1)	Display assembly for use in blue models: NOTE: The touch display is spared only as an entire assembly.	
	SVA	L58574-001
	UWVA	L58576-001
	Display assembly for use in grey models:	
	SVA	L58573-001
	UWVA	L58575-001
(2)	Keyboard/top cover (includes keyboard cable, top cover shielding, and magnets): NOTE: For a detailed list of keyboard country codes, see Keyboard/top cover on page 24 .	
	Models without a second webcam	L59053-xx1
	Models with a second webcam	L58584-xx1
(3)	Second webcam (includes bracket)	L43799-001
(4)	Touchpad (does not include cable or bracket)	L43778-001
(5)	Touchpad bracket (included in the Bracket Kit)	L58579-001
(6)	Speakers (left and right; includes cables)	L43779-001
(7)	USB board (includes cable)	L58583-001
(8)	System board (includes processor, graphics subsystem with UMA memory, and replacement thermal material): All system boards use the following part numbers: xxxxxx-001: Non-Windows operating system xxxxxx-601: Windows 10 operating system	
	Equipped with an Intel i5-8200Y processor and 8 GB of system memory	L58567-xx1
	Equipped with an Intel m3-8100Y processor and 8 GB of system memory	L58569-xx1
	Equipped with an Intel m3-8100Y processor and 4 GB of system memory	L58568-xx1
(9)	Power connector (DC-in) cable	L58572-001 (Cable Kit)
(10)	Webcam transfer board (includes cable)	L58581-001
(11)	Audio board (includes rubber and cable)	L58571-001
(12)	WLAN module	
	Intel Wireless-AC 9260 802.11ac 2 × 2 Wi-Fi + Bluetooth 5.0	L16647-002
	Realtek RTL8822BE 802.11ac 2 × 2 Wi-Fi + Bluetooth 4.2 Combo Adapter	L51005-002
(13)	Solid-state drive:	
	256 GB, M.2, PCIe solid-state drive	L58578-001
	128 GB, M.2, SATA-3 solid-state drive	L58577-001
(14)	Heat sink (includes replacement thermal material)	L58570-001
(15)	Battery	L12791-855

Table 3-1 Computer major components and their descriptions (continued)

Item	Component	Spare part number
(16)	Bottom cover	
	Grey	L43780-001
	Blue	L43781-001
	RTC battery (includes cable; not illustrated)	L43797-001

Miscellaneous parts

Table 3-2 Miscellaneous parts and their descriptions

Component	Spare part number
AC adapter:	
65 W HP Smart AC adapter (non-PFC, EM, 4.5-mm)	913691-850
45 W HP Smart AC adapter (non-PFC, RC, 4.5-mm, for use in Argentina)	741553-852
45 W USB Type-C adapter (nPFC, 3 pin)	934739-850
45 W HP Smart AC adapter (non-PFC, RC, 4.5-mm)	741727-001
Screw Kit	L43782-001
AES active pen	L43795-001
Pen holder	L43796-001
External optical drive	747080-001
HP HDMI-to-VGA adapter	701943-001
HSP USB laser mouse	674318-001
HP Comfort grip laser mouse	691922-001
HP Slim Ultrabook backpack	747079-001
HP Slim Ultrabook top load case	747078-001
Essential top load case	679921-001
Essential backpack	679923-001
Power cord (1.0 m, conventional):	
For use in Argentina	L19357-001
For use in Australia	L19358-001
For use in Europe	L19361-001
For use in India	L19363-001
For use in Israel	L19362-001
For use in Italy	L19364-001
For use in North America	L19367-001
For use in the People's Republic of China	L19368-001

Table 3-2 Miscellaneous parts and their descriptions (continued)

Component	Spare part number
For use in South America	L19369-001
For use in South Korea	L19366-001
For use in Switzerland	L19370-001
For use in Thailand	L19371-001
For use in Taiwan	L19372-001
For use in the United Kingdom	L19373-001
Power cord (1.0 m, duckhead):	
For use in North America	L30410-001

Bracket Kit

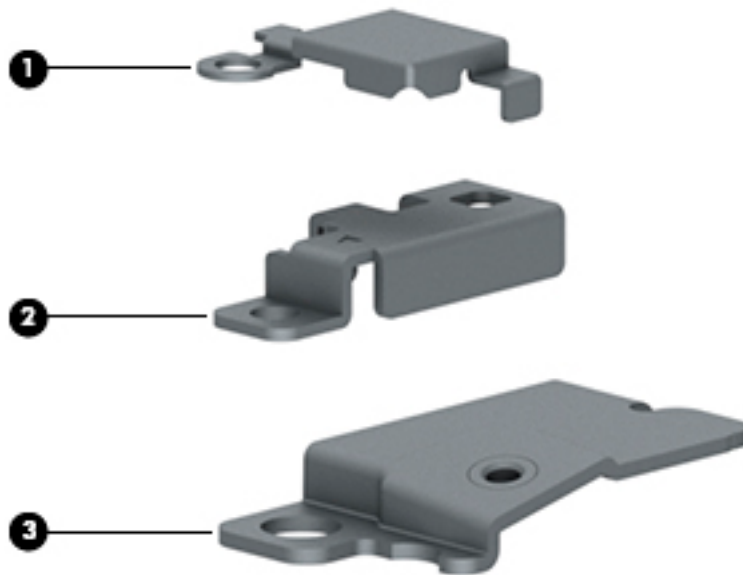
**Table 3-3 Bracket Kit components and their descriptions**

Item	Component	Spare part number
	Bracket Kit , includes the following parts:	L58579-001
(1)	USB Type-C bracket	
(2)	Power connector (DC-in) bracket	
(3)	Touchpad bracket	

Cable Kit



Table 3-4 Cable Kit components and their descriptions

Item	Component	Spare part number
	Cable Kit , includes the following parts:	L58572-001
(1)	Touchpad cable	
(2)	Audio board cable	
(3)	Power connector (DC-in) cable	
(4)	Webcam transfer board	
(5)	Display cable	

4 Removal and replacement procedures preliminary requirements

Tools required

You will need the following tools to complete the removal and replacement procedures:

- Torx T8 screwdriver
- Phillips P0 screwdriver
- Phillips P1 screwdriver

Service considerations

The following sections include some of the considerations that you must keep in mind during disassembly and assembly procedures.

 **NOTE:** As you remove each subassembly from the computer, place the subassembly (and all accompanying screws) away from the work area to prevent damage.

Plastic parts

 **IMPORTANT:** Using excessive force during disassembly and reassembly can damage plastic parts.

Cables and connectors

 **IMPORTANT:** When servicing the computer, be sure that cables are placed in their proper locations during the reassembly process. Improper cable placement can damage the computer.

Cables must be handled with extreme care to avoid damage. Apply only the tension required to unseat or seat the cables during removal and insertion. Handle cables by the connector whenever possible. In all cases, avoid bending, twisting, or tearing cables. Be sure that cables are routed in such a way that they cannot be caught or snagged by parts being removed or replaced. Handle flex cables with extreme care; these cables tear easily.

Drive handling



IMPORTANT: Drives are fragile components that must be handled with care. To prevent damage to the computer, damage to a drive, or loss of information, observe these precautions:

Before removing or inserting a hard drive, shut down the computer. If you are unsure whether the computer is off or in Hibernation, turn the computer on, and then shut it down through the operating system.

Before handling a drive, be sure that you are discharged of static electricity. While handling a drive, avoid touching the connector.

Before removing an optical drive, be sure that a disc is not in the drive and be sure that the optical drive tray is closed.

Handle drives on surfaces covered with at least one inch of shock-proof foam.

Avoid dropping drives from any height onto any surface.

After removing a hard drive or an optical drive, place it in a static-proof bag.

Avoid exposing an internal hard drive to products that have magnetic fields, such as monitors or speakers.

Avoid exposing a drive to temperature extremes or liquids.

If a drive must be mailed, place the drive in a bubble pack mailer or other suitable form of protective packaging and label the package “FRAGILE.”

Workstation guidelines

Follow these grounding workstation guidelines:

- Cover the workstation with approved static-shielding material.
- Use a wrist strap connected to a properly grounded work surface and use properly grounded tools and equipment.
- Use conductive field service tools, such as cutters, screw drivers, and vacuums.
- When fixtures must directly contact dissipative surfaces, use fixtures made only of static-safe materials.
- Keep the work area free of nonconductive materials, such as ordinary plastic assembly aids and Styrofoam.
- Handle ESD-sensitive components, parts, and assemblies by the case or PCM laminate. Handle these items only at static-free workstations.
- Avoid contact with pins, leads, or circuitry.
- Turn off power and input signals before inserting or removing connectors or test equipment.

Electrostatic discharge information

A sudden discharge of static electricity from your finger or other conductor can destroy static-sensitive devices or microcircuitry. Often the spark is neither felt nor heard, but damage occurs. An electronic device exposed to electrostatic discharge (ESD) may not appear to be affected at all and can work perfectly throughout a normal cycle. The device may function normally for a while, but it has been degraded in the internal layers, reducing its life expectancy.

Networks built into many integrated circuits provide some protection, but in many cases, the discharge contains enough power to alter device parameters or melt silicon junctions.



IMPORTANT: To prevent damage to the device when you are removing or installing internal components, observe these precautions:

Keep components in their electrostatic-safe containers until you are ready to install them.

Before touching an electronic component, discharge static electricity by using the guidelines described in this section.

Avoid touching pins, leads, and circuitry. Handle electronic components as little as possible.

If you remove a component, place it in an electrostatic-safe container.

Generating static electricity

Note the following:

- Different activities generate different amounts of static electricity.
- Static electricity increases as humidity decreases.

Table 4-1 Static electricity occurrence based on activity and humidity

Event	Relative humidity		
	55%	40%	10%
Walking across carpet	7,500 V	15,000 V	35,000 V
Walking across vinyl floor	3,000 V	5,000 V	12,000 V
Motions of bench worker	400 V	800 V	6,000 V
Removing DIPs from plastic tube	400 V	700 V	2,000 V
Removing DIPs from vinyl tray	2,000 V	4,000 V	11,500 V
Removing DIPs from Styrofoam	3,500 V	5,000 V	14,500 V
Removing bubble pack from PCB	7,000 V	20,000 V	26,500 V
Packing PCBs in foam-lined box	5,000 V	11,000 V	21,000 V

Electronic components are multi-packaged inside plastic tubes, trays, or Styrofoam.



NOTE: As little as 700 volts can degrade a product.

Preventing electrostatic damage to equipment

Many electronic components are sensitive to ESD. Circuitry design and structure determine the degree of sensitivity. The following packaging and grounding precautions are necessary to prevent static electricity damage to electronic components.

- To avoid hand contact, transport products in static-safe containers such as tubes, bags, or boxes.
- Protect all electrostatic parts and assemblies with conductive or approved containers or packaging.
- Keep electrostatic-sensitive parts in their containers until they arrive at static-free stations.
- Place items on a grounded surface before removing them from their container.
- Always be properly grounded when touching a sensitive component or assembly.

- Avoid contact with pins, leads, or circuitry.
- Place reusable electrostatic-sensitive parts from assemblies in protective packaging or conductive foam.

Personal grounding methods and equipment

Use the following equipment to prevent static electricity damage to electronic components:

- **Wrist straps** are flexible straps with a maximum of one-megohm \pm 10% resistance in the ground cords. To provide proper ground, a strap must be worn snug against bare skin. The ground cord must be connected and fit snugly into the banana plug connector on the grounding mat or workstation.
- **Heel straps/Toe straps/Boot straps** can be used at standing workstations and are compatible with most types of shoes or boots. On conductive floors or dissipative floor mats, use them on both feet with a maximum of one-megohm \pm 10% resistance between the operator and ground.

Table 4-2 Static shielding protection levels

Static shielding protection levels	
Method	Voltage
Antistatic plastic	1,500
Carbon-loaded plastic	7,500
Metallized laminate	15,000

Grounding the work area

To prevent static damage at the work area, use the following precautions:

- Cover the work surface with approved static-dissipative material. Provide a wrist strap connected to the work surface and properly grounded tools and equipment.
- Use static-dissipative mats, foot straps, or air ionizers to give added protection.
- Handle electrostatic sensitive components, parts, and assemblies by the case or PCB laminate. Handle them only at static-free work areas.
- Turn off power and input signals before inserting and removing connectors or test equipment.
- Use fixtures made of static-safe materials when fixtures must directly contact dissipative surfaces.
- Keep work area free of nonconductive materials such as ordinary plastic assembly aids and Styrofoam.
- Use field service tools, such as cutters, screwdrivers, and vacuums, that are conductive.

Recommended materials and equipment

Materials and equipment that are recommended for use in preventing static electricity include:

- Antistatic tape
- Antistatic smocks, aprons, or sleeve protectors
- Conductive bins and other assembly or soldering aids
- Conductive foam
- Conductive tabletop workstations with ground cord of one-megohm \pm 10% resistance
- Static-dissipative table or floor mats with hard tie to ground

- Field service kits
- Static awareness labels
- Wrist straps and footwear straps providing one-megohm +/- 10% resistance
- Material handling packages
- Conductive plastic bags
- Conductive plastic tubes
- Conductive tote boxes
- Opaque shielding bags
- Transparent metallized shielding bags
- Transparent shielding tubes

Packaging and transporting guidelines

Follow these grounding guidelines when packaging and transporting equipment:

- To avoid hand contact, transport products in static-safe tubes, bags, or boxes.
- Protect ESD-sensitive parts and assemblies with conductive or approved containers or packaging.
- Keep ESD-sensitive parts in their containers until the parts arrive at static-free workstations.
- Place items on a grounded surface before removing items from their containers.
- Always be properly grounded when touching a component or assembly.
- Store reusable ESD-sensitive parts from assemblies in protective packaging or nonconductive foam.
- Use transporters and conveyors made of antistatic belts and roller bushings. Be sure that mechanized equipment used for moving materials is wired to ground and that proper materials are selected to avoid static charging. When grounding is not possible, use an ionizer to dissipate electric charges.

5 Removal and replacement procedures for Authorized Service Provider parts

 **CAUTION:** Components described in this chapter should only be accessed by an authorized service provider. Accessing these parts can damage the computer or void the warranty.

Component replacement procedures

 **NOTE:** Details about the computer, including model, serial number, product key, and length of warranty, are on the service tag on the bottom of the computer. See [Labels on page 13](#) for details.

This chapter provides removal and replacement procedures.

There are as many as 68 screws that must be removed, replaced, and/or loosened when servicing the computer. Make special note of each screw size and location during removal and replacement.

Preparation for disassembly

See [Removal and replacement procedures preliminary requirements on page 19](#) for initial safety procedures.

1. Turn off the computer. If you are unsure whether the computer is off or in Hibernation, turn the computer on, and then shut it down through the operating system.
2. Disconnect the power from the computer by unplugging the power cord from the computer.
3. Disconnect all external devices from the computer

Keyboard/top cover

In this section, the first table provides the main spare part number for the keyboards. The second table provides the country codes.

Table 5-1 Keyboard descriptions and part numbers

Description	Spare part number
Keyboard/top cover, models without a second webcam	L59053-xx1
Keyboard/top cover, models with a second webcam	L58584-xx1

Table 5-2 Keyboard country codes

For use in country or region	Spare part number	For use in country or region	Spare part number	For use in country or region	Spare part number
Belgium	-A41	Iceland	-DD1	Slovenia	-BA1
Bulgaria	-261	India	-D61	South Korea	-AD1
Chile	-161	Israel	-BB1	Spain	-071
Czech Republic/Slovakia	-FL1	Italy	-061	Switzerland	-BG1

Table 5-2 Keyboard country codes (continued)

For use in country or region	Spare part number	For use in country or region	Spare part number	For use in country or region	Spare part number
Europe	-B31	The Netherlands	-DH1	Taiwan	-AB1
French Canada	-DB1	Northern Africa	-FP1	Thailand	-281
France	-051	Portugal	-131	Turkey	-141
Germany	-041	Romania	-271	United Kingdom	-031
Greece	-151	Russia	-251	United States	-001
Hungary	-211	Saudi Arabia	-171		

Before disassembling the computer, follow these steps:

- ▲ Prepare the computer for disassembly ([Preparation for disassembly on page 24](#)).

 **NOTE:** When replacing the keyboard/top cover, be sure that the touchpad (see [Touchpad on page 27](#)), the second webcam, and webcam transfer board (see [Second webcam and webcam transfer board on page 29](#)) are removed from the defective keyboard/top cover and installed on the replacement keyboard/top cover.

Remove the keyboard/top cover:

1. Turn the computer upside down with the front toward you.
2. Remove the four T8 Torx M2.5 × 4.1 screws **(1)** that secure the bottom cover to the computer.
3. Loosen the two captive Phillips P1 screws **(2)** that secure the bottom cover to the computer.
4. Loosen the two captive Torx T8 screws **(3)** that secure the bottom cover to the computer.

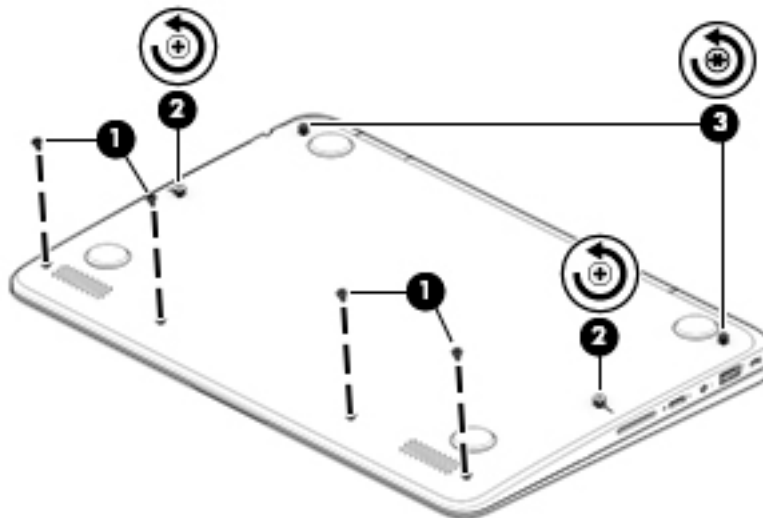

5. Open the computer.
6. Starting near the touchpad **(1)**, flex to disengage the top cover from the bottom cover.

7. Loosen the sides (2) and top (3) to completely disengage the top cover from the bottom cover.

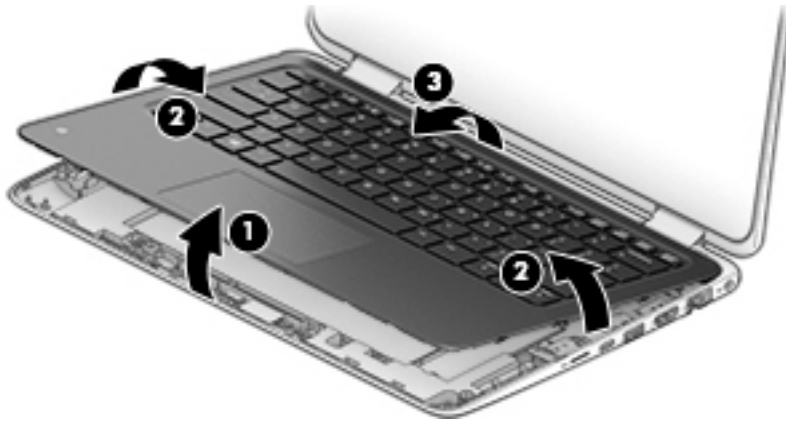

8. Lift the front edge of the keyboard/top cover up and back until the webcam module cable, touchpad cable, and keyboard cable connectors are accessible.

 **IMPORTANT:** The top cover is connected to the system board by three cables. Do not lift the top cover so much as to inadvertently disconnect the cables, as doing so could damage the cables and/or connectors.

9. Disconnect the keyboard cable from the zero insertion force (ZIF) connector on the system board (1).
10. Disconnect the touchpad cable from the ZIF connector on the system board (2).
11. Disconnect the webcam cable from the ZIF connector on the system board (3).
12. Remove the keyboard/top cover.

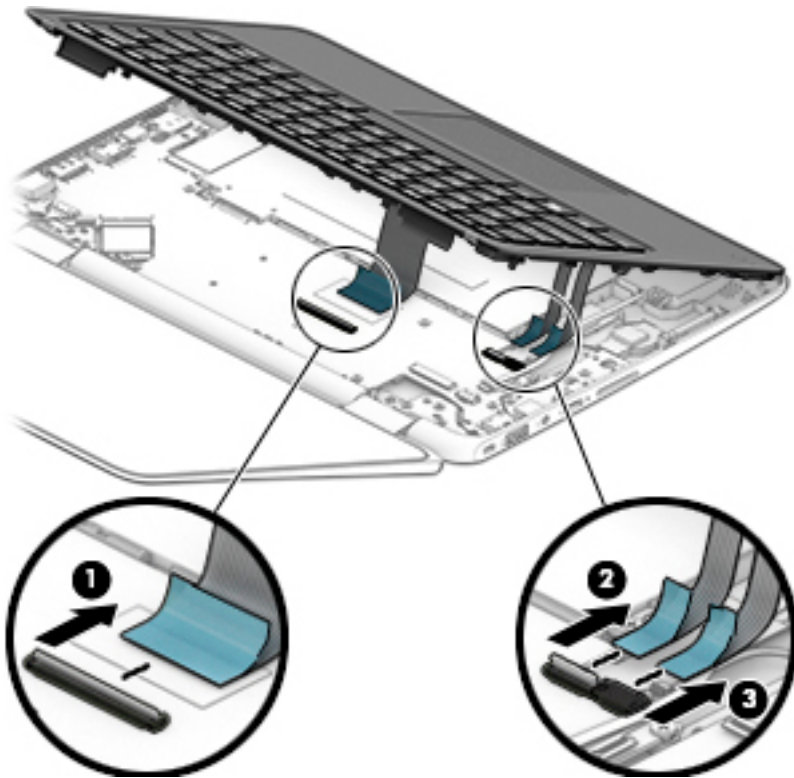

Reverse this procedure to install the keyboard/top cover.

Touchpad



NOTE: The touchpad spare part kit does not include the touchpad bracket or the touchpad cable.

Table 5-3 Touchpad, cable, and bracket descriptions and part numbers

Description	Spare part number
Touchpad (does not include cable or bracket)	L43778-001
Touchpad cable (included in Cable Kit)	L58572-001
Touchpad bracket (included in Bracket Kit)	L58579-001

Before removing the touchpad, follow these steps:

1. Prepare the computer for disassembly ([Preparation for disassembly on page 24](#)).
2. Remove the keyboard/top cover (see [Keyboard/top cover on page 24](#)).

Remove the touchpad:

1. Position the keyboard/top cover upside down with the front edge toward you.
2. Disconnect the cable from the ZIF connector on the touchpad **(1)**.
3. Lift the clear tape from the top of the touchpad **(2)**.

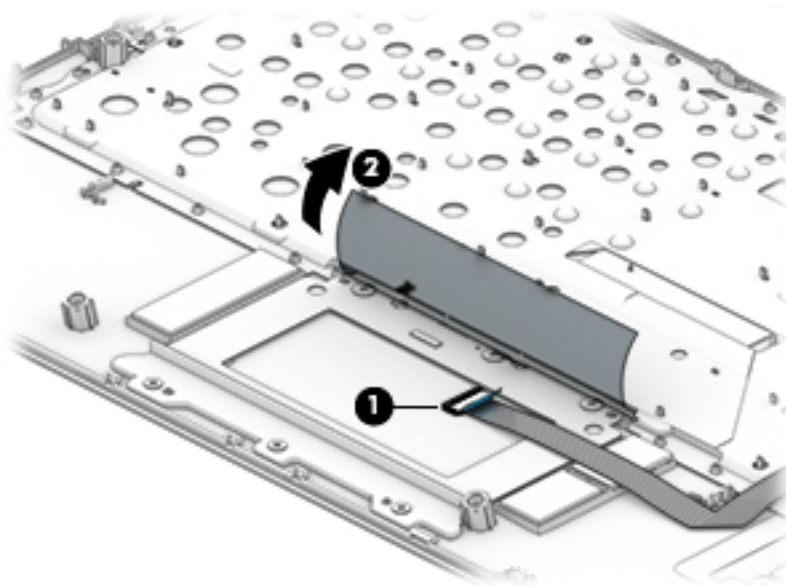

4. Remove the six Phillips M2.0 × 2.3 screws **(1)** that secure the touchpad and touchpad bracket to the keyboard/top cover.
5. Remove the touchpad bracket **(2)**.

6. Remove the touchpad (3).

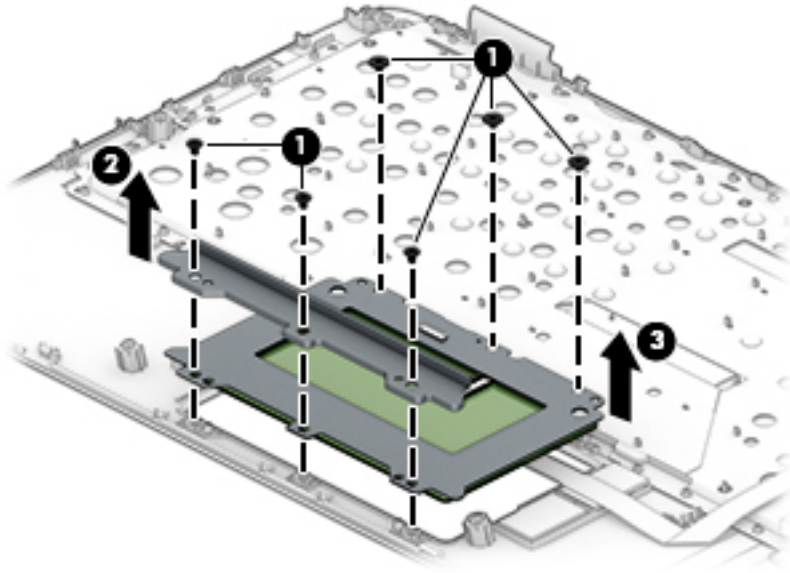

Reverse this procedure to install the touchpad.

Second webcam and webcam transfer board

Table 5-4 Second webcam, webcam transfer board, and cable descriptions and part numbers

Description	Spare part number
Second webcam (includes bracket)	L43799-001
Webcam transfer board (includes cable)	L58581-001
Webcam transfer board cable (included in Cable Kit)	L58572-001

Before removing the second webcam, follow these steps:

1. Prepare the computer for disassembly ([Preparation for disassembly on page 24](#)).
2. Remove the keyboard/top cover (see [Keyboard/top cover on page 24](#)).

Remove the second webcam:

1. Turn the keyboard/top cover upside down with the front edge toward you.
2. Remove the two Phillips M2.0 × 2.0 broad head screws **(1)** that secure the webcam bracket to the keyboard/top cover.
3. Remove the bracket **(2)**.

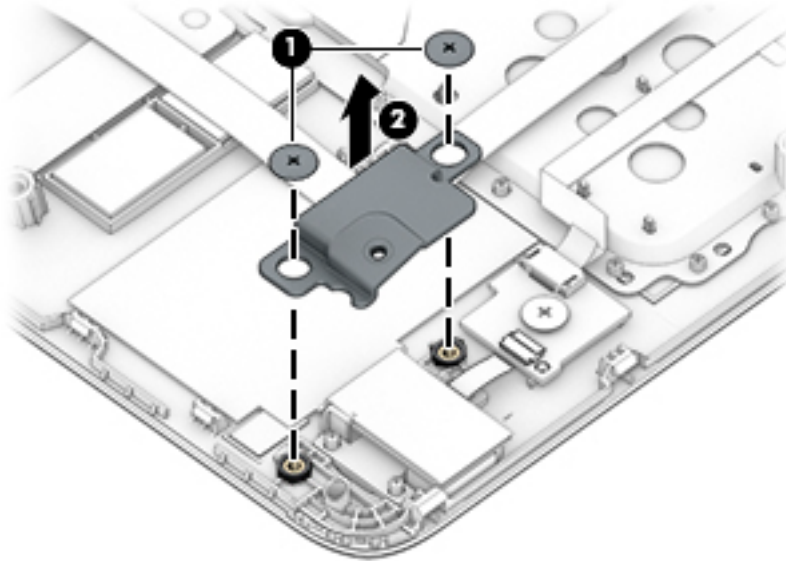

4. Disconnect the cable from the ZIF connector on the webcam transfer board **(1)**.
5. Lift the foil from on top of the webcam **(2)**.
6. Remove the Phillips M1.6 × 2.0 screw (P0 driver) **(3)** that secures the second webcam to the keyboard/top cover.

7. Remove the second webcam from the top cover (4).

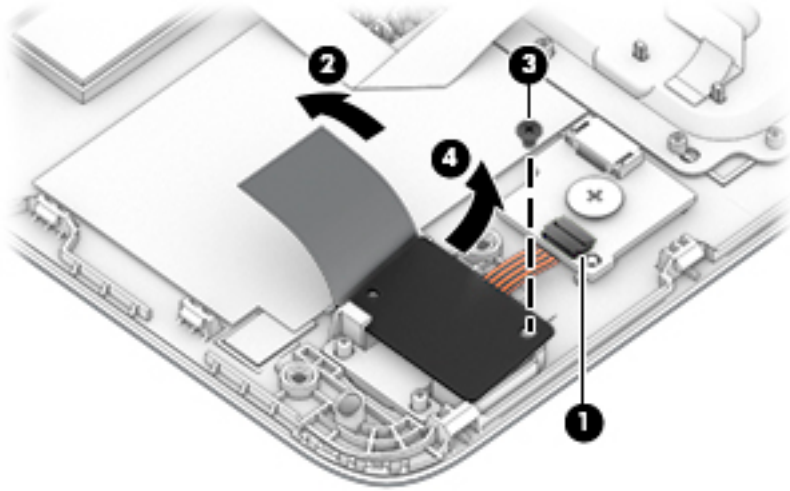

8. If it is necessary to remove the webcam transfer board, disconnect the cable from the webcam transfer board (1), remove the Phillips M2.0 × 2.0 screw (2), and then remove the board from the top cover (3).

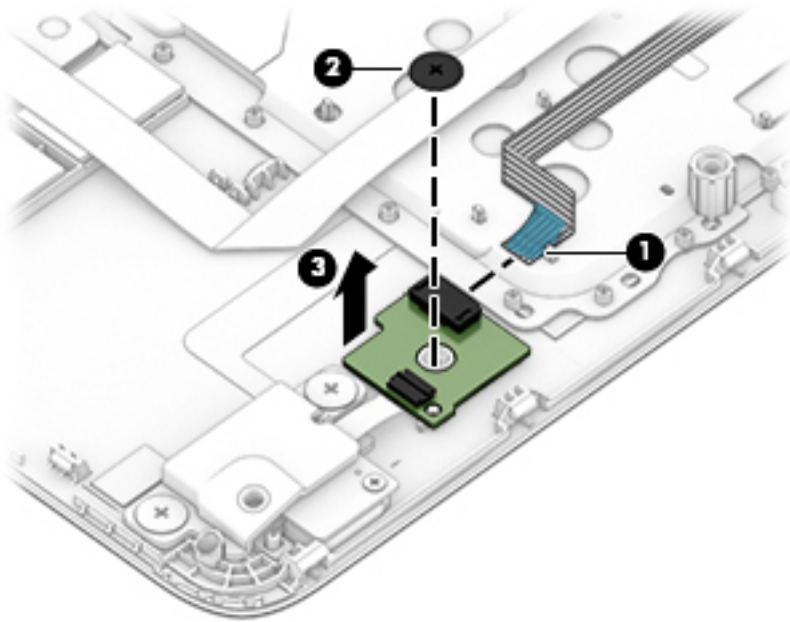

Reverse these procedures to install the second webcam and webcam transfer board.

Battery

Table 5-5 Battery description and part number

Description	Spare part number
Battery (3-cell, 48 Whr)	L12791-855

Before removing the battery, follow these steps:

1. Prepare the computer for disassembly ([Preparation for disassembly on page 24](#)).
2. Remove the keyboard/top cover (see [Keyboard/top cover on page 24](#)).

Remove the battery:

1. Remove the four Phillips M2.5 × 4.0 screws (1) that secure the battery to the bottom cover.
2. Lift the bottom of the battery, and then pull it away to disconnect it from the system board (2).

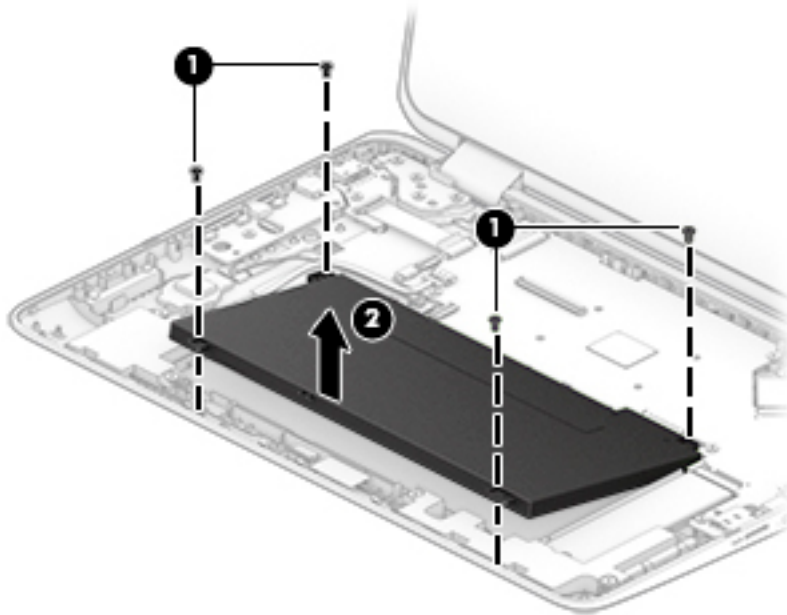

Reverse this procedure to install the battery.

Solid-state drive

Table 5-6 Solid-state drive descriptions and part numbers

Description	Spare part number
256 GB, M.2, PCIe solid-state drive	L58578-001
128 GB, M.2, SATA-3 solid-state drive	L58577-001

Before removing the solid-state drive, follow these steps:

1. Prepare the computer for disassembly ([Preparation for disassembly on page 24](#)).
2. Remove the keyboard/top cover (see [Keyboard/top cover on page 24](#)).
3. Remove the battery (see [Battery on page 31](#)).

Remove the solid-state drive:

1. Remove the Phillips M2.0 × 2.5 screw **(1)** that secures the solid-state drive to the bottom cover. (The solid-state drive tilts up.)
2. Remove the solid-state drive **(2)** by pulling the drive away from the slot at an angle.

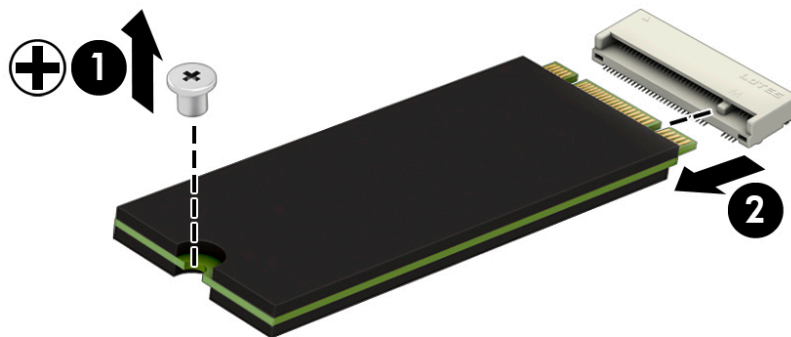

Reverse this procedure to install the solid-state drive.

WLAN module

Table 5-7 WLAN module description and part number

Description	Spare part number
Intel Wireless-AC 9260 802.11ac 2 × 2 Wi-Fi + Bluetooth 5.0	L16647-002
Realtek RTL8822BE 802.11ac 2 × 2 Wi-Fi + Bluetooth 4.2 Combo Adapter	L51005-002

 **CAUTION:** To prevent an unresponsive system, replace the wireless module only with a wireless module authorized for use in the computer by the governmental agency that regulates wireless devices in your country or region. If you replace the module and then receive a warning message, remove the module to restore device functionality, and then contact technical support.

Before removing the WLAN module, follow these steps:

1. Prepare the computer for disassembly ([Preparation for disassembly on page 24](#)).
2. Remove the keyboard/top cover (see [Keyboard/top cover on page 24](#)).
3. Remove the battery (see [Battery on page 31](#)).

Remove the WLAN module:

1. Disconnect the wireless antenna cables **(1)** from the terminals on the WLAN module.



NOTE: The wireless antenna cable labeled “1/MAIN” connects to the WLAN module “Main” terminal. The wireless antenna cable labeled “2/AUX” connects to the WLAN module “Aux” terminal.

2. Remove the Phillips M2.0 × 2.5 screw **(2)** that secures the WLAN module to the computer. (The WLAN module tilts up.)

3. Remove the WLAN module (3) by pulling the module away from the slot at an angle.

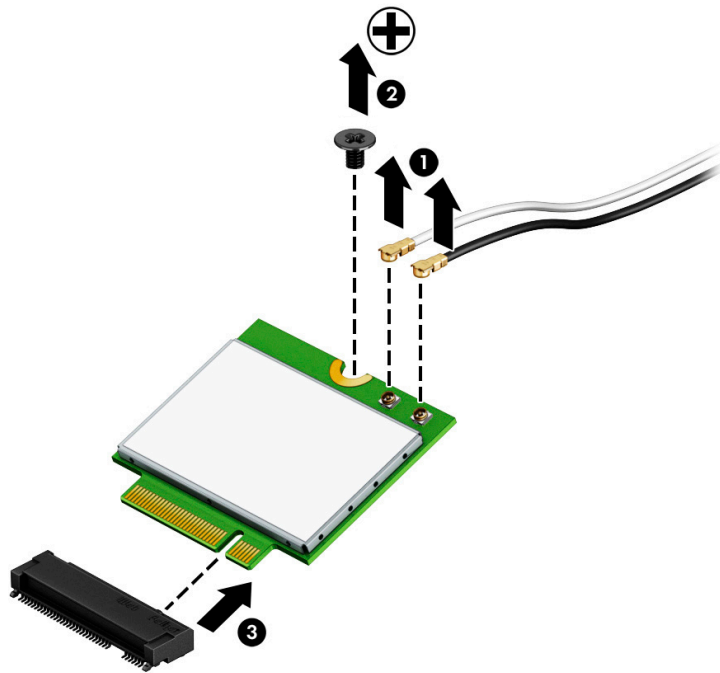

 **NOTE:** If the wireless antenna cables are not connected to the WLAN module terminal, the protective sleeves should be installed on the antenna connectors, as shown in the following illustration.



Reverse this procedure to install the WLAN module.

RTC battery

Table 5-8 RTC battery description and part number

Description	Spare part number
RTC battery (includes cable)	L43797-001

Before removing the RTC battery, follow these steps:

1. Prepare the computer for disassembly ([Preparation for disassembly on page 24](#)).
2. Remove the keyboard/top cover (see [Keyboard/top cover on page 24](#)).
3. Remove the battery (see [Battery on page 31](#)).

Remove the RTC battery:

1. Disconnect the RTC battery cable **(1)** from the system board.
2. Detach the RTC battery **(2)** from the bottom cover and remove it. (The RTC battery is secured to the bottom cover with double-sided adhesive.)

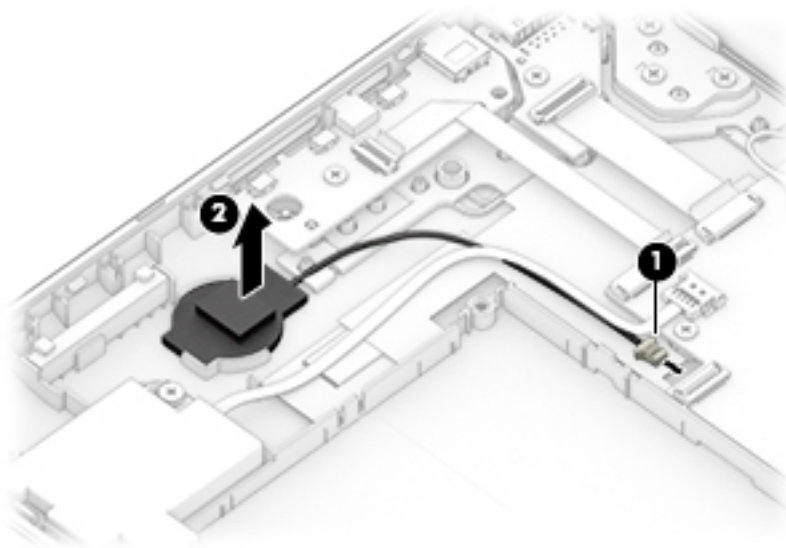

Reverse this procedure to install the RTC battery.

Speakers

Table 5-9 Speaker description and part number

Description	Spare part number
Speakers (left and right; includes cables)	L43779-001

Before removing the speakers, follow these steps:

1. Prepare the computer for disassembly ([Preparation for disassembly on page 24](#)).
2. Remove the keyboard/top cover (see [Keyboard/top cover on page 24](#)).
3. Remove the battery (see [Battery on page 31](#)).

Remove the speakers:

1. Disconnect the speaker cable **(1)** from the system board.
2. Remove the four Phillips M2.0 × 5.0 shoulder screws **(2)** that secure the speakers to the bottom cover.
3. Lift the left speaker **(3)**.
4. Release the speaker cable from the routing channel **(4)** and retention clips built into the bottom cover.
5. Remove the right speaker **(5)**.

 **NOTE:** When removing the speakers, make note of the location of the four rubber isolators around the screws **(2)**. Failure to properly install or damage to these isolators can result in degraded speaker performance.

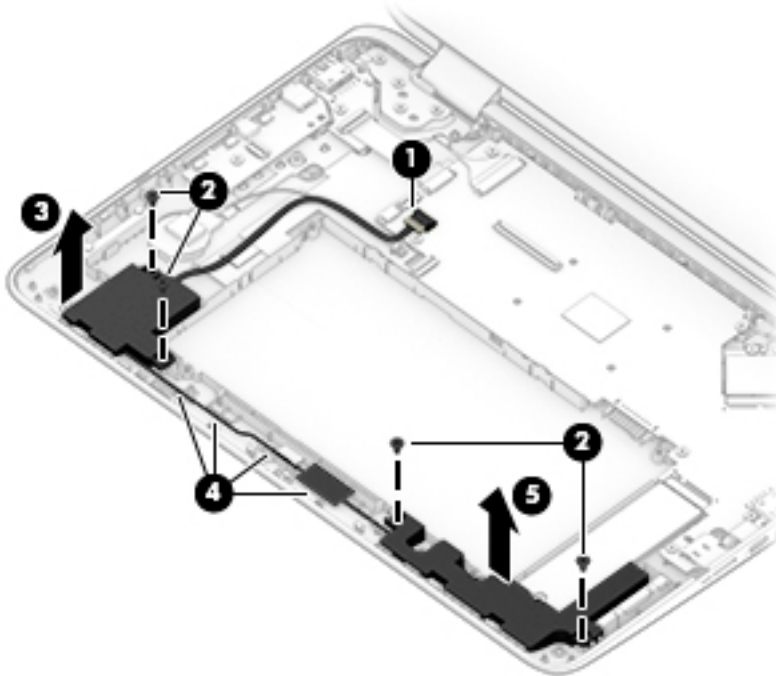

Reverse this procedure to install the speakers.

USB board

Table 5-10 USB board description and part number

Description	Spare part number
USB board (includes cable)	L58583-001

Before removing the USB board, follow these steps:

1. Prepare the computer for disassembly ([Preparation for disassembly on page 24](#)).
2. Remove the keyboard/top cover (see [Keyboard/top cover on page 24](#)).
3. Remove the battery (see [Battery on page 31](#)).

Remove the USB board:

1. Disconnect the cable from the ZIF connector on the USB board **(1)**.
2. Remove the Phillips M2.5 × 4.0 screw **(2)** that secures the board to the computer.
3. Remove the USB board from the computer **(3)**.

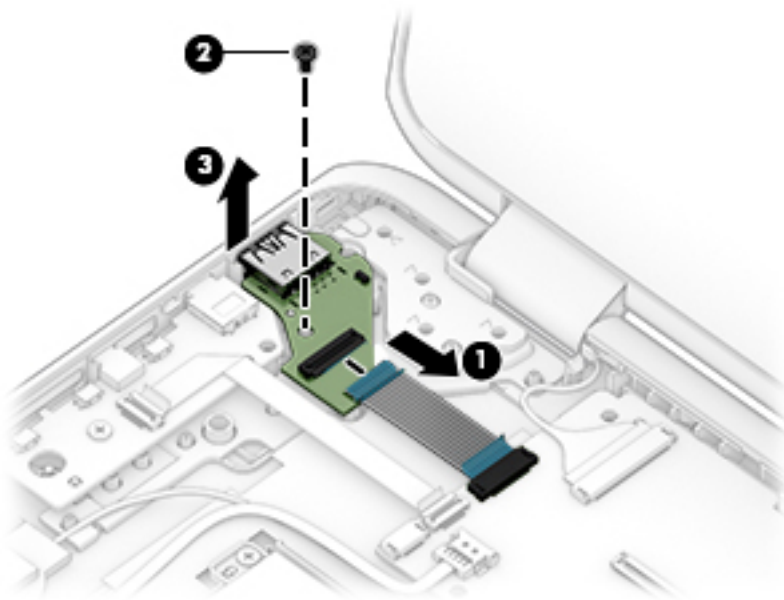

Reverse this procedure to install the USB board.

Audio board

Table 5-11 Audio board description and part number

Description	Spare part number
Audio board (includes rubber and cable)	L58571-001
Audio board cable (included in Cable Kit)	L58572-001

Before removing the audio board, follow these steps:

1. Prepare the computer for disassembly ([Preparation for disassembly on page 24](#)).
2. Remove the keyboard/top cover (see [Keyboard/top cover on page 24](#)).
3. Remove the battery (see [Battery on page 31](#)).

Remove the audio board:

1. Disconnect the cable from the ZIF connector on the audio board **(1)**.
2. Remove the two Phillips M2.5 × 4.0 screws **(2)** that secure the board to the computer.
3. Release the audio board by lifting the right side until it rests at an angle, and then pull the board away from the side and out of the computer **(3)**.

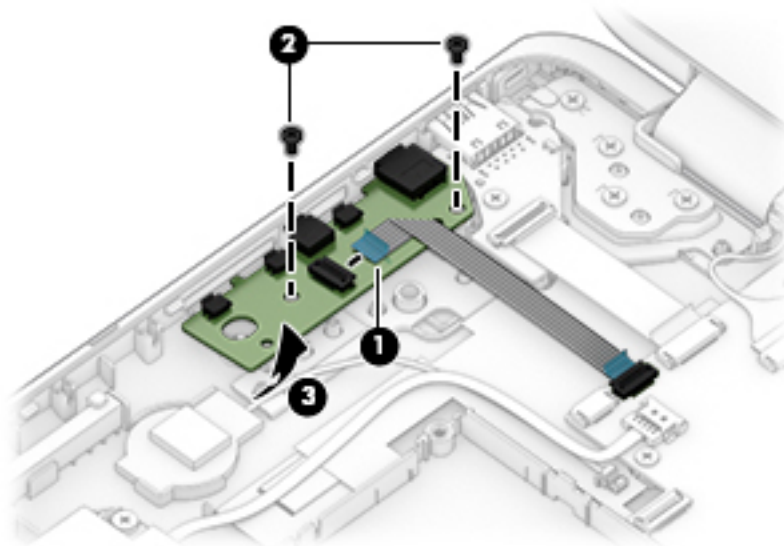

To replace the audio board:

1. Insert the board into the computer **(1)**.
2. Replace the two screws **(2)**.
3. Install the rubber light cover over the light on the board **(3)**.



NOTE: The rubber light cover must be installed to prevent light leakage.

4. Connect the cable to the board (4).

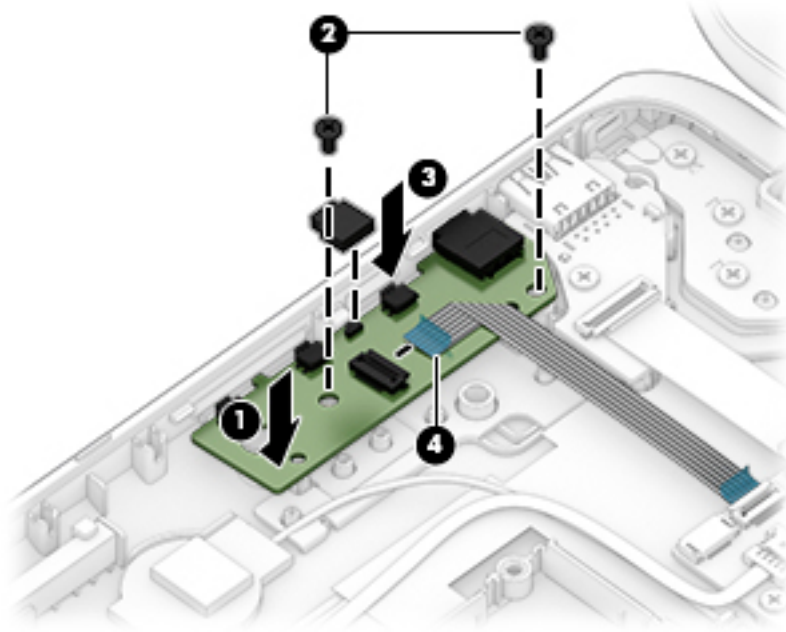

Power connector cable (DC-in)

Table 5-12 Power connector cable (DC-in) and bracket description and part number

Description	Spare part number
Power connector cable (included in Cable Kit)	L58572-001
Power connector cable bracket (included in Bracket Kit)	L58579-001

Before removing the power connector cable, follow these steps:

1. Prepare the computer for disassembly ([Preparation for disassembly on page 24](#)).
2. Remove the keyboard/top cover (see [Keyboard/top cover on page 24](#)).
3. Remove the battery (see [Battery on page 31](#)).

Remove the power connector cable:

1. Disconnect the power connector cable from the system board **(1)**.
2. Remove the Phillips M2.5 × 4.0 screw **(2)** that secures the power connector cable to the bottom cover.
3. Lift the bracket off the connector **(3)**.
4. Use the cable to pull the connector out of the computer **(4)**.

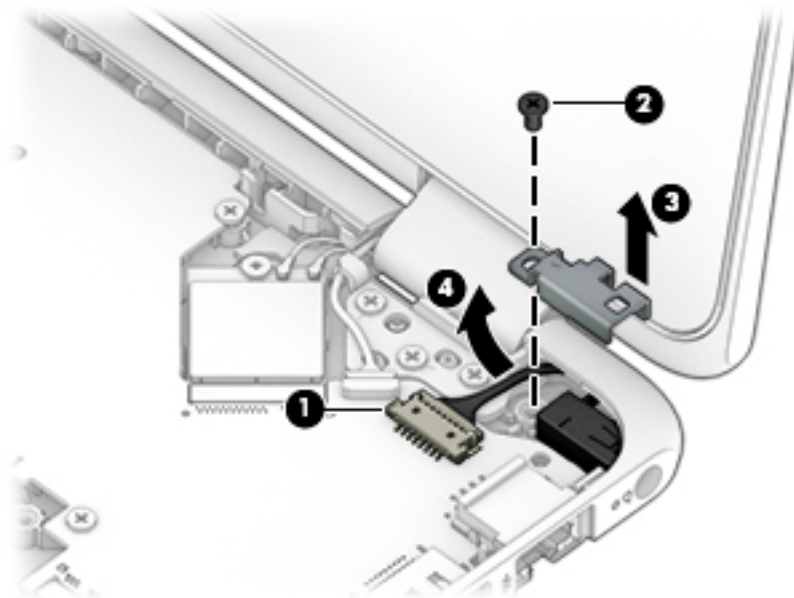

Reverse this procedure to install the power connector cable.

System board



NOTE: The system board spare part kit includes the processor, integrated system memory, a graphics subsystem with UMA memory, and replacement thermal material.

All system boards use the following part numbers:

xxxxxx-001: Non-Windows operating system

xxxxxx-601: Windows 10 operating system

Table 5-13 System board descriptions and part numbers

Description	Spare part number
System board equipped with an Intel i5-8200Y processor and 8 GB of system memory	L58567-xx1
System board equipped with an Intel m3-8100Y processor and 8 GB of system memory	L58569-xx1
System board equipped with an Intel m3-8100Y processor and 4 GB of system memory	L58568-xx1

Before removing the system board, follow these steps:

1. Prepare the computer for disassembly ([Preparation for disassembly on page 24](#)).
2. Remove the keyboard/top cover (see [Keyboard/top cover on page 24](#)), and then remove the following components:
 - a. Battery (see [Battery on page 31](#))
 - b. Solid-state drive (see [Solid-state drive on page 32](#))
 - c. WLAN module (see [WLAN module on page 33](#))



NOTE: When replacing the system board, be sure that the heat sink (see [Heat sink on page 44](#)) is removed from the defective system board and installed on the replacement system board.

Remove the system board:

1. Disconnect the following cables from the system board:
 - (1) Display panel/webcam cable (ZIF)
 - (2) USB board cable (ZIF)
 - (3) Audio board cable (ZIF)
 - (4) Speaker cable
 - (5) RTC battery cable
 - (6) Display touch cable (ZIF)
 - (7) Power connector cable

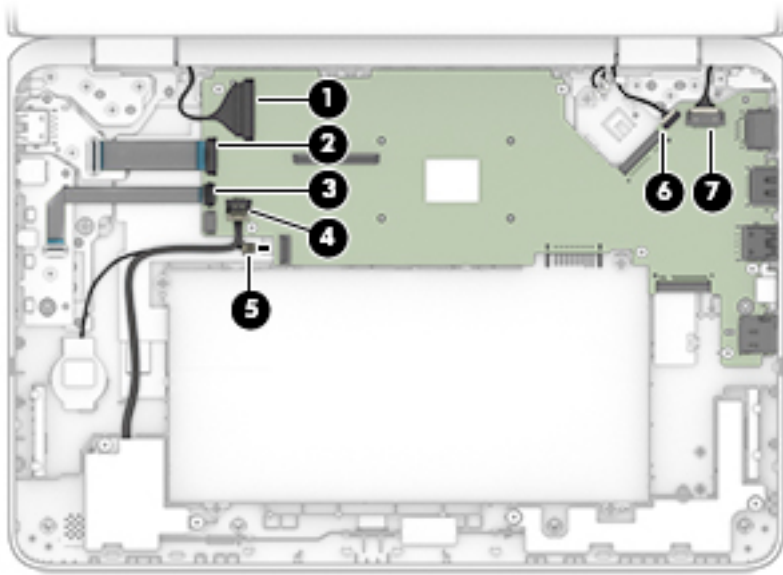

2. Remove the six Phillips M2.5 × 4.0 screws **(1)** that secure the system board to the bottom cover.
3. Remove the USB bracket from the system board **(2)**.
The USB bracket is available in the Bracket Kit using spare part number L58579-001.

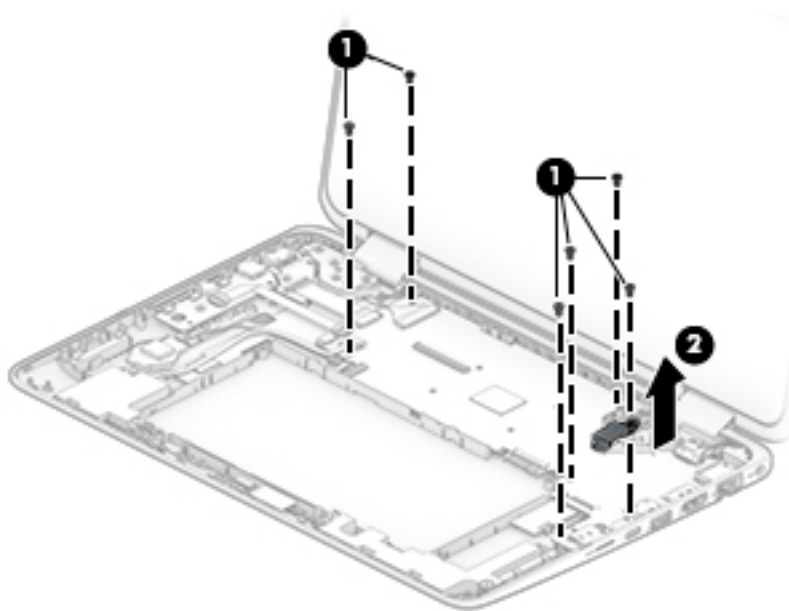

4. Lift the tape from the edge of the system board **(1)**.
5. Lift the left side of the system board **(2)** until it rests at an angle.

6. Remove the system board (3) by sliding it up and to the left at an angle.

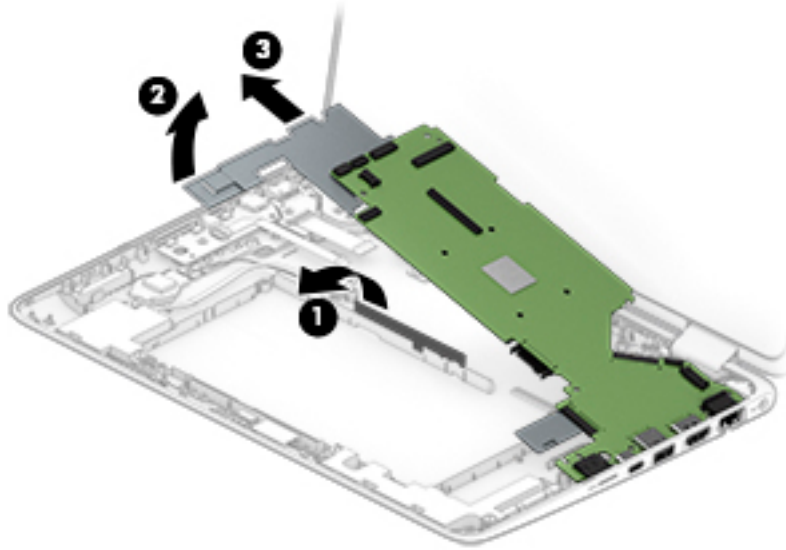

Reverse this procedure to install the system board.

Heat sink

 **NOTE:** The heat sink spare part kit includes replacement thermal material.

Table 5-14 Heat sink description and part number

Description	Spare part number
Heat sink (includes replacement thermal material)	L58570-001

Before removing the heat sink, follow these steps:

1. Prepare the computer for disassembly ([Preparation for disassembly on page 24](#)).
2. Remove the keyboard/top cover (see [Keyboard/top cover on page 24](#)), and then remove the following components:
 - a. Battery (see [Battery on page 31](#))
 - b. Solid-state drive (see [Solid-state drive on page 32](#))
 - c. WLAN module (see [WLAN module on page 33](#))
 - d. System board (see [System board on page 41](#))

Remove the heat sink:

1. Turn the system board upside down with the rear toward you.
2. Remove the four Phillips M2.0 × 3.0 screws **(1)** that secure the heat sink to the system board.
3. Remove the heat sink from the system board **(2)**.

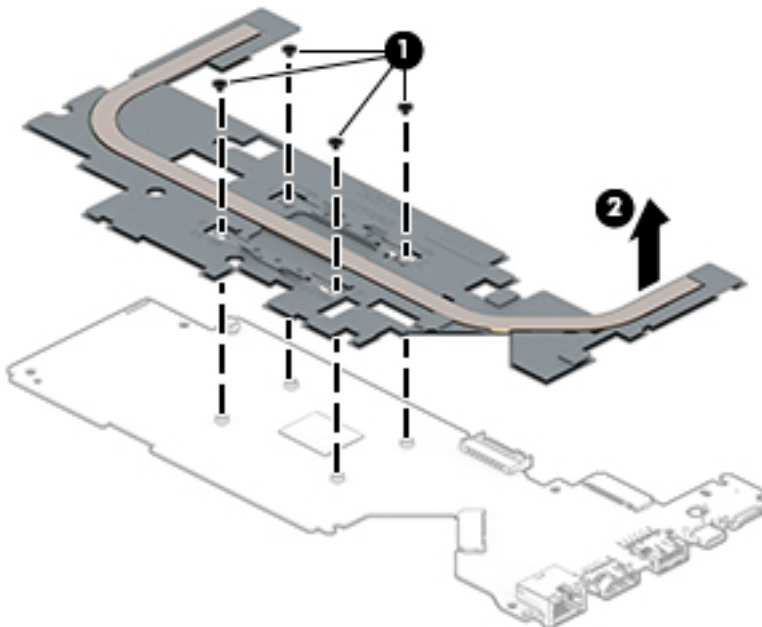

 **NOTE:** The thermal material must be thoroughly cleaned from the surfaces of the heat sink and the system board each time the heat sink is removed. Thermal paste is used on the processor **(1)** and the heat sink section **(2)** that services it.

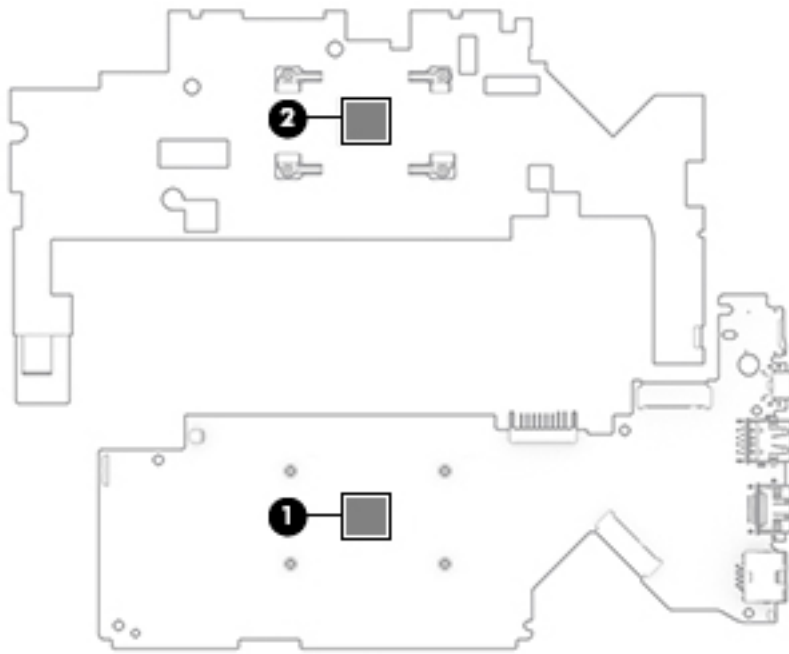

Reverse this procedure to install the heat sink.

Display assembly



 **NOTE:** The touch display is spared only as an entire assembly. The non-touch display is spared only at the subcomponent level. For non-touch display assembly spare part information, see the individual removal subsections.

Table 5-15 Display assembly descriptions and part numbers

Description	Spare part number
Touch display assembly, SVA, for use in blue models	L58574-001
Touch display assembly, UWVA, for use in blue models	L58576-001
Touch display assembly, SVA, for use in grey models	L58573-001
Touch display assembly, UWVA, for use in grey models	L58575-001

Before removing the display assembly, follow these steps:

1. Prepare the computer for disassembly ([Preparation for disassembly on page 24](#)).
2. Remove the keyboard/top cover (see [Keyboard/top cover on page 24](#)).
3. Remove the battery (see [Battery on page 31](#)).

 **TIP:** Touch display assemblies and non-touch display assemblies use the same removal procedure.

Remove the display assembly:

1. Disconnect the display cable from the ZIF connector on the system board **(1)**.
2. Release the display panel cable **(2)** from the retention clip built into the bottom cover.
3. Disconnect the wireless antenna cables **(3)** from the terminals on the WLAN module.

 **NOTE:** The wireless antenna cable labeled “1/MAIN” connects to the WLAN module “Main” terminal. The wireless antenna cable labeled “2/AUX” connects to the WLAN module “Aux” terminal.

4. Release the wireless antenna cables **(4)** from the retention clip built into the bottom cover.
5. Disconnect the display touch cable **(5)** from the system board.

6. Release the display touch cable from the retention clip **(6)** built into the bottom cover.

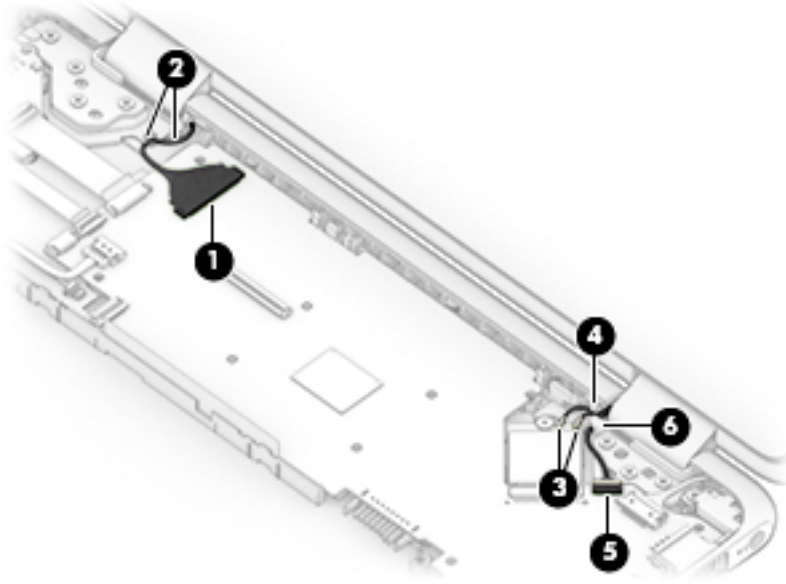

7. Remove the seven Phillips M2.5 × 5.0 screws that secure the display assembly to the bottom cover.
8. Separate the display assembly from the bottom cover **(2)**.

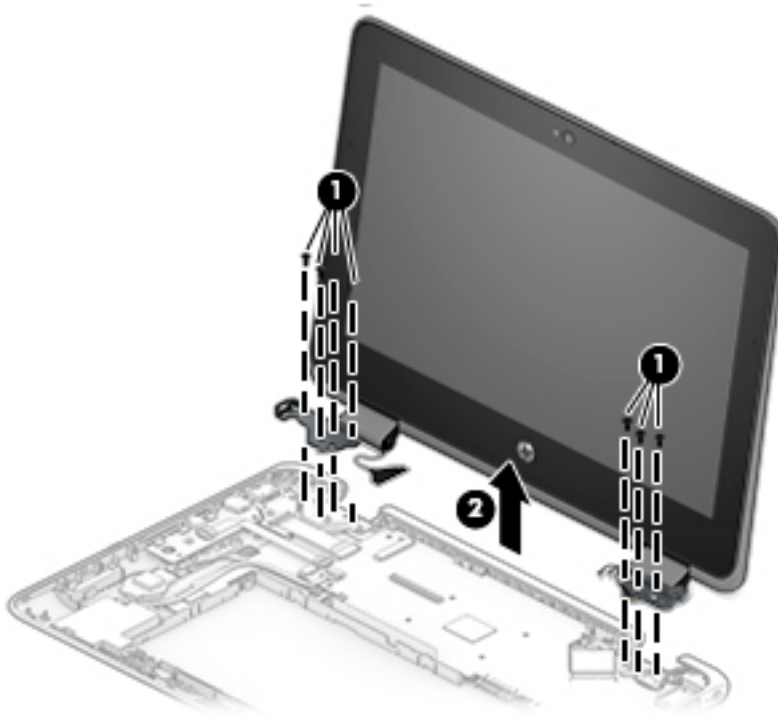

Reverse this procedure to install the display assembly.

6 Computer Setup (BIOS), TPM, and HP Sure Start

Using Computer Setup

Computer Setup, or Basic Input/Output System (BIOS), controls communication between all the input and output devices on the system (such as disk drives, display, keyboard, mouse, and printer). Computer Setup includes settings for the types of devices installed, the startup sequence of the computer, and the amount of system and extended memory.

 **NOTE:** Use extreme care when making changes in Computer Setup. Errors can prevent the computer from operating properly.

Starting Computer Setup

- ▲ Turn on or restart the computer, and when the HP logo appears, press **f10** to enter Computer Setup.

Navigating and selecting in Computer Setup

- To select a menu or a menu item, use the **tab** key and the keyboard arrow keys and then press **enter**, or use a pointing device to select the item.
- To scroll up and down, select the up arrow or the down arrow in the upper-right corner of the screen, or use the up arrow key or the down arrow key on the keyboard.
- To close open dialog boxes and return to the main Computer Setup screen, press **esc**, and then follow the on-screen instructions.

To exit Computer Setup, choose one of the following methods:

- To exit Computer Setup menus without saving your changes, select **Main**, select **Ignore Changes and Exit**, and then select **Yes**.

 **NOTE:** If you are using arrow keys to highlight your choice, you must then press **enter**.

- To save your changes and exit Computer Setup menus, select **Main**, select **Save Changes and Exit**, and then select **Yes**.

 **NOTE:** If you are using arrow keys to highlight your choice, you must then press **enter**.

Your changes go into effect when the computer restarts.

Restoring factory settings in Computer Setup

 **NOTE:** Restoring defaults will not change the hard drive mode.

To return all settings in Computer Setup to the values that were set at the factory, follow these steps:

1. Start Computer Setup. See [Starting Computer Setup on page 48](#).
2. Select **Main**, select **Apply Factory Defaults and Exit**, and then select **Yes**.

 **NOTE:** If you are using arrow keys to highlight your choice, you must then press **enter**.

 **NOTE:** On select products, the selections may display **Restore Defaults** instead of **Apply Factory Defaults and Exit**.

Your changes go into effect when the computer restarts.

 **NOTE:** Your password settings and security settings are not changed when you restore the factory settings.

Updating the BIOS

Updated versions of the BIOS may be available on the HP website.

Most BIOS updates on the HP website are packaged in compressed files called *SoftPaqs*.

Some download packages contain a file named *Readme.txt*, which contains information regarding installing and troubleshooting the file.

Determining the BIOS version

To decide whether you need to update Computer Setup (BIOS), first determine the BIOS version on your computer.

BIOS version information (also known as *ROM date* and *System BIOS*) can be accessed by pressing **fn+esc** (if you are already in Windows) or by using Computer Setup.

1. Start Computer Setup. See [Starting Computer Setup on page 48](#).
2. Select **Main**, and then select **System Information**.
3. To exit Computer Setup menus without saving your changes, select **Main**, select **Ignore Changes and Exit**, and then select **Yes**.

 **NOTE:** If you are using arrow keys to highlight your choice, you must then press **enter**.

To check for later BIOS versions, see [Downloading a BIOS update on page 49](#).

Downloading a BIOS update

 **CAUTION:** To reduce the risk of damage to the computer or an unsuccessful installation, download and install a BIOS update only when the computer is connected to reliable external power using the AC adapter. Do not download or install a BIOS update while the computer is running on battery power, docked in an optional docking device, or connected to an optional power source. During the download and installation, follow these instructions:

Do not disconnect power on the computer by unplugging the power cord from the AC outlet.

Do not shut down the computer or initiate Sleep.

Do not insert, remove, connect, or disconnect any device, cable, or cord.

1. Type `support` in the taskbar search box, and then select the HP Support Assistant app.
– or –
Select the question mark icon in the taskbar.
2. Select **Updates**, and then select **Check for updates and messages**.
3. Follow the on-screen instructions.
4. At the download area, follow these steps:

- a. Identify the most recent BIOS update and compare it to the BIOS version currently installed on your computer. Make a note of the date, name, or other identifier. You may need this information to locate the update later, after it has been downloaded to your hard drive.
- b. Follow the on-screen instructions to download your selection to the hard drive.

Make a note of the path to the location on your hard drive where the BIOS update is downloaded. You will need to access this path when you are ready to install the update.

 **NOTE:** If you connect your computer to a network, consult the network administrator before installing any software updates, especially system BIOS updates.

BIOS installation procedures vary. Follow any instructions that are displayed on the screen after the download is complete. If no instructions are displayed, follow these steps:

1. Type *file* in the taskbar search box, and then select **File Explorer**.
2. Select your hard drive designation. The hard drive designation is typically Local Disk (C:).
3. Using the hard drive path you recorded earlier, open the folder that contains the update.
4. Double-click the file that has an .exe extension (for example, *filename.exe*).

The BIOS installation begins.

5. Complete the installation by following the on-screen instructions.

 **NOTE:** After a message on the screen reports a successful installation, you can delete the downloaded file from your hard drive.

Changing the boot order using the f9 prompt

To dynamically choose a boot device for the current startup sequence, follow these steps:

1. Access the Boot Device Options menu:
 - Turn on or restart the computer, and when the HP logo appears, press **f9** to enter the Boot Device Options menu.
2. Select a boot device, press **enter**, and then follow the on-screen instructions.

TPM BIOS settings (select products only)

 **IMPORTANT:** Before enabling Trusted Platform Module (TPM) functionality on this system, you must ensure that your intended use of TPM complies with relevant local laws, regulations and policies, and approvals or licenses must be obtained if applicable. For any compliance issues arising from your operation/usage of TPM which violates the above mentioned requirement, you shall bear all the liabilities wholly and solely. HP will not be responsible for any related liabilities.

TPM provides additional security for your computer. You can modify the TPM settings in Computer Setup (BIOS).

 **NOTE:** If you change the TPM setting to Hidden, TPM is not visible in the operating system.

To access TPM settings in Computer Setup:

1. Start Computer Setup. See [Starting Computer Setup on page 48](#).
2. Select **Security**, select **TPM Embedded Security**, and then follow the on-screen instructions.

Using HP Sure Start (select products only)

Select computer models are configured with HP Sure Start, a technology that monitors the computer's BIOS for attacks or corruption. If the BIOS becomes corrupted or is attacked, HP Sure Start automatically restores the BIOS to its previously safe state, without user intervention.

HP Sure Start is configured and already enabled so that most users can use the HP Sure Start default configuration. The default configuration can be customized by advanced users.

To access the latest documentation on HP Sure Start, go to <http://www.hp.com/support>. Select **Find your product**, and then follow the on-screen instructions.

7 Backing up, restoring, and recovering

This chapter provides information about the following processes, which are standard procedure for most products:

- **Backing up your personal information**—You can use Windows tools to back up your personal information (see [Using Windows tools on page 52](#)).
- **Creating a restore point**—You can use Windows tools to create a restore point (see [Using Windows tools on page 52](#)).
- **Creating recovery media** (select products only)—You can use the HP Cloud Recovery Download Tool (select products only) to create recovery media (see [Using the HP Cloud Recovery Download Tool to create recovery media \(select products only\) on page 52](#)).
- **Restoring and recovery**—Windows offers several options for restoring from backup, refreshing the computer, and resetting the computer to its original state (see [Using Windows tools on page 52](#)).

 **IMPORTANT:** If you will be performing recovery procedures on a tablet, the tablet battery must be at least 70% charged before you start the recovery process.

IMPORTANT: For a tablet with a detachable keyboard, connect the tablet to the keyboard base before beginning any recovery process.

Backing up information and creating recovery media

Using Windows tools

 **IMPORTANT:** Windows is the only option that allows you to back up your personal information. Schedule regular backups to avoid information loss.

You can use Windows tools to back up personal information and create system restore points and recovery media.

 **NOTE:** If computer storage is 32 GB or less, Microsoft System Restore is disabled by default.

For more information and steps, see the Get Help app.

1. Select the **Start** button, and then select the **Get Help** app.
2. Enter the task you want to perform.

 **NOTE:** You must be connected to the Internet to access the Get Help app.

Using the HP Cloud Recovery Download Tool to create recovery media (select products only)

You can use the HP Cloud Recovery Download Tool to create HP Recovery media on a bootable USB flash drive.

To download the tool:

- ▲ Go to the Microsoft Store and search for HP Cloud Recovery.

For details, go to <http://www.hp.com/support>, search for HP Cloud Recovery, and then select "HP PCs – Using the Cloud Recovery Tool (Windows 10, 7)."



NOTE: If you cannot create recovery media yourself, contact support to obtain recovery discs. Go to <http://www.hp.com/support>, select your country or region, and then follow the on-screen instructions.

Restoring and recovery

Restoring, resetting, and refreshing using Windows tools

Windows offers several options for restoring, resetting, and refreshing the computer. For details, see [Using Windows tools on page 52](#).

Recovering using HP Recovery media

HP Recovery media is used to recover the original operating system and software programs that were installed at the factory. On select products, it can be created on a bootable USB flash drive using the HP Cloud Recovery Download Tool. For details, see [Using the HP Cloud Recovery Download Tool to create recovery media \(select products only\) on page 52](#).



NOTE: If you cannot create recovery media yourself, contact support to obtain recovery discs. Go to <http://www.hp.com/support>, select your country or region, and then follow the on-screen instructions.

To recover your system:

- ▲ Insert the HP Recovery media, and then restart the computer.

Changing the computer boot order

If your computer does not restart using the HP Recovery media, you can change the computer boot order. This is the order of devices listed in BIOS where the computer looks for startup information. You can change the selection to an optical drive or a USB flash drive, depending on the location of your HP Recovery media.

To change the boot order:



IMPORTANT: For a tablet with a detachable keyboard, connect the tablet to the keyboard base before beginning these steps.

1. Insert the HP Recovery media.
2. Access the system **Startup** menu.

For computers or tablets with keyboards attached:

- ▲ Turn on or restart the computer or tablet, quickly press **esc**, and then press **f9** for boot options.

For tablets without keyboards:

- ▲ Turn on or restart the tablet, quickly hold down the volume up button, and then select **f9**.

– or –

Turn on or restart the tablet, quickly hold down the volume down button, and then select **f9**.

3. Select the optical drive or USB flash drive from which you want to boot, and then follow the on-screen instructions.

8 Using HP PC Hardware Diagnostics

Using HP PC Hardware Diagnostics Windows (select products only)

HP PC Hardware Diagnostics Windows is a Windows-based utility that allows you to run diagnostic tests to determine whether the computer hardware is functioning properly. The tool runs within the Windows operating system in order to diagnose hardware failures.

If HP PC Hardware Diagnostics Windows is not installed on your computer, first you must download and install it. To download HP PC Hardware Diagnostics Windows, see [Downloading HP PC Hardware Diagnostics Windows on page 54](#).

After HP PC Hardware Diagnostics Windows is installed, follow these steps to access it from HP Help and Support or HP Support Assistant.

1. To access HP PC Hardware Diagnostics Windows from HP Help and Support:
 - a. Select the **Start** button, and then select **HP Help and Support**.
 - b. Right-click **HP PC Hardware Diagnostics Windows**, select **More**, and then select **Run as administrator**.

– or –

To access HP PC Hardware Diagnostics Windows from HP Support Assistant:

- a. Type `support` in the taskbar search box, and then select the **HP Support Assistant** app.
- or –
- a. Select the question mark icon in the taskbar.
 - b. Select **Troubleshooting and fixes**.
 - c. Select **Diagnostics**, and then select **HP PC Hardware Diagnostics Windows**.
2. When the tool opens, select the type of diagnostic test you want to run, and then follow the on-screen instructions.

 **NOTE:** If you need to stop a diagnostic test at any time, select **Cancel**.

When HP PC Hardware Diagnostics Windows detects a failure that requires hardware replacement, a 24-digit Failure ID code is generated. The screen displays one of the following options:

- A Failure ID link is displayed. Select the link and follow the on-screen instructions.
- A Quick Response (QR) code is displayed. With a mobile device, scan the code and then follow the on-screen instructions.
- Instructions for calling support are displayed. Follow those instructions.

Downloading HP PC Hardware Diagnostics Windows

- The HP PC Hardware Diagnostics Windows download instructions are provided in English only.
- You must use a Windows computer to download this tool because only .exe files are provided.

Downloading the latest HP PC Hardware Diagnostics Windows version

To download HP PC Hardware Diagnostics Windows, follow these steps:

1. Go to <http://www.hp.com/go/techcenter/pcdiags>. The HP PC Diagnostics home page is displayed.
2. Select **Download HP Diagnostics Windows**, and then select a location on your computer or a USB flash drive.

The tool is downloaded to the selected location.

Downloading HP Hardware Diagnostics Windows by product name or number (select products only)

 **NOTE:** For some products, it may be necessary to download the software to a USB flash drive by using the product name or number.

To download HP PC Hardware Diagnostics Windows by product name or number, follow these steps:

1. Go to <http://www.hp.com/support>.
2. Select **Get software and drivers**, select your type of product, and then enter the product name or number in the search box that is displayed.
3. In the **Diagnostics** section, select **Download**, and then follow the on-screen instructions to select the specific Windows diagnostics version to be downloaded to your computer or USB flash drive.

The tool is downloaded to the selected location.

Installing HP PC Hardware Diagnostics Windows

To install HP PC Hardware Diagnostics Windows, follow these steps:

- ▲ Navigate to the folder on your computer or the USB flash drive where the .exe file was downloaded, double-click the .exe file, and then follow the on-screen instructions.

Using HP PC Hardware Diagnostics UEFI

 **NOTE:** For Windows 10 S computers, you must use a Windows computer and a USB flash drive to download and create the HP UEFI support environment because only .exe files are provided. For more information, see [Downloading HP PC Hardware Diagnostics UEFI to a USB flash drive on page 56](#).

HP PC Hardware Diagnostics UEFI (Unified Extensible Firmware Interface) allows you to run diagnostic tests to determine whether the computer hardware is functioning properly. The tool runs outside the operating system so that it can isolate hardware failures from issues that are caused by the operating system or other software components.

If your PC will not boot into Windows, you can use HP PC Hardware Diagnostics UEFI to diagnose hardware issues.

When HP PC Hardware Diagnostics Windows detects a failure that requires hardware replacement, a 24-digit Failure ID code is generated. For assistance in solving the problem:

- ▲ Select **Get Support**, and then use a mobile device to scan the QR code that displays on the next screen. The HP Customer Support - Service Center page displays, with your Failure ID and product number automatically filled in. Follow the on-screen instructions.

– or –

Contact support, and provide the Failure ID code.

 **NOTE:** To start diagnostics on a convertible computer, your computer must be in notebook mode, and you must use the attached keyboard.

 **NOTE:** If you need to stop a diagnostic test, press `esc`.

Starting HP PC Hardware Diagnostics UEFI

To start HP PC Hardware Diagnostics UEFI, follow these steps:

1. Turn on or restart the computer, and quickly press `esc`.
2. Press `f2`.

The BIOS searches three places for the diagnostic tools, in the following order:

- a. Connected USB flash drive

 **NOTE:** To download the HP PC Hardware Diagnostics UEFI tool to a USB flash drive, see [Downloading the latest HP PC Hardware Diagnostics UEFI version on page 56](#).

- b. Hard drive

- c. BIOS

3. When the diagnostic tool opens, select a language, select the type of diagnostic test you want to run, and then follow the on-screen instructions.

Downloading HP PC Hardware Diagnostics UEFI to a USB flash drive

Downloading HP PC Hardware Diagnostics UEFI to a USB flash drive can be useful in the following situations:

- HP PC Hardware Diagnostics UEFI is not included in the preinstall image.
- HP PC Hardware Diagnostics UEFI is not included in the HP Tool partition.
- The hard drive is damaged.

 **NOTE:** The HP PC Hardware Diagnostics UEFI download instructions are provided in English only, and you must use a Windows computer to download and create the HP UEFI support environment because only `.exe` files are provided.

Downloading the latest HP PC Hardware Diagnostics UEFI version

To download the latest HP PC Hardware Diagnostics UEFI version to a USB flash drive:

1. Go to <http://www.hp.com/go/techcenter/pcdiags>. The HP PC Diagnostics home page is displayed.
2. Select **Download HP Diagnostics UEFI**, and then select **Run**.

Downloading HP PC Hardware Diagnostics UEFI by product name or number (select products only)

 **NOTE:** For some products, it may be necessary to download the software to a USB flash drive by using the product name or number.

To download HP PC Hardware Diagnostics UEFI by product name or number (select products only) to a USB flash drive:

1. Go to <http://www.hp.com/support>.
2. Enter the product name or number, select your computer, and then select your operating system.
3. In the **Diagnostics** section, follow the on-screen instructions to select and download the specific UEFI Diagnostics version for your computer.

Using Remote HP PC Hardware Diagnostics UEFI settings (select products only)

Remote HP PC Hardware Diagnostics UEFI is a firmware (BIOS) feature that downloads HP PC Hardware Diagnostics UEFI to your computer. It can then execute the diagnostics on your computer, and it may upload results to a preconfigured server. For more information about Remote HP PC Hardware Diagnostics UEFI, go to <http://www.hp.com/go/techcenter/pcdiags>, and then select **Find out more**.

Downloading Remote HP PC Hardware Diagnostics UEFI



NOTE: HP Remote PC Hardware Diagnostics UEFI is also available as a Softpaq that can be downloaded to a server.

Downloading the latest Remote HP PC Hardware Diagnostics UEFI version

To download the latest Remote HP PC Hardware Diagnostics UEFI version, follow these steps:

1. Go to <http://www.hp.com/go/techcenter/pcdiags>. The HP PC Diagnostics home page is displayed.
2. Select **Download Remote Diagnostics**, and then select **Run**.

Downloading Remote HP PC Hardware Diagnostics UEFI by product name or number



NOTE: For some products, it may be necessary to download the software by using the product name or number.

To download HP Remote PC Hardware Diagnostics UEFI by product name or number, follow these steps:

1. Go to <http://www.hp.com/support>.
2. Select **Get software and drivers**, select your type of product, enter the product name or number in the search box that is displayed, select your computer, and then select your operating system.
3. In the **Diagnostics** section, follow the on-screen instructions to select and download the **Remote UEFI** version for the product.

Customizing Remote HP PC Hardware Diagnostics UEFI settings

Using the Remote HP PC Hardware Diagnostics setting in Computer Setup (BIOS), you can perform the following customizations:

- Set a schedule for running diagnostics unattended. You can also start diagnostics immediately in interactive mode by selecting **Execute Remote HP PC Hardware Diagnostics**.
- Set the location for downloading the diagnostic tools. This feature provides access to the tools from the HP website or from a server that has been preconfigured for use. Your computer does not require the traditional local storage (such as a disk drive or USB flash drive) to run remote diagnostics.

- Set a location for storing the test results. You can also set the user name and password settings used for uploads.
- Display status information about the diagnostics run previously.

To customize Remote HP PC Hardware Diagnostics UEFI settings, follow these steps:

1. Turn on or restart the computer, and when the HP logo appears, press **f10** to enter Computer Setup.
2. Select **Advanced**, and then select **Settings**.
3. Make your customization selections.
4. Select **Main**, and then **Save Changes and Exit** to save your settings.

Your changes take effect when the computer restarts.

9 Specifications

Computer specifications

The power information in this section may be helpful if you plan to travel internationally with the computer.

The computer operates on DC power, which can be supplied by an AC or a DC power source. The AC power source must be rated at 100–240 V, 50–60 Hz. Although the computer can be powered from a standalone DC power source, it should be powered only with an AC adapter or a DC power source that is supplied and approved by HP for use with this computer.

The computer can operate on DC power within the following specifications. Operating voltage and current varies by platform. The voltage and current for your computer is located on the regulatory label.

Table 9-1 Computer specifications

	Metric	U.S.
Dimensions		
Depth	205.9 mm	8.1 in
Width	300.0 mm	11.8 in
Height	19.9 mm	0.78 in
Weight	1.45 kg	3.19 lbs
Input power		
Operating voltage and current	5 V dc @ 2 A / 12 V dc @ 3 A / 15 V dc @ 3 A – 45 W USB-C 19.5 V dc @ 2.31 A – 45 W 19.5 V dc @ 3.33 A – 65 W	
NOTE: This product is designed for IT power systems in Norway with phase-to-phase voltage not exceeding 240 V rms.		
Temperature		
Operating	5°C to 35°C	41°F to 95°F
Non-operating	-20°C to 60°C	-4°F to 140°F
Relative humidity (non-condensing)		
Operating	10% to 90%	
Non-operating	5% to 95%	
Maximum altitude (unpressurized)		
Operating	-15 m to 3,048 m	-50 ft to 10,000 ft
Non-operating	-15 m to 12,192 m	-50 ft to 40,000 ft
NOTE: Applicable product safety standards specify thermal limits for plastic surfaces. The device operates well within this range of temperatures.		

10 Statement of memory volatility

The purpose of this chapter is to provide general information regarding nonvolatile memory in HP Business computers. This chapter also provides general instructions for restoring nonvolatile memory that can contain personal data after the system has been powered off and the hard drive has been removed.

HP Business computer products that use Intel®-based or AMD®-based system boards contain volatile DDR memory. The amount of nonvolatile memory present in the system depends upon the system configuration. Intel-based and AMD-based system boards contain nonvolatile memory subcomponents as originally shipped from HP, assuming that no subsequent modifications have been made to the system and assuming that no applications, features, or functionality have been added to or installed on the system.

Following system shutdown and removal of all power sources from an HP Business computer system, personal data can remain on volatile system memory (DIMMs) for a finite period of time and will also remain in nonvolatile memory. Use the steps below to remove personal data from the computer, including the nonvolatile memory found in Intel-based and AMD-based system boards.

 **NOTE:** If your tablet has a keyboard base, connect to the keyboard base before beginning steps in this chapter.

Current BIOS steps

1. Follow steps (a) through (l) below to restore the nonvolatile memory that can contain personal data. Restoring or reprogramming nonvolatile memory that does not store personal data is neither necessary nor recommended.
 - a. Turn on or restart the computer, and then press **esc** while the “Press the ESC key for Startup Menu” message is displayed at the bottom of the screen.

 **NOTE:** If the system has a BIOS administrator password, enter the password at the prompt.

- b. Select **Main**, select **Apply Factory Defaults and Exit**, and then select **Yes** to load defaults.
The computer will reboot.
 - c. During the reboot, press **esc** while the “Press the ESC key for Startup Menu” message is displayed at the bottom of the screen.

 **NOTE:** If the system has a BIOS administrator password, enter the password at the prompt.

- d. Select the **Security** menu, select **Restore Security Settings to Factory Defaults**, and then select **Yes** to restore security level defaults.
The computer will reboot.
 - e. During the reboot, press **esc** while the “Press the ESC key for Startup Menu” message is displayed at the bottom of the screen.

 **NOTE:** If the system has a BIOS administrator password, enter the password at the prompt.

- f. If an asset or ownership tag is set, select the **Security** menu and scroll down to the **Utilities** menu. Select **System IDs**, and then select **Asset Tracking Number**. Clear the tag, and then make the selection to return to the prior menu.

Nonvolatile memory usage

Table 10-1 Nonvolatile memory usage

Nonvolatile Memory Type	Amount (Size)	Does this memory store customer data?	Does this memory retain data when power is removed?	What is the purpose of this memory?	How is data input into this memory?	How is this memory write-protected?
HP Sure Start flash (select models only)	8 MBytes	No	Yes	Provides protected backup of critical System BIOS code, EC firmware, and critical computer configuration data for select platforms that support HP Sure Start. For more information, see Using HP Sure Start (select models only) on page 65 .	Data cannot be written to this device via the host processor. The content is managed solely by the HP Sure Start Embedded Controller.	This memory is protected by the HP Sure Start Embedded Controller.
Real Time Clock (RTC) battery backed-up CMOS configuration memory	256 Bytes	No	Yes	Stores system date and time and noncritical data.	RTC battery backed-up CMOS is programmed using the Computer Setup (BIOS), or changing the Microsoft Windows date & time.	This memory is not write-protected.
Controller (NIC) EEPROM	64 KBytes (not customer accessible)	No	Yes	Stores NIC configuration and NIC firmware.	NIC EEPROM is programmed using a utility from the NIC vendor that can be run from DOS.	A utility is required to write data to this memory and is available from the NIC vendor. Writing data to this ROM in an inappropriate manner will render the NIC non-functional.
DIMM Serial Presence Detect (SPD) configuration data	256 Bytes per memory module, 128 Bytes programmable (not customer accessible)	No	Yes	Stores memory module information.	DIMM SPD is programmed by the memory vendor.	Data cannot be written to this memory when the module is installed in a computer. The specific write-protection method varies by memory vendor.
System BIOS	9 MBytes	Yes	Yes	Stores system BIOS code and computer configuration data.	System BIOS code is programmed at the factory. Code is updated when the system BIOS is updated. Configuration data and settings are input using the Computer Setup (BIOS) or a custom utility.	NOTE: Writing data to this ROM in an inappropriate manner can render the computer non-functional. A utility is required for writing data to this memory and is available on the HP website; go to http://www.hp.com/

Table 10-1 Nonvolatile memory usage (continued)

Nonvolatile Memory Type	Amount (Size)	Does this memory store customer data?	Does this memory retain data when power is removed?	What is the purpose of this memory?	How is data input into this memory?	How is this memory write-protected?
Intel Management Engine Firmware (present only in select Elite or Z models. For more information, go to http://www.hp.com/support . Select Find your product , and then follow the on-screen instructions.)	1.5 MBytes or 7 MBytes	Yes	Yes	Stores Management Engine Code, Settings, Provisioning Data and iAMT third-party data store.	Management Engine Code is programmed at the factory. Code is updated via Intel secure firmware update utility. Unique Provisioning Data can be entered at the factory or by an administrator using the Management Engine (MEBx) setup utility. The third party data store contents can be populated by a remote management console or local applications that have been registered by an administrator to have access to the space.	support . Select Find your product , and then follow the on-screen instructions. The Intel chipset is configured to enforce hardware protection to block all direct read/write access to this area. An Intel utility is required for updating the firmware. Only firmware updates digitally signed by Intel can be applied using this utility.
Bluetooth flash (select products only)	2 Mbit	No	Yes	Stores Bluetooth configuration and firmware.	Bluetooth flash is programmed at the factory. Tools for writing data to this memory are not publicly available but can be obtained from the silicon vendor.	A utility is required for writing data to this memory and is made available through newer versions of the driver whenever the flash requires an upgrade.
802.11 WLAN EEPROM	4 Kbit to 8 Kbit	No	Yes	Stores configuration and calibration data.	802.11 WLAN EEPROM is programmed at the factory. Tools for writing data to this memory are not made public.	A utility is required for writing data to this memory and is typically not made available to the public unless a firmware upgrade is necessary to address a unique issue.
Camera (select products only)	64 Kbit	No	Yes	Stores camera configuration and firmware.	Camera memory is programmed using a utility from the device manufacturer that can be run from Windows.	A utility is required for writing data to this memory and is typically not made available to the public unless a firmware upgrade is necessary to address a unique issue.
Fingerprint sensor (select products only)	512 KByte flash	Yes	Yes	Stores fingerprint templates.	Fingerprint sensor memory is programmed by user enrollment in HP ProtectTools Security Manager.	Only a digitally signed application can make the call to write to the flash.

Questions and answers

1. How can the BIOS settings be restored (returned to factory settings)?



IMPORTANT: Restore defaults does not securely erase any data on your hard drive. See question and answer 6 for steps to securely erase data.

Restore defaults does not reset the Custom Secure Boot keys. See question and answer 7 for information about resetting the keys.

- a. Turn on or restart the computer, and then press **esc** while the “Press the ESC key for Startup Menu” message is displayed at the bottom of the screen.
- b. Select **Main**, and then select **Apply Factory Defaults and Exit**.
- c. Follow the on-screen instructions.
- d. Select **Main**, select **Save Changes and Exit**, and then follow the on-screen instructions.

2. What is a UEFI BIOS, and how is it different from a legacy BIOS?

The Unified Extensible Firmware Interface (UEFI) BIOS is an industry-standard software interface between the platform firmware and an operating system (OS). It is a replacement for the older BIOS architecture, but supports much of the legacy BIOS functionality.

Like the legacy BIOS, the UEFI BIOS provides an interface to display the system information and configuration settings and to change the configuration of your computer before an OS is loaded. BIOS provides a secure run-time environment that supports a Graphic User Interface (GUI). In this environment, you can use either a pointing device (touch screen, touchpad, pointing stick, or USB mouse) or the keyboard to navigate and make menu and configuration selections. The UEFI BIOS also contains basic system diagnostics.

The UEFI BIOS provides functionality beyond that of the legacy BIOS. In addition, the UEFI BIOS works to initialize the computer’s hardware before loading and executing the OS; the run-time environment allows the loading and execution of software programs from storage devices to provide more functionality, such as advanced hardware diagnostics (with the ability to display more detailed system information) and advanced firmware management and recovery software.

HP has provided options in Computer Setup (BIOS) to allow you to run in legacy BIOS, if required by the operating system. Examples of this requirement would be if you upgrade or downgrade the OS.

3. Where does the UEFI BIOS reside?

The UEFI BIOS resides on a flash memory chip. A utility is required to write to the chip.

4. What kind of configuration data is stored on the DIMM Serial Presence Detect (SPD) memory module? How would this data be written?

The DIMM SPD memory contains information about the memory module, such as size, serial number, data width, speed/timing, voltage, and thermal information. This information is written by the module manufacturer and stored on an EEPROM. This EEPROM cannot be written to when the memory module is installed in a computer. Third-party tools do exist that can write to the EEPROM when the memory module is not installed in a computer. Various third-party tools are available to read SPD memory.

5. What is meant by “Restore the nonvolatile memory found in Intel-based system boards”?

This message relates to clearing the Real Time Clock (RTC) CMOS memory that contains computer configuration data.

6. How can the BIOS security be reset to factory defaults and data erased?

 **IMPORTANT:** Resetting will result in the loss of information.

These steps will not reset Custom Secure Boot Keys. See question and answer 7 for information about resetting the keys.

- a. Turn on or restart the computer, and then press **esc** while the “Press the ESC key for Startup Menu” message is displayed at the bottom of the screen.
- b. Select **Main**, and then select **Reset Security to Factory Defaults**.
- c. Follow the on-screen instructions.
- d. Select **Main**, select **Save Changes and Exit**, and then follow the on-screen instructions.

7. How can the Custom Secure Boot Keys be reset?

Secure Boot is a feature to ensure that only authenticated code can start on a platform. If you enabled Secure Boot and created Custom Secure Boot Keys, simply disabling Secure Boot will not clear the keys. You must also select to clear the Custom Secure Boot Keys. Use the same Secure Boot access procedure you used to create the Custom Secure Boot Keys, but make the selection to clear or delete all Secure Boot Keys.

- a. Turn on or restart the computer, and then press **esc** while the “Press the ESC key for Startup Menu” message is displayed at the bottom of the screen.
- b. Select the **Security** menu, select **Secure Boot Configuration**, and then follow the on-screen instructions.
- c. At the **Secure Boot Configuration** window, select **Secure Boot**, select **Clear Secure Boot Keys**, and then follow the on-screen instructions to continue.

Using HP Sure Start (select models only)

Select computer models are configured with HP Sure Start, a technology that continuously monitors your computer's BIOS for attacks or corruption. If the BIOS becomes corrupted or is attacked, HP Sure Start restores the BIOS to its previously safe state, without user intervention. Those select computer models ship with HP Sure Start configured and enabled. HP Sure Start is configured and already enabled so that most users can use the HP Sure Start default configuration. The default configuration can be customized by advanced users.

To access the latest documentation on HP Sure Start, go to <http://www.hp.com/support>. Select **Find your product**, and then follow the on-screen instructions.

11 Power cord set requirements

The wide-range input feature of the computer permits it to operate from any line voltage from 100 to 120 V ac, or from 220 to 240 V ac.

The 3-conductor power cord set included with the computer meets the requirements for use in the country or region where the equipment is purchased.

Power cord sets for use in other countries or regions must meet the requirements of the country and region where the computer is used.

Requirements for all countries

The following requirements are applicable to all countries and regions:

- The length of the power cord set must be at least **1.0 m** (3.3 ft) and no more than **2.0 m** (6.5 ft).
- All power cord sets must be approved by an acceptable accredited agency responsible for evaluation in the country or region where the power cord set will be used.
- The power cord sets must have a minimum current capacity of 10 A and a nominal voltage rating of 125 or 250 V ac, as required by the power system of each country or region.
- The appliance coupler must meet the mechanical configuration of an EN 60 320/IEC 320 Standard Sheet C13 connector for mating with the appliance inlet on the back of the computer.

Requirements for specific countries and regions

Table 11-1 Power cord requirements for specific countries and regions

Country/region	Accredited agency	Applicable note number
Argentina	IRAM	1
Australia	SAA	1
Austria	OVE	1
Belgium	CEBEC	1
Brazil	ABNT	1
Canada	CSA	2
Chile	IMQ	1
Denmark	DEMKO	1
Finland	FIMKO	1
France	UTE	1
Germany	VDE	1
India	BIS	1
Israel	SII	1
Italy	IMQ	1
Japan	JIS	3
The Netherlands	KEMA	1
New Zealand	SANZ	1
Norway	NEMKO	1
The People's Republic of China	CCC	4
Saudi Arabia	SASO	7
Singapore	PSB	1
South Africa	SABS	1
South Korea	KTL	5
Sweden	SEMKO	1
Switzerland	SEV	1
Taiwan	BSMI	6
Thailand	TISI	1
The United Kingdom	ASTA	1
The United States	UL	2

1. The flexible cord must be Type H05VV-F, 3-conductor, 0.75 mm² conductor size. Power cord set fittings (appliance coupler and wall plug) must bear the certification mark of the agency responsible for evaluation in the country or region where it will be used.

Table 11-1 Power cord requirements for specific countries and regions (continued)

Country/region	Accredited agency	Applicable note number
		2. The flexible cord must be Type SVT/SJT or equivalent, No. 18 AWG, 3-conductor. The wall plug must be a two-pole grounding type with a NEMA 5-15P (15 A, 125 V ac) or NEMA 6-15P (15 A, 250 V ac) configuration. CSA or C-UL mark. UL file number must be on each element.
		3. The appliance coupler, flexible cord, and wall plug must bear a “T” mark and registration number in accordance with the Japanese Dentori Law. The flexible cord must be Type VCTF, 3-conductor, 0.75 mm ² or 1.25 mm ² conductor size. The wall plug must be a two-pole grounding type with a Japanese Industrial Standard C8303 (7 A, 125 V ac) configuration.
		4. The flexible cord must be Type RVV, 3-conductor, 0.75 mm ² conductor size. Power cord set fittings (appliance coupler and wall plug) must bear the CCC certification mark.
		5. The flexible cord must be Type H05VV-F 3-conductor, 0.75 mm ² conductor size. KTL logo and individual approval number must be on each element. Corset approval number and logo must be printed on a flag label.
		6. The flexible cord must be Type HVCTF 3-conductor, 1.25 mm ² conductor size. Power cord set fittings (appliance coupler, cable, and wall plug) must bear the BSMI certification mark.
		7. For 127 V ac, the flexible cord must be Type SVT or SJT 3-conductor, 18 AWG, with plug NEMA 5-15P (15 A, 125 V ac), with UL and CSA or C-UL marks. For 240 V ac, the flexible cord must be Type H05VV-F 3-conductor, 0.75 mm ² or 1.00 mm ² conductor size, with plug BS 1363/A with BSI or ASTA marks.

12 Recycling

When a non-rechargeable or rechargeable battery has reached the end of its useful life, do not dispose of the battery in general household waste. Follow the local laws and regulations in your area for battery disposal.

HP encourages customers to recycle used electronic hardware, HP original print cartridges, and rechargeable batteries. For more information about recycling programs, see the HP Web site at <http://www.hp.com/recycle>.

Index

- A**
 - AC adapter, spare part numbers 16
 - audio board
 - removal 38
 - spare part number 15, 38
 - audio board cable
 - spare part number 18
 - audio-out (headphone)/audio-in (microphone) combo jack, identifying 5
- B**
 - backup, creating 52
 - backups 52
 - battery
 - removal 31
 - spare part number 15, 31
 - battery light 4
 - BIOS
 - determining version 49
 - downloading an update 49
 - updating 49
 - Bluetooth label 13
 - boot order
 - changing using the f9 prompt 50
 - boot order, changing 53
 - bottom 13
 - bottom cover, spare part numbers 16
 - Bracket Kit 17
 - buttons
 - left touchpad 8
 - power 6
 - right touchpad 8
- C**
 - Cable Kit 18
 - camera 7, 10
 - identifying 7, 10
 - camera light, identifying 7, 10
 - caps lock light, identifying 9
 - cautions
 - electrostatic discharge 20
- components**
 - bottom 12
 - display 7
 - keyboard area 8
 - left side 5
 - right side 4
- computer**
 - major components 14
 - specifications 59
- Computer Setup**
 - navigating and selecting 48
 - restoring factory settings 48
 - starting 48
- computer setup** 48
- connector, power** 5
- D**
 - display assembly
 - removal 46
 - spare part numbers 46
 - display cable
 - spare part number 18
 - display components 7
 - display panel
 - product description 1
- E**
 - electrostatic discharge (ESD) 20
 - preventing damage 21
 - embedded numeric keypad, identifying 11
 - esc key, identifying 11
- F**
 - fn key, identifying 11
- G**
 - graphics, product description 1
 - grounding methods 22
 - guidelines
 - packaging 23
 - transporting 23
 - workstation 20
- H**
 - HDMI port, identifying 4
 - heat sink
 - removal 44
 - spare part number 15, 44
 - HP PC Hardware Diagnostics UEFI
 - downloading 56
 - starting 56
 - using 55
 - HP PC Hardware Diagnostics Windows
 - downloading 54
 - installing 55
 - using 54
 - HP Recovery media
 - recovery 53
 - HP Sure Start 65
- I**
 - internal microphones, identifying 7
- J**
 - jacks
 - audio-out (headphone)/audio-in (microphone) combo 5
 - network 4
 - RJ-45 (network) 4
- K**
 - keyboard, product description 2
 - keyboard/top cover
 - removal 24
 - spare part numbers 15, 24
 - keypad
 - embedded numeric 11
 - keys
 - esc 11
 - fn 11
 - Windows 11
- L**
 - labels
 - Bluetooth 13
 - regulatory 13
 - serial number 13
 - service 13

- wireless certification 13
- WLAN 13
- left side components 5
- lights
 - AC adapter and battery 4
 - battery 4
 - camera 7, 10
 - caps lock 9
 - power 6
 - RJ-45 (network) 4
 - touchpad 9
 - wireless 9
- M**
- memory
 - nonvolatile 60
 - volatile 60
- memory card reader, identifying 4
- memory module, product description 1
- MicroSD memory card reader, identifying 4
- miscellaneous parts 16
- model name 1
- N**
- network jack, identifying 4
- nonvolatile memory 60
- O**
- operating system, product description 3
- P**
- packaging guidelines 23
- pen input, product description 2
- pen, spare part number 16
- pointing device, product description 2
- ports
 - HDMI 4
 - product description 2
 - USB SuperSpeed 4, 5
 - USB Type-C 4
- power button, identifying 6
- power connector
 - identifying 5
- power connector (DC-in) bracket
 - spare part number 17
- power connector (DC-in) cable
 - spare part number 15, 18

- power connector cable
 - removal 40
 - spare part number 40
- power cord
 - requirements for all countries 66
 - requirements for specific countries and regions 67
 - set requirements 66
- power lights 6
- power requirements, product description 2
- processor, product description 1
- product description
 - display panel 1
 - graphics 1
 - keyboard 2
 - media card reader 2
 - memory module 1
 - operating system 3
 - pen input 2
 - pointing device 2
 - ports 2
 - power requirements 2
 - processors 1
 - product name 1
 - RJ-45 (network) jack 1
 - security 3
 - sensors 2
 - serviceability 3
 - solid-state drive 1
 - video 1
 - wireless 1
- product name 1
- product name and number, computer 13
- R**
- recovery 52
 - discs 53
 - HP Recovery partition 53
 - media 53
 - USB flash drive 53
- recovery media
 - creating using HP Cloud Recovery Download Tool 52
 - creating using Windows tools 52
- regulatory information
 - regulatory label 13
 - wireless certification labels 13

- Remote HP PC Hardware Diagnostics
 - UEFI settings
 - customizing 57
 - using 57
- removal/replacement procedures 24
- removing personal data from volatile system memory 60
- restoring 52
- right side components 4
- RJ-45 (network) jack, identifying 4
- RJ-45 (network) jack, product description 1
- RJ-45 (network) lights, identifying 4
- RTC battery
 - removal 35
 - spare part number 16, 35
- S**
- Screw Kit, spare part number 16
- second webcam
 - removal 29
 - spare part number 15, 29
- security cable slot, identifying 5
- security, product description 3
- sensors
 - product description 2
- serial number, computer 13
- service labels, locating 13
- serviceability, product description 3
- setup utility
 - navigating and selecting 48
 - restoring factory settings 48
- slots
 - security cable 5
- solid-state drive
 - product description 1
 - removal 32
 - spare part numbers 15, 32
- speakers
 - identifying 12
 - removal 36
 - spare part number 15, 36
- special keys, using 11
- specifications 59
- static electricity 21
- Sure Start
 - using 51

- system board
 - removal 41
 - spare part numbers 15, 41
- system memory, removing personal data from volatile 60
- system restore point, creating 52

T

- touchpad
 - removal 27
 - spare part numbers 15, 27
- touchpad bracket
 - spare part number 15, 17
- touchpad buttons
 - identifying 8
- touchpad cable
 - spare part number 18
- touchpad light, identifying 9
- touchpad zone
 - identifying 8
- TPM settings 50
- transporting guidelines 23
- traveling with the computer 13

U

- USB board
 - removal 37
 - spare part number 37
- USB SuperSpeed port, identifying 4, 5
- USB Type-C bracket
 - spare part number 17
- USB Type-C port, identifying 4

V

- video, product description 1
- volume button
 - identifying 6

W

- webcam transfer board
 - removal 29
 - spare part number 15, 18, 29
- Windows
 - backup 52
 - recovery media 52
 - system restore point 52
- Windows key, identifying 11
- Windows tools, using 52
- wireless certification label 13
- wireless light, identifying 9
- wireless, product description 1
- WLAN antennas, identifying 7
- WLAN device 13
- WLAN label 13
- WLAN module
 - removal 33
 - spare part number 15, 33
- workstation guidelines 20