

XP-4100/XP-4105 User's Guide

Contents

XP-4100/XP-4105 User's Guide	11
Product Basics	12
Using the Control Panel	12
Control Panel Buttons and Lights	13
The LCD Screen	14
Status Icon Information	14
Navigating the LCD Screen.....	15
Entering Characters on the LCD Screen.....	15
Viewing Animations.....	17
Changing LCD Screen Language.....	19
Product Parts Locations	19
Product Parts - Front	20
Product Parts - Inside	21
Product Parts - Back.....	22
Using Power Saving Settings	22
Changing the Sleep Timer Settings	22
Changing the Power Off Timer Settings	23
Epson Connect Solutions for Smartphones, Tablets, and More	24
Setting Up Epson Connect Services.....	25
Using Epson Email Print	26
Using the Epson iPrint Mobile App	27
Using Epson Remote Print	27
Using Epson Scan to Cloud.....	28
Using AirPrint	29
Using Google Cloud Print.....	30
Setting Up Google Cloud Print on a Chromebook	31
Android Printing Using the Epson Print Enabler	32
Using Fire OS Printing	32
Using Windows 10 Mobile Printing	33
Using Epson Print and Scan App with Windows Tablets	33

Using the Mopria Print Service	34
Wi-Fi Networking	35
Network Security Recommendations	35
Wi-Fi Infrastructure Mode Setup.....	36
Selecting Wireless Network Settings from the Control Panel	37
Wi-Fi Direct Mode Setup	40
Enabling Wi-Fi Direct Mode	40
Connecting to a Mobile Device Using Wi-Fi Direct	42
Wi-Fi Protected Setup (WPS).....	43
Using WPS to Connect to a Network	44
Printing a Network Status Sheet.....	45
Printing a Network Connection Report	46
Network Connection Report Codes and Messages	47
Changing or Updating Network Connections	53
Accessing the Web Config Utility	53
Changing a USB Connection to a Wi-Fi Connection.....	54
Connecting to a New Wi-Fi Router	54
Disabling Wi-Fi Features	55
Loading Paper	57
Loading Paper in the Rear Paper Feed	57
Paper Loading Capacity	61
Turning Off the Paper Setting Alert.....	61
Double-sided Printing Capacity	62
Compatible Epson Papers.....	63
Borderless Paper Type Compatibility	65
Paper or Media Type Settings - Printing Software.....	66
Selecting the Paper Settings - Control Panel	66
Paper Type Settings - Control Panel	68
Placing Originals on the Product	70
Placing Originals on the Scanner Glass	70
Copying	74
Copying Documents or Photos.....	74

Copying Restored Photos	75
Copying Books, ID Cards, or Borderless Photos	77
Copying Options.....	78
Printing from a Computer	80
Printing with Windows	80
Selecting Basic Print Settings - Windows	81
Print Quality Options - Windows	83
Multi-Page Printing Options - Windows.....	83
Selecting Double-sided Printing Settings - Windows	84
Double-sided Printing Options - Windows.....	86
Print Density Adjustments - Windows	87
Selecting Additional Layout and Print Options - Windows	88
Custom Color Correction Options - Windows.....	90
Image Options and Additional Settings - Windows.....	91
Header/Footer Settings - Windows	92
Selecting a Printing Preset - Windows.....	93
Selecting Extended Settings - Windows	94
Extended Settings - Windows	95
Printing Your Document or Photo - Windows.....	96
Checking Print Status - Windows	98
Selecting Default Print Settings - Windows.....	98
Changing the Language of the Printer Software Screens	99
Changing Automatic Update Options	100
Printing with the Built-in Epson Driver - Windows 10 S.....	101
Selecting Print Settings - Windows 10 S.....	102
Printing on a Mac	105
Selecting Basic Print Settings - Mac	106
Print Quality Settings - Mac.....	110
Print Options - Mac	110
Selecting Page Setup Settings - Mac	111
Selecting Print Layout Options - Mac.....	112
Selecting Double-sided Printing Settings - Mac.....	113
Double-sided Printing Options and Adjustments - Mac.....	114

Managing Color - Mac	115
Color Matching and Color Options - Mac	116
Selecting Printing Preferences - Mac	117
Printing Preferences - Mac.....	118
Printing Your Document or Photo - Mac	119
Checking Print Status - Mac.....	120
Printing From a Chromebook	120
Cancelling Printing Using a Product Button.....	122
Scanning	123
Starting a Scan.....	123
Starting a Scan Using the Product Control Panel	123
Scanning to a Connected Computer	125
Scanning to the Cloud.....	127
Setting Up a WSD Port (Windows 7/Windows Vista)	128
Control Panel Scanning Options.....	129
Changing Default Scan Job Settings	130
Starting a Scan Using the Epson Scan 2 Icon	131
Starting a Scan from a Scanning Program.....	133
Starting a Scan from a Smart Device.....	135
Scanning in Epson Scan 2	135
Additional Scanning Settings - Main Settings Tab	138
Additional Scanning Settings - Advanced Settings Tab	139
Saving Scanned Documents as a Searchable PDF Using Epson Scan 2	140
Image Format Options.....	141
Scan Resolution Guidelines	142
Scanning to Online Destinations Using Easy Photo Scan	143
Scanning Using Easy Photo Scan	143
Uploading Scanned Images to Google Photos	145
Uploading Scanned Images to Evernote	147
Uploading Scanned Images to SugarSync	149
Uploading Scanned Images to a Web Folder	150
Uploading Scanned Images to Email.....	152
Saving Scanned Images to a Folder.....	153

Replacing Ink Cartridges and Maintenance Boxes.....	155
Check Cartridge and Maintenance Box Status.....	155
Checking Cartridge and Maintenance Box Status on the LCD Screen	155
Checking Cartridge and Maintenance Box Status - Windows.....	156
Checking Cartridge and Maintenance Box Status - Mac	159
Purchase Epson Ink Cartridges and Maintenance Box	160
Ink Cartridge and Maintenance Box Part Numbers.....	160
Removing and Installing Ink Cartridges.....	161
Printing with Black Ink and Expended Color Cartridges	167
Printing with Expended Color Cartridges - Control Panel	167
Printing with Expended Color Cartridges - Windows	168
Printing with Expended Color Cartridges - Mac	168
Conserving Low Black Ink with Windows	170
Replacing the Maintenance Box.....	170
Adjusting Print Quality.....	175
Print Head Maintenance.....	175
Print Head Nozzle Check.....	175
Checking the Nozzles Using the Product Control Panel	175
Checking the Nozzles Using a Computer Utility	178
Print Head Cleaning	180
Cleaning the Print Head Using the Product Control Panel	181
Cleaning the Print Head Using a Computer Utility.....	182
Aligning the Print Head Using the Product Control Panel	185
Cleaning the Paper Guide	186
Cleaning and Transporting Your Product	187
Cleaning Your Product	187
Cleaning the Print Head Path	187
Transporting Your Product	190
Solving Problems	194
Checking for Software Updates.....	194
Product Status Messages	195
Running a Product Check	197
Resetting Control Panel Defaults	198

Solving Setup Problems	199
Product Does Not Turn On or Off.....	200
Noise After Ink Installation	200
Software Installation Problems	200
Solving Network Problems	201
Product Cannot Connect to a Wireless Router or Access Point	201
Network Software Cannot Find Product on a Network.....	203
Product Does Not Appear in Mac Printer Window	204
Cannot Print Over a Network.....	204
Cannot Scan Over a Network	206
Wireless Network Connection is Unstable on a Mac	206
Solving Copying Problems	207
Product Makes Noise, But Nothing Copies.....	207
Product Makes Noise When It Sits for a While.....	207
Solving Paper Problems.....	207
Paper Feeding Problems	208
Paper Jam Problems Inside the Product	208
Paper Jam Problems in the Rear Cover	210
Paper Ejection Problems	212
Solving Problems Printing from a Computer.....	212
Nothing Prints	213
Product Icon Does Not Appear in Windows Taskbar	213
Printing is Slow	214
Solving Page Layout and Content Problems	216
Inverted Image.....	216
Too Many Copies Print	217
Blank Pages Print	217
Incorrect Margins on Printout.....	218
Border Appears on Borderless Prints	218
Incorrect Characters Print.....	219
Incorrect Image Size or Position	219
Slanted Printout	220
Solving Print Quality Problems	221

White or Dark Lines in Printout	221
Blurry or Smearred Printout	222
Faint Printout or Printout Has Gaps	223
Grainy Printout.....	223
Incorrect Colors	224
Solving Scanning Problems	225
Scanning Software Does Not Operate Correctly	225
Cannot Start Epson Scan 2	226
Scanning is Slow	227
Solving Scanned Image Quality Problems	227
Scanned Image Quality Problems	227
Image Consists of a Few Dots Only.....	229
Line of Dots Appears in All Scanned Images.....	229
Straight Lines in an Image Appear Crooked	229
Image Colors are Patchy at the Edges	229
Ripple Patterns Appear in an Image	230
Scanned Image Edges are Cropped	230
Uninstall Your Product Software.....	230
Uninstalling Product Software - Windows.....	230
Uninstalling Product Software - Mac.....	231
Where to Get Help.....	232
Technical Specifications	234
Windows System Requirements	234
Mac System Requirements	235
Paper Specifications	235
Printable Area Specifications	237
Scanning Specifications	238
Ink Cartridge Specifications.....	239
Dimension Specifications	240
Electrical Specifications	240
Environmental Specifications	241
Interface Specifications	241
Network Interface Specifications	241

Safety and Approvals Specifications	242
Notices	243
Important Safety Instructions.....	243
General Product Safety Instructions	243
Ink Cartridge Safety Instructions.....	245
Wireless Connection Safety Instructions	246
LCD Screen Safety Instructions.....	246
Important Privacy Notice (Printer Serial Number).....	247
FCC Compliance Statement.....	247
Binding Arbitration and Class Waiver	248
Trademarks	251
Copyright Notice.....	252
libTIFF Software Acknowledgment.....	252
A Note Concerning Responsible Use of Copyrighted Materials.....	253
Default Delay Times for Power Management for Epson Products	253
Copyright Attribution	253

XP-4100/XP-4105 User's Guide

Welcome to the XP-4100/XP-4105 *User's Guide*.

For a printable PDF copy of this guide, [click here](#).

Product Basics

See these sections to learn about the basic features of your product.

[Using the Control Panel](#)

[Product Parts Locations](#)

[Using Power Saving Settings](#)

[Epson Connect Solutions for Smartphones, Tablets, and More](#)

[Using AirPrint](#)

[Using Google Cloud Print](#)

[Android Printing Using the Epson Print Enabler](#)

[Using Fire OS Printing](#)

[Using Windows 10 Mobile Printing](#)

[Using Epson Print and Scan App with Windows Tablets](#)

[Using the Mopria Print Service](#)

Using the Control Panel

See these sections to learn about the control panel and select control panel settings.

[Control Panel Buttons and Lights](#)

[Changing LCD Screen Language](#)

Parent topic: [Product Basics](#)

Control Panel Buttons and Lights

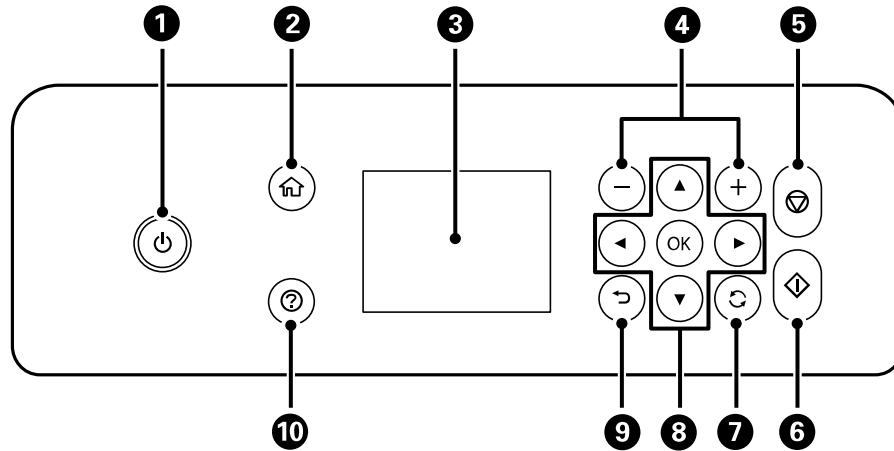

- 1 power button and light
- 2 home button
- 3 LCD screen
- 4 + and - buttons
- 5 stop button
- 6 start button
- 7 reset button
- 8 Arrow buttons and the **OK** button
- 9 back button
- 10 help button

[The LCD Screen](#)

[Status Icon Information](#)

[Navigating the LCD Screen](#)

[Entering Characters on the LCD Screen](#)

[Viewing Animations](#)

Parent topic: [Using the Control Panel](#)

The LCD Screen

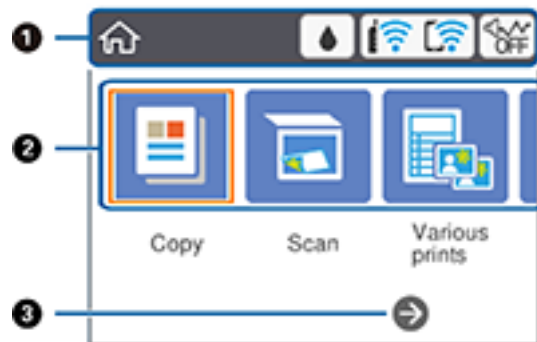

- 1 Displays various status information; select an icon to check its status or adjust its settings
- 2 Menu options
- 3 Scrolls to show more menu options

Parent topic: [Control Panel Buttons and Lights](#)







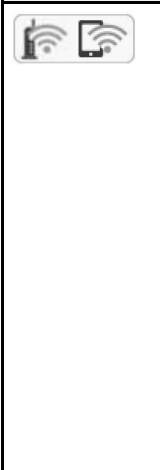

Related references

[LCD Screen Safety Instructions](#)

Status Icon Information

Your product displays status icons on the LCD screen for certain product status conditions.

Icons	Description
	Ink and maintenance box status; select the icon to view the ink and maintenance box levels

Icons	Description
	<p>Network connection status; select the icon to set up or change your network connection</p> <ul style="list-style-type: none"> •  The product is not connected to a wireless network •  The product is searching for an SSID or experiencing a wireless network connection issue •  The product is connected to a wireless network; the number of bars indicates the connection's signal strength •  Wi-Fi Direct is not enabled •  Wi-Fi Direct is enabled
	<p>The Quiet Mode setting is enabled or disabled. Select the icon to change the setting. When this feature is enabled and depending on the selected paper type and print quality, noise is reduced during printing at the cost of print speed.</p>
	<p>There is a problem with the indicated setting; select the icon for information on resolving the problem</p>
	<p>Additional information is available; select the icon to display the information</p>

Parent topic: [Control Panel Buttons and Lights](#)

Navigating the LCD Screen

Follow these guidelines to navigate and use the menus on the LCD screen.

To navigate the menus, press the arrow buttons to change your highlighted selection and press the **OK** button to confirm your selection.

To change a setting, press the arrow buttons to highlight the setting and press the **OK** button.

To enter a value in a field, press the arrow buttons to highlight the field and press the **OK** button to display the on-screen keyboard.

Parent topic: [Control Panel Buttons and Lights](#)

Entering Characters on the LCD Screen

Follow these guidelines to enter characters for passwords and other settings.

On-screen keyboard

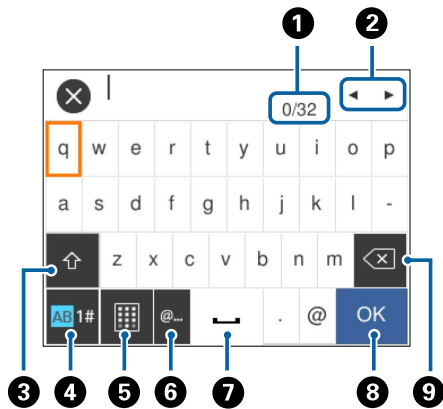

- 1 Displays the character count
- 2 Moves the cursor left or right
- 3 Switches between uppercase and lowercase characters, numbers and symbols
- 4 Switches between characters and numbers or symbols
- 5 Changes the keyboard layout
- 6 Displays a list of common domain names to choose from
- 7 Enters a space
- 8 Select when you are finished
- 9 Deletes the previous character

Note: You can also switch the character type by pressing the  reset button.

On-screen keypad



- 1 Deletes the previous number
- 2 Clears the entered number
- 3 Select when you are finished

Parent topic: [Control Panel Buttons and Lights](#)

Viewing Animations

You can view animations on the LCD screen to help guide you with a procedure or to troubleshoot a problem.

1. Press the  help button.

You see a screen like this:

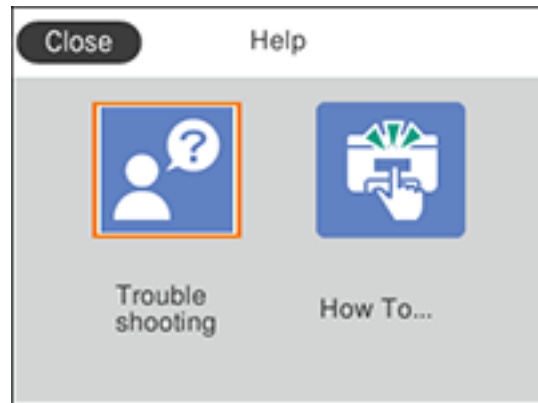

2. Select **Troubleshooting** if you are experiencing a problem or **How To** to view instructions on common procedures.
3. Select a topic from the list of available topics and follow the on-screen instructions.

While viewing the topics, you may see screens like this:

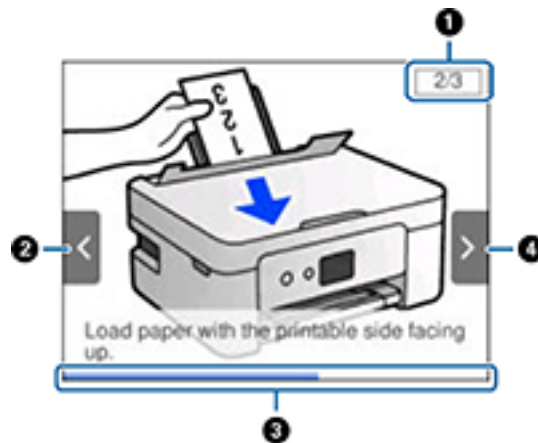

- 1 Displays the current step number and the total number of steps

- 2 Press the left arrow button to view the previous step
- 3 Indicates your overall progress through the animation
- 4 Press the right arrow button to view the next step

Parent topic: [Control Panel Buttons and Lights](#)

Changing LCD Screen Language

You can change the language used on the LCD screen.

1. Press the  home button, if necessary.
2. Select **Settings**.

You see a screen like this:

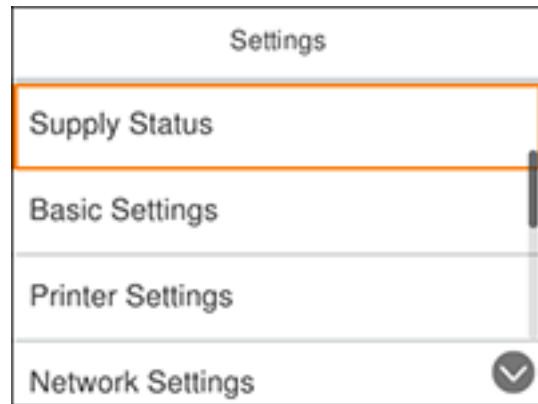

3. Select **Basic Settings**.
4. Select **Language**.
5. Select a language.

Parent topic: [Using the Control Panel](#)

Product Parts Locations

See these sections to identify the parts on your product.

[Product Parts - Front](#)

[Product Parts - Inside](#)

[Product Parts - Back](#)

Parent topic: [Product Basics](#)

Product Parts - Front

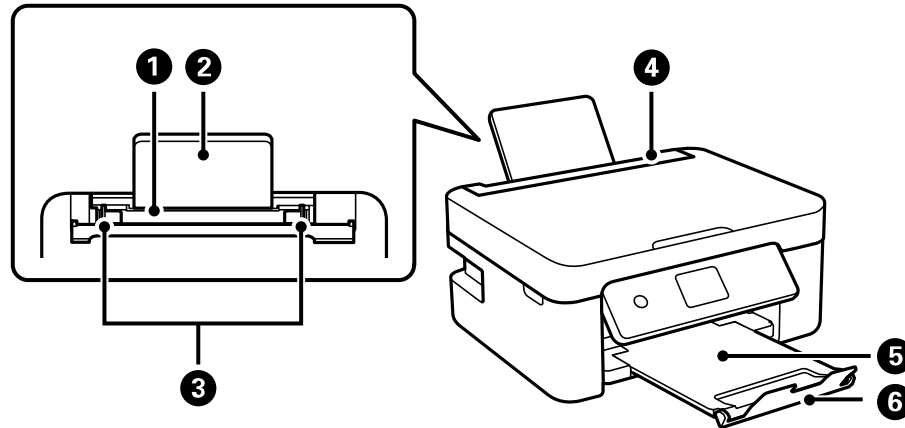

- 1 Rear paper feed
- 2 Paper support
- 3 Edge guides
- 4 Feeder guard
- 5 Output tray
- 6 Stopper

Parent topic: [Product Parts Locations](#)

Product Parts - Inside

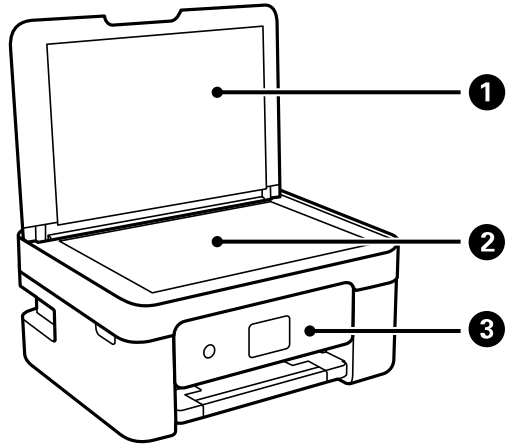

- 1 Document cover
- 2 Scanner glass
- 3 Control panel

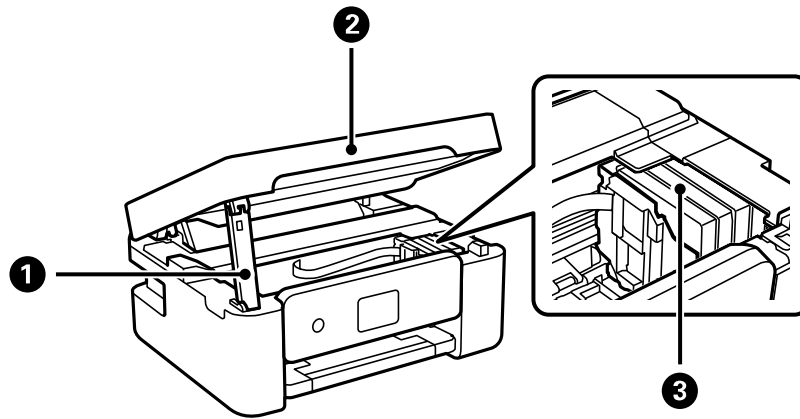

- 1 Scanner unit support

- 2 Scanner unit
- 3 Ink cartridge holder

Parent topic: [Product Parts Locations](#)

Product Parts - Back

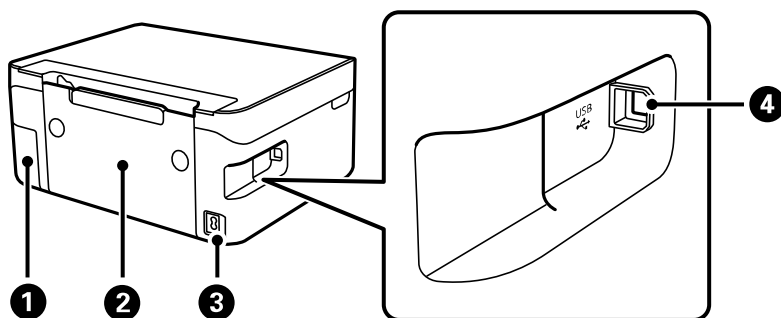

- 1 Maintenance box cover
- 2 Rear cover (duplexer)
- 3 AC inlet
- 4 **USB** port

Parent topic: [Product Parts Locations](#)

Using Power Saving Settings

Your product enters sleep mode automatically and turns off the LCD screen if it is not used for a period of time. You can make the time period shorter and select other options to save energy and resources.

[Changing the Sleep Timer Settings](#)

[Changing the Power Off Timer Settings](#)

Parent topic: [Product Basics](#)

Changing the Sleep Timer Settings

You can adjust the time period before your product enters sleep mode and turns off the LCD screen.

1. Press the  home button, if necessary.
2. Select **Settings**.

You see a screen like this:

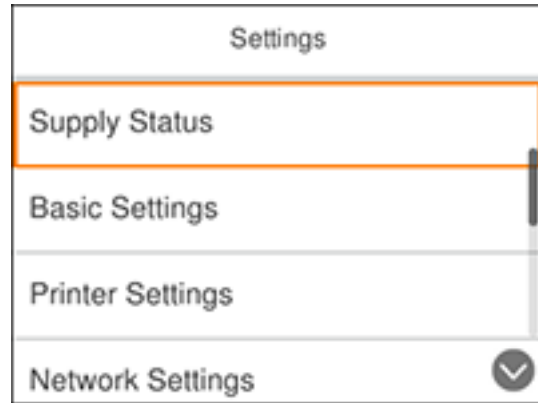

3. Select **Basic Settings**.
4. Select **Sleep Timer**.
5. Press the + and – button to adjust the number of minutes of inactivity before the product enters sleep mode.

Note: You can also use the displayed numeric keypad to select the number of minutes (up to 99).

Parent topic: [Using Power Saving Settings](#)

Changing the Power Off Timer Settings

You can have the product turn off automatically if it is not used for a specified period of time.

1. Press the  home button, if necessary.
2. Select **Settings**.

You see a screen like this:

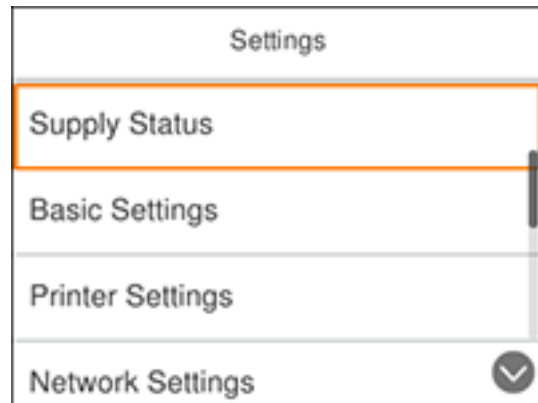

3. Select **Basic Settings**.
4. Select **Power Off Timer**.
5. Select a time period between **30minutes** and **12h** (12 hours).

Parent topic: [Using Power Saving Settings](#)

Epson Connect Solutions for Smartphones, Tablets, and More

Use your smartphone, tablet, or computer to print and scan documents, photos, emails, and web pages from your home, office, or even across the globe.

Note: If you are using your Epson product with the Windows 10 S operating system, you cannot use the software described in this section. You also cannot download and install any Epson product software from the Epson website for use with Windows 10 S; you must obtain software only from the Windows Store.

Print from anywhere with these Epson Connect solutions:

- Epson Email Print
- Epson iPrint Mobile App
- Epson Remote Print

Scan and send a file as an email or upload it to an online service directly from your Epson product with Epson Scan to Cloud or the Epson iPrint Mobile App.

[Setting Up Epson Connect Services](#)

[Using Epson Email Print](#)

[Using the Epson iPrint Mobile App](#)

[Using Epson Remote Print](#)

[Using Epson Scan to Cloud](#)

Parent topic: [Product Basics](#)

Related tasks

[Using AirPrint](#)

[Using Google Cloud Print](#)

[Android Printing Using the Epson Print Enabler](#)

[Using Fire OS Printing](#)

[Using Windows 10 Mobile Printing](#)

[Using Epson Print and Scan App with Windows Tablets](#)

[Using the Mopria Print Service](#)

Setting Up Epson Connect Services

If you did not activate your product's email address for use with Epson Connect when you set up your product, you can activate it using the product control panel.

1. Press the  home button, if necessary.
2. Select **Settings**.

You see a screen like this:

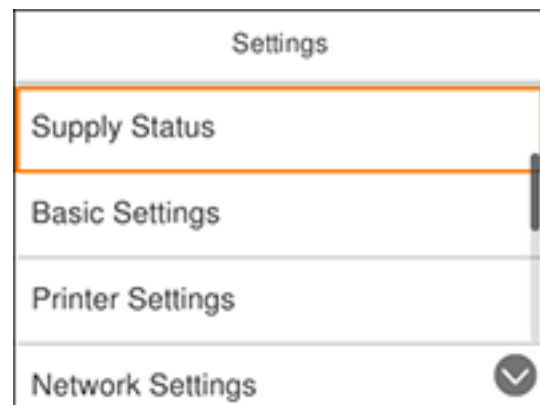

3. Select **Web Service Settings**.
4. Select **Epson Connect Services**.

You see a screen like this:

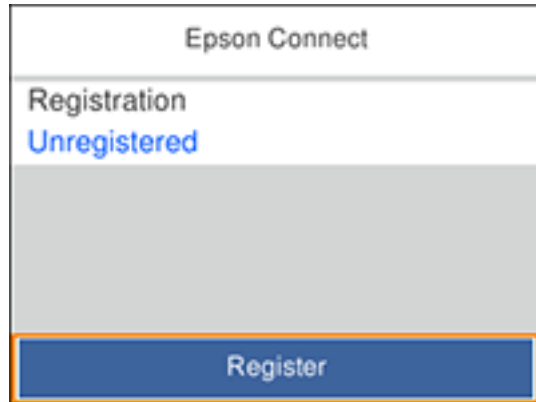

5. Select **Register**.
6. Follow the instructions on the screen to activate your product's email address.

Parent topic: [Epson Connect Solutions for Smartphones, Tablets, and More](#)

Using Epson Email Print

With Epson Email Print, you can print from any device that can send email, such as your smartphone, tablet, or laptop. Just activate your product's unique email address. When you want to print, attach a PDF, Microsoft Office document, or photo to an email and send it to your product. Both the email and the attachments will print automatically.

1. Connect your product to your network. See the link below.
2. If you did not already set up Email Print when you installed your product software, see the link below to use your product control panel to activate your unique email address. Or visit epson.com/connect (U.S), epson.ca/connect (Canada), or epsonconnect.com (Caribbean) to learn more about Email Print, create your Epson Connect account, and register your product to the Epson Connect service.
3. Now you are ready to send and print emails to your product's Email Print address.

Note: Go to epsonconnect.com and log into your Epson Connect account to personalize your product's email, adjust print settings, and set up other Epson Connect services.

Parent topic: [Epson Connect Solutions for Smartphones, Tablets, and More](#)

Related tasks

[Setting Up Epson Connect Services](#)

Related topics

[Wi-Fi Networking](#)

Using the Epson iPrint Mobile App

Use this free Apple and Android app to print and scan with networked Epson products. Epson iPrint lets you print PDFs, Microsoft Office documents, photos, and web pages over a wireless network. You can scan and save a file on your device, send it as an email, or upload it to an online service such as Box, Dropbox, Evernote, or Google Drive.

1. Connect your product to your wireless network. See the link below.
2. Visit epson.com/connect (U.S), epson.ca/connect (Canada), or epson.com.jm/connect (Caribbean) to learn more about Epson iPrint and check the compatibility of your mobile device.
3. Download Epson iPrint from the Apple App Store or Google Play.
4. Connect your mobile device to the same wireless network as your product.
5. Open Epson iPrint and select your Epson product.

Now you are ready to print or scan with your mobile device and your Epson product.

Parent topic: [Epson Connect Solutions for Smartphones, Tablets, and More](#)

Related tasks

[Setting Up Epson Connect Services](#)

Related topics

[Wi-Fi Networking](#)

Using Epson Remote Print

With Epson Remote Print software, you can print from your laptop or desktop computer to an Epson Email-enabled product anywhere in the world.

1. Connect your Epson product to your wireless network. See the link below.

2. If you did not already set up an Epson Connect account when you installed your product software, visit epsonconnect.com to create your account and register your product to the Epson Connect service.

Note: Make a note of your product's email address.

3. Visit epsonconnect.com to learn more about Remote Print and how to download the Remote Print Driver software.
4. Download and install the Remote Print software.
5. Enter the email address and optional access key of your Epson product during Remote Print setup.
6. Now you are ready to print remotely. Select the print command in your laptop or desktop computer application and choose the Remote Print option for your Epson product.

Parent topic: [Epson Connect Solutions for Smartphones, Tablets, and More](#)

Related tasks

[Setting Up Epson Connect Services](#)

Related topics

[Wi-Fi Networking](#)

Using Epson Scan to Cloud

The Epson Scan to Cloud service allows you to scan and send a file as an email or upload it to an online service directly from your Epson product. Register an email address or online services such as Box, DropBox, Evernote, or Google Drive with your Epson Connect account.

1. Connect your Epson product to your network. See the link below.
2. If you did not already set up an Epson Connect account when you installed your product software, visit epsonconnect.com to create your account and register your product to the Epson Connect service.

Note: Make a note of your product's email address and password.

3. Visit epsonconnect.com to sign into your account with the email address and password you selected.
4. Select your product, select **Scan to Cloud**, and select **Destination List**.
5. Click **Add**, then follow the instructions on the screen to create your destination list.

6. Now you are ready to use Scan to Cloud. Select the setting for scanning to Scan to Cloud on your Epson product control panel.

Parent topic: [Epson Connect Solutions for Smartphones, Tablets, and More](#)

Related tasks

[Setting Up Epson Connect Services](#)

Related topics

[Wi-Fi Networking](#)

Using AirPrint

AirPrint enables instant wireless printing from iPhone, iPad, and iPod touch with the latest version of iOS, and Mac with the latest version of OS X or macOS.



Note: If you disabled paper configuration messages on your product control panel, you cannot use AirPrint. See the link below to enable the messages, if necessary.

1. Load paper in your product.
2. Set up your product for wireless printing. See the link below.
3. Connect your Apple device to the same wireless network that your product is using.
4. Print from your device to your product.

Note: For details, see the AirPrint page on the Apple website.

Parent topic: [Product Basics](#)

Related tasks

[Setting Up Epson Connect Services](#)

Related topics

[Wi-Fi Networking](#)

Using Google Cloud Print

With a Google Account, you can print from your Apple or Android device to your Epson product. You can also print from Chromebooks and the Google Chrome browser without drivers or cables.

1. Connect your Epson product to your wireless network. See the link below.
2. Note your product's IP address by checking your network status. See the link below.
3. Connect your computer or your mobile device to the same wireless network as your Epson product.
4. Enter your product's IP address into the address bar of a web browser.
5. Select the **Google Cloud Print Services** option.

Note: If you don't see the **Google Cloud Print Services** option, turn your product off and back on. If the option still doesn't appear, select the **Firmware Update** option and follow the on-screen instructions to update your product.

6. Click **Register**.
7. Select the checkbox to agree to the Usage Advisory and click **Next**.
8. Click **OK** to launch the sign-in page.
A separate browser window opens.
9. Enter your Google Account username and password and click **Sign in**, or, if you don't have an account, click **Sign up for a new Google Account** and follow the on-screen instructions.
10. Click **Finish printer registration** to complete setup and print a test page.

Your product is now linked to your Google Account and can be accessed from any Chromebook, computer, Apple or Android device with Internet access. Visit [Epson Support for Google Cloud Print \(U.S\)](#) or [Epson Support for Google Cloud Print \(Canada\)](#) for more information on using Google Cloud Print, or the [Google Cloud Print](#) website for a list of [supported apps](#).

[Setting Up Google Cloud Print on a Chromebook](#)

Parent topic: [Product Basics](#)

Related tasks

[Printing a Network Status Sheet](#)

Related topics

[Wi-Fi Networking](#)

Setting Up Google Cloud Print on a Chromebook

With a Google Account, you can print from a Chromebook without drivers or cables.

1. Connect your Epson product to your wireless network. See the link below.
2. Turn on your Chromebook and connect it to the same wireless network as your product.

Note: See your Chromebook's documentation for details on connecting to a network.

3. Do one of the following:
 - Click **Add to Cloud Print** in the notification that appears in the corner of your Chromebook screen.

Note: If you do not see a notification, check to see if a number appears in the status area at the lower-right corner of the screen. Click this number to open the notifications menu, then click **Add to Cloud Print**.

- Open a web browser and enter **chrome://devices** in the address bar. Skip to step 5.
 - If you see a registration confirmation screen instead, click **Register**.
4. Click **Add Device**.
 5. Click the **Register** button that appears next to your product.
 6. Click **Register** on the confirmation screen. Your product's LCD screen displays a confirmation message.
 7. Select **OK** or press the **OK** button on your product to confirm the Google Cloud Print connection and print a test page.

Your product is now linked to your Google Account and can be accessed from any Chromebook, iPhone, or Android phone with Internet access. Visit [Epson Support for Google Cloud Print \(U.S\)](#) or [Epson Support for Google Cloud Print \(Canada\)](#) for more information on using Google Cloud Print, or the [Google Cloud Print](#) website for a list of [supported apps](#).

Parent topic: [Using Google Cloud Print](#)

Related tasks

[Printing From a Chromebook](#)

Related topics

[Wi-Fi Networking](#)

Android Printing Using the Epson Print Enabler

You can wirelessly print your documents, emails, photos, and web pages right from your Android phone or tablet (Android v4.4 or later). With a few taps, your Android device will discover your nearby Epson product and print.

1. Connect your Epson product to your wireless network. See the link below.
2. On your Android device, download the Epson Print Enabler plug-in from Google Play.
3. Go to **Settings** on your Android device, select **Printing**, and enable the Epson plug-in.
4. Connect your Android device to the same wireless network as your product.
5. Now you are ready to print. From an Android application such as Chrome or Gmail, tap the menu icon and print whatever is on the screen.

Note: If you do not see your product, tap **All Printers** and select your product.

Parent topic: [Product Basics](#)

Related topics

[Wi-Fi Networking](#)

Using Fire OS Printing

You can wirelessly print from Amazon Fire tablets and phones to your nearby networked Epson product. There is no software to download, no drivers to install, and no cables to connect. With just a few taps in Email, Calendar, Contacts, and WPS Office, you can send whatever is on the screen to an Epson product.

1. Connect your Epson product to your wireless network. See the link below.
2. Connect your Amazon device to the same wireless network as your product.
3. Now you are ready to print. From your Amazon application, tap the print option and select your product to print whatever is on the screen.

Note: If you see a message telling you that a plug-in is required, tap **OK** and tap **Download**. If your Amazon Fire product uses Fire OS 5 and above, your device automatically uses the built-in Mopria Print Service app to print.

Parent topic: [Product Basics](#)

Related topics[Wi-Fi Networking](#)[Wi-Fi Networking](#)

Using Windows 10 Mobile Printing

You can wirelessly print from Windows 10 Mobile tablets and phones to your nearby networked Epson product. There is no software to download, no drivers to install, and no cables to connect. Look for the print option in your Windows 10 application to send whatever is on the screen to an Epson product.

1. Connect your Epson product to your wireless network. See the link below.
2. Connect your Windows 10 Mobile device to the same wireless network as your product.
3. Now you are ready to print. From your Windows 10 application, tap the print option and select your product to print whatever is on the screen.

Parent topic: [Product Basics](#)

Related topics[Wi-Fi Networking](#)

Using Epson Print and Scan App with Windows Tablets

You can use this free app to print photos and scan from your Windows (Windows 8 or higher) Surface RT or Pro tablet with networked Epson products. Epson Print and Scan App allows you to scan and capture images right to your tablet or to Microsoft OneDrive.

Note: The Epson Print and Scan App does not support Windows 10 Mobile printing.

1. Connect your Epson product to your wireless network. See the link below.
2. Download Epson Print and Scan App from the Microsoft Windows Store.
3. Connect your Windows tablet to the same wireless network as your product.
4. Open Epson Print and Scan App and select your Epson product.

Now you are ready to print photos or scan.

Parent topic: [Product Basics](#)

Related topics[Wi-Fi Networking](#)

Using the Mopria Print Service

You can use the Mopria Print Service to print from your Android phone or tablet (Android v4.4 or later) to your Epson product or any Mopria-certified product from other manufacturers. You can download the Mopria Print Service from Google Play.

Note: For details on the Mopria Print Service, [click here](#) (U.S) or [click here](#) (Canada).

1. Connect your Epson product to your wireless network. See the link below.
2. On your Android device, download the Mopria Print Service app from Google Play.

Note: On some Samsung Galaxy devices, Mopria may come preinstalled.

3. Go to **Settings** on your Android device, select **Printing**, and enable the Mopria Print Service.
4. Connect your Android device to the same wireless network as your product.
5. Now you are ready to print. From an Android application such as Chrome or Gmail, tap the menu icon and select **Print**. Then select **All printers**, select your Epson product, adjust your print settings, and print.

Parent topic: [Product Basics](#)

Related topics

[Wi-Fi Networking](#)

Wi-Fi Networking

See these sections to use your product on a Wi-Fi network.

[Network Security Recommendations](#)

[Wi-Fi Infrastructure Mode Setup](#)

[Wi-Fi Direct Mode Setup](#)

[Wi-Fi Protected Setup \(WPS\)](#)

[Printing a Network Status Sheet](#)

[Printing a Network Connection Report](#)

[Changing or Updating Network Connections](#)

Related references

[Wireless Connection Safety Instructions](#)

Network Security Recommendations

To help deter unauthorized access to your product over a network, you should protect your network environment using appropriate security measures.

Security measures such as these can help deter threats such as loss of user data, use of telephone and fax lines, and other intrusions:

- **Enable security on your wireless LAN**

Enable the appropriate security on the wireless LAN you plan to use with your product. Network security such as a network password can deter interception of traffic over the wireless LAN. Your router may already have a default password enabled by your Internet service provider (ISP). See your ISP and router documentation for instructions on how to change the default password and better secure your network.

- **Connect your product only to a network protected by a firewall**

Connecting your product directly to the Internet may leave it vulnerable to security threats. Instead, connect it to a router or other network connection protected by a firewall. Your router may already have a firewall set up by your Internet service provider; check with your ISP for confirmation. For best results, set up and use a private IP address for your network connection.

- **Change the default administrator password on your product**

If your product has an option to set an administrator password, change the default administrator password to deter access by unauthorized users to personal data stored on your product, such as IDs, passwords, and contact lists.

Parent topic: [Wi-Fi Networking](#)

Wi-Fi Infrastructure Mode Setup

You can set up your product to communicate with your computer using a wireless router or access point. The wireless router or access point can be connected to your computer over a wireless or wired network.

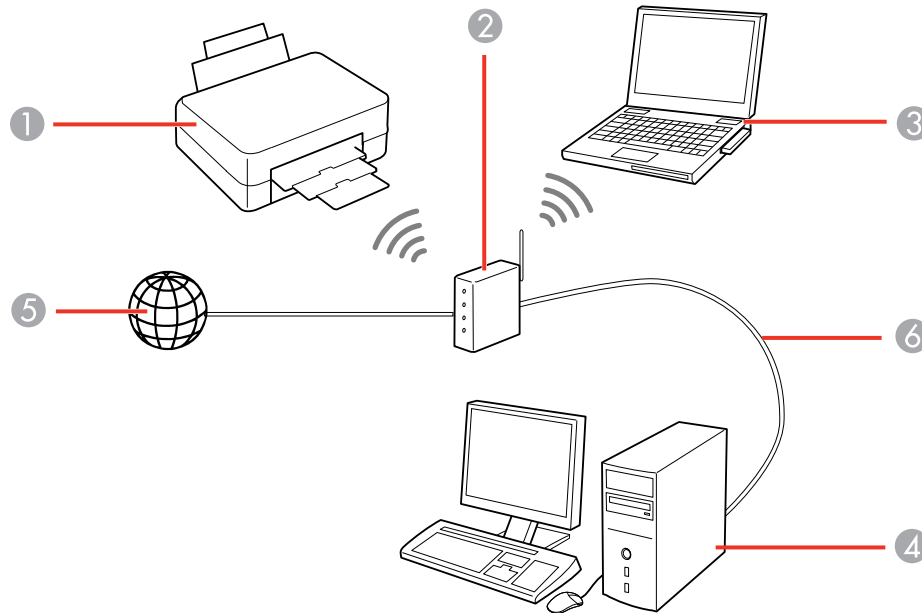

- 1 Epson product
- 2 Wireless router or access point
- 3 Computer with a wireless interface
- 4 Computer
- 5 Internet
- 6 Ethernet cable (used only for wired connection to the wireless router or access point)

[Selecting Wireless Network Settings from the Control Panel](#)



Parent topic: [Wi-Fi Networking](#)

Selecting Wireless Network Settings from the Control Panel

You can select or change wireless network settings using your product control panel.

To install your product on a wireless network, follow the instructions on the *Start Here* sheet and install the necessary software by downloading it from the Epson website. The installer program guides you through network setup.

Note: Breakdown or repair of this product may cause loss of network data and settings. Epson is not responsible for backing up or recovering data and settings during or after the warranty period. We recommend that you make your own backup or print out your network data and settings.

1. Press the  home button, if necessary.
2. Select the  icon.

You see a screen like this:

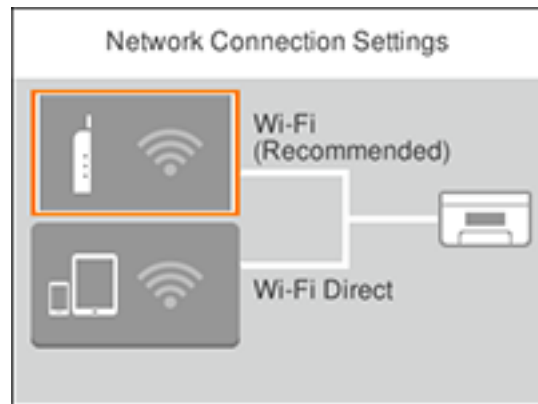

3. Select **Wi-Fi (Recommended)**.
4. Select **Start Setup** or **Change Settings**.
5. Select **Wi-Fi Setup Wizard**.

You see a screen like this:





6. Select the name of your wireless network or press the + button to enter the name manually. If you are entering the name manually, use the displayed keyboard to enter your network name.





Note: The network name and password are case sensitive. Be sure to correctly enter uppercase and lowercase letters, and numeric or special characters.

- To move the cursor, press the left or right arrows.
- To change the case of letters, select .

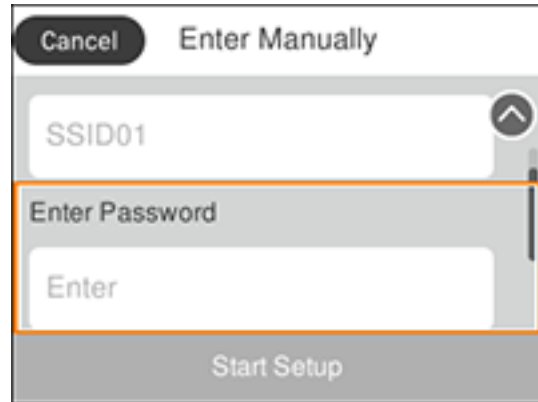
- To delete the previous character, select .
 - To enter numbers and symbols, select **AB1#**.
 - To enter a space, select .
 - To finish entering your network name or password, select **OK**.
7. Select the **Enter Password** field and use the displayed keyboard to enter your network password.



8. When you are finished, confirm the displayed network settings and select **Start Setup** to begin setup.
9. Do one of the following:
- If setup was successful, select **Print Check Report** to print a network setup report or **OK** to finish with the setup.
 - If setup was unsuccessful, select **Print Check Report** to print a network setup report or **Re-enter** to re-enter your network name and password again.
10. Press the  home button to return to the Home screen.

The  Wi-Fi icon is displayed on the LCD screen and indicates your wireless connection status. If the product is not connected to the network, you may have selected the wrong network name or entered the password incorrectly. Repeat these steps to try again.

If you are printing from a computer, make sure you installed the network software as described on the *Start Here* sheet.

Parent topic: [Wi-Fi Infrastructure Mode Setup](#)

Related references

[Status Icon Information](#)

Related tasks

[Entering Characters on the LCD Screen](#)

Wi-Fi Direct Mode Setup

You can set up your product to communicate directly with your computer or another device without requiring a wireless router or access point. In Wi-Fi Direct Mode, the product itself acts as a network access point for up to 8 devices.

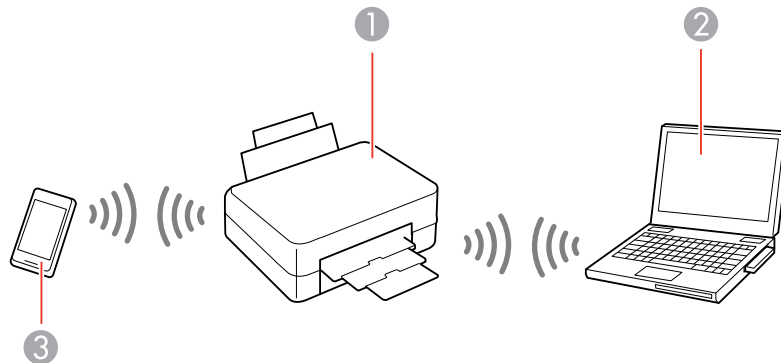

- 1 Epson product
- 2 Computer with a wireless interface
- 3 Other wireless device



[Enabling Wi-Fi Direct Mode](#)

[Connecting to a Mobile Device Using Wi-Fi Direct](#)

Parent topic: [Wi-Fi Networking](#)

Enabling Wi-Fi Direct Mode

You can enable Wi-Fi Direct mode to allow direct communication between your product and computer or other devices without a wireless router or access point.

1. Press the  home button, if necessary.
2. Select the  icon.

You see a screen like this:

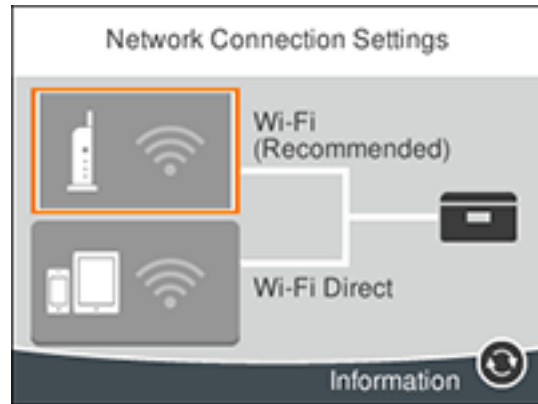

3. Select **Wi-Fi Direct**.
4. Select **Start Setup**.
5. Select **Start Setup** again.

You see a screen like this:



6. Use your computer or wireless device to select the Wi-Fi network name (SSID) displayed on the LCD screen, then enter the password shown.
7. When you are finished, scroll down on the product's LCD screen and select **OK**.

Note: You can also scan the QR Code on the LCD screen to view online setup instructions.

8. Press the  home button to return to the Home screen.

The  Wi-Fi Direct icon is displayed on the LCD screen and indicates if Wi-Fi Direct is enabled on the product.

If you are printing from a computer, make sure you installed the network software as described on the *Start Here* sheet.

Parent topic: [Wi-Fi Direct Mode Setup](#)

Related references

[Status Icon Information](#)

Connecting to a Mobile Device Using Wi-Fi Direct

You can connect a mobile device directly to the printer without a wireless router or access point.

Note: After your smartphone is connected, use the Epson iPrint app to print from the device.

1. Press the  home button, if necessary.
2. Select **Smartphone connect**.
 - If your product is not connected to a wireless network, go to the next step.
 - If your product is already connected to a wireless network, select **Next** to display your product's model name and IP address or select **Other Methods** to choose a specific device to connect.
3. Select **Start Setup**.

You see this screen:

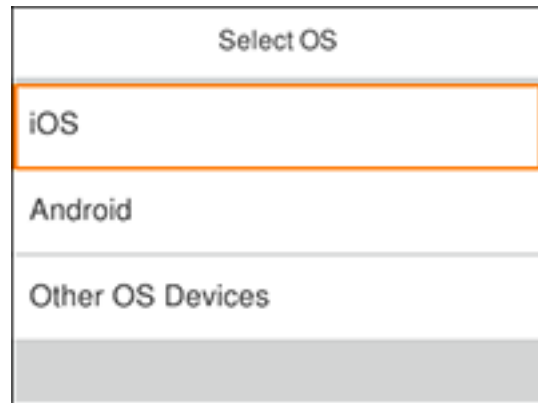

4. Do one of the following:
 - For iOS devices, select **iOS**. Scan the QR code with the camera app on your device and follow the instructions on your device. Select **Next** on the LCD screen to verify the printer information, and then open the Epson iPrint app on your device and select the printer displayed on the LCD screen. Select **Complete** on the LCD screen.
 - For Android devices, select **Android**. Open the Epson iPrint app on your device and select the printer displayed on the LCD screen. Select **Complete** on the LCD screen.
 - For other types of devices, select **Other OS Devices**. Use your device to select the Wi-Fi network name (SSID) displayed on the LCD screen, then enter the password shown.
5. Follow the instructions on the LCD screen to complete Wi-Fi Direct setup.

The  Wi-Fi Direct icon is displayed on the LCD screen and indicates if Wi-Fi Direct is enabled on the product.

Parent topic: [Wi-Fi Direct Mode Setup](#)

Related references

[Status Icon Information](#)

Wi-Fi Protected Setup (WPS)

If your network uses a WPS-enabled wireless router or access point, you can quickly connect your product to the network using Wi-Fi Protected Setup (WPS).



Note: To check if your router is WPS-enabled, look for a button labeled **WPS** on your router or access point. If there is no hardware button, there may be a virtual WPS button in the software for the device. Check your network product documentation for details.

Using WPS to Connect to a Network

Parent topic: [Wi-Fi Networking](#)

Using WPS to Connect to a Network

If you have a WPS-enabled wireless router or access point, you can use Wi-Fi Protected Setup (WPS) to connect your product to the network.

1. Press the  home button, if necessary.
2. Select the  icon.

You see a screen like this:

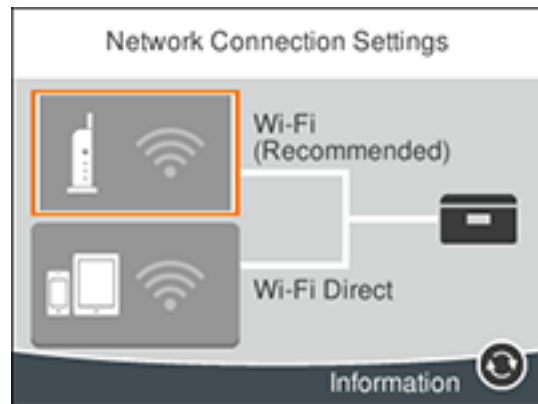

3. Select **Wi-Fi (Recommended)**.
4. Select **Start Setup** or **Change Settings**.
5. Select **Push Button Setup (WPS)**.
6. Follow the instructions on the LCD screen to complete WPS setup.

Note: Make sure you press **Start Setup** within two minutes of activating WPS on your router.

7. Press the  home button to return to the Home screen.

The  Wi-Fi icon is displayed on the LCD screen and indicates your wireless connection status. If the product is not connected to the network, repeat these steps to try again.

If you are printing from a computer, make sure you installed the network software as described on the *Start Here* sheet.

Parent topic: [Wi-Fi Protected Setup \(WPS\)](#)

Printing a Network Status Sheet

You can print a network status sheet to help you determine the causes of any problems you may have using your product on a network.

1. Press the  home button, if necessary.
2. Select **Settings**.

You see a screen like this:

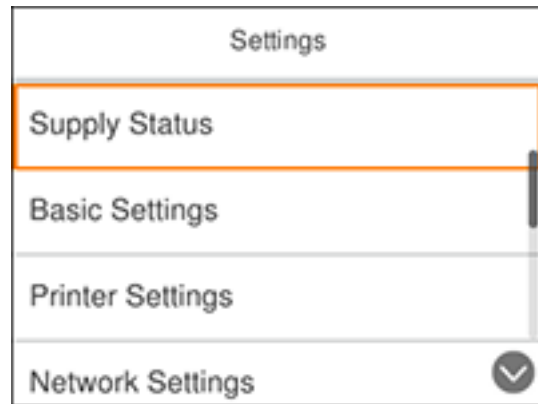

3. Select **Network Settings**.
4. Select **Network Status**.
5. Select **Print Status Sheet**.
6. Press the  start button to print the status sheet.

Examine the settings shown on the network status sheet to diagnose any problems you have.

Parent topic: [Wi-Fi Networking](#)

Printing a Network Connection Report

You can print a network connection report to view solutions to any problems you may have using your product on a network.

1. Make sure a few sheets of plain paper are loaded in the cassette.
2. Press the  home button, if necessary.
3. Select **Settings**.

You see a screen like this:

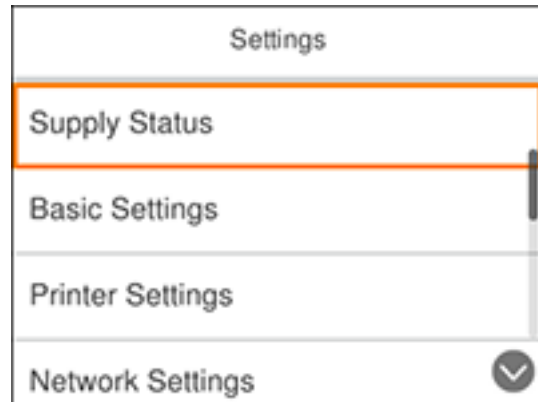

4. Select **Network Settings**.
5. Select **Connection Check**.

You see a screen like this:

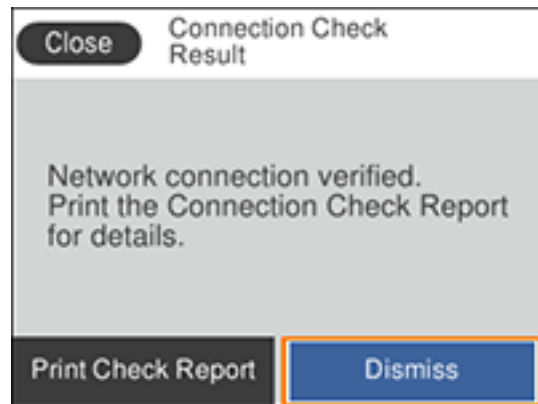

6. Select **Print Check Report** to print the network connection report.

Examine any error codes and solutions shown on the network connection report.

[Network Connection Report Codes and Messages](#)

Parent topic: [Wi-Fi Networking](#)

Network Connection Report Codes and Messages

Check the error codes and messages on the network connection report to solve problems you may encounter with network connections. The tables here list solutions to problems based on the error codes and messages that may appear on the top of the report.

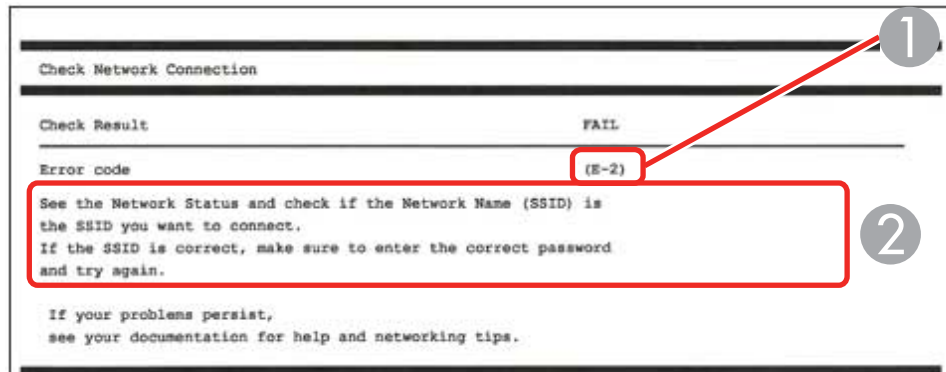

- 1 Error code
- 2 Message

Note: Error codes and messages listed here may not all apply to your product.

Error Codes and Messages

Error code and message	Solution
E1 Confirm that the network cable is connected and network devices such as hub, router, or access point are turned on.	Make sure your router, access point, and/or hub are turned on, and the network cable is securely connected to your device and to your product. If you are trying to set up Wi-Fi, remove the network cable and set up Wi-Fi again. Ethernet and Wi-Fi cannot be connected at the same time.

Error code and message	Solution
<p>E2, E3, or E7</p> <p>No wireless network names (SSID) found. Confirm that the router/access point is turned on and the wireless network (SSID) is set up correctly. Contact your network administrator for assistance.</p> <p>No wireless network names (SSID) found. Confirm that the wireless network name (SSID) of the PC you wish to connect is set up correctly. Contact your network administrator for assistance.</p> <p>Entered security key/password does not match the one set for your router/access point. Confirm security key/password. Contact your network administrator for assistance.</p>	<p>Check the following:</p> <ul style="list-style-type: none"> • Make sure your router or access point is turned on, and is correctly connected to your computer or network device. • Turn off the router or access point, wait about 10 seconds, and turn it on again. • Move your product closer to your router or access point, and remove any obstacles between them. Also move your product away from devices such as wireless phones or microwaves. • Confirm that the SSID shown on the network connection report matches the label on your router or access point. Also make sure your SSID uses only ASCII characters and symbols, or your product cannot display the SSID correctly. • If you are trying to connect using the WPS push button method, make sure your router or access point supports it. • If you are using a network password, check the label on your router or access point to confirm that you are using the correct password, or check with your network administrator or router/access point documentation. • If you are connecting to a smart device that generates an SSID, check the device documentation for the SSID and password you should use. • If your wireless connection suddenly disconnects, and another smart device was added to the network using a WPS push button method or your network was set up using a non-WPS push button method, try downloading and installing your product software again.

Error code and message	Solution
<p>E5</p> <p>Security mode (e.g. WEP, WPA) does not match the current setting of the printer. Confirm security mode. Contact your network administrator for assistance.</p>	<p>If the security on your router or access point is not one of the following types, change the type of security on your router or access point and reset your product's network settings.</p> <ul style="list-style-type: none"> • WEP-64 bit (40 bit) • WEP-128 bit (104 bit) • WPA PSK (TKIP/AES); also known as WPA Personal • WPA2 PSK (TKIP/AES); also known as WPA2 Personal • WPA (TKIP/AES) • WPA2 (TKIP/AES) <p>Also make sure you are connecting to the 2.4GHz band on your network and using the password for that band.</p>
<p>E6</p> <p>MAC address of your printer may be filtered. Check whether your router/access point has restrictions such as MAC address filtering. See the documentation of the router/access point or contact your network administrator for assistance.</p>	<p>If your router or access point has MAC address filtering enabled, register your product's MAC address so it is not filtered. Locate the MAC address on the network connection report and check your router or access point documentation for instructions.</p> <p>If your router or access point is using shared authentication with WEP security, confirm that you are using the correct authentication key and index.</p> <p>If your router or access point limits the number of connected devices, raise the connection limit. See your router or access point documentation for instructions.</p>
<p>E8</p> <p>Incorrect IP address is assigned to the printer. Confirm IP address setup of the network device (hub, router, or access point). Contact your network administrator for assistance.</p>	<p>If your product's Obtain IP Address setting is set to Auto, enable DHCP on your router or access point. If it is set to Manual, the IP address may be out of range or on a different network segment; set a valid IP address using your product control panel or the Web Config utility.</p> <p>You can also try turning off your product and the router or access point, waiting about 10 seconds, and turning them on again.</p>

Error code and message	Solution
<p>E9</p> <p>Confirm the connection and network setup of the PC or other device. Connection using the EpsonNet Setup is available. Contact your network administrator for assistance.</p>	<p>Make sure your computer or network device are turned on. Also make sure that you can access the internet and other devices on the same network from the devices you are trying to connect to your product.</p> <p>If you still cannot connect to your product, turn off your router or access point, wait about 10 seconds, and turn it on again. Download and install your product software again to reset your network settings.</p>
<p>E10</p> <p>Confirm IP address, subnet mask, and default gateway setup. Connection using the EpsonNet Setup is available. Contact your network administrator for assistance.</p>	<p>Make sure other devices on the network are turned on and do the following:</p> <ul style="list-style-type: none"> • If your product's Obtain IP Address setting is set to Manual, check the IP address, subnet mask, and default gateway addresses on the network connection report to see if they are correct. If not, correct the settings. • If DHCP is enabled, set your product's Obtain IP Address setting to Auto. If you want to use the DHCP-assigned address as a static address, set the Obtain IP Address setting to Manual, enter the product's IP address as listed on the network connection report, and set the subnet mask to 255.255.255.0. <p>If you still cannot connect to your product, turn off your router or access point, wait about 10 seconds, and turn it on again.</p>
<p>E11</p> <p>Setup is incomplete. Confirm default gateway setup. Connection using the EpsonNet Setup is available. Contact your network administrator for assistance.</p>	<p>If you set your product's TCP/IP Setup setting to Manual, check that the default gateway address listed on the network connection report is correct. Also turn on the device that is set as the default gateway.</p>

Error code and message	Solution
<p>E12</p> <p>Confirm the following</p> <ul style="list-style-type: none"> -Entered security key/password is correct -Index of the security key/password is set to the first number -IP address, subnet mask, or default gateway setup is correct <p>Contact your network administrator for assistance.</p>	<p>Make sure other devices on the network are turned on and do the following:</p> <ul style="list-style-type: none"> • Make sure the IP address, subnet mask, and default gateway addresses are correct, if you are entering them manually. • Confirm that the subnet mask and default gateway addresses for other devices are the same. • Make sure the IP address does not conflict with other devices. <p>If you still cannot connect to your product, do the following:</p> <ul style="list-style-type: none"> • Turn off your router or access point, wait about 10 seconds, and turn it on again. • Download and install your product software again to reset your network settings. • If your router or access point uses WEP security with several registered passwords, make sure that the first registered password is set on your product.
<p>E13</p> <p>Confirm the following</p> <ul style="list-style-type: none"> -Entered security key/password is correct -Index of the security key/password is set to the first number -Connection and network setup of the PC or other device is correct <p>Contact your network administrator for assistance.</p>	<p>Make sure your router, access point, and/or hub are turned on. Also make sure the TCP/IP setup on your router, access point, and/or hub is not set manually; this may cause your product's network settings to differ from the manually set up devices.</p> <p>If you still cannot connect to your product, do the following:</p> <ul style="list-style-type: none"> • Turn off your router or access point, wait about 10 seconds, and turn it on again. • Download and install your product software again to reset your network settings. • If your router or access point uses WEP security with several registered passwords, make sure that the first registered password is set on your product.

Network Environment Messages

Message	Solution
The same SSID may be set on several access points.	Check the settings on your router and other access points to make sure each one uses a different SSID.
The Wi-Fi environment needs to be improved. Turn the wireless router off and then turn it on. If the connection does not improve, see the documentation for the wireless router.	Move your product closer to your router or access point, and remove any obstacles between them. Then turn off your router or access point, wait about 10 seconds, and turn it back on again. If you still cannot connect to your product, check the documentation that came with your router or access point for solutions.
*No more devices can be connected. Disconnect one of the connected devices if you want to add another one.	You can connect up to 8 computers or other devices to your product using a Wi-Fi Direct (Simple AP) connection. If you want to add another device, disconnect an existing connected device first.
The same SSID as Wi-Fi Direct exists in the environment. Change the Wi-Fi Direct SSID if you cannot connect a smart device to the printer.	Change the Wi-Fi Direct SSID.

Parent topic: [Printing a Network Connection Report](#)

Changing or Updating Network Connections

See these sections to change or update how your product connects to a network.

[Accessing the Web Config Utility](#)

[Changing a USB Connection to a Wi-Fi Connection](#)

[Connecting to a New Wi-Fi Router](#)

[Disabling Wi-Fi Features](#)

Parent topic: [Wi-Fi Networking](#)

Accessing the Web Config Utility

You can select your product's network settings and confirm its operating status using a web browser. You do this by accessing your product's built-in Web Config utility from a computer or other device that is connected to the same network as your product.

1. Print a network status sheet.

2. Locate the IP address for your product that is listed on the network status sheet.
3. On a computer or other device connected to the same network as your product, open a web browser.
4. Enter your product's IP address into the address bar.

You see the available Web Config utility options.

Parent topic: [Changing or Updating Network Connections](#)

Related tasks

[Printing a Network Status Sheet](#)

Changing a USB Connection to a Wi-Fi Connection

If you have already connected your product to your computer using a USB connection, you can change to a Wi-Fi connection.

1. Disconnect the USB cable from your product.
2. Uninstall your product software.
3. Download and install your product software from the Epson website using the instructions on the *Start Here* sheet.

Parent topic: [Changing or Updating Network Connections](#)

Related concepts

[Uninstall Your Product Software](#)

Connecting to a New Wi-Fi Router

If you change the wireless router you have been using on your network, you need to update your product's Wi-Fi connection to the new router.

Note: If you switch to a 5 GHz wireless router, set the router to operate in dual band (2.4 GHz and 5 GHz) mode. If your router uses a single network name (SSID) for both the 2.4 GHz and 5 GHz band, give each band its own network name (SSID) instead, such as Home Network 2.4 GHz and Home Network 5 GHz. See your router documentation for instructions.

1. Do one of the following:
 - **Windows:** Uninstall your product software.
 - **Mac:** Go to the next step.

2. Download and install your product software from the Epson website using the instructions on the *Start Here* sheet.

Parent topic: [Changing or Updating Network Connections](#)



Related concepts

[Uninstall Your Product Software](#)

Disabling Wi-Fi Features

You may need to disable your product's Wi-Fi features if you change your network connection type or need to solve a problem with your network connection.

Note: Before disabling Wi-Fi features, make a note of your product's SSID (network name) and password, and any network settings selected for the Epson Connect services you may use.

1. Press the  home button, if necessary.
2. Select the  icon.

You see a screen like this:

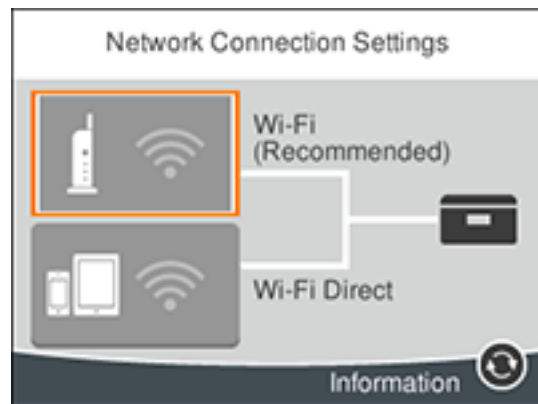

3. Select **Wi-Fi (Recommended)**.
4. Select **Change Settings**.
5. Select **Others**.
6. Select **Disable Wi-Fi**.

7. Select **Start Setup** to disable Wi-Fi.
8. When finished, press the  home button to return to the Home screen.

Parent topic: [Changing or Updating Network Connections](#)

Related tasks

[Printing a Network Status Sheet](#)

Loading Paper

Before you print, load paper for the type of printing you will do.

[Loading Paper in the Rear Paper Feed](#)

[Paper Loading Capacity](#)

[Turning Off the Paper Setting Alert](#)

[Double-sided Printing Capacity](#)

[Compatible Epson Papers](#)

[Borderless Paper Type Compatibility](#)

[Paper or Media Type Settings - Printing Software](#)

[Selecting the Paper Settings - Control Panel](#)

Loading Paper in the Rear Paper Feed

You can print documents and photos on a variety of paper types and sizes.

1. Flip the feeder guard forward and pull out the paper support.

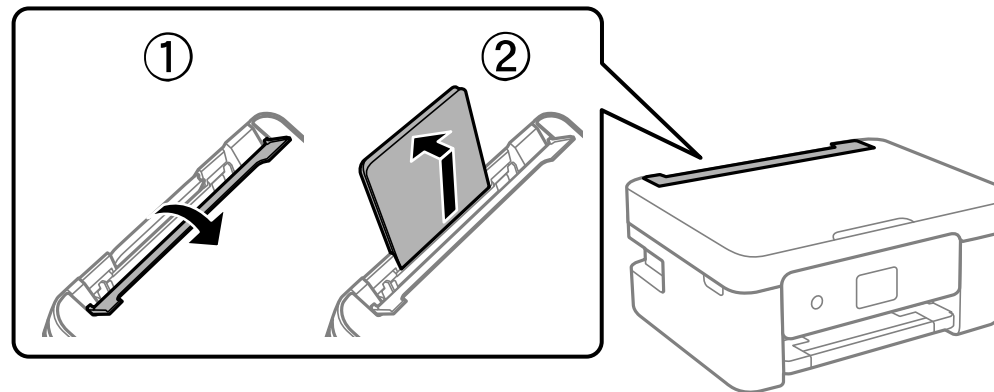

2. Pull out the output tray and open the paper stopper.

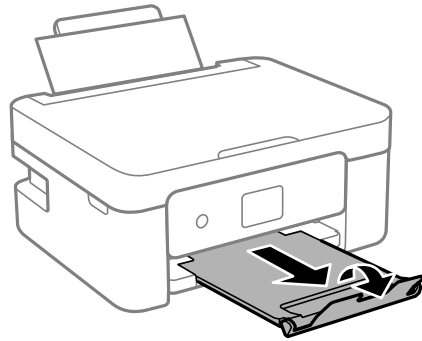

3. Slide the edge guides out all the way.

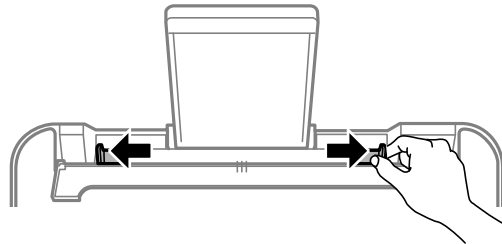

4. If you are inserting a stack of paper, fan the sheets first and tap the stack on a flat surface to even the edges.

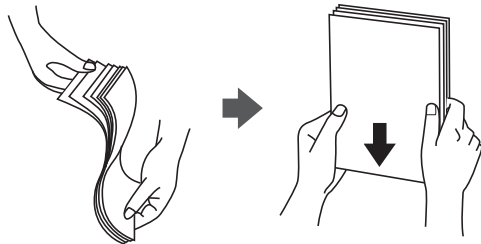

Note: Do not fan or curl photo paper.

5. Do one of the following:

- Insert paper, glossy or printable side up and short edge first, in the center of the paper support.

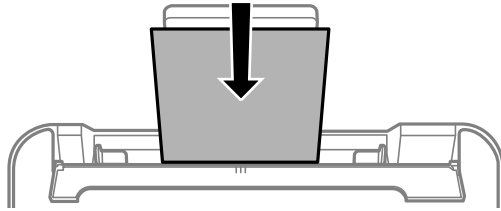

- Load up to 10 envelopes in the center of the paper support. Load them printable side up and flap edge left.



- Load a sheet of loose-leaf or other paper with holes facing as shown.

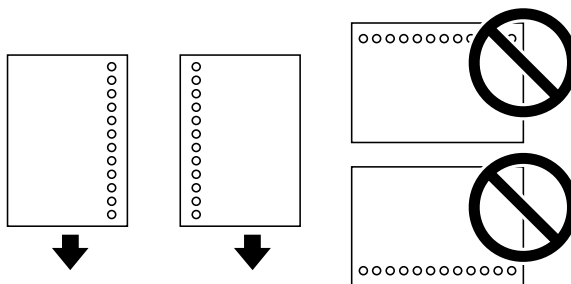

- To load a sheet of paper longer than legal size, close the paper support and flatten the leading edge of the paper as shown.

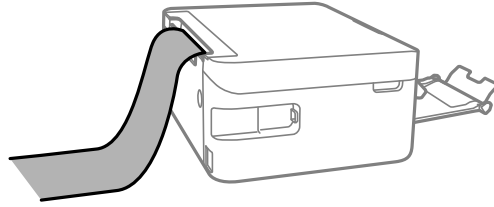

6. Slide the edge guides against the paper, but not too tightly.

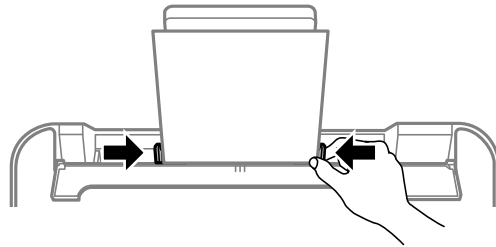

Always follow these paper loading guidelines:

- Load only the recommended number of sheets.
- Load paper short edge first, no matter which way your document faces.
- Load letterhead or pre-printed paper top edge first.
- Do not load paper above the arrow mark inside the edge guide.
- If you have trouble loading a stack of envelopes, press each envelope flat before loading it or load one envelope at a time.
- Do not load envelopes that are curled, folded, or too thin, or that have plastic windows or exposed adhesive flaps.
- Check the paper package for any additional loading instructions.
- If you use paper with binder holes, load only one sheet at a time in only these sizes: Letter (8.5 × 11 inches [216 × 279 mm]), A4 (8.3 × 11.7 inches [210 × 297 mm]), or Legal (8.5 × 14 inches [216 × 356 mm]).

Parent topic: [Loading Paper](#)

Related references

[Printable Area Specifications](#)

[Paper Specifications](#)

[Paper Loading Capacity](#)

Paper Loading Capacity

See the table here for the loading capacity of the rear paper feed.

Paper type	Loading capacity
Plain paper	Letter (8.5 × 11 inches [216 × 279 mm]) or A4 (8.3 × 11.7 inches [210 × 297 mm]) size or smaller: 100 sheets
Copy paper	
Letterhead	
	Legal (8.5 × 14 inches [216 × 356 mm]) size: 1 sheet
Epson Bright White Pro Paper	100 sheets
Epson Presentation Paper Matte	80 sheets
Epson Premium Presentation Paper Matte	20 sheets If paper feeds incorrectly, or printing is uneven or smeared, load 1 sheet at a time.
Epson Photo Paper Glossy	
Epson Premium Photo Paper Glossy	
Epson Ultra Premium Photo Paper Glossy	
Epson Premium Photo Paper Semi-gloss	
Epson Premium Presentation Paper Matte Double-sided	1 sheet
Epson Photo Quality Self-adhesive Sheets	
Envelopes	10 envelopes

Parent topic: [Loading Paper](#)

Turning Off the Paper Setting Alert

The paper setting alert warns you when the paper settings do not match the paper you loaded. You can turn off this feature from the product's control panel.

Note: You cannot turn on this setting if the **Paper Configuration** setting is disabled.

1. Press the  home button, if necessary.
2. Select **Settings**.
3. Select **Guide Functions**.

You see a screen like this:

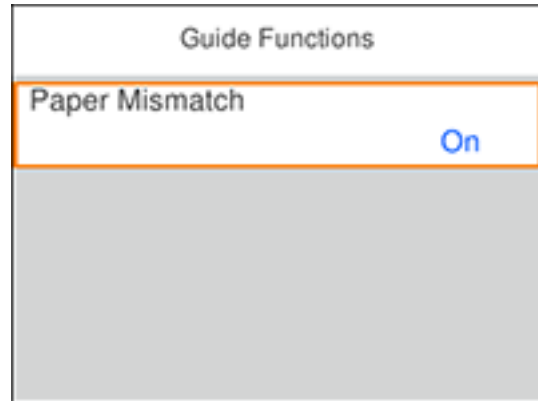

4. Select **Paper Mismatch**.
5. Set the **Paper Mismatch** setting to **Off**.

Parent topic: [Loading Paper](#)

Related tasks

[Selecting the Paper Settings - Control Panel](#)

Double-sided Printing Capacity

You can print double-sided using Auto or Manual mode on the paper types and sizes listed here.

Paper type	Size	Double-sided printing capacity	
		Auto	Manual
Plain paper Copy paper	Letter (8.5 × 11 inches [216 × 279 mm]) or A4 (8.3 × 11.7 inches [210 × 297 mm]) size or smaller	100 sheets	30 sheets
	Legal (8.5 × 14 inches [216 × 356 mm])	—	1 sheet
Epson Bright White Pro Paper	Letter (8.5 × 11 inches [216 × 279 mm])	100 sheets	30 sheets

You cannot print double-sided on the following paper types:

- Epson Presentation Paper Matte
- Epson Premium Presentation Paper Matte
- Epson Premium Presentation Paper Matte Double-sided
- Epson Ultra Premium Presentation Paper MatteEpson Photo Paper Glossy
- Epson Premium Photo Paper Glossy
- Epson Premium Photo Paper Semi-gloss
- Epson Ultra Premium Photo Paper Glossy
- Epson Photo Quality Self-adhesive Sheets
- Letterhead
- Envelopes

Parent topic: [Loading Paper](#)

Compatible Epson Papers

You can purchase genuine Epson ink, maintenance boxes, and paper at epson.com (U.S. sales), epson.ca (Canadian sales), or epson.com.jm (Caribbean sales). You can also purchase supplies from an Epson authorized reseller. To find the nearest one, call 800-GO-EPSON (800-463-7766) in the U.S. or 800-807-7766 in Canada.

Paper Type	Size	Part number	Sheet count
Epson Bright White Pro Paper	Letter (8.5 × 11 inches [216 × 279 mm])	S041586	500
Epson Presentation Paper Matte	Letter (8.5 × 11 inches [216 × 279 mm])	S041062	100
	Legal (8.5 × 14 inches [216 × 356 mm])	S041067	100
Epson Premium Presentation Paper Matte	8 × 10 inches (203 × 254 mm)	S041467	50
	Letter (8.5 × 11 inches [216 × 279 mm])	S041257 S042180	50 100
Epson Premium Presentation Paper Matte Double-sided	Letter (8.5 × 11 inches [216 × 279 mm])	S041568	50
Epson Photo Paper Glossy	4 × 6 inches (102 × 152 mm)	S041809 S042038	50 100
	Letter (8.5 × 11 inches [216 × 279 mm])	S041141 S041649 S041271	20 50 100
Epson Premium Photo Paper Glossy	4 × 6 inches (102 × 152 mm)	S041727	100
	16:9 wide (4 × 7.1 inches [102 × 181 mm])	S042109	20
	5 × 7 inches (127 × 178 mm)	S041464	20
	8 × 10 inches (203 × 254 mm)	S041465	20
	Letter (8.5 × 11 inches [216 × 279 mm])	S042183 S041667	25 50

Paper Type	Size	Part number	Sheet count
Epson Ultra Premium Photo Paper Glossy	4 × 6 inches (102 × 152 mm)	S042181	60
		S042174	100
	5 × 7 inches (127 × 178 mm)	S041945	20
	8 × 10 inches (203 × 254 mm)	S041946	20
Letter (8.5 × 11 inches [216 × 279 mm])		S042182	25
		S042175	50
Epson Premium Photo Paper Semi-gloss	4 × 6 inches (102 × 152 mm)	S041982	40
	Letter (8.5 × 11 inches [216 × 279 mm])	S041331	20
Epson Photo Quality Self-adhesive Sheets	Letter (8.5 × 11 inches [216 × 279 mm])	S041106	10

Parent topic: [Loading Paper](#)

Borderless Paper Type Compatibility

You can print borderless photos on compatible paper types in compatible sizes:

Borderless Paper Types

- Epson Bright White Pro Paper
- Epson Photo Paper Glossy
- Epson Premium Photo Paper Glossy
- Epson Ultra Premium Photo Paper Glossy
- Epson Premium Photo Paper Semi-gloss
- Epson Presentation Paper Matte
- Epson Premium Presentation Paper Matte
- Epson Premium Presentation Paper Matte Double-sided

Borderless Paper Sizes

- 4 × 6 inches (102 × 152 mm)
- 5 × 7 inches (127 × 178 mm)

- 8 × 10 inches (203 × 254 mm)
- 16:9 wide (4 × 7.1 inches [102 × 181 mm])
- A4 (8.3 × 11.7 inches [210 × 297 mm])
- Letter (8.5 × 11 inches [216 × 279 mm])

Parent topic: [Loading Paper](#)

Paper or Media Type Settings - Printing Software

For this paper	Select this paper Type or Media Type setting
Plain paper Epson Bright White Pro Paper Epson Photo Quality Self-adhesive Sheets	Plain Paper / Bright White Paper
Envelopes	Envelope
Epson Ultra Premium Photo Paper Glossy	Ultra Premium Photo Paper Glossy
Epson Premium Photo Paper Glossy	Premium Photo Paper Glossy
Epson Photo Paper Glossy	Photo Paper Glossy
Epson Premium Photo Paper Semi-gloss	Premium Photo Paper Semi-Gloss
Epson Presentation Paper Matte	Presentation Paper Matte
Epson Premium Presentation Paper Matte Epson Premium Presentation Paper Matte Double-sided	Premium Presentation Paper Matte

Note: The settings listed here are available only when printing from your computer; they do not apply to your product's control panel settings.

Parent topic: [Loading Paper](#)

Related references

[Paper Type Settings - Control Panel](#)

Selecting the Paper Settings - Control Panel

You can change the default paper size and paper type using the control panel on the product.

1. Press the  home button, if necessary.
2. Select **Settings** > **Printer Settings** > **Paper Source Settings**.

You see a screen like this:

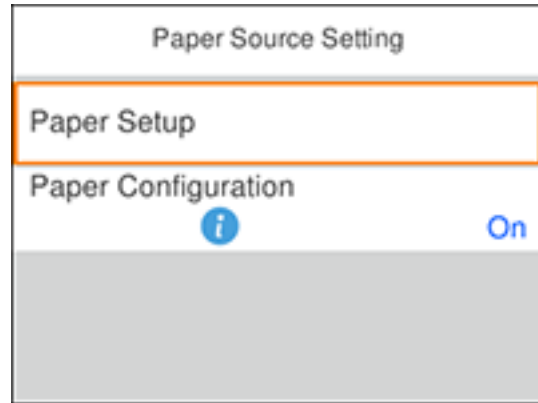

3. Make sure the **Paper Configuration** setting is set to **On**.

Note: Disabling this feature turns off the automatic display of the paper settings selection screen after you load paper in the cassette. If this setting is disabled, you cannot use AirPrint and you cannot turn on the **Paper Mismatch** setting.

4. Select **Paper Setup**.

You see a screen like this:

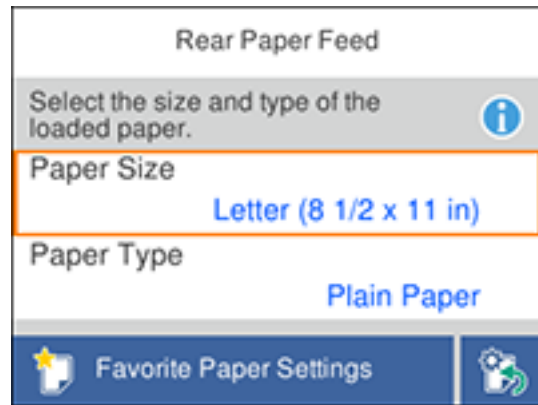

5. Do one of the following to select your paper settings:

- Select a **Paper Size** and **Paper Type** setting.
- Select **Favorite Paper Settings** to select from a list of saved presets.

Note: You can change your preset settings by highlighting a preset and pressing the right arrow button.

- Select the  icon to change back to your previous paper settings.

[Paper Type Settings - Control Panel](#)

Parent topic: [Loading Paper](#)

Paper Type Settings - Control Panel

Select a **Paper Type** setting that matches the paper you loaded.

Paper type loaded	Paper Type setting
Plain paper	Plain Paper
Epson Bright White Pro Paper	
Epson Photo Quality Self-adhesive Sheets	
Envelopes	Envelope

Paper type loaded	Paper Type setting
Epson Ultra Premium Photo Paper Glossy	Ultra Glossy
Epson Premium Photo Paper Glossy	Prem. Glossy
Epson Photo Paper Glossy	Glossy
Epson Premium Photo Paper Semi-gloss	Prem. Semi-Gloss
Epson Presentation Paper Matte	Presentation Matte
Epson Ultra Premium Presentation Paper Matte Epson Premium Presentation Paper Matte Double-sided	Prem. Matte

Parent topic: [Selecting the Paper Settings - Control Panel](#)

Related tasks

[Turning Off the Paper Setting Alert](#)

Placing Originals on the Product

Follow the instructions here to place your original documents or photos on the product.

Caution: Do not place anything on top of your product or use its cover as a writing surface to avoid damaging it.

[Placing Originals on the Scanner Glass](#)

Placing Originals on the Scanner Glass

You can place originals up to this size on the scanner glass: Letter (8.5 × 11 inches [216 × 279 mm]) or A4 (8.3 × 11.7 inches [210 × 297 mm]).

1. Open the document cover.

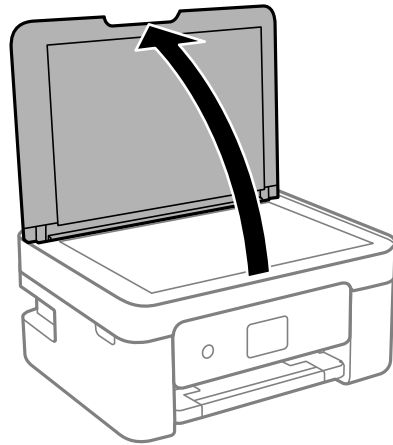

2. Do one of the following to place your originals:

- **Single sheet:** Place your original facedown on the scanner glass with the top facing into the corner. Slide the original to the edges of the indicated corner.

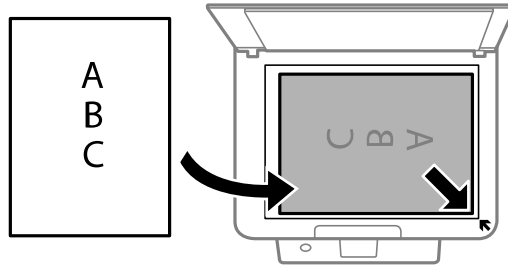

Note: The area about 0.06 inch (1.5 mm) from the edges of the scanner glass is not scanned.

- **ID card:** Place an ID card 0.2 inch (5 mm) away from the corner of the scanner glass as shown.

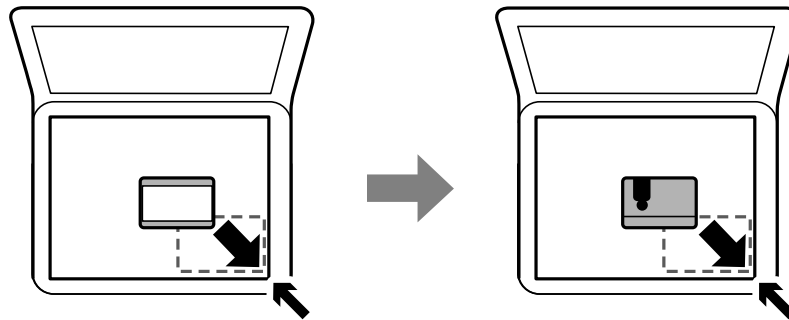

- **Multiple photos for copying:** You can place multiple photos of different sizes on the scanner glass to make separate copies. Make sure your photos are at least 0.2 inch (5 mm) away from

each other and from the corner of the scanner glass. You can place multiple photos up to this size: 4 × 6 inches (102 × 152 mm).

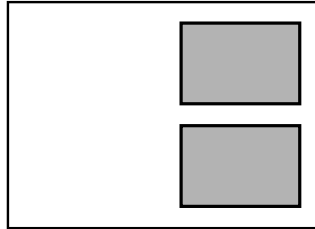

- **Multiple photos for scanning:** You can place multiple photos of different sizes on the scanner glass and save them separately using Photo Mode in Epson Scan 2. Make sure your photos are at least 0.6 inch × 0.6 inch (15 × 15 mm) in size, and placed away from each other and from the edges of the scanner glass as shown.

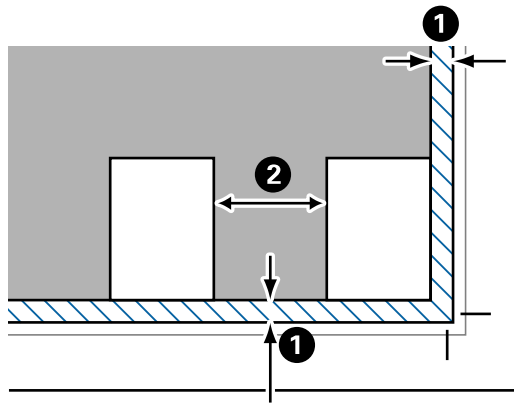

- 1 0.2 inch (4.5 mm)
- 2 0.8 inch (20 mm)

Note: To view multiple scanned photos in Epson Scan 2, select the **Thumbnail** checkbox in the preview window.

3. Close the document cover gently to keep your original in place.

Caution: Do not push down on the document cover or scanner glass or you may damage the product.

Remove your originals after scanning. If you leave the originals on the scanner glass for a long time, they may stick to the glass surface.

Parent topic: [Placing Originals on the Product](#)

Related tasks

[Scanning in Epson Scan 2](#)

Copying

See the information here to copy documents or photos using your product.

Note: Copies may not be exactly the same size as your originals.

[Copying Documents or Photos](#)

[Copying Restored Photos](#)

[Copying Books, ID Cards, or Borderless Photos](#)

[Copying Options](#)

Copying Documents or Photos

You can copy documents or photos onto various sizes and types of paper, including Epson special papers.

1. Place your original document or photo on the scanner glass.
2. Load the paper you want to print on.
3. Press the  home button, if necessary.
4. Select **Copy**.

You see a screen like this:

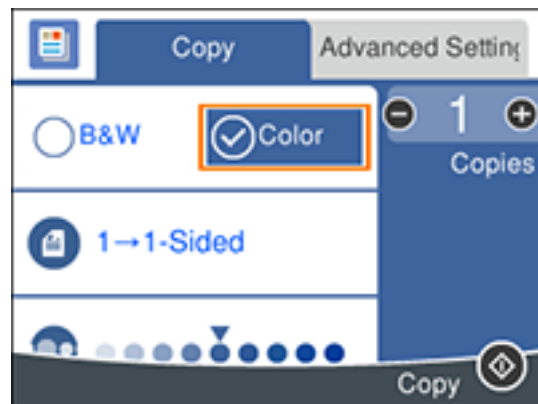

5. To print more than one copy, press the **+** or **–** buttons to increase or decrease the number of copies.

Note: You can also select **Copies** and use the displayed numeric keypad to select the number of copies (up to 99).

6. Change any of the displayed settings as necessary.
7. Select the **Advanced Settings** tab to view and change additional copy settings, if necessary.
8. When you are ready to copy, press the  start button.

Note: To cancel printing, press the  stop button.

Parent topic: [Copying](#)

Related references

[Copying Options](#)

Related tasks

[Placing Originals on the Scanner Glass](#)



Copying Restored Photos

You can restore the colors in faded photos as you make copies of them.

1. Place your original photo on the scanner glass.
2. Load the paper you want to print on.
3. Press the  home button, if necessary.
4. Select **Various prints**.
5. Select **Various copies**.

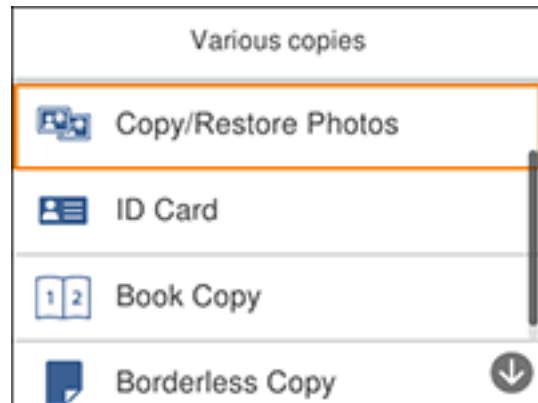
You see a screen like this:



6. Select **Copy/Restore Photos**.
7. Make sure the **Restore Color** setting is set to **On**.
8. Select your other paper and print settings as necessary, then press the right arrow button.
9. Select **Start Scanning**.
Your originals are scanned and a preview appears on the LCD screen.
10. If you need to edit the copy, press the  reset button and change any of these settings as necessary:
 - **Crop/Zoom**: Zoom in and enlarge a part of the photo and crop it.
 - **Clear Edit**: Resets your photo edits.
11. To print more than one copy, press the **+** or **-** buttons to increase or decrease the number of copies.
Note: You can also select **Copies** and use the displayed numeric keypad to select the number of copies (up to 99).
12. When you are ready to copy, press the  start button.

Note: To cancel copying, press the  stop button.

Parent topic: [Copying](#)

Related references

[Copying Options](#)

Related tasks

[Placing Originals on the Scanner Glass](#)

Copying Books, ID Cards, or Borderless Photos

You can copy two pages of a book or both sides of an ID card onto a single sheet of paper. You can also copy a photo and print it without any borders.

1. Place your original on the scanner glass.
2. Load the paper you want to print on.
3. Press the  home button, if necessary.
4. Select **Various prints**.
5. Select **Various copies**.

You see a screen like this:

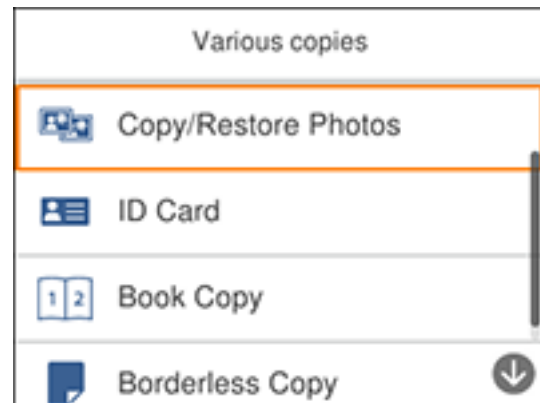

6. Select one of these options:
 - **ID Card** to scan and copy both sides of an ID card onto one side of paper.
 - **Book Copy** to copy two facing pages of a book onto a single sheet of paper.

Note: Make sure the first page of your original is placed on the scanner glass as described on the LCD screen and press the **OK** button.

- **Borderless Copy** to make a copy without margins around the edges.

7. To print more than one copy, press the **+** or **-** buttons to increase or decrease the number of copies.

Note: You can also select **Copies** and use the displayed numeric keypad to select the number of copies (up to 99).

8. Change any of the displayed settings as necessary.

9. Select the **Advanced Settings** tab to view and change additional copy settings, if necessary.

10. When you are ready to copy, press the **◇** start button.

Note: To cancel copying, press the **⏏** stop button.

11. Follow any on-screen instructions to place the rest of your originals and select **Start Scanning**.

Parent topic: [Copying](#)

Related references

[Copying Options](#)

Related tasks

[Placing Originals on the Scanner Glass](#)

Copying Options

Select the copying options you want to use for your copies.

Note: Not all options or settings may be available, depending on other copying settings.

Copy

Copying option	Available settings	Description
Color mode	B&W	Select whether to copy the original in color or black and white
	Color	

Copying option	Available settings	Description
2-Sided	1>1-Sided	Select to make 2-sided copies. When you select 1>2-Sided , scroll down and also select the orientation and binding edge for your originals or copies.
	1>2-Sided	
Density selector	Varying levels	Adjusts the lightness or darkness of copies

Advanced Settings

Copying option	Available settings	Description
Reduce/Enlarge	Actual Size	Copies the original at its full size or 100% magnification
	Auto Fit Page	Automatically sizes the image to fit the paper size you selected
	5×7in>Letter and other conversions	Automatically converts from one size to another
Paper Setting	Various settings	Selects the paper size and paper type
Multi-Page	Single Page	Copies each page of the original onto an individual sheet
	2-up	Copies 2 page documents onto one sheet. Scroll down and select the document orientation and layout order settings as necessary.
Quality	Draft	Adjusts the quality of your copies
	Standard	
	Best	

Parent topic: [Copying](#)

Printing from a Computer

Before printing from your computer, make sure you have set up your product and installed its software as described on the *Start Here* sheet.

Note: If you have an Internet connection, it is a good idea to check for updates to your product software on Epson's support website. If you see a Software Update screen, select **Enable automatic checking** and click **OK**. The update scans your system to see if you have the latest product software. Follow the on-screen instructions.

[Printing with Windows](#)

[Printing with the Built-in Epson Driver - Windows 10 S](#)

[Printing on a Mac](#)

[Printing From a Chromebook](#)

[Cancelling Printing Using a Product Button](#)

Related tasks

[Checking for Software Updates](#)

Printing with Windows

You can print with your product using any Windows application, as described in these sections.

Note: If you are using your Epson product with the Windows 10 S operating system, you cannot use the software described in this section. You also cannot download and install any Epson product software from the Epson website for use with Windows 10 S; you must obtain software only from the Windows Store.

[Selecting Basic Print Settings - Windows](#)

[Selecting Double-sided Printing Settings - Windows](#)

[Selecting Additional Layout and Print Options - Windows](#)

[Selecting a Printing Preset - Windows](#)

[Selecting Extended Settings - Windows](#)

[Printing Your Document or Photo - Windows](#)

[Selecting Default Print Settings - Windows](#)

[Changing Automatic Update Options](#)

Parent topic: [Printing from a Computer](#)

Selecting Basic Print Settings - Windows

Select the basic settings for the document or photo you want to print.

1. Open a photo or document for printing.
2. Select the print command in your application.

Note: You may need to select a print icon on your screen, the **Print** option in the **File** menu, or another command. See your application's help utility for details.

3. If necessary, select your product name as the printer you want to use.

Note: You may also need to select **Properties** or **Preferences** to view your print settings.

You see the Main tab of your printer settings window:

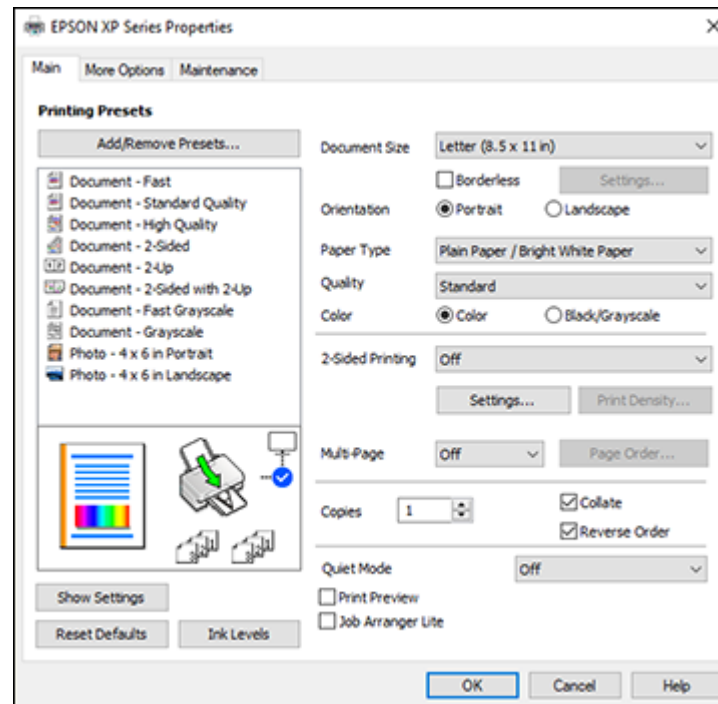

4. Select the size of the paper you loaded as the **Document Size** setting.

Note: You can also select the **User-Defined** setting to create a custom paper size, but you cannot use the **Borderless** setting.

5. If you are printing a borderless photo, select **Borderless**. You can click **Settings** to access additional options for borderless printing.

Note: You must select a compatible borderless paper type and size to print without borders. Check the borderless paper compatibility list for details.

6. Select the orientation of your document.

Note: If you are printing an envelope, select **Landscape**.

7. Select the type of paper you loaded as the **Paper Type** setting.

Note: The setting may not exactly match the name of your paper. Check the paper type settings list for details.

8. Select the **Quality** setting that matches the print quality you want to use.

9. Select a Color option:

- To print a color document or photo, select the **Color** setting.
- To print text and graphics in black or shades of gray, select the **Black/Grayscale** setting.

10. To print on both sides of the paper, select a **2-Sided Printing** option.

11. To print multiple pages on one sheet of paper, or print one image on multiple sheets of paper, select one of the settings in the **Multi-Page** menu and select the printing options you want.

12. To print multiple copies and arrange their print order, select the **Copies** options.

13. To reduce noise during printing when you select **Plain Paper/Bright White Paper**, turn on **Quiet Mode** (printing will be slower).

14. To preview your job before printing, select **Print Preview**.

15. To save your print job as a project that can be modified and combined with other print jobs, select **Job Arranger Lite**.

[Print Quality Options - Windows](#)

[Multi-Page Printing Options - Windows](#)

Parent topic: [Printing with Windows](#)

Related references

[Paper or Media Type Settings - Printing Software](#)

Related tasks

[Selecting Double-sided Printing Settings - Windows](#)

[Selecting Additional Layout and Print Options - Windows](#)

[Printing Your Document or Photo - Windows](#)

Print Quality Options - Windows

You can select any of the available Quality options to fine-tune the quality of your print. Some settings may be unavailable, depending on the paper type and border setting you have chosen.

Draft

For draft printing on plain paper.

Standard

For everyday text and image printing.

Standard - Vivid

For text and graphics with good quality and print speed.

High

For photos and graphics with high print quality.

More Settings

Opens a window that lets you choose among levels of speed and quality.

Parent topic: [Selecting Basic Print Settings - Windows](#)

Multi-Page Printing Options - Windows

You can select any of the available options in the Multi-Page menu to set up your multi-page print job.

2-Up and 4-Up

Prints 2 or 4 pages on one sheet of paper. Click the **Page Order** button to select page layout and border options.

2×1 Poster, 2×2 Poster, 3×3 Poster, 4×4 Poster

Prints one image on multiple sheets of paper to create a larger poster. Click the **Settings** button to select image layout and guideline options.

Parent topic: [Selecting Basic Print Settings - Windows](#)

Selecting Double-sided Printing Settings - Windows

You can print on both sides of the paper by selecting one of the **2-Sided Printing** options on the **Main** tab.

Note: Some options may be pre-selected or unavailable, depending on other settings you have chosen or if you are accessing the product over a network.

1. Select one of the following options for **2-Sided Printing**:
 - **Auto (Long-edge binding)** to print your double-sided print job by automatically flipping the paper on the long edge.
 - **Auto (Short-edge binding)** to print your double-sided print job by automatically flipping the paper on the short edge.
 - **Manual (Long-edge binding)** to print your double-sided print job by printing one side and prompting you to flip the paper over on the long edge to print the other side (recommended for paper types that do not support automatic duplexing).
 - **Manual (Short-edge binding)** to print your double-sided print job by printing one side and prompting you to flip the paper over on the short edge to print the other side (recommended for paper types that do not support automatic duplexing).
2. Click the **Settings** button.

You see this window:

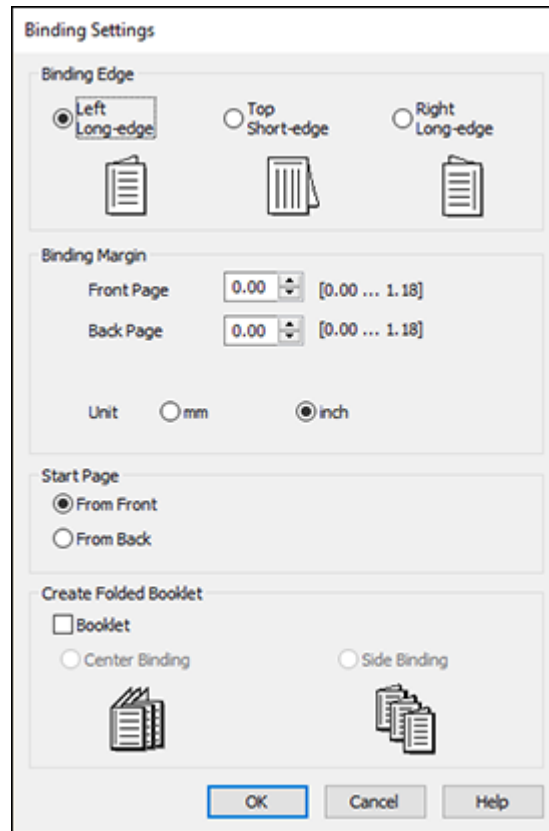

3. Select the double-sided printing options you want to use.
4. Click **OK** to return to the **Main** tab.
5. Click the **Print Density** button.

You see this window:

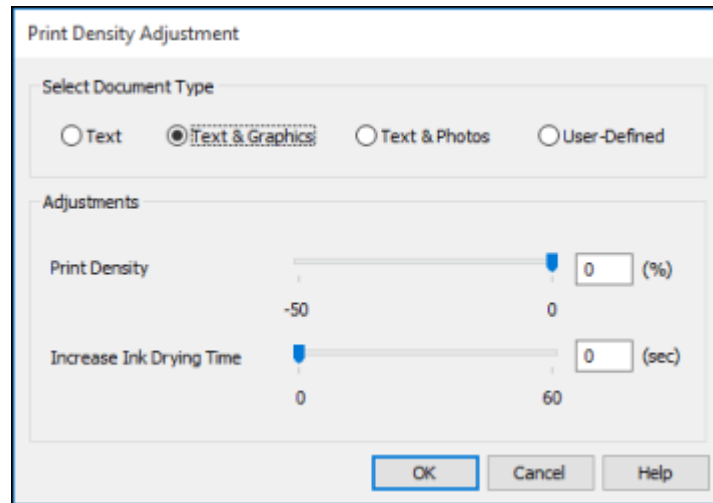

6. Select the type of document you are printing as the Document Type setting. The software automatically sets the **Adjustments** options for that document type.
7. If necessary, select the **Adjustments** options you want to use.
8. Click **OK** to return to the **Main** tab.
9. Print a test copy of your double-sided document to test the selected settings.
10. Follow any instructions displayed on the screen during printing.

[Double-sided Printing Options - Windows](#)

[Print Density Adjustments - Windows](#)

Parent topic: [Printing with Windows](#)

Related tasks

[Selecting Basic Print Settings - Windows](#)

Double-sided Printing Options - Windows

You can select any of the available options on the 2-Sided Printing Settings window to set up your double-sided print job.

Binding Edge Options

Select a setting that orients double-sided print binding in the desired direction.

Binding Margin Options

Select options that define a wider margin to allow for binding.

Start Page

Selects whether printing starts on the front or back page.

Create Folded Booklet Options

Select the **Booklet** checkbox and a binding option to print double-sided pages as a booklet.

Parent topic: [Selecting Double-sided Printing Settings - Windows](#)

Print Density Adjustments - Windows

You can select any of the available options on the Print Density Adjustment window to adjust the print quality of your double-sided print job.

Print Density

Sets the level of ink coverage for double-sided printing.

Increase Ink Drying Time

Sets the amount of time required for drying ink after printing on one side of the paper before printing the other side in double-sided printing to prevent ink smearing.

Parent topic: [Selecting Double-sided Printing Settings - Windows](#)

Selecting Additional Layout and Print Options - Windows

You can select a variety of additional layout and printing options for your document or photo on the **More Options** tab.

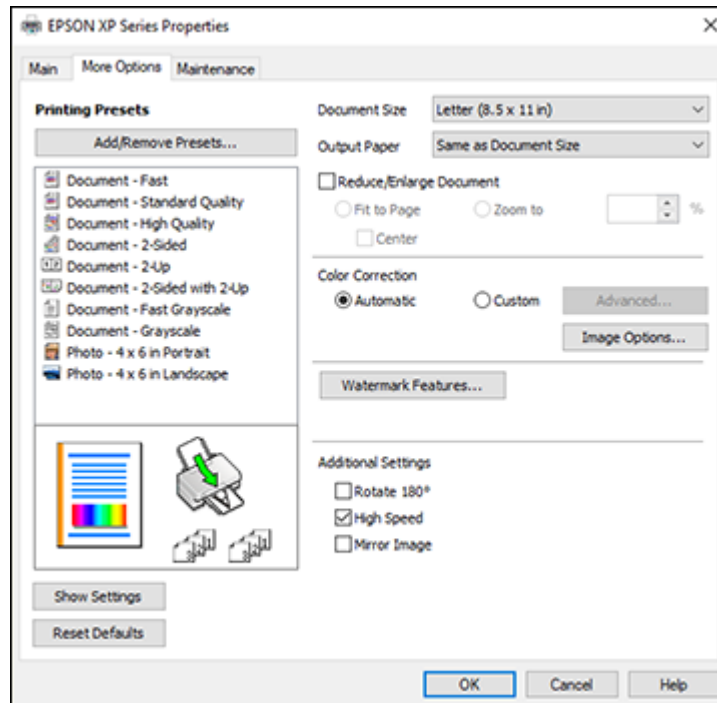

1. To change the size of your printed document or photo, select the **Reduce/Enlarge Document** checkbox and select one of these sizing options:
 - Select the **Fit to Page** option to size your image to fit the paper you loaded. Select the size of your document or photo as the **Document Size** setting, and the size of your paper as the **Output Paper** setting. If you want to center your image on the paper, select the **Center** option.
 - Select the **Zoom to** option to reduce or enlarge your document or photo by a specific percentage. Select the percentage in the % menu.
2. Select one of the following Color Correction options:
 - Select **Automatic** to automatically adjust the sharpness, brightness, contrast, and color saturation for your image.

- Select **Custom** and click the **Advanced** button to manually adjust the color correction settings or turn off color management in your printer software.
 - Select **Image Options** to access additional settings for improving printed images.
3. To add the following features, click the **Watermark Features** button:
- **Watermark**: adds a visible watermark to your printout
 - **Header/Footer**: adds information such as the date and time to the top or bottom of your printout

Note: Click the **Settings** button to customize the text and location of the header or footer.

4. Select any of the Additional Settings options to customize your print.

[Custom Color Correction Options - Windows](#)

[Image Options and Additional Settings - Windows](#)

[Header/Footer Settings - Windows](#)

Parent topic: [Printing with Windows](#)

Related tasks

[Selecting Basic Print Settings - Windows](#)

Custom Color Correction Options - Windows

You can select any of the available options in the Color Correction window to customize the image colors for your print job.

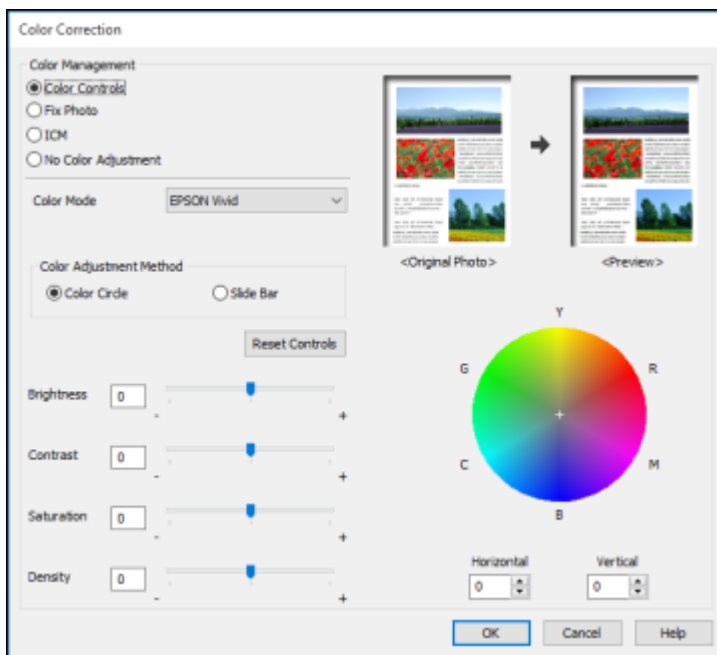

Color Controls

Lets you select a **Color Mode** setting, individual settings for **Brightness**, **Contrast**, **Saturation**, and **Density**, and individual color tones. Depending on the selected color mode, you can also adjust the midtone density using the **Gamma** setting.

Fix Photo

Improves the color, contrast, and sharpness of flawed photos.

Note: Fix Photo uses a sophisticated face recognition technology to optimize photos that include faces. For this to work, both eyes and the nose must be visible in the subject's face. If your photo includes a face with an intentional color cast, such as a statue, you may want to turn off **Fix Photo** to retain the special color effects.

ICM

Lets you manage color using installed color printing profiles.

No Color Adjustment

Turns off color management in your printer software so you can manage color using only your application software.

Parent topic: [Selecting Additional Layout and Print Options - Windows](#)

Image Options and Additional Settings - Windows

You can select any of the Image Options and Additional Settings to customize your print. Some options may be pre-selected or unavailable, depending on other settings you have chosen.

Image Options**Emphasize Text**

Adjusts the weight of printed text to increase readability.

Emphasize Thin Lines

Adjusts the weight of printed lines to increase visibility.

Edge Smoothing

Smooths jagged edges in low-resolution images such as screen captures or images from the Web.

Fix Red-Eye

Reduces or removes red-eye in photos.

Print Text in Black

Prints colored text in black.

For Color Text

Prints colored text on a background pattern or underlined.

For Color Graphs and Images

Prints colored graphics and images with overlay patterns.

For Color Text, Graphs, and Images

Prints colored text, graphics, and images with overlay patterns.

Enhancement Options

Specifies Color Universal Print enhancement settings for text, graphics, and images.

Additional Settings Options**Rotate 180°**

Prints the image rotated 180° from its original orientation.

High Speed

Speeds up printing but may reduce print quality.

Mirror Image

Flips the printed image left to right.

Parent topic: [Selecting Additional Layout and Print Options - Windows](#)

Header/Footer Settings - Windows

You can select any of the Header/Footer Settings options to add headers or footers when you print. The items are available to print at the top or bottom of your pages, in either the left, right, or center of the page.

Note: These settings are not saved with your document.

Top Left	Top Center	Top Right
User Name	None	Date/Time
Bottom Left	Bottom Center	Bottom Right
None	None	None

Reset Defaults OK Cancel Help

You can select to print the following information:

- User Name
- Computer Name
- Date
- Date/Time
- Collate Number (copy number)

Note: The user name, computer name, date, and time come from the Windows Control Panel on your computer.

Parent topic: [Selecting Additional Layout and Print Options - Windows](#)

Selecting a Printing Preset - Windows

For quick access to common groups of print settings, you can select a printing preset on the **Main** or **More Options** tab.

Note: You can create your own preset by clicking the **Add/Remove Presets** button.

1. Click the **Main** or **More Options** tab.

You see the available **Printing Presets** on the left:

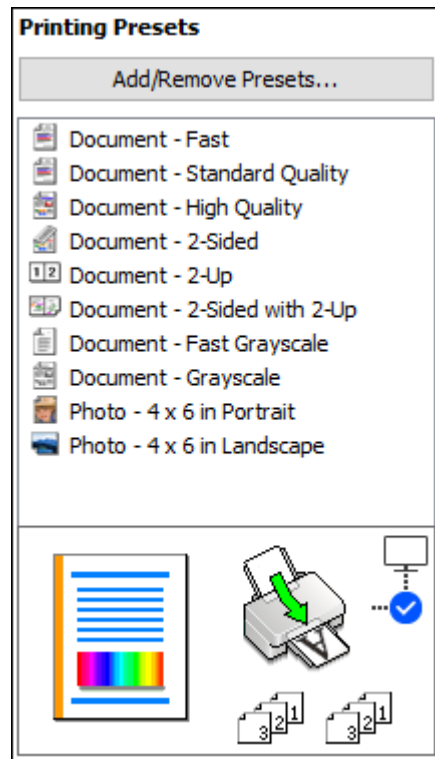



2. Place your cursor over one of the **Printing Presets** to view its list of settings.
3. Click on a preset to change its settings, or use any of the available options on the screen to control your printing presets.
4. To choose a preset for printing, select it.

5. Click **OK**.

Parent topic: [Printing with Windows](#)

Selecting Extended Settings - Windows

You can select additional settings that apply to all the print jobs you send to your product.

1. Access the Windows Desktop and right-click the  icon for your product in the right side of the Windows taskbar, or click the up arrow and right-click .
2. Select **Printer Settings**.
3. Click the **Maintenance** tab.

You see the maintenance options:

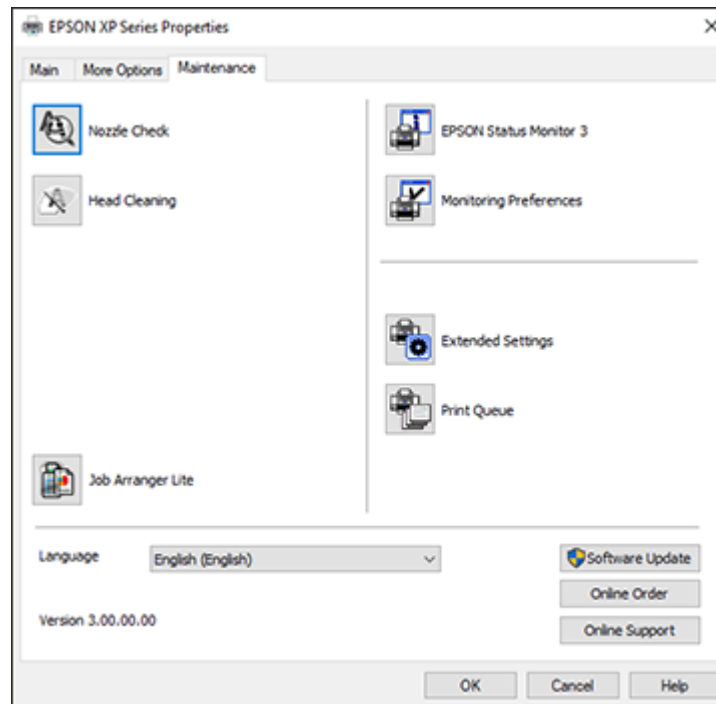

4. Click the **Extended Settings** button.

You see this window:

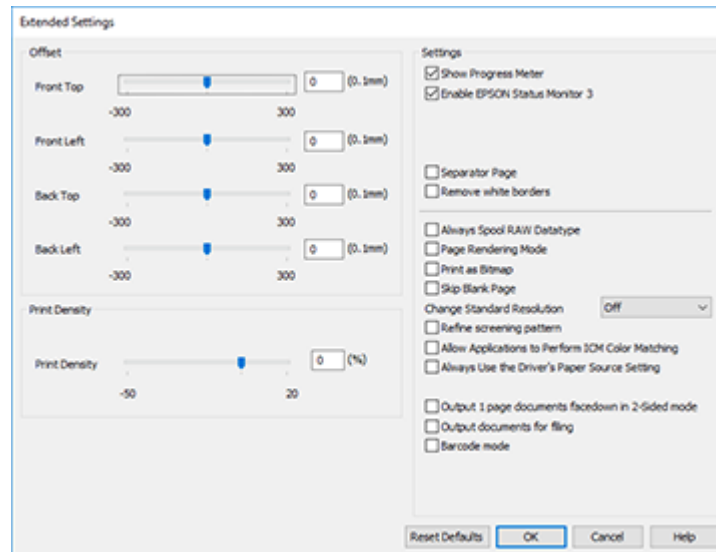

5. Select any of the extended settings to customize your print.
6. Click **OK** to close the Extended Settings window.
7. Click **OK** to close the printer software window.

[Extended Settings - Windows](#)

Parent topic: [Printing with Windows](#)

Extended Settings - Windows

You can select from these settings on the Extended Settings window.

Show Progress Meter

Displays the progress of print jobs as they are being printed.

Enable EPSON Status Monitor 3

Enables product monitoring for ink and paper supplies and other issues.

Separator Page

Before each document, prints a separator page containing the title, user, date, and time.

Remove white borders

Removes white margins that may appear when you print borderless photos.

Always Spool RAW Datatype

Increases print speed and may solve other printing problems.

Page Rendering Mode

Increases print speed when printing is extremely slow or the print head stops during printing.

Print as Bitmap

Increases print speed when printing is extremely slow or the print head stops during printing, and other settings do not help.

Skip Blank Page

Ensures that your product does not print pages that contain no text or images.

Change Standard Resolution

Reduces the resolution of print data to correct printing problems.

Refine screening pattern

Prints graphics with a finer screening pattern.

Allow Applications to Perform ICM Color Matching

Allows applications to perform ICM color matching.

Always Use the Driver's Paper Source Setting

Prints using the paper source setting in the printer driver, rather than the setting in your application.

Output 1 page documents facedown in 2-Sided mode

Outputs single-sided pages in a 2-sided print job facedown instead of faceup.

Output documents for filing

Outputs all landscape, portrait, 1-sided, and 2-sided documents in the same orientation for easier filing.

Barcode mode

Reduces bleeding when printing barcodes on plain paper, letterhead paper, recycled paper, preprinted paper, envelopes, and thick paper.

Parent topic: [Selecting Extended Settings - Windows](#)

Printing Your Document or Photo - Windows

Once you have selected your print settings, you are ready to save your settings and print.

1. Click **OK** to save your settings.

You see your application's Print window, such as this one:

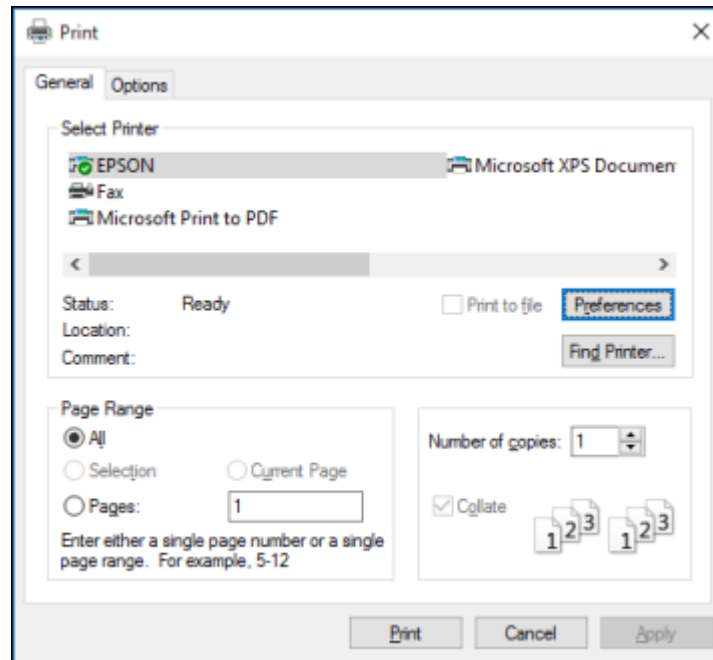

2. Click **OK** or **Print** to start printing.

[Checking Print Status - Windows](#)

Parent topic: [Printing with Windows](#)

Related tasks

[Selecting Basic Print Settings - Windows](#)

Checking Print Status - Windows

During printing, you see this window showing the progress of your print job. It allows you to control printing and check ink cartridge status.

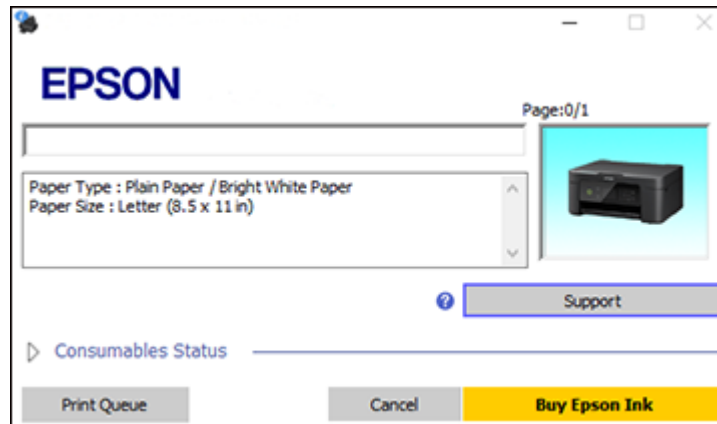



- To cancel printing, click **Cancel**.
- To see print jobs waiting to print, click **Print Queue**.
- To check ink status, click **Consumables Status**.

Parent topic: [Printing Your Document or Photo - Windows](#)

Selecting Default Print Settings - Windows

When you change your print settings in a program, the changes apply only while you are printing in that program session. If you want to change the print settings you use in all your Windows programs, you can select new default print settings.

1. Access the Windows Desktop and right-click the  icon for your product in the right side of the Windows taskbar, or click the up arrow and right-click .
2. Select **Printer Settings**.

You see the printer settings window:

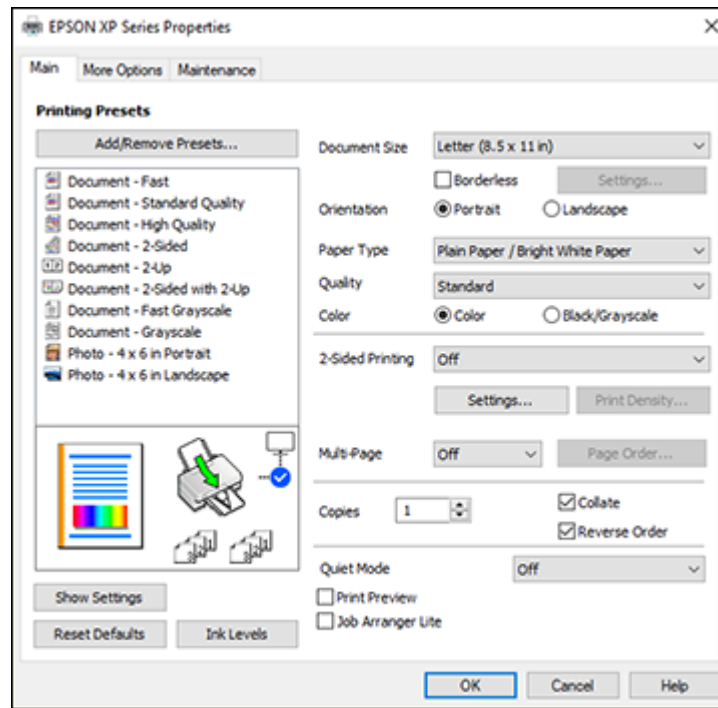

3. Select the print settings you want to use as defaults in all your Windows programs.
4. Click **OK**.



These settings are now the defaults selected for printing. You can still change them as needed for printing in any program session.

[Changing the Language of the Printer Software Screens](#)

Parent topic: [Printing with Windows](#)

Changing the Language of the Printer Software Screens

You can change the language used on the Windows printer software screens.

1. Access the Windows Desktop and right-click the  icon for your product in the right side of the Windows taskbar, or click the up arrow and right-click .
2. Select **Printer Settings**.

You see the printer settings window.

3. Click the **Maintenance** tab.

You see the maintenance options:

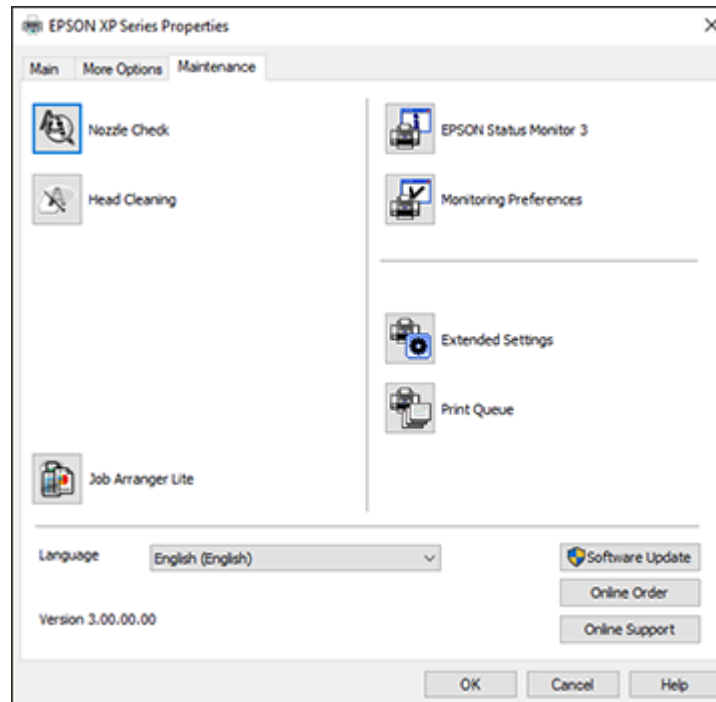

4. Select the language you want to use as the **Language** setting.



5. Click **OK** to close the printer software window.

The printer software screens appear in the language you selected the next time you access them.

Parent topic: [Selecting Default Print Settings - Windows](#)

Changing Automatic Update Options

Your printer software for Windows automatically checks for updates to the product software. You can change how often the software checks for updates or disable this feature.

1. Access the Windows Desktop and right-click the  icon for your product in the right side of the Windows taskbar, or click the up arrow and right-click .
2. Select **Software Update Settings**.

You see this window:

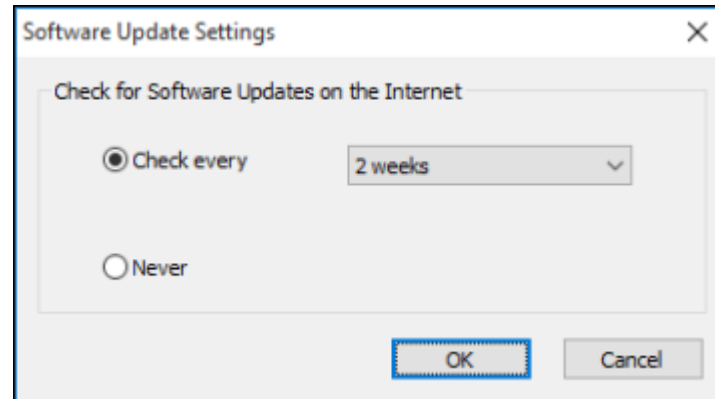

3. Do one of the following:
 - To change how often the software checks for updates, select a setting in the **Check every** menu.
 - To disable the automatic update feature, select the **Never** option.
4. Click **OK** to exit.

Note: If you choose to disable the automatic update feature, you can check for updates manually.

Parent topic: [Printing with Windows](#)

Printing with the Built-in Epson Driver - Windows 10 S

You can print with the built-in Epson printer driver using any printing program on Windows 10 S, as described in these sections.

Note: The built-in Epson driver in Windows 10 S does not include all the available print settings for your product. To print with additional settings, download and install the Epson Print and Scan utility from the Windows Store. You cannot download and install any Epson product software from the Epson website for use with Windows 10 S; you must obtain software only from the Windows Store.

Selecting Print Settings - Windows 10 S

Parent topic: [Printing from a Computer](#)

Selecting Print Settings - Windows 10 S

Select the settings for your print job in your Windows 10 S application.

1. Open a photo or document for printing.
2. Select the print command in your application.

Note: You may need to select a print icon on your screen, the **Print** option in the **File** menu, or another command. See your application's help utility for details.

3. If necessary, select your product name as the printer you want to use.

Note: You may also need to select **Properties** or **Preferences** to view your print settings.

You see a window like this:

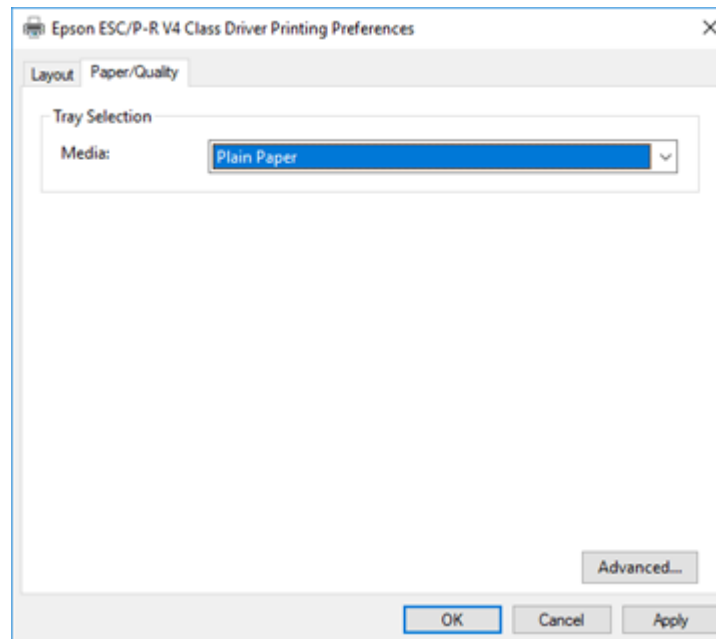

4. Select the type of paper you loaded as the **Media** setting.

Note: The setting may not exactly match the name of your paper. Check the paper type settings list for details.

5. Click the **Advanced** button.

You see a window like this:

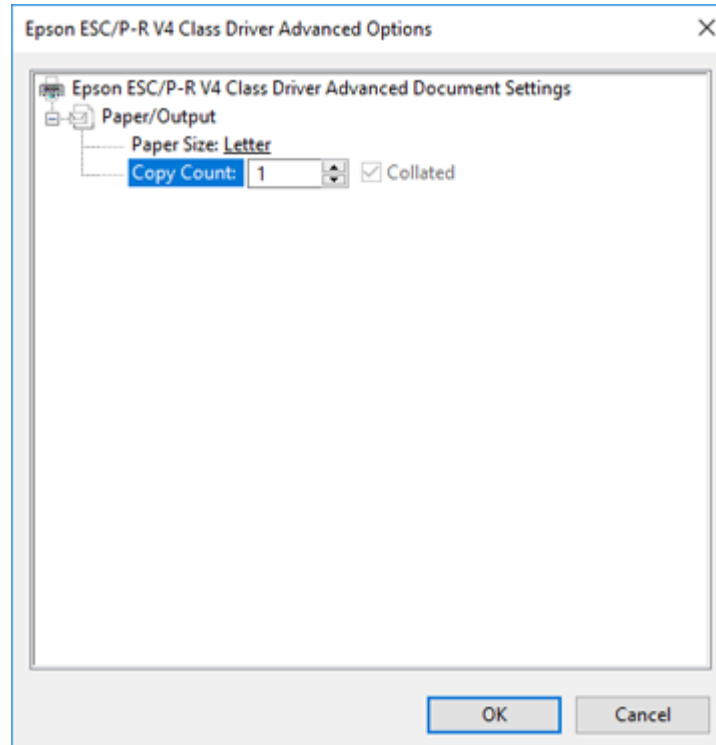

6. Select the size of the paper you loaded as the **Paper Size** setting.
7. To print multiple copies, select or enter the number as the **Copy Count** setting.
8. To print multiple copies of multi-page documents in sets, select the **Collated** checkbox.
9. Click **OK**.

You return to the printing preferences window.

10. Select the **Layout** tab.

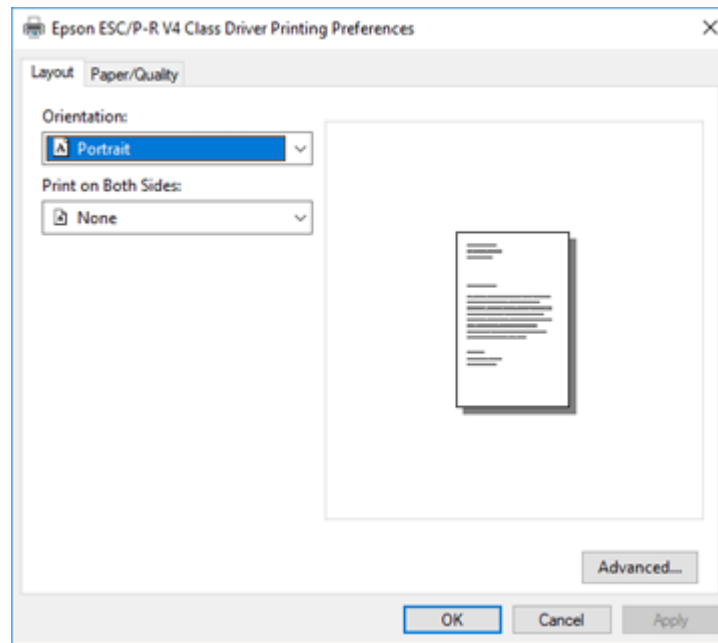

11. Select the orientation of your document as the **Orientation** setting.

- To print double-sided, select one of the **Print on Both Sides** options, depending on how you want to orient the page layout. The icon next to each option shows the layout.

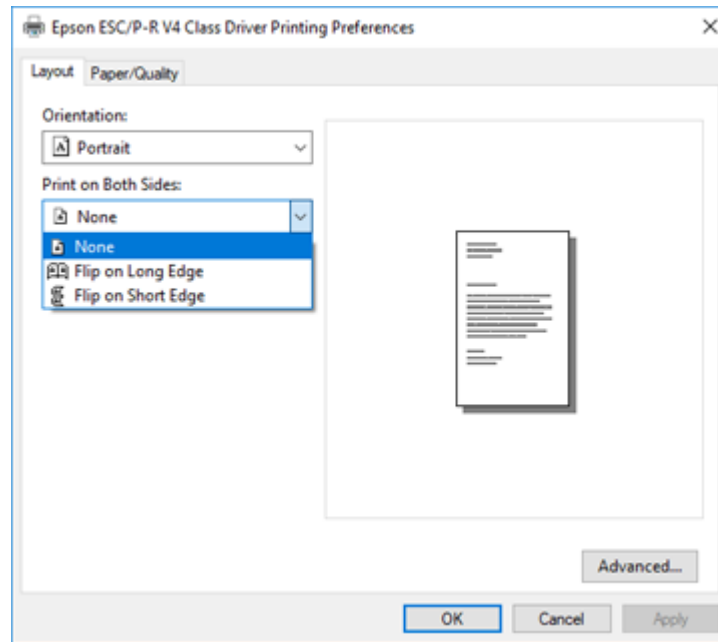

- Click **OK** to save your settings.

You see your application's **Print** window.

- Click **OK** or **Print** to start printing.

Parent topic: [Printing with the Built-in Epson Driver - Windows 10 S](#)

Printing on a Mac

You can print with your product using any Mac printing program, as described in these sections.

Note: If you have an Internet connection, it is a good idea to check for updates to your product software on Epson's support website.

[Selecting Basic Print Settings - Mac](#)

[Selecting Page Setup Settings - Mac](#)

[Selecting Print Layout Options - Mac](#)
[Selecting Double-sided Printing Settings - Mac](#)
[Managing Color - Mac](#)
[Selecting Printing Preferences - Mac](#)
[Printing Your Document or Photo - Mac](#)

Parent topic: [Printing from a Computer](#)

Related tasks

[Checking for Software Updates](#)

Selecting Basic Print Settings - Mac

Select the basic settings for the document or photo you want to print.

1. Open a photo or document for printing.
2. Select the print command in your application.

Note: You may need to select a print icon on your screen, the **Print** option in the File menu, or another command. See your application's help utility for details.

3. Select your product as the **Printer** setting.

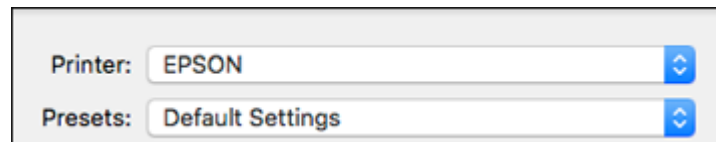

4. If necessary, click the arrow next to the Printer setting or the **Show Details** button to expand the print window.

You see the expanded printer settings window for your product:

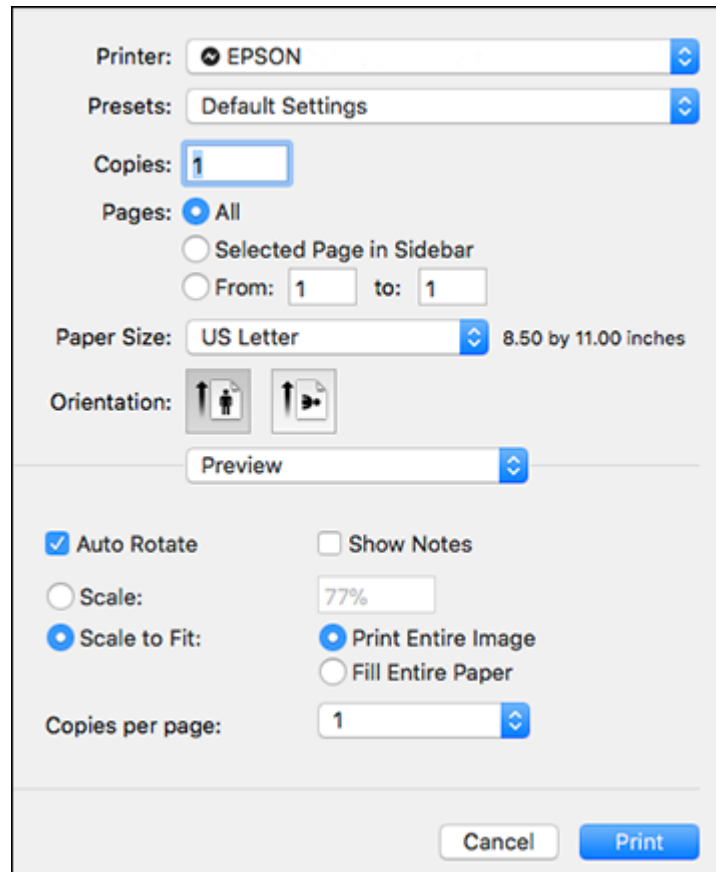

Note: The print window may look different, depending on your version of the Mac operating system and the application you are using.

5. Select the **Copies** and **Pages** settings as necessary.

Note: If you do not see these settings in the print window, check for them in your application before printing.

6. Select the page setup options: **Paper Size** and **Orientation**.

Note: If you do not see these settings in the print window, check for them in your application before printing. They may be accessible by selecting **Page Setup** from the File menu.

7. Select any application-specific settings that appear on the screen, such as those shown in the image above for the Preview application.
8. Select **Print Settings** or **Printer Features** from the pop-up menu.

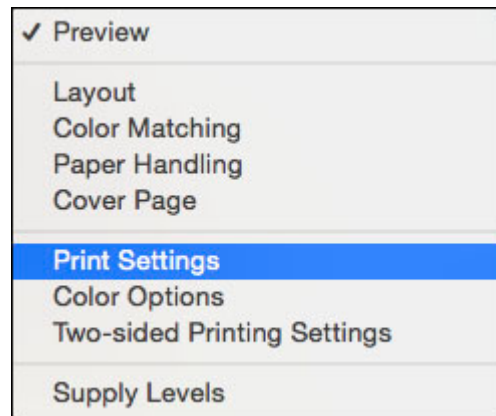

You see these settings:

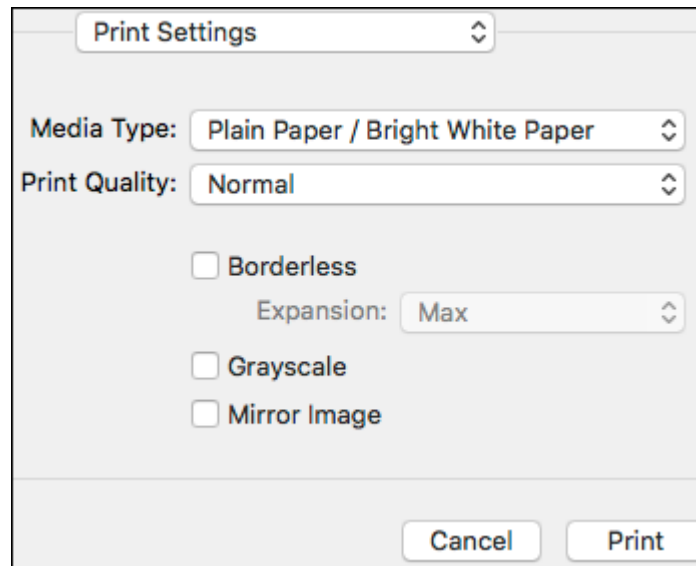

Note: The available print settings and appearance of the print window may be different than those covered here, depending on the Mac OS version and the application you are using.

9. Select the type of paper you loaded as the **Media Type** setting.

Note: The setting may not exactly match the name of your paper. Check the paper type settings list for details.

10. Select the **Print Quality** setting you want to use.
11. Select the **Borderless** checkbox if you want to print a borderless photo. If the option is grayed out, change the **Media Type** setting to a paper type that supports borderless printing.
12. Select any of the available print options.

[Print Quality Settings - Mac](#)

[Print Options - Mac](#)

Parent topic: [Printing on a Mac](#)

Related references

[Paper or Media Type Settings - Printing Software](#)

Related tasks

[Selecting Page Setup Settings - Mac](#)

[Selecting Print Layout Options - Mac](#)

[Selecting Double-sided Printing Settings - Mac](#)

[Managing Color - Mac](#)

[Printing Your Document or Photo - Mac](#)

Print Quality Settings - Mac

You can select any of the **Print Quality** settings to fine-tune the quality of your print. Some settings may be unavailable, depending on the paper type and border setting you have chosen.

Draft

For draft printing on photo paper.

Normal

For everyday text and image printing.

Normal - Vivid

For everyday text and image printing with good quality and print speed.

Fine

For text and graphics with good quality and print speed.

Quality

For photos and graphics with good quality and print speed.

Best Quality

For the best print quality, but the slowest print speed.

Parent topic: [Selecting Basic Print Settings - Mac](#)

Print Options - Mac

You can select any of the print options to customize your print. Some options may be unavailable, depending on other settings you have chosen.

Expansion

If you selected a borderless paper size setting, this option adjusts the image expansion settings to control printing at the edges of borderless prints.

Grayscale

Prints text and graphics in black or shades of gray.

Mirror Image

Lets you flip the printed image horizontally.

Note: If you select the **Min** option for the Expansion setting, you may see white borders on your printed photo.

Parent topic: [Selecting Basic Print Settings - Mac](#)

Selecting Page Setup Settings - Mac

Depending on your application, you may be able to select the paper size and orientation settings from the print window.

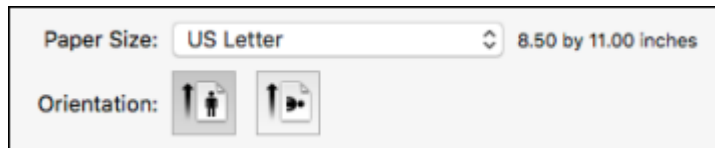

Note: If you do not see these settings in the print window, check for them in your application before printing. They may be accessible by selecting **Page Setup** from the File menu.

1. Select the size of the paper you loaded as the **Paper Size** setting. If you are printing a borderless photo, select the **Borderless** checkbox or a paper size with a **Borderless** option. You can also select a custom setting to create a custom paper size, but the Quality setting will be limited to **Normal**.

Note: You must select a compatible borderless paper type and size to print without borders. Check the borderless paper compatibility list for details.

2. Select the orientation of your document or photo as shown in the print window.

Note: If you are printing an envelope, select the  icon.

Note: You can reduce or enlarge the size of the printed image by selecting **Paper Handling** from the pop-up menu and selecting a scaling option.

Parent topic: [Printing on a Mac](#)

Selecting Print Layout Options - Mac

You can select a variety of layout options for your document or photo by selecting **Layout** from the pop-up menu on the print window.

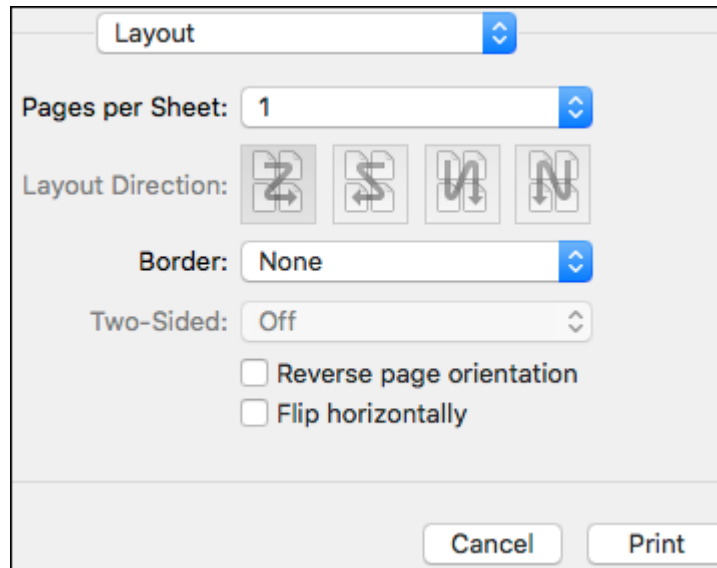

- To print multiple pages on one sheet of paper, select the number of pages in the **Pages per Sheet** pop-up menu. To arrange the print order of the pages, select a **Layout Direction** setting.
- To print borders around each page on the sheet, select a line setting from the **Border** pop-up menu.
- To invert or flip the printed image, select the **Reverse page orientation** or **Flip horizontally** settings.

Parent topic: [Printing on a Mac](#)

Selecting Double-sided Printing Settings - Mac

You can print on both sides of the paper by selecting **Two-sided Printing Settings** from the pop-up menu on the print window.

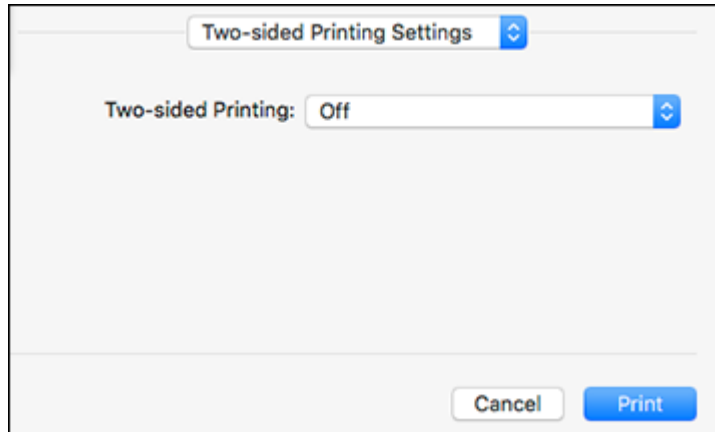

Note: Some options may be pre-selected or unavailable, depending on other settings you have chosen or if you are accessing the product over a network. This screen may be different, depending on the Mac OS version you are using.

1. Select one of the **Two-sided Printing** options.

2. Select the type of document you are printing as the **Document Type** setting. The software automatically sets the Adjustments options for that document type.

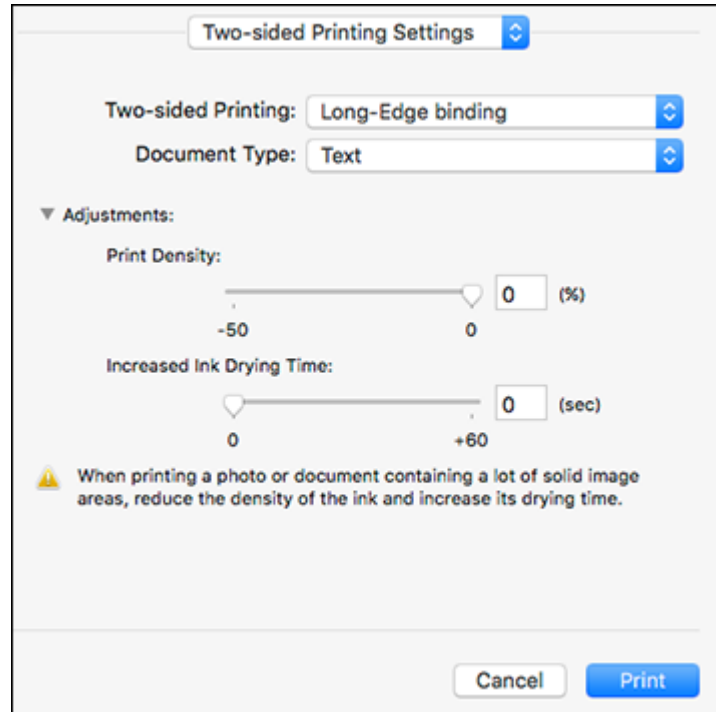

3. If necessary, customize the Adjustments settings as instructed on the screen.
4. Print a test copy of your double-sided document to test the selected settings.
5. Follow any instructions displayed on the screen during printing.

[Double-sided Printing Options and Adjustments - Mac](#)

Parent topic: [Printing on a Mac](#)

Double-sided Printing Options and Adjustments - Mac

You can select any of the available options in the **Two-sided Printing Settings** or **Output Settings** pop-up menu to set up your double-sided print job.

Two-sided Printing Options

Long-Edge binding

Orients double-sided printed pages to be bound on the long edge of the paper.

Short-Edge binding

Orients double-sided printed pages to be bound on the short edge of the paper.

Adjustments

Print Density

Sets the level of ink coverage for double-sided printing.

Increased Ink Drying Time

Sets the amount of time required for drying ink after printing on one side of the paper before printing the other side in double-sided printing.

Parent topic: [Selecting Double-sided Printing Settings - Mac](#)

Managing Color - Mac

You can adjust the Color Matching and Color Options settings to fine-tune the colors in your printout, or turn off color management in your printer software.

1. Select **Color Matching** from the pop-up menu in the print window.

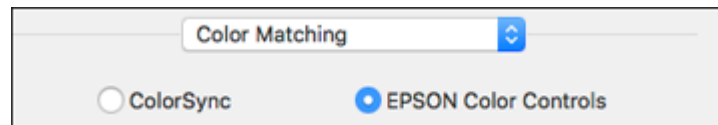

2. Select one of the available options.

3. Select **Color Options** from the pop-up menu in the print window.

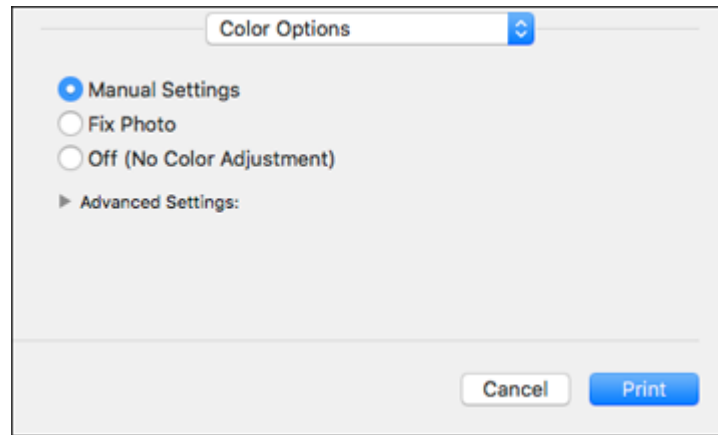

Note: The available settings on the Color Options menu depend on the option you selected on the Color Matching menu.

4. Select one of the available options.

[Color Matching and Color Options - Mac](#)

Parent topic: [Printing on a Mac](#)

Color Matching and Color Options - Mac

You can select from these settings on the **Color Matching** and **Color Options** menus.

Color Matching Settings

EPSON Color Controls

Lets you manage color using controls in your printer software or turn off color management.

ColorSync

Prints using standard color profiles for your product and paper to help match image colors. You can customize the conversion method and filter settings on the ColorSync pop-up menu in the print window.

Color Options Settings

Manual Settings

Lets you select manual color adjustments. Click the arrow next to **Advanced Settings** and select settings for **Brightness**, **Contrast**, **Saturation**, and individual color tones. You can also select a color **Mode** setting for printing photos and graphics and the **Fix Red-Eye** setting to reduce or remove red-eye in photos. Depending on the selected color mode, you can also adjust the midtone density using the **Gamma** setting.

Fix Photo

Improves the color, contrast, and sharpness of flawed photos. Click the arrow next to **Advanced Settings** and select the **Fix Red-Eye** setting to reduce or remove red-eye in photos.

Note: Fix Photo uses a sophisticated face recognition technology to optimize photos that include faces. For this to work, both eyes and the nose must be visible in the subject's face. If your photo includes a face with an intentional color cast, such as a statue, you may want to turn off **Fix Photo** to retain the special color effects.

Off (No Color Adjustment)

Turns off color management in your printer software so you can manage color using only your application software.

Note: An ICC profile is required if color management is turned off.

Parent topic: [Managing Color - Mac](#)

Selecting Printing Preferences - Mac

You can select printing preferences that apply to all the print jobs you send to your product.

1. In the Apple menu or the Dock, select **System Preferences**.
2. Select **Print & Fax**, **Print & Scan**, or **Printers & Scanners**, select your product, and select **Options & Supplies**.
3. Select **Driver** or **Options**.

You see a screen like this:

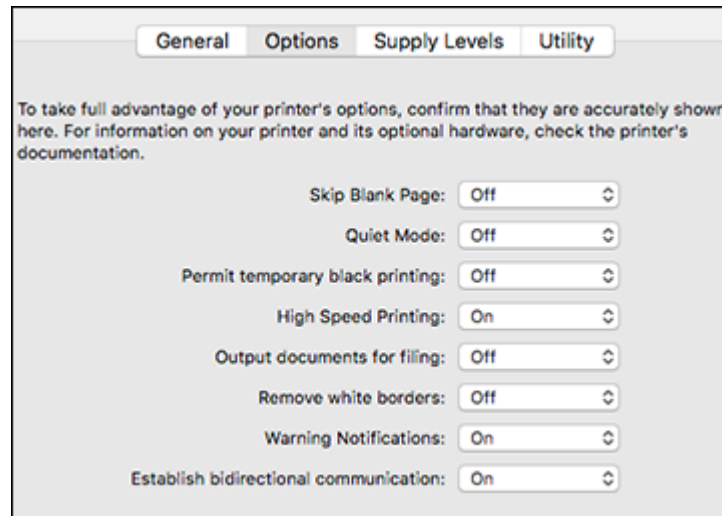

4. Select any of the available printing preferences.
5. Click **OK**.

[Printing Preferences - Mac](#)

Parent topic: [Printing on a Mac](#)

Printing Preferences - Mac

You can select from these settings on the **Options** or **Driver** tab.

Skip Blank Page

Ensures that your product does not print pages that contain no text or images.

Quiet Mode

Lessens noise during printing but may decrease print speed.

Permit temporary black printing

Allows you to print using black ink when color ink is expended.

High Speed Printing

Speeds up printing but may reduce print quality.

Output documents for filing

Outputs all landscape, portrait, 1-sided, and 2-sided documents in the same orientation for easier filing.

Remove white borders

Removes white margins that may appear when you print borderless photos.

Warning Notifications

Lets you choose whether or not to receive warning notifications from the printer software for various operating conditions.

Establish bidirectional communication

Allows the product to communicate with the computer. Do not change the default setting unless you experience issues when using a shared printing pool.

Parent topic: [Selecting Printing Preferences - Mac](#)

Printing Your Document or Photo - Mac

Once you have selected your print settings, you are ready to print.

Click **Print** at the bottom of the print window.

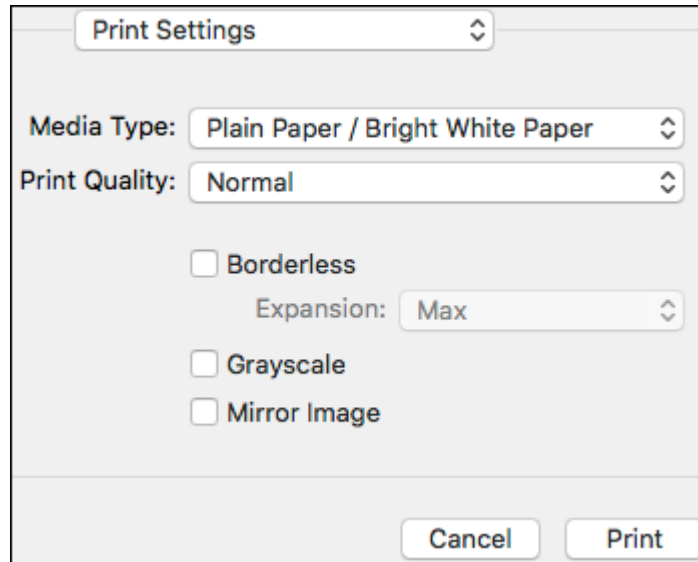

[Checking Print Status - Mac](#)

Parent topic: [Printing on a Mac](#)

Related tasks

[Selecting Basic Print Settings - Mac](#)

Checking Print Status - Mac



During printing, you can view the progress of your print job, control printing, and check ink status.

1. Click the printer icon when it appears in the Dock.

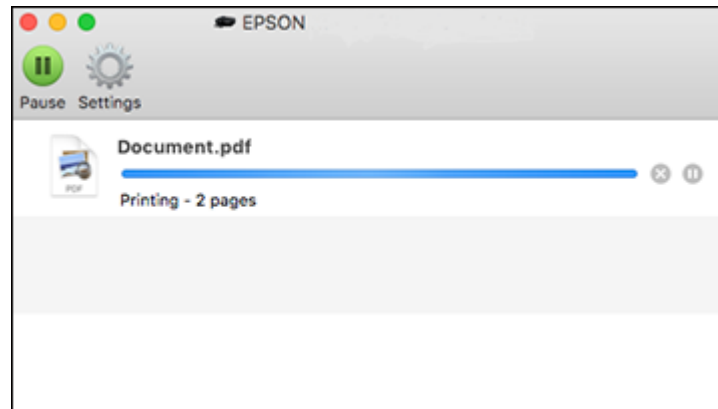
You see the print status window:



2. Select the following options as necessary for your Mac OS version:

- To cancel printing, click the print job and click  or **Delete**.
- To pause a print job, click the print job and click  or **Hold**. To resume a print job, click the paused print job and click  or **Resume**.
- To pause printing for all queued print jobs, click **Pause** or **Pause Printer**.
- To display other printer information, click **Settings** or **Supply Levels**.

Parent topic: [Printing Your Document or Photo - Mac](#)

Printing From a Chromebook

With a Google Account, you can print from a Chromebook without drivers or cables.

1. Connect your Epson product to your wireless network. See the link below.
2. Turn on your Chromebook and connect it to the same wireless network as your product.

Note: See your Chromebook's documentation for details on connecting to a network.

3. Do one of the following:
 - Click **Add to Cloud Print** in the notification that appears in the corner of your Chromebook screen.

Note: If you do not see a notification, check to see if a number appears in the status area at the lower-right corner of the screen. Click this number to open the notifications menu, then click **Add to Cloud Print**.

- Open a web browser and enter **chrome://devices** in the address bar. Skip to step 4.
 - If you see a registration confirmation screen instead, click **Register**.
4. Click **Add Device**.
 5. Click the **Register** button that appears next to your product.
 6. Click **Register** on the confirmation screen. Your product's LCD screen displays a confirmation message.
 7. Select **OK** or press the **OK** button on your product to confirm the Google Cloud Print connection and print a test page.
 8. To print to the connected product, select the print command in your Chrome app.

Your product is now linked to your Google Account and can be accessed from any Chromebook where you are logged in, as long as you have Internet access. Visit [Epson Support for Google Cloud Print \(U.S\)](#) or [Epson Support for Google Cloud Print \(Canada\)](#) for more information on using Google Cloud Print, or the [Google Cloud Print](#) website for a list of [supported apps](#).

Parent topic: [Printing from a Computer](#)

Related tasks

[Using Google Cloud Print](#)

Related topics

[Wi-Fi Networking](#)

Cancelling Printing Using a Product Button

If you need to cancel printing, press the  stop button.

Parent topic: [Printing from a Computer](#)

Scanning

You can scan your originals and save them as digital files.

[Starting a Scan](#)

[Scanning in Epson Scan 2](#)

[Scanning to Online Destinations Using Easy Photo Scan](#)

Starting a Scan

After placing your originals on your product for scanning, start scanning using one of these methods.

[Starting a Scan Using the Product Control Panel](#)

[Starting a Scan Using the Epson Scan 2 Icon](#)

[Starting a Scan from a Scanning Program](#)

[Starting a Scan from a Smart Device](#)

Parent topic: [Scanning](#)

Related tasks

[Placing Originals on the Scanner Glass](#)

Starting a Scan Using the Product Control Panel

You can scan an image to a variety of destinations using your product's control panel.

1. Make sure you installed the product software and connected the product to your computer or network.

Note: Restart your computer after installing the product software to enable scanning from the control panel.

2. Place your original on the product for scanning.
3. Press the  home button, if necessary.
4. Select **Scan**.

You see a screen like this:

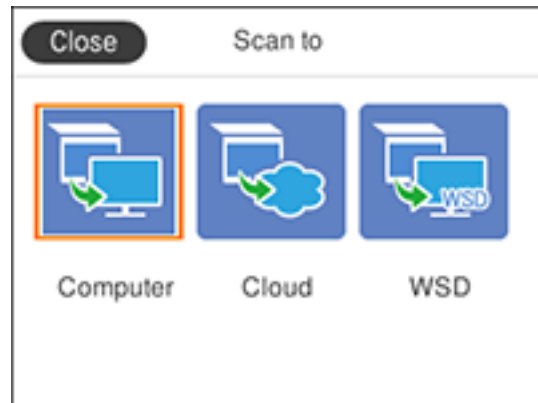

5. Select one of the following **Scan to** options:
 - **Computer** lets you scan to a connected computer using your saved scan settings.
 - **Cloud** sends your scanned files to a destination that you have registered with Epson Connect.
 - **Computer (WSD)** lets you manage network scanning in Windows 10, Windows 8.x, Windows 7, or Windows Vista (English only). To use this feature, you must first set up a WSD (Web Services for Devices) port on your Windows 7 or Windows Vista computer (the port is set up automatically on Windows 10 and Windows 8.x).
6. Follow the instructions in the links below to complete your scan.

[Scanning to a Connected Computer](#)

[Scanning to the Cloud](#)

[Setting Up a WSD Port \(Windows 7/Windows Vista\)](#)

[Control Panel Scanning Options](#)

[Changing Default Scan Job Settings](#)

Parent topic: [Starting a Scan](#)

Related tasks

[Placing Originals on the Scanner Glass](#)

Related topics

[Wi-Fi Networking](#)

Scanning to a Connected Computer

You can scan an original and save it to a connected computer using your product's control panel. The computer must be connected using a USB cable or connected to the same network as your product.

You can save the scanned file as a JPEG or PDF file, or attach it to an email. You can also set up custom scan settings using Event Manager and automatically scan using those settings on your product control panel.

Note: Be sure you have installed Epson Scan 2 and Event Manager on your computer before scanning to your computer.

1. Place your original on the product for scanning.
2. Press the  home button, if necessary.
3. Select **Scan**.

You see a screen like this:

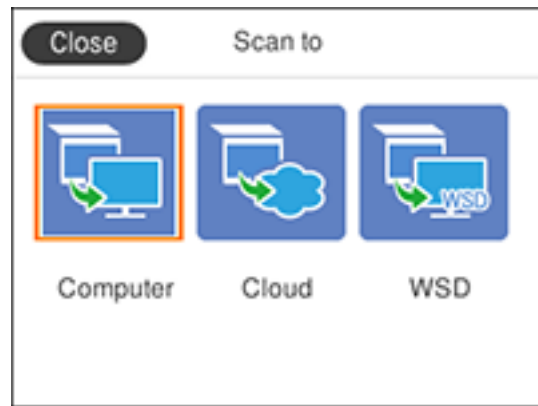

4. Select **Computer**.

You see a screen like this:

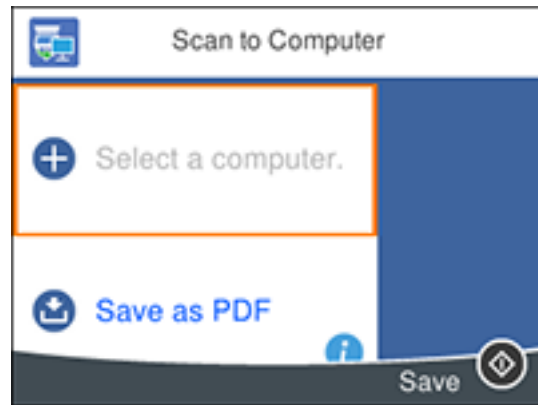

Note: Select **OK** to close the information screen, if necessary.

5. Select **Select a computer** and choose one of the following options:
 - If your computer is connected to your product over a network, select a connected computer from the displayed list. (If the computer is not listed, select **Search Again**.)
 - If your computer is connected to your product using a USB cable, select **USB Connection**.
6. Select **Save as PDF** and choose one of the following options:
 - **Save as JPEG** to save the scanned image as a JPEG file.
 - **Save as PDF** to save the scanned document or image as a PDF file.
 - **Attach to e-mail** to open the default email software on your computer and save the scanned document or images as a JPEG email attachment.
 - **Follow custom setting** to save the scanned document or image using custom settings you have selected using the Event Manager custom scan settings option.

Note: You can customize the settings for each of the options above using Event Manager.

7. Press the  start button to start scanning.
Your product scans your original and saves the scanned file to your computer.

Parent topic: [Starting a Scan Using the Product Control Panel](#)

Related references

[Control Panel Scanning Options](#)

Scanning to the Cloud

You can use the control panel to send your scanned files to a destination that you have registered with Epson Connect.

Note: Make sure to set up your product using Epson Connect before using this feature.

1. Place your original on the product for scanning.
2. Press the  home button, if necessary.
3. Select **Scan**.

You see a screen like this:

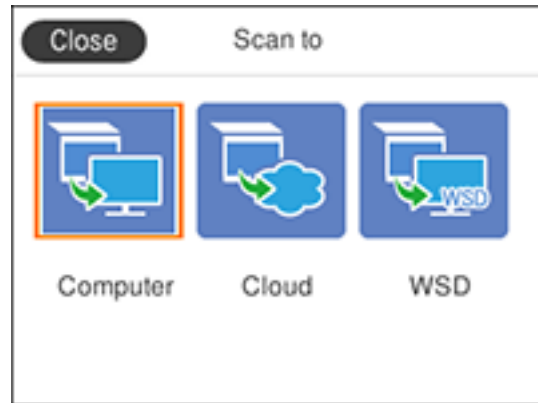

4. Select **Cloud**.

You see a screen like this:

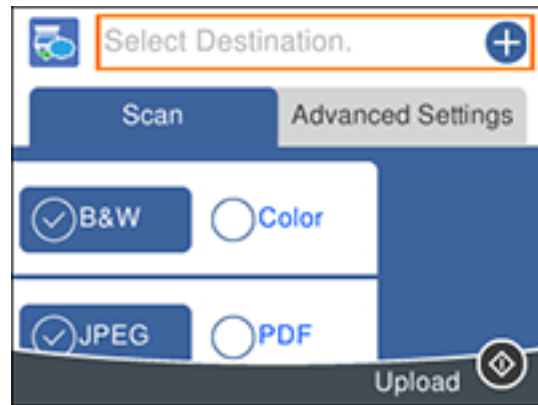

5. Change any of the displayed settings on the **Scan** tab as necessary.
6. Select the **Advanced Settings** tab to view and change additional scan settings, if necessary.
7. On the **Scan** tab, press the  start button to start scanning.

Your product scans your original and saves the scanned file to the selected destination.

Parent topic: [Starting a Scan Using the Product Control Panel](#)

Related references

[Control Panel Scanning Options](#)

Related tasks

[Setting Up Epson Connect Services](#)

[Using Epson Scan to Cloud](#)

Setting Up a WSD Port (Windows 7/Windows Vista)

You can scan to a networked Windows computer using WSD (Web Services for Devices). You must first set up a WSD port on your Windows 7 or Windows Vista system (the port is set up automatically on Windows 10 and Windows 8.x).

Before you set up a WSD port, make sure you installed your product software, and connected your product and computer to the same network.

1. Turn on your product.

2. Print a network status sheet so you can identify the network name and model name for your product on the network.
3. Click  or **Start** and select **Computer**.
4. On the left side of the window, select **Network**.
5. Locate your product on the Network screen, right-click it, and select **Install**.
6. When you see the User Account Control screen, click **Continue**.

Note: If you see an Uninstall screen, click **Uninstall** and repeat these steps as necessary.

7. When you see the message **Your device is ready to use** in the Windows taskbar, click the message.
8. On the Driver Software Installation screen, make sure your product is listed as **Ready to use**. Then click **Close**.
9. Do one of the following:
 - **Windows 7:** Click  and select **Devices and Printers**.
 - **Windows Vista:** Click **Start** and select **Control Panel > Hardware and Sound > Printers**.
10. Make sure that an icon appears for your product's name on the network.

When you use WSD, select your product name to scan over the network.

Parent topic: [Starting a Scan Using the Product Control Panel](#)

Related references

[Control Panel Scanning Options](#)

Control Panel Scanning Options

Select the options you want to use for scanning.

Note: Not all options or settings may be available, depending on the **Scan to** option selected.



Scan to setting	Available options	Description
Color Mode	B&W	Select whether to scan images in color or black and white
	Color	

Scan to setting	Available options	Description
Original Type	Text	Specifies the type of original you are scanning
	Photo	
Scan Settings	Letter	Select the page size for documents, then select the orientation of the original
	A4	
	Auto Cropping	Select for photos with dark edges
	Max Area	Select for most photos
Contrast	Varying levels	Adjusts the lightness or darkness of scanned images

Parent topic: [Starting a Scan Using the Product Control Panel](#)

Changing Default Scan Job Settings

You can view or change the default scan job settings your product uses when you scan to your computer. You do this using the Event Manager program.



1. Do one of the following to open Event Manager:
 - **Windows 10:** Click  and select **EPSON Software > Event Manager**.
 - **Windows 8.x:** Navigate to the **Apps** screen and select **Event Manager**.
 - **Windows (other versions):** Click  or **Start > All Programs** or **Programs > EPSON Software > Event Manager**.
 - **Mac:** Open the **Applications** folder, click **Epson Software**, and select **Event Manager**.
2. Open the **Scanner** (Windows) or **Select Scanner** (Mac) drop-down list and select your product, if necessary.
3. Click **Make Job Settings**.
4. Open the **Edit Job Settings** drop-down list and select the scan job settings you want to view or change.
5. Change the settings as necessary.
6. Click **OK**.
7. Click **Close** to close the Event Manager window.

Parent topic: [Starting a Scan Using the Product Control Panel](#)

Starting a Scan Using the Epson Scan 2 Icon

You can start the Epson Scan 2 program to select scan settings, scan, and save the scanned image to a file.

Note: If you are using your Epson product with the Windows 10 S operating system, you cannot use the software described in this section. You also cannot download and install any Epson product software from the Epson website for use with Windows 10 S; you must obtain software only from the Windows Store.

- **Windows 10:** Click  and select **EPSON > Epson Scan 2**.
- **Windows 8.x:** Navigate to the **Apps** screen and select **Epson Scan 2**.
- **Windows (other versions):** Click  or **Start**, and select **All Programs** or **Programs**. Select **EPSON > Epson Scan 2 > Epson Scan 2**.
- **Mac:** Open the **Applications** folder, open the **Epson Software** folder, and select **Epson Scan 2**.

You see an Epson Scan 2 window like this:

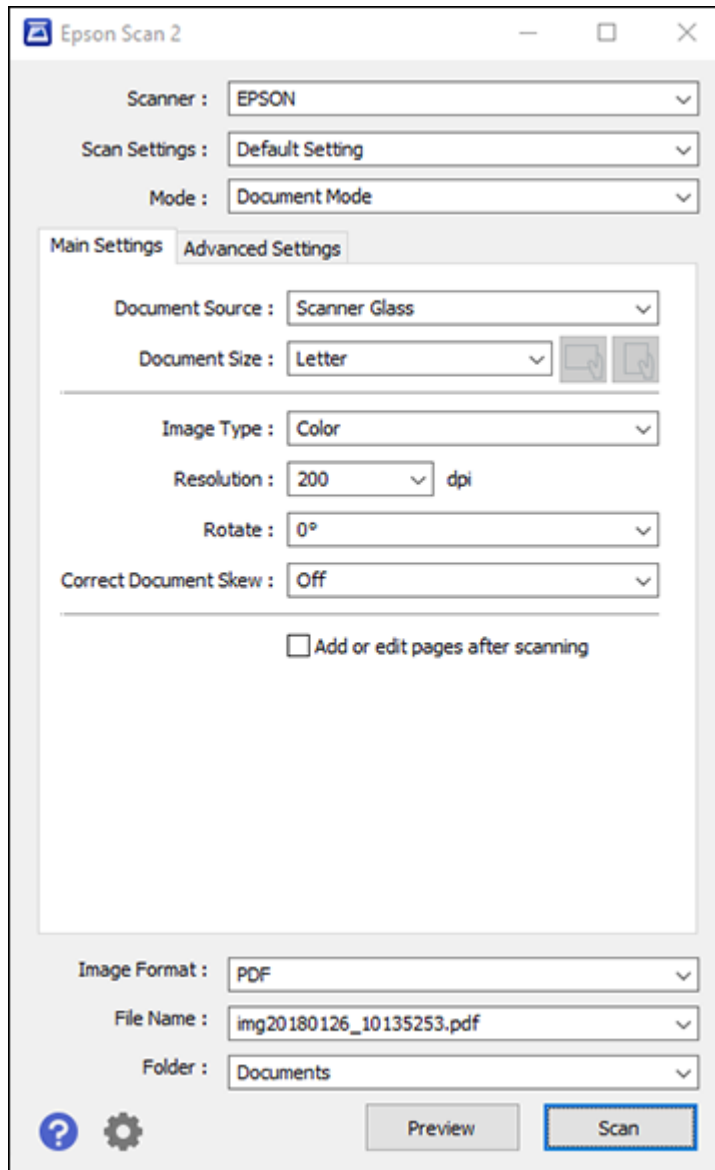

Parent topic: [Starting a Scan](#)

Starting a Scan from a Scanning Program

You can start Epson Scan 2 from a TWAIN-compliant scanning program to select scan settings, scan, and open the scanned image in the program.

Note: If you are using your Epson product with the Windows 10 S operating system, you cannot use the software described in this section. You also cannot download and install any Epson product software from the Epson website for use with Windows 10 S; you must obtain software only from the Windows Store.

1. Open your scanning program and select its scanning option. (See your scanning program help for instructions.)
2. Select your product.

Note: In certain programs, you may need to select your product as the "source" first. If you see a **Select Source** option, choose it and select your product. With Windows, do not select a **WIA** option for your product; not all scan functions will be available.

You see an Epson Scan 2 window like this:

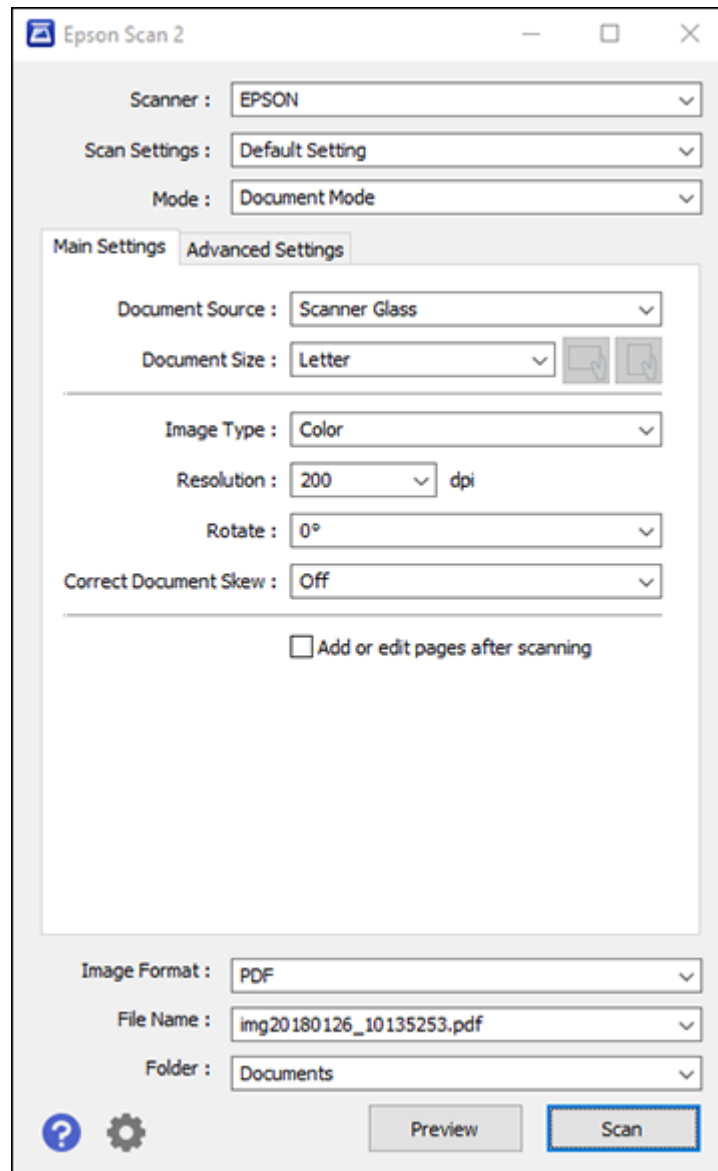

Parent topic: [Starting a Scan](#)

Starting a Scan from a Smart Device

You can start a scan from a smart device using the Epson iPrint app. You can save the scanned document to your device or a cloud service, e-mail it, or print it.

Note: If you are using your Epson product with the Windows 10 S operating system, you cannot use the software described in this section. You also cannot download and install any Epson product software from the Epson website for use with Windows 10 S; you must obtain software only from the Windows Store.

Note: Your device must be connected to the same wireless network as your Epson product.

1. Download the Epson iPrint app from your device's app store or from Epson's website.
2. Place your original on the product for scanning.
3. Open the Epson iPrint app and select your product.
4. Select the scan settings and scan your original.
5. Save your scanned image to a file or cloud location.

Parent topic: [Starting a Scan](#)

Related tasks

[Using the Epson iPrint Mobile App](#)

Scanning in Epson Scan 2

Epson Scan 2 automatically scans your document and saves the scanned file in PDF format in your operating system's Documents or My Documents folder, or opens it in your scanning program. You can select settings, preview, and change the scanned file settings as necessary.

Note: If you are using your Epson product with the Windows 10 S operating system, you cannot use the software described in this section. You also cannot download and install any Epson product software from the Epson website for use with Windows 10 S; you must obtain software only from the Windows Store.

1. Start Epson Scan 2.

You see this window:

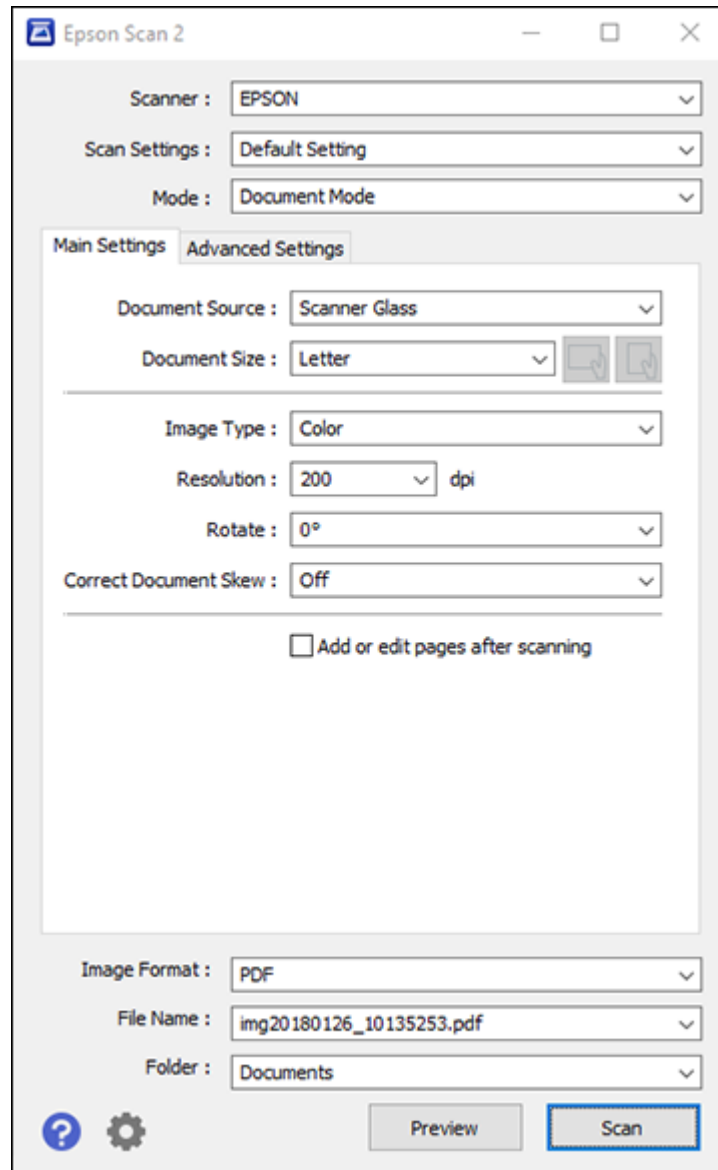

2. Select the **Mode** setting that matches the type of original you are scanning.
3. Select the **Document Source** setting that matches where you placed your original.
4. Select the **Document Size** setting that matches the size of your original. You can select **Customize** to enter a custom size, if necessary.
5. Select the image type of your original and how you want it scanned as the **Image Type** setting.
6. Select the **Resolution** setting you want to use for your scan.
7. Click the **Preview** button.

Epson Scan 2 previews your original and displays the results in the Epson Scan 2 window.

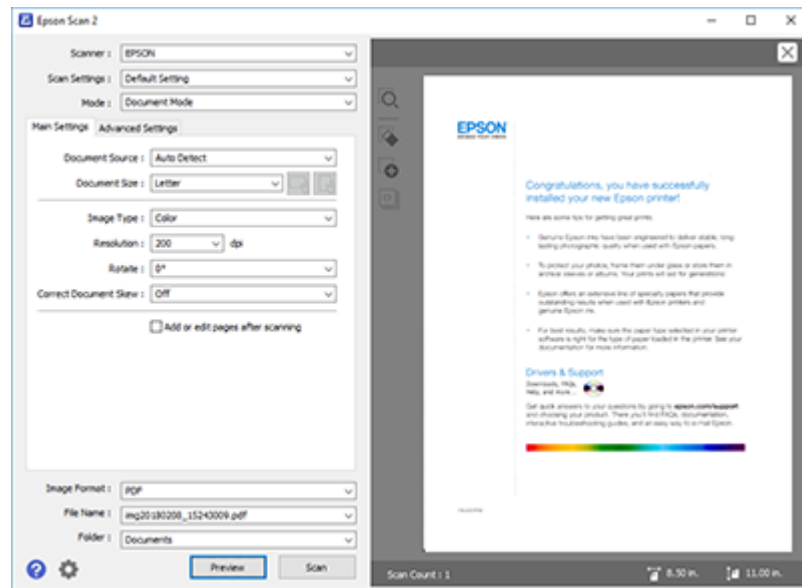

8. Select any of the additional settings that you want to use on the Main Settings tab.
9. Do one of the following:
 - If you're scanning in Document Mode, select any of the additional settings that you want to use on the Main Settings tab.
 - If you're scanning in Photo Mode, select the **Color Management** and **Thumbnail Options** settings as necessary.
10. Click the **Advanced Settings** tab and select any settings that you want to use.

11. Select the format in which you want to save your scanned file as the **Image Format** setting. If necessary, select **Options** and select any desired format options.
12. Enter the file name for your scanned file in the **File Name** field. If necessary, select **Settings** to modify the file name settings.
13. Select the location in which you want to save your scanned file as the **Folder** setting. If necessary, select **Select** to create a new folder.
14. Click **Scan**.

The product scans your original and saves the scanned file in the location you specified.

[Additional Scanning Settings - Main Settings Tab](#)

[Additional Scanning Settings - Advanced Settings Tab](#)

[Saving Scanned Documents as a Searchable PDF Using Epson Scan 2](#)

[Image Format Options](#)

[Scan Resolution Guidelines](#)

Parent topic: [Scanning](#)

Additional Scanning Settings - Main Settings Tab

You can select these additional scanning settings on the Epson Scan 2 Main Settings tab. Not all adjustment settings may be available, depending on other settings you have chosen.

Rotate

Rotates the original image clockwise to the desired angle before scanning it. Select **Auto** to allow your product to automatically rotate the image based on the orientation of the text (may take longer to scan).

Correct Document Skew

Corrects skewed originals, image contents, or both.

Add or edit pages after scanning

Lets you add, remove, or edit the pages in a scan, including rotating pages and changing the page order.

Note: To save multiple pages in a single file, you must select a file format that supports multiple pages such as **PDF** or **Multi-TIFF**. If you select another file format, each scanned image or page is saved as a separate file.

Parent topic: [Scanning in Epson Scan 2](#)

Additional Scanning Settings - Advanced Settings Tab

You can select these additional scanning settings on the Epson Scan 2 Advanced Settings tab. Not all adjustment settings may be available, depending on other settings you have chosen.

Color Restoration

Restores the colors in faded photos automatically.

Backlight Correction

Removes shadows from photos that have too much background light.

Dust Removal

Removes dust marks from your originals automatically.

Remove Background

Removes the background of the originals.

Text Enhancement

Sharpens the appearance of letters in text documents.

Auto Area Segmentation

Makes black and white images clearer and text recognition more accurate by separating the text from the graphics.

Threshold

Adjusts the level at which black areas in text and line art are delineated, improving text recognition in OCR (Optical Character Recognition) programs.

Color Enhance

Enhances the shades of the color you select in the scanned image. This setting is available only if you select **Grayscale** or **Black & White** as the Image Type setting.

Brightness

Adjusts the overall lightness and darkness of the scanned image.

Contrast

Adjusts the difference between the light and dark areas of the overall scanned image.

Saturation

Adjusts the density of colors in the overall image.

Gamma

Adjusts the midtone density of the scanned image.

Unsharp Mask

Makes the edges of certain image areas clearer. Turn off this option to leave softer edges.

Descreening

Removes the ripple pattern that might appear in subtly shaded image areas, such as skin tones. This option improves results when scanning magazines or newspapers. (The results of descreening do not appear in the preview image, only in your scanned image.)

Edge Fill

Corrects shadowing around the edges of the image by filling the shadows with black or white.

Parent topic: [Scanning in Epson Scan 2](#)

Saving Scanned Documents as a Searchable PDF Using Epson Scan 2

You can scan a document and save the text in a searchable PDF. In a searchable PDF, text is recognized using Optical Character Recognition (OCR) and then embedded in the scanned original.

Note: The required Epson Scan 2 OCR Component is installed automatically when you install your product software as instructed on the *Start Here* sheet. If you install your scanner software programs individually, be sure to also install this component if you want to perform OCR.

1. Load your original in the product for scanning.
2. Start Epson Scan 2.
3. Select your scan settings.
4. Click **Preview** and adjust the area you want to scan, if necessary.
5. Select **Searchable PDF** as the Image Format setting.
6. Select **Options** from the Image Format list.

You see this window:

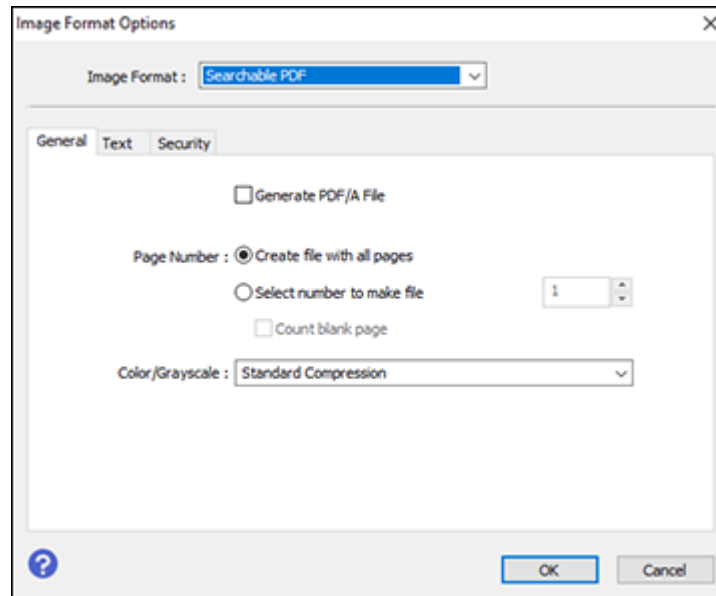

7. Select any of the options on the **General** tab.
8. Select the **Text** tab.
9. Make sure the language used in the document text is selected as the **Text Language** setting.
10. Select the **Security** tab if you want to add a password to the PDF or protect printing or editing properties.
11. Click **OK**.
12. Confirm the **File Name** setting and select a **Folder** setting for your document.
13. Click **Scan**.

The scanned image is saved as a searchable PDF.

Parent topic: [Scanning in Epson Scan 2](#)

Image Format Options

You can select different image formats and related options. For details on available options, click the ? icon on the Epson Scan 2 Image Format Options window. Not all image formats have options.

BITMAP (*.bmp)

A standard image file format for most Windows programs.

JPEG (*.jpg)

An image format that lets you highly compress image data. However, the higher the compression, the lower the image quality. (The TIFF format is recommended when you need to modify or retouch your scanned image.)

PNG (*.png)

An image format that does not lose quality during editing.

TIFF (*.tif)

A file format created for exchanging data between many programs, such as graphic and DTP software.

Multi-TIFF (*.tif)

A TIFF file format when multiple pages are saved to the same file, allowing you to edit the images using a compatible program.

PDF (*.pdf)

A document format that is readable by Windows and Mac systems using Adobe Reader, Acrobat, or other programs. You can save multi-page documents in one PDF file.

Searchable PDF (*.pdf)

A document format that is readable by Windows and Mac systems using Adobe Reader, Acrobat, or other programs. You can save multi-page documents in one PDF file. Recognized text in the scanned document can be searched.

Parent topic: [Scanning in Epson Scan 2](#)

Scan Resolution Guidelines

The **Resolution** setting, measured in dpi (dots per inch), controls the amount of detail captured in your scans. Increasing the resolution raises the amount of detail captured but comes with the following disadvantages:

- Larger file sizes
- It takes longer to scan your originals, send/receive your scans by email or fax, and to print your scans
- The image may become too large to fit on your display or print on paper

If you plan to enlarge a scanned image so you can print it at a larger size, you may need to increase the resolution from the default resolution set by Epson Scan 2. Follow these guidelines to determine the resolution setting you need:

- You will scan the image at its original size but enlarge it later in an image-editing program.

Increase the Epson Scan 2 Resolution setting in your scan. Increase the resolution by the same amount you will increase the image size to retain a high image quality. For example, if the resolution is 300 dpi (dots per inch) and you will double the image size later, change the Resolution setting to 600 dpi.

- You will scan the image at 100% or smaller size.

Select the Epson Scan 2 Resolution setting based on how you will use the scanned image:

- Email/view on a computer screen/post on the web: 96 to 200 dpi
- Print/fax/convert to editable text (OCR)/create searchable PDF: 200 to 300 dpi

Parent topic: [Scanning in Epson Scan 2](#)

Scanning to Online Destinations Using Easy Photo Scan

You can scan documents or photos and upload them to online destinations, such as photo-sharing sites, web servers, or network folders using Easy Photo Scan.

Note: If you are using your Epson product with the Windows 10 S operating system, you cannot use the software described in this section. You also cannot download and install any Epson product software from the Epson website for use with Windows 10 S; you must obtain software only from the Windows Store.

[Scanning Using Easy Photo Scan](#)

[Uploading Scanned Images to Google Photos](#)

[Uploading Scanned Images to Evernote](#)

[Uploading Scanned Images to SugarSync](#)

[Uploading Scanned Images to a Web Folder](#)

[Uploading Scanned Images to Email](#)

[Saving Scanned Images to a Folder](#)



Parent topic: [Scanning](#)

Scanning Using Easy Photo Scan

You can use Easy Photo Scan to easily scan your originals, edit the scanned images, and upload them to online destinations.

1. Place your original on your product for scanning.

2. Do one of the following to open Easy Photo Scan:

- **Windows 10:** Click  and select **Epson Software > Easy Photo Scan**. Select your product and click **OK**, if necessary.
- **Windows 8.x:** Navigate to the **Apps** screen and select **Easy Photo Scan**. Select your product and click **OK**, if necessary.
- **Windows (other versions):** Click  or **Start**, and select **All Programs** or **Programs**. Select **Epson Software > Easy Photo Scan**. Select your product and click **OK**, if necessary.
- **Mac:** Open the **Applications** folder, select **Epson Software**, and select **Easy Photo Scan**. Select your product and click **OK**, if necessary.

You see a window like this:

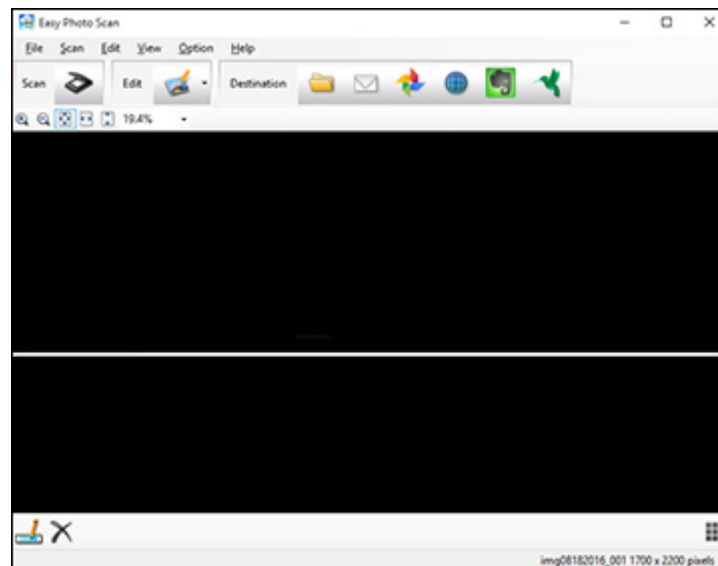



3. Click the  Scan icon.

Your scanning program launches.

4. Click **Scan** in the window that appears to scan your original.

The scanned image is displayed in the Easy Photo Scan window with an automatically generated name.

Note: You may need to close the scanning program window to display Easy Photo Scan.

5. To edit the name of the file, select the image thumbnail at the bottom of the screen, click the  icon, and enter the new filename.
6. To edit the scanned image, click the  Edit icon and select one of the displayed options.

Note: See the Easy Photo Scan help for additional information on image editing options.

7. Repeat these steps for each image you want to upload.
8. When you finish scanning, click one of the destination icons to upload the images.

Note: You may need to click the arrow next to the icons in order to see all of them. The available icons may vary, depending on the software version you are using.

Parent topic: [Scanning to Online Destinations Using Easy Photo Scan](#)

Related tasks

[Uploading Scanned Images to Google Photos](#)

[Uploading Scanned Images to Evernote](#)

[Uploading Scanned Images to SugarSync](#)

[Uploading Scanned Images to a Web Folder](#)

[Uploading Scanned Images to Email](#)

Uploading Scanned Images to Google Photos

You can configure a Google Photos account for use with Easy Photo Scan and upload your scanned images.

1. Scan your original using Easy Photo Scan.
2. Click the  icon.

You see a window like this:

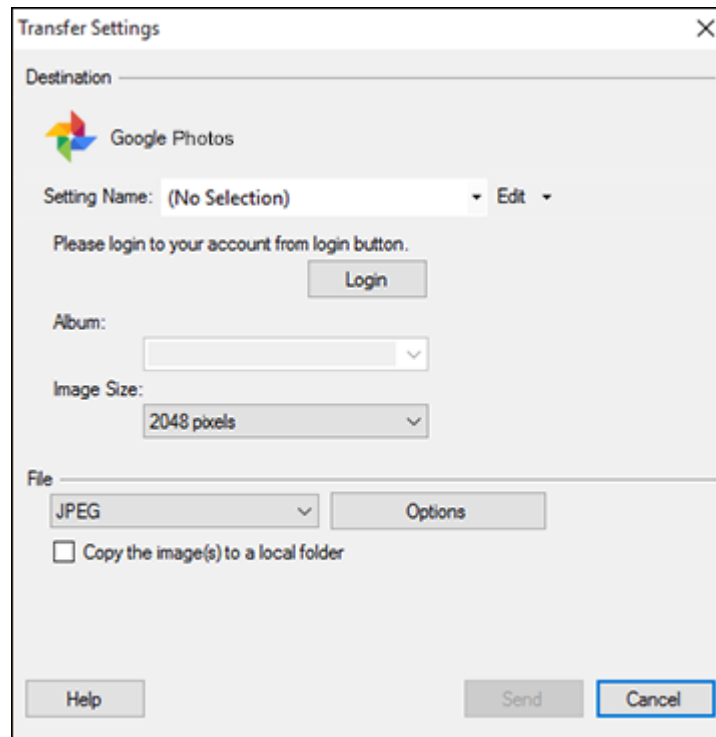

Note: If you have already configured a Google Photos account in Easy Photo Scan, you can select the **Setting Name** or **Destination Name** for the account, click **Login** if necessary, and click **Send** to upload your images.

3. Click **Login**.
4. On the Application Authentication screen, log into your Google account.
5. Click **Accept** to allow Easy Photo Scan to upload images to your account.
An authentication code is generated.
6. Copy the authentication code into the **Please enter authentication code** field and click **OK**.

7. Select an album from the **Album** list.

Note: If you cannot select an album, make sure the Setting Name is set to **(No Selection)**, click the **Login** button to log into your Google Photos account, and try again. If you want to create a new album, you must create it directly in Google Photos.

8. Select an **Image Size** option for the uploaded images.
9. Select the image format for the uploaded files from the **File** or **File Type** list.
10. If there are options for the selected file format, click **Options** or **Option** and select the options you want.
11. If you also want to save the images to a local folder, select the **Copy the image(s) to a local folder** checkbox and select a folder.
12. If you want to save the current settings, click **Edit**, or the **Setting Name** or **Destination Name** field, and select **Save As**. Enter a name for the setting and click **OK**.
13. Click **Send** to upload the images to your Google Photos account, or click **Cancel** to cancel the operation.

Parent topic: [Scanning to Online Destinations Using Easy Photo Scan](#)

Related tasks

[Saving Scanned Images to a Folder](#)

Uploading Scanned Images to Evernote

You can configure an Evernote account for use with Easy Photo Scan and upload your scanned images to it (Windows only).

Note: You must install Evernote before you can use it with Easy Photo Scan.

1. Scan your original using Easy Photo Scan.
2. Click the  icon.

You see a window like this:

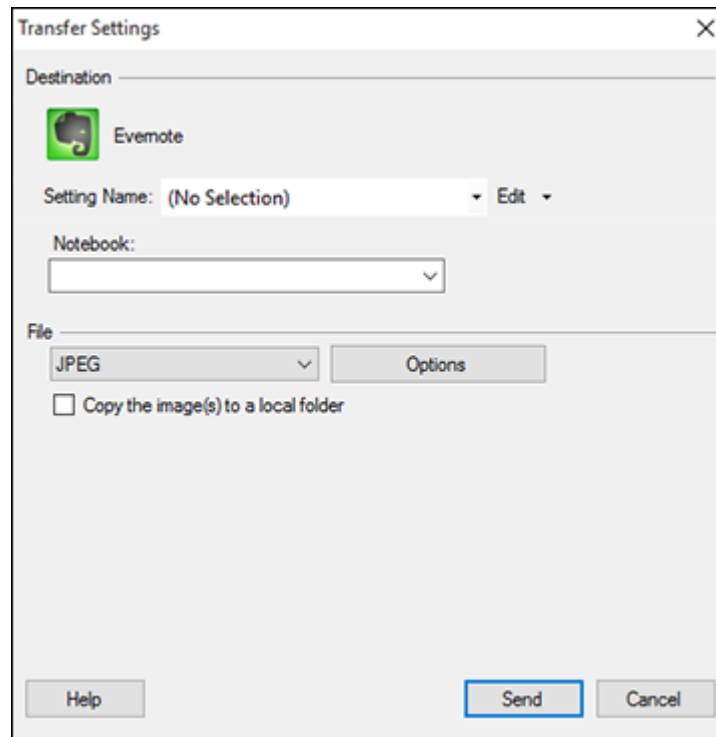

Note: If you have already configured an Evernote account in Easy Photo Scan, you can select the **Setting Name** or **Destination Name** for the account and click **Send** to upload your images.

3. Select a notebook from the **Notebook** list.

Note: If you want to create a new notebook, you must create it directly in Evernote.

4. Select the image format for the uploaded files from the **File** or **File Type** list.
5. If there are options for the selected file format, click **Options** or **Option** and select the options you want.
6. If you also want to save the images to a local folder, select the **Copy the image(s) to a local folder** checkbox and select a folder.

7. If you want to save the current settings, click **Edit**, or the **Setting Name** or **Destination Name** field, and select **Save As**. Enter a name for the setting and click **OK**.
8. Click **Send** to upload the images to your Evernote account, or click **Cancel** to cancel the operation.

Parent topic: [Scanning to Online Destinations Using Easy Photo Scan](#)

Related tasks

[Saving Scanned Images to a Folder](#)

Uploading Scanned Images to SugarSync

You can configure a SugarSync account for use with Easy Photo Scan and upload your scanned images.

1. Scan your original using Easy Photo Scan.
2. Click the  icon.

You see a window like this:

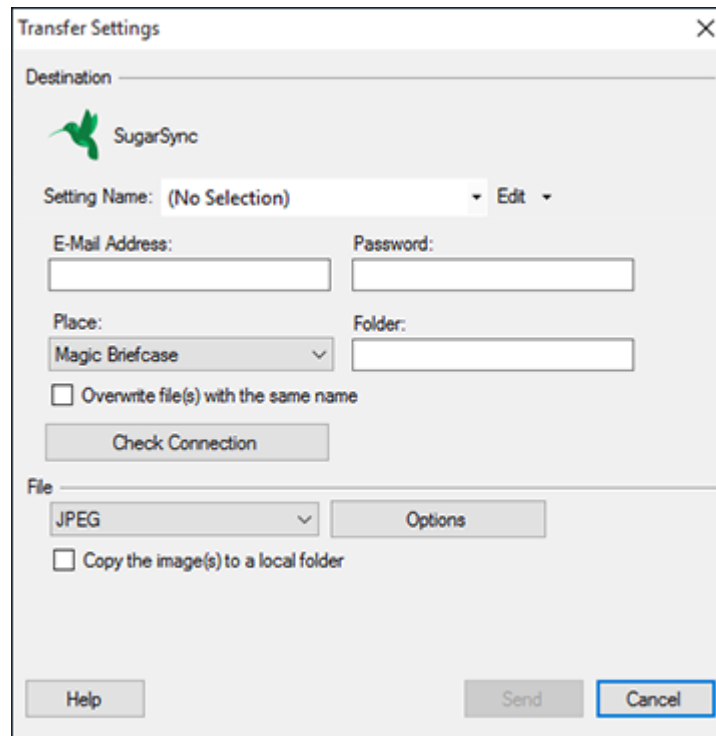

The screenshot shows a dialog box titled "Transfer Settings" with a close button (X) in the top right corner. The dialog is divided into several sections:

- Destination:** A horizontal line separates this section from the one below. Below it is the SugarSync logo (a green hummingbird) and the text "SugarSync".
- Setting Name:** A dropdown menu currently showing "(No Selection)" and an "Edit" button to its right.
- E-Mail Address:** A text input field.
- Password:** A text input field.
- Place:** A dropdown menu currently showing "Magic Briefcase".
- Folder:** A text input field.
- Overwrite:** A checkbox labeled "Overwrite file(s) with the same name", which is currently unchecked.
- Check Connection:** A button.
- File:** A horizontal line separates this section from the one above. Below it is a dropdown menu currently showing ".JPEG" and an "Options" button to its right.
- Copy to Local:** A checkbox labeled "Copy the image(s) to a local folder", which is currently unchecked.

At the bottom of the dialog, there are three buttons: "Help", "Send", and "Cancel". The "Cancel" button is highlighted with a blue border.

Note: If you have already configured a SugarSync account in Easy Photo Scan, you can select the **Setting Name** or **Destination Name** for the account and click **Send** to upload your images.

3. Enter the account information in the **E-Mail Address** and **Password** fields.
4. Select a **Place** option for the uploaded images.

Note: In SugarSync, the Magic Briefcase is now called "My SugarSync". Uploads to the Magic Briefcase appear in the My SugarSync folder.

5. Enter a folder name in the **Folder** field.
If you enter the name of an existing folder, the images are uploaded to that folder. If the folder does not exist, a new folder with that name is created.
6. If you want to replace existing files with the same name with the uploaded images, click the **Overwrite file(s) with the same name** checkbox.
7. Click **Check Connection** to test whether the SugarSync account information is correct.
8. Select the image format for the uploaded files from the **File** or **File Type** list.
9. If there are options for the selected file format, click **Options** or **Option** and select the options you want.
10. If you also want to save the images to a local folder, select the **Copy the image(s) to a local folder** checkbox and select a folder.
11. If you want to save the current settings, click **Edit**, or the **Setting Name** or **Destination Name** field, and select **Save As**. Enter a name for the setting and click **OK**.
12. Click **Send** to upload the images to your SugarSync account, or click **Cancel** to cancel the operation.

Parent topic: [Scanning to Online Destinations Using Easy Photo Scan](#)

Related tasks

[Saving Scanned Images to a Folder](#)

Uploading Scanned Images to a Web Folder

You can upload your scanned images to a Web Folder (WebDAV) using Easy Photo Scan.

1. Scan your original using Easy Photo Scan.
2. Click the  icon.

You see a window like this:

Transfer Settings

Destination

Web Folder (WebDAV)

Setting Name: (No Selection) Edit

Address:
http://www.example.com/upload

User Name: Password:

Overwrite file(s) with the same name

Check Connection

File

JPEG Options

Copy the image(s) to a local folder

Help Send Cancel

Note: If you have already configured a Web Folder account in Easy Photo Scan, you can select the **Setting Name** or **Destination Name** for the account and click **Send** to upload your pictures.

3. Enter the Web Folder URL in the **Address** field.
4. Enter the login information in the **User Name** and **Password** fields.
5. If you want to replace existing files with the same name with the uploaded images, click the **Overwrite file(s) with the same name** checkbox.
6. Click **Check Connection** to test whether the account information is correct.
7. Select the image format for the uploaded files from the **File** or **File Type** list.
8. If there are options for the selected file format, click **Options** or **Option** and select the options you want.

9. If you also want to save the images to a local folder, select the **Copy the image(s) to a local folder** checkbox and select a folder.
10. If you want to save the current settings, click **Edit**, or the **Setting Name** or **Destination Name** field, and select **Save As**. Enter a name for the setting and click **OK**.
11. Click **Send** to upload the images to your Web Folder, or click **Cancel** to cancel the operation.

Parent topic: [Scanning to Online Destinations Using Easy Photo Scan](#)

Related tasks

[Saving Scanned Images to a Folder](#)

Uploading Scanned Images to Email

You can save your scanned images to a local network folder and send them by email using Easy Photo Scan.

Note: With Windows, Easy Photo Scan supports Microsoft Outlook 2000/2002/2003/2007/2010 (x86)/2013 (x86) and Windows Mail/Windows Live Mail. If you do not have one of these email applications, Easy Photo Scan saves the images, but the email application does not open.

1. Scan your original using Easy Photo Scan.
2. Click the  icon.

You see a window like this:

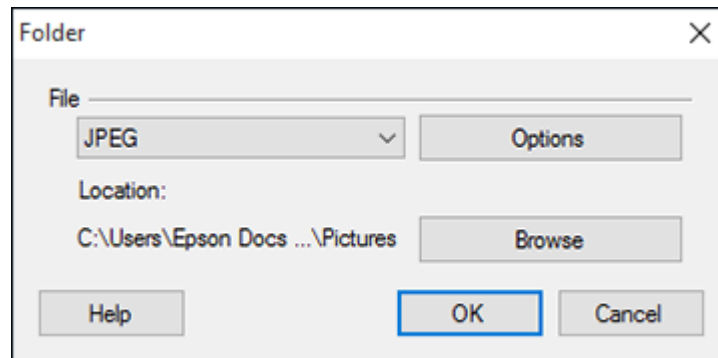

Note: On a Mac, you also enter an email address and email text in the window. If you have already configured email settings in Easy Photo Scan, you can select them using the **Destination Name** field.

3. Select the image format for the saved files from the **File** or **File Type** list.
4. If there are options for the selected file format, click **Options** or **Option** and select the options you want.
5. Do one of the following:
 - **Windows:** Click **Browse** to choose the folder where you want to save the images. Then click **OK** to save the images to the folder and launch your email program, or click **Cancel** to cancel the operation.
 - **Mac:** If you also want to save the images to a local folder, select the **Copy the image(s) to a local folder** checkbox and select a folder. Then click **Send**, or click **Cancel** to cancel the operation.

Parent topic: [Scanning to Online Destinations Using Easy Photo Scan](#)

Related tasks

[Saving Scanned Images to a Folder](#)

Saving Scanned Images to a Folder

You can save your scanned images to a local network folder using Easy Photo Scan.

1. Scan your original using Easy Photo Scan.
2. Click the  icon.

You see a window like this:

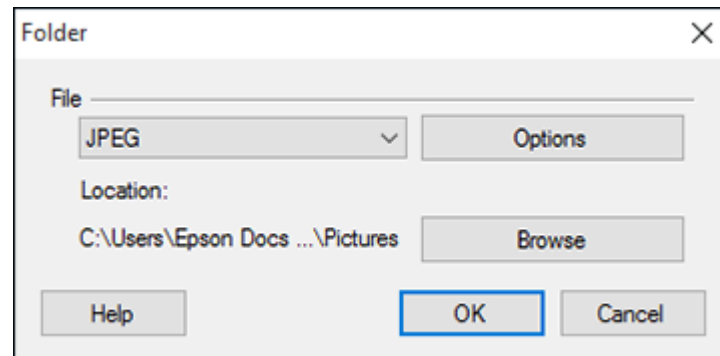

3. Select the image format for the saved files from the **File** or **File Type** list.
4. If there are options for the selected file format, click **Options** and select the options you want.

Note: See the help information in Easy Photo Scan for details on the file format options.

5. Click **Browse** or the **Save in** field to choose the folder where you want to save the images.
6. Click **OK** to save the images to the folder, or click **Cancel** to cancel the operation.

Parent topic: [Scanning to Online Destinations Using Easy Photo Scan](#)

Replacing Ink Cartridges and Maintenance Boxes

The maintenance box stores ink that gets flushed from the system during print head cleaning. When an ink cartridge is expended or the maintenance box is at the end of its service life, you need to replace it.

You may also need to replace a cartridge that is more than six months old if your printouts do not look their best, even after cleaning and aligning the print head.

Note: Please dispose of your used Epson branded ink cartridges and maintenance boxes responsibly and in accordance with local requirements. If you would like to return your used ink cartridges and maintenance boxes to Epson for proper disposal, please go to epson.com/recycle for more information.

[Check Cartridge and Maintenance Box Status](#)

[Purchase Epson Ink Cartridges and Maintenance Box](#)

[Removing and Installing Ink Cartridges](#)

[Printing with Black Ink and Expended Color Cartridges](#)

[Conserving Low Black Ink with Windows](#)

[Replacing the Maintenance Box](#)

Check Cartridge and Maintenance Box Status

Your product and its software will let you know when an ink cartridge is low or expended, or when the maintenance box needs to be replaced.

[Checking Cartridge and Maintenance Box Status on the LCD Screen](#)



[Checking Cartridge and Maintenance Box Status - Windows](#)

[Checking Cartridge and Maintenance Box Status - Mac](#)

Parent topic: [Replacing Ink Cartridges and Maintenance Boxes](#)

Checking Cartridge and Maintenance Box Status on the LCD Screen

You can check the status of the cartridges and maintenance box using the product's LCD screen.

1. Press the  home button, if necessary.
2. Select the  icon.

You see a screen like this:

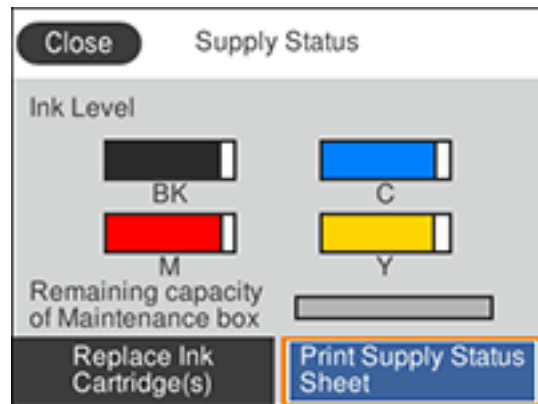

Note: The displayed ink and maintenance box levels are approximate.

3. To print a sheet with more information on the ink cartridges and maintenance box, select **Print Supply Status Sheet**.



Parent topic: [Check Cartridge and Maintenance Box Status](#)

Related tasks

[Removing and Installing Ink Cartridges](#)

Checking Cartridge and Maintenance Box Status - Windows

A low ink reminder appears if you try to print when ink is low, and you can check your cartridge or maintenance box status at any time using a utility on your Windows computer.

1. To check your status, access the Windows Desktop and double-click the  icon for your product in the right side of the Windows taskbar, or click the up arrow and double-click . Then click **Details**.

You see this window:



2. Replace or reinstall the maintenance box or any ink cartridge as indicated on the screen.

Note: If any of the cartridges installed in the product is broken, incompatible with the product model, or improperly installed, Epson Status Monitor will not display an accurate cartridge status.

3. To disable the low ink reminder, right-click the product icon in the Windows taskbar and select **Monitoring Preferences**.

You see this window:

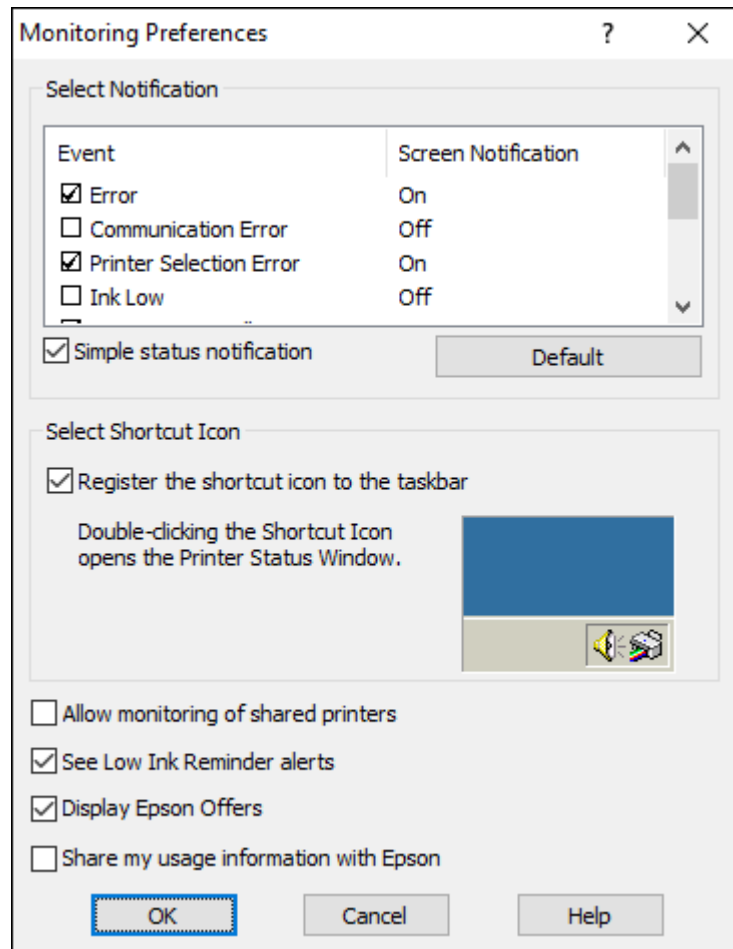

4. Deselect the **See Low Ink Reminder alerts** checkbox at the bottom of the screen.
5. To disable promotional offers, deselect the **Display Epson Offers** checkbox.
6. Click **OK**.

Parent topic: [Check Cartridge and Maintenance Box Status](#)

Related tasks

[Removing and Installing Ink Cartridges](#)

Checking Cartridge and Maintenance Box Status - Mac

You can check the status of your ink cartridges and maintenance box using a utility on your Mac.

1. Select **EPSON Status Monitor**.

You see this window:



2. Do the following as necessary:
 - You can update the ink cartridge and maintenance box status by clicking **Update**.

- Replace or reinstall the maintenance box or any ink cartridge as indicated on the screen.

Note: If any of the cartridges installed in the product is broken, incompatible with the product model, or improperly installed, Epson Status Monitor will not display an accurate cartridge status.

Parent topic: [Check Cartridge and Maintenance Box Status](#)

Related tasks

[Removing and Installing Ink Cartridges](#)

Purchase Epson Ink Cartridges and Maintenance Box

You can purchase genuine Epson ink, maintenance boxes, and paper at epson.com (U.S. sales), epson.ca (Canadian sales), or epson.com.jm (Caribbean sales). You can also purchase supplies from an Epson authorized reseller. To find the nearest one, call 800-GO-EPSON (800-463-7766) in the U.S. or 800-807-7766 in Canada.

Note: This printer is designed for use with Epson cartridges only, not third-party cartridges or ink. Other brands of ink supplies are not compatible and, if described as compatible, may not function properly or continuously. Such restrictions can be avoided with some other printers such as Epson EcoTank cartridge-free printers.

The included initial cartridges are designed for reliable printer setup and cannot be used as replacement cartridges or resold. After setup, the remaining ink is available for printing. Yields are based on ISO 24711 in default mode, printing continuously. Yields vary due to print images, settings, and temperatures. Printing infrequently or primarily with one color reduces yields. All cartridges must be installed with ink for printing and printer maintenance. For print quality, some ink remains in replaced cartridges.

[Ink Cartridge and Maintenance Box Part Numbers](#)

Parent topic: [Replacing Ink Cartridges and Maintenance Boxes](#)

Ink Cartridge and Maintenance Box Part Numbers

Use these part numbers when you order or purchase a new maintenance box or ink cartridges.

Maintenance box part number: C9344

Note: For best printing results, use up a cartridge within 6 months of opening the package.

Ink color	Part number	
	Standard-capacity	High-capacity
Black	212	212XL
Cyan	212	212XL
Magenta	212	212XL
Yellow	212	212XL

Parent topic: [Purchase Epson Ink Cartridges and Maintenance Box](#)

Related references

[Ink Cartridge Specifications](#)

Removing and Installing Ink Cartridges

Make sure you have your replacement cartridges handy before you begin. You must install new cartridges immediately after removing the old ones.

Caution: Leave your old cartridges in the product until you are ready to replace them to prevent the print head nozzles from drying out. Do not open ink cartridge packages until you are ready to install the ink. Cartridges are vacuum packed to maintain reliability.

Note: If you remove a low or expended ink cartridge, you cannot re-install and use the cartridge.

1. Turn on your product.
 - If an ink cartridge is expended, you see a message on the LCD screen. Note which cartridges need to be replaced and follow the on-screen instructions or the instructions below to replace the cartridge.
 - If you are replacing a cartridge before you see a message on the LCD screen, press the  home button if necessary, and select **Maintenance > Ink Cartridge(s) Replacement > Next > Start**.

Note: You can also select **How To** to view ink replacement instructions on the LCD screen.

2. Lift up the scanner unit until the support clicks into place.

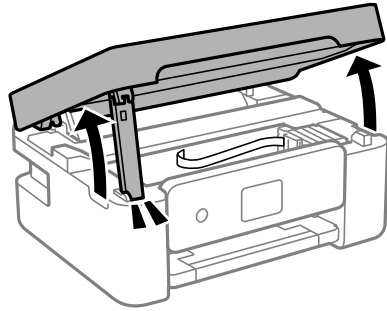

Caution: Do not move the print head by hand; otherwise, you may damage your product. Do not touch the flat white cable or translucent film inside the product.

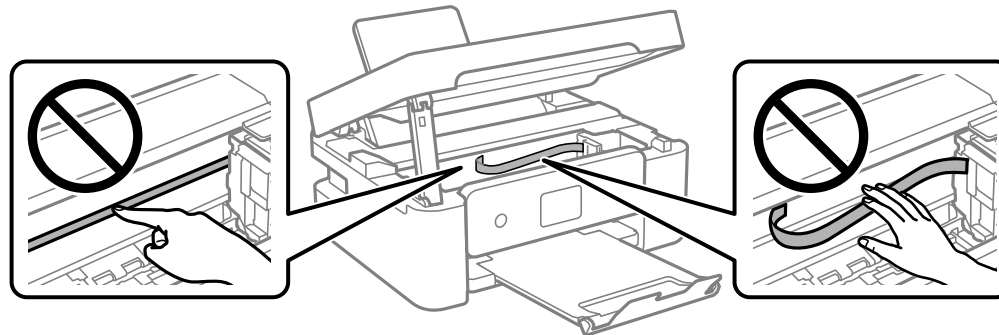

3. Squeeze the tab on the cartridge and lift the cartridge straight up to remove it.

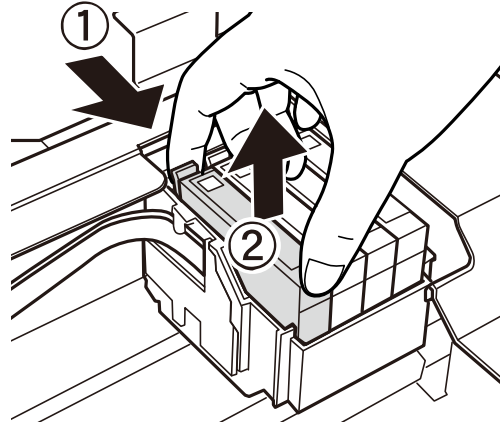

Note: Dispose of used cartridges carefully. Do not take the used cartridge apart or try to refill it.

Warning: If ink gets on your skin, wash it thoroughly with soap and water. If ink gets into your eyes, flush them immediately with water. If ink gets into your mouth, spit it out and see a doctor right away. Keep ink cartridges out of the reach of children.

4. If you are replacing the black ink cartridge, gently shake the new black ink cartridge four or five times before unpacking it. Do not shake the color ink cartridges.

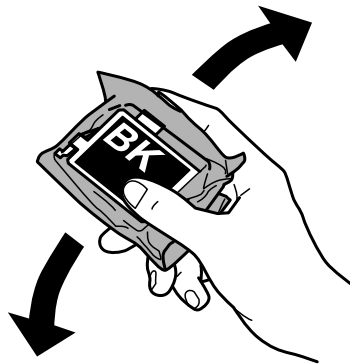

Caution: Do not shake the cartridges after opening the packages, or ink may leak.

5. Remove the cartridge from the package.

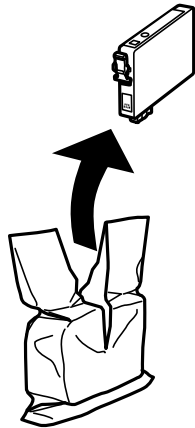

Caution: Do not touch the areas shown here. Doing so may prevent normal operation and printing.

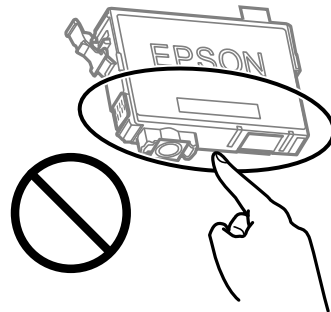

6. Remove the yellow tape from the cartridge.

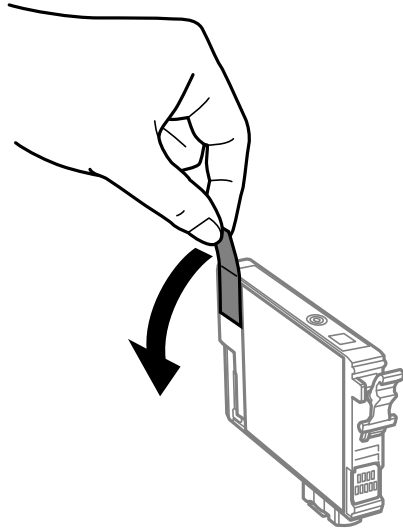

Caution: Do not remove any other labels or seals, or the ink cartridge may leak or become unusable.

7. Insert the new cartridge into the holder and push it down until it clicks into place and is level with the other cartridges.

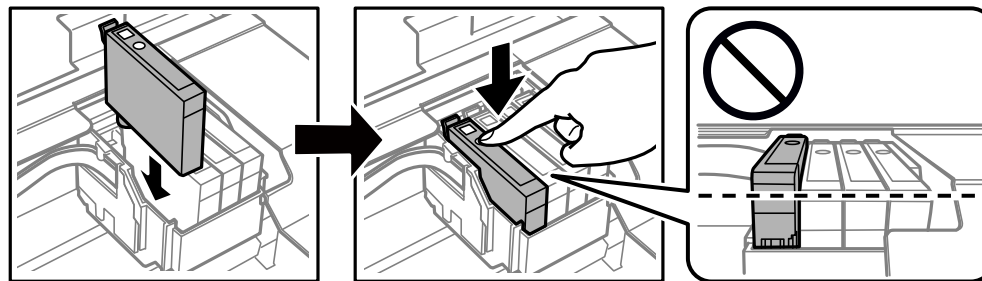

8. Lift the scanner unit up slightly and lower it. When the scanner unit catches, lift it up again and lower it completely.

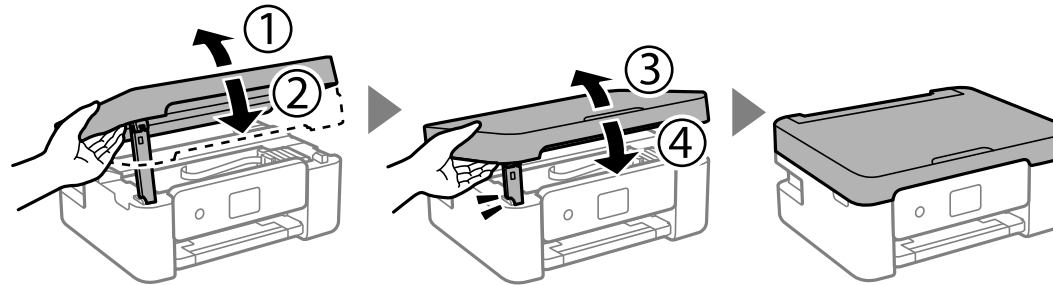

Note: The scanner unit cannot be opened from the position shown below. Close it completely before operating your product or opening the scanner unit again.

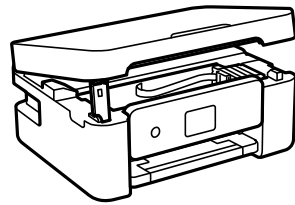

9. Select **Completed** on the LCD screen.

The print head moves to its home position and the product starts charging the ink. This takes a few minutes. When you see a completion message on the screen, ink replacement is finished.

Caution: Do not turn off the product while ink is charging or you may not be able to print.

Caution: If you remove an ink cartridge for later use, protect the ink supply area from dirt and dust and store it in the same environment as the printer. The valve in the ink supply port is designed to contain any excess ink, but do not touch the ink supply port or surrounding area. Always store ink cartridges with the label facing up; do not store cartridges upside-down.

Parent topic: [Replacing Ink Cartridges and Maintenance Boxes](#)

Related concepts

[Purchase Epson Ink Cartridges and Maintenance Box](#)

Related references

[Ink Cartridge Safety Instructions](#)

Printing with Black Ink and Expended Color Cartridges

When a color ink cartridge is expended, you can temporarily continue printing using black ink. Replace the expended color cartridge as soon as possible for future printing.

[Printing with Expended Color Cartridges - Control Panel](#)

[Printing with Expended Color Cartridges - Windows](#)

[Printing with Expended Color Cartridges - Mac](#)

Parent topic: [Replacing Ink Cartridges and Maintenance Boxes](#)

Printing with Expended Color Cartridges - Control Panel

If you see a message on the control panel to replace a color ink cartridge, you can temporarily print or copy in black ink.

Note the following restrictions when using this feature:

- You can print or copy only on plain paper or envelopes
 - You can print or copy only in black or grayscale
 - You cannot select borderless printing or copying
1. When you see a message on the LCD screen to replace a color ink cartridge, select **Proceed**.
You see a message that you can temporarily print with black ink.
 2. Select **Proceed** again.
 3. If you want to print or copy in black only, select **No, remind me later**.
The current print job is canceled.
 4. Press the  home button, if necessary.
 5. Try printing or copying again.

Parent topic: [Printing with Black Ink and Expended Color Cartridges](#)

Printing with Expended Color Cartridges - Windows

If you see a message during printing telling you that you can temporarily print in black ink with an expended color cartridge, you can cancel your print job and select settings to print on plain paper or on an envelope.

Note: If you are using your Epson product with the Windows 10 S operating system, you cannot use the software described in this section. You also cannot download and install any Epson product software from the Epson website for use with Windows 10 S; you must obtain software only from the Windows Store.

Note: To use this feature, Epson Status Monitor must be enabled.

1. Click **Cancel** or **Cancel Print** to cancel your print job.

Note: If the message screen appears on another computer on a network, you may need to cancel the print job using the product control panel.

2. Load plain paper or an envelope in your product.
3. Access the print settings in your print application.
4. Click the **Main** tab and make sure **Borderless** is not selected.
5. Select **Plain Paper/Bright White Paper** or **Envelope** as the paper type setting.
6. Select the **Black/Grayscale** checkbox.
7. Click **OK**.
8. Print your document.

Epson Status Monitor 3 displays a print message.

9. Click **Print in Black** to print your document.

Parent topic: [Printing with Black Ink and Expended Color Cartridges](#)

Printing with Expended Color Cartridges - Mac

If printing stops, you can cancel your print job and select settings to temporarily print with only black ink on plain paper or on an envelope.

1. Click the printer icon in the Dock.

2. If you see a message telling you that you can temporarily print with only black ink, click the **Delete** or  button to cancel your print job. If you see an error message, click **OK**.
3. In the Apple menu or the Dock, select **System Preferences**.
4. Select **Print & Fax**, **Print & Scan**, or **Printers & Scanners**, select your product, and select **Options & Supplies**.
5. Select **Driver** or **Options**.

You see a screen like this:

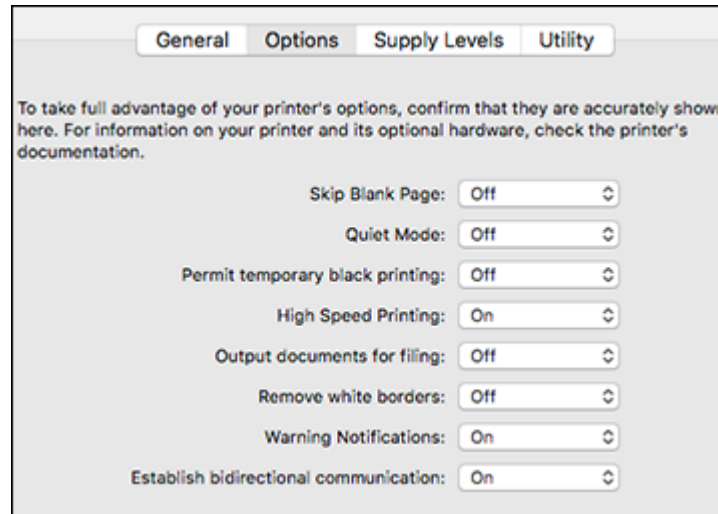

6. Select **On** as the **Permit temporary black printing** setting.
7. Click **OK**.
8. Close the utility window.
9. Load plain paper or an envelope in your product.
10. Access the print settings in your print application.
11. Select **Print Settings** from the pop-up menu.
12. Select **Plain Paper/Bright White Paper** or **Envelope** as the paper type setting.
13. Select the **Grayscale** option.
14. Click **Print** to print your document.

Parent topic: [Printing with Black Ink and Expended Color Cartridges](#)

Conserving Low Black Ink with Windows

The following window appears when black ink runs low and there is more color ink.

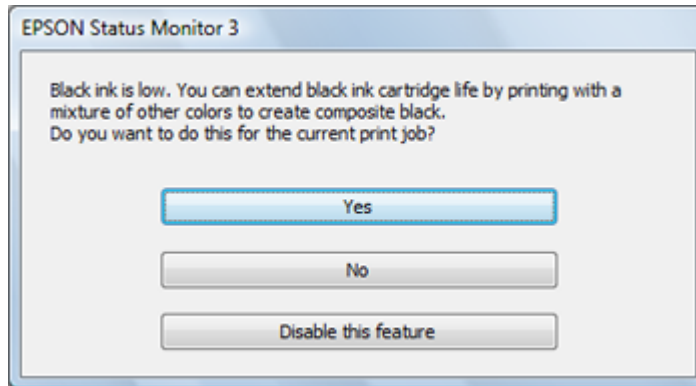

Note: The window appears only when you have selected **Plain Paper/Bright White Paper** as the paper type setting, and depends on other selected print settings. To use this feature, Epson Status Monitor must be enabled.

- Click **Yes** to use a mixture of color inks to create black, or **No** to continue using the remaining black ink for the document you are printing.
- Click **Disable this feature** to continue using the remaining black ink.

Note: If you disable this feature, it remains disabled until you install a new black ink cartridge.

Parent topic: [Replacing Ink Cartridges and Maintenance Boxes](#)

Related references

[Paper or Media Type Settings - Printing Software](#)

Replacing the Maintenance Box

Make sure you have a new maintenance box before you begin.

Caution: Do not reuse a maintenance box that has been removed and left uninstalled for more than a week. Keep the maintenance box away from direct sunlight.

1. Make sure the product is not printing.
2. Remove the new maintenance box from its package.

Caution: Do not touch the green chip on the maintenance box.

3. Use a flat-head screwdriver to loosen the screw on the maintenance box cover as shown, then remove the cover.

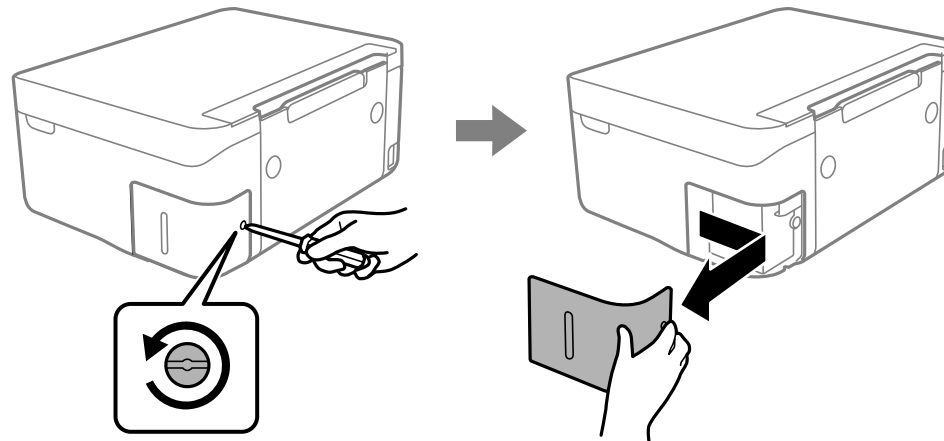

4. Grasp the maintenance box as shown and pull it out of its holder.

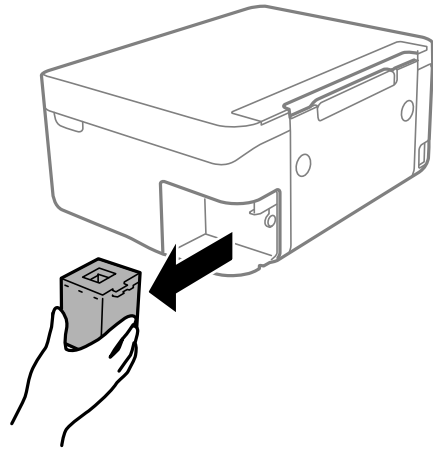

Note: Do not tilt the used maintenance box or take it apart, and do not touch the areas shown here.

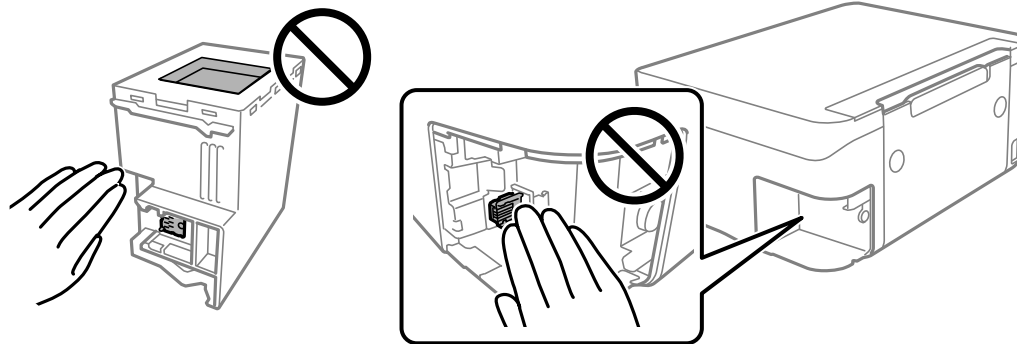

Warning: If ink gets on your skin, wash it thoroughly with soap and water. If ink gets into your eyes, flush them immediately with water. If ink gets into your mouth, spit it out and see a doctor right away. Keep the maintenance box out of the reach of children and do not drink the ink.

5. Place the used maintenance box in the plastic bag that came with the new maintenance box. Seal the bag and dispose of it carefully.

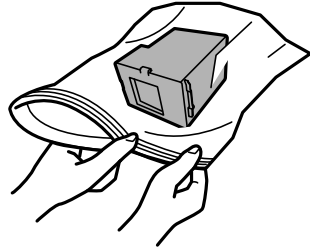

6. Insert the new maintenance box into the holder and push it all the way in until it clicks into place.

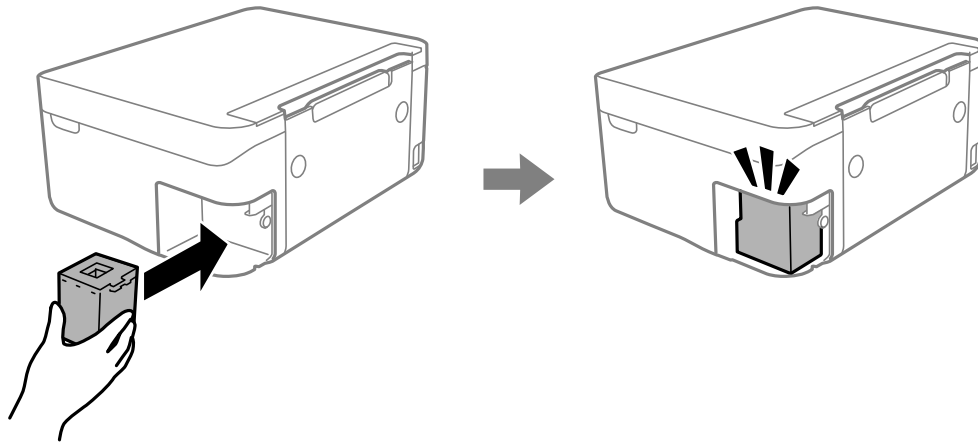

7. Insert the maintenance box cover and tighten the screw to secure the cover.

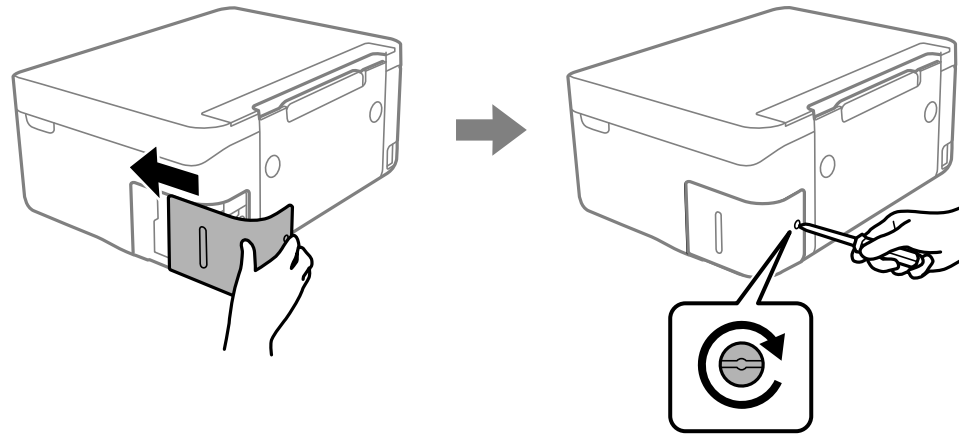

Parent topic: [Replacing Ink Cartridges and Maintenance Boxes](#)

Related concepts

[Purchase Epson Ink Cartridges and Maintenance Box](#)

Adjusting Print Quality

If your print quality declines, you may need to run a utility to clean or align the print head.

Note: If you are using your Epson product with the Windows 10 S operating system, you cannot use the software described in this section. You also cannot download and install any Epson product software from the Epson website for use with Windows 10 S; you must obtain software only from the Windows Store.

If running these utilities does not solve the problem, you may need to replace the ink cartridges.

[Print Head Maintenance](#)

[Aligning the Print Head Using the Product Control Panel](#)

[Cleaning the Paper Guide](#)

Print Head Maintenance

If your printouts become too light, or you see dark or light bands across them, you may need to clean the print head nozzles. Cleaning uses ink, so clean the nozzles only if print quality declines.

You can check for clogged nozzles before you clean them so you don't clean them unnecessarily.

Note: You cannot clean the print head if an ink cartridge is expended, and may not be able to clean it when a cartridge is low. You must replace the cartridge first.

[Print Head Nozzle Check](#)

[Print Head Cleaning](#)

Parent topic: [Adjusting Print Quality](#)

Print Head Nozzle Check

You can print a nozzle check pattern to check for clogged nozzles.

[Checking the Nozzles Using the Product Control Panel](#)

[Checking the Nozzles Using a Computer Utility](#)

Parent topic: [Print Head Maintenance](#)

Checking the Nozzles Using the Product Control Panel

You can check the print head nozzles using the control panel on your product.

1. Load a few sheets of plain paper in the product.
2. Press the  home button, if necessary.
3. Select **Maintenance**.

You see a screen like this:

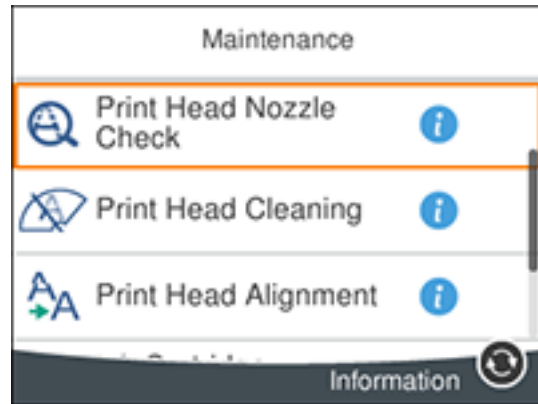

4. Select **Print Head Nozzle Check**.

You see a screen like this:

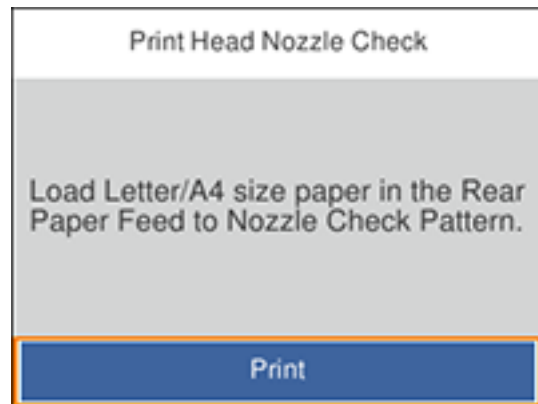

5. Select **Print**.

The nozzle pattern prints.

6. Check the printed pattern to see if there are gaps in the lines.

Print head is clean

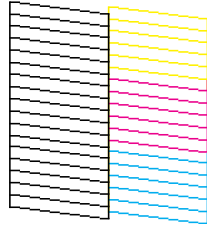

Print head needs cleaning

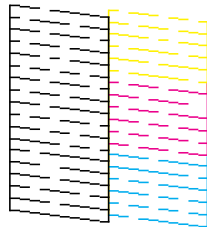

7. Do one of the following:
 - If there are no gaps, select **O**.
 - If there are gaps or the pattern is faint, select **X** and continue.
8. Follow the instructions on the screen to clean the print head, check the nozzles, and repeat the process as necessary.

Caution: Never turn off the product or open the front cover during a cleaning cycle or you may not be able to print.

If you don't see any improvement after cleaning the print head up to 4 times, wait at least 6 hours without printing or longer if printing. Then try cleaning the print head again. If quality still does not improve, contact Epson.

Parent topic: [Print Head Nozzle Check](#)

Related tasks



[Cleaning the Print Head Using the Product Control Panel](#)

Related topics

[Replacing Ink Cartridges and Maintenance Boxes](#)

Checking the Nozzles Using a Computer Utility

You can check the print head nozzles using a utility on your Windows or Mac computer.

1. Load a few sheets of plain paper in the product.
2. Do one of the following:
 - **Windows:** Access the Windows Desktop and right-click the  icon for your product in the right side of the Windows taskbar, or click the up arrow and right-click .
 - **Mac:** In the Apple menu or the Dock, select **System Preferences**. Select **Print & Fax**, **Print & Scan**, or **Printers & Scanners**, select your product, and select **Options & Supplies**. Select **Utility** and select **Open Printer Utility**.
3. Select **Nozzle Check**.

You see a window like this:

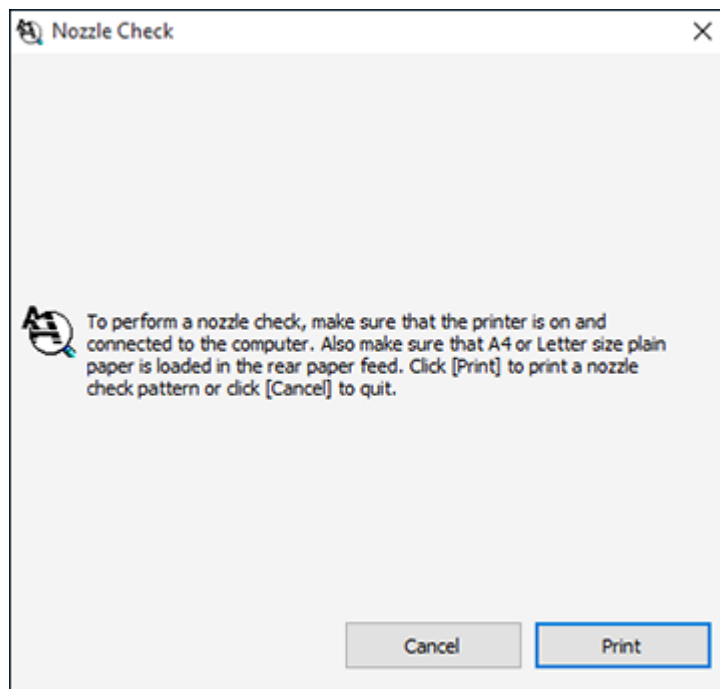

4. Click **Print**.

5. Check the printed pattern to see if there are gaps in the lines.

Print head is clean

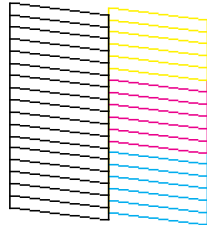

Print head needs cleaning

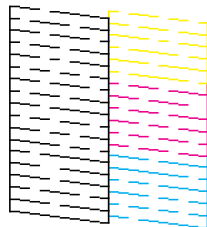

6. If there are no gaps, click **Finish**.

If there are gaps or the pattern is faint, clean the print head.

Parent topic: [Print Head Nozzle Check](#)

Related tasks

[Cleaning the Print Head Using a Computer Utility](#)

Related topics

[Replacing Ink Cartridges and Maintenance Boxes](#)

Print Head Cleaning

If print quality has declined and the nozzle check pattern indicates clogged nozzles, you can clean the print head.

Note: You cannot clean the print head if an ink cartridge is expended, and may not be able to clean it when a cartridge is low. You must replace the cartridge first.

[Cleaning the Print Head Using the Product Control Panel](#)
[Cleaning the Print Head Using a Computer Utility](#)

Parent topic: [Print Head Maintenance](#)

Cleaning the Print Head Using the Product Control Panel

You can clean the print head using the control panel on your product.

1. Load a few sheets of plain paper in the product.
2. Press the  home button, if necessary.
3. Select **Maintenance**.

You see a screen like this:

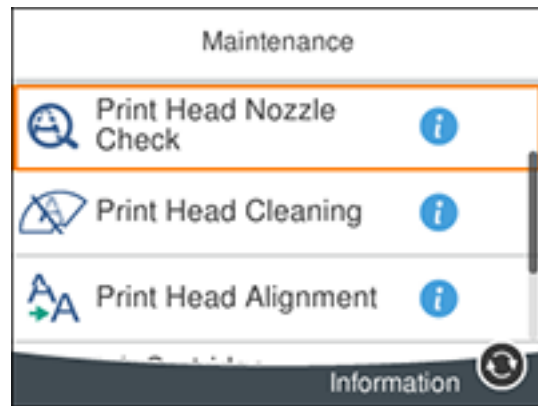

4. Select **Print Head Cleaning**.

You see a screen like this:

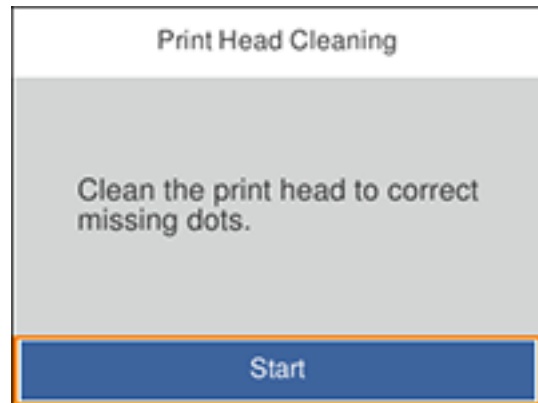

5. Select **Start** to clean the print head.

When the cleaning cycle is finished, you see a message on the screen.

Caution: Never turn off the product or open the scanner unit during a cleaning cycle or you may not be able to print.

6. Select **Check**.
7. Select **Print** to print a nozzle check pattern and confirm that the print head is clean.

If you don't see any improvement after cleaning the print head up to 4 times, wait at least 6 hours without printing or longer if printing. Then try cleaning the print head again. If quality still does not improve, contact Epson.

Parent topic: [Print Head Cleaning](#)

Related tasks

[Checking the Nozzles Using the Product Control Panel](#)

Related topics



[Replacing Ink Cartridges and Maintenance Boxes](#)

Cleaning the Print Head Using a Computer Utility

You can clean the print head using a utility on your Windows or Mac computer.

1. Load a few sheets of plain paper in the product.

2. Do one of the following:

- **Windows:** Access the Windows Desktop and right-click the  icon for your product in the right side of the Windows taskbar, or click the up arrow and right-click .
- **Mac:** In the Apple menu or the Dock, select **System Preferences**. Select **Print & Fax**, **Print & Scan**, or **Printers & Scanners**, select your product, and select **Options & Supplies**. Select **Utility** and select **Open Printer Utility**.

3. Select **Head Cleaning**.

You see a window like this:

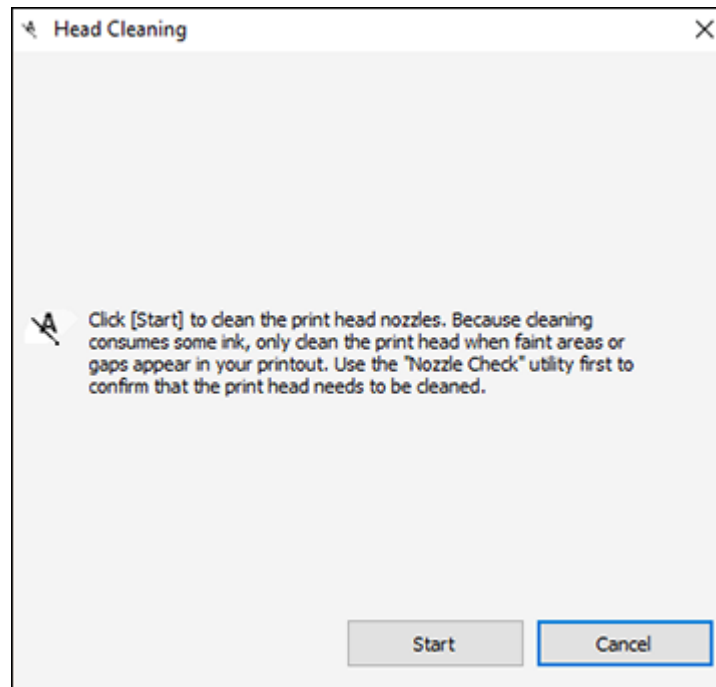

4. Click **Start** to begin the cleaning cycle.

The  power light flashes throughout the cleaning cycle and stays on when the cleaning cycle is finished.

Caution: Never turn off the product or open the scanner unit during a cleaning cycle or you may not be able to print.

5. When the cleaning cycle is finished, you can check to see if the nozzles are clean; click **Print Nozzle Check Pattern** and click **Print**.
6. Check the printed pattern to see if there are gaps in the lines.

Print head is clean

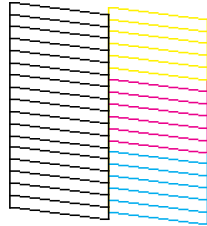

Print head needs cleaning

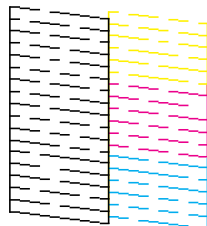

- If there are no gaps, click **Finish**.
- If there are gaps or the pattern is faint, click **Clean** to clean the print head again.

If you don't see any improvement after cleaning the print head up to 4 times, wait at least 6 hours without printing or longer if printing. Then try cleaning the print head again. If quality still does not improve, contact Epson.

Parent topic: [Print Head Cleaning](#)

Related tasks

[Checking the Nozzles Using a Computer Utility](#)

Related topics

[Replacing Ink Cartridges and Maintenance Boxes](#)

Aligning the Print Head Using the Product Control Panel

If your printouts become grainy or blurry, you notice misalignment of vertical lines, or you see dark or light horizontal bands, you may need to align the print head.

Note: Banding may also occur if your print head nozzles need cleaning.

1. Load a few sheets of plain paper in the product.
2. Press the  home button, if necessary.
3. Select **Maintenance**.

You see a screen like this:

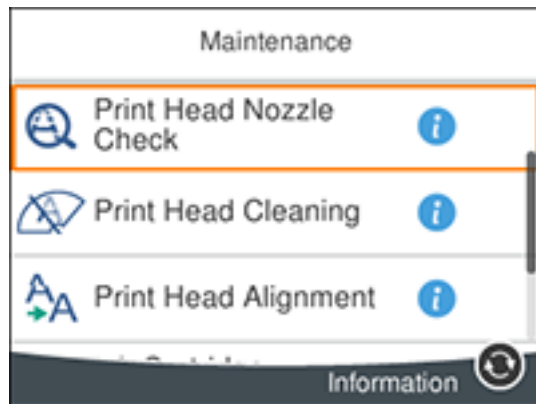

4. Select **Print Head Alignment**.
5. If your printout contains misaligned vertical lines or is blurry, continue with the next step. If your printout contains horizontal banding, go to step 8.
6. Select **Vertical Alignment** and follow the on-screen instructions to print an alignment sheet.
7. Check the printed pattern on the alignment sheet and for each set of patterns, select the number representing the pattern with the least amount of separation or overlap.
8. Select **Horizontal Alignment** and follow the on-screen instructions to print an alignment sheet.

9. Check the printed pattern on the alignment sheet and select the number representing the pattern with the least amount of separation or overlap.
10. Continue following the rest of the on-screen instructions to finish with the alignment.

Parent topic: [Adjusting Print Quality](#)

Cleaning the Paper Guide

If you see ink on the back of a printout, you can clean the paper guide rollers to remove any excess ink.

1. Load plain paper in this size: Letter (8.5 × 11 inches [216 × 279 mm]) or A4 (8.3 × 11.7 inches [210 × 297 mm]).
2. Press the  home button, if necessary..
3. Select **Maintenance**.

You see a screen like this:

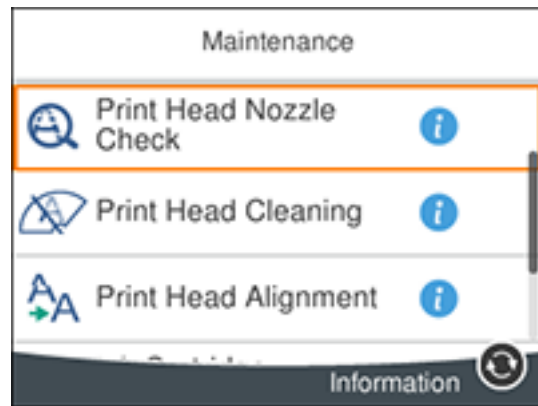

4. Scroll down and select **Paper Guide Cleaning**.
5. Follow the on-screen instructions to clean the paper guide.
6. Repeat these steps as necessary until the paper comes out clean.

Parent topic: [Adjusting Print Quality](#)

Related tasks

[Cleaning the Print Head Path](#)

Cleaning and Transporting Your Product

See these sections if you need to clean or transport your product.

[Cleaning Your Product](#)

[Cleaning the Print Head Path](#)

[Transporting Your Product](#)

Cleaning Your Product

To keep your product working at its best, you should clean it several times a year.

Close the output tray and paper support when you are not using the product to protect it from dust.

Caution: Do not use a hard brush, alcohol, or paint thinner to clean the product or you may damage it. Do not use oil or other lubricants inside the product or let water get inside it.

1. Turn off the product.
2. Unplug the power cable.
3. Disconnect any connected cables.
4. Remove all the paper.
5. Clean the scanner glass with a soft, lint-free cloth (microfiber is recommended), moistened with a little glass cleaner.

Caution: Do not spray glass cleaner directly on the glass and do not press the glass surface with any force.

6. Clean the outer case and control panel with a soft, dry cloth. Do not use liquid or chemical cleansers.

Parent topic: [Cleaning and Transporting Your Product](#)

Cleaning the Print Head Path

If the print quality has not improved after aligning the print head and cleaning the paper guide, the print head path inside the product may be smeared with ink.

To clean the print head path, use the following:

- Several cotton swabs

- ¼ cup (59 ml) water containing 2 to 3 drops of mild dish detergent
- A small flashlight

Caution: Do not use any other liquid to clean the print head path or you may damage your product.

1. Turn off the product.
2. Unplug the power cable.
3. Disconnect any connected cables.
4. Lift up the scanner unit.

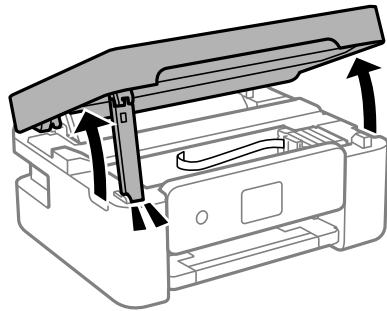

5. Using the flashlight, check the translucent film shown here for ink smears.

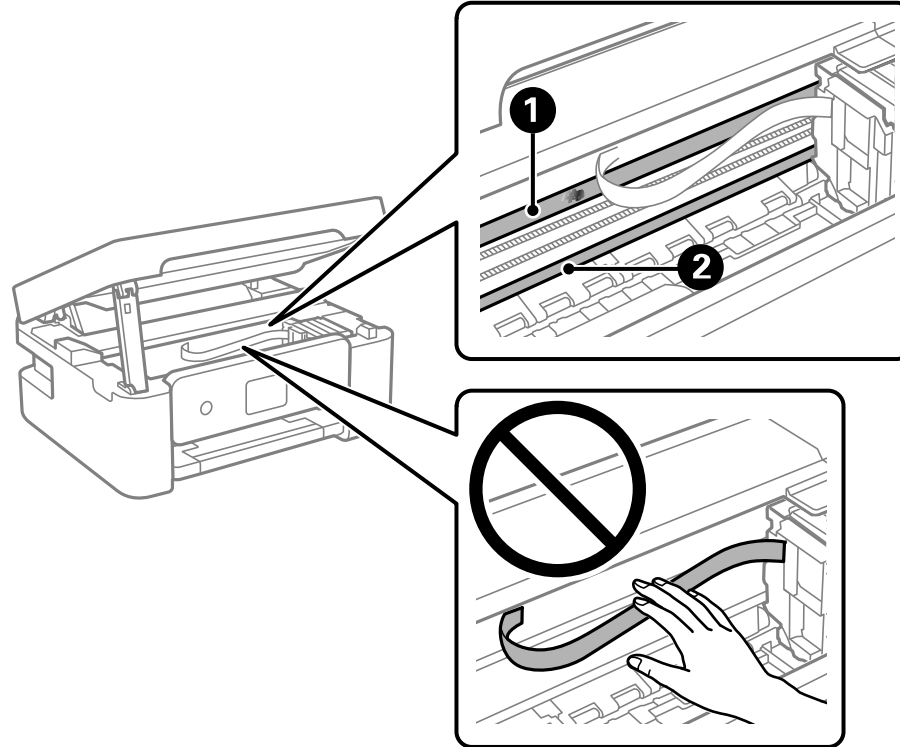

- 1 Translucent film
- 2 Print head rail

Caution: Do not touch the flat white cable or the print head rail; otherwise, you may not be able to print. Do not wipe off the grease on the rail.

6. Moisten a cotton swab with the water and detergent mixture and squeeze out any excess moisture. Use it to lightly wipe ink off the translucent film.

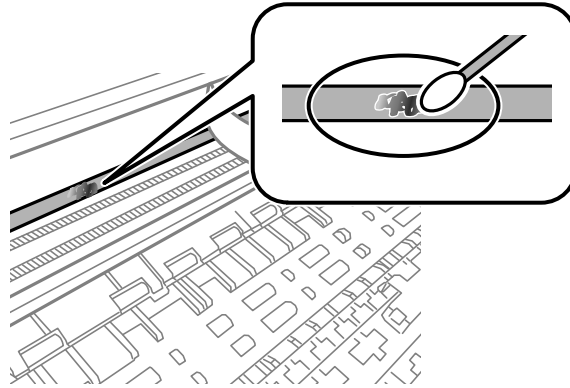

Caution: Do not press too hard on the film or you may dislocate the anchor springs and damage the product.

7. Use a new, dry cotton swab to dry the translucent film.
8. Repeat steps 6 and 7 as necessary to clean all ink smears.
9. When the translucent film is dry, close the scanner unit.
10. Plug in the power cable and reconnect any interface cables.

Parent topic: [Cleaning and Transporting Your Product](#)

Related tasks

[Aligning the Print Head Using the Product Control Panel](#)

[Cleaning the Paper Guide](#)

Transporting Your Product

If you need to store your product or transport it a long distance, prepare it for transportation as described here.

Caution: During transportation and storage, follow these guidelines:

- Avoid tilting the product or turning it upside down. Also avoid placing the product on its side for an extended period of time. Ink may leak.

- Leave the ink cartridges installed. Removing the cartridges can dry out the print head and may prevent the product from printing.
- Do not carry the product by its control panel; this may damage the product.

Note: Before storing your product for a long period, replace low, expended, or expired ink to help prevent the print head from drying out. Store your product in a cool, dry place.

1. Turn off the product.
2. Lift up the scanner unit and check to see if the print head is in the far right position (the home position). If not, turn on the product, wait for the print head to move, then turn the product off again.

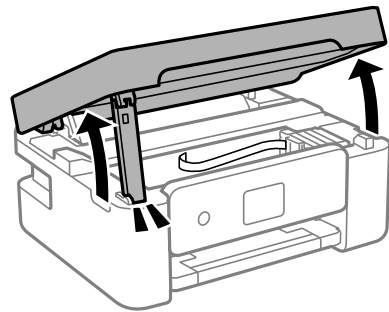

- Secure the ink cartridge holder to the case with tape.

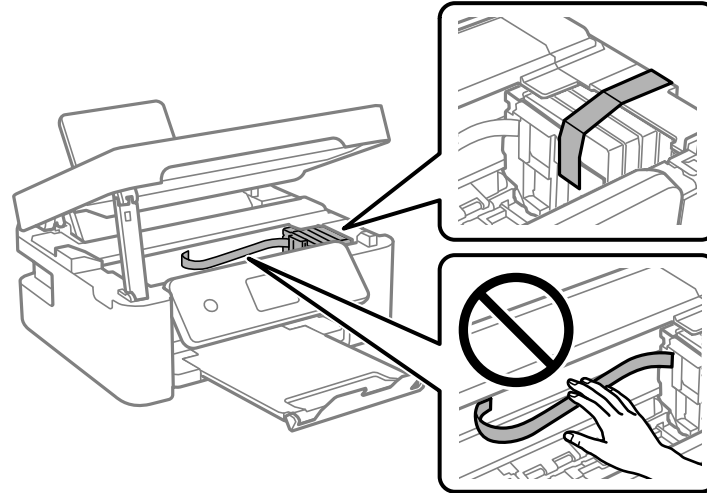

Caution: Do not place tape on the white flat cable inside the product; otherwise, you may damage your product.

- Lower the scanner unit all the way as shown.

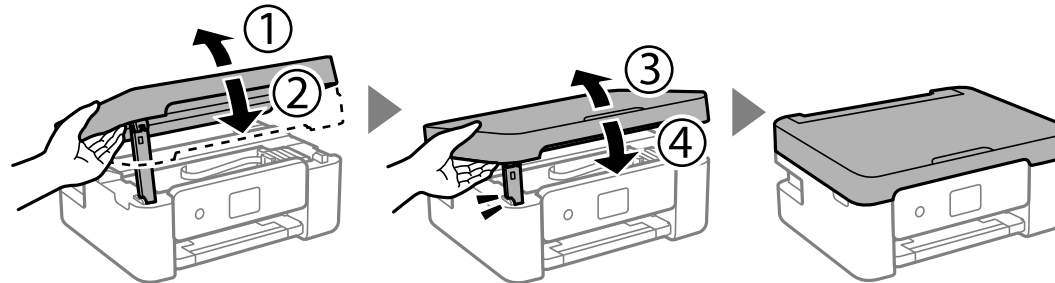

- Remove all the paper from the product.
- Unplug the power cable.
- Disconnect any connected cables.

8. Close all parts on the product as shown.

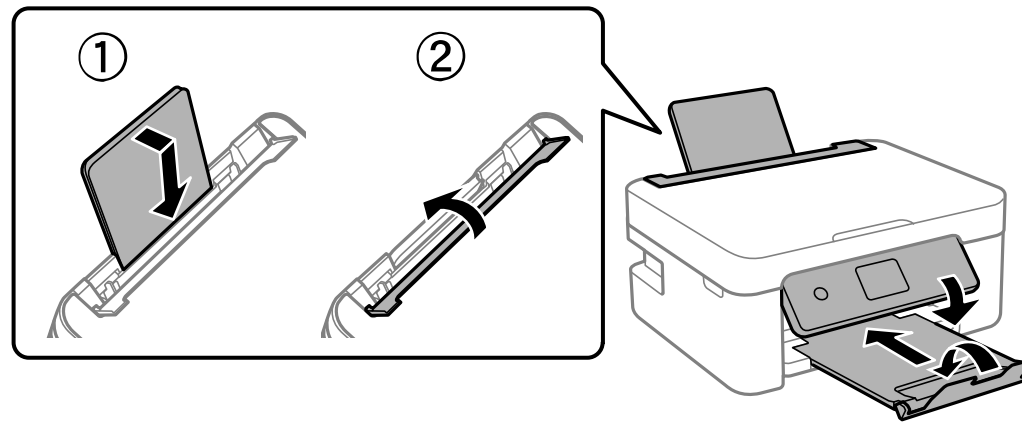

9. Place the product in its original packing materials, if possible, or use equivalent materials with cushioning around the product.

Keep the product level during transportation. Be sure to remove the tape from the ink cartridge holder before turning on your product. If print quality has declined when you print again, clean and align the print head.

Parent topic: [Cleaning and Transporting Your Product](#)

Related concepts

[Print Head Nozzle Check](#)

[Print Head Cleaning](#)

Related tasks

[Aligning the Print Head Using the Product Control Panel](#)

Solving Problems

Check these sections for solutions to problems you may have using your product.

[Checking for Software Updates](#)

[Product Status Messages](#)

[Running a Product Check](#)

[Resetting Control Panel Defaults](#)

[Solving Setup Problems](#)

[Solving Network Problems](#)

[Solving Copying Problems](#)

[Solving Paper Problems](#)

[Solving Problems Printing from a Computer](#)

[Solving Page Layout and Content Problems](#)

[Solving Print Quality Problems](#)

[Solving Scanning Problems](#)

[Solving Scanned Image Quality Problems](#)



[Uninstall Your Product Software](#)

[Where to Get Help](#)

Checking for Software Updates

It's a good idea to check Epson's support website occasionally for free updates to your product software. Visit epson.com/support (U.S.), epson.ca/support (Canada), or epson.com.jm/support (Caribbean) and select your product.

Note: Epson periodically provides firmware updates to address issues of security, performance, minor bug fixes and ensure your printer functions as designed. Your printer was designed to work only with genuine Epson ink cartridges, therefore some updates may affect the functionality of third-party ink.

- **Windows:** Your printer software automatically checks for updates. You can also manually update the software by selecting **Software Update** here:
 - Accessing the Windows Desktop and right-clicking the  icon for your product in the right side of the Windows taskbar, or clicking the up arrow and right-clicking .
 - On the **Maintenance** tab in the printer settings window

You can also update the software by selecting **EPSON Software Updater** in the **EPSON** or **EPSON Software** program group, accessible by the **Start** button, or on the **Start** or **Apps** screens, depending on your version of Windows.

- **OS X:** You can manually update the software by opening the **Applications > Epson Software** folder and selecting **EPSON Software Updater**.
- **macOS 10.12.x, 10.13.x, or 10.14.x:** You can manually update the software by opening the **App Store**, selecting **Updates**, searching for a software update option for Epson Software, and selecting **Update**.

Parent topic: [Solving Problems](#)

Product Status Messages

You can often diagnose problems with your product by checking the messages on its LCD screen. You can also press the  help button to see help information and how-to instructions on the screen.

LCD screen message	Condition/solution
Printer error. Turn on the printer again. See your documentation for more details.	A fatal error has occurred. Turn the product off and then back on again. If the error continues, check for a paper jam or any protective material inside the product. If there is no paper jam or protective material, contact Epson for support.
You need to replace Ink Cartridge(s).	The ink cartridge is expended. Replace the cartridge.
The printer's borderless printing ink pad is nearing the end of its service life. It is not a user-replaceable part. Please contact Epson support.	The ink pad is near the end of its service life and the message will be displayed until the ink pad is replaced. Contact Epson for support. (To resume printing, press the OK button.)
The printer's borderless printing ink pad has reached the end of its service life. It is not a user-replaceable part. Please contact Epson support.	The ink pad is at the end of its service life. Turn off the product and contact Epson for support.

LCD screen message	Condition/solution
Paper Configuration is set to Off. Some features may not be available. For details, see your documentation.	The Paper Configuration setting must be enabled to use AirPrint.
The combination of the IP address and the subnet mask is invalid. See your documentation for more details.	There is a problem with the network connection to your product. Check the solutions in this guide.
To use cloud services, update the root certificate from the Epson Web Config utility.	Access your product's built-in Web Config utility and update the root certificate for your product.
Check that the printer driver is installed on the computer and that the port settings for the printer are correct.	Make sure the printer port is selected correctly on the Port tab of the Printer Properties screen (Windows) or the System Properties > USB list (Mac). Select USBXXX for a USB connection or EpsonNet Print Port for a network connection.
Check that the printer driver is installed on the computer and that the USB port settings for the printer are correct.	
Recovery mode	An error has occurred during firmware updating. Connect your product using a USB cable and try updating the firmware again. If you still receive this error message, contact Epson for support.

Note: The ink pads in the printer collect, distribute, and contain the ink that is not used on printed pages. During the life of your product it may reach a condition where either satisfactory print quality cannot be maintained or the ink pads have reached the end of their usable life. The Epson Status Monitor, your LCD screen, or lights on the control panel will advise you when these parts need replacing. If this happens during the standard warranty of the product, the exchange of the product or replacement of the pads is covered under the standard warranty. If the product is out of warranty, the pads can be replaced by any Epson authorized service provider. The waste ink pads are not a user-replaceable part.

Parent topic: [Solving Problems](#)

Related references

[Paper Jam Problems Inside the Product](#)

[Where to Get Help](#)

Related tasks

[Selecting the Paper Settings - Control Panel](#)

[Accessing the Web Config Utility](#)

Related topics

[Loading Paper](#)

[Replacing Ink Cartridges and Maintenance Boxes](#)

Running a Product Check

Running a product check helps you determine if your product is operating properly.

1. Disconnect any interface cables connected to your product.
2. Make sure there are no errors on the LCD screen.
3. Load plain paper in the product.
4. Press the  home button, if necessary.
5. Select **Maintenance**.

You see a screen like this:

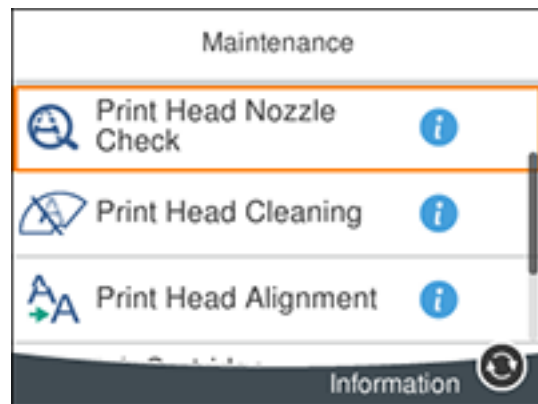

6. Select **Print Head Nozzle Check**.
7. Select **Print**.
The nozzle pattern prints.
8. Do one of the following, depending on the results of the product check:
 - If the page prints and the nozzle check pattern is complete, the product is operating properly. Any operation problem you may have could be caused by your computer, cable, software, or selected settings. Check the other solutions in this manual or try uninstalling and reinstalling your printer software.
 - If the page prints but the nozzle check pattern has gaps, clean the print head.
 - If the page does not print, the product may have a problem. Check the other solutions in this manual. If they do not work, contact Epson.

Parent topic: [Solving Problems](#)

Related concepts

[Print Head Maintenance](#)

[Uninstall Your Product Software](#)

Resetting Control Panel Defaults

If you have a problem with settings on the product control panel, you can reset them to their factory defaults. You can choose which settings to reset or reset them all.

1. Press the  home button, if necessary.
2. Select **Settings**.
3. Scroll down and select **Restore Default Settings**.

You see a screen like this:

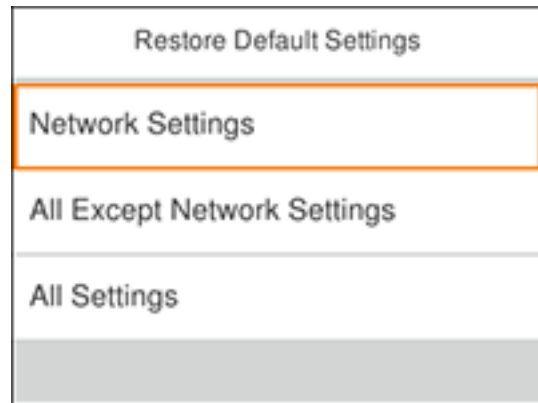

4. Select one of these options:
 - **Network Settings:** Resets all network settings
 - **All Except Network Settings:** Resets all settings except for network settings
 - **All Settings:** Resets all control panel settings

You see a confirmation screen.

5. Select **Yes** to reset the selected settings. (Select **No** if you want to cancel the operation.)

Parent topic: [Solving Problems](#)

Solving Setup Problems

Check these sections if you have problems while setting up your product.

[Product Does Not Turn On or Off](#)

[Noise After Ink Installation](#)

[Software Installation Problems](#)

Parent topic: [Solving Problems](#)

Product Does Not Turn On or Off

If you cannot turn the product on or off, try these solutions:

- If you cannot turn on your product, make sure the power cord is securely connected and hold down the power button a little longer.
- If you cannot turn off your product, hold down the power button a little longer. If you still cannot turn off your product, unplug the power cord, plug the power cord back in, then turn your product on and off again using the power button.

Parent topic: [Solving Setup Problems](#)

Noise After Ink Installation

If you hear noises from your product after installing ink, check the following:

- The first time you install the ink cartridges, the product must charge its print head. Wait until charging finishes before you turn off the product, or it may charge improperly and use excess ink the next time you turn it on.
- If the product's print head stops moving or making noise, and the charging process has not finished after approximately 5 minutes, turn off your product. Turn it back on and check to see if charging is still in progress. If it is still in progress, contact Epson for help.

Parent topic: [Solving Setup Problems](#)

Related references

[Where to Get Help](#)

Software Installation Problems

If you have problems while installing your product software, try these solutions:

- Make sure your product is turned on and any necessary cables are securely connected at both ends. If you still have problems installing software, disconnect the cable and carefully follow the instructions on the *Start Here* sheet. Also make sure your system meets the requirements for your operating system.
- Close any other programs, including screen savers and virus protection software, and install your product software again.
- In Windows, make sure your product is selected as the default printer and the correct port is shown in the printer properties.
- If you see any error message or your software does not install correctly in Windows, you may not have software installation privileges. Contact your system administrator.
- If you are printing over a network, make sure your product is set up properly on the network.

Parent topic: [Solving Setup Problems](#)

Related references

[Windows System Requirements](#)

[Mac System Requirements](#)

Solving Network Problems

Check these solutions if you have problems setting up or using your product on a network.

Note: Breakdown or repair of this product may cause loss of network data and settings. Epson is not responsible for backing up or recovering data and settings during or after the warranty period. We recommend that you make your own backup or print out your network data and settings.

[Product Cannot Connect to a Wireless Router or Access Point](#)

[Network Software Cannot Find Product on a Network](#)

[Product Does Not Appear in Mac Printer Window](#)

[Cannot Print Over a Network](#)

[Cannot Scan Over a Network](#)

[Wireless Network Connection is Unstable on a Mac](#)

Parent topic: [Solving Problems](#)

Related tasks

[Printing a Network Status Sheet](#)

Product Cannot Connect to a Wireless Router or Access Point

If your product has trouble finding or connecting to a wireless router or access point, try these solutions:

- If you are connecting the product via Wi-Fi Protected Setup (WPS) and the Wi-Fi icon on your product's LCD screen is not lit or does not appear, make sure you select one of the WPS options from the product control panel within 2 minutes of pressing the WPS button on your router.
- Make sure to place your product within contact range of your 2.4 GHz router or access point. Avoid placing your product near a microwave oven, 2.4 GHz cordless phone, or large metal object, such as a filing cabinet.

Note: If you are using a 5 GHz wireless router, set the router to operate in dual band (2.4 GHz and 5 GHz) mode. If your router uses a single network name (SSID) for both the 2.4 GHz and 5 GHz band, give each band its own network name (SSID) instead, such as Home Network 2.4 GHz and Home

Network 5 GHz. See your router documentation or contact your internet service provider for instructions.

- Verify that your router or access point is operating correctly by connecting to it from your computer or another device.
- Print a network connection report and check the codes and messages on the report to help determine the cause of the problem.
- You may need to disable the firewall and any anti-virus software on your wireless router or access point.
- Try restarting your router following the instructions in your router documentation.

Note: If you are reading these instructions online, you will lose your Internet connection when you restart your router.

- Check to see if access restrictions, such as MAC address filtering, are set on the router or access point. If access restrictions are set, add your product's MAC address to your router's address list. To obtain your product's MAC address, print a network status sheet. Then follow the instructions in your router or access point documentation to add the address to the list.
- If your router or access point does not broadcast its network name (SSID), follow the instructions that came with your product to enter your wireless network name manually.
- If your router or access point has security enabled, determine the kind of security it is using and any required password or passphrase for connection. Then make sure to enter the exact WEP key or WPA passphrase correctly.
- Check if your computer is restricting the available wireless channels. If so, verify that your wireless access point is using one of the usable channels and change to a usable channel, if necessary.
- If you are using a Wi-Fi Direct connection that suddenly disconnects, the Wi-Fi direct password on your device may have been changed. If necessary, delete the existing **DIRECT-xxxxxxx** connection settings from your device and enter a new password. See your device documentation for instructions.
- If you connected your product to a Windows computer using Wi-Fi Direct and it automatically selected Access Point Mode, you may have trouble accessing a low-priority Internet connection. Check the network connection or adapter settings in the Windows Control Panel and set the **Internet metric** setting to **100** for your version of the Internet Protocol.

Parent topic: [Solving Network Problems](#)

Related references

[Status Icon Information](#)

Related topics

[Wi-Fi Networking](#)

Network Software Cannot Find Product on a Network

If EpsonNet Setup cannot find your product on a network, try these solutions:

- Make sure your product is turned on and connected to your network. Verify the connection using your product control panel.
- Check if your network name (SSID) contains non-ASCII characters. Your product cannot display non-ASCII characters.
- Print a network connection report and check the codes and messages on the report to help determine the cause of the problem.
- Make sure your product is not connected to a guest network.
- If necessary, reinstall your product software and try running EpsonNet Setup again:
 1. Reset your product's network settings to their factory defaults.
 2. **Windows only:** Uninstall your product software.
 3. Restart your router following the instructions in your router documentation.

Note: If you are reading these instructions online, you will lose your Internet connection when you restart your router, so note the next step before restarting it.

4. Download your product software from the Epson website using the instructions on the *Start Here* sheet.
- If you have replaced your router, reinstall your product software to connect to the new router.

Note: If you are using a 5 GHz wireless router, set the router to operate in dual band (2.4 GHz and 5 GHz) mode. If your router uses a single network name (SSID) for both the 2.4 GHz and 5 GHz band, give each band its own network name (SSID) instead, such as Home Network 2.4 GHz and Home Network 5 GHz. See your router documentation or contact your internet service provider for instructions.

- Check to see if your wireless router or access point has an enabled Privacy Separator function that is preventing detection of your device over the network. See your router or access point documentation for instructions on disabling the Privacy Separator function.

Parent topic: [Solving Network Problems](#)

Related concepts

[Uninstall Your Product Software](#)

Related references

[Status Icon Information](#)

Related topics

[Wi-Fi Networking](#)

Product Does Not Appear in Mac Printer Window

If your product does not appear in the Mac printer window, try these solutions:

- Turn your product off, wait 30 seconds, then turn it back on again.
- If you are connecting the product via Wi-Fi Protected Setup (WPS) and the Wi-Fi icon on your product's LCD screen is not lit, make sure you select one of the WPS options from the product control panel within 2 minutes of pressing the WPS button on your router.
- If you are connecting the product wirelessly via EpsonNet Setup and the Wi-Fi icon does not appear lit on your LCD screen, make sure your product software was installed correctly. If necessary, reinstall your software.

Note: If you are using a 5 GHz wireless router, set the router to operate in dual band (2.4 GHz and 5 GHz) mode. If your router uses a single network name (SSID) for both the 2.4 GHz and 5 GHz band, give each band its own network name (SSID) instead, such as Home Network 2.4 GHz and Home Network 5 GHz. See your router documentation or contact your internet service provider for instructions.

Parent topic: [Solving Network Problems](#)

Related references

[Status Icon Information](#)

Related topics

[Wi-Fi Networking](#)

Cannot Print Over a Network

If you cannot print over a network, try these solutions:

- Make sure that your product is turned on.
- Make sure you install your product's network software as described in your product documentation.

- Print a network status sheet and verify that the network settings are correct. If the network status is **Disconnected**, check any cable connections and turn your product off and then on again.
- Print a network connection report and check the codes and messages on the report to help determine the cause of the problem.
- If you are using TCP/IP, make sure the product's IP address is set correctly for your network. If your network does not assign IP addresses using DHCP, set the IP address manually.
- Make sure your computer and product are both using the same wireless network.
- If network printing is slow, print a network status sheet and check the signal strength. If it is poor, place your product closer to your router or access point. Avoid placing your product near a microwave oven, 2.4 GHz cordless phone, or large metal object, such as a filing cabinet.

Note: If you are using a 5 GHz wireless router, set the router to operate in dual band (2.4 GHz and 5 GHz) mode. If your router uses a single network name (SSID) for both the 2.4 GHz and 5 GHz band, give each band its own network name (SSID) instead, such as Home Network 2.4 GHz and Home Network 5 GHz. See your router documentation or contact your internet service provider for instructions.

- Try restarting your router following the instructions in your router documentation.

Note: If you are reading these instructions online, you will lose your Internet connection when you restart your router.

- Check to see if your wireless router or access point has an enabled Privacy Separator function that is preventing printing from a device over the network. See your router or access point documentation for instructions on disabling the Privacy Separator function.

Parent topic: [Solving Network Problems](#)

Related references

[Status Icon Information](#)

Related topics

[Wi-Fi Networking](#)

Cannot Scan Over a Network

If you cannot start Epson Scan 2 for scanning over a network, try these solutions:

- If you cannot scan from your product control panel, make sure you restarted your computer after installing the product software. Make sure the Event Manager program is not being blocked by your firewall or security software.

Note: If you are using a 5 GHz wireless router, set the router to operate in dual band (2.4 GHz and 5 GHz) mode. If your router uses a single network name (SSID) for both the 2.4 GHz and 5 GHz band, give each band its own network name (SSID) instead, such as Home Network 2.4 GHz and Home Network 5 GHz. See your router documentation or contact your internet service provider for instructions.

- If you are scanning a large original at a high resolution, a network communication error may occur. Try scanning again at a lower resolution.
- If network communication was interrupted while starting Epson Scan 2, exit Epson Scan 2, wait a few seconds, and restart it. If Epson Scan 2 cannot restart, turn off your product, turn it back on, and try restarting Epson Scan 2 again.
- Check the scanner setting and reset the connection if necessary using Epson Scan 2 Utility:

Windows 10: Click  and select **EPSON > Epson Scan 2 Utility**. Make sure your product is selected. If necessary, select the **Other** tab and click **Reset**.

Windows 8.x: Navigate to the **Apps** screen, select **EPSON**, and select **Epson Scan 2 Utility**. Make sure your product is selected. If necessary, select the **Other** tab and click **Reset**.

Windows (other versions): Click  or **Start > All Programs** or **Programs > EPSON > Epson Scan 2 > Epson Scan 2 Utility**. Make sure your product is selected. If necessary, select the **Other** tab and click **Reset**.

Mac: Open the **Applications** folder, click **Epson Software**, and click **Epson Scan 2 Utility**. Make sure your product is selected. If necessary, select the **Other** tab and click **Reset**.

- You may need to disable the firewall and any anti-virus software on your wireless router or access point.

Parent topic: [Solving Network Problems](#)

Wireless Network Connection is Unstable on a Mac

If you connected a device to a USB 3.0 port on your Mac, you may experience wireless network interference between your product and your Mac.

If you cannot connect to your product over the wireless network or the connection becomes unstable, move the device connected to your Mac USB 3.0 port further away from your Mac.

Parent topic: [Solving Network Problems](#)

Solving Copying Problems

Check these solutions if you have problems copying with your product.

[Product Makes Noise, But Nothing Copies](#)

[Product Makes Noise When It Sits for a While](#)

Parent topic: [Solving Problems](#)

Product Makes Noise, But Nothing Copies

If your product makes a noise, but nothing copies, try these solutions:

- Run a nozzle check to see if any of the print head nozzles are clogged. Then clean the print head, if necessary.
- If the nozzle check page does not print, but the product's power is on, make sure your product software is installed correctly.
- Make sure your product is level (not tilted).

Parent topic: [Solving Copying Problems](#)

Related concepts

[Print Head Maintenance](#)

Product Makes Noise When It Sits for a While

Your product is performing routine maintenance. This is normal.

Parent topic: [Solving Copying Problems](#)

Solving Paper Problems

Check these sections if you have problems using paper with your product.

[Paper Feeding Problems](#)

[Paper Jam Problems Inside the Product](#)

[Paper Jam Problems in the Rear Cover](#)

[Paper Ejection Problems](#)

Parent topic: [Solving Problems](#)

Paper Feeding Problems

If you have problems feeding paper, try these solutions:

- Place the product on a flat surface.
- If paper does not feed for printing, remove it. Then reload it in the middle of the rear paper feed. Slide the edge guides against the edge of the paper, making sure that the paper stack is not above the arrow mark on the edge guides.
- If multiple pages feed at once, remove the paper, fan the edges to separate the sheets, and reload it.
- Do not load more than the recommended number of sheets.
- If paper jams when you print on both sides of the paper, try loading fewer sheets.
- Make sure your paper meets the specifications for your product.
- Make sure the paper size and paper type settings on the control panel are correct.
- Do not place objects on the feeder guard.
- For best results, follow these guidelines:
 - Use new, smooth, high-quality paper that is not curled, creased, old, too thin, or too thick.
 - Load paper in the rear paper feed printable side up.
 - Follow any special loading instructions that came with the paper.

Parent topic: [Solving Paper Problems](#)

Related references

[Paper Loading Capacity](#)

[Paper Specifications](#)

[Paper Jam Problems Inside the Product](#)

[Paper Jam Problems in the Rear Cover](#)

[Paper Ejection Problems](#)

Related tasks

[Loading Paper in the Rear Paper Feed](#)

Paper Jam Problems Inside the Product

If you see a message that paper has jammed inside the product, follow the steps here or on the LCD screen to clear the jam.

1. Cancel the print job, if necessary.

2. Remove any jammed paper from the rear paper feed slot and the ADF.
3. Lift the scanner unit and remove any jammed paper inside.

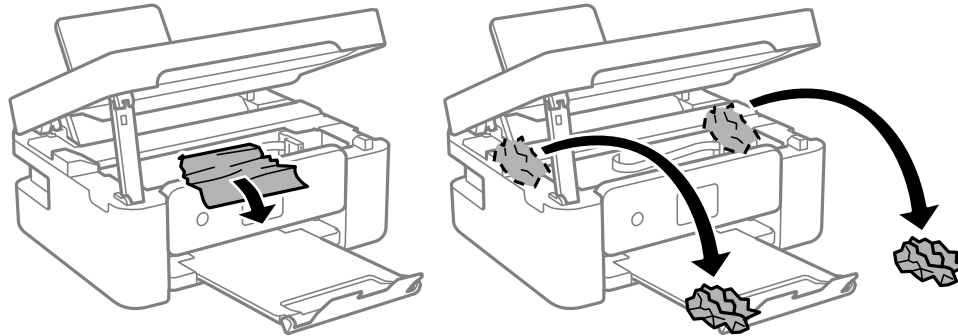

Caution: Do not touch the flat white cable or the translucent film inside your product.

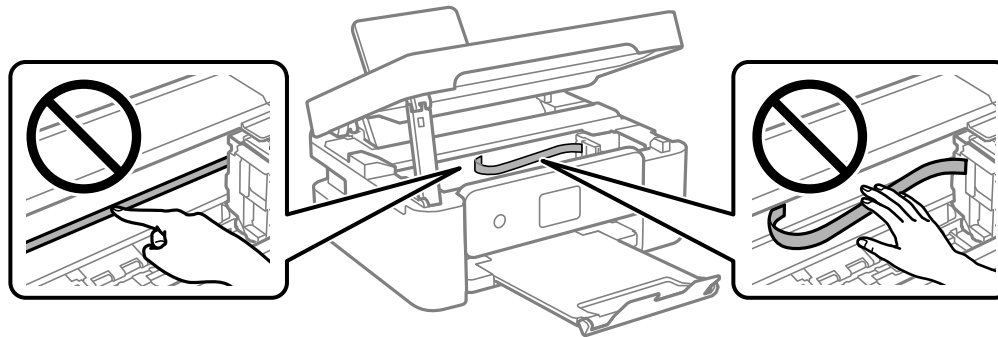

4. Close the scanner unit. Lift the scanner unit up slightly and lower it. When the scanner unit catches, lift it up again and lower it completely.

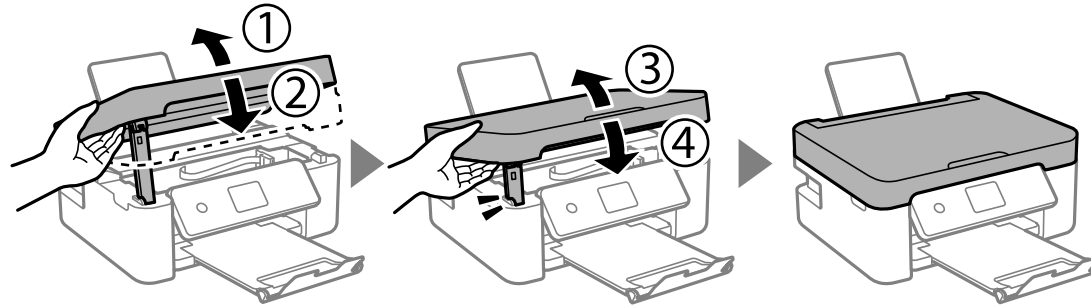

5. Follow the prompts on the LCD screen to clear any error messages. If you still see a paper jam message, check the other paper jam solutions.

Parent topic: [Solving Paper Problems](#)

Related references

[Paper Feeding Problems](#)

[Paper Ejection Problems](#)

Related topics

[Loading Paper](#)

Paper Jam Problems in the Rear Cover

If you see a message that paper has jammed in the rear cover, follow the steps here or on the LCD screen to clear the jam.

1. Cancel the print job, if necessary.

2. Press the buttons to release the rear cover and remove it from your product. Carefully remove any jammed paper from inside the product.

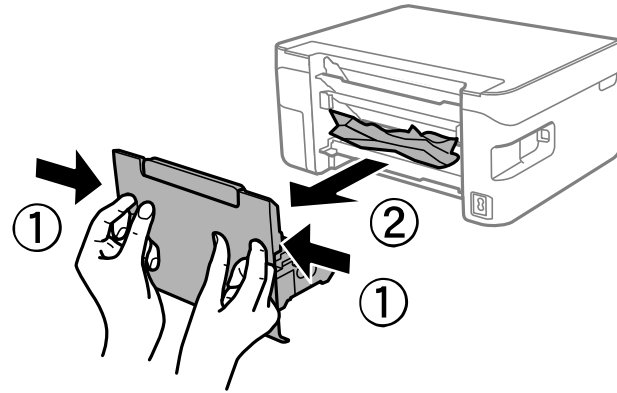

3. Remove any jammed paper from inside the rear cover.

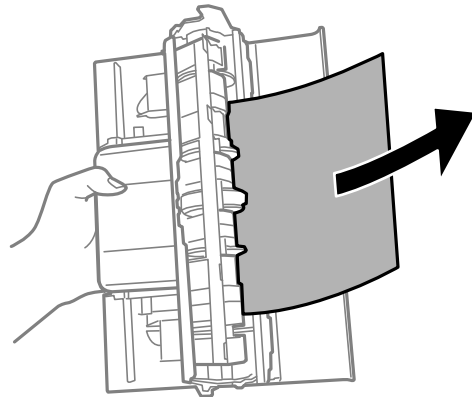

4. Reattach the rear cover.
5. Follow the prompts on the LCD screen to clear any error messages. If you still see a paper jam message, check the other paper jam solutions.

Parent topic: [Solving Paper Problems](#)

Related references

[Paper Feeding Problems](#)
[Paper Ejection Problems](#)

Related topics

[Loading Paper](#)

Paper Ejection Problems

If you have problems with paper ejecting properly, try these solutions:

- If paper does not eject fully, you may have set the wrong paper size. Cancel printing to eject the paper. Select the correct paper size when you reprint.
- If paper is wrinkled when it ejects, it may be damp or too thin. Load new paper and be sure to select the correct paper type setting when you reprint.

Parent topic: [Solving Paper Problems](#)

Related references

[Paper or Media Type Settings - Printing Software](#)
[Paper Type Settings - Control Panel](#)
[Paper Feeding Problems](#)
[Paper Jam Problems Inside the Product](#)
[Paper Jam Problems in the Rear Cover](#)

Related tasks

[Selecting the Paper Settings - Control Panel](#)

Related topics

[Loading Paper](#)

Solving Problems Printing from a Computer

Check these sections if you have problems while printing from your computer.

Note: When printing using AirPrint, the available print settings are different from those covered in this manual. See the Apple website for details.

[Nothing Prints](#)
[Product Icon Does Not Appear in Windows Taskbar](#)
[Printing is Slow](#)

Parent topic: [Solving Problems](#)

Nothing Prints

If you have sent a print job and nothing prints, try these solutions:

- Make sure your product is turned on and connected to your computer.
- Make sure any interface cables are connected securely at both ends.
- If you connected your product to a USB hub, make sure it is a first-tier hub. If it still does not print, connect your product directly to your computer instead of the hub.
- If the printer cannot print using a USB connection, disconnect the USB cable from the computer, right-click on the printer icon displayed on the computer, and select **Remove Device**. Then connect the USB cable to the computer and try a test print.
- Make sure the printer status is not offline or pending.
- Run a product check to see if a test page prints. If the test page prints, check to see if your product software is installed correctly.
- Make sure your system meets the requirements for your operating system. If you are printing a high-resolution image, you may need more than the minimum requirements. Print the image at a lower resolution or if necessary, increase your system's memory.
- In Windows, make sure your product is selected as the default printer and the printer port setting matches the printer connection port.
- In Windows, delete all jobs from the Windows Spooler. Click **Print Queue** on the Maintenance tab in the printer settings window, and cancel any stalled print jobs.
- On a Mac, make sure the printer is added to the printer list and the printer is not paused.

Parent topic: [Solving Problems Printing from a Computer](#)



Related references



[Product Status Messages](#)

Product Icon Does Not Appear in Windows Taskbar

If you do not see your product icon in the Windows taskbar, first try restarting your computer. If that does not work, try this solution:

1. Do one of the following:

- **Windows 10:** Click  and select  (Settings) > **Devices** > **Printers & scanners**. Select your product name and select **Manage** > **Printing preferences**.

- **Windows 8.x:** Navigate to the **Apps** screen and select **Control Panel > Hardware and Sound > Devices and Printers**. Right-click your product name, select **Printing Preferences**, and select your product name again if necessary.
 - **Windows 7:** Click  and select **Devices and Printers**. Right-click your product name, select **Printing Preferences**, and select your product name again if necessary.
 - **Windows Vista:** Click , select **Control Panel**, and click **Printer** under **Hardware and Sound**. Right-click your product name, select **Printing Preferences**, and select your product name again if necessary.
2. Click the **Maintenance** tab.
 3. Click the **Extended Settings** button.
 4. Select **Enable EPSON Status Monitor 3** and click **OK**.
 5. Click the **Monitoring Preferences** button.
 6. Click the checkbox for the option that adds the shortcut icon to the taskbar.
 7. Click **OK** to close the open program windows.

Parent topic: [Solving Problems Printing from a Computer](#)

Related references

[Windows System Requirements](#)

[Mac System Requirements](#)

Related tasks

[Selecting Basic Print Settings - Windows](#)

[Selecting Basic Print Settings - Mac](#)

[Selecting Printing Preferences - Mac](#)

[Selecting the Paper Settings - Control Panel](#)

Printing is Slow

If printing becomes slow, try these solutions:

- Make sure your system meets the requirements for your operating system. If you are printing a high-resolution image, you may need more than the minimum requirements. If necessary, increase your system's memory.
- If you are using Windows 7, close the **Devices and Printers** window before you print.
- Make sure **Quiet Mode** is turned off.

- Clear space on your hard drive or run a defragmentation utility to free up existing space.
- Close any programs you are not using when you print.
- If your product is connected to a USB hub, connect it directly to your computer instead.
- If printing becomes slower after printing continuously for a long time, the product may have automatically slowed down to protect the print mechanism from overheating or becoming damaged. Let the product rest with the power on for 30 minutes, then try printing again.
- If you are printing over a wireless network, factors such as interference, network traffic, or weak signal strength may affect your printing speed.

For the fastest printing, select the following settings in your product software:

- Make sure the paper type setting matches the type of paper you loaded.
- Turn on any high speed settings in your product software.
- Select a lower print quality setting.
- Make sure the ink drying time has not been increased for double-sided printing.
- **Windows:** Click the **Maintenance** or **Utility** tab, select **Extended Settings** or **Speed and Progress**, and select the following settings:
 - **High Speed Copies**
 - **Always Spool RAW Datatype**
 - **Page Rendering Mode**
 - **Print as Bitmap**
- **Windows:** Select **Printer Properties**, click the **More Options** tab, and make sure the **High Speed** setting is enabled.
- **Mac:** Select **System Preferences**, select **Printers & Scanners**, and select your product. Select **Options & Supplies**, select **Options** (or **Driver**), and enable the **High Speed Printing** setting.

If printing is still slow and you are using Windows 7 or Windows Vista, try the following:

1. Click  and select **Computer** or **My Computer**. Double-click the **C:** drive and open these folders: **ProgramData > EPSON > PRINTER**.

Note: If you do not see the ProgramData folder, open the **Organize** menu and select **Folder and search options**. In the window that appears, click the **View** tab, select **Show hidden files, folders, and drives** in the Advanced settings list, and click **OK**.

2. Right-click the **EPAUDF01.AUD** file and select **Delete**.

3. Restart your computer and try printing again.

Parent topic: [Solving Problems Printing from a Computer](#)

Related references

[Windows System Requirements](#)

[Mac System Requirements](#)

Related tasks

[Selecting Basic Print Settings - Windows](#)

[Selecting Basic Print Settings - Mac](#)

[Selecting Printing Preferences - Mac](#)

[Selecting the Paper Settings - Control Panel](#)

Solving Page Layout and Content Problems

Check these sections if you have problems with the layout or content of your printed pages.

Note: When printing using AirPrint, the available print settings are different from those covered in this manual. See the Apple website for details.

[Inverted Image](#)

[Too Many Copies Print](#)

[Blank Pages Print](#)

[Incorrect Margins on Printout](#)

[Border Appears on Borderless Prints](#)

[Incorrect Characters Print](#)

[Incorrect Image Size or Position](#)

[Slanted Printout](#)

Parent topic: [Solving Problems](#)

Inverted Image

If your printed image is inverted unexpectedly, try these solutions:

- Turn off any mirror or inversion settings in your printing application.
- Turn off the **Mirror Image**, **Flip horizontally**, or **Reverse page orientation** settings in your printer software. (This option has different names, depending on your operating system version.)

Parent topic: [Solving Page Layout and Content Problems](#)

Related tasks

[Selecting Additional Layout and Print Options - Windows](#)

[Selecting Basic Print Settings - Mac](#)

[Selecting Print Layout Options - Mac](#)

Too Many Copies Print

Make sure that the **Copies** setting in your printing program or printer software is not set for multiple copies.

Parent topic: [Solving Page Layout and Content Problems](#)

Related tasks

[Selecting Basic Print Settings - Windows](#)

[Selecting Basic Print Settings - Mac](#)

Blank Pages Print

If blank pages print unexpectedly, try these solutions:

- Make sure you selected the correct paper size settings in your printing program and printer software.
- If a blank page exists in a document you are printing and you want to skip printing it, select the **Skip Blank Page** setting in your printer software, if available.
- Run a print head nozzle check to see if any of the nozzles are clogged. Then clean the print head, if necessary.
- Make sure your product is selected as the printer in your printing program.

Parent topic: [Solving Page Layout and Content Problems](#)

Related concepts

[Print Head Maintenance](#)

Related tasks

[Selecting Basic Print Settings - Windows](#)

[Selecting Extended Settings - Windows](#)

[Printing Your Document or Photo - Windows](#)

[Selecting Basic Print Settings - Mac](#)

[Selecting Printing Preferences - Mac](#)

[Printing Your Document or Photo - Mac](#)

Incorrect Margins on Printout

If your printed page has incorrect margins, try these solutions:

- Make sure you selected the correct paper size settings in your printing program and printer software.
- Make sure you selected the correct margins for your paper size in your printing program.
- Make sure your paper is positioned correctly for feeding into the product.
- When placing originals on the scanner glass, align the corner of the original with the corner indicated by the arrow. If the edges of the copy are cropped, move the original slightly away from the corner.
- Clean the scanner glass and the document cover. If there is dust or stains on the glass, the copy area may extend to include the dust or stains.

You can use the preview option in your printer software to check your margins before you print.

Parent topic: [Solving Page Layout and Content Problems](#)

Related tasks

[Selecting Basic Print Settings - Windows](#)

[Selecting Basic Print Settings - Mac](#)

[Selecting the Paper Settings - Control Panel](#)

[Loading Paper in the Rear Paper Feed](#)

[Placing Originals on the Scanner Glass](#)

Border Appears on Borderless Prints

If you see a border on borderless prints, try these solutions:

- Make sure you are printing on a compatible borderless paper type and size.

Note: For custom paper sizes, make sure you select a supported borderless page width.

- **Windows:** Make sure you selected the **Borderless** setting in your printer software.
- **Mac:** Make sure you selected the **Borderless** checkbox or a paper size with a **Borderless** option in your printer software.
- Adjust the **Expansion** setting to adjust the amount of image expansion on the edges of borderless prints.
- Make sure the image size and the paper size are set correctly; if the image is small, the enlargement may not be enough to cover the paper.

- Access the Extended Settings (Windows) or Printing Preferences (Mac) and select **Remove White Borders**.

Parent topic: [Solving Page Layout and Content Problems](#)

Related references

[Borderless Paper Type Compatibility](#)

[Print Options - Mac](#)

Related tasks

[Selecting Basic Print Settings - Windows](#)

[Selecting Extended Settings - Windows](#)

[Selecting Basic Print Settings - Mac](#)

[Selecting Printing Preferences - Mac](#)

Incorrect Characters Print

If incorrect characters appear in your prints, try these solutions before reprinting:

- Make sure any cables are securely connected at both ends.
- In Windows, delete all jobs from the Windows Spooler. Click **Print Queue** on the Maintenance tab in the printer settings window, and cancel any stalled print jobs.
- If your product is connected to a USB hub, connect it directly to your computer instead.
- If your computer entered sleep mode the last time you printed, the next print job after your computer exits sleep mode may contain garbled characters. Print your document again.
- If incorrect characters still appear in your prints, try connecting your product using a different cable.
- Make sure you are using the printer software for this product. Check the product name at the top of the driver window.

Parent topic: [Solving Page Layout and Content Problems](#)

Related tasks

[Printing Your Document or Photo - Windows](#)

[Printing Your Document or Photo - Mac](#)

Incorrect Image Size or Position

If your printed image is the wrong size or in the wrong position, try these solutions:

- Make sure you selected the correct paper size and layout settings in your printing program and printer software.

- Make sure you selected the correct paper size on the control panel.
- Make sure your paper is positioned correctly for feeding into the printer.
- Slide the edge guides against the edges of the paper.
- Clean the scanner glass and document cover.
- If the edges of a copy are cropped, slightly move the original away from the edges of the scanner glass.
- Make sure you selected the correct margins for your paper size in your printing program.
- If the image is slightly enlarged and cropped during borderless printing, change the **Expansion** setting.

You can use the preview option in your printer software to check your margins before you print.

Parent topic: [Solving Page Layout and Content Problems](#)

Related tasks

[Selecting Basic Print Settings - Windows](#)

[Selecting Basic Print Settings - Mac](#)

[Selecting the Paper Settings - Control Panel](#)

[Loading Paper in the Rear Paper Feed](#)

[Cleaning Your Product](#)

[Placing Originals on the Scanner Glass](#)

Slanted Printout

If your printouts are slanted, try these solutions:

- Slide the edge guides against the edges of the paper.
- Select a higher print quality setting in your printer software.
- Turn off any high speed settings in your product software.
- Make sure the product is not printing while tilted or at an angle.

Parent topic: [Solving Page Layout and Content Problems](#)

Related tasks

[Loading Paper in the Rear Paper Feed](#)

[Selecting Basic Print Settings - Windows](#)

[Selecting Basic Print Settings - Mac](#)

[Aligning the Print Head Using the Product Control Panel](#)

Solving Print Quality Problems

Check these sections if your printouts have problems with print quality, but your image looks fine on your computer screen.

Note: When printing using AirPrint, the available print settings are different from those covered in this manual. See the Apple website for details.

[White or Dark Lines in Printout](#)

[Blurry or Smearred Printout](#)

[Faint Printout or Printout Has Gaps](#)

[Grainy Printout](#)

[Incorrect Colors](#)

Parent topic: [Solving Problems](#)

White or Dark Lines in Printout

If you notice white or dark lines in your prints (also called banding), try these solutions before you reprint:

- Run a nozzle check to see if any of the print head nozzles are clogged. Then clean the print head, if necessary.
- Make sure the paper type setting matches the type of paper you loaded.
- Turn off any high speed settings in your product software.

Parent topic: [Solving Print Quality Problems](#)

Related concepts

[Print Head Maintenance](#)

Related tasks

[Selecting Basic Print Settings - Windows](#)

[Selecting Basic Print Settings - Mac](#)

[Selecting the Paper Settings - Control Panel](#)

[Loading Paper in the Rear Paper Feed](#)

[Aligning the Print Head Using the Product Control Panel](#)

Related topics

[Replacing Ink Cartridges and Maintenance Boxes](#)

Blurry or Smearred Printout

If your printouts are blurry or smearred, try these solutions:

- Make sure your paper is not damp, curled, old, or loaded incorrectly in your product.
- Use a support sheet with special paper, or load special paper one sheet at a time.
- Make sure your paper meets the specifications for your product.
- Use Epson papers to ensure proper saturation and absorption of genuine Epson inks.
- Make sure the paper type setting in your product software matches the type of paper you loaded.
- If you are printing on letterhead paper, make sure the paper size setting matches the size of paper you loaded. If you select a paper size that is too large for the paper you loaded, the product may print beyond the edges of the paper and cause ink to smear.
- Make sure you loaded the printable side of the paper correctly for your product.
- Remove each sheet from the output tray as it is printed.
- Avoid handling printouts on glossy paper right after printing to allow the ink to set.
- Turn off any high speed settings in your product software.
- If you print on both sides of a sheet of paper, smudges may appear on the reverse side of heavily saturated or dark images. If one side of a sheet will contain a lighter image or text, print that side first. Adjust the density and/or ink drying time settings.
- Run a nozzle check to see if any of the print head nozzles are clogged. Then clean the print head, if necessary.
- Align the print head.
- Clean the paper path.

Note: Your product will not operate properly while tilted at an angle. Place it on a flat, stable surface that extends beyond the base of the product in all directions.

Parent topic: [Solving Print Quality Problems](#)

Related concepts

[Print Head Maintenance](#)

Related references

[Paper Specifications](#)

Related tasks

- [Loading Paper in the Rear Paper Feed](#)
- [Selecting Basic Print Settings - Windows](#)
- [Selecting Double-sided Printing Settings - Windows](#)
- [Selecting Basic Print Settings - Mac](#)
- [Selecting Double-sided Printing Settings - Mac](#)
- [Aligning the Print Head Using the Product Control Panel](#)

Faint Printout or Printout Has Gaps

If your printouts are faint or have gaps, try these solutions:

- Run a nozzle check to see if any of the print head nozzles are clogged. Then clean the print head, if necessary.
- The ink cartridges may be old or low on ink, and you may need to replace them.
- Make sure your paper is not damp, curled, old, or loaded incorrectly in your product.
- Align the print head.
- Clean the paper path.

Parent topic: [Solving Print Quality Problems](#)

Related concepts

[Print Head Maintenance](#)

Related tasks

- [Loading Paper in the Rear Paper Feed](#)
- [Aligning the Print Head Using the Product Control Panel](#)

Related topics

[Replacing Ink Cartridges and Maintenance Boxes](#)

Grainy Printout

If your printouts are grainy, try these solutions:

- Make sure you loaded the printable side of the paper correctly for your product.
- Select a higher print quality setting and turn off any high speed settings in your product software.
- Run a nozzle check to see if any of the print head nozzles are clogged. Then clean the print head, if necessary.

- Align the print head.
- You may need to increase the image resolution or print a smaller size; see your software documentation.

Note: Images from the Internet may be low resolution and not result in a high quality printout.

- If you enlarged the image size in an image-editing program, you need to increase the image resolution setting to retain a high image quality. Increase the image resolution by the same amount you increase the image size. For example, if the image resolution is 300 dpi (dots per inch) and you will double the image size for printing, change the resolution setting to 600 dpi.

Note: Higher resolution settings result in larger file sizes, which take longer to process and print. Consider the limitations of your computer system when selecting a resolution, and select the lowest possible resolution that produces acceptable quality to keep file sizes manageable.

Parent topic: [Solving Print Quality Problems](#)

Related concepts

[Print Head Maintenance](#)

Related tasks

[Loading Paper in the Rear Paper Feed](#)

[Selecting Basic Print Settings - Windows](#)

[Selecting Basic Print Settings - Mac](#)

[Aligning the Print Head Using the Product Control Panel](#)

Incorrect Colors

If your printouts have incorrect colors, try these solutions:

- Make sure the paper type setting matches the paper you loaded.
- Make sure the **Black/Grayscale** or **Grayscale** setting is not selected in your printer software.
- If you selected **Standard-Vivid** (Windows) or **Normal-Vivid** (Mac) as the quality setting in the printer software, try selecting **Standard** (Windows) or **Normal** (Mac) instead.
- Run a nozzle check to see if any of the print head nozzles are clogged. Then clean the print head, if necessary.
- The ink cartridges may be old or low on ink, and you may need to replace them.

- After you print, the colors in your printout need time to set as the ink dries. During this time, the colors may look different than you expect. To speed up drying time, do not stack your printouts on top of each other.
- Your printed colors can never exactly match your on-screen colors. However, you can use a color management system to get as close as possible. Try using the color management options in your printer software.
- For best results, use genuine Epson paper.

Parent topic: [Solving Print Quality Problems](#)

Related concepts

[Print Head Maintenance](#)

Related tasks

[Selecting Basic Print Settings - Windows](#)

[Selecting Basic Print Settings - Mac](#)

[Selecting the Paper Settings - Control Panel](#)

Related topics

[Replacing Ink Cartridges and Maintenance Boxes](#)

Solving Scanning Problems

Check these solutions if you have problems scanning with your product.

[Scanning Software Does Not Operate Correctly](#)

[Cannot Start Epson Scan 2](#)

[Scanning is Slow](#)

Parent topic: [Solving Problems](#)

Scanning Software Does Not Operate Correctly

If your scanning software does not operate correctly, try these solutions:

- Make sure your computer has adequate memory and meets the system requirements for your operating system.
- Make sure your computer is not running in a power-saving mode, such as sleep or standby. If so, wake your system and restart your scanning software.
- If you upgraded your operating system but did not reinstall your scanning software, try reinstalling it.

- In Windows, make sure your product is listed as a valid device in the **Scanners and Cameras** control panel.

Parent topic: [Solving Scanning Problems](#)

Cannot Start Epson Scan 2

If you cannot start Epson Scan 2, try these solutions:

- Make sure your product is turned on and any interface cables are securely connected at both ends.
- If your product is connected to a USB hub, connect it directly to your computer instead.
- If you scan at a high resolution over a network, a communication error may occur. Lower the resolution.
- Make sure Epson Scan 2 is selected as your scanning program.
- Make sure your computer is not running in a power-saving mode, such as sleep or standby. If so, wake your system and restart Epson Scan 2.
- Check the connection setting and test the connection using Epson Scan 2 Utility:

Windows 10: Click  and select **EPSON > Epson Scan 2 Utility**. Make sure the correct product is selected. If necessary, select the **Other** tab and click **Reset**.

Windows 8.x: Navigate to the **Apps** screen and select **Epson Scan 2 Utility**. Make sure the correct product is selected. If necessary, select the **Other** tab and click **Reset**.

Windows (other versions): Click  or **Start > All Programs** or **Programs > EPSON > Epson Scan 2 > Epson Scan 2 Utility**. Make sure the correct product is selected. If necessary, select the **Other** tab and click **Reset**.

Mac: Open the **Applications** folder, click **Epson Software**, and click **Epson Scan 2 Utility**. Make sure the correct product is selected. If necessary, select the **Other** tab and click **Reset**.

- Make sure you do not have multiple versions of Epson Scan 2 installed. If you do, uninstall both versions and install one version.
- If you upgraded your operating system but did not reinstall Epson Scan 2, try reinstalling it.

Parent topic: [Solving Scanning Problems](#)

Related concepts

[Uninstall Your Product Software](#)

Related tasks

[Scanning in Epson Scan 2](#)

Scanning is Slow

If scanning becomes slow, try these solutions:

- Scan your original at a lower resolution, if possible.
- Make sure your system meets the requirements for your operating system. If you are scanning a high-resolution image, you may need more than the minimum requirements. If necessary, increase your system's memory or reduce the resolution.
- If you are scanning over a wireless network, factors such as interference, network traffic, or weak signal strength may affect your scanning speed.

Parent topic: [Solving Scanning Problems](#)

Related concepts

[Scan Resolution Guidelines](#)

Solving Scanned Image Quality Problems

Check these sections if a scanned image on your computer screen has a quality problem.

[Scanned Image Quality Problems](#)

[Image Consists of a Few Dots Only](#)

[Line of Dots Appears in All Scanned Images](#)

[Straight Lines in an Image Appear Crooked](#)

[Image Colors are Patchy at the Edges](#)

[Ripple Patterns Appear in an Image](#)

[Scanned Image Edges are Cropped](#)

Parent topic: [Solving Problems](#)

Scanned Image Quality Problems

If you encounter quality problems with your scanned image, try these solutions:

Image is Distorted or Blurry

- Do not move your original or your product during scanning.
- Your product will not operate properly while tilted at an angle. Place your product on a flat, stable surface that extends beyond its base in all directions.
- Adjust these Epson Scan 2 settings (if available) and try scanning again:
 - Increase the **Resolution** setting.

- If the **Image Type** setting is **Black & White**, adjust the **Threshold** setting.
- If the **Image Type** setting is **Color** or **Grayscale**, select the **Unsharp Mask** setting.
- If the **Image Type** setting is **Black & White**, select **Text Enhancement**. If the **Image Type** setting is **Color** or **Grayscale**, change the **Text Enhancement** setting to **High**.

Image is Too Dark

- If the **Image Type** is set to **Color** or **Grayscale**, adjust the **Brightness** setting.
- Check the brightness and contrast settings of your computer monitor.

Back of Original Image Appears in Scanned Image

- Place a piece of black paper on the back of the original and scan it again.
- Adjust these Epson Scan 2 settings (if available) and try scanning again:
 - Select the **Advanced Settings** tab and adjust the **Brightness** setting.
 - If the **Image Type** is set to **Black & White**, select **Text Enhancement**. If the **Image Type** is set to **Color** or **Grayscale**, change the **Text Enhancement** setting to **High**.

Scanned Image Colors Do Not Match Original Colors

Printed colors can never exactly match the colors on your computer monitor because printers and monitors use different color systems: monitors use RGB (red, green, and blue) and printers typically use CMYK (cyan, magenta, yellow, and black).

Check the color matching and color management capabilities of your computer, display adapter, and the software you are using to see if they are affecting the palette of colors you see on your screen.

To adjust the colors in your scanned image, adjust these Epson Scan 2 settings (if available) and try scanning again:

- If the **Image Type** setting is **Color** or **Grayscale**, adjust the **Contrast** setting.
- If the **Image Type** setting is **Black & White** or **Grayscale**, adjust the **Color Enhance** setting.

Parent topic: [Solving Scanned Image Quality Problems](#)

Related tasks

[Placing Originals on the Scanner Glass](#)

[Scanning in Epson Scan 2](#)

Image Consists of a Few Dots Only

If your scanned image consists only of a few dots, try these solutions:

- Make sure you placed your original for scanning facing the correct way.
- If the **Image Type** setting is **Black & White**, adjust the **Threshold** and scan again.

Parent topic: [Solving Scanned Image Quality Problems](#)

Related tasks

[Placing Originals on the Scanner Glass](#)

[Scanning in Epson Scan 2](#)

Line of Dots Appears in All Scanned Images

If a line of dots appears in all your scanned images, clean the scanner glass with a soft, dry, lint-free cloth or use a small amount of glass cleaner on the cloth, if necessary. Paper towels are not recommended.

Caution: Do not spray glass cleaner directly on the scanner glass.

Parent topic: [Solving Scanned Image Quality Problems](#)

Related tasks

[Cleaning Your Product](#)

Straight Lines in an Image Appear Crooked

If straight lines in an original appear crooked in a scanned image, make sure to place your original straight when you scan it.

Parent topic: [Solving Scanned Image Quality Problems](#)

Related tasks

[Placing Originals on the Scanner Glass](#)

Image Colors are Patchy at the Edges

If you are scanning a thick or warped original, cover its edges with paper to block external light as you scan it.

Parent topic: [Solving Scanned Image Quality Problems](#)

Ripple Patterns Appear in an Image

You may see a ripple pattern (called a moiré) in scanned images of printed documents. This is caused by interference from differing pitches in the scanner's screen and your original's halftone screen. To reduce this effect, adjust these Epson Scan settings (if available) and try scanning again:

- Select the **Descreening** setting.
- Select a lower **Resolution** setting.

Parent topic: [Solving Scanned Image Quality Problems](#)

Related tasks

[Scanning in Epson Scan 2](#)

Scanned Image Edges are Cropped

If the edges of a scanned image are cropped, make sure your original is placed correctly for scanning. If necessary, move your original away from the edges of the scanner glass slightly.

Parent topic: [Solving Scanned Image Quality Problems](#)

Uninstall Your Product Software

If you have a problem that requires you to uninstall and re-install your software, follow the instructions for your operating system.



[Uninstalling Product Software - Windows](#)

[Uninstalling Product Software - Mac](#)

Parent topic: [Solving Problems](#)

Uninstalling Product Software - Windows

You can uninstall and then re-install your product software to solve certain problems.

1. Turn off the product.
2. Disconnect any interface cables.
3. Do one of the following:
 - **Windows 10:** Click  and select  (Settings) > **Apps** or **System** > **Apps & features**. Then select the program you want to uninstall and select **Uninstall**.
 - **Windows 8.x:** Navigate to the **Apps** screen and select **Control Panel** > **Programs** > **Programs and Features**. Select the uninstall option for your Epson product, then select **Uninstall/Change**.

Note: If you see a **User Account Control** window, click **Yes** or **Continue**.

Select your product again, if necessary, then select **OK**, and click **Yes** to confirm the uninstallation.

- **Windows (other versions):** Click  or **Start**, and select **All Programs** or **Programs**. Select **EPSON**, select your product, then click **EPSON Printer Software Uninstall**.

Note: If you see a **User Account Control** window, click **Yes** or **Continue**.

In the next window, select your product and click **OK**. Then follow any on-screen instructions.

4. Do one of the following to uninstall Epson Event Manager, then follow any on-screen instructions:
 - **Windows 10/8.x:** Select **Epson Event Manager** and click **Uninstall**.
 - **Windows 7/Windows Vista:** Open the Windows **Control Panel** utility. Select **Programs and Features**. (In Classic view, select **Programs** and click **Uninstall a program**.) Select **Epson Event Manager** and click **Uninstall/Change**.
5. Do one of the following to uninstall Epson Scan 2, then follow any on-screen instructions:
 - **Windows 10:** Select **Epson Scan 2** and click **Uninstall**.
 - **Windows 8.x/Windows 7/Windows Vista:** Select **Epson Scan 2** and click **Uninstall/Change**.
6. Restart your computer, then see the *Start Here* sheet to re-install your software.

Note: If you find that re-installing your product software does not solve a problem, contact Epson.

Parent topic: [Uninstall Your Product Software](#)

Uninstalling Product Software - Mac

In most cases, you do not need to uninstall your product software before re-installing it. However, you can download the Uninstaller utility from the Epson support website to uninstall your product software as described here.

Note: If you find that re-installing your product software does not solve a problem, contact Epson.

1. To download the Uninstaller utility, visit epson.com/support (U.S.), epson.ca/support (Canada), or epson.com.jm/support (Caribbean) and select your product.
2. Click **Downloads**.

3. Select your operating system, click **Utilities**, locate the Uninstaller utility, and click **Download**.
4. Run the file you downloaded.
5. Double-click the **Uninstaller** icon.
6. In the Epson Uninstaller screen, select the checkbox for each software program you want to uninstall.
7. Click **Uninstall**.
8. Follow the on-screen instructions to uninstall the software.
9. Reinstall your product software.

Note: If you uninstall the printer driver and your product name remains in the **Print & Fax**, **Print & Scan**, or **Printers & Scanners** window, select your product name and click the – (remove) icon to remove it.

Parent topic: [Uninstall Your Product Software](#)

Where to Get Help

If you need to contact Epson for technical support services, use the following support options.

Internet Support

Visit Epson's support website at epson.com/support (U.S.), epson.ca/support (Canada), or epson.com.jm/support (Caribbean) and select your product for solutions to common problems. You can download drivers and documentation, get FAQs and troubleshooting advice, or e-mail Epson with your questions.

Speak to a Support Representative

Before you call Epson for support, please have the following information ready:

- Product name
- Product serial number (located on a label on the product)
- Proof of purchase (such as a store receipt) and date of purchase
- Computer configuration
- Description of the problem

Then call:

- U.S.: (562) 276-4382, 6 AM to 8 PM, Pacific Time, Monday through Friday, and 7 AM to 4 PM, Pacific Time, Saturday

- Canada: (905) 709-3839, 6 AM to 8 PM, Pacific Time, Monday through Friday, and 7 AM to 4 PM, Pacific Time, Saturday

Days and hours of support are subject to change without notice. Toll or long distance charges may apply.

Purchase Supplies and Accessories

You can purchase genuine Epson ink and paper at epson.com (U.S. sales), epson.ca (Canadian sales), or epson.com.jm (Caribbean sales). You can also purchase supplies from an Epson authorized reseller. To find the nearest one, call 800-GO-EPSON (800-463-7766) in the U.S. or 800-807-7766 in Canada.

Parent topic: [Solving Problems](#)

Technical Specifications

These sections list the technical specifications for your product.

Note: Epson offers a recycling program for end of life Epson products. Please go to [this site](#) (U.S) or [this site](#) (Canada) for information on how to return your Epson products for proper disposal.

[Windows System Requirements](#)

[Mac System Requirements](#)

[Paper Specifications](#)

[Printable Area Specifications](#)

[Scanning Specifications](#)

[Ink Cartridge Specifications](#)

[Dimension Specifications](#)

[Electrical Specifications](#)

[Environmental Specifications](#)

[Interface Specifications](#)

[Network Interface Specifications](#)

[Safety and Approvals Specifications](#)

Windows System Requirements

To use your product and its software, your computer should use one of these Microsoft operating systems:

- Windows 10
- Windows 8.x
- Windows 7
- Windows Vista

Note: For the latest product software available for your operating system, visit the Epson support site at [epson.com/support](#) (U.S.), [epson.ca/support](#) (Canada), or [epson.com.jm/support](#) (Caribbean), select your product, and select **Downloads**.

Parent topic: [Technical Specifications](#)

Mac System Requirements

To use your product and its software, your Mac should use one of these operating systems:

- macOS 10.14.x
- macOS 10.13.x
- macOS 10.12.x
- OS X 10.11.x
- OS X 10.10.x
- OS X 10.9.x
- OS X 10.8.x
- OS X 10.7.x
- OS X 10.6.8

Note: For the latest product software available for your operating system, visit the Epson support site at epson.com/support (U.S.), epson.ca/support (Canada), or epson.com.jm/support (Caribbean), select your product, and select **Downloads**.

Parent topic: [Technical Specifications](#)

Paper Specifications

Note: Since the quality of any particular brand or type of paper may be changed by the manufacturer at any time, Epson cannot guarantee the quality of any non-Epson brand or type of paper. Always test a sample of paper stock before purchasing large quantities or printing large jobs.

Single-sheets

Size

A4 (8.3 × 11.7 inches [210 × 297 mm])
A6 (4.1 × 5.8 inches [105 × 148 mm])
Letter (8.5 × 11 inches [216 × 279 mm])
Legal (8.5 × 14 inches [216 × 356 mm])
Mexico-Oficio (8.5 × 13.4 inches [216 × 340 mm])
Oficio 9 (8.46 × 12.4 inches [215 × 315 mm])
8.5 × 13 inches (216 × 330 mm)
4 × 6 inches (102 × 152 mm)
5 × 7 inches (127 × 178 mm)
8 × 10 inches (203 × 254 mm)
3.5 × 5 inches (89 × 127 mm)
Executive (7.25 × 10.5 inches [184 × 267 mm])
Half Letter (5.5 × 8.5 inches [140 × 216 mm])

Paper types

Plain paper

Note: Your product also supports compatible papers distributed by Epson. See the link at the end of this topic for a list of compatible Epson papers.

Weight

Plain paper: 17 lb (64 g/m²) to 24 lb (90 g/m²)

Envelopes

Size

No. 10 (4.1 × 9.5 inches [105 × 241 mm])

Paper types

Plain bond paper

Weight

20 lb (75 g/m²) to 24 lb (90 g/m²)

Parent topic: [Technical Specifications](#)

Printable Area Specifications

Note: When printing borderless, quality may decline in the expanded printable area.

Single sheets

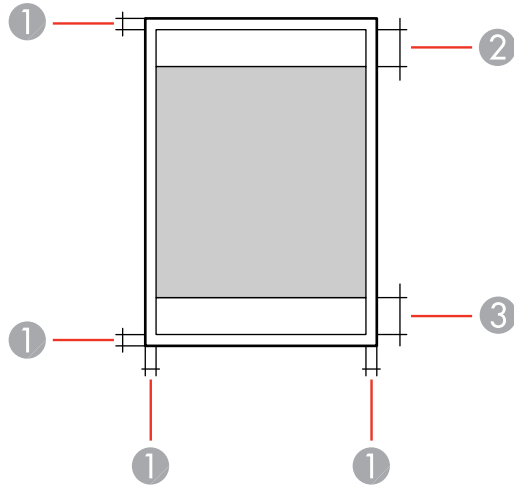

- 1 Top/bottom/left/right: 0.12 inch (3 mm) minimum
- 2 Top reduced quality area: 1.61 inches (41 mm) minimum
- 3 Bottom reduced quality area: 1.46 inches (37 mm) minimum

Borderless

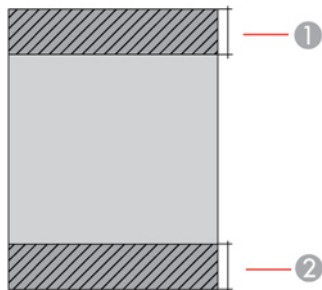

- 1 Top reduced quality area: 1.73 inches (44 mm) minimum
- 2 Bottom reduced quality area: 1.57 inches (40 mm) minimum

Envelopes

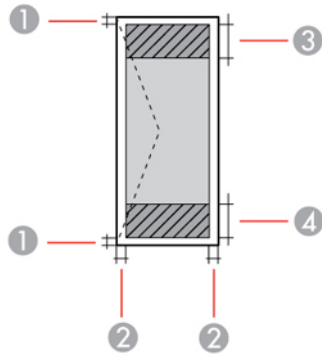

- 1 Left/right: 0.12 inch (3 mm) minimum
- 2 Top/Bottom: 0.20 inch (5 mm) minimum
- 3 Left reduced quality area: 0.70 inch (18 mm) minimum
- 4 Right reduced quality area: 1.61 inches (41 mm) minimum

Parent topic: [Technical Specifications](#)

Scanning Specifications

Scanner type	Flatbed, color
Photoelectric device	CIS
Effective pixels	10200 × 14040 pixels at 1200 dpi
Document size	Maximum: 8.5 × 11.7 inches (216 × 297 mm) Scanner glass: US letter or A4
Scanning resolution	1200 dpi (main scan) 2400 dpi (sub scan)
Output resolution	50 to 9600 in 1 dpi increments

Image data

Color:

48 bits per pixel (16 bits per pixel per color) internal

24 bits per pixel (8 bits per pixel per color) external

Grayscale:

16 bits per pixel internal

8 bits per pixel external

Black and white:

16 bits per pixel internal

1 bit per pixel external

Light source

LED

Parent topic: [Technical Specifications](#)

Ink Cartridge Specifications

Note: This printer is designed for use with Epson cartridges only, not third-party cartridges or ink. Other brands of ink supplies are not compatible and, if described as compatible, may not function properly or continuously. Such restrictions can be avoided with some other printers such as Epson EcoTank cartridge-free printers.

The included initial cartridges are designed for reliable printer setup and cannot be used as replacement cartridges or resold. After setup, the remaining ink is available for printing. Yields are based on ISO 24711 in default mode, printing continuously. Yields vary due to print images, settings, and temperatures. Printing infrequently or primarily with one color reduces yields. All cartridges must be installed with ink for printing and printer maintenance. For print quality, some ink remains in replaced cartridges.

Color

Black, Cyan, Magenta, Yellow

Cartridge life

Opened package: 6 months

Unopened package: do not use if the date on the package has expired

Temperature Storage: –22 to 104 °F (–30 to 40 °C)
1 month at 104 °F (40 °C)
Ink freezes at 3.2 °F (–16 °C)
Ink thaws and is usable after 3 hours at 77 °F (25 °C)

Note: For best printing results, use up a cartridge within 6 months of opening the package.

Parent topic: [Technical Specifications](#)

Related references

[Ink Cartridge and Maintenance Box Part Numbers](#)

Dimension Specifications

Height	6.7 inches (170 mm)
Width	14.8 inches (375 mm)
Depth	Stored: 11.8 inches (300 mm) Printing: 22.8 inches (578 mm)
Weight (without ink cartridges or power cord)	Approximately 9.5 lb (4.3 kg)

Parent topic: [Technical Specifications](#)

Electrical Specifications

Power supply rating	100 to 240 V
Rated frequency range	50 to 60 Hz
Rated current	0.4 to 0.2 A

Power consumption	Standalone copying: Approximately 12 W (ISO/IEC24712) Ready mode: Approximately 5.0 W Sleep mode: Approximately 0.8 W Power off mode: Approximately 0.3 W
--------------------------	--

Parent topic: [Technical Specifications](#)

Environmental Specifications

Temperature	Operating: 50 to 95 °F (10 to 35 °C) Storage: –4 to 104 °F (–20 to 40 °C) 1 month at 104 °F (40 °C)
Humidity (without condensation)	Operating: 20 to 80% RH Storage: 5 to 85% RH

Parent topic: [Technical Specifications](#)

Interface Specifications

Interface type	Hi-Speed USB (Device Class for computers)
-----------------------	---

Parent topic: [Technical Specifications](#)

Network Interface Specifications

Wireless LAN standard	IEEE 802.11 b/g/n
Wireless security	WPA2-PSK (AES); complies with WPA2 with support for WPA/WPA2 Personal WEP (64/128 bit)
Frequency band	2.4 GHz
Communication mode	Infrastructure mode Wi-Fi Direct (Simple AP); not supported for IEEE 802.11b

Security protocol	SSL/TLS HTTPS Server/Client, IPPS
Maximum radio frequency power transmitted	20 dBm (EIRP)

Parent topic: [Technical Specifications](#)

Safety and Approvals Specifications

United States	Safety: UL60950-1 EMC: FCC part 15 Subpart B class B
Canada	Safety: CAN/CSA C22.2 No. 60950-1 EMC: CAN/CSA-CEI/IEC CISPR 22 Class B

This equipment contains the following wireless module:

- Manufacturer: Seiko Epson Corporation.
- Type: J26H006

This product conforms to Part 15 of FCC Rules and RSS-210 of the IC Rules. Epson cannot accept responsibility for any failure to satisfy the protection requirements resulting from a non-recommended modification of the product. Operation is subject to the following two conditions: (1) this device may not cause harmful interference, and (2) this device must accept any interference received, including interference that may cause undesired operation of the device.

To prevent radio interference to the licensed service, this device is intended to be operated indoors and away from windows to provide maximum shielding. Equipment (or its transmit antenna) that is installed outdoors is subject to licensing.

This equipment complies with FCC/IC radiation exposure limits set forth for an uncontrolled environment and meets the FCC radio frequency (RF) Exposure Guidelines in Supplement C to OET65 and RSS-102 of the IC radio frequency (RF) Exposure rules. This equipment should be installed and operated so that the radiator is kept at least 7.9 inches (20 cm) or more away from a person's body (excluding extremities: hands, wrists, feet and ankles).

Parent topic: [Technical Specifications](#)

Notices

Check these sections for important notices about your product.

Note: Epson offers a recycling program for end of life Epson products. Please go to [this site](#) (U.S) or [this site](#) (Canada) for information on how to return your Epson products for proper disposal.

[Important Safety Instructions](#)

[Important Privacy Notice \(Printer Serial Number\)](#)

[FCC Compliance Statement](#)

[Binding Arbitration and Class Waiver](#)

[Trademarks](#)

[Copyright Notice](#)

Important Safety Instructions

Before using your Epson product, read and follow these safety instructions.

[General Product Safety Instructions](#)

[Ink Cartridge Safety Instructions](#)

[Wireless Connection Safety Instructions](#)

[LCD Screen Safety Instructions](#)

Parent topic: [Notices](#)

General Product Safety Instructions

- Be sure to follow all warnings and instructions marked on the product.
- Use only the type of power source indicated on the product's label.
- Use only the power cord that comes with the product. Use of another cord may cause fires or shock. Do not use the cord with any other equipment.
- Make sure the AC power cord meets the relevant local safety standard.
- Place the product near a wall outlet where the plug can be easily unplugged.
- Avoid plugging the product into an outlet on the same circuit as a photo copier or air control system that regularly switches on and off, or on an outlet controlled by a wall switch or timer.

- Do not let the power cord become damaged or frayed. Place it to avoid abrasions, cuts, fraying, crimping, and kinking. Do not place objects on top of it and do not allow it to be stepped on or run over. Be careful to keep the cord straight at each end.
- If you use an extension cord with the product, make sure the total ampere rating of the devices plugged into the extension cord does not exceed the cord's ampere rating. Also, make sure the total ampere rating of all devices plugged into the wall outlet does not exceed the wall outlet's ampere rating.
- Always turn off the product using the power button, and wait until the power light stops flashing before unplugging the product or cutting off power to the electrical outlet.
- If you will not be using the product for a long period, unplug the power cord from the electrical outlet.
- Place the product on a flat, stable surface that extends beyond its base in all directions. It will not operate properly if it is tilted or at an angle.
- Allow space behind the product for the cables, and space above the product so that you can fully raise the document cover.
- Leave enough space in front of the product for the paper to be fully ejected.
- Avoid locations that are subject to rapid changes in heat or humidity, shocks or vibrations, or dust.
- Do not place or store the product outdoors.
- Do not place the product near excessive heat sources or in direct sunlight.
- Leave enough room around the product for sufficient ventilation. Do not block or cover openings in the case or insert objects through the slots.
- Keep the product away from potential sources of electromagnetic interference, such as loudspeakers or the base units of cordless telephones.
- Keep your product at least 8.7 inches (22 cm) away from cardiac pacemakers to prevent your product's radio waves from affecting the operation of the pacemaker.
- When connecting the product to a computer or other device with a cable, ensure the correct orientation of the connectors. Each connector has only one correct orientation. Inserting a connector in the wrong orientation may damage both devices connected by the cable.
- Do not sit or lean on the product. Do not place heavy objects on the product.
- Do not touch the flat white cable inside the product.
- Do not touch the translucent film inside the product.
- Do not move the print head by hand; this may damage the product.
- Do not put your hand inside the product while it is printing.

- Do not spill liquid on the product or use the product with wet hands.
- Do not use aerosol products that contain flammable gases inside or around the product. Doing so may cause fire.
- Do not press too hard on the scanner glass when placing originals.
- Do not open the scanner section while the product is copying, printing, scanning, or performing any other functions.
- Be careful not to trap your fingers when closing the document cover or scanner.
- Except as specifically explained in your documentation, do not attempt to service or disassemble the product yourself.
- Unplug the product and refer servicing to qualified service personnel under the following conditions: if the power cord or plug is damaged; if liquid has entered the product; if the product has been dropped or the case damaged; if the product does not operate normally or exhibits a distinct change in performance. Adjust only those controls that are covered by the operating instructions.
- Leave the ink cartridges installed. Removing the cartridges can dehydrate the print head and may prevent the product from printing.
- When storing or transporting the product, do not tilt it, stand it on its side, or turn it upside down; otherwise, ink may leak.

Parent topic: [Important Safety Instructions](#)

Ink Cartridge Safety Instructions

- Keep ink cartridges out of the reach of children and do not drink the ink.
- Be careful when you handle used ink cartridges; there may be ink remaining around the ink supply port. If ink gets on your skin, wash it off with soap and water. If it gets in your eyes, flush them immediately with water.
- Do not put your hand inside the product or touch any cartridges during printing.
- Install a new ink cartridge immediately after removing an expended one. Leaving cartridges uninstalled can dry out the print head and may prevent the product from printing.
- Do not remove or tear the label on the cartridge; this can cause leakage.
- Do not remove the transparent seal from the bottom of the cartridge. This may cause the cartridge to become unusable.
- Do not break the hooks on the side of the cartridge when removing it from the packaging.
- Do not touch the green IC chip on the side of the cartridge. This may prevent normal operation.

- Do not shake cartridges after opening their packages; this can cause them to leak.
- If you remove an ink cartridge for later use, protect the ink supply area from dirt and dust and store it in the same environment as the product. Note that there is a valve in the ink supply port, making covers or plugs unnecessary, but care is needed to prevent the ink from staining items that the cartridge touches. Do not touch the ink cartridge ink supply port or surrounding area.
- Use an ink cartridge before the date printed on its package.
- Do not dismantle an ink cartridge. This could damage the print head.
- Store ink cartridges in a cool, dark place.
- Make sure to install all ink cartridges. The printer only works when all ink cartridges are properly installed.
- After bringing an ink cartridge inside from a cold storage site, allow it to warm up at room temperature for at least three hours before using it.
- Store ink cartridges with their bottoms down. Do not store cartridges upside down.

Parent topic: [Important Safety Instructions](#)

Wireless Connection Safety Instructions

Radio waves from this product may adversely affect the operation of medical equipment or automatically controlled devices, such as pacemakers, automatic doors or fire alarms. When using this product near such devices or inside a medical facility, follow the directions from authorized staff members at the facility, and follow all posted warnings and directions on the device to avoid causing an accident.

Parent topic: [Important Safety Instructions](#)

LCD Screen Safety Instructions

- Use only a dry, soft cloth to clean the LCD screen. Do not use liquid or chemical cleansers.
- If the LCD screen is damaged, contact Epson. If the liquid crystal solution gets on your hands, wash them thoroughly with soap and water. If the liquid crystal solution gets into your eyes, flush them immediately with water. If discomfort or vision problems remain after a thorough flushing, see a doctor immediately.
- Do not press too hard on the LCD screen or subject it to heavy impacts.
- Do not use a pointy or sharp object, such as a pen or your fingernail, to operate the LCD screen.
- If the LCD screen chips or cracks, do not touch or attempt to remove the broken pieces; contact Epson for support.

Parent topic: [Important Safety Instructions](#)

Important Privacy Notice (Printer Serial Number)

As part of setup, your product's serial number will be sent to a secure Epson server so that you can be eligible to participate in programs we may offer from time to time, including the Epson ink replenishment program. You will have a separate opportunity to consent to participating in such programs.

If you have any questions concerning this process, you can contact us by using the [Privacy Feedback Form](#), or you can write to:

Epson America, Inc.

Attn: Privacy Coordinator

3840 Kilroy Airport Way

Long Beach, CA 90806-2469

Parent topic: [Notices](#)

FCC Compliance Statement

For United States Users

This equipment has been tested and found to comply with the limits for a Class B digital device, pursuant to Part 15 of the FCC Rules. These limits are designed to provide reasonable protection against harmful interference in a residential installation. This equipment generates, uses, and can radiate radio frequency energy and, if not installed and used in accordance with the instructions, may cause harmful interference to radio or television reception. However, there is no guarantee that interference will not occur in a particular installation. If this equipment does cause interference to radio and television reception, which can be determined by turning the equipment off and on, the user is encouraged to try to correct the interference by one or more of the following measures:

- Reorient or relocate the receiving antenna.
- Increase the separation between the equipment and receiver.
- Connect the equipment into an outlet on a circuit different from that to which the receiver is connected.
- Consult the dealer or an experienced radio/TV technician for help.

WARNING

The connection of a non-shielded equipment interface cable to this equipment will invalidate the FCC Certification or Declaration of this device and may cause interference levels which exceed the limits established by the FCC for this equipment. It is the responsibility of the user to obtain and use a shielded equipment interface cable with this device. If this equipment has more than one interface connector, do

not leave cables connected to unused interfaces. Changes or modifications not expressly approved by the manufacturer could void the user's authority to operate the equipment.

For Canadian Users

CAN ICES-3(B)/NMB-3(B)

Parent topic: [Notices](#)

Binding Arbitration and Class Waiver

1. DISPUTES, BINDING INDIVIDUAL ARBITRATION, AND WAIVER OF CLASS ACTIONS AND CLASS ARBITRATIONS

1.1 Disputes. The terms of this Section 1 shall apply to all Disputes between you and Epson. The term "Dispute" is meant to have the broadest meaning permissible under law and includes any dispute, claim, controversy or action between you and Epson arising out of or relating to this Agreement, Epson branded products (hardware and including any related software), or other transaction involving you and Epson, whether in contract, warranty, misrepresentation, fraud, tort, intentional tort, statute, regulation, ordinance, or any other legal or equitable basis. "DISPUTE" DOES NOT INCLUDE IP CLAIMS, or more specifically, a claim or cause of action for (a) trademark infringement or dilution, (b) patent infringement, (c) copyright infringement or misuse, or (d) trade secret misappropriation (an "IP Claim"). You and Epson also agree, notwithstanding Section 1.6, that a court, not an arbitrator, may decide if a claim or cause of action is for an IP Claim.

1.2 Binding Arbitration. You and Epson agree that all Disputes shall be resolved by binding arbitration according to this Agreement. **ARBITRATION MEANS THAT YOU WAIVE YOUR RIGHT TO A JUDGE OR JURY IN A COURT PROCEEDING AND YOUR GROUNDS FOR APPEAL ARE LIMITED.**

Pursuant to this Agreement, binding arbitration shall be administered by JAMS, a nationally recognized arbitration authority, pursuant to its code of procedures then in effect for consumer related disputes, but excluding any rules that permit joinder or class actions in arbitration (for more detail on procedure, see Section 1.6 below). You and Epson understand and agree that (a) the Federal Arbitration Act (9 U.S.C. §1, et seq.) governs the interpretation and enforcement of this Section 1, (b) this Agreement memorializes a transaction in interstate commerce, and (c) this Section 1 shall survive termination of this Agreement.

1.3 Pre-Arbitration Steps and Notice. Before submitting a claim for arbitration, you and Epson agree to try, for sixty (60) days, to resolve any Dispute informally. If Epson and you do not reach an agreement to resolve the Dispute within the sixty (60) days, you or Epson may commence an arbitration. Notice to Epson must be addressed to: Epson America, Inc., ATTN: Legal Department, 3840 Kilroy Airport Way, Long Beach, CA 90806 (the "Epson Address"). The Dispute Notice to you will be sent to the most recent address Epson has in its records for you. For this reason, it is important to notify us if your address changes by emailing us at EAILEgal@ea.epson.com or writing us at the Epson Address above. Notice of

the Dispute shall include the sender's name, address and contact information, the facts giving rise to the Dispute, and the relief requested (the "Dispute Notice"). Following receipt of the Dispute Notice, Epson and you agree to act in good faith to resolve the Dispute before commencing arbitration.

1.4 Small Claims Court. Notwithstanding the foregoing, you may bring an individual action in the small claims court of your state or municipality if the action is within that court's jurisdiction and is pending only in that court.

1.5 WAIVER OF CLASS ACTIONS AND CLASS ARBITRATIONS. YOU AND EPSON AGREE THAT EACH PARTY MAY BRING DISPUTES AGAINST THE OTHER PARTY ONLY IN AN INDIVIDUAL CAPACITY, AND NOT AS A PLAINTIFF OR CLASS MEMBER IN ANY CLASS OR REPRESENTATIVE PROCEEDING, INCLUDING WITHOUT LIMITATION FEDERAL OR STATE CLASS ACTIONS, OR CLASS ARBITRATIONS. CLASS ACTION LAWSUITS, CLASS-WIDE ARBITRATIONS, PRIVATE ATTORNEY-GENERAL ACTIONS, AND ANY OTHER PROCEEDING WHERE SOMEONE ACTS IN A REPRESENTATIVE CAPACITY ARE NOT ALLOWED. ACCORDINGLY, UNDER THE ARBITRATION PROCEDURES OUTLINED IN THIS SECTION, AN ARBITRATOR SHALL NOT COMBINE OR CONSOLIDATE MORE THAN ONE PARTY'S CLAIMS WITHOUT THE WRITTEN CONSENT OF ALL AFFECTED PARTIES TO AN ARBITRATION PROCEEDING.

1.6 Arbitration Procedure. If you or Epson commences arbitration, the arbitration shall be governed by the rules of JAMS that are in effect when the arbitration is filed, excluding any rules that permit arbitration on a class or representative basis (the "JAMS Rules"), available at <http://www.jamsadr.com> or by calling 1-800-352-5267, and under the rules set forth in this Agreement. All Disputes shall be resolved by a single neutral arbitrator, and both parties shall have a reasonable opportunity to participate in the selection of the arbitrator. The arbitrator is bound by the terms of this Agreement. The arbitrator, and not any federal, state or local court or agency, shall have exclusive authority to resolve all disputes arising out of or relating to the interpretation, applicability, enforceability or formation of this Agreement, including any claim that all or any part of this Agreement is void or voidable. Notwithstanding this broad delegation of authority to the arbitrator, a court may determine the limited question of whether a claim or cause of action is for an IP Claim, which is excluded from the definition of "Disputes" in Section 1.1 above. The arbitrator shall be empowered to grant whatever relief would be available in a court under law or in equity. The arbitrator may award you the same damages as a court could, and may award declaratory or injunctive relief only in favor of the individual party seeking relief and only to the extent necessary to provide relief warranted by that party's individual claim. In some instances, the costs of arbitration can exceed the costs of litigation and the right to discovery may be more limited in arbitration than in court. The arbitrator's award is binding and may be entered as a judgment in any court of competent jurisdiction.

You may choose to engage in arbitration hearings by telephone. Arbitration hearings not conducted by telephone shall take place in a location reasonably accessible from your primary residence, or in Orange County, California, at your option.

a) Initiation of Arbitration Proceeding. If either you or Epson decides to arbitrate a Dispute, both parties agree to the following procedure:

(i) Write a Demand for Arbitration. The demand must include a description of the Dispute and the amount of damages sought to be recovered. You can find a copy of a Demand for Arbitration at <http://www.jamsadr.com> ("Demand for Arbitration").

(ii) Send three copies of the Demand for Arbitration, plus the appropriate filing fee, to: JAMS, 500 North State College Blvd., Suite 600 Orange, CA 92868, U.S.A.

(iii) Send one copy of the Demand for Arbitration to the other party (same address as the Dispute Notice), or as otherwise agreed by the parties.

b) Hearing Format. During the arbitration, the amount of any settlement offer made shall not be disclosed to the arbitrator until after the arbitrator determines the amount, if any, to which you or Epson is entitled. The discovery or exchange of non-privileged information relevant to the Dispute may be allowed during the arbitration.

c) Arbitration Fees. Epson shall pay, or (if applicable) reimburse you for, all JAMS filings and arbitrator fees for any arbitration commenced (by you or Epson) pursuant to provisions of this Agreement.

d) Award in Your Favor. For Disputes in which you or Epson seeks \$75,000 or less in damages exclusive of attorney's fees and costs, if the arbitrator's decision results in an award to you in an amount greater than Epson's last written offer, if any, to settle the Dispute, Epson will: (i) pay you \$1,000 or the amount of the award, whichever is greater; (ii) pay you twice the amount of your reasonable attorney's fees, if any; and (iii) reimburse you for any expenses (including expert witness fees and costs) that your attorney reasonably accrues for investigating, preparing, and pursuing the Dispute in arbitration. Except as agreed upon by you and Epson in writing, the arbitrator shall determine the amount of fees, costs, and expenses to be paid by Epson pursuant to this Section 1.6d).

e) Attorney's Fees. Epson will not seek its attorney's fees and expenses for any arbitration commenced involving a Dispute under this Agreement. Your right to attorney's fees and expenses under Section 1.6d) above does not limit your rights to attorney's fees and expenses under applicable law; notwithstanding the foregoing, the arbitrator may not award duplicative awards of attorney's fees and expenses.

1.7 Opt-out. You may elect to opt-out (exclude yourself) from the final, binding, individual arbitration procedure and waiver of class and representative proceedings specified in this Agreement by sending a written letter to the Epson Address within thirty (30) days of your assent to this Agreement (including without limitation the purchase, download, installation of the Software or other applicable use of Epson Hardware, products and services) that specifies (i) your name, (ii) your mailing address, and (iii) your request to be excluded from the final, binding individual arbitration procedure and waiver of class and representative proceedings specified in this Section 1. In the event that you opt-out consistent with the procedure set forth above, all other terms shall continue to apply, including the requirement to provide notice prior to litigation.

1.8 Amendments to Section 1. Notwithstanding any provision in this Agreement to the contrary, you and Epson agree that if Epson makes any future amendments to the dispute resolution procedure and class action waiver provisions (other than a change to Epson's address) in this Agreement, Epson will obtain your affirmative assent to the applicable amendment. If you do not affirmatively assent to the applicable amendment, you are agreeing that you will arbitrate any Dispute between the parties in accordance with the language of this Section 1 (or resolve disputes as provided for in Section 1.7, if you timely elected to opt-out when you first assented to this Agreement).

1.9 Severability. If any provision in this Section 1 is found to be unenforceable, that provision shall be severed with the remainder of this Agreement remaining in full force and effect. **The foregoing shall not apply to the prohibition against class or representative actions as provided in Section 1.5. This means that if Section 1.5 is found to be unenforceable, the entire Section 1 (but only Section 1) shall be null and void.**

Parent topic: [Notices](#)

Trademarks

EPSON® is a registered trademark, EPSON Exceed Your Vision is a registered logomark, and Epson Connect™ is a trademark of Seiko Epson Corporation.

Epson iPrint™ and Remote Print™ are trademarks of Seiko Epson Corporation.

Windows is a registered trademark of Microsoft Corporation in the United States and/or other countries.

Apple, App Store, AirPrint, AirPrint logo, Mac, macOS, and OS X are trademarks of Apple Inc., registered in the U.S. and other countries.

Google® is a registered trademark and Android™, Chromebook™, Gmail™, Google Chrome™, Google Cloud Print™, Google Drive™, Google Photos™, and Google Play™ are trademarks of Google LLC.

Wi-Fi Direct® is a registered trademark of Wi-Fi Alliance®.

General Notice: Other product names used herein are for identification purposes only and may be trademarks of their respective owners. Epson disclaims any and all rights in those marks.



Parent topic: [Notices](#)

Copyright Notice

All rights reserved. No part of this publication may be reproduced, stored in a retrieval system, or transmitted in any form or by any means, electronic, mechanical, photocopying, recording, or otherwise, without the prior written permission of Seiko Epson Corporation. The information contained herein is designed only for use with this Epson product. Epson is not responsible for any use of this information as applied to other products.

Neither Seiko Epson Corporation nor its affiliates shall be liable to the purchaser of this product or third parties for damages, losses, costs, or expenses incurred by purchaser or third parties as a result of: accident, misuse, or abuse of this product or unauthorized modifications, repairs, or alterations to this product, or (excluding the U.S.) failure to strictly comply with Seiko Epson Corporation's operating and maintenance instructions.

Seiko Epson Corporation shall not be liable for any damages or problems arising from the use of any options or any consumable products other than those designated as Original Epson Products or Epson Approved Products by Seiko Epson Corporation.

Seiko Epson Corporation shall not be held liable for any damage resulting from electromagnetic interference that occurs from the use of any interface cables other than those designated as Epson approved Products by Seiko Epson Corporation.

This information is subject to change without notice.

[libTIFF Software Acknowledgment](#)

[A Note Concerning Responsible Use of Copyrighted Materials](#)

[Default Delay Times for Power Management for Epson Products](#)

[Copyright Attribution](#)

Parent topic: [Notices](#)

libTIFF Software Acknowledgment

Copyright © 1988-1997 Sam Leffler

Copyright © 1991-1997 Silicon Graphics, Inc.

Permission to use, copy, modify, distribute, and sell this software and its documentation for any purpose is hereby granted without fee, provided that (i) the above copyright notices and this permission notice appear in all copies of the software and related documentation, and (ii) the names of Sam Leffler and Silicon Graphics may not be used in any advertising or publicity relating to the software without the specific, prior written permission of Sam Leffler and Silicon Graphics.

THE SOFTWARE IS PROVIDED "AS-IS" AND WITHOUT WARRANTY OF ANY KIND, EXPRESS, IMPLIED OR OTHERWISE, INCLUDING WITHOUT LIMITATION, ANY WARRANTY OF MERCHANTABILITY OR FITNESS FOR A PARTICULAR PURPOSE.

IN NO EVENT SHALL SAM LEFFLER OR SILICON GRAPHICS BE LIABLE FOR ANY SPECIAL, INCIDENTAL, INDIRECT OR CONSEQUENTIAL DAMAGES OF ANY KIND, OR ANY DAMAGES WHATSOEVER RESULTING FROM LOSS OF USE, DATA OR PROFITS, WHETHER OR NOT ADVISED OF THE POSSIBILITY OF DAMAGE, AND ON ANY THEORY OF LIABILITY, ARISING OUT OF OR IN CONNECTION WITH THE USE OR PERFORMANCE OF THIS SOFTWARE.

Parent topic: [Copyright Notice](#)

A Note Concerning Responsible Use of Copyrighted Materials

Epson encourages each user to be responsible and respectful of the copyright laws when using any Epson product. While some countries' laws permit limited copying or reuse of copyrighted material in certain circumstances, those circumstances may not be as broad as some people assume. Contact your legal advisor for any questions regarding copyright law.

Parent topic: [Copyright Notice](#)

Default Delay Times for Power Management for Epson Products

This product will enter sleep mode after a period of nonuse. This is to ensure that the product meets Energy Star standards of energy efficiency. More energy savings can be achieved by setting the time to sleep to a shorter interval.

Parent topic: [Copyright Notice](#)

Copyright Attribution

© 2019 Epson America, Inc.

4/19

CPD-56917

Parent topic: [Copyright Notice](#)