

# VZ-CMP SERIES

## 32" and 43" PROFESSIONAL

---

LED CCTV MONITOR **USER MANUAL**



**ViewZ**<sup>®</sup>  
[www.viewzusa.com](http://www.viewzusa.com)

Please read this manual thoroughly before use, and keep it handy for future reference.

# CONTENTS

<b>Safety Instruction</b> .....	3
1. Mark Indication & Substance .....	4
2. Warning .....	4
3. Caution .....	5
4. Operational Temperature & Humidity .....	5
5. Dot Defect (dead pixel) of TFT .....	5
6. FCC RF INTERFERENCE STATEMENT .....	6
<b>Installation</b> .....	7
1. Package .....	7
2. Interface .....	8
3. Remote Control Function .....	9
<b>Function</b> .....	10
1. Monitor Button Function .....	10
2. OSD Control and Function .....	11
<b>Mounting Guide</b> .....	16
<b>Specification</b> .....	17
<b>Trouble Shooting</b> .....	18
<b>RMA</b> .....	19
<b>Warranty</b> .....	20

# SAFETY INSTRUCTION

## Important Safety Instruction

1. Read all warnings.
2. Follow all instructions to ensure longevity of monitor.
3. Do not place the monitor near water.
4. Clean only with dry cloth.
5. Do not block any ventilation openings. Install in accordance with the manufacturer's instructions.
6. Do not install near any heat sources such as radiators, heat registers, stoves, or other heat generating devices.
7. Do not override the safety purpose of the polarized or grounding-type plug.
8. A polarized plug has two blades with one wider than the other.
9. A grounding type plug has two blades and a third grounding prong.
10. The wide blade or the third prong are provided for your safety.
11. If the provided plug does not fit into your outlet, consult with electrician for replacement of the outlet.
12. Protect the power cord from being walked on or pinched particularly at plugs, convenience receptacles and the point where it connects to the monitor.
13. Only use attachment/accessories specified by the manufacturer.
14. Use only with the cart, stand, tripod, bracket or table specified by the manufacturer or sold with the monitor. When a cart is used, use caution when moving the cart & monitor in combination to avoid injuries.
15. Unplug the monitor during lightning storms or when unused for long periods of time.
16. Refer all servicing to qualified service personnel. Servicing is required when the monitor has been damaged in any way.



The monitor shall not be exposed to dripping or splashing and objects containing liquids, such as vases shall be placed near the monitor.

The monitor should have ample distance (e.g. 10cm) from the wall for sufficient ventilation.

# SAFETY INSTRUCTION

## Important Safety Instruction

### Mark Indication and Substance



CAUTION : TO REDUCE THE RISK OF ELECTRICAL SHOCK,  
DO NOT REMOVE COVER (OR BACK). NO USER  
SERVICEABLE PARTS INSIDE. REFER SERVICING TO  
QUALIFIED SERVICE PERSONNEL



This symbol is intended to alert the user to the presence of uninsulated & dangerous voltage within the monitor's enclosure that may be of sufficient magnitude to constitute a risk of electric shock to persons.



This symbol is intended to alert the user to the presence of important operating and maintenance (servicing) instructions in the literature accompanying the monitor.

### Warning

- Do not use damaged or loose cables and plug.
- Do not pull the plug out by the wire nor touch the plug with wet hands.
- Use only a properly grounded plug and receptacle.
- Do not connect too many extension cords or plugs to one outlet.
- Do not excessively bend the plug and wire.
- Do not disconnect the power cord while it's still plugged into the monitor.
- Do not place any heavy objects on the power cord. Damage to the cord may cause shock or fire.
- Never open the monitor. There are no user-serviceable parts inside and opening will void warranty.
- Removing covers may expose you to dangerous shock hazards or other risks.
- Keep any heating devices away from the power cable and monitor.
- Do not place the monitor near water.
- Do not insert objects of any kind into the monitor's open slots, as they may touch dangerous voltage points.
- Please follow the laws and regulations of your municipality to dispose of the tube properly.
- Do not use the monitor in high temperature, humid, dusty or oily areas.
- Do not install the monitor where it will be exposed to continual vibration.
- Keep the plastic packaging out of children's reach.
- If any damage is defected upon first opening the box, contact agency from which you bought the monitor directly.
- If your monitor does not operate normally – in particular, if there is any unusual sound or smell coming from the monitor – unplug it immediately and contact an authorized dealer or the service center.

# SAFETY INSTRUCTION

## Important Safety Instruction

### Caution

- If the connector between the plug and the pin is dusty or dirty, clean it properly using a dry cloth.
- Make sure to unplug the power cord before cleaning the monitor.
- Make sure to leave a gap between monitor and wall.
- Do not drop the monitor when moving it.
- Place your monitor in a location with low humidity and a minimum dust.
- Install the monitor base on a showcase or shelf so that the end of the base does not protrude from the showcase or shelf.
- Do not place the monitor on an unstable or small surface area.
- Do not install inside a vehicle.
- Disconnect the plug from the outlet during storms or lightning or if it has not been used for a long time.
- Do not try to move the monitor by pulling on the power cord.
- Do not cover the vents on the monitor.
- When moving the monitor, turn off and unplug the power cord. Make sure that all cables, including HDMI cable and cables connected to other devices, are disconnected before moving it.
- Place the monitor out of children's reach, as they could damage it by hanging onto it.

### Available Temperature & Humidity

- Operating Temperature : 14°F ~ 122°F / -10°C ~ 50°C
- Operating Humidity : 20 ~ 70% RH

## Dot Defect (dead pixel) of TFT

ViewZ monitors are manufactured using high-end semiconductor technology with precision ratings of 99.9% and above. However, it may be the case that certain RGB and white pixels seem darker (or entirely unlit i.e. black).

Modern production methods cannot guarantee an absolute fault-free monitor. To this effect, no LED manufacturer can guarantee a defect free panel. A few isolated pixel or sub-pixel faults are considered tolerable and different policies exist that govern the amount of these tolerable values.

While most pixel faults occur in isolated regions, a cluster of dead pixels or sub-pixels can sometimes form for which a separate ruling applies. A cluster is defined as an area of 5x5 pixels. ViewZ's policy on pixel failure: either as an isolated fault or in the form of a cluster is outlined on the website: [www.viewzusa.com](http://www.viewzusa.com)

# FCC RF INTERFERENCE STATEMENT

## Note

This equipment has been tested and found to comply with the limits for a Class A digital device, pursuant to Part 15 of the FCC Rules. These limits are designed to provide reasonable protection against harmful interference in a residential installation.

This equipment generates, uses and can radiate radio frequency energy and, if not installed and used in accordance with the instructions, may cause harmful interference to radio communications. However, there is no guarantee that interference will not occur in a particular installation.

If this equipment does cause harmful interference to radio or television reception which can be determined by turning the equipment off and on, the user is encouraged to try to correct the interference by one or more of the following measures.

- Reorient or relocate the receiving antenna.
- Increase the separation between the equipment and receiver.
- Connect the equipment into an outlet on a circuit different from that to which the receiver is connected.
- Consult the dealer or an experienced radio, TV technician for help.
- Only shielded interface cable should be used.

Finally, any changes or modifications to the equipment by the user not expressly approved by the grantee or manufacturer could void the users authority to operate such equipment.

### ► DOC COMPLIANCE NOTICE

This digital apparatus does not exceed the Class A limits for radio noise emissions from digital apparatus set out in the radio interference regulation of Canadian Department of communications.

# INSTALLATION

## Installation Tools

The following tools may be required depending on your installation.

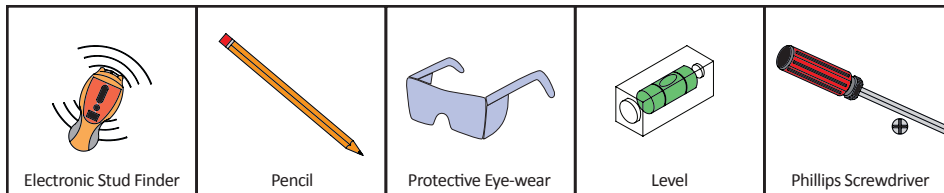

## Assembly Components - provided

Your ViewZ monitor is shipped with all proper installation hardware and components. If there are parts missing and/or damaged, please stop the installation and contact ViewZ USA at (888)-998-4399.

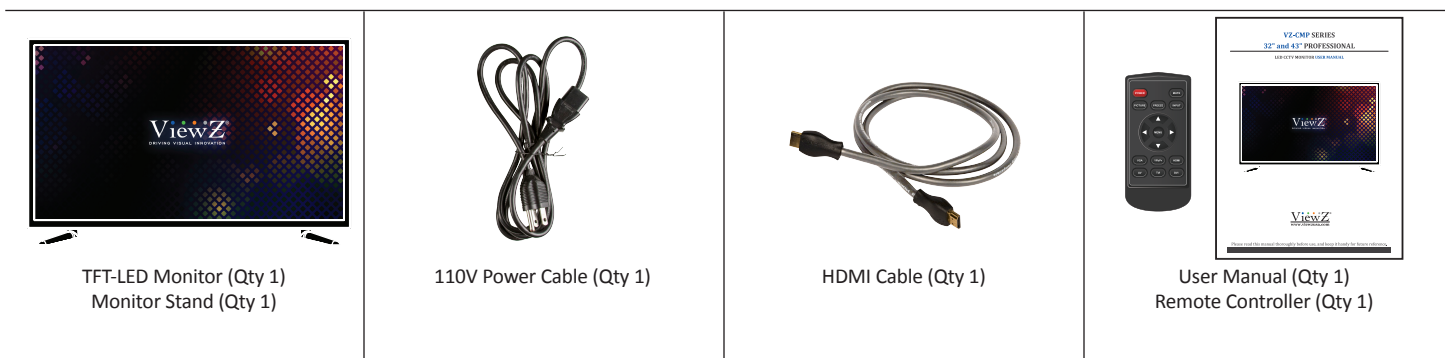



## Mounting Option

Your ViewZ monitor is compatible with ViewZ monitor mounts. For more information, please contact ViewZ USA at (888)-998-4399.

### Wall Mount

- |  |   |  |   |  |   |
|--|---|--|---|--|---|
| <ul style="list-style-type: none"> <li>Part # <b>WM50</b></li> </ul>  | <ul style="list-style-type: none"> <li>Tilting <math>-15^{\circ} \sim 0^{\circ}</math></li> <li>Universal Mount</li> <li>Compatible with <b>VZ-32CMP</b></li> </ul> | <ul style="list-style-type: none"> <li>Part # <b>WM71</b></li> </ul>  | <ul style="list-style-type: none"> <li>Tilting <math>-15^{\circ} \sim 0^{\circ}</math></li> <li>Universal Mount</li> <li>Compatible with <b>VZ-43CMP</b></li> </ul> | <ul style="list-style-type: none"> <li>Part # <b>AM02-A</b></li> </ul>  | <ul style="list-style-type: none"> <li>Tilting <math>-15^{\circ} \sim 15^{\circ}</math></li> <li>Swivel <math>180^{\circ}</math></li> <li>VESA <math>75 \sim 200</math></li> <li>Compatible with <b>VZ-32CMP</b></li> </ul> |
|--|---|--|---|--|---|

### Ceiling Mount

- |  |  |  |  |
|--|--|--|--|
| <ul style="list-style-type: none"> <li>Part # <b>CMKIT-02</b></li> </ul>  | <ul style="list-style-type: none"> <li>Tilting <math>-12^{\circ} \sim +5^{\circ}</math></li> <li>Rotation <math>360^{\circ}</math></li> <li><b>35" ~ 70"</b></li> <li>Compatible with <b>VZ-32CMP, VZ-43CMP</b></li> </ul> | <ul style="list-style-type: none"> <li>Part # <b>CMKIT-04</b></li> </ul>  | <ul style="list-style-type: none"> <li>Tilting <math>-12^{\circ} \sim +5^{\circ}</math></li> <li>Universal Mount</li> <li><b>35" ~ 70"</b></li> <li>Compatible with <b>VZ-43CMP</b></li> </ul> |
|--|--|--|--|

# CONNECT EXTERNAL EQUIPMENTS

## Interface Input Ports

The following image is the description of interface input ports of BNC Monitor

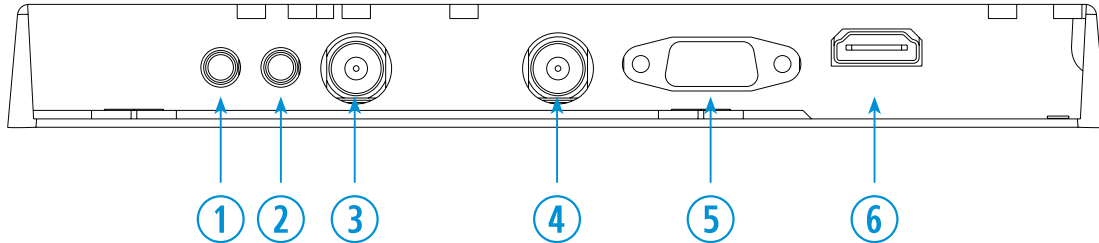

1. AV AUDIO IN
2. PC STEREO IN
3. AV (CVBS) OUT
4. AV (CVBS) IN
5. VGA IN
6. HDMI IN



# REMOTE FUNCTION

## Remote Controller

1. Power
2. Picture - Select Picture Mode
3. Freeze - Freeze the Display Image
4. Up
5. Left
6. Menu
7. Right
8. Down
9. Mute
10. Input
11. VGA Input Select
12. YPbPr Input Select - N / A
13. HDMI Input Select
14. AV Input Select - CVBS
15. TVI Input Select - N / A
16. DVI Input Select - N / A



Display image, sound and custom settings can be adjusted in OSD (On Screen Display) menu by remote controller.  
To adjust monitor setting value :

1. Press the **'MENU'** button to enter the OSD menu
2. Press the **'INPUT'** button to select input source
3. Press the **'FREEZE'** button to freeze current display image On / Off - only available on the remote controller
4. Press the **▲ / ▼** buttons to select the desired sub-menu. The selected submenu will be highlighted
5. Press the **'MENU'** button to enter the sub-menu for adjusting items
6. Change the value you wish to adjust by using the **◀ / ▶** buttons
7. Press the **'MENU'** button to confirm / exit for saving adjustment value on sub-menu
8. Without entering OSD MENU, press **◀ / ▶** buttons to adjust the audio volume
9. Without entering OSD MENU, press **HDMI, AV & VGA buttons** to select desired input source
10. Press the **'MUTE'** button to on / off audio

# CONTROL AND FUNCTION

## On Monitor, Button Control

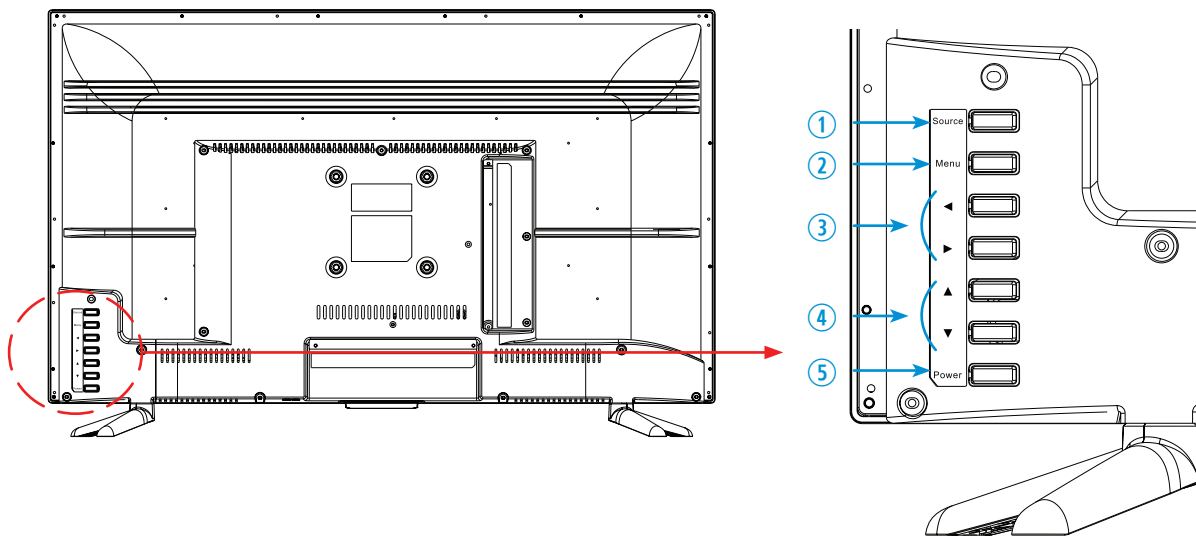

1. Source  
Select an input source
2. Menu  
Enter the MENU, save the adjustment of sub-menu and exit the OSD
3. Left & Right ◀ (VOL) ▶  
Change the value on selected menu
4. Up & Down ▲ ▼  
Switch a menu on OSD
5. Power  
Monitor power on / off

## Monitor Button Function

All picture, sound settings and setup can be adjusted in OSD (On Screen Display) menu.

To adjust the OSD screen:

1. Press the **MENU** button to enter the **OSD MENU**
2. Press the ◀ / ▶ buttons to select the desired **main-MENU**. The selected **main-MENU** is highlighted
3. Press the ▲ / ▼ buttons to select the desired **sub-MENU**. The selected **sub-MENU** is highlighted
4. Change the value you wish to adjust by using the ◀ / ▶ buttons
5. Press the **MENU** button to confirm the adjustment on **sub-MENU**
6. Press the **MENU** button to exit the **sub-MENU** and go back to the **main-MENU**
7. Press the **MENU** button to exit the **OSD MENU**

# CONTROL AND FUNCTION

## Select Input Source

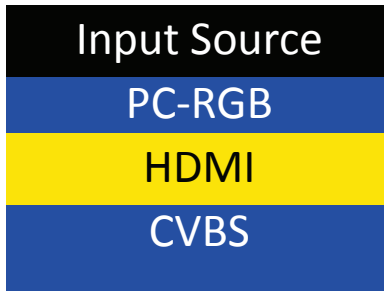

Press 'SOURCE' button on monitor or 'INPUT' button on remote controller

Press ▲ / ▼ button to change input source and then press ► button to select input source on monitor

Press ▲ / ▼ button to change input source and then press 'INPUT' / ► buttons to select input source on remote controller

## Volume



Press ◀ / ▶ buttons to adjust volume on monitor

Press ◀ / ▶ buttons to adjust volume on remote controller

## Detect Source Signal Message

If you connect any input source, monitor will display current input source resolution and frequency.

# CONTROL AND FUNCTION

## Picture

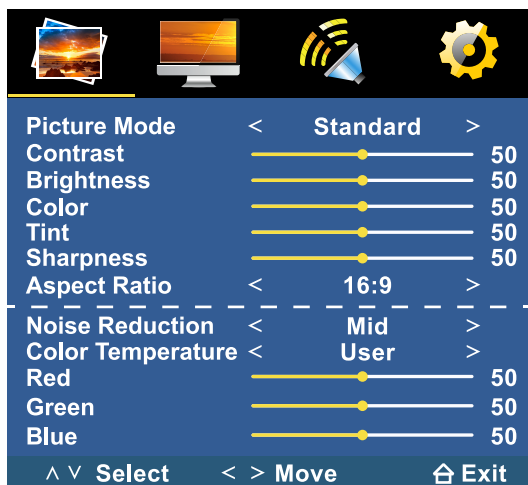

▲/▼ MOVE ◀/▶ SELECT(ADJUST) MENU RETURN

	FUNCTION	VALUE
PICTURE MODE	Adjust the image color setting	See table below
CONTRAST	Adjust the contrast	0 ~ 100
BRIGHTNESS	Adjust the brightness	0 ~ 100
COLOR	Adjust the color saturation	0 ~ 100
TINT <sup>1)</sup>	Adjust the tint	0 ~ 100
SHARPNESS <sup>2)</sup>	Adjust the sharpness	0 ~ 100
ASPECT RATIO	Adjust the video format	See table below
NOISE REDUCTION	Adjust the noise reduction value	See table below
COLOR TEMP	Adjust the color setting	See table below

1) Only available in AV(CVBS) input

2) Only available in AV(CVBS) & HDMI input

### PICTURE MODE

MILD	Reduce contrast and sharpness
USER	Apply user selected values - brightness, contrast, color and hue
DYNAMIC	Provide enhanced contrast and sharpness
STANDARD	Provide standard contrast and sharpness

### ASPECT RATIO

16 : 9	Set the image size to 16 : 9
4 : 3	Set the image size to 4 : 3

### COLOR TEMP.

WARM	Give the white color a reddish tint
NORMAL	Give the white color a neutral tint
COOL	Give the white color a blue-ish tint
USER <sup>1)</sup>	Set custom color temperature

1) To set custom color temperature (R,G,B values), select "USER" to set color temperature. Keep pushing 'Down' button on the monitor or the remote controller, then you will see Red, Green and Blue option

	FUNCTION	VALUE
NOISE REDUCTION <sup>1)</sup>	Reduce noise of the display image	LOW / MID / HIGH / DEFAULT / OFF

1) Only available in AV(CVBS) & HDMI input

# CONTROL AND FUNCTION

## PC (available on VGA input)

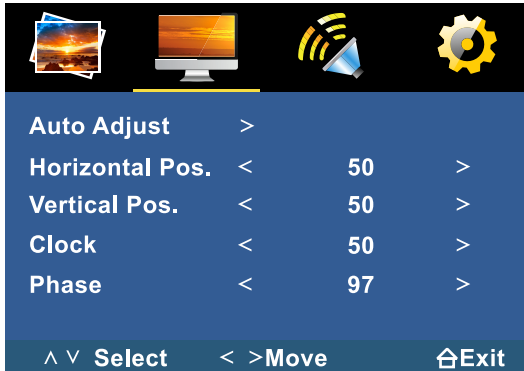

▲/▼ MOVE ◀/▶ SELECT(ADJUST) MENU RETURN

FUNCTION		VALUE
AUTO ADJUST <sup>1)</sup>	Fit the image size automatically	
H-POSITION <sup>1)</sup>	Adjust the horizontal position of picture	0 ~ 100
V-POSITION <sup>1)</sup>	Adjust the vertical position of picture	0 ~ 100
CLOCK <sup>1)</sup>	Adjust the number of horizontal picture elements	0 ~ 100
PHASE <sup>1)</sup>	Adjust the vertical noise of screen image	0 ~ 100

1) Only available in VGA input

# CONTROL AND FUNCTION

## Sound

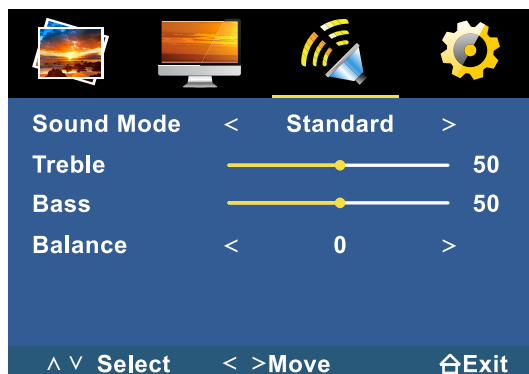

▲/▼ MOVE ◀/▶ SELECT(ADJUST) MENU RETURN

FUNCTION		VALUE
SOUND MODE	Select one of the presets	STANDARD / MUSIC / MOVIE / SPORTS / USER
TREBLE	Adjust the treble level	0 ~ 100
BASS	Adjust the bass level	0 ~ 100
BALANCE	Adjust the balance	-50 ~ +50

# CONTROL AND FUNCTION

## OSD

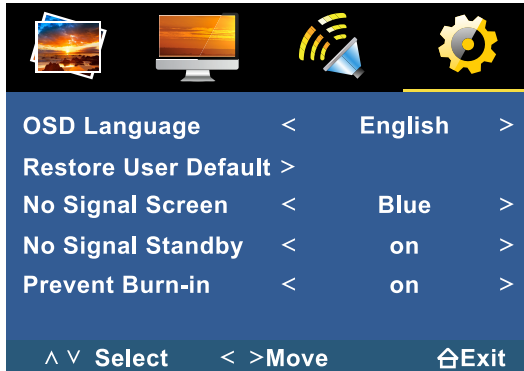

▲/▼ MOVE ◀/▶ SELECT(ADJUST) MENU RETURN

FUNCTION		VALUE
OSD LANGUAGE	Set the language of the OSD menu	English, German, French Spanish, Italian, Denmark Poland, Netherland
RESTORE USER DEFAULT	Reset the monitor settings to the factory default	
NO SIGNAL SCREEN	Set the standby mode screen as blue or black (default) color	Blue, Black
NO SIGNAL STANDBY	Monitor will go into a standby mode when no input source is detected	ON / OFF
PREVENT BURN-IN	Set periodic image retention	ON / OFF

# MOUNTING GUIDE

## Wall Mounting (Optional)

VZ-CMP monitors are suitable for VESA wall mount (not included in the delivery).

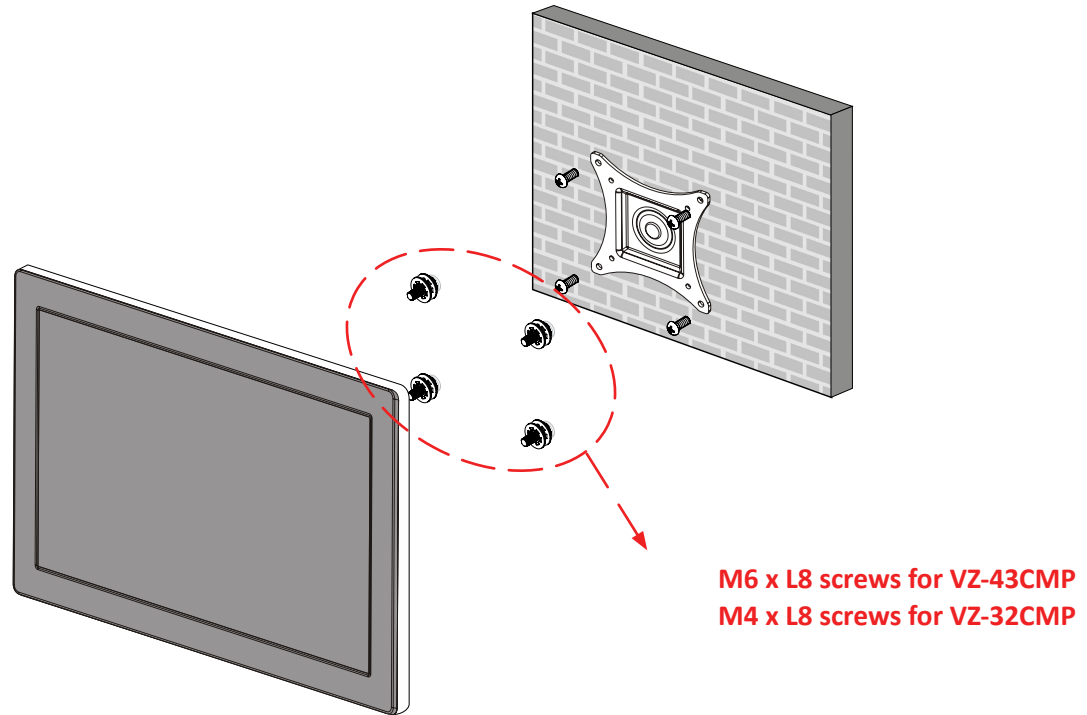

1. VZ-32CMP : VESA WALL MOUNT 100 mm x 100 mm
2. VZ-43CMP : VESA WALL MOUNT 200 mm x 100 mm

### ! Attention!

VZ-32CMP : You must use 4 \* M4 x L8 screws to assemble this monitor and the wall mount bracket.

VZ-43CMP : You must use 4 \* M6 x L8 screws to assemble this monitor and the wall mount bracket.

### ! WARNING !

If user uses screws longer than M6 x L8 mm for VZ-43CMP & M4 x L8 mm for VZ-32CMP , it may cause damage to the unit. Please use bolt of correct size and length as instructed.



### Mounting Safety !

At least two people are recommended to safely install the mount.



# SPECIFICATION

Model No.		VZ-32CMP	VZ-43CMP
Size & Type		32"	43"
LCD	Panel Type	32" LED Backlit Monitor	43" LED Backlit Monitor
	Pixel Pitch (mm)	0.36375 (H) x 0.36375 (V) mm	0.4902 (H) x 0.4902 (V) mm
	Brightness	220 cd/m <sup>2</sup>	250 cd/m <sup>2</sup>
	Contrast Ratio	3000 : 1	1200 : 1
	Viewing Angle	178° / 178°	
	Display Color	16.7 Million Colors	
	Response Time	< 14 ms	< 8 ms
	Resolution	1920 (H) x 1080 (V)	
	Active Display Area	698.4 (H) x 392.85 (V)	953.0 (H) x 543.0 (V)
	Aspect Ratio	16 : 9	
Case Type		Black Metal	
Color Temperature		Warm / Standard / Cool	
Speaker		2 x 5W	
Operating Temperature		14°F ~ 122°F / -10°C - 50°C	
Operating Humidity		20 ~ 70% RH	
Weight		Net : 12.78 lbs / 5.8 kg Gross : 15.43 lbs / 7.0 kg	Net : 19.26 lbs / 8.9 kg Gross : 25.35 lbs / 11.5 kg
INTERFACE		CVBS AV (1ch input 1.0Vp-p, 75Ω terminated, 1ch loop-through out) HDMI (High Definition Multimedia Interface) VGA (RGB-PC), PC Stereo In / AV Audio In	
Safety & EMC Certification		CE / FCC / RoHS	
Electrical Ratings		AC 100-240V, 50/60Hz	AC 100-240V, 50/60Hz
Power Consumption		≤ 50 W (Max)	≤ 65 W (Max)
Accessories		AC 110V Power cable, User's Manual, Remote controller	

# TROUBLESHOOTING GUIDE

- Check the following before calling for service.
- If the same problems continue after checking, contact the reseller you purchased the monitor from.

At start	We recommend that you test with different input sources when you have trouble with the current input source. If symptom persists, follow the instructions below. After following the instructions below, please contact us at 1-888-99-VIEWZ.
No image or Noise on the screen	<ul style="list-style-type: none"> <li>- Make sure the cable is correctly plugged into the outlet</li> <li>- Make sure the power cable is correctly plugged into the monitor</li> <li>- Make sure the cable is correctly connected between monitor &amp; source</li> <li>- Check brightness and see if brightness is set to 'Ø'</li> <li>- Check video source</li> </ul>
Incorrect display or Half display	<ul style="list-style-type: none"> <li>- Check your video source</li> <li>- Reset video source : connection, cable replacement, setting &amp; more</li> </ul>
Flickering and shadow image	<ul style="list-style-type: none"> <li>- Check your input source setting for resolution and phase (Hz)</li> </ul>
The audio function is not working	<ul style="list-style-type: none"> <li>- Check the volume and make sure MUTE is not on</li> <li>- Check HDMI / Audio port cable connection</li> </ul>
LED is flickering or no image	<ul style="list-style-type: none"> <li>- Check the interface cable connection and make sure it's plugged in correctly</li> <li>- Check the input source</li> </ul>

# TERMS OF WARRANTY / RMA

- The warranty period for this monitor is 3 years. The warranty will be voided for the scenarios listed below.
- You can also download the manual and information of VIEWZ web site: VIEWZUSA.COM

Cases of Non-Warranty Coverage	When power feed to the monitor exceeds capacity and causes damage
	Accident, Abuse, Misuse, Neglect, Fire, Water/liquids, Lightning or any act of nature
	Damaged by dropping, throwing and hitting the monitor
	Failure caused by users attempt to modify the product
	Failure by limited life of parts such as LED Lamps and any other consumables
	Damaged by using third party power cable, unstable power input and electric shock

\* Above information can be changed without notification - please check our website or contact ViewZ representative for latest RMA service policy.

\* When shipping the monitor for RMA, make sure to pack safely to ensure the monitor is not damaged during shipping.

# WARRANTY

## ViewZ USA LIMITED 3 YEAR WARRANTY

### What and Who is Covered by this Limited Warranty and for How Long

ViewZ USA warrants this product to be free from defects in material and workmanship for 3 years to the original owner of this product. The limited warranty is valid only for the original purchaser of the product.

### What ViewZ USA Will Do

At the sole discretion of ViewZ USA, ViewZ USA will repair or replace any product or product part that is defective. If ViewZ USA chooses to replace a defective product or part, a replacement product or part will be shipped to you at no charge, but you must pay any labor costs.

### What is Not Covered; Limitations

ViewZ USA disclaims any liability for damage to mounts, adapters, displays, projectors, other property, or personal injury resulting, in whole or in part, from improper installation, modification, use or misuse of its products.

ViewZ USA disclaims all other warranties, express or implied, including warranties of merchantability and fitness for a particular purpose. ViewZ USA is not responsible for incidental or consequential damages, including but not limited to, inability to use its products or labor costs for removing and replacing defective products or parts. Some states do not allow the exclusion or limitation of incidental or consequential damage, so the above limitation or exclusion may not apply to you.

### What Customers Must Do for Limited Warranty Service

If you discover a problem that you think may be covered by the warranty you MUST REPORT it in writing to the address below within thirty (30) days. Proof of purchase (an original sales receipt) from the original consumer purchaser must accompany all warranty claims. Warranty claims must also include a description of the problem, the purchaser's name, address, and telephone number. General inquiries can be addressed to ViewZ USA Customer Service at 1-888-998-4399. Warranty claims will not be accepted over the phone or by fax.

ViewZ USA  
Attn: Warranty Claim  
177 W. Orangethorpe Ave.  
Placentia, CA 92870

### How State Law Applies

This warranty gives you specific legal rights, and you may also have other rights which vary from state to state.

### Disclaimer

ViewZ USA intends to make this manual accurate and complete. However, ViewZ USA makes no claim that the information contained herein covers all details, conditions or variations, nor does it provide for every possible contingency in connection with the installation or use of this monitor. The information contained in this document is subject to change without notice or obligation of any kind. ViewZ USA makes no representation of warranty, expressed or implied, regarding the information contained herein. ViewZ USA assumes no responsibility for accuracy, completeness or sufficiency of the information contained in this document.

### Contact Us

**NORTH AMERICA**  
177 W. Orangethorpe Ave.  
Placentia, CA 92870  
USA and Canada  
Phone: 1-888-998-4399  
Fax: 1-714-996-1138  
Other Locations  
Phone: (001) 888-998-4399  
Fax: (001) 714-996-1138