

3 x 1 Ceiling Menu Board Tilt

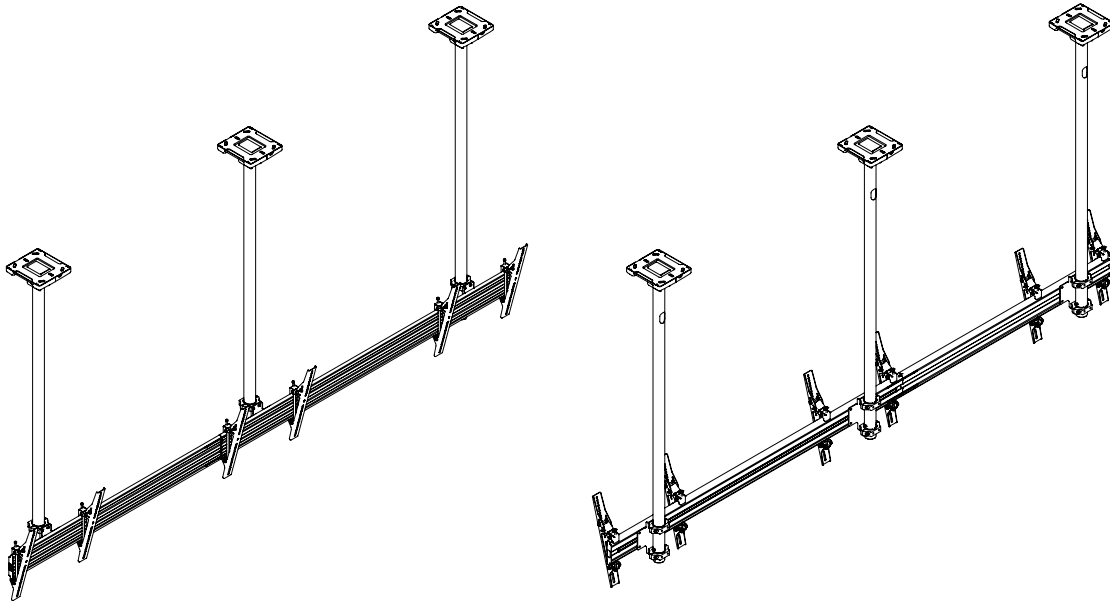

INSTALL GUIDELINES

✓ TWO PERSON INSTALL RECOMMENDED.

- Read and understand Installation Safety Instructions before commencing installation.
- Atdec recommends that a professional AV installer or other suitably qualified person install this product.
- Configurations should be installed in a symmetrical manner for optimal safety.
- Place rail supports (ADB-RPJ, ADB-RUJ, ADB-WP) evenly along the length of a Rail segment to provide even loading of components.
- ADB-R175 requires two rail supports (ADB-RPJ, ADB-RUJ, ADB-WP) to support a load of 200lbs (100kg). If one rail support is used, the rail can only support 110lbs (50kg) maximum load.
- Fasten ADB-RX symmetrically over the junction of Rail segments. Tighten the set screws of ADB-RX firmly.
- Place ADB-P Poles and ADB-RPJ Rail Pole Joiners directly behind the centre of each screen.
- Ensure that each ADB-R Rail is supported by at least one ADB-WP Wall Plate.
- When attaching displays, attach in an order that ensures stability during installation. Alternate the loading order such that loads are balanced across to system. Alternate the side onto which screens are placed to distribute load evenly.

REQUIRED TOOLS

- Power driver
- 13mm Hex socket
- Crosshead Screwdriver

OPTIONAL TOOLS

- Spirit Level

COMPONENT & PARTS CHECKLIST

A		ADB-PC Pole Ceiling Fixture	QTY:3
Ref	Part name		Qty
A1	Ceiling Plate		1
A2	Plate Covers		2
A3	M8 x 70mm Screw		3
A4	M8 Washer		12
A5	M8 Nut		4
A6	Plastic Anchor		6
A7	Coach Screw		6
A8	Open Wrench		1
A9	6mm Hex Key		1
A10	M8 x 60mm Screw		1
A11	End Cap		1

220lbs
100kg

COMPONENT & PARTS CHECKLIST (cont.)

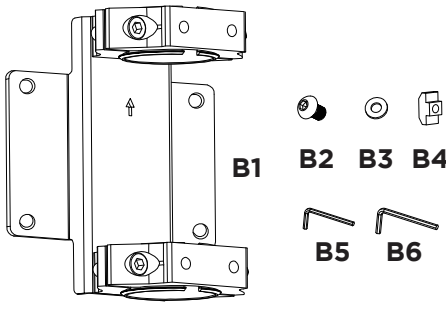
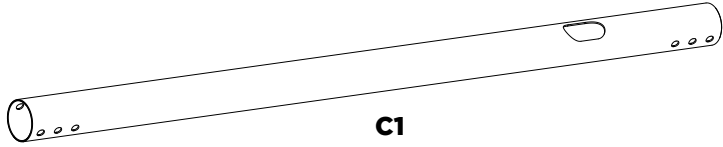
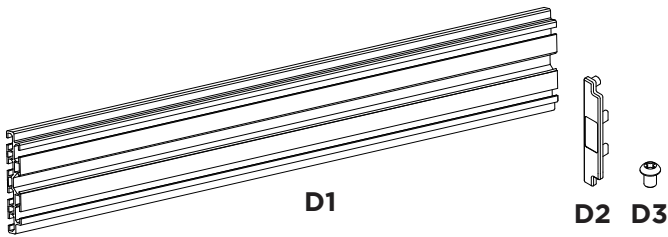
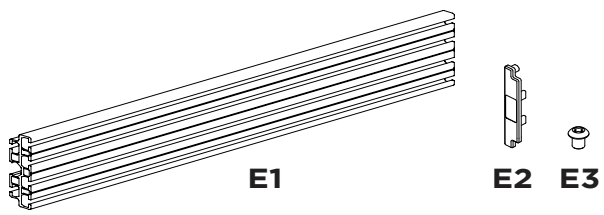
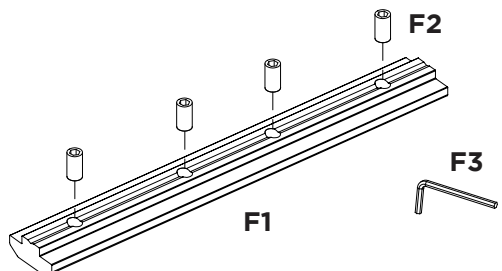
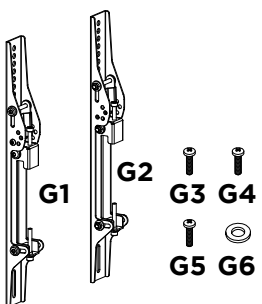
<p>B</p>  <p>B1 B2 B3 B4 B5 B6</p> <p>220lbs 100kg</p>	<p>ADB-RPJ Rail Pole Joiner QTY:3</p> <table border="1"> <thead> <tr> <th>Ref</th> <th>Part name</th> <th>Qty</th> </tr> </thead> <tbody> <tr> <td>B1</td> <td>Rail-Pole Plate</td> <td>1</td> </tr> <tr> <td>B2</td> <td>M8 x 12mm Screw</td> <td>4</td> </tr> <tr> <td>B3</td> <td>M8 Washer</td> <td>4</td> </tr> <tr> <td>B4</td> <td>M8 Sliding Nut</td> <td>4</td> </tr> <tr> <td>B5</td> <td>5mm Allen Key</td> <td>1</td> </tr> <tr> <td>B6</td> <td>6mm Allen Key</td> <td>1</td> </tr> </tbody> </table>	Ref	Part name	Qty	B1	Rail-Pole Plate	1	B2	M8 x 12mm Screw	4	B3	M8 Washer	4	B4	M8 Sliding Nut	4	B5	5mm Allen Key	1	B6	6mm Allen Key	1
Ref	Part name	Qty																				
B1	Rail-Pole Plate	1																				
B2	M8 x 12mm Screw	4																				
B3	M8 Washer	4																				
B4	M8 Sliding Nut	4																				
B5	5mm Allen Key	1																				
B6	6mm Allen Key	1																				
<p>C</p>  <p>C1</p> <p>220lbs 100kg</p>	<p>ADB-P150-B 150 Pole QTY:3</p> <table border="1"> <thead> <tr> <th>Ref</th> <th>Part name</th> <th>Qty</th> </tr> </thead> <tbody> <tr> <td>C1</td> <td>Pole Ø 1.97" (50mm), 59.06" (1500mm) Long</td> <td>1</td> </tr> </tbody> </table>	Ref	Part name	Qty	C1	Pole Ø 1.97" (50mm), 59.06" (1500mm) Long	1															
Ref	Part name	Qty																				
C1	Pole Ø 1.97" (50mm), 59.06" (1500mm) Long	1																				
<p>D</p>  <p>D1 D2 D3</p> <p>100kg (220lbs)</p>	<p>ADB-R175-S 175 Rail QTY:1</p> <table border="1"> <thead> <tr> <th>Ref</th> <th>Part name</th> <th>Qty</th> </tr> </thead> <tbody> <tr> <td>D1</td> <td>Rail, 68.90" (1750mm)</td> <td>1</td> </tr> <tr> <td>D2</td> <td>End Cap</td> <td>2</td> </tr> <tr> <td>D3</td> <td>M5 x 8mm Screw</td> <td>2</td> </tr> </tbody> </table>	Ref	Part name	Qty	D1	Rail, 68.90" (1750mm)	1	D2	End Cap	2	D3	M5 x 8mm Screw	2									
Ref	Part name	Qty																				
D1	Rail, 68.90" (1750mm)	1																				
D2	End Cap	2																				
D3	M5 x 8mm Screw	2																				
<p>E</p>  <p>E1 E2 E3</p> <p>220lbs 100kg</p>	<p>ADB-R125-S 125 Rail QTY:1</p> <table border="1"> <thead> <tr> <th>Ref</th> <th>Part name</th> <th>Qty</th> </tr> </thead> <tbody> <tr> <td>E1</td> <td>Rail, 1250mm (49.21")</td> <td>1</td> </tr> <tr> <td>E2</td> <td>End Cap</td> <td>2</td> </tr> <tr> <td>E3</td> <td>M5 x 8mm Screw</td> <td>2</td> </tr> </tbody> </table>	Ref	Part name	Qty	E1	Rail, 1250mm (49.21")	1	E2	End Cap	2	E3	M5 x 8mm Screw	2									
Ref	Part name	Qty																				
E1	Rail, 1250mm (49.21")	1																				
E2	End Cap	2																				
E3	M5 x 8mm Screw	2																				
<p>F</p>  <p>F1 F2 F3</p>	<p>ADB-RX Rail Extension Kit QTY:1</p> <table border="1"> <thead> <tr> <th>Ref</th> <th>Part name</th> <th>Qty</th> </tr> </thead> <tbody> <tr> <td>F1</td> <td>Rail Extender Bar</td> <td>1</td> </tr> <tr> <td>F2</td> <td>M6 x 8mm Set Screw</td> <td>4</td> </tr> <tr> <td>F3</td> <td>3mm Allen Key</td> <td>1</td> </tr> </tbody> </table>	Ref	Part name	Qty	F1	Rail Extender Bar	1	F2	M6 x 8mm Set Screw	4	F3	3mm Allen Key	1									
Ref	Part name	Qty																				
F1	Rail Extender Bar	1																				
F2	M6 x 8mm Set Screw	4																				
F3	3mm Allen Key	1																				
<p>G</p>  <p>G1 G2 G3 G4 G5 G6</p> <p>110lbs 50kg</p>	<p>ADB-B400T VESA 400 Tilt Brackets QTY:3</p> <table border="1"> <thead> <tr> <th>Ref</th> <th>Part name</th> <th>Qty</th> </tr> </thead> <tbody> <tr> <td>G1</td> <td>Tilt Bracket - Right</td> <td>1</td> </tr> <tr> <td>G2</td> <td>Tilt Bracket - Left</td> <td>1</td> </tr> <tr> <td>G3</td> <td>M5 x 15mm Screw</td> <td>4</td> </tr> <tr> <td>G4</td> <td>M6 x 15mm Screw</td> <td>4</td> </tr> <tr> <td>G5</td> <td>M8 x 15mm Screw</td> <td>4</td> </tr> <tr> <td>G6</td> <td>M6 Washer</td> <td>4</td> </tr> </tbody> </table>	Ref	Part name	Qty	G1	Tilt Bracket - Right	1	G2	Tilt Bracket - Left	1	G3	M5 x 15mm Screw	4	G4	M6 x 15mm Screw	4	G5	M8 x 15mm Screw	4	G6	M6 Washer	4
Ref	Part name	Qty																				
G1	Tilt Bracket - Right	1																				
G2	Tilt Bracket - Left	1																				
G3	M5 x 15mm Screw	4																				
G4	M6 x 15mm Screw	4																				
G5	M8 x 15mm Screw	4																				
G6	M6 Washer	4																				

INSTALLATION SAFETY INSTRUCTIONS



CAUTION: THIS MOUNT IS INTENDED FOR USE ONLY UP TO THE MAXIMUM WEIGHTS INDICATED. USE WITH DISPLAYS HEAVIER THAN THE MAXIMUM INDICATED MAY RESULT IN INSTABILITY OR FAILURE CAUSING POSSIBLE INJURY, DEATH OR DAMAGE TO EQUIPMENT.

Do not attempt to install this product until all instructions and warnings have been read and properly understood. If you have any questions regarding any of the instructions or warnings, please contact Atdec customer service.

Please keep this information for future reference.

Please check carefully to make sure there are no missing or defective parts - defective parts must never be used. Never operate this mounting system if it is damaged. Return the mounting system to a service centre for examination and repair.

Atdec, its distributors and dealers are not liable or responsible for damage or injury caused by improper installation, improper use or failure to observe these safety instructions. Use this mounting system only for its intended use as described in these instructions. Do not use attachments not recommended by the manufacturer.

In such cases, all guarantees will expire.

GENERAL

This product should only be installed by someone of good mechanical aptitude, who has experience with basic building construction, and fully understands these instructions. Atdec recommends that a professional AV installer or other suitably qualified person install this product. Great care must always be taken during installation as most AV equipment is of a fragile nature, possibly heavy and easily damaged if dropped. Always use an assistant or mechanical lifting device to safely lift and position equipment.

If you do not fully understand the instructions or are not sure how to install this product safely, then please consult a professional for advice and/or to install this product for you. Failure to mount this product correctly may cause serious injury or death both during installation and at any time thereafter.

Do not mount any AV equipment that exceeds the specific weight limit of the product you are installing.

PRODUCT LOCATION

Please pay careful attention to where this product is located. Check load capacity of wall prior to installation as some mounting surfaces (including walls, ceilings, horizontal surfaces) are not suitable for installation. Failure to provide adequate structural strength for this component can result in serious personal injury or damage to equipment! It is the installer's responsibility to make sure the structure to which this component is attached can support five times the combined weight of all equipment. Reinforce the structure as required before installing the component. Installing on drywall boards alone will not support the weight of most AV equipment. If you install this product on drywall it must be securely fixed to a wooden stud, concrete block or other permanent structure behind the drywall board.

Designed for indoor use, this mount is suitable for public or home installation. If located in a public or frequently

populated area ensure that the product is out of the immediate reach of people. If any AV equipment is to be suspended over the likely path or location of people then great care should be taken to secure all parts of the installation from falling.

When drilling holes in walls it is essential to avoid contact with electrical cables and water or gas pipes contained within. Use of a good quality live wire detector and hidden object locator is therefore recommended. Only drill into structures when you are sure it is safe to do so.

FIXING HARDWARE

The installer must be satisfied that any supplied fixing hardware is suitable for each specific installation. If any fixing screws or included hardware are deemed not sufficient for a safe installation then please consult a professional or your local hardware store.

It is highly recommended that all wall fixing screws be used where supplied and that the purpose of all other fixing hardware is fully understood. In some cases more AV equipment fixing hardware will be supplied to accommodate different models of equipment and set up configurations.

HAZARD LIMITATION

When routing cables take advantage of any built in cable management features that the product might provide and ensure that all cables are tidy and secure. Check to see that any moving aspect of product can do so unhindered by any cabling.

Some products have moving parts and the potential to cause injury through the crushing or trapping of fingers or other body parts.

Particular attention to the nature of moving parts is required especially when assembling, installing and adjusting during set up. Immediately after installations double-check that the work done is safe and secure. Double-check all necessary fixings are present and are of ample tightness.

Tighten screws so adaptor brackets are firmly attached. Do not tighten with excessive force. Overtightening can cause stress damage to screws, greatly reducing their holding power and possibly causing screw heads to become detached. Tighten to 4.5N/m or 40 in-lb maximum torque.

Correct length screws must be used. If screws don't get three complete turns in the screen inserts or if screws bottom out and bracket is still not tightly secured, damage may occur to screen or product may fail.

It is recommended that periodic inspections of the product and its fixing points are made to ensure that safety is maintained. If in doubt consult a professional AV installer or other suitably qualified person.

INSTALLATION INSTRUCTIONS

<p>1.</p>	<p>2.</p>	<p>3.</p>								
<p>4.</p>	<p>5. Position plate on pole and retighten screws from step 4</p>	<p>6. Fix safety screw</p>								
<p>7. Attach xx to xx first</p>	<p>8. Install ADB-RX symmetrically about junction of Rail segments</p> <table border="1"> <tr> <td>D1</td> <td>E1</td> </tr> <tr> <td>—</td> <td>—</td> </tr> <tr> <td>—</td> <td>—</td> </tr> <tr> <td>—</td> <td>—</td> </tr> </table>	D1	E1	—	—	—	—	—	—	<p>9. Attach brackets to screen with supplied screws and spacers (if required)</p>
D1	E1									
—	—									
—	—									
—	—									
<p>10. Tighten or loosen screw to raise or lower screen height, respectively</p>	<p>11. Tighten safety screw</p>	<p>12. Put screw into hole to set at required angular increment</p>								