

Wall Direct Monitor Mount

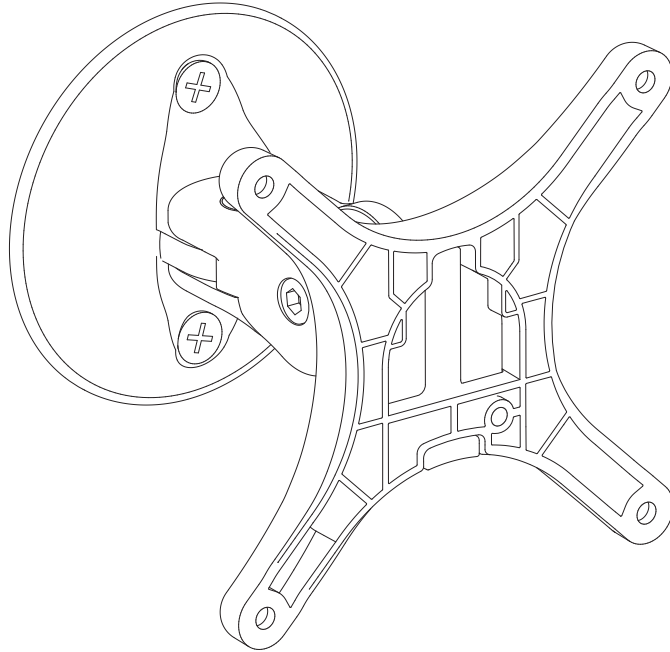

COMPONENT CHECKLIST

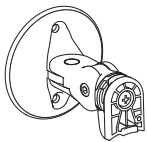

A
Wall direct
assembly
(x1)

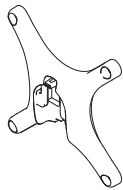

B
VESA
head
(x1)



C
5mm
Allen key
(x1)



D
Countersunk
Screw
M6 x 50mm
(x2)



E
Wall plug
(x2)



F
Security Screw
M4 x 16mm
(x1)



G
Mounting
screws
M4 x 10mm
(x4)



H
Mounting
screws
M4 x 12mm
(x4)



I
Mounting
screws
M4 x 16mm
(x4)

Wall

REQUIRED TOOLS

- Phillips Head Screwdriver
- Drill Bit
- Power Drill

WEIGHT RANGE

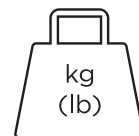

kg
(lb)

0 - 8kg
(0 - 17.6lbs)

IMPORTANT INFORMATION

! Please ensure this product is installed as per these installation instructions.

! This product is designed to support a flat panel monitor in a non interactive environment. i.e. It should not be used in a situation where the display's position will be frequently change.

! The manufacturer accepts no responsibility for incorrect installation.

1. Disassemble

1.1 Using the supplied allen key, remove the bottom screw

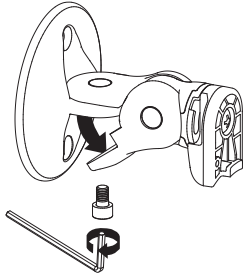

1.2 Separate the two components

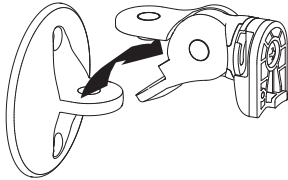

2. Attach base to wall

Masonry Wall

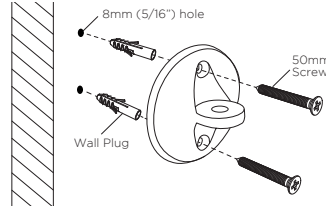

Tip: Use a spirit level to ensure this surface is horizontal

Timber stud wall

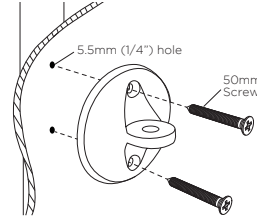

Tip: Use a spirit level to ensure this surface is horizontal

3. Re-assemble

3.1 Reassemble the wall direct assembly

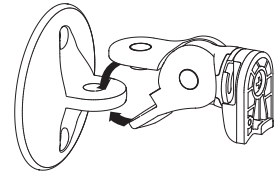

3.2 Close the two halves of the bracket around the base by firstly positioning the top half and then the bottom half

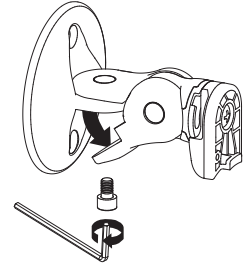

4. Install VESA monitor head

4.1 Install VESA monitor head as

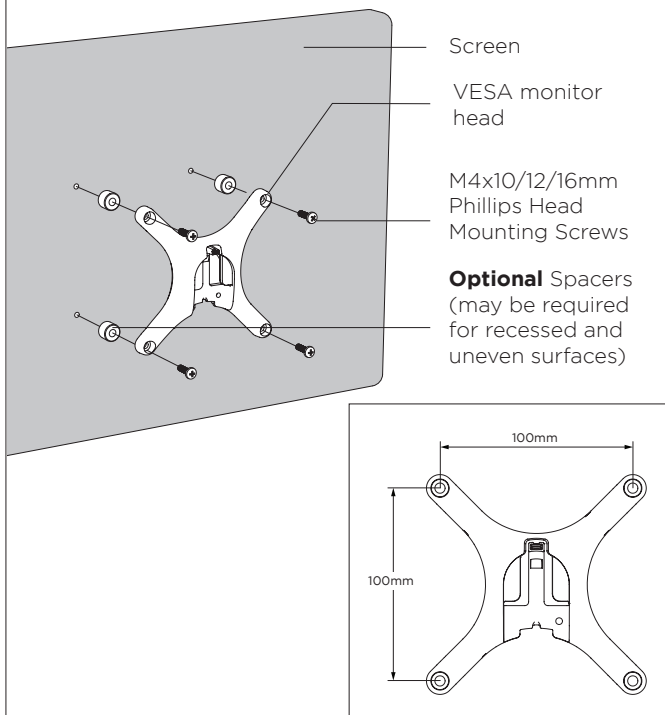

5. Mounting Monitor

5.1 Insert VESA monitor head into the receptacle in the Arm Assembly

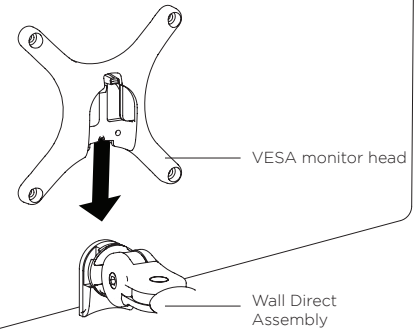

5.2 OPTIONAL SECURITY SCREW
Ensure the Monitor is supported, then loosen the Monitor head screw with the 5mm Allen Key and tilt screen up before installing the M4 x 16mm Security Screw into the Security Screw hole

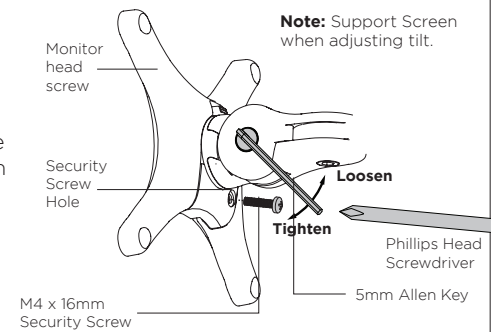

6. Adjusting the Display Bracket

Portrait/ Landscape

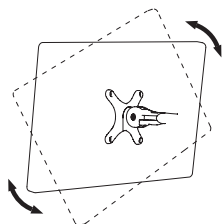

No Allen Key necessary

Tilt (Screen angle up/down)

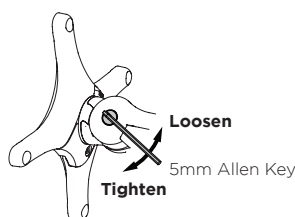

Note: Support Screen when adjusting tilt.

Pan (Screen angle left/right)

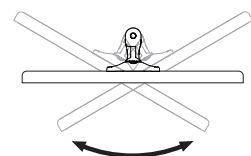

No Allen Key necessary

ATDEC

No portion of this document or any artwork contained herein should be reproduced in any way without the express written consent of Atdec Pty Ltd. Due to continuing product development, the manufacturer reserves the right to alter specifications without notice. ©20180228B

atdec.com | atdec.co.uk | atdec.com.au

Please Recycle ♻️

AF-WD Page 2 of 2