

COBY®



TF-DVD5050

Please read this manual before connection and use.



English

Important Safety Instruction

CAUTION: Use of controls or adjustments or performance of procedures other than those specified herein may result in hazardous radiation exposure.

Please study this manual carefully and always keep it available. There are, however, some installation and operation precautions which you should be aware of.

- (1). Read these instructions.
- (2). Keep these instructions.
- (3). Heed all warnings.
- (4). Follow all instructions.
- (5). Do not use this apparatus near water.
- (6). Clean only with dry cloth.
- (7). Do not block any ventilation openings-Maintain well ventilated conditions around the product. Do not put product on bed, sofa or anything that blocks ventilation. Install in accordance with the manufacturer's instructions.
- (8). Do not install near any heat sources such as radiators, heat registers, stoves, or other apparatus (including amplifiers) that produce heat.
- (9). Do not defeat the safety purpose of the polarized or grounding type plug. A polarized plug has two blades with one wider than the other. A grounding type plug has two blades and a third grounding prong. The wide blade or the third prong is provided for your safety. If the provided plug does not fit into your outlet, consult an electrician for replacement of the obsolete outlet.
- (10). Protect the power cord from being walked on or pinched particularly at plugs, convenience receptacles, and the point where they exit from the apparatus. Power supply cords should be routed so that they are not likely to be walked on or pinched by items placed upon or against them, paying particular attention to cords at plugs, convenience receptacles, and the point where they exit from the product.
- (11). Only use attachments or accessories specified by the manufacturer. Do not use attachments not recommended by the product manufacturer as they may cause hazards.
- (12). Refer all servicing to qualified service personnel. Servicing is required when the apparatus has been damaged in any way, such as power-supply cord or plug is damaged, liquid has been spilled or objects have fallen into the apparatus, the apparatus has been exposed to rain or moisture, does not operate normally, or has been dropped.
- (13). Unplug this apparatus during lightning storms or when unused for long periods of time. Unplug it from the wall outlet and disconnect the antenna or cable system. This will prevent damage to the product due to lightning and power line surges.
- (14). Power sources-this product should be operated only from the type of power source indicated on the marking label. If you are not sure of the type of power supply to your home, consult your product dealer or local power company. For products intended to operate from battery power, or other sources, refer to the operating instructions.
- (15). Overloading-do not overload wall outlets, extension cords, or integral convenience receptacles as this can result in a risk of fire or electric shock.

Safety Precautions



The lightning flash with arrowhead symbol within an equilateral triangle is intended to alert the user to the presence of uninsulated "dangerous voltage" within the product's enclosure that may be of sufficient magnitude to constitute risk of electric shock to persons.



The exclamation point within an equilateral triangle is intended to alert the user to the presence of important operating and maintenance (servicing) instructions in the literature accompanying the product.

WARNING: To reduce the risk of fire or electric shock, do not expose this appliance to rain or moisture. Dangerous high voltage is present inside the enclosure. Do not open the cabinet.

CAUTION: To prevent electric shock, match wide blade plug to wide slot, and fully insert.

CAUTION: This Digital Video Disc Player employs a laser System. To prevent direct exposure to the laser beam, do not try to open the enclosure. When open and the interlocks are defeated, visible laser radiation is present.

Use of controls or adjustments or performance of procedures other than those specified herein may result in hazardous radiation exposure. **DO NOT STARE INTO BEAM.**

FCC NOTICE: This equipment has been tested and found to comply with the limits for a Class B digital device. Pursuant with the FCC Rules, Part 15. These limits are designed to provide reasonable protection against harmful interference in a residential installation.

This equipment generates, uses and can radiate radio frequency energy and if not installed and used in accordance with the instruction may cause harmful interference to radio communication.

Table of Contents

IMPORTANT SAFETY INSTRUCTIONS SAFETY INFORMATION TABLE OF CONTENTS	Page
UNPACKING.....	1
NOTE ON DISC.....	2
VIEWS OF THE MAIN UNIT.....	3-4
VIEWS OF THE REMOTE CONTROL.....	5
CONNECTIONS(Connecting to a TV).....	6
CONNECTIONS(Connecting to an amplifier equipped with a Dolby Pro Logic Surround)	6
CONNECTIONS(Connecting to a HeadphonePower Connections (to AC Adapter)Power Connections (to DC Car Cord)	7
CONNECTIONS(Power Connections to Battery Pack).....	8
FUNCTION BUTTONS.....	9-14
SETUP MENU.....	15-17
CUSTOM SETUP.....	17
TROUBLE SHOOTING.....	18
SPECIFICATIONS.....	19

Unpacking

Please make sure the following items are included with your DVD player. If any items are missing, contact your dealer.

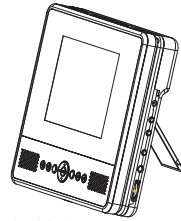

Main Unit



Battery



Remote Control

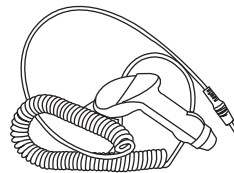

DC Car Cord

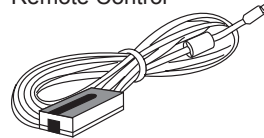

AC/DC Adapter

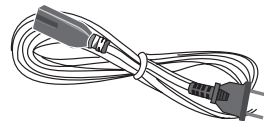

Power Cord

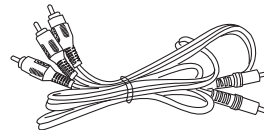

RCA Cable

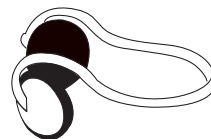

Headphones

.1.

Note on Disc

Disc Requirement

The DVD player can play back the following discs.

Disc mark	Contents	Disc size	Maximum playback time	
			133 min (SS-SL)	242 min (SS-DL)
DVD video discs	Audio+Video (moving picture)	12cm	266 min (DS-SL)	484 min (DS-DL)
CD	Audio	12cm/8cm	74min/20min	
MP3	Audio	12cm	600min	
JPEG	Still high resolution		600min	

In addition, this unit can play back a CD-R, or CD-RW that contains audio titles or MP3 files. You cannot playback discs other than those listed above. (CD-ROM, CD-Extra, CD-G, and CD-I discs can not be played on this DVD player.)

Care of Disc

Video disc contains high-density compressed data that needs proper handling.

Hold the disc with fingers. Hold the disc's outer edge and/or the center spindle hole. Do not touch the disc surface.



Do not bend or press the disc. Do not expose the disc to direct sunlight or heating sources.



Store discs in cabinet vertically, and in dry condition. Prevent exposure to :

- Direct sunlight
- Heat or exhaust from a heating device.
- Extreme humidity.

Clean the disc surface with a soft, dry cleaning cloth. Wipe the disc surface gently and radially from center toward the outer edge. Do not apply thinner, alcohol, chemical solvent, or sprays when cleaning. Such cleaning fluids will permanently damage the disc surface.

.2.

Views of the Main Unit

Left /Top/Right View

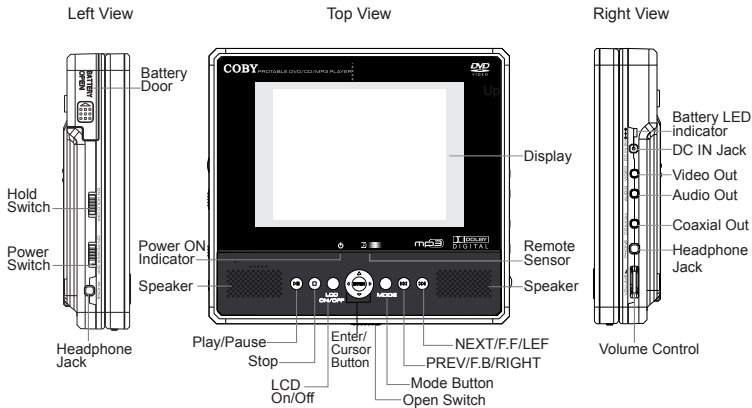

Video Out -- Connect to external TV screen by the supplied RCA cables.

Audio Out -- Connect to external speaker system by the supplied RCA cables

Coaxial Out -- Connect to external speaker system by the coaxial cable (not supplied).

Headphone Jack -- connect to the supplied headphone. As the headphone is plugged in, the speakers' output will be OFF.

Volume Control -- Adjust to the desired volume level.

MODE

Press MODE button once to enter setup menu. Refer to "setup menu" section for detail.

Press it twice, below picture appears :

Press the left/right direction button to adjust contrast ratio.

Press it the third time, below picture appears :

Press the left/right direction button to adjust Brightness

Press it for the fourth time, below picture appears :

Press the left/right direction button to adjust color saturation

LCD On/Off

Press to turn on/off the LCD display

Speaker

Two speakers produce stereo sound.

Power Switch

Press to turn on/off the unit.

Hold Switch

Prevent any unwanted function changes in PLAY or STOP mode

Remote Sensor

Receiving remote control signal for operation.

Display

Present high-resolution pictures.

DC 9V IN

Connect to the supplied AC Adapter/DC Car Cord for power supply.

Battery LED Indicator

It lights red when charging the battery. It lights green when the battery is fully charged.

Views of the Main Unit

Bottom View

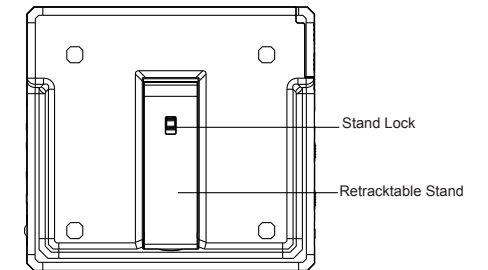

Using Stand

- Lift up the stand from its groove.
- Erect the unit by supporting it against the stand.
- A slopewise viewing position is realized.

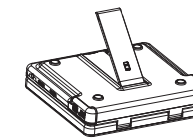

(a)

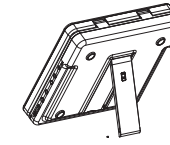

(b)

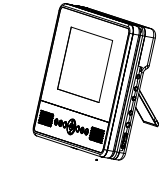

(c)

Stand is such a retractable support that you can get different extent of deviation by adjusting it.

- Push the lock button upward to release the stand.
- Draw the stand out and then fix it in position by clicking down the lock button.
- Stand up the unit.

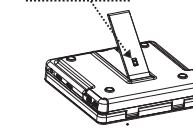

(a)

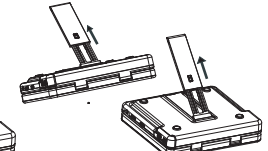

(b)

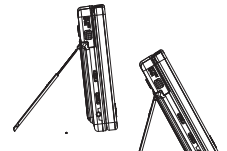

(c)

.4.

Views of the Remote Control

Remote Control

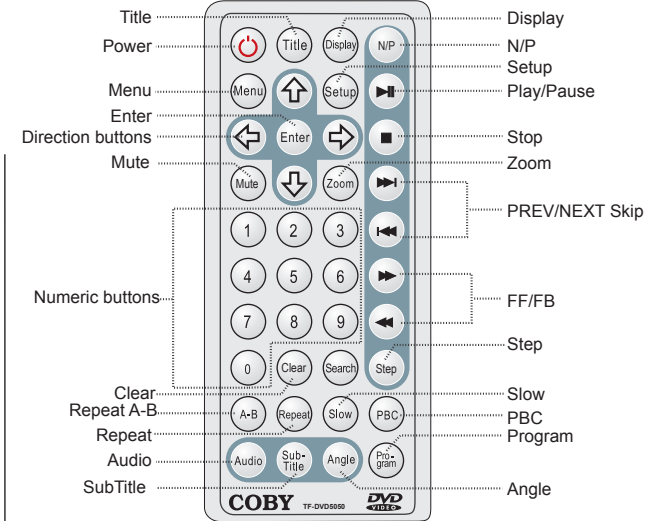

NOTE The buttons of same descriptions on the main unit/remote control are of same functions.

Battery Installation

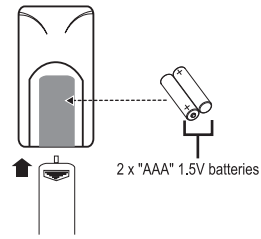

2 x "AAA" 1.5V batteries

WARNING:

- The battery used in this device may present a fire or chemical burn hazard if mistreated.
- Do not recharge, disassemble, incinerate, or heat the batteries about 1000C (2120F).
- Use of another battery may present a risk of fire or explosion. Dispose of used batteries.
- Do not dispose of fire.
- Keep batteries out of children's reach.

.5.

Connections

Connecting to a TV set

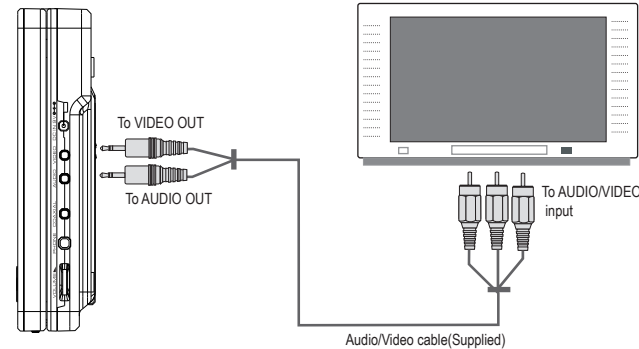

NOTE:

- Refer to the owner's manual of your TV as well.
- Before connecting the DVD player to a TV set, be sure to turn the power off and unplug both units from the wall outlet.

Connecting to an amplifier equipped with a Dolby Pro Logic Surround

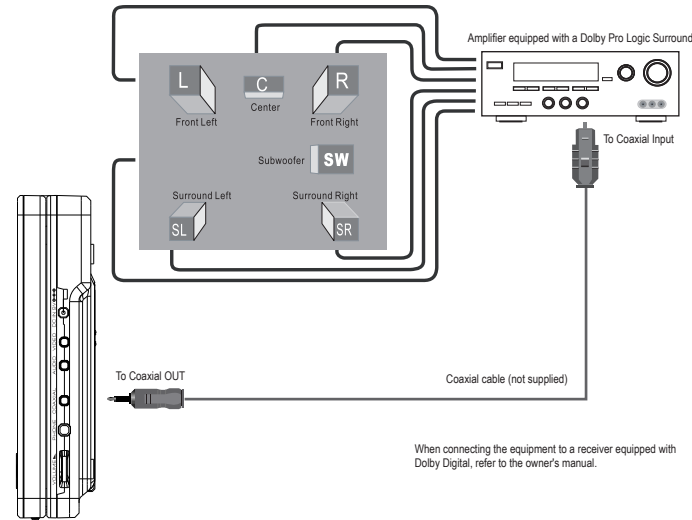

When connecting the equipment to a receiver equipped with Dolby Digital, refer to the owner's manual.

.6.

Connections

Connecting to a Headphone

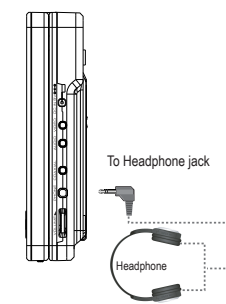

Be sure that your unit is at low volume level before connecting the headphone. Increase the volume gradually for your comfortable listening.

CAUTION:

Hearing experts advise against the constant use of personal stereos played at high volume. Constant high volume use can lead to hearing loss. If you experience ringing in the ears or hearing loss, discontinue use and seek medical advise.

Power Connections (to AC Adapter)

**Do not connect the power cord until all other connections have been made.

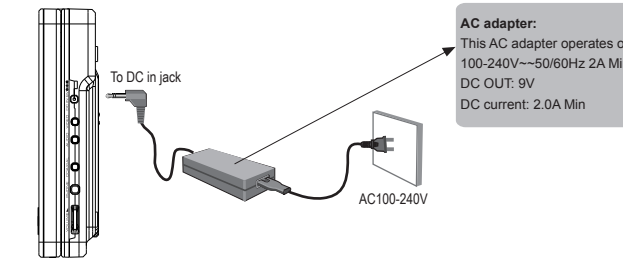

AC adapter:
This AC adapter operates on 100-240V~50/60Hz 2A Min
DC OUT: 9V
DC current: 2.0A Min

Power is supplied through the provided appropriate power adapter, one end of which is connected to the DC IN jack on the main unit, another to wall outlet with AC100-240V.

Note:

- If you have difficulty inserting the plug, turn it over and reinsert it.
- If the unit will not be in use for long periods of time, disconnect the plug from the outlet.
- In order to prolong the operation life, the intervals of continuous power on should be not less than 30s.

Power Connections (to DC Car Cord)



Plug the DC Car Cord to the DC in Jack for power supply.

Note:

- Please do not plug it to the battery recharge jack.
- The DC Car Cord is only for in car use.

.7.

Connections

Power Connections (to Battery Pack)

Insert Battery

For initial use, we recommend it be charged for at least 4 hours.

- Push the battery door to arrow direction to open it
- insert the battery and then close the door by hand.

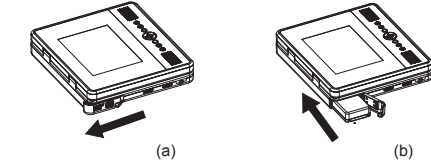

Charge Battery

To charge the battery, just leave it in its compartment and then power on the unit by AC adaptor. Battery LED indicator lights red while battery is under charging and it will turn to green after the battery is fully charged.

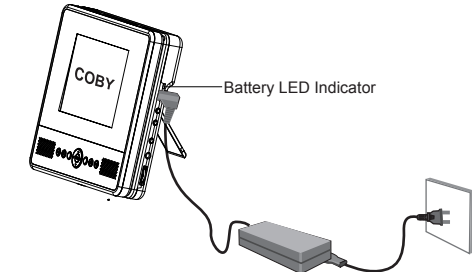

Note:

The battery can be recharged about 300 times without obvious performance drop. The unit will not operate on battery power when the AC power cord is plugged into the AC socket.

Low Battery Detection: The unit will stop automatically and turn to STANDBY mode when voltage reaches too low.

.8.

Function Buttons

Basic Playback

1. Switch on the player

Make sure all the necessary connections are properly done and then set the POWER switch to ON position to turn the unit on.

The coby logo picture appears after 2-3 seconds turning on the unit.

(If close the cover during playback, the LCD display will be off for power saving).

2. Load a disc

- 1) Push the OPEN button to arrow direction to open the disc compartment .
- 2) Insert a disc with the label facing up.
- 3) Close the compartment door by hand.

■ If the single side disc is placed upside-down, "NO DISC" or "BAD DISC" will appear on the TV screen.

■ The DVD player will stop automatically at the end of playback and show the menu picture.

3. Start playback

Press the PLAY or ENTER button to start playing. (Some discs may play automatically).

If a DVD disc menu appears on screen, press the PLAY button to start playing.



Press the DIRECTION buttons to select the desired feature in the menu.

Press ENTER button to confirm a selection in the menu.

4. Adjust the volume

Turn the volume control on main unit to the desired volume level.

5. To stop playing, press the Stop button.

6. To Skip Forward/Skip Backward, press the PREV/NEXT button.

7. To Fast Forward/Fast Backward, press and hold the PREV/NEXT button for about two seconds.

Problem disc messages

The following message will be displayed on screen when there is a format problem with loaded disc:

"WRONG REGIONAL DISC"

Region code of the disc is not matching to that of the player's (region 1 to region 6)

"WRONG PASSWORD"

The rating level of the disc is higher than the rating level setting of the player.

The player will not play the disc.

"WRONG DISC"

The player is equipped with automatic disc quality detection software. When the player detects a problem or damaged disc, the unit may play the disc at a lower quality or stop completely, depending on the damaged level of the disc.

Production quality of DVD discs varies. Some discs may deviate from the industry standard. Some incorrectly formatted discs may be played. However, the playback quality may be substandard.

POWER management

If the player will not be used for a long period of time, unplug the player for safety.

Function Buttons

N/P



Press the N/P button to select the TV system from NTSC/PAL/AUTO.

Display



Press the Display button to show the time and status information.

Press Display button the third time to quit the display mode.

Play/Pause/Stop



Press the Play button for the first time to play the disc.

Press the button for the second time to pause playing. (Still picture).

Press again to resume playback.



Press the Stop button once, to stop playback. Press the Play button to resume. Disc will begin playing from where it was stopped.

Press the Stop button twice, to stop playback. Press the Play button to resume. Disc will begin playing from the beginning.

Skip Forward/Backward



Press the button to skip advance DVD chapter or CD track



Press the button to skip backward DVD chapter or CD track.



NOTE: Player will not skip forward or backward during "WARNING" section of a DVD disc.

Single chapter DVD or single track CD cannot be skipped.

Fast Forward/Backward



Press the button to fast forward through the disc. Repeatedly pressing the button will increase the search speed.



Press the button to fast backward through the disc. Repeatedly pressing the button will increase the search speed.

Play → X2 → X4 → X8 → X16 → X32

Press PLAY to resume normal playback.

NOTE: The player is muted during fast forward or fast backward except under the MP3 and CD mode.

The player will not fast forward or fast backward during WARNING section of a DVD disc.

Function Buttons

Slow



Press SLOW button to play at slow motion. Repeatedly pressing the button will decrease the slow speed.

Play → X1/2 → X1/4 → X1/8 → X1/16 → X1/32

NOTE: The player is muted at SLOW mode.

Disc MENU/TITLE



While playing a DVD, press the MENU button to return to the DVD disc start menu.



While playing a DVD, press the TITLE button to return to the title menu.

NOTE: Some DVD discs do not allow the TITLE function.

Select an item in the menu

In the DVD disc start menu or in the Set Up menu



Press the DIRECTION buttons to highlight function icons.

Press the ENTER button to confirm a selection.

Numeric Key Pad

(Random Program access)



1.) To directly access a DVD Chapter or a CD track, input the desired DVD Chapter or CD Track number using the numeric key pad. Then press the ENTER button to confirm.

2.) Input data for the DVD disc start menu or the player's setup menu.

NOTE: Some DVD discs do not allow direct access function.

MUTE



Press the MUTE button to select mute on or mute off.

ZOOM



PLAYING DVD

Press the ZOOM button repeatedly and the TV screen will display

ZOOMx2 → ZOOMx4 → ZOOMx1

Press the Direction buttons to move the picture position.

PLAYING JPEG

Press the ZOOM button repeatedly and the TV screen will display:

25% → 50% → 100% → 150% → 200%

While at 100%, press the direction button to rotate the picture.

While at 150% or 200%, press the direction button to move the picture position.

NOTE: The picture quality decreases as the picture size increases.

Function Buttons

Repeat Section A-B

To repeat a specific section of a disc.

Press the A-B button at the starting point of the desired section, "Repeat A" appears on screen.

Press the A-B button again at the end of the desired section, "Repeat A-B" appears on screen.

The player will start repeating playback the selected section from A to B until the function is cancelled.

To cancel the function, press the A-B button once more to return to normal playback. "Off" will appear on screen for few seconds.

NOTE: Some DVD discs do not allow the A-B function playback. This function does not apply to MP3 discs.

REPEAT

This function allows repeated playback of a Title, Chapter, Track or Disc.

Press REPEAT button repeatedly to select the repeat mode.

Playing DVD

Chapter → Title → Disc → Off

↑

Playing CD

Track → Disc → Off

↑

Playing MP3

Track → Folder → Disc → Off

↑

NOTE: Some DVD discs do not allow the REPEAT function.

STEP

Press STEP during playback, one frame of the image is played each time you press the button.

Press the Play button to quit the STEP mode.

AUDIO

For DVD playback:

While playing a DVD disc that contains multiple languages, press the AUDIO button repeatedly

to select the desired language of the audio sound track.

A DVD disc may contain up to 8 selectable audio languages.

The default AUDIO setting is English.

For CD/MP3 playback:

Press the AUDIO button repeatedly to shift among R/R, L/R, and L/L.

The default AUDIO setting is L/R.

NOTE:

- If the desired language is not selected even after pressing the button several times, it means that the language is not available on the disc.
- When the power is turned on or the disc is removed, the language heard is the one selected at the initial settings.

Function Buttons

Subtitle

While playing a DVD disc that contains multiple subtitles, press the SUBTITLE button repeatedly to select the desired language of the viewable subtitle. A DVD disc may contain up to 32 selectable subtitles.

The default SUBTITLE language is ENGLISH.

NOTE:

- In some cases, the subtitle language is not changed to the selected one immediately.
- When a disc supporting the closed caption is played, the subtitle and the closed caption may overlap each other on the TV screen. In this case, turn the subtitle OFF.
- When the desired language is not selected even after pressing the button several times, it means that the language is not available on the disc.

CLEAR

Press the Clear button to cancel the incorrect input in DVD program.



SEARCH

Go to a desired section. (A desired Title, Chapter, Time)

Playing DVD

Search by Title/Chapter

a). Press the SEARCH button once, below picture appears:



- b). Press the LEFT/RIGHT direction button to highlight the entry.
c). Input the desired title/chapter by numeric keys.
d). Press the ENTER button to execute search.
f). To exit, press SEARCH again.

Search by Time

a). Press the SEARCH button twice, below picture appears:

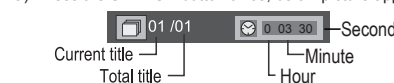

- b). Input Second, Minute and Hour information by the numeric keys
c). Press the ENTER button to execute the search.
d). To cancel the incorrect information you have input, press the Clear button.
e). To exit, press SEARCH again.

Playing CD

Search by Time

a). Press the SEARCH button once, below picture appears:



- b). Input Second, Minute and Hour information by the numeric keypad.
c). To cancel the incorrect input, press the Clear button. To execute the search, press ENTER.
d). To exit, press SEARCH again.

Function Buttons

Program

To play a disc in a desired sequence.

NOTE: The Program function is available just as the player is in Navigate Off mode. Press the PBC button to set Navigate Off.



Press the Program button to enter the program menu.

In DVD mode

- When the Program menu appears, move the cursor to highlight the title column by LEFT/RIGHT button, select the Title by UP/DOWN button and press ENTER. Or input the title number by the numeric keypad.
- Move the cursor to highlight the chapter column by LEFT/RIGHT button, select the Chapter by UP/DOWN button and press ENTER. Or input the chapter number by the numeric keypad.
- Repeat step a to b to set up to 20 titles for the programming playback.
- Press PLAY to start playing the programmed titles.

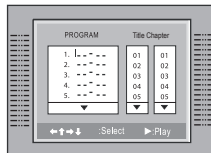

In CD mode

- When the Program menu appears, move the cursor to highlight the column by LEFT/RIGHT button, select the Track by UP/DOWN button and press ENTER.
- Repeat Step a to set up to 20 tracks for the programming playback.
- Press PLAY to start playing the programmed tracks.

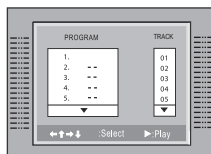

In MP3 mode

- When the Program menu appears, Press the ▲ ▼ button to select the folder, use the ENTER button to confirm.
- Highlight the desired track by the ▲ ▼ button, and press the RIGHT button to select it. (The tracks to be programmed playback can be in different folders. Press the LEFT button to return to the folder menu).
- Repeat Step a to b to select the tracks you wish to play.
- Press PLAY to start playing the programmed tracks.

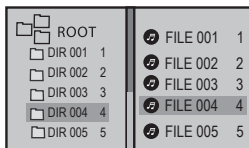

For your reference:

- To cancel the incorrect input information, press the Clear button. For MP3 mode, press right direction button twice to cancel unwanted selection.
- Press Program again to quit the program menu.
- Under program playing, press the Program twice to resume normal playback.

NOTE: Some discs do not allow program setting.

SETUP

Press the SETUP button to enter the player's setup menu. The SETUP menu allows the viewer to adjust the setting details of the DVD player. Please read the "Setup Menu" of the manual for further directions on how to use the SETUP menu.



Setup Menu

Various features of the DVD player can be adjusted in the Setup Menu.

- Press the SETUP button. Then the SETUP menu appears on screen.
- Press the UP/DOWN button to highlight the desired Sub-menu.
- Press ENTER to confirm your selection.
- Press the LEFT button to return to upper menu level.
- To exit from the setup menu, press SETUP once more. Or press UP/DOWN to select the EXIT menu.



NOTE:

Make sure your player is in STOP mode before setting the SETUP menu, otherwise some setup features will be unavailable.

--Language Setup--

Press the UP/DOWN button to highlight the desired item from OSD/Menu/Audio/Subtitle, and press ENTER to confirm.

Item	Instruction	Default setting
OSD	To select the language of the OSD by the UP/DOWN button, and press ENTER to confirm. There are four options: English, French, German, Spanish.	English
Menu	To select the language of the Menu by the UP/DOWN button, and press ENTER to confirm.	English
Audio	To select the language of the audio sound track by the UP/DOWN button, and press ENTER to confirm.	English
Subtitle	Select the language of the subtitle by the UP/DOWN button and press ENTER to confirm. When OFF is selected, the subtitle will not be displayed.	English

--Screen Setup--

Press the UP/DOWN button to highlight the desired item from TV Type/Screen Saver/TV System/Brightness/ Contrast, and press ENTER to confirm.

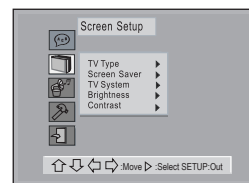

1. TV Type

Press the UP/DOWN button to select the aspect ratio from 4:3 PS (Pan Scan); 4:3 LB (Letter Box); 16:9 (Wide Screen). And press ENTER to confirm.

4:3 LB (Letter Box): This is selected when the unit is connected to a normal TV. Wide-screen images are shown on screen, with black belt on the top and bottom.

4:3 PS (Pan Scan): This is selected when the unit is connected to a normal TV. Wide-screen images are shown on screen, with some parts cut automatically.

Setup Menu

16:9 (Wide Screen): This is selected when the unit is connected to a wide-screen TV.

The default setting is 4:3 LB

NOTE: Certain DVD discs are formatted in wide screen (16:9) or letter box (4:3) only. Adjusting the setting of the disc player will not change the screen size for these "Format-only" discs.

2. Screen Saver

Press the UP/DOWN button to shift between Screen Saver ON and OFF. And press ENTER to confirm.

The default setting is On.

The screen saver is useful to prevent your display from becoming damaged.

If the Screen Saver is set ON, the screen saver picture appears when you leave the DVD player in stop mode for about a few minutes. Press any button on main unit or remote control to exit from the screen saver.

Automatic power off function

After the screen saver has been engaged for about a few minutes, the DVD player will automatically turn itself off, except during CD playback.

3. TV System

Press the UP/DOWN button to select the TV System from NTSC/PAL/AUTO, and press ENTER to confirm. *The default setting is NTSC.* (The TV System for north America is NTSC. Auto should only be used if you have a Multi-System TV.)

4. Brightness

Press the UP/DOWN button to select your satisfied brightness effect from Normal/Bright/Soft. And press ENTER to confirm.

The default setting is Normal.

5. Contrast

Press the UP/DOWN button to select your satisfied contrast ratio from -4, -3, -2, -1, 0, 1, 2, 3 and 4. And press ENTER to confirm.

The default setting is 0.

--Audio Setup--

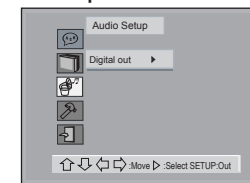

a. When the Digital Out is highlighted, press ENTER to confirm.

b. Press UP/DOWN to select Digital Off from SPDIF/PCM, SPDIF/RAW, and OFF. And press ENTER to confirm.

The default setting is SPDIF/RAW.

NOTE: When Digital Out is NOT in use, it is recommended to turn OFF the digital output setting, for the purpose of minimizing the circuit interference.

SPDIF/RAW: When this item is selected, all digital coaxial and optical outputs are turned on and are able to output a Dolby Digital signal.

Setup Menu

NOTE: In order to output a Dolby Digital signal, the amplifier or external device that the unit is hooked up to must have Dolby Digital, DTS and MPEG decoding.

SPDIF/PCM: Select this item when the DVD player is connected with a 2-channel digital stereo amplifier. When a Dolby Digital or MPEG disc is played, the digital port will output in PCM 2-channel format.

OFF: When this item is selected, all digital coaxial and optical outputs are turned off.

--Custom Setup--

Press the UP/DOWN button to highlight the desired Custom item (Parental Ctrl, Password, Angle Mark, Default), and press ENTER to confirm.

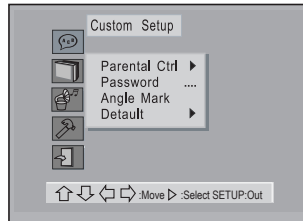

A). Parental Ctrl

There are eight levels of Parental Control. Level one opens discs to people of all ages. Level eight is suitable only for adults.

To change the parental control setting, a 4-digit code is required to be input first. (The default code is 8888.) When the input code is confirmed, the level setting menu will appear. Select the appropriate level by the UP/DOWN button, and press ENTER to confirm.

B). Password

Move the cursor to the PASSWORD prompt and press ENTER. Input the password 8888 if it is the first use. After confirmation, you will be required to input a new 4-digit code, and verify again.

WARNING:

- Please keep a copy of the new password in a safe place. Otherwise, you will not be able to change the Parental Control.
- Please remember your password, as the DEFAULT setting will revert everything BUT the PASSWORD and Parental Control to the factory defaults.

C). Angle Mark

Choose between ON and OFF.

The default setting is **ON**.

When the Angle Mark function is ON, an icon will be displayed on screen if the disc has multiple angle shots available for viewing.

Press ANGLE on the remote control to enjoy these scenes.

D). Default

This function allows you to change the player back to the factory default settings. All settings will be changed back to the original settings except the Password and Parental Control.

Trouble Shooting

Should your DVD player develop a problem, please check below before requesting service:

Symptom	Check and Action
No power	<ol style="list-style-type: none"> 1. Make sure the unit has been powered on manually. 2. Check if the power cord has been properly connected to the power outlet. 3. Make sure the battery pack is fully charged.
Does not play	<ol style="list-style-type: none"> 1. No disc, load a disc. 2. Disc has been loaded upside down. Place the disc with the label side up. 3. Disc's rating level is higher than the player's setting. 4. Disc is incorrect type for the player. 5. Disc is damaged or dirty. Clean the disc or try another one. 6. Moisture may be condensed inside the player. Remove the disc and leave the unit power on for one or two hours.
No Picture	<ol style="list-style-type: none"> 1. Check if the TV set has been powered on. Use TV remote to select AV signal for DVD rather than broadcast. 2. Check if the system connection is proper and secure. 3. Check if the connection cables are damaged. 4. Clean the disc.
Picture noisy/ distorted	<ol style="list-style-type: none"> 1. Disc is damaged or dirty. Clean the disc or try another one. 2. Reset the color system of the TV set. 3. Make sure the DVD player is not connected through a VCR, cable or satellite dish.
No sound or sound output not complete	<ol style="list-style-type: none"> 1. Check if the TV and amplifier have been switched on and correctly set. 2. Check if the TV and amplifier system connections are secured. 3. Press AUDIO button to select other audio tracks of the disc. 4. Check if the MUTE function of the TV or amplifier has been activated. 5. There will be no sound output during REVERSE PLAY/PAUSE/SLOW and SEARCH.
Remote control does not work	<ol style="list-style-type: none"> 1. Make sure the POWER button on the unit has been turned on manually. 2. Remove the obstacles between the remote control and the player. 3. Point the remote control towards the remote sensor on the player. 4. Check if the batteries of the remote control have been loaded with correct polarities. 5. Replace the batteries of the remote control.
Malfunction	Should the player develop a malfunction, unplug the player for 30 minutes. After that, power on the player and the restore function should reset the player.

Specification

Power supply	DC 9.0V 2A (AC adapter TERMINAL)
Power consumption	<=9w
Signal system	NTSC
Video output	1±0.2V (p-p), 75ohm, Negative sync., 3.5 mm mini jack x1
Audio output	1.5 Vrms (1 KHz, 0dB), 3.5 mm mini jack x1
Coaxial Output	3.5mm mini jack x 1
Earphone terminal	3.5mm stereo mini jack x1
Signal /Noise ratio(audio)	90dB typical
Dynamic range(audio)	90dB typical
Panel size	5 inch (4:3)
Resolution	320(H) x 240 (V) (QVGA) Pixels
Laser	Wavelength 650 nm
Operating conditions	Temperature: 0 c to 35 c. Operation status : Horizontal
Dimensions	165x152x50mm (Main Unit & Batt.)
Weight	887.5g (Main Unit & Batt.)