

A solid green vertical bar is located on the left side of the page, extending from the top of the main title area down to the model numbers.

Single/Dual View Secure KVM Switch User Manual

2/4/8-Port USB DVI/HDMI/DisplayPort

GCS1212TAA3 – GCS1214TAA3 – GCS1218TAA3 – GCS1222TAA3 – GCS1224TAA3 – GCS1228TAA3
GCS1312TAA3 – GCS1314TAA3 – GCS1318TAA3 – GCS1322TAA3 – GCS1324TAA3 – GCS1328TAA3
GCS1412TAA3 – GCS1414TAA3 – GCS1418TAA3 – GCS1422TAA3 – GCS1424TAA3 – GCS1428TAA3

www.iogear.com

©2018 IOGEAR® All rights reserved. Specifications subject to change without notice

Manual Version: v1.02

Manual Date: 2017-10-24

Table of Contents

FCC Information	4
User Notice	5
Package Content	6
About This Manual	7
Chapter 1 - Introduction	8
Features	9
Requirements	10
Operating Systems	11
Overview	12
Chapter 2 - Hardware Setup	16
Chapter 3 - Operation	22
Appendix	25
Specification	
DisplayPort Single View Secure KVM	26
DisplayPort Dual View Secure KVM	27
HDMI Single View Secure KVM	28
HDMI Dual View Secure KVM	29
DVI Single View Secure KVM	30
DVI Dual View Secure KVM	31
Limited Warranty	32

FCC Information

FEDERAL COMMUNICATIONS COMMISSION INTERFERENCE STATEMENT: This equipment has been tested and found to comply with the limits for a Class B digital service, pursuant to Part 15 of the FCC Rules. These limits are designed to provide reasonable protection against harmful interference in a residential installation. Any changes or modifications made to this equipment may void the user's authority to operate this equipment. This equipment generates, uses, and can radiate radio frequency energy. If not installed and used in accordance with the instructions, may cause harmful interference to radio communications. However, there is no guarantee that interference will not occur in a particular installation. If this equipment does cause harmful interference to radio or television reception, which can be determined by turning the equipment off and on, the user is encouraged to try to connect the interference by one or more of the following measure:

- Reorient or relocate the receiving antenna
- Increase the separation between the equipment and receiver
- Connect the equipment into an outlet on a circuit different from that to which the receiver is connected
- Consult the dealer or an experienced radio / TV technician for help

FCC Caution: Any changes or modifications not expressly approved by the party responsible for compliance could void the user's authority to operate this equipment.

This device complies with Part 15 of the FCC Rules. Operation is subject to the following two conditions:

1. this device may not cause harmful interference, and
2. this device must accept any interference received, including interference that may cause undesired operation

RoHS

This product is RoHS compliant.



User Notice

User Information

All information, documentation, and specifications contained in this manual are subject to change without prior notification by the manufacturer. The manufacturer makes no representations or warranties, either expressed or implied, with respect to the contents hereof and specifically disclaims any warranties as to merchantability or fitness for any particular purpose. Any of the manufacturer's software described in this manual is sold or licensed as is. Should the programs prove defective following their purchase, the buyer (and not the manufacturer, its distributor, or its dealer) assumes the entire cost of all necessary servicing, repair and any incidental or consequential damages resulting from any defect in the software.

The manufacturer of this system is not responsible for any radio and / or TV interference caused by unauthorized modifications to this device. It is the responsibility of the user to correct such interference.

The manufacturer is not responsible for any damage incurred in the operation of this system if the correct operational voltage setting was not selected prior to operation. PLEASE VERIFY THAT THE VOLTAGE SETTING IS CORRECT BEFORE USE.

Warranty Information

This product carries a 4 Year Limited Warranty. For the terms and conditions of this warranty, please go to <http://www.iogear.com/support/warranty>

Online Registration

Please make sure to register your product online at <https://www.iogear.com/registration>

Contact

Please contact our support team for any assistance
GovSupport@iogear.com

Package Content

IOGEAR Secure KVM package consists of:

- 1 x IOGEAR Secure KVM Switch
- 1 x Power Cord
- 1 x User Manual*

Please check to make sure that all of the components are present and are in good order. Please contact your dealer if anything was missing or damaged in shipping. Please read this manual thoroughly and follow the installation and operation procedures carefully to prevent any damage to the switch or to any other devices on IOGEAR Secure KVM installation.

*Please visit our website to download the most up-to-date version of the manual

ATTENTION

If the tamper-evident seals are missing or peeled, avoid using the product and contact your IOGEAR dealer.

If all front panel LEDs (except for Power LED) flash continuously or the switch's enclosure appears to be breached, avoid using this product and contact your IOGEAR dealer.

This Secure KVM Switch is equipped with active always-on chassis intrusion detection security. Any attempt to open the enclosure will permanently damage, disable the switch, and void the warranty.

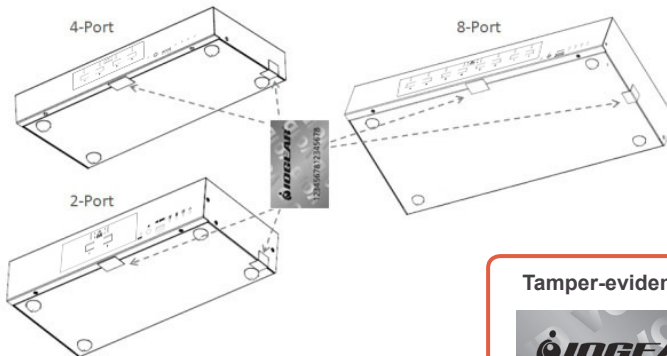

Tamper-evident seal



About This Manual

This User Manual is intended for System Administrators and end users

Please read this user manual thoroughly to help you get the most from your IOGEAR Secure KVM Switch system. This manual covers all aspects of installation, configuration, and operation. An overview of the information found in the manual is provided below.

This User Manual covers the following IOGEAR Secure KVM

Configuration			2-Port	4-Port	8-Port
PC Video Connection	Console Video Connection	Number of Displays			
DisplayPort	HDMI	Single	GCS1412TAA3	GCS1414TAA3	GCS1418TAA3
		Dual	GCS1422TAA3	GCS1424TAA3	GCS1428TAA3
HDMI	HDMI	Single	GCS1312TAA3	GCS1314TAA3	GCS1318TAA3
		Dual	GCS1322TAA3	GCS1324TAA3	GCS1328TAA3
DVI	DVI	Single	GCS1212TAA3	GCS1214TAA3	GCS1218TAA3
		Dual	GCS1222TAA3	GCS1224TAA3	GCS1228TAA3

Conventions

This manual uses the following conventions:

Monospaced	Indicates text that you should key in
[]	Indicates keys you should press. For example, [Enter] means to press the Enter key. If keys need to be pressed together, they appear together in the same bracket with a plus sign between them: [Ctrl+Alt]
1.	Numbered lists represent procedures with sequential steps.
◆	Bullet lists provide information, but do not involve sequential steps.
→	Indicates selecting the option (on a menu or dialog box, for example), that comes next. For example, Start → Run means to open the Start menu, and then select Run.
	Indicates critical information

Product Information

For information about all IOGEAR products and how they can help you connect without limits, visit IOGEAR on the Web or contact an IOGEAR Authorized Reseller. Visit IOGEAR on the Web for a list of locations and telephone numbers:

www.IOGEAR.com

Chapter 1 - Introduction

The IOGEAR Secure KVM Switch series is NIAP-certified and compliant with NIAP PP 3.0 (Protection Profile for Peripheral Sharing Switch version 3.0) requirements, satisfying the latest security requisites set by the U.S. Department of Defense for peripheral sharing switches. Compliance ensures maximum information security while sharing a single set of HID's (keyboards, mice, speakers, and CAC Readers) between multiple computers. Conformity with Protection Profile v3.0 certifies that only a keyboard and a mouse are accommodated, other USB peripherals cannot be connected to the console ports of the Secure KVM; therefore, providing high-level security, protection and data safekeeping.

The IOGEAR Secure KVM Switch provides the utmost hardware and software security when switching port focus. Hardware security includes tamper-evident tapes, chassis intrusion detection, and tamper-proof hardware. Software security includes restricted USB connectivity, meaning non-HID's (Human Interface Devices) are ignored when switching. This security includes channel isolation per port and automatic clearing of the keyboard and mouse buffer when switching port focus, making it impossible for data to be leaked or transferred between secure and unsecure computers.

By combining physical security with controlled USB connectivity and controlled unidirectional data flow from devices to connected computers only, the IOGEAR Secure KVM Switch series offers the means to consolidate multiple workstations of various security classification levels with one keyboard, one video monitor, and one mouse (KVM) console.

Administrative Functions

To be compliant with Protection Profile 3.0 while providing higher deployment flexibility, wider product support for new authentication devices, and maximum security, the IOGEAR Secure KVM Switch offers Port Authentication Utility. IOGEAR Port Authentication Utility allows authorized administrators to configure IOGEAR Secure KVM Switch to either accept or reject specific USB devices. Through a secured access and authentication process, authorized administrators can perform configurable device filtering through the Port Authentication Utility.

Note:

1. The National Information Assurance Partnership (NIAP) is a United States government initiative to meet the security testing needs of IT consumers and manufacturers. NIAP is operated by the National Security Agency (NSA) and the National Institute of Standards and Technology (NIST).
2. IOGEAR Secure KVM Switch series additionally satisfied Protection Profile version 3.0 for Peripheral Sharing Switch (PSS).

Features

Features	Benefits
2/4/8-Port USB DVI/HDMI/DisplayPort Single/Dual View Secure KVM Switch	Reduces the costs involved in controlling up to 8 Single/Dual View computers while offering data isolation between shared peripherals and computers
Superior ultra-high video resolution- up to 4K UHD (3840 x 2160 @30Hz)*	Supports resolution up to 3840 x 2160@30Hz* with crystal clear image quality
Video DynaSync™ – exclusive IOGEAR technology	IOGEAR Video DynaSync™ eliminates boot-up display problems and optimizes resolution when switching between ports
DisplayPort AUX channel filtering (DisplayPort Secure KVM Switch only)	Non-qualified auxiliary channel traffic such as MCCS and EDID write are rejected.
NIAP PP PSS v3.0 certified	Provides the most advanced security features required by the latest Protection Profile (PP) v3.0 for Peripheral Sharing Switch (PSS)
Pushbutton Port Selection and secure port switching	Port selection only via Pushbutton to enhance security. Keyboard, Mouse, Video, Audio and CAC reader will switch together for secure switching.
Channel Isolation	Isolated channel per port — making it impossible for data to be leaked or transferred between computers.
Shared peripherals and computer isolation	Console USB and PS/2 keyboard/mouse are supported. The always-on Keyboard, Mouse, and Display EDID emulation ensures isolation between peripherals and connected computers.
Keyboard, Mouse, and Video EDID emulation	Keyboard, Mouse, and EDID emulation ensures isolation between peripherals and connected computers.
Restricted USB connectivity	Non-authorized HID (Human Interface Devices) or non-predefined CAC will be rejected / ignored
Unidirectional data flow	Secure design enables unidirectional data flow between devices and connected computers
Administrative configuration and event log functions	Secure access for authorized Administrator to audit KVM operation logs and secure configuration. (Please refer to Administrator's Guide)
Supports analogue audio (Speaker only)**	Only unidirectional speaker data is allowed preventing the passage of the analog audio by microphone input or line input
Active always-on chassis intrusion detection	If the cover is removed from the switch, the unit becomes inoperable and front panel LEDs (except for Power LED) will flash continuously
Clears keyboard buffer when switching	Keyboard data buffer is automatically purged when switching KVM port focus
Tamper-proof hardware	All integrated circuits are soldered directly to the circuit board to prevent tampering with the components
Tamper-evident tape	Provides a visual indication of any attempt to gain access to the switch's internal components
Tamper-evident tape	Provides a visual indication of any attempt to gain access to the switch's internal components
Firmware non-reprogrammable	Prevents tampering and attempts to reprogram the switch's firmware
Metal enclosure	Rugged metal enclosure

Note:

* IOGEAR HDMI and DisplayPort Secure KVM Switch series supports console video output resolution up to 4K UHD 3840 x 2160 @30Hz.

** IOGEAR Dual-Link DVI Secure KVM Switch series supports 3840 x 2160 @30Hz video output on compatible HDMI-interfaced monitors and / or computers used with IOGEAR's DVI-to-HDMI KVM cables

*** Only analog speaker data input is supported. The IOGEAR Secure KVM does not convert digital audio to analog audio.

Requirements

Console

- DVI (for DVI-interfaced Secure KVM) or HDMI (for HDMI and DisplayPort-interfaced Secure KVM) monitor capable of the highest resolution that will be used on any computer in the installation
- Standard wired USB mouse
- Standard wired USB keyboard
- Standard wired PS/2 mouse (Optional)
- Standard wired PS/2 keyboard (Optional)
- Speaker (Optional)
- USB Smart card or CAC (Common Access Card) reader (Optional)

Computers

- a DVI/HDMI/DisplayPort Video output connector
- a USB Type A port for keyboard and mouse
- a USB Type A port for Smart Card or CAC reader (Optional)
- a 3.5mm jack Audio port for speaker (Optional)

Cables

The KVM cable sets which are specifically designed to work with this switch are not supplied in the package and require a separate purchase.

For security, do not connect any cable that has a microphone audio input or line in audio input

Operating Systems

Suggested operating systems are shown in the table, below:

OS	Version	
Windows	2000 / XP / Vista / 7 / 8 / 8.1 / 10	
Linux	RedHat	6.0 and higher
	SuSE	8.2 and higher
	Mandriva (Mandrake)	9.0 and higher
UNIX	AIX	4.3 and higher
	FreeBSD	3.51 and higher
	Sun	Solaris 9 and higher
Novell	Netware	5.0 and higher
Mac	OS 9 and higher	
DOS	6.2 and higher	

Note: Supports Linux Kernel 2.6 and higher

Overview

Front View

GCS1228TAA3

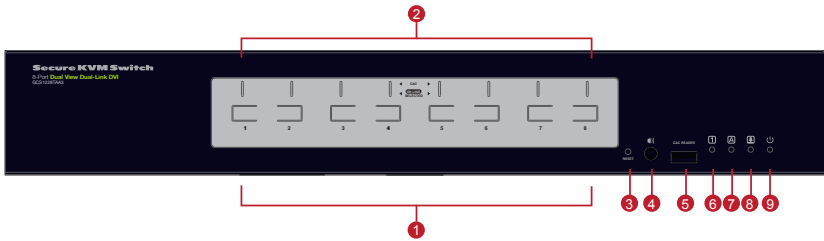

GCS1312TAA3

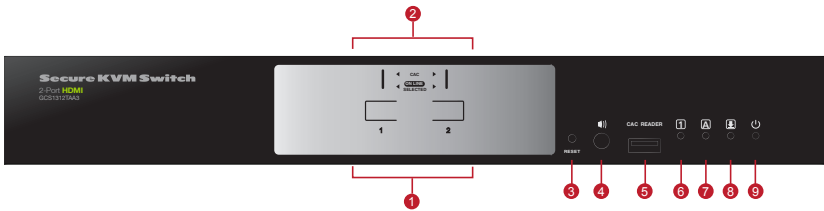

GCS1414TAA3

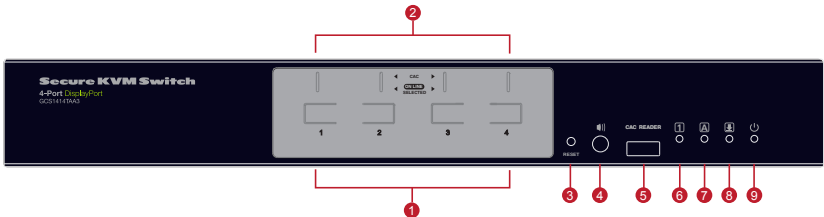

Overview

Rear View

GCS1228TAA3

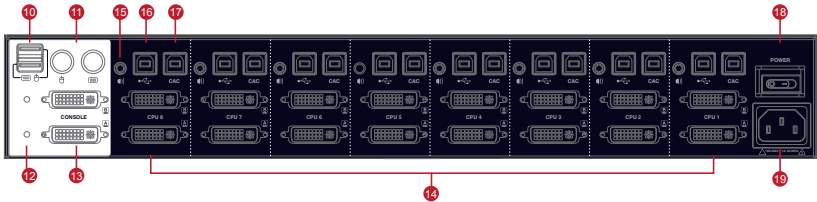

GCS1312TAA3

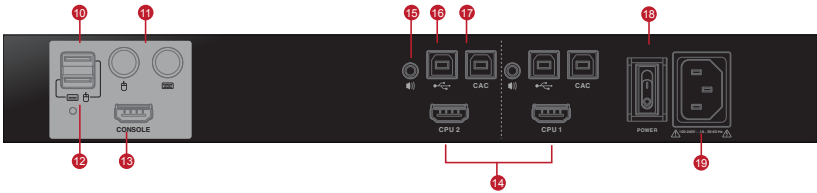

GCS1414TAA3

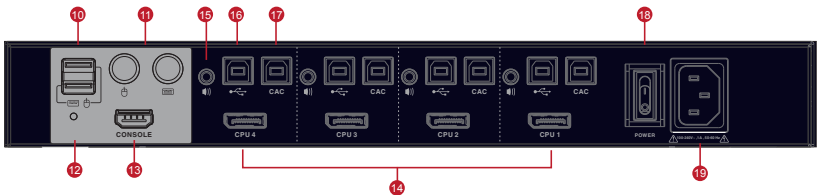

Note:

1. This user manual uses GCS1228TAA3, GCS1312TAA3, and GCS1414TAA3 to demonstrate each interface (DVI / HDMI / DisplayPort), port number (2 / 4 / 8-Port), and number of displays (single / dual) included in IOGEAR Secure KVM Switch series.
2. The console video of the GCS1412/GCS1422/GCS1414/GCS1424/GCS1418/GCS1428 (DisplayPort models) supports only HDMI video output
3. All IOGEAR Secure KVM Switch PP3.0 models support USB and PS/2 console Keyboard/Mouse and USB CAC card reader port.

Overview

No.	Component	Description
1	Port Selection Pushbuttons	Pressing a Port Selection Pushbutton brings together the Keyboard, Mouse, Video, Audio, and CAC reader focus to the computer attached to the corresponding port
2	Port and CAC LEDs	<p>The Port/CAC LEDs located on front panel are to indicate Port/CAC reader selection or connection status.</p> <p>Port LEDs (Bottom row; Orange LEDs) Online – Port LED lights dim orange to indicate that the computer attached to its corresponding port is connected and powered on Selected – Port LED lights bright orange to indicate that the computer attached to its corresponding port has the KVM focus</p> <p>CAC LEDs (Upper row; Green LEDs) Online – CAC LED lights dim green to indicate that the computer attached to its corresponding port has a USB CAC reader cable connection up and running, and the CAC function is enabled Selected – CAC LED lights bright green to indicate that the CAC function is enabled and the computer attached to its corresponding port has the CAC focus None – No lights indicate that the cable is not connected or the CAC function has been disabled Warning – CAC LED Flashes to indicate that a non-qualified USB Smart Card/ CAC reader is connected when the corresponding port has the focus</p> <p><u>Note:</u></p> <ol style="list-style-type: none"> CAC function of each port can be enabled or disabled by pressing the port selection pushbutton for more than 3 seconds (this is a toggle feature). Please refer to the Operation section of this user manual for more information. All front panel LEDs (except for Power LED) will flash continuously when a chassis intrusion or self-test failure is detected. See Chassis Intrusion Detection section for further details Port and CAC LEDs also indicate the status of the Secure KVM self-test. See Operation section for further details
3	Reset Button	<p>Press the Reset Button to reset IOGEAR Secure KVM Switch</p> <p><u>Note:</u></p> <ol style="list-style-type: none"> When the Reset Button is pressed for more than 5 seconds, the Keyboard/ Mouse buffer will be purged and KVM switch will reboot and perform a self-test. After a successful self-test, port focus will be switched to Port 1, and CAC function of each port will be set to factory default (enabled). If the Secure KVM fails to generate video on the monitor after a reset, please power off the installation, check the cables, and follow the instructions in this manual to power on the installation
4	Audio Ports	<p>Connect cables from your speakers to these audio ports</p> <p><u>Note:</u> Only standard analog speaker connections are allowed. The use of analog microphones or line-in audio devices is strictly prohibited</p>
5	USB Smart Card/CAC Reader Port	<p>Only qualified USB authentication devices (e.g., standard smart card and CAC reader) can be connected to this port.</p> <p><u>Note:</u> USB Authentication device filter is configurable by authorized administrators for trusted authentication devices (e.g. USB token, USB Biometric reader). Please refer to Administrator's Guide for details.</p>
6	Num Lock LED	<p>Num Lock LED lights green to indicate that the Num Lock function has been turned on.</p> <p><u>Note:</u> Num Lock LED on keyboard will be disabled due to security requirement</p>
7	Caps Lock LED	<p>Caps Lock LED lights green to indicate that the Caps Lock function has been turned on</p> <p><u>Note:</u> Caps Lock LED on keyboard will be disabled due to security requirement</p>
8	Scroll Lock LED	<p>Scroll Lock LED lights green to indicate that the Scroll Lock function has been turned on.</p> <p><u>Note:</u> Scroll Lock LED on keyboard will be disabled due to security requirement</p>

Overview

9	Power LED	Power LED lights blue to indicate that the IOGEAR Secure KVM Switch is powered on
10	USB Console Ports	<p>Wired USB keyboard and mouse are connected into these ports. The USB console keyboard port (lower port) and mouse port (upper port) are only compatible with standard wired USB keyboards/mice</p> <p><u>Note:</u></p> <ol style="list-style-type: none"> 1. The console USB keyboard and mouse ports are interchangeable. User can connect a keyboard to the mouse port and vice versa. However, for optimal operation, it is recommended that the USB keyboard connected to the console's USB keyboard port and the USB mouse connected to the console's USB mouse port 2. For security purposes, IOGEAR Secure KVM Switch series do not support wireless keyboards and mice. Do not attempt to connect a wireless keyboard and mouse to the switch in any case. 3. Non-standard keyboards/mice with integrated USB hubs and/or other USB-integrated devices may not be fully supported due to the strict security standards and policy for IOGEAR Secure KVM Switch. If supported, only basic (HID) keyboard/mouse operations will function 4. Multimedia keys on the keyboard will not function due to security policy 5. Num Lock, Caps Lock, and Scroll Lock LED on keyboards will not function due to security policy.
11	PS/2 Console Ports	Wired PS/2 keyboard and mouse are connected into these ports. (PS/2 Mouse port: Green; PS/2 Keyboard port: Purple)
12	Video LED(s)	<p>Video LED lights green when the video connection is established. Video LED flashes when a non-qualified monitor is connected.</p> <p><u>Note:</u></p> <p>With the Dual View (dual monitor) models, each console video connection has one Video LED</p>
13	Console Monitor Port(s)	<p>Console monitor's cables are connected into these ports</p> <p><u>Note:</u></p> <p>IOGEAR Secure KVM Switch Dual View models has two console monitor ports</p>
14	KVM Port Section	Connect IOGEAR proprietary KVM cables from the computers into these ports
15	KVM Audio Ports	<p>Connect audio cable from the connected computers into these ports</p> <p><u>Note:</u></p> <p>Only speaker connections are allowed. The use of analog microphones or line-in audio devices is strictly prohibited</p>
16	KVM USB Ports	Connect the USB cable from the keyboard and mouse into these ports
17	USB Smart Card / CAC (Common Access Card) Reader Port	Connect the USB cable from the connected USB Smart Card / CAC reader into these ports
18	Power Switch	This is a standard rocker switch that powers the IOGEAR Secure KVM Switch off and on
19	Power Socket	Connect the included AC power cord into this socket

Hardware Setup

8. For security, do not use any USB CAC authentication device or other peripherals that adopt an external power source.
9. Always use qualified monitor(s). Non-qualified monitors will be rejected.
10. Do not use wireless video transmitters or any docking device.
11. Do not connect any Thunderbolt device to IOGEAR Secure KVM Switch.

Secure Installation

1. Do not attempt to connect or install the following devices to the computers connected to IOGEAR Secure KVM Switch:
 - TEMPEST computers,
 - Telecommunication equipment,
 - Frame grabber video cards, or
 - Special audio processing cards
2. Important safety information regarding the placement of this device is provided on page 25. Please review it before proceeding.
3. Before installation, please make sure that the power sources to all connected devices are turned off. You must unplug the power cords of any computers that have the Keyboard Power On function.
4. Hot-swapping of the console monitor is not allowed. Power off the Secure KVM Switch and the monitor before changing the console monitor.
5. A computer connected to IOGEAR Secure KVM Switch should only be powered on after all of the device (Video, USB, and audio) are securely connected

Secure Operation and Administration

Please refer to **Operation** section for detail administrator functions.

Hardware Setup

Stacking

IOGEAR Secure KVM Switch features a rugged, metal enclosure which provides stability and allows the unit to be stacked on a desktop. The unit can be placed on any leveled surface that can safely support its weight and the weight of the attached cables. Please ensure that the surface is clean and free of materials that can block the exhaust vents or otherwise interfere with normal operation of IOGEAR Secure KVM Switch

Rack-mount

IOGEAR Secure KVM Switch features a rack-mount design and offers rack-mount options. Rack-mount kits which are specifically designed to work with this switch are not supplied in the package and require a separate purchase.

Cable Connection

To install IOGEAR Secure KVM Switch, please refer to the installation diagram on the following page. The numbers in the diagrams correspond to the steps below:

1. Connect the wired USB keyboard and USB mouse into the USB console ports located on the unit's rear panel. The USB keyboard and mouse console ports are compatible only with standard wired USB keyboard/mice.
or
Connect the PS/2 keyboard and PS/2 mouse, if you are using PS/2 keyboard and mouse, into the corresponding PS/2 ports.

Note:

1. The console USB keyboard and mouse ports are interchangeable. You can connect a keyboard to the mouse port and vice versa. However, for optimal operation, it is recommended that you connect the USB keyboard to the console's USB keyboard port and the USB mouse to the console's USB mouse port.
 2. For security purposes, IOGEAR Secure KVM Switch does not support wireless keyboards and mice.
Do not attempt to connect a wireless keyboard/mouse to the switch
 3. During IOGEAR Secure KVM Switch operation, non-standard keyboards with integrated USB hubs and/or other USB-integrated devices may not be fully supported, due to the strict security standards and policy for IOGEAR Secure KVM Switch. If supported, only basic (HID) keyboard operations will function
 4. When the IOGEAR Secure KVM Switch is powered on and the keyboard or mouse is rejected, the keyboard and mouse will be inoperable (i.e., mouse cursor freezes and/or no key strokes response on the connected computer)
2. Connect the console monitor(s) into the console Video port(s) located on the unit's rear panel. Then, power the monitor on.

Note:

1. When the IOGEAR Secure KVM Switch is powered on, the Video LED lights green indicating that the video connection is established. The Video LED flashes when non-qualified monitors are connected
2. Due to security policy, IOGEAR Secure KVM Switch does not support monitor hot-swap. If you would like to change the console monitor, you must first power off the entire installation.
3. Connected monitors will be filtered when IOGEAR Secure KVM Switch is powered on. Non-qualified monitor will be rejected (Video LED flashes). Please refer to the LED Display for detail visual identification.

3. Connect the speakers into the console's speaker jack located on the unit's front panel.

Note:

1. Only speaker connections are allowed. The use of analog microphones or line-in audio connections is strictly prohibited.

4. For Single View (single monitor) IOGEAR Secure KVM Switch
Using IOGEAR's proprietary KVM cable set (not supplied with this package and must be purchased separately), connect the Video connector into any available Video socket in the KVM port section of the switch, then connect the accompanying USB (Keyboard/Mouse or CAC) and speaker connectors into their corresponding USB and speaker ports.

For Dual View (dual monitors) IOGEAR Secure KVM Switch,
Using IOGEAR's proprietary KVM cable set (not supplied with this package and must be purchased separately), connect the Video connector for primary monitor into any available Video socket A in the KVM port section of the switch, then connect the accompanying USB (Keyboard/Mouse or CAC) and speaker connectors into their corresponding USB and speaker ports. Connect a separate Video cable for secondary monitor to corresponding Video socket B in the same KVM port section of the switch.

Note:

1. Verify that all connectors are in the same or corresponding KVM Port sockets (all in Port 1, all in Port 2, etc.). Each socket is marked with appropriate icons
2. If the CAC reader function is to be disabled for certain PCs, it is advised not to connect the corresponding USB CAC cable in the installation

Hardware Setup

5. With the other end of the KVM cable set, connect the USB, video, and speaker cables into their respective ports on the computers.

Note:

1. On Dual View (dual display) KVM installation, please verify that the second Video connection is in the same KVM Port sockets as the first Video connection (all in Port 1, all in Port 2, etc.) Each socket is marked with appropriate icons
2. Repeat steps 4, 5, 6, and 7 for each PC system you are installing
3. On Dual View (dual display) KVM installation, you may also connect all of the primary Video connectors to Video Sockets B and all secondary Video connectors to Video Sockets A for easier cable connections. Please make sure your console primary and secondary monitors are connected the same way.

6. Connect the USB Smart Card / CAC reader to the CAC port on the front panel of IOGEAR Secure KVM Switch

Note:

1. Only qualified USB Authentication devices (e.g., Smart Card and CAC readers by default) can be connected into this port. During KVM operation, non-qualified or non-authorized USB devices will be filtered and rejected (CAC LED that has the port focus will flash continuously). Please refer to LED Display for visual indications.
2. CDF (Configurable Device Filtering) function can only be operated by authorized administrators.
3. Please refer to Administrator's Guide and Port Authentication Utility Guide for more details

7. Connect the female end of the power cord into IOGEAR Secure KVM Switch's power socket. Then, connect the male end of the power cord into an AC power source.
8. Power on the IOGEAR Secure KVM Switch and check if the LEDs light up. IOGEAR Secure KVM Switch will begin KVM self-test momentarily.

Note:

IOGEAR Secure KVM Switch performs a security self-test at power-on and at each power cycle. Front panel LEDs will indicate the self-test status and test result. Please refer to the **Operation** section and the **LED Display** section for visual identification detail.

Hardware Setup

Front View



Rear View

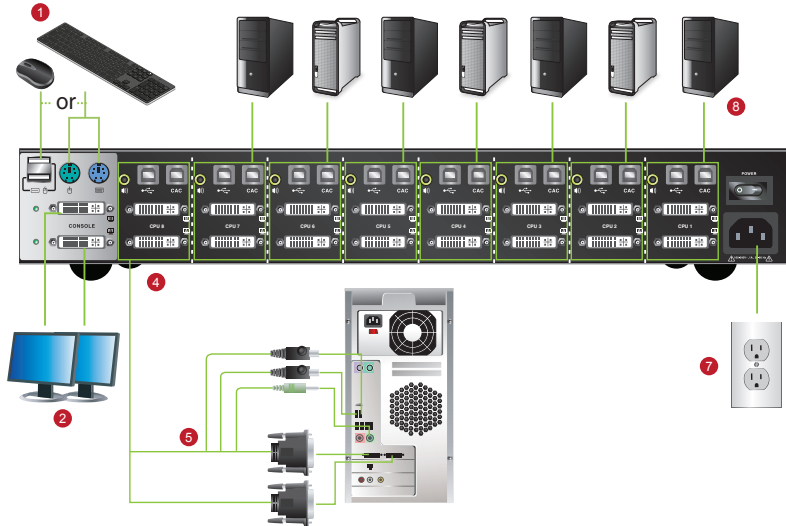

Chapter 3 - Operation

Powering On

When powering on, resetting, or power cycling IOGEAR Secure KVM Switch, the switch will perform a self-test to check the unit's integrity and security functions.

During the self-test

All Port and CAC LEDs will turn ON and then OFF

The KVM focus will be switched to Port 1 when the self-test completes successfully (Port 1 LED lights bright orange)

Self-test failure

In case of a self-test failure, IOGEAR Secure KVM Switch becomes inoperable. Front panel LED combination lights up, indicating the potential cause to the failure (such as button jam or KVM integrity compromise):

A pre-defined combination of Port and CAC LED indicates the cause to the failure.

If all front panel LEDs (except for Power LED) flash continuously, then either KVM tampering is detected or a self-test failure has occurred (except for Pushbutton jam; see below)

If Pushbutton jam is detected, both the Port and CAC LEDs will flash

For security, IOGEAR Secure KVM Switch becomes inoperable if self-test fails. Please verify your KVM installation, pushbuttons, and power cycle the Secure KVM Switch again if this should happen. If the self-test failure remains, stop using the Secure KVM Switch immediately, remove it from service, and contact your IOGEAR dealer.

After the IOGEAR Secure KVM Switch is powered on and ready, power on your computers. By default, the IOGEAR Secure KVM Switch will switch to Port 1 after a successful self-test.

IOGEAR Secure KVM Switch filters and emulates both the mouse and keyboard on each port after the unit is powered on. If the keyboard, mouse, monitor, or Smart Card / CAC reader fails to operate properly, make sure that only qualified and authorized peripherals are connected. Next, power off IOGEAR Secure KVM Switch and check all cable connections. Then, power the unit back on again.

Manual Switching

For increased security, IOGEAR Secure KVM Switch offers manual port-switching only. This is achieved by pressing the port selection pushbutton located on the Secure KVM switch's front panel. Press and release a port selection pushbutton to bring the KVM focus to the computer attached to its corresponding port (see Port ID Numbering below). To meet maximum security and channel isolation requirements, the keyboard, mouse, video monitor, audio, and USB CAC reader ports will be switched together. The Selected Port LED lights orange to indicate that the computer attached to its corresponding port has the KVM focus (keyboard, mouse, monitor, audio, and CAC reader).

The PC that has the port focus on should be able to detect the peripherals after port switching. If the PC fails to detect the keyboard, mouse, or CAC reader:

- Please verify if you are using qualified Keyboard, Mouse, or CAC reader
- Please verify if your keyboard, mouse, or CAC reader has failed
- For USB CAC Card readers (USB authentication devices), please make sure that the USB CAC cable has been securely connected and the CAC function on the Secure KVM switch is enabled.
- Please verify if the USB CAC reader has been authorized for the corresponding port

Port ID Numbering

Each KVM port on IOGEAR Secure KVM Switch is assigned a port number (1-2 for 2-Port models; 1-4 for 4-Port models; 1-8 for 8-Port models). The port numbers are marked on the rear side of the switch. See **Rear View** section in this manual. The port ID of a computer is derived from the KVM port number to which it is connected.

Operation

LED Display

In addition to the Power LED, IOGEAR Secure KVM Switch has Port LEDs (Online and Selected), keyboard lock (Num Lock / Caps Lock / Scroll Lock) LEDs and CAC LEDs that are built into the front panel to indicate Port / Keyboard / CAC reader operating status. A Video LED is located on rear panel to indicate the operating status of the video connection. These LEDs also serve as the alarm notification for KVM security issues.

LED	Indication
Power LED	Power LED is located on the front panel Power LED lights blue to indicate that the KVM switch is powered on.
Video LED	Video LED is located on the rear panel next to each video connector. Video LED lights green when the video connection is established. Video LED flashes when a non-qualified monitor is connected.
Port LED	Port LEDs located on the front panel are to indicate the Port selection or connection status. Online – Port LED lights dim orange to indicate that the computer attached to its corresponding port is connected and powered on. Selected – Port LED lights bright orange to indicate that the computer attached to its corresponding port has the KVM focus. <u>Note:</u> 1. Port and CAC LEDs will flash constantly when a chassis intrusion is detected. See Chassis Intrusion Detection section for details. 2. Port and CAC LEDs also indicate the Secure KVM self-test status. See Operation section for further details
CAC LED	CAC LEDs located on front panel are to indicate CAC reader selection or connection status: Online – CAC LED lights dim green to indicate that the computer attached to the corresponding port has a USB CAC reader cable connection established and that CAC function is enabled. Selected – CAC LED lights bright green to indicate that the CAC function is enabled and the computer attached to the corresponding port has the CAC focus None – No light indicates that the cable is not connected or CAC has been disabled Warning – CAC LED flashes to indicate that a non-qualified USB Smart card / CAC reader is connected when the corresponding port has the focus. <u>Note:</u> 1. CAC function of each port can be enabled or disabled by pressing the port selection button for more than 3 seconds (This is a toggle function). Please refer to Operation section for details. 2. Port and CAC LEDs will flash constantly when a chassis intrusion is detected. See Chassis Intrusion Detection section for further details.
Num Lock LED	Num Lock LED lights green to indicate Num Lock is enabled
Caps Lock LED	Caps Lock LED lights green to indicate Caps Lock is enabled
Scroll Lock LED	Scroll Lock LED lights green to indicate Scroll Lock is enabled

Chassis Intrusion Detection

The IOGEAR Secure KVM Switch will become inoperable and the Front Panel LEDs (except for the Power LED) will flash constantly when a chassis intrusion, such as the cover being removed, is detected. This is to prevent malicious tampering with IOGEAR Secure KVM Switch.

The Intrusion Detection is an active always-on function. If all of the front panel LEDs (except for Power LED) flash continuously or the switch's enclosure appears to be breached, avoid using this product and contact your IOGEAR dealer.

Smart Card and CAC Reader

The USB Smart Card / CAC reader function of each port can be enabled or disabled (enabled by default). Press the port selection pushbutton for more than 3 seconds and release it, and the CAC reader function of that port will be enabled/disabled (this is a toggle feature). The CAC LEDs are used to indicate the CAC reader operation status.

If the CAC reader function is to be disabled for certain PCs, it is advised not to connect a USB CAC cable in the installation.

Appendix

Safety Instructions

General

This product is for indoor use only

Read all of these instructions. Save them for future reference.

Follow all warnings and instructions marked on the device

Do not place the device on any unstable surface (cart, stand, table, etc.). If the device falls, serious damage will result

Do not use the device near water

Do not place the device near, or over, radiators or heat registers

The device cabinet is provided with slots and openings to allow for adequate ventilation*. To ensure reliable operation, and to protect against overheating, the cabinet must never be blocked or covered

The device should never be placed on a soft surface (bed, sofa, rug, etc.) as this will block its ventilation openings*. Placing the device without slots or openings on a soft surface will affect the heat dissipation.

The device should be not placed in a built-in enclosure unless adequate ventilation has been provided

Never spill liquid of any kind on the device

Unplug the device from the wall outlet before cleaning. Do not use liquid or aerosol cleaners. Use a damp cloth for cleaning

The device should be operated from the type of power source indicated on the marking label. If you are not sure of the type of power available, consult your dealer or local power company

The device is designed for IT power distribution systems with 230V phase-to-phase voltage

To prevent damage to your installation, it is important that all devices be properly grounded

The device is equipped with a 3-wire grounding type plug. This is a safety feature. If you are unable to insert the plug into the outlet, contact your electrician to replace your obsolete outlet. Do not attempt to defeat the purpose of the grounding-type plug. Always follow your local / national wiring codes.

Do not allow anything to rest on the power cord or cables. Route the power cord and cables so that they cannot be stepped on or tripped over.

If an extension cord is used with this device, make sure that the total of the ampere ratings of all products used on this cord does not exceed the extension cord ampere rating. Make sure that the total of all products connected to the wall outlet does not exceed 15 amperes

To help protect your system from sudden, transient increases and decreases in electrical power, use a surge suppressor, line conditioner, or uninterruptible power supply (UPS)

Position system cables and power cables carefully; Make sure that nothing rests on any cables

Never push objects of any kind into or through cabinet slots. They may touch dangerous voltage points or short out parts resulting in a risk of fire or electrical shock.

Do not attempt to service the device yourself. Refer all servicing to qualified service personnel

If the following conditions occur, unplug the device from the wall outlet and take it to a qualified service personnel for repair:

- The power cord or plug has become damaged or fried
- Liquid has been spilled into the device
- The device has been exposed to rain or water
- The device has been dropped, or the cabinet has been damaged
- The device exhibits a distinct change in performance, indicating a need for service
- The device does not operate normally when the operating instructions are followed

CAUTION: Never attempt to replace the battery or open the switches' enclosure

*Note: Not all devices have slots or openings to allow for ventilation

Specification - DisplayPort Single View Secure KVM

IOGEAR DisplayPort Single View Secure KVM

Function		GCS1412TAA3	GCS1414TAA3	GCS1418TAA3	
Computer Connections	Direct	2	4	8	
	Maximum	2	4	8	
Console Connections		1 Direct			
Port Selection		Pushbutton			
Connectors	Console Ports	Keyboard	1 x 6-pin Mini-DIN Female (Purple) 1 x USB Type A Female (2/4-Port Black; 8-Port White)		
		Video	1 x HDMI 1.4 Female (Black)		
		Mouse	1 x 6-pin Mini-DIN Female (Green) 1 x USB Type A Female (2/4-Port Black; 8-Port White)		
		Speaker	1 x Mini Stereo Jack Female (Green)		
		Microphone	N/A		
		CAC	1 x USB Type A Female (Black)		
	KVM Ports	Keyboard/ Mouse	2 x USB Type-B Female (White)	4 x USB Type-B Female (White)	8 x USB Type-B Female (White)
		Video	2 x DisplayPort1.2 Female (Black)	4 x DisplayPort1.2 Female (Black)	8 x DisplayPort1.2 Female (Black)
		CAC	2 x USB Type-B Female (White)	4 x USB Type-B Female (White)	8 x USB Type-B Female (White)
		Speaker	2 x Mini Stereo Jack Female (Green)	4 x Mini Stereo Jack Female (Green)	8 x Mini Stereo Jack Female (Green)
		Microphone	N/A		
	Power		1 x 3-Prong AC Socket		
	Switches	Port	2 x Pushbuttons	4 x Pushbuttons	8 x Pushbuttons
		Reset	1 x Semi-recessed Pushbutton		
Power		1 x Rocker			
LEDs	On Line / Selected	2 (Orange)	4 (Orange)	8 (Orange)	
	CAC activated	2 (Green)	4 (Green)	8 (Green)	
	Power	1 (Blue)			
	Key Lock LED	3 (Green; Num Lock, Caps Lock, Scroll Lock)			
	Console Video	1 (Green, on rear panel)			
Emulation	Keyboard/Mouse	USB			
Video		Max. 3840 x 2160 @30Hz (UHD)			
Scan Interval		N/A			
I/P Rating		100-240V~; 50-60Hz; 1A			
Environment Physical Properties	Operating Temperature	0-50C			
	Storage Temperature	-20 – 60C			
	Humidity	0-80% RH, Non-condensing			
Physical Properties	Housing	Metal			
	Weight	3.69lb (1.68kg)	3.74 lb (1.70kg)	6.23lb (2.83kg)	
	Dimension	13.1"x6.42"x1.73" (33.5cmx16.3cmx4.4cm)	13.1"x6.42"x1.73" (33.5cmx16.3cmx4.4cm)	17"x8"x2.58" (43.24cmx20.4cmx6.55cm)	

Specification - DisplayPort Dual View Secure KVM

IOGEAR DisplayPort Dual View Secure KVM

Function		GCS1422TAA3	GCS1424TAA3	GCS1428TAA3	
Computer Connections	Direct	2	4	8	
	Maximum	2	4	8	
Console Connections		1 Direct			
Port Selection		Pushbutton			
Connectors	Console Ports	Keyboard	1 x 6-pin Mini-DIN Female (Purple) 1 x USB Type A Female (2/4-Port Black; 8-Port White)		
		Video	2 x HDMI 1.4 Female (Black)		
		Mouse	1 x 6-pin Mini-DIN Female (Green) 1 x USB Type A Female (2/4-Port Black; 8-Port White)		
		Speaker	1 x Mini Stereo Jack Female (Green)		
		Microphone	N/A		
		CAC	1 x USB Type A Female (Black)		
	KVM Ports	Keyboard/ Mouse	2 x USB Type-B Female (White)	4 x USB Type-B Female (White)	8 x USB Type-B Female (White)
		Video	4 x DisplayPort1.2 Female (Black)	8 x DisplayPort1.2 Female (Black)	16 x DisplayPort1.2 Female (Black)
		CAC	2 x USB Type-B Female (White)	4 x USB Type-B Female (White)	8 x USB Type-B Female (White)
		Speaker	2 x Mini Stereo Jack Female (Green)	4 x Mini Stereo Jack Female (Green)	8 x Mini Stereo Jack Female (Green)
		Microphone	N/A		
	Power		1 x 3-Prong AC Socket		
	Switches	Port	2 x Pushbuttons	4 x Pushbuttons	8 x Pushbuttons
		Reset	1 x Semi-recessed Pushbutton		
		Power	1 x Rocker		
LEDs	On Line / Selected	2 (Orange)	4 (Orange)	8 (Orange)	
	CAC activated	2 (Green)	4 (Green)	8 (Green)	
	Power	1 (Blue)			
	Key Lock LED	3 (Green; Num Lock, Caps Lock, Scroll Lock)			
	Console Video	2 (Green, on rear panel)			
Emulation	Keyboard/Mouse	USB			
Video	Max. 3840 x 2160 @30Hz (UHD)				
Scan Interval		N/A			
I/P Rating		100-240V~; 50-60Hz; 1A			
Environment Physical Properties	Operation Temperature	0-50C			
	Storage Temperature	-20 – 60C			
	Humidity	0-80% RH, Non-condensing			
Physical Properties	Housing	Metal			
	Weight	4.45lb (2.02kg)	4.49lb (2.04kg)	6.89lb (3.13kg)	
	Dimension	13.2"x6.42"x2.58" (33.5cmx16.3cmx6.55cm)	13.2"x6.42"x2.58" (33.5cmx16.3cmx6.55cm)	17"x8"x2.58" (43.24cmx20.4cmx6.55cm)	

Specification - HDMI Single View Secure KVM

IOGEAR HDMI Single View Secure KVM

Function		GCS1312TAA3	GCS1314TAA3	GCS1318TAA3	
Computer Connections	Direct	2	4	8	
	Maximum	2	4	8	
Console Connections		1 Direct			
Port Selection		Pushbutton			
Connectors	Console Ports	Keyboard	1 x 6-pin Mini-DIN Female (Purple) 1 x USB Type A Female (2/4-Port Black; 8-Port White)		
		Video	1 x HDMI 1.4 Female (Black)		
		Mouse	1 x 6-pin Mini-DIN Female (Green) 1 x USB Type A Female (2/4-Port Black; 8-Port White)		
		Speaker	1 x Mini Stereo Jack Female (Green)		
		Microphone	N/A		
		CAC	1 x USB Type A Female (Black)		
	KVM Ports	Keyboard/Mouse	2 x USB Type-B Female (White)	4 x USB Type-B Female (White)	8 x USB Type-B Female (White)
		Video	2 x HDMI 1.4 Female (Black)	4 x HDMI 1.4 Female (Black)	8 x HDMI 1.4 Female (Black)
		CAC	2 x USB Type-B Female (White)	4 x USB Type-B Female (White)	8 x USB Type-B Female (White)
		Speaker	2 x Mini Stereo Jack Female (Green)	4 x Mini Stereo Jack Female (Green)	8 x Mini Stereo Jack Female (Green)
		Microphone	N/A		
	Power		1 x 3-Prong AC Socket		
	Switches	Port	2 x Pushbuttons	4 x Pushbuttons	8 x Pushbuttons
		Reset	1 x Semi-recessed Pushbutton		
		Power	1 x Rocker		
LEDs	On Line / Selected	2 (Orange)	4 (Orange)	8 (Orange)	
	CAC activated	2 (Green)	4 (Green)	8 (Green)	
	Power	1 (Blue)			
	Key Lock LED	3 (Green; Num Lock, Caps Lock, Scroll Lock)			
	Console Video	1 (Green, on rear panel)			
Emulation	Keyboard/Mouse	USB			
Video		Max. 3840 x 2160 @30Hz (UHD); 1920 x 1080 (FHD)			
Scan Interval		N/A			
I/P Rating		100-240V~; 50-60Hz; 1A			
Environment Physical Properties	Operation Temperature	0-50C			
	Storage Temperature	-20 – 60C			
	Humidity	0-80% RH, Non-condensing			
Physical Properties	Housing	Metal			
	Weight	3.69lb (1.68kg)	3.74lb (1.70kg)	6.23lb (2.83kg)	
	Dimension	13.1"x6.42"x1.73" (33.5cmx16.3cmx4.4cm)	13.1"x6.42"x1.73" (33.5cmx16.3cmx4.4cm)	17"x8"x2.58" (43.24cmx20.4cmx6.55cm)	

Specification - HDMI Dual View Secure KVM

IOGEAR HDMI Dual View Secure KVM

Function		GCS1322TAA3	GCS1324TAA3	GCS1328TAA3	
Computer Connections	Direct	2	4	8	
	Maximum	2	4	8	
Console Connections		1 Direct			
Port Selection		Pushbutton			
Connectors	Console Ports	Keyboard	1 x 6-pin Mini-DIN Female (Purple) 1 x USB Type A Female (2/4-Port Black; 8-Port White)		
		Video	2 x HDMI 1.4 Female (Black)		
		Mouse	1 x 6-pin Mini-DIN Female (Green) 1 x USB Type A Female (2/4-Port Black; 8-Port White)		
		Speaker	1 x Mini Stereo Jack Female (Green)		
		Microphone	N/A		
		CAC	1 x USB Type A Female (Black)		
	KVM Ports	Keyboard/Mouse	2 x USB Type-B Female (White)	4 x USB Type-B Female (White)	8 x USB Type-B Female (White)
		Video	4 x HDMI1.4 Female (Black)	8 x HDMI1.4 Female (Black)	16 x HDMI1.4 Female (Black)
		CAC	2 x USB Type-B Female (White)	4 x USB Type-B Female (White)	8 x USB Type-B Female (White)
		Speaker	2 x Mini Stereo Jack Female (Green)	4 x Mini Stereo Jack Female (Green)	8 x Mini Stereo Jack Female (Green)
		Microphone	N/A		
	Power		1 x 3-Prong AC Socket		
	Switches	Port	2 x Pushbuttons	4 x Pushbuttons	8 x Pushbuttons
		Reset	1 x Semi-recessed Pushbutton		
		Power	1 x Rocker		
LEDs	On Line / Selected	2 (Orange)	4 (Orange)	8 (Orange)	
	CAC activated	2 (Green)	4 (Green)	8 (Green)	
	Power	1 (Blue)			
	Key Lock LED	3 (Green; Num Lock, Caps Lock, Scroll Lock)			
	Console Video	2 (Green, on rear panel)			
Emulation	Keyboard/Mouse	USB			
Video		Max. 3840 x 2160 @30Hz (UHD); 1920 x 1080 (FHD)			
Scan Interval		N/A			
I/P Rating		100-240V~; 50-60Hz; 1A			
Environment Physical Properties	Operating Temperature	0-50C			
	Storage Temperature	-20 – 60C			
	Humidity	0-80% RH, Non-condensing			
Physical Properties	Housing	Metal			
	Weight	4.44lb (2.02kg)	4.49lb (2.04kg)	6.89lb (3.13kg)	
	Dimension	13.2"x6.42"x2.58" (33.5cmx16.3cmx6.55cm)	13.2"x6.42"x2.58" (33.5x16.3cmx6.55cm)	17"x8"x2.58" (43.24cmx20.4cmx6.55cm)	

Specification - DVI Single View Secure KVM

IOGEAR DVI Single View Secure KVM

Function		GCS1212TAA3	GCS1214TAA3	GCS1218TAA3	
Computer Connections	Direct	2	4	8	
	Maximum	2	4	8	
Console Connections		1 Direct			
Port Selection		Pushbutton			
Connectors	Console Ports	Keyboard	1 x 6-pin Mini-DIN Female (Purple) 1 x USB Type A Female (2/4-Port Black; 8-Port White)		
		Video	1 x DVI-I Dual-Link Female (White)		
		Mouse	1 x 6-pin Mini-DIN Female (Green) 1 x USB Type A Female (2/4-Port Black; 8-Port White)		
		Speaker	1 x Mini Stereo Jack Female (Green)		
		Microphone	N/A		
		CAC	1 x USB Type A Female (Black)		
	KVM Ports	Keyboard/Mouse	2 x USB Type-B Female (White)	4 x USB Type-B Female (White)	8 x USB Type-B Female (White)
		Video	2 x DVI-I Dual-Link Female (White)	4 x DVI-I Dual-Link Female (White)	8 x DVI-I Dual-Link Female (White)
		CAC	2 x USB Type-B Female (White)	4 x USB Type-B Female (White)	8 x USB Type-B Female (White)
		Speaker	2 x Mini Stereo Jack Female (Green)	4 x Mini Stereo Jack Female (Green)	8 x Mini Stereo Jack Female (Green)
		Microphone	N/A		
	Power	1 x 3-Prong AC Socket			
	Switches	Port	2 x Pushbuttons	4 x Pushbuttons	8 x Pushbuttons
Reset		1 x Semi-recessed Pushbutton			
Power		1 x Rocker			
LEDs	On Line / Selected	2 (Orange)	4 (Orange)	8 (Orange)	
	CAC activated	2 (Green)	4 (Green)	8 (Green)	
	Power	1 (Blue)			
	Key Lock LED	3 (Green; Num Lock, Caps Lock, Scroll Lock)			
	Console Video	1 (Green, on rear panel)			
Emulation	Keyboard/Mouse	USB			
Video		3840 x 2160 @ 30Hz* 1920 x 1200 DVI Single-Link	2560 x 1600 DVI Dual-Link 2048 x 1536 DVI-A		
Scan Interval		N/A			
I/P Rating		100-240V~; 50-60Hz; 1A			
Environment Physical Properties	Operating Temperature	0-50C			
	Storage Temperature	-20 – 60C			
	Humidity	0-80% RH, Non-condensing			
Physical Properties	Housing	Metal			
	Weight	3.69lb (1.68kg)	3.74lb (1.70kg)	6.23lb (2.83kg)	
	Dimension	13.1"x6.42"x1.73" (33.5cmx16.3cmx4.4cm)	13.2"x6.42"x1.73" (33.5cmx16.3cmx4.4cm)	17"x8"x2.58" (43.24cmx20.4cmx6.55cm)	

* IOGEAR Single / Dual View Dual-Link DVI Secure KVM Switch offer 3840 x 2160 @ 30Hz video output on compatible HDMI-interfaced monitors and / or computers used with IOGEAR DVI-to-HDMI KVM cables

Specification - DVI Dual View Secure KVM

IOGEAR DVI Dual View Secure KVM

Function		GCS1222TAA3	GCS1224TAA3	GCS1228TAA3	
Computer Connections	Direct	2	4	8	
	Maximum	2	4	8	
Console Connections		1 Direct			
Port Selection		Pushbutton			
Connectors	Console Ports	Keyboard	1 x 6-pin Mini-DIN Female (Purple) 1 x USB Type A Female (2/4-Port Black; 8-Port White)		
		Video	2 x DVI-I Dual-Link Female (White)		
		Mouse	1 x 6-pin Mini-DIN Female (Green) 1 x USB Type A Female (2/4-Port Black; 8-Port White)		
		Speaker	1 x Mini Stereo Jack Female (Green)		
		Microphone	N/A		
		CAC	1 x USB Type A Female (Black)		
	KVM Ports	Keyboard/ Mouse	2 x USB Type-B Female (White)	4 x USB Type-B Female (White)	8 x USB Type-B Female (White)
		Video	4 x DVI-I Dual-Link Female (White)	8 x DVI-I Dual-Link Female (White)	16 x DVI-I Dual-Link Female (White)
		CAC	2 x USB Type-B Female (White)	4 x USB Type-B Female (White)	8 x USB Type-B Female (White)
		Speaker	2 x Mini Stereo Jack Female (Green)	4 x Mini Stereo Jack Female (Green)	8 x Mini Stereo Jack Female (Green)
		Microphone	N/A		
	Power		1 x 3-Prong AC Socket		
	Switches	Port	2 x Pushbuttons	4 x Pushbuttons	8 x Pushbuttons
		Reset	1 x Semi-recessed Pushbutton		
Power		1 x Rocker			
LEDs	On Line / Selected	2 (Orange)	4 (Orange)	8 (Orange)	
	CAC activated	2 (Green)	4 (Green)	8 (Green)	
	Power	1 (Blue)			
	Key Lock LED	3 (Green; Num Lock, Caps Lock, Scroll Lock)			
	Console Video	2 (Green, on rear panel)			
Emulation	Keyboard/Mouse	USB			
Video		3840 x 2160 @ 30Hz* 1920 x 1200 DVI Single-Link	2560 x 1600 DVI Dual-Link 2048 x 1536 DVI-A		
Scan Interval		N/A			
I/P Rating		100-240V~; 50-60Hz; 1A			
Environment Physical Properties	Operation Temperature	0-50C			
	Storage Temperature	-20 – 60C			
	Humidity	0-80% RH, Non-condensing			
Physical Properties	Housing	Metal			
	Weight	4.45lb (2.02kg)	4.49lb (2.04kg)	6.89lb (3.13kg)	
	Dimension	13.19"x6.42"x2.58" (33.5cmx16.3cmx6.5cm)	13.19"x6.42"x2.58" (33.5cmx16.3cmx6.5cm)	17"x9.27"x2.58" (43.24cmx20.4cmx6.55cm)	

* IOGEAR Single / Dual View Dual-Link DVI Secure KVM Switch offer 3840 x 2160 @ 30Hz video output on compatible HDMI-interfaced monitors and / or computers and used with IOGEAR DVI-to-HDMI KVM cables

Limited Warranty

IN NO EVENT SHALL THE DIRECT VENDOR'S LIABILITY EXCEED THE PRICE PAID FOR THE PRODUCT FROM DIRECT, INDIRECT, SPECIAL, INCIDENTAL, OR CONSEQUENTIAL DAMAGES RESULTING FROM THE USE OF THE PRODUCT, DISK, OR ITS DOCUMENTATION.

The direct vendor makes no warranty or representation, expressed, implied, or statutory with respect to the contents or use of this documentation, and especially disclaims its quality, performance, merchantability, or fitness for any particular purpose.

The direct vendor also reserves the right to revise or update the device or documentation without obligation to notify any individual or entity of such revisions, or update. For further inquiries, please contact your direct vendor.

This Secure KVM carries a 4 Year Limited Warranty. For the terms and conditions of this warranty, please visit <http://www.iogear.com/support/warranty>

Register your IOGEAR Secure KVM Switch online at <https://www.iogear.com/register>
For further assistance with IOGEAR Secure KVM Switch series, please contact IOGEAR Technical Support department at GovSupport@iogear.com

This page is intentionally left blank

This page is intentionally left blank

This page is intentionally left blank

