



Hardware Installation Guide for the Cisco 1100 Series Integrated Services Router

Last Modified: 2017-11-09

Americas Headquarters

Cisco Systems, Inc.
170 West Tasman Drive
San Jose, CA 95134-1706
USA
<http://www.cisco.com>
Tel: 408 526-4000
800 553-NETS (6387)
Fax: 408 527-0883



CONTENTS

Preface

Preface vii

Audience vii

Document Organization vii

Document Conventions viii

Related Documentation ix

Obtaining Documentation and Submitting a Service Request x

CHAPTER 1

Overview of Cisco 1100 Series Integrated Services Routers 1

Overview 1

About Cisco 1100 Series Integrated Service Routers 1

Chassis Views 2

Labels on the Router 3

For Additional Help Locating Labels on the Router 4

Hardware Features 4

Interface Ports 4

Power-over-Ethernet (PoE) 5

LED Indicators 5

Reset Button 10

Slots and Interfaces 10

About Slots, Subslots, and Port Numbering 10

Subslot/Bay Numbering 11

Specification 11

Periodic Inspection and Cleaning 14

CHAPTER 2

Preparing for Router Installation 15

Preparing for Router Installation 15

Safety Recommendations 15

Safety With Electricity	15
Preventing Electrostatic Discharge Damage	16
General Site Requirements	16
Site Selection Guidelines	17
Rack Requirements	17
Router Environmental Requirements	17
Power Guidelines and Requirements	18
Network Cabling Specifications	18
Console Port Connections	18
EIA/TIA-232	18
USB Serial Console	19
Console Port Considerations	19
Preparing for Network Connections	20
Ethernet Connections	20
Required Tools and Equipment for Installation and Maintenance	20
Installation Checklist	21
Creating a Site Log	22

CHAPTER 3**Installing and Connecting the Router 23**

Installing and Connecting the Router	23
Safety Warnings	23
What You Need to Know	23
Before You Begin	24
Unpacking the Router	24
Installing the Router	24
Installing a Cisco 1100 Series ISR	24
Attaching the Chassis	25
Mounting on the Wall	25
Attaching DIN Rail Brackets	28
Mounting the Router in a Rack	30
Setting the Chassis on a Desktop	31
Chassis Grounding	31
Connecting to a Console Terminal or Modem	32
Connecting to the Serial Port with Microsoft Windows	33
Connecting to the Console Port with Mac OS X	34

Connecting to the Console Port with Linux	34
Installing the Cisco Microsoft Windows USB Device Driver	35
Installing the Cisco Microsoft Windows XP USB Driver	35
Installing the Cisco Microsoft Windows 2000 USB Driver	36
Installing the Cisco Microsoft Windows Vista USB Driver	36
Installing the Cisco Microsoft Windows 8/Windows 10 USB Driver	36
Uninstalling the Cisco Microsoft Windows USB Driver	37
Uninstalling the Cisco Microsoft Windows XP and 2000 USB Driver	37
Uninstalling the Cisco Microsoft Windows Vista USB Driver	38
Connecting WAN and LAN Interfaces	38
Ports and Cabling	39
Connection Procedures and Precautions	39

CHAPTER 4

ROM Monitor Overview and Basic Procedures	41
ROM Monitor Overview and Basic Procedures	41
ROM Monitor Overview	41
Entering ROM Monitor Mode	42
Checking the Current ROMmon Version	42
Commonly Used ROM Monitor Commands	43
Displaying the Available ROM Monitor Commands	43
Examples	44
Changing the ROM Monitor Prompt	44
Displaying the Configuration Register Setting	44
Environment Variable Settings	45
Frequently Used Environmental Variables	45
Displaying Environment Variable Settings	45
Entering Environment Variable Settings	46
Saving Environment Variable Settings	46
Exiting ROM Monitor Mode	46
Configuration Example	47
Upgrading the ROMmon for a Router	47

CHAPTER 5

Installing and Upgrading Internal Modules and FRUs	49
Installing and Upgrading Internal Modules and FRUs	49
Safety Warnings	49

- Accessing Internal Modules 49
 - Replacing the Chassis Cover 50
 - Removing the Cover 50
 - Replacing the Cover 51
- Locating Internal and External Slots for Modules 51
 - Installing the Internal PoE Daughter Card 52
 - Removing and Replacing the Internal PoE Daughter Card 53
- Removing and Replacing the USB Flash Token Memory Stick 53
- AC Power Supplies 54
 - Overview of the AC Power Supply 54
- Installing and Removing SFP Modules 54
 - Installing SFPs 61
 - Removing SFP Modules 61



Preface

- [Audience, page vii](#)
- [Document Organization, page vii](#)
- [Document Conventions, page viii](#)
- [Related Documentation, page ix](#)
- [Obtaining Documentation and Submitting a Service Request, page x](#)

Audience

This guide is intended for Cisco equipment providers and service personnel who are technically knowledgeable and familiar with Cisco routers and Cisco IOS software and features. They would understand how to install, configure, and maintain the router, and they should be familiar with electronic circuitry and wiring practices, and have experience as an electronic or electromechanical technician. This guide identifies certain procedures that should be performed only by trained and qualified personnel.

Document Organization

This guide includes the following chapters and appendix::

Chapter//Appendix	Title	Description
Chapter 1	<i>Overview of the Cisco 1100 Series ISR</i>	Describes the router chassis views, general hardware features, slot, port and interface information, and LED indicators.
Chapter 2	<i>Preparing for Router Installation</i>	Describes site requirements and the equipment needed to install the router.
Chapter 3	<i>Installing and Connecting the Router</i>	Describes how to install and connect the router to LAN and WAN.

Chapter//Appendix	Title	Description
Chapter 4	<i>ROM Monitor Overview and Basic Procedures</i>	Provides an overview of ROM Monitor concepts and operations.
Chapter 5	<i>Installing and Upgrading Internal Modules and FRUs</i>	Describes how to install and upgrade internal modules and field replaceable units ¹ on the router.

¹ Field Replaceable Unit

Document Conventions

This document uses the following conventions:

Convention	Description
^ or Ctrl	Both the ^ symbol and Ctrl represent the Control (Ctrl) key on a keyboard. For example, the key combination ^D or Ctrl-D means that you hold down the Control key while you press the D key. (Keys are indicated in capital letters but are not case sensitive.)
bold font	Commands and keywords and user-entered text appear in bold font .
<i>Italic font</i>	Document titles, new or emphasized terms, and arguments for which you supply values are in <i>italic font</i> .
Courier font	Terminal sessions and information the system displays appear in <code>courier font</code> .
Bold Courier font	Bold Courier font indicates text that the user must enter.
[x]	Elements in square brackets are optional.
...	An ellipsis (three consecutive nonbolded periods without spaces) after a syntax element indicates that the element can be repeated.
	A vertical line, called a pipe, indicates a choice within a set of keywords or arguments.
[x y]	Optional alternative keywords are grouped in brackets and separated by vertical bars.
{x y}	Required alternative keywords are grouped in braces and separated by vertical bars.

Convention	Description
[x {y z}]	Nested set of square brackets or braces indicate optional or required choices within optional or required elements. Braces and a vertical bar within square brackets indicate a required choice within an optional element.
string	A nonquoted set of characters. Do not use quotation marks around the string or the string will include the quotation marks.
< >	Nonprinting characters such as passwords are in angle brackets.
[]	Default responses to system prompts are in square brackets.
!, #	An exclamation point (!) or a pound sign (#) at the beginning of a line of code indicates a comment line.

Reader Alert Conventions

This document uses the following conventions for reader alerts:



Note

Means *reader take note*. Notes contain helpful suggestions or references to material not covered in the manual.



Tip

Means *the following information will help you solve a problem*.



Caution

Means *reader be careful*. In this situation, you might do something that could result in equipment damage or loss of data.



Timesaver

Means *the described action saves time*. You can save time by performing the action described in the paragraph.



Warning

Means *reader be warned*. In this situation, you might perform an action that could result in bodily injury.

Related Documentation

For related release documentation, see the following URLs:

Cisco 1100 Series ISR Release Notes: <https://www.cisco.com/c/en/us/td/docs/routers/access/1100/release/16-6-2/isr1k-rel-notes-xe-16-6.html>

Cisco 1100 Series ISR Configuration Guide - https://www.cisco.com/c/en/us/td/docs/routers/access/1100/software/configuration/guide/cisco_1100_series_swcfg.html

Obtaining Documentation and Submitting a Service Request

For information on obtaining documentation, submitting a service request, and gathering additional information, see What's New in Cisco Product Documentation at: <http://www.cisco.com/en/US/docs/general/whatsnew/whatsnew.html>.

Subscribe to What's New in Cisco Product Documentation, which lists all new and revised Cisco technical documentation, as an RSS feed and deliver content directly to your desktop using a reader application. The RSS feeds are a free service.



Overview of Cisco 1100 Series Integrated Services Routers

- [Overview](#) , page 1

Overview

Cisco 1100 Series Integrated Services Routers (ISRs) with Cisco IOS XE Software combine Internet access, comprehensive security, and wireless services (LTE Advanced 3.0, Wireless WAN and Wireless LAN), are high-performance devices that are easy to deploy and manage. They are well suited for deployment as customer premises equipment (CPE) in enterprise branch offices, and in service provider managed-service environments.

These ISRs are the industry leader in bringing enterprise-grade wired-line-like functionality such as quality of service (QoS) for cellular, Multi-VRF, advanced VPN, and unified communications solutions over LTE.

The 1100 Series also provides the ability to extend Cisco product-based networks to remote offices with a relatively low incremental investment, as well as to enable managed services offerings based on end-to-end Cisco system architecture.

About Cisco 1100 Series Integrated Service Routers

The Cisco 1100 Series ISRs are fixed branch routers based on the Cisco IOS XE Everest 16.6.2 operating system, with a multi-core Data Plane.

The two types of platforms supported on Cisco 1100 Series ISRs are 8-port and 4-port platforms.

8-port platforms are high-performance, managed service provider and enterprise platforms having:

- 8-port integrated front panel switch ports
- Optional PoE on LAN daughter card with support up to 4PoE/2PoE+ports
- Optional WLAN support - 802.11ac WAVE 2
- 4G LTE-Advanced support with carrier aggregation

4-port platforms are midrange performance, managed service provider platforms and enterprise platforms having:

- 4-port integrated front panel switch ports
- VDSL2 and ADSL2/2+ support
- Optional POE on LAN daughter card supporting 2PoE/1PoE+ ports
- Optional WLAN support - 802.11ac WAVE 2
- 4G LTE-Advanced support with carrier aggregation

Chassis Views

This section contains views of the front and back panels of the Cisco 1100 Series ISR, showing locations of the power and signal interfaces, interface slots, status indicators, and chassis identification labels.

Bezel View

Figure 1: Cisco 1100 Series ISR - Bezel View

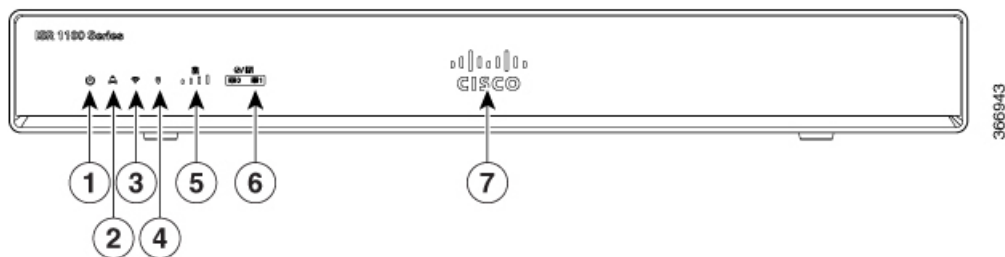

1	Status	2	VPN
3	WiFi	4	GPS
5	LTE Signal Intensity	6	LTE Data/SIM
7	Illuminated Cisco Logo		

I/O View

Figure 2: Cisco 1100 Series ISR - I/O Views

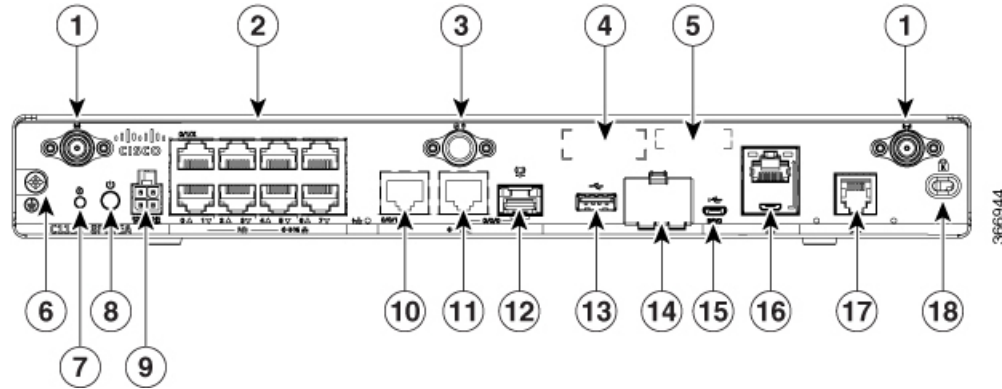

1	LTE Antennas – Main and Diversity	2	LAN
3	GPS Connection	4	CLEI Label
5	Serial Number	6	Grounding
7	Reset Button	8	Power Switch
9	4-pin Power Connector	10	GE 0/0/1
11	GE 0/0/0 - RJ45	12	GE 0/0/0 - SFP
13	USB3.0	14	uSIM*2
15	LTE Provisioning Port	16	RJ45 / Micro USB Console
17	DSL	18	Kensington Lock Slot

Labels on the Router

To obtain a software license, you need a product authorization key (PAK) and the unique device identifier (UDI) of the device where the license will be installed.

Figure shows the location of the labels on the Cisco 1100 Series ISRs:

Figure 3: Labels on the Routers

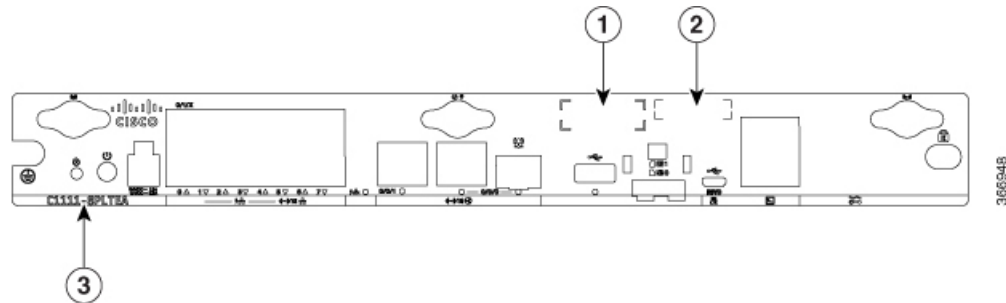

SI. No	Name	Description
1	CLEI Number	Common Language Equipment Identifier (CLEI) number
2	Serial Number	
3	PID Family Name	Product Identification Number

For Additional Help Locating Labels on the Router

Use the Cisco Product Identification (CPI) tool to find labels on the router. The tool provides detailed illustrations and descriptions of where the labels are located on Cisco products. It includes the following features:

- A search option that allows browsing for models by using a tree-structured product hierarchy
- A search field on the final results page that makes it easier to look up multiple products
- End-of-sale products clearly identified in results lists

The tool streamlines the process of locating serial number labels and identifying products. Serial number information expedites the entitlement process and is important for access to support services.

Hardware Features

This section describes the hardware features in the routers.

Interface Ports

The Cisco ISR C1100-8P series comes with 8-Gigabit Ethernet LAN ports, and two WAN ports, with options for one LTE modem and one WLAN interface.

The Cisco ISR C1100-4P series comes with 4-Gigabit Ethernet LAN ports, and two WAN ports, with options for one LTE modem and one WLAN interface.

Power-over-Ethernet (PoE)

The C1100-8P series has 8 Ethernet LAN ports. Four of the Ethernet LAN ports are PoE-capable, LAN ports 0-3. A total of 80W of PoE power is available across the four PoE-capable ports on the C1100-8P series.

The C1100-4P series has 4 Ethernet LAN ports. Two of the Ethernet LAN ports are PoE-capable, LAN ports 0-1. A total of 60W of PoE power is available across the two PoE-capable ports on the C1100-4P series.

Each individual PoE-capable Ethernet LAN port is capable of PoE 802.3af or PoE+ 802.3at functionality. The total number of PoE and/or PoE+ devices that can be enabled on the PoE ports at any one time is a function of the PoE power available from the external power supply. Software will allocate PoE power based on the PoE power requested by the device on each port; and manage the total available power so as not to allocate more power than what is available.

LED Indicators

The following figures and table summarizes the LED indicators that are located in the router bezel or chassis, but not on the interface cards and modules.

Figure 4: LED Indicators - Bezel Side

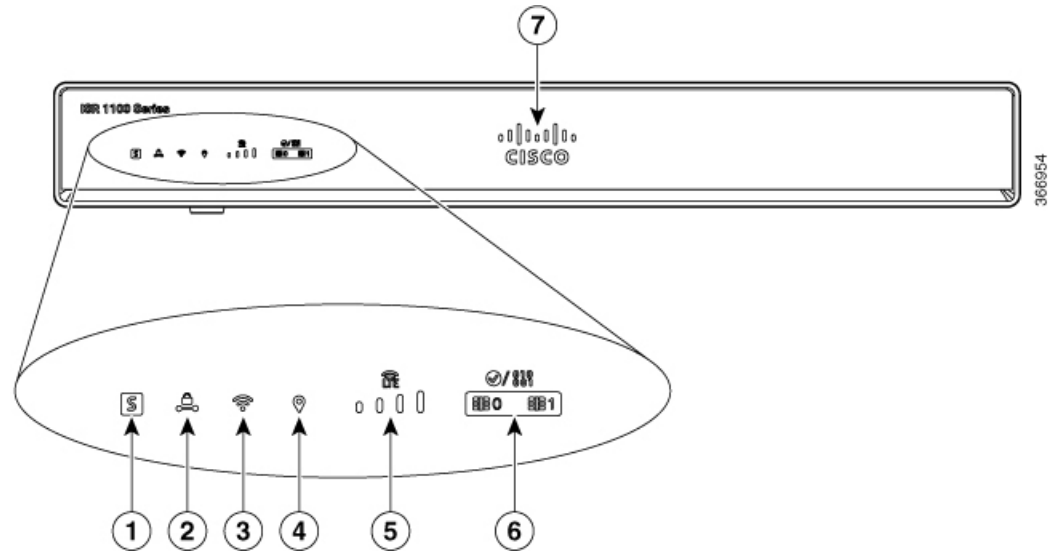

1	Status	2	VPN
3	WLAN	4	GPS
5	LTE RSSI/Mode	6	LTE DATA/SIM
7	Cisco Logo		

Figure 5: LED Indicators - I/O Side

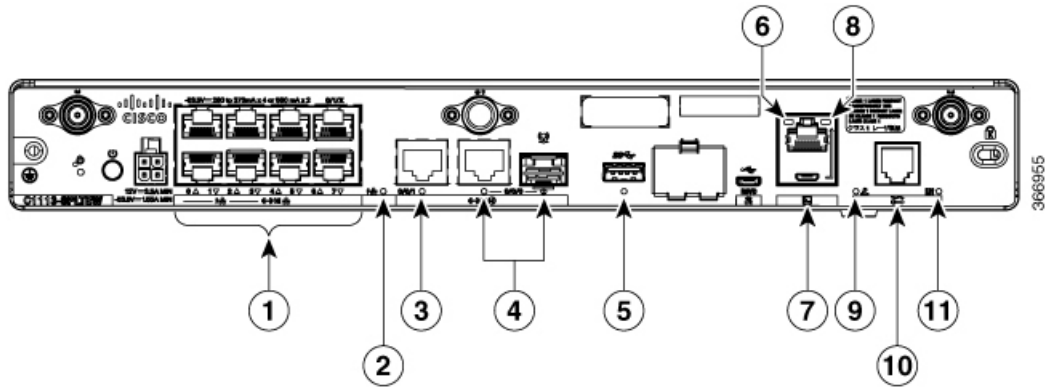

1	GE WAN Ports: 0-7 (0,2,4,6 at the top and 1,3,5,7 at the bottom)	2	PoE LED
3	GE1 LED	4	GE0 LED
5	USB LED	6	RJ-45 Console LED
7	USB Console	8	Micro USB Console LED
9	CD LED	10	DSL
11	DATA LED		

Table 1: LED Indicators - Description

Port	LED Color	Description	Location
Cisco Logo	Blue	Bezel illuminated Cisco logo. Indicates router power is good.	Bezel side

Port	LED Color	Description	Location
STATUS (System Status)	Green and Amber	Steady Green - System operates normally	Bezel side. All models.
		Off—System is not out of reset; or BIOS image is not loadable.	
		Blinking Amber — BIOS/Rommon is booting.	
		Steady Amber — BIOS/Rommon has completed booting, and the system is at the Rommon prompt or booting the platform software.	
VPN OK	Green	Off—No tunnel.	Bezel side
		Steady On— at least one tunnel is up	
LTE RSSI/Mode	Green and Amber	No LEDs On—No Service	Bezel Side
		1 LED On— RSSI is under -100dBm	
		2 LEDs On— Low RSSI, -99dbm \diamond -90dBm	
		3 LEDs On— Medium RSSI -89dBm \diamond -70dBm	
		4 LEDs On— High RSSI, > -69dBm	
		Green— LTE	
		Amber— 3G	

Port	LED Color	Description	Location
GPS	Green and Amber	Amber— Assisted GPS (Reserved for Future Use)	Bezel Side
		Green— Standalone GPS	
		Off— GPS not configured	
		On— GPS configured	
		Blink— GPS Acquiring	
LTE DATA/SIM	Green and Amber	Single LTE Modem (one modem with SIM switch-over capability)	Bezel Side
		Off— Modem not up or modem up and no SIM	
		Amber Steady On— Modem up, SIM installed but not active.	
		Green Steady On— Modem up, SIM installed and active.	
		Green Blink— LTE data activity.	
WLAN	Green, Red, and Amber	Green— Normal operating condition with at least one wireless client association.	Bezel side
		Red—Ethernet link is not operational or Ethernet failure.	
		Amber—Software upgrade is in progress.	
Ethernet Switch GE LAN Ports, Non-PoE	Green	Off— No link	I/O side
		Steady On— link	
		Blink— TXD/RXD data	

Port	LED Color	Description	Location
Ethernet Switch GE LAN Ports, with PoE	Green and Amber	Off— No link, no device powered, PD denied power, power delivery fault PoE administratively disabled.	I/O side
		Green Steady On— link; if PoE device, power is enabled.	
		Green Blink— TXD/RXD data	
		Amber - PoE Fault	
GE WAN Ports	Green	Off— No link	I/O side
		Steady On— link	
		Blink— TXD/RXD data	
DSL CD	Green	Off— Shut	I/O Side
		Green Blink— Training, or no shut and cable disconnected.	
		Green Steady On— Trained	
PoE OK	Green	Green Steady On— -53.5V PoE power supply connected and all powered port operating normally.	I/O Side
		Off— No -53.5V PoE power supply connected to router.	
DSL Data	Green	Off— No Data Activity	I/O Side
		Green Blink— TX/RX Data	

Port	LED Color	Description	Location
Console/AUX	Green and Amber	Green On— Console enabled.	I/O side
		Amber On— AUX enabled.	
USB Console	Green	Off— No USB device discovered.	I/O side
		On— USB device discovered.	
USB	Green	Off: No USB device discovered.	I/O Side
		On: USB device discovered.	

Reset Button

The actuation of the Reset button is only recognized during Rommon boot, that is, as the router comes to the Rommon prompt.

The Reset button does not require much force to be actuated. The Reset button should be actuated only with a small implement such as the tip of a pen or a paper clip. When the Reset button is pressed at startup, the system LED will turn green.

For more information, see the "Reset Overview" section of the Cisco 1100 Series Software Configuration Guide.

Slots and Interfaces

About Slots, Subslots, and Port Numbering

Cisco 1100 Series ISRs do not support physical and removable modules. It has only one slot, that is, slot 0. Slot 0 is the motherboard and not removable. It is reserved for integrated ports. The front panel GE ports (or native interface ports) always reside in slot 0 and bay 0. The ports are called Gigabitethernet 0/0/0 and Gigabitethernet 0/0/1.

Each interface type has its own 'bay', and port is a unique port of an interface type.

In most cases, the router designates its interfaces using a 3-tuple notation that lists the slot, bay, and port. The 3-tuple value is zero based. An example of a 3-tuple is 0/1/2. This refers to slot 0, the second bay in slot 0 (the first bay is 0 so the second bay is 1), and the third port in bay 1. See this section for more examples.

Table 2: Slot, Bay, and Port Numbering

3- Tuple Example	Slot	Bay	Port
0/1/2	0	2nd	3rd
0/0/1	0	1st	2nd

Subslot/Bay Numbering

All interfaces are integrated interfaces. There is only one Bay, and the interface 'Type' is defined by a slot number. In this example there is only one slot, 0, and each interface is a bay:

```

Bay 0 Ethernet WAN
Bay 1 Ethernet LAN (Switch)
Bay 2 LTE
Bay 3 DSL
Bay 4 WiFi

Chassis type: C1117-4PLTEEAW

Slot Type State Insert time (ago)
-----
0 C1117-4PLTEEAW ok 00:05:58
0/0 C1117-1x1GE ok 00:03:03
0/1 C1117-ES-4 ok 00:03:01
0/2 C1117-LTE ok 00:02:52
0/3 C1117-VADSL-A ok 00:01:56
0/4 ISR-AP1100AC-E ok 00:03:13
    
```

Specification

The following table provide Cisco 1100 ISR specification:

Table 3: Cisco 1100 Series ISR Specification

Description	Specification
Physical Properties	
Dimensions (H x W x D)	Non-LTE models: H x W X D = 1.75 x 12.7 x 9.03 in. (42 x 323 x 230mm) (includes rubber feet)
	LTE models: H x W X D = 1.75 x 12.7 x 9.6 in. (44 x 323 x 244 mm) (includes rubber feet)
Weight with AC PS (w/o modules)	5.5 Lbs. (2.5 kg) maximum
AC Input Power	

Description	Specification
Input voltage	Universal 100 to 240 VAC
Frequency	50-60 Hz
Input current	PoE not enabled: 0.82A maximum PoE enabled: 1.55A Maximum
Surge current	90 A peak and less than 8 Arms per half cycle
Ports	
Micro USB Port	One RJ-45: Separate console port
USB port	USB 3.0 Type A host port USB devices supported: <ul style="list-style-type: none"> • USB flash memory
Console port	One USB 5-pin micro Type B: Console management connectivity
10/100/1000 Gigabit Ethernet	Two GE ports allocated among RJ45 and SFP as: One combo port with 10/100/1000RJ-45 Ethernet port or SFP Ethernet port (labeled GE0/0/0) One dedicated 10/100/1000RJ-45 Ethernet port (labeled GE0/0/1)
Wireless VLANs	32 (encrypted and non-encrypted VLANs)
Wireless specifications	2x2 .11ac Wave 2
Default and maximum DRAM	4GB
Default and maximum flash	4GB
Inline PoE	4 ports for -8P PIDs, 2 ports for -4P PIDs 802.3af-compliant PoE or 802.3at-compliant PoE+
Acoustic for Cisco 1100 Series ISRs	Not Applicable - Fanless design

Description	Specification
Approvals and compliance	<ul style="list-style-type: none"> • Emission • 47 CFR Part 15 • <ul style="list-style-type: none"> ◦ CISPR 32 Edition 2 ◦ EN 300 386 V1.6.1 ◦ EN 55032:2012/ AC:2013 ◦ EN 55032:2015 ◦ EN61000-3-2 2014 ◦ EN61000-3-3: 2013 ◦ ICES-003 ISSUE 6:2016 ◦ KN 32: 2015 ◦ V-2/2015.04 ◦ V-3/2015.04 ◦ TCVN 7189: 2009 ◦ CNS13438: 2006 ◦ IEC 60950-1 ◦ EN 60950-1 ◦ UL 60950-1 ◦ CSA C22.2 No. 60950-1 • Immunity <ul style="list-style-type: none"> ◦ CISPR24: 2010 + A1: 2015 ◦ EN 300 386 V1.6.1 ◦ EN55024: 2010 + A1: 2015 ◦ KN35: 2015 ◦ TCVN 7317: 2003

Table 4: Environmental Specification

Description	Specification
Environmental	
Operating humidity	5 to 85% relative humidity

Description	Specification
Operating temperature	32 to 104°F (0 to 40°C) Sea Level; 32 to 77°F (0°C to 25°C) at 10,000 ft 1.5°C derating per 1000 ft
Altitude in China	0-6560 ft (0-2000 m)
Altitude in all other countries	0-10,000 ft (0-3050 m)
Transportation and Storage	
Nonoperating temperature	-40 to 158°F (-40 to 70°C)
Nonoperating humidity	5 to 95% relative humidity (noncondensing)
Nonoperating altitude	0 to 15,000 ft (0 to 4570m)

Periodic Inspection and Cleaning

Periodic inspection and cleaning of the external surface of the router is recommended to minimize the negative impact of environmental dust or debris. The frequency of inspection and cleaning is dependent upon the severity of the environmental conditions, but a minimum of every six months is recommended. Cleaning involves vacuuming of router air intake and exhaust vents.



Note

Sites with ambient temperatures consistently above 25°C or 77°F and with potentially high levels of dust or debris might require periodic preventative maintenance cleaning.



Preparing for Router Installation

- [Preparing for Router Installation, page 15](#)

Preparing for Router Installation

This document provides pre-installation information, such as recommendations and requirements that should be before installing your router. See the following sections to prepare for installation:

Safety Recommendations



Warning

This warning symbol means danger. You are in a situation that could cause bodily injury. Before you work on any equipment, be aware of the hazards involved with electrical circuitry and be familiar with standard practices for preventing accidents. Use the statement number provided at the end of each warning to locate its translation in the translated safety warnings that accompanied this device



Note

SAVE THESE INSTRUCTIONS Statement 1071.



Warning

Ultimate disposal of this product should be handled according to all national laws and regulations. Statement 1040.

Safety With Electricity



Warning

Do not work on the system or connect or disconnect cables during periods of lightning activity. Statement 1001

**Warning**

Installation of the equipment must comply with local and national electrical codes. Statement 1074

**Warning**

Only trained and qualified personnel should be allowed to install or replace this equipment Statement 1030

**Warning**

There is the danger of explosion if the battery is replaced incorrectly. Replace the battery only with the same or equivalent type recommended by the manufacturer. Dispose of used batteries according to the manufacturer's instructions. Statement 1015

Preventing Electrostatic Discharge Damage

Electrostatic discharge (ESD) can damage equipment and impair electrical circuitry. It can occur if electronic printed circuit cards are improperly handled and can cause complete or intermittent failures. Always follow ESD prevention procedures when removing and replacing modules:

- Ensure that the router chassis is electrically connected to ground.
- Wear an ESD-preventive wrist strap, ensuring that it makes good skin contact. Connect the clip to an unpainted surface of the chassis frame to channel unwanted ESD voltages safely to ground. To guard against ESD damage and shocks, the wrist strap and cord must operate effectively.
- If no wrist strap is available, ground yourself by touching a metal part of the chassis.

**Caution**

For the safety of your equipment, periodically check the resistance value of the anti-static strap. It should be between 1 and 10 megohms (Mohm).

General Site Requirements

This section describes the requirements your site must meet for safe installation and operation of your router. Ensure that the site is properly prepared before beginning installation. If you are experiencing shutdowns or unusually high errors with your existing equipment, this section can also help you isolate the cause of failures and prevent future problems.

**Warning**

This product relies on the building's installation for short-circuit (overcurrent) protection. Ensure that the protective device is rated not greater than: 20A. Statement 1005

**Warning**

To prevent the system from overheating, do not operate it in an area that exceeds the maximum recommended ambient temperature of: 40 degrees C. Statement 1047

Site Selection Guidelines

The Cisco 1100 Series ISRs require specific environmental operating conditions. Temperature, humidity, altitude, and vibration can affect the performance and reliability of the router. The following sections provide specific information to help you plan for the proper operating environment.

The Cisco 1100 Series ISRs are designed to meet the industry EMC, safety, and environmental standards described in the Regulatory Compliance and Safety Information for the Cisco 1100 Series ISRs document.

Rack Requirements

Cisco 1100 Series ISRs require brackets for use with a 19-inch rack.

The following information can help you plan your equipment rack configuration:

- Allow clearance around the rack for maintenance.
- Allow at least one rack unit of vertical space between routers; more clearance is required when stacking multiple Cisco 1100 Series ISRs. Provide adequate heat removal mechanism to keep the surrounding air temperature well within the specified operating temperature condition.



Note More spacing may be required depending on the installation environment.

- Enclosed racks must have adequate ventilation. Ensure that the rack is not congested, because each router generates heat. An enclosed rack should have louvered sides and a fan to provide cooling air. Heat generated by equipment near the bottom of the rack can be drawn upward into the intake ports of the equipment above it.
- When mounting a chassis in an open rack, ensure that the rack frame does not block the intake or exhaust ports. If the chassis is installed on slides, check the position of the chassis when it is seated in the rack.

Router Environmental Requirements

Cisco 1100 Series ISRs can be placed on a desktop, installed in a rack, or mounted on a wall. The location of your router and the layout of your equipment rack or wiring room are extremely important considerations for proper operation. Equipment placed too close together, inadequate ventilation, and inaccessible panels can cause malfunctions and shutdowns, and can make maintenance difficult. Plan for access to both front and rear panels of the router.

When planning your site layout and equipment locations, refer to the General Site Requirements , section. If you are currently experiencing shutdowns or an unusually high number of errors with your existing equipment, these precautions and recommendations may help you isolate the cause of failure and prevent future problems.

- Ensure that the room where your router operates has adequate air circulation. Electrical equipment generates heat. Without adequate air circulation, ambient air temperature may not cool equipment to acceptable operating temperatures.
- Always follow ESD-prevention procedures described in the Preventing Electrostatic Discharge Damage to avoid damage to equipment. Damage from static discharge can cause immediate or intermittent equipment failure.

- Baffles can help to isolate exhaust air from intake air, which also helps to draw cooling air through the chassis. The best placement of the baffles depends on the airflow patterns in the rack, which can be found by experimenting with different configurations.
- When equipment installed in a rack (particularly in an enclosed rack) fails, try operating the equipment by itself, if possible. Power off other equipment in the rack (and in adjacent racks) to allow the router under test a maximum of cooling air and clean power.

Power Guidelines and Requirements

Check the power at your site to ensure that you are receiving “clean” power (free of spikes and noise). Install a power conditioner if necessary.

Power Guidelines and Requirements lists power requirements for the Cisco 1100 Series ISRs.

Table 5: Power Requirements for Cisco 1100 Series ISRs

Power Source	Input Rated	Output Rated
66W AC Power Adapter (341-100346-01)	100-240V, 0.82A - 0.35A	12 VDC, 5.5A
125W AC Power Adapter (341-0502-01)	100-240 VAC, 1.55A – 0.65A, 50-60 Hz	12VDC, 3.5A; -53.5Vdc, 1.55A
115W AC Power Adapter (341-100765-01)	100-240VAC, 1.43A - 0.60A, 50-60 Hz	12VDC, 4.7A; -53.5VDC, 1.2A

Network Cabling Specifications

The following sections describe the cables needed to install your Cisco 1100 Series ISR in the following sections:

Console Port Connections

The router has both EIA/TIA-232 asynchronous (RJ-45) and USB 5-pin micro Type B, 2.0 compliant serial console ports. The console ports do not have any hardware flow control. Shielded USB cables with properly terminated shields are recommended.

EIA/TIA-232

Depending on the cable and the adapter used, this port appears as a DTE or DCE device at the end of the cable. Only one port can be used at the same time.

The default parameters for the console port are 9600 baud, 8 data bits, 1 stop bit, and no parity. The console port does not support hardware flow control. For detailed information about installing a console terminal, see the Connecting to a Console Terminal or Modem section.

For cable and port pinouts, see the Cisco Modular Access Router Cable Specifications document located on Cisco.com.

USB Serial Console

The USB serial console port connects directly to the USB connector of a PC using a USB Type A to 5-pin micro USB Type-B cable. The USB Console supports full speed (12Mb/s) operation. The console port does not support hardware flow control.



Note Always use shielded USB cables with a properly terminated shield.

The default parameters for the console port are 9600 baud, 8 data bits, no parity, and 1 stop bit. For detailed information about installing a console terminal, see the Connecting to a Console Terminal or Modem section on page 3-19.

For operation with a Microsoft Windows OS version older than Windows 7, the Cisco Windows USB Console Driver must be installed on any PC connected to the console port. If the driver is not installed, prompts guide you through a simple installation process.

The Cisco Windows USB Console Driver allows plugging and unplugging the USB cable from the console port without affecting Windows HyperTerminal operations. No special drivers are needed for Mac OS X or Linux.

Only one console port can be active at a time. When a cable is plugged into the USB console port, the RJ-45 port becomes inactive. Conversely, when the USB cable is removed from the USB port, the RJ-45 port becomes active.

Baud rates for the USB console port are 1200, 2400, 4800, 9600, 19200, 38400, 57600, and 115200 bps.



Note 4-pin micro USB Type-B connectors are easily confused with 5-pin micro USB Type-B connectors. Only the 5-pin micro USB Type-B is supported.

USB Console OS Compatibility

- Windows 10, Windows 8, Windows 7, Windows 2000, Window XP 32 bit, Windows Vista 32 bit
- Mac OS X version 10.5.4
- Redhat / Fedora Core 10 with kernel 2.6.27.5-117
- Ubuntu 8.10 with kernel 2.6.27-11
- Debian 5.0 with kernel 2.6
- Suse 11.1 with kernel 2.6.27.7-9

Console Port Considerations

The router includes an asynchronous serial console port. The console ports provide access to the router using a console terminal connected to the console port. This section discusses important cabling information to consider before connecting the router to a console terminal or modem.

Console terminals send data at speeds slower than modems do; therefore, the console port is ideally suited for use with console terminals.

Preparing for Network Connections

When setting up your router, consider distance limitations and potential electromagnetic interference (EMI) as defined by the applicable local and international regulations.

Network connection considerations are provided for:

See the following online document for more information about network connections and interfaces:

- Cisco Modular Access Router Cable Specifications

Ethernet Connections

The IEEE has established Ethernet as standard IEEE 802.3. The routers support the following Ethernet implementations:

- 1000BASE-T—1000 Mb/s full-duplex transmission over a Category 5 or better unshielded twisted-pair (UTP) cable. Supports the Ethernet maximum length of 328 feet (100 meters).
- 100BASE-T—100 Mb/s full-duplex transmission over a Category 5 or better unshielded twisted-pair (UTP) cable. Supports the Ethernet maximum length of 328 feet (100 meters).
- 10BASE-T—10 Mb/s full-duplex transmission over a Category 5 or better unshielded twisted-pair (UTP) cable. Supports the Ethernet maximum length of 328 feet (100 meters).

See the Cisco Modular Access Router Cable Specifications document at Cisco.com for information about Ethernet cables, connectors, and pinouts.

Required Tools and Equipment for Installation and Maintenance

You need the following tools and equipment to install and upgrade the router and its components:

- ESD-preventive cord and wrist strap
- Number 2 Phillips screwdriver
- Phillips screwdrivers: small, 3/16-in. (4 to 5 mm) and medium, 1/4-in. (6 to 7 mm)
 - To install or remove modules
 - To remove the cover, if you are upgrading memory or other components
- Screws that fit your rack
- Wire crimper
- Wire for connecting the chassis to an earth ground:
 - AWG 14 (2 mm 2) or larger wire for NEC-compliant chassis grounding
- For NEC-compliant grounding, an appropriate user-supplied ring terminal, with an inner diameter of 1/4 in. (5 to 7 mm)

Installation Checklist

The sample installation checklist lists items and procedures for installing a new router. Make a copy of this checklist and mark the entries when completed. Include a copy of the checklist for each router in your site log (described in the next section, Creating a Site Log).

Table 6: Checklist

Task	Verified By	Date
Installation checklist copied		
Background information placed in Site Log		
Site power voltages verified		
Installation site power check completed		
Required tools available		
Additional equipment available		
Router received		
Router quick start guide received		
Regulatory Compliance and Safety Information for the Cisco 1100 Series ISRs document received		
Product registration card received		
Cisco.com contact information label received		
Chassis components verified		
Initial electrical connections established		
ASCII terminal (for local configuration) or modem (for remote configuration) available		
Signal distance limits verified		
Startup sequence steps completed		

Task	Verified By	Date
Initial operation verified		
Software image verified		

Creating a Site Log

The Site Log provides a record of all actions related to the router. Keep it in an accessible place near the chassis where anyone who performs tasks has access to it. Use the installation checklist to verify steps in the installation and maintenance of the router. Site Log entries might include the following information:

- Installation progress—Make a copy of the installation checklist and insert it into the site log. Make entries as each procedure is completed.
- Upgrade and maintenance procedures—Use the site log as a record of ongoing router maintenance and expansion history. A site log might include the following events:
 - Removal or replacement of PoE daughter card
 - Configuration changes
 - Maintenance schedules and requirements
 - Maintenance procedures performed
 - Intermittent problems
 - Comments and notes

Inspect all items for shipping damage. If anything appears to be damaged or if you encounter problems installing or configuring your router, contact customer service. Warranty, service, and support information is in the quick start guide that shipped with your router, or in the Preface of this guide. See the Obtaining Documentation and Submitting a Service Request section.



Installing and Connecting the Router

- [Installing and Connecting the Router, page 23](#)

Installing and Connecting the Router

This document describes how to install and connect the Cisco 1100 Series Integrated Services Routers (ISRs) to LAN and WAN networks. The following sections provide technical details.

Safety Warnings



Warning

Read the installation instructions before using, installing or connecting the system to the power source. Statement 1004

What You Need to Know

CLI Console Access

Use the USB or RJ-45 console port on the router to access the Cisco Internet Operating System (IOS-XE) command line interface (CLI) on the router and perform configuration tasks. A terminal emulation program is required to establish communication between the router and a PC. See the Connecting to a Console Terminal or Modem for instructions.



Note

A Microsoft Windows USB driver must be installed before you establish physical connectivity between the router and the PC.

Slot and Port Numbers

The routers have built in ports and slots. See the About Slots and Interfaces section for slot and port numbering.

Software Licenses

To use all the features on the router, you must purchase a software package.

See the Licensing section of the Software Configuration Guide for the Cisco 1100 Series ISRs for more information.

Before You Begin

Before installing and connecting a Cisco Integrated Services Router, read the safety warnings and gather the following tools and equipment. For more information about the required tools and equipment.

**Note**

For more information on cable specifications, see the Cisco Modular Access Router Cable Specifications document on Cisco.com.

Unpacking the Router

Do not unpack the router until you are ready to install it. If the final installation site will not be ready for some time, keep the chassis in its shipping container to prevent accidental damage. When you are ready to install the router, proceed with unpacking it.

The router, accessory kit, publications, and any optional equipment you ordered may be shipped in more than one container. When you unpack the containers, check the packing list to ensure that you received all of the items on the list.

Installing the Router

If you need to install PoE daughter card, you can install them before you install the router. Ideally, the PoE daughter card should be purchased pre-installed.

There are two methods of installing the router:

**Caution**

To prevent damage to the chassis, never attempt to lift or tilt the chassis by holding it by the plastic panel on the front. Always hold the chassis by the sides of the metal body.

Installing a Cisco 1100 Series ISR

This section describes how to install the Cisco 1100 Series ISR. These routers can be installed on a table top or other flat horizontal surface mounted on a wall or DIN rail.

**Warning**

To prevent airflow restriction, allow clearance around the ventilation openings to be at least 1.75 in. (4.4 cm). Statement 1076

**Warning**

Radiofrequency Exposure - To maintain compliance, installations will assure a separation distance of at least 21.29 cm.

**Note**

More clearance is required when stacking multiple Cisco 1100 ISRs or having heat removal capability to maintain the surrounding air temperature to stay within the specified operating condition.

Attaching the Chassis

The tasks that you perform for attaching the router chassis to the wall or for mounting it in a rack are based on the specific model of the Cisco 1100 Series Integrated Service Router.

The recommended clearance when horizontally mounted is 1.5 inches on both sides for clearance and 1.75 inches on top. I/O side clearance is needed as it is required to access the cable connections. Clearance is not required on the backside (opposite side from I/O face) unless DIN rail mounting is required. Clearance is required to attach and mount the DIN rail bracket.

Mounting on the Wall

The Cisco 1100 Series ISRs have mounting key-hole slots on the bottom of the chassis for mounting the unit on a wall or other vertical surface, as shown in the figure below.

**Note**

The unit must not be mounted with the output ports facing downwards. You must mount the unit with the cables going sideways.

Figure 6: Mounting on the Wall

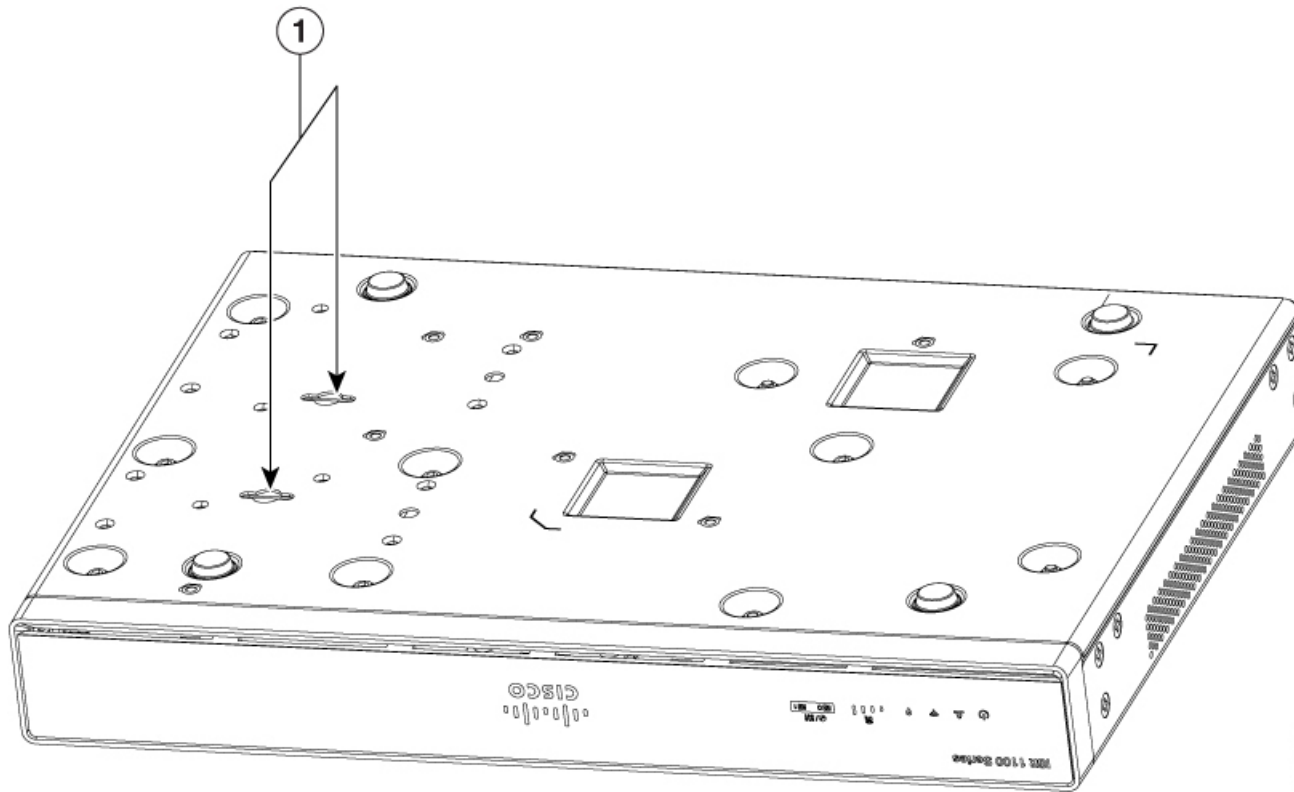

1

Key-hole slots

**Note**

To attach to a wall stud, each bracket requires one number-10 wood screws (round- or pan-head) with number-10 washers, or two number-10 washer-head screws. The screws must be long enough to penetrate at least 1.5 inches (38.1 mm) into the supporting wood or metal wall stud.

**Note**

For hollow-wall mounting, each bracket requires two wall anchors with washers. Wall anchors and washers must be size number 10. Route the cables so that they do not put a strain on the connectors or mounting hardware.

**Note**

When choosing a location for wall-mounting the router, consider cable limitations and wall structure.

The figure below shows the orientation for wall mounting of the router.

Figure 7: Wall-Mount Orientation

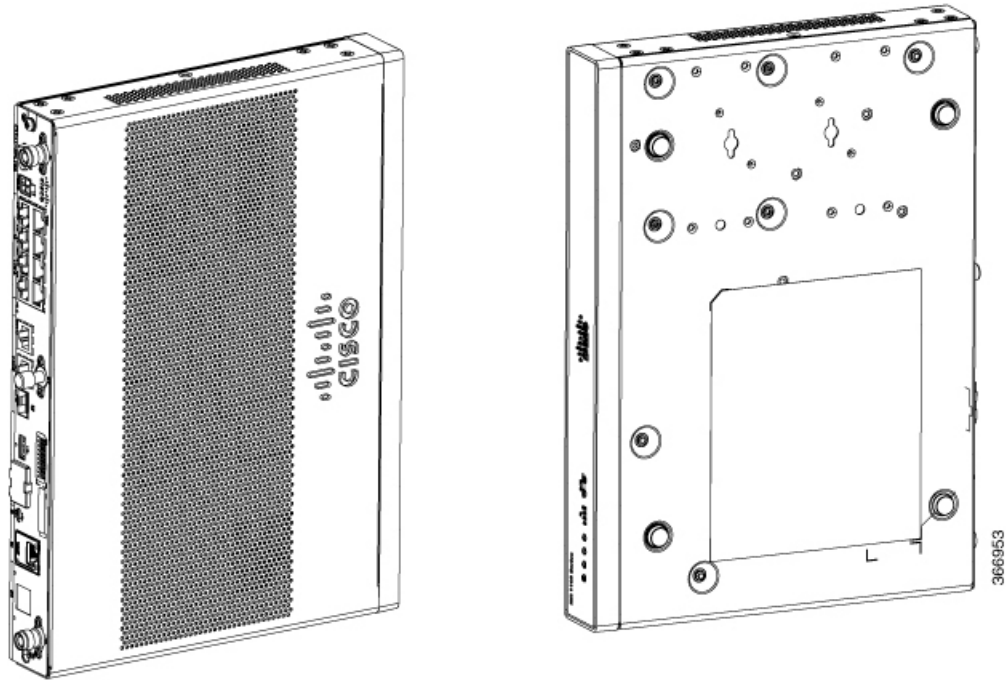

1

Key-hole slots

Attaching DIN Rail Brackets

Step 1: Attach the brackets to the router chassis as shown in the figure below, using the PHMS screws and the plastic spacers provided for each bracket.

Figure 8: DIN Rail Bracket Installation

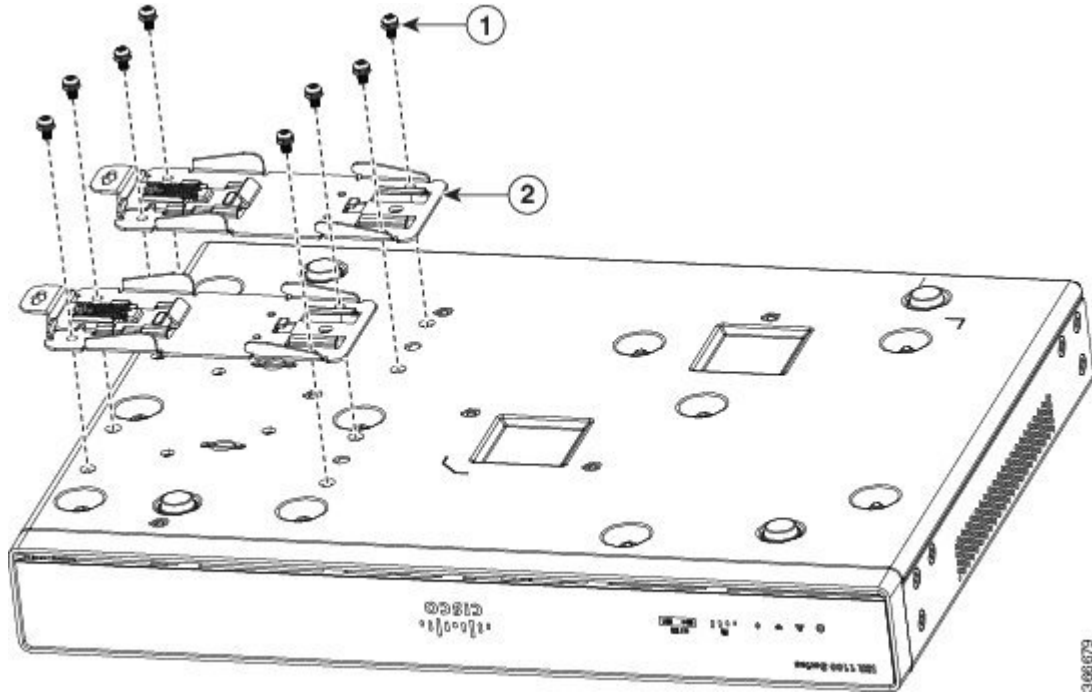

1	Screws
2	DIN Rail Brackets



Note Do not over-torque the screws. The recommended torque is 8 to 10 inch-lbf (.9 to 1.1 N-m).



Note Your chassis installation must allow unrestricted airflow for chassis cooling.

Step 2: Attach the router to the wall using the key-hole slots.

The figure below displays the orientation of the DIN rail bracket.

Figure 9: DIN Rail Bracket Orientation

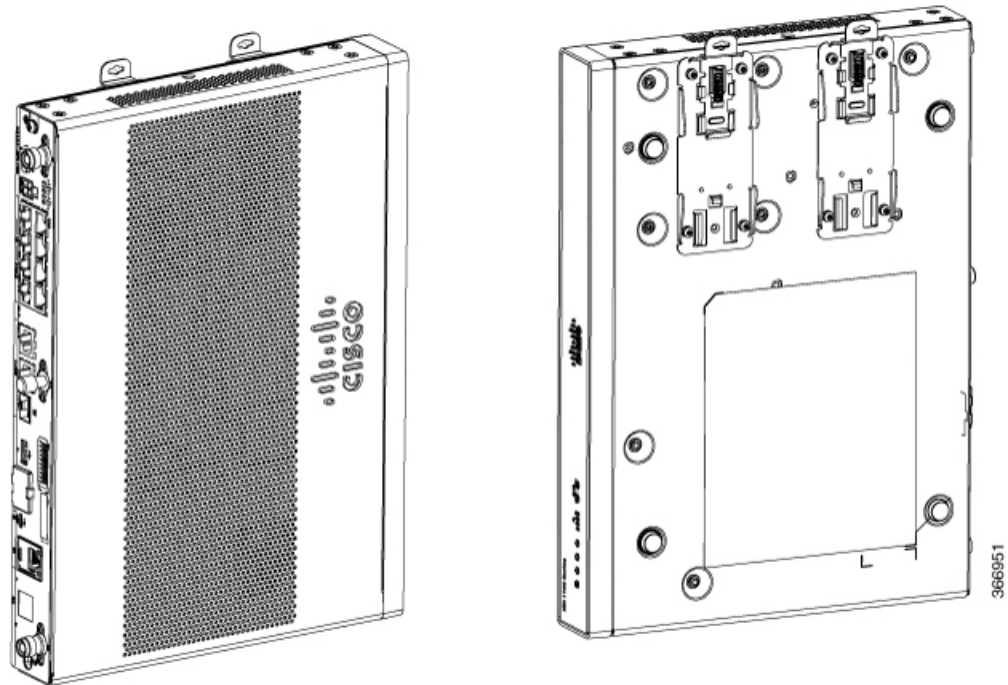

The figure below displays the DIN rail orientation and mount.

Figure 10: DIN Rail Orientation and Mount

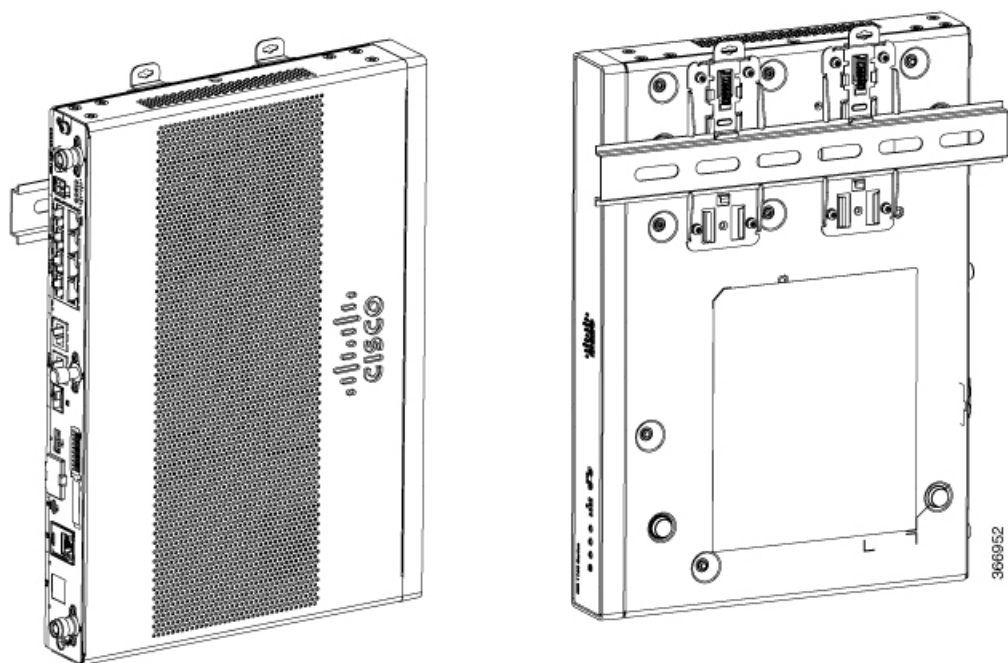

After the router is installed, you must connect the chassis to a reliable earth ground. For the chassis ground connection procedures, see the “Chassis Grounding” section.

Mounting the Router in a Rack

- 1 Attach the brackets to the router chassis (towards the left or right) as shown in figure below.

Figure 11: Bracket Installation for Left-Hand-Mounting

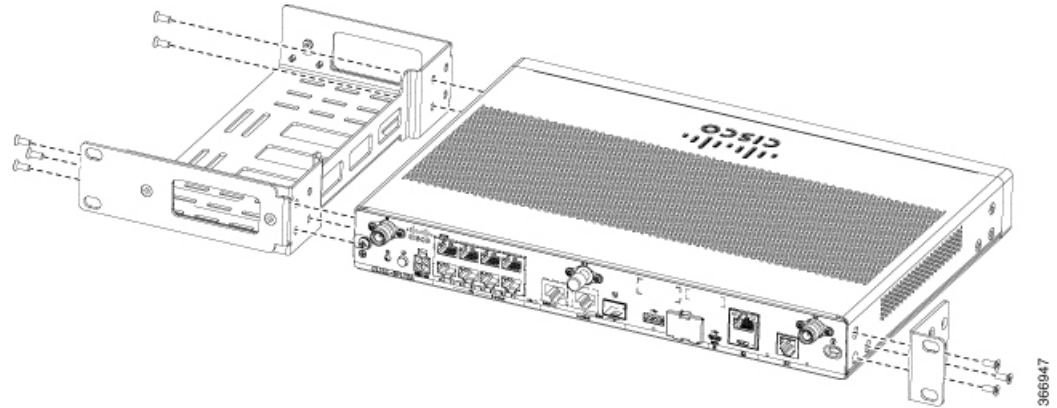

Note

In the similar manner, you can install the bracket on the right-hand for mounting.

- 2 Use the screws provided with the rack to install the chassis in the rack.



Warning

To prevent bodily injury when mounting or servicing this unit in a rack, you must take special precautions to ensure that the system remains stable. The following guidelines are provided to ensure your safety:

- This unit should be mounted at the bottom of the rack if it is the only unit in the rack.
- When mounting this unit in a partially filled rack, load the rack from the bottom to the top with the heaviest component at the bottom of the rack.
- If the rack is provided with stabilizing devices, install the stabilizers before mounting or servicing the unit in the rack. Statement 1006



Warning

Warning To prevent airflow restriction, allow clearance around the ventilation openings to be at least: 1.75 in. (4.4 cm). Statement 1076

After the router is installed, you must connect the chassis to a reliable earth ground. For the chassis ground connection procedures, see the “Chassis Grounding” section.

Setting the Chassis on a Desktop

You can place the router on a desktop, bench top, or shelf.

After the router is installed, you must connect the chassis to a reliable earth ground. For the chassis ground connection procedures, see the Chassis Grounding section.

Chassis Grounding



Warning

This equipment must be grounded. Never defeat the ground conductor or operate the equipment in the absence of a suitably installed ground conductor. Contact the appropriate electrical inspection authority or an electrician if you are uncertain that suitable grounding is available. Statement 1024

You must connect the chassis to a reliable earth ground; the ground wire must be installed in accordance with local electrical safety standards.

- For grounding, use size 14 AWG copper wire and the ground lug (which are not a part of the accessory kit).
- Use the UNC 6-32 screws, which have a length of about 0.25 inches



Note

Use 14AWG wire for installation.

To install the ground connection for your router, perform the following steps:

- 1 Strip one end of the ground wire to the length required for the ground lug or terminal.
 - For the ground lug—approximately 0.75 inch (20 mm)
 - For user-provided ring terminal—as required
- 2 Crimp the ground wire to the ground lug or ring terminal, using a crimp tool of the appropriate size.

- Attach the ground lug or ring terminal to the chassis as shown in Figure. For a ground lug, one of the screws provided. Tighten the screw to a torque of 8 to 10 in-lb (0.9 to 1.1 N-m).

Figure 12: Chassis Ground Connection on the Router

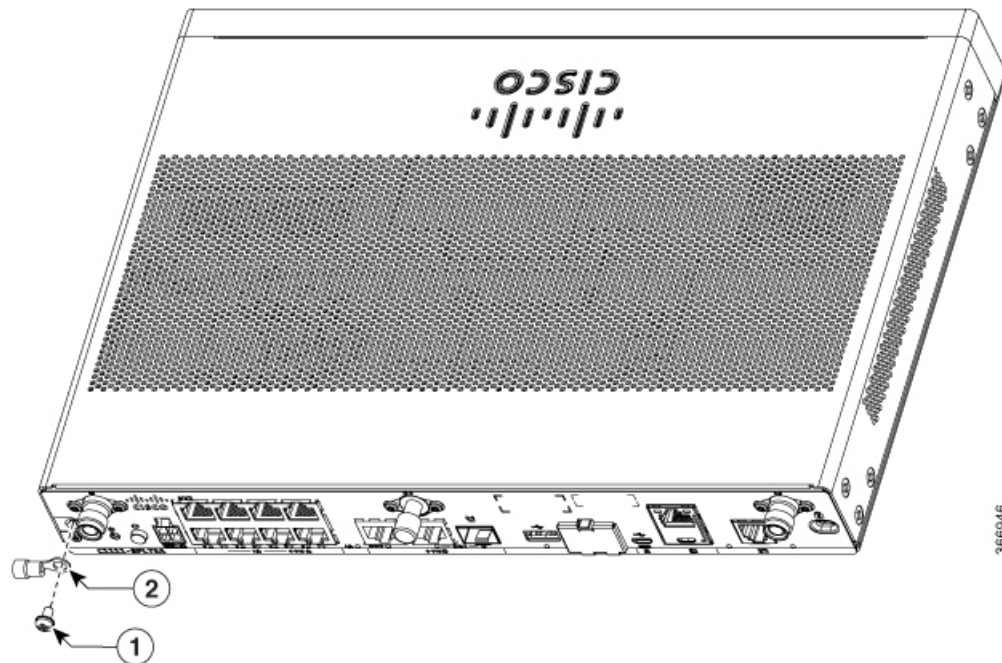

1	Screw (UNC 6-32)
2	Ground Lug

Connecting to a Console Terminal or Modem

The router has asynchronous serial ports. These ports provide administrative access to the router either locally (with a console terminal or a PC) or remotely (with a modem). To configure the router through the Cisco IOS CLI, you must establish a connection between the router console port and either a terminal or a PC.

Use the following cables and adapters to establish a local or remote connection.

Table 7: Local and Remote Connections

Port Type	Cable	Section
Serial (RJ-45)	EIA RJ-45	Connecting to the Serial Port with Microsoft Windows, on page 33
Serial (USB)	Micro USB Type-B to USB Type-A	

Connecting to the Serial Port with Microsoft Windows

Note

Install the USB device driver before establishing a physical connection between the router and the PC using the USB Console cable plugged into the USB serial port, otherwise the connection will fail. See the “Installing the Cisco Microsoft Windows USB Device Driver” section.

- 1 Connect the end of the console cable with the RJ-45 connector to the light blue console port on the router.
- 2 or
Connect a USB 5-pin micro USB Type-B to the USB console port. If you are using the USB serial port for the first time on a Windows-based PC, install the USB driver now according to the instructions in the following sections.
 - “Installing the Cisco Microsoft Windows XP USB Driver” section
 - “Installing the Cisco Microsoft Windows 2000 USB Driver” section
 - “Installing the Cisco Microsoft Windows Vista USB Driver” section
 - “Installing the Cisco Microsoft Windows 8 and Windows 10 USB Driver” section

Note

You cannot use the USB port and the EIA port concurrently. When the USB port is used it takes priority over the RJ-45 EIA port.

- 3 Connect the end of the cable with the DB-9 connector (or USB Type-A) to the terminal or PC. If your terminal or PC has a console port that does not accommodate a DB-9 connector, you must provide an appropriate adapter for that port.
- 4 To communicate with the router, start a terminal emulator application. This software should be configured with the following parameters:
 - 9600 baud
 - 8 data bits

- no parity
- 1 stop bit
- no flow control

Connecting to the Console Port with Mac OS X

This procedure describes how to connect a Mac OS X system USB port to the console using the built in OS X Terminal utility.

-
- Step 1** Use the Finder to go to Applications > Utilities > Terminal.
- Step 2** Connect the OS X USB port to the router.
- Step 3** Enter the following commands to find the OS X USB port number

Example:

```
macbook:user$ cd /dev
macbook:user$ ls -ltr /dev/*usb*
crw-rw-rw- 1 root  wheel   9,  66 Apr  1 16:46 tty.usbmodem1a21 DT-macbook:dev user$
```

- Step 4** Connect to the USB port with the following command followed by the router USB port speed

Example:

```
macbook:user$ screen /dev/tty.usbmodem1a21 9600
```

To disconnect the OS X USB console from the Terminal window

Enter Ctrl-a followed by Ctrl-\

Connecting to the Console Port with Linux

This procedure shows how to connect a Linux system USB port to the console using the built in Linux Terminal utility.

-
- Step 1** Open the Linux Terminal window.
- Step 2** Connect the Linux USB port to the router.
- Step 3** Enter the following commands to find the Linux USB port number

Example:

```
root@usb-suse# cd /dev
root@usb-suse /dev# ls -ltr *ACM*
crw-r--r-- 1 root  root   188,  0 Jan 14 18:02 ttyACM0
root@usb-suse /dev#
```

- Step 4** Connect to the USB port with the following command followed by the router USB port speed

Example:

```
root@usb-suse /dev# screen /dev/ttyACM0 9600
```

To disconnect the Linux USB console from the Terminal window

Enter Ctrl-a followed by : then quit

Installing the Cisco Microsoft Windows USB Device Driver

A USB device driver must be installed the first time a Microsoft Windows-based PC is connected to the USB serial port on the router.

This section contains the following topics:

Installing the Cisco Microsoft Windows XP USB Driver

This procedure shows how to install the Microsoft Windows XP USB driver.

Before you begin, download the appropriate driver for your router model from the Cisco Software Download site, USB Console Software category: <http://www.cisco.com/cisco/software/navigator.html>

-
- Step 1** Unzip the file Cisco_usbconsole_driver_X_X.zip (where X is a revision number).
 - Step 2** If using 32-bit Windows XP double-click the file setup.exe from the Windows_32 folder, or if using 64-bit Windows XP double-click the file setup(x64).exe from the Windows_64 folder.
 - Step 3** The Cisco Virtual Com InstallShield Wizard begins. Click Next.
 - Step 4** The Ready to Install the Program window appears, Click Install.
 - Step 5** The InstallShield Wizard Completed window appears. Click Finish.
 - Step 6** Connect the USB cable to the PC and router USB console. The LED of the USB console port turns green, and within a few moments the Found New Hardware Wizard appears. Follow the instructions to complete the installation of the driver.
 - Step 7** The USB console is now ready for use.
-

Installing the Cisco Microsoft Windows 2000 USB Driver

This procedure shows how to install the Microsoft Windows 2000 USB driver.

-
- Step 1** Obtain the file Cisco_usbconsole_driver.zip from the Cisco.com web site and unzip it.
 - Step 2** Double-click the file setup.exe.
 - Step 3** The Cisco Virtual Com InstallShield Wizard begins. Click Next.
 - Step 4** The Ready to Install the Program window appears, Click Install.
 - Step 5** The InstallShield Wizard Completed window appears. Click Finish.
 - Step 6** Connect the USB cable to the PC and router USB console ports. The LED for the USB console port turns green, and within a few moments a series of Found New Hardware Wizard windows appear. Follow the instructions to complete the installation of the driver.
 - Step 7** The USB console is now ready for use.
-

Installing the Cisco Microsoft Windows Vista USB Driver

This procedure shows how to install the Microsoft Windows Vista USB driver.

-
- Step 1** Obtain the file Cisco_usbconsole_driver.zip from the Cisco.com web site and unzip it.
 - Step 2** If using 32-bit Windows Vista double-click the file setup.exe from the Windows_32 folder, or if using 64-bit Windows Vista double-click the file setup(x64).exe from the Windows_64 folder.
 - Step 3** The Cisco Virtual Com InstallShield Wizard begins. Click Next.
 - Step 4** The Ready to Install the Program window appears, Click Install.
Note If a User Account Control warning appears, click “Allow - I trust this program...” to proceed.
 - Step 5** The InstallShield Wizard Completed window appears. Click Finish.
 - Step 6** Connect the USB cable to the PC and router USB console ports. The LED for the USB console port turns green, and within a few moments a pop up window stating “Installing device driver software” appears. Follow the instructions to complete the installation of the driver.
 - Step 7** The USB console is now ready for use.
-

Installing the Cisco Microsoft Windows 8/Windows 10 USB Driver

This procedure shows how to install the Microsoft Windows 8/Windows 10 USB driver.

-
- Step 1** Obtain the Cisco USB console driver file from the Cisco.com web site and unzip it.
Note You can download the driver file from the Cisco.com site for downloading the router software.

- Step 2** If using 32-bit Windows 8 or Windows 10, double-click the setup.exe file in the Windows_32 folder. If using 64-bit Windows Vista or Windows 8 or Windows 10, double-click the setup(x64).exe file in the Windows_64 folder.
- Step 3** The Cisco Virtual Com InstallShield Wizard begins. Click Next.
- Step 4** The Ready to Install the Program window appears, Click Install.
Note If a User Account Control warning appears, click Allow - I trust this program to proceed.
- Step 5** The InstallShield Wizard Completed window appears. Click Finish.
- Step 6** Connect the USB cable to the PC and router USB console ports. The LED for the USB console port turns green, and within a few moments a series of Found New Hardware Wizard windows appear. Follow the instructions to complete the installation of the driver.
- Step 7** The USB console is now ready for use.
-

Uninstalling the Cisco Microsoft Windows USB Driver

This section provides instructions for how to uninstall the Cisco Microsoft Windows USB device driver.

- [Uninstalling the Cisco Microsoft Windows XP and 2000 USB Driver, on page 37](#)
- [Uninstalling the Cisco Microsoft Windows Vista USB Driver, on page 38](#)

Uninstalling the Cisco Microsoft Windows XP and 2000 USB Driver

This procedure shows you how to uninstall both the Microsoft Windows XP and 2000 USB driver. The driver can be removed using the Windows Add Remove Programs utility or the setup.exe program.

Using the Add Remove Programs utility

Disconnect the router console terminal before uninstalling the driver.

- 1 Click Start > Control Panel > Add or Remove Programs.
- 2 Scroll to Cisco Virtual Com and click Remove.
- 3 When the Program Maintenance window appears, select the Remove radio button. Click Next.

Using the Setup.exe program

**Note**

Disconnect the router console terminal before uninstalling the driver.

- 1 Run the setup.exe for Windows 32-bit or setup(x64).exe for Windows-64bit. Click Next.
- 2 The InstallShield Wizard for Cisco Virtual Com appears. Click Next.
- 3 When the Program Maintenance window appears, select the Remove radio button. Click Next.
- 4 When the Remove the Program window appears, click Remove.
- 5 When the InstallShield Wizard Completed window appears click Finish.

Uninstalling the Cisco Microsoft Windows Vista USB Driver

This procedure shows you how to uninstall the Microsoft Windows Vista USB driver.

Note

Disconnect the router console terminal before uninstalling the driver.

-
- Step 1** Run the setup.exe for Windows 32-bit or setup(x64).exe for Windows-64bit. Click Next.
- Step 2** The InstallShield Wizard for Cisco Virtual Com appears. Click Next.
- Step 3** When the Program Maintenance window appears, select the Remove radio button. Click Next.
- Step 4** When the Remove the Program window appears, click Remove.
- Note** If a User Account Control warning appears, click “Allow - I trust this program...” to proceed.
- Step 5** When the InstallShield Wizard Completed window appears click Finish.
-

Connecting WAN and LAN Interfaces

This section describes how to connect WAN and LAN interface cables. It covers the following topics:

Warning

Do not work on the system or connect or disconnect cables during periods of lightning activity. Statement 1001

Warning

Hazardous network voltages are present in WAN ports regardless of whether power to the unit is OFF or ON. To avoid electric shock, use caution when working near WAN ports. When detaching cables, detach the end away from the unit first. Statement 1026

Caution

To comply with the Telcordia GR-1089 NEBS standard for electromagnetic compatibility and safety, connect Gigabit Ethernet ports using RJ-45 connectors for shielded twisted pair cable only to intra-building or unexposed wiring or cable. The intra-building cable must be shielded and the shield must be grounded at both ends. The intra-building port(s) of the equipment or subassembly must not be metallicly connected to interfaces that connect to the OSP or its wiring. These interfaces are designed for use as intra-building interfaces only (Type 2 or Type 4 ports as described in GR-1089-CORE, Issue 4) and require isolation from the exposed OSP cabling. The addition of Primary Protectors is not sufficient protection in order to connect these interfaces metallicly to OSP wiring.

Warning

Never install telephone jacks in wet locations unless the jack is specifically designed for wet locations. Statement 1036

**Warning**

Never touch uninsulated telephone wires or terminals unless the telephone line has been disconnected at the network interface. Statement 1037

**Warning**

Class 1 laser product. Statement 1008

Ports and Cabling

This chapter summarizes typical WAN and LAN connections for routers. The connections summarized here are also described in detail in the document on Cisco.com: Cisco Modular Access Router Cable Specifications

Table 8: WAN and LAN Connections

Port or Connection	Port Type, Color ²	Connection:	Cable
Ethernet	RJ-45, yellow	Ethernet hub or Ethernet switch	Category 5 or higher Ethernet
Cisco serial	60-pin D-sub, blue	CSU/DSU and serial network or equipment	Cisco serial transition cable that matches the signaling protocol (EIA/TIA-232, EIA/TIA-449, V.35, X.21, or EIA-530) and the serial port operating mode (DTE or DCE). ³
Cisco Smart serial	Cisco Smart compact connector, blue	CSU/DSU and serial network or equipment	
Gigabit Ethernet SFP, optical	LC, color according to optical wavelength	1000BASE-SX, -LX, -LH, -ZX, -CWDM	Optical fiber as specified on applicable data sheet
Gigabit Ethernet SFP, copper	RJ-45	1000BASE-T	Category 5, 5e, 6 UTP

² Cable color codes are specific to Cisco cables.

³ See the Cisco Modular Access Router Cable Specifications document for information about choosing these cables.

Connection Procedures and Precautions

- Connect each WAN and LAN to the appropriate connector on the chassis.
- Position the cables carefully, so that they do not put strain on the connectors.
- Organize cables in bundles so that cables do not intertwine.
- Inspect the cables to make sure that the routing and bend radius is satisfactory. Reposition cables, if necessary.
- Install cable ties in accordance with site requirements.

For cable pinouts, see Cisco Modular Access Router Cable Specifications .



ROM Monitor Overview and Basic Procedures

- [ROM Monitor Overview and Basic Procedures, page 41](#)

ROM Monitor Overview and Basic Procedures

This chapter provides an overview of ROM Monitor concepts and operations.

This chapter includes the following main topics:

ROM Monitor Overview

The *ROM Monitor* is a bootstrap program that initializes the hardware and boots the Cisco IOS XE software when you power on or reload a router. When you connect a terminal to the router that is in ROM Monitor mode, the ROM Monitor command-line interface (CLI) prompt is displayed.

If your system (router, switch, or access server) does not find a valid system image to load when it is booting, the system will enter the ROM monitor mode. ROM monitor (ROMMON) mode can also be accessed by interrupting the boot sequence during startup.

The ROM monitor mode is used to:

- specify config-register value to use for the next boot up
- boot a valid IOS XE image
- bypass NVRAM settings and config-register value for password recovery

The *ROM Monitor software* is known by many names. It is sometimes called *ROMMON* because of the CLI prompt in ROM Monitor mode. The ROM Monitor software is also called the *boot software*, *boot image*, or *boot helper*. Although it is distributed with routers that use the Cisco IOS XE software, ROM Monitor is a separate program from the Cisco IOS XE software. During normal startup, the ROM Monitor initializes the router, and then control passes to the Cisco IOS XE software. After the Cisco IOS XE software takes over, ROM Monitor is no longer in use.

Environmental Variables and the Configuration Register

Two primary connections exist between ROM Monitor and the Cisco IOS XE software: the ROM Monitor environment variables and the configuration register.

The ROM Monitor environment variables define the location of the Cisco IOS XE software and describe how to load it. After ROM Monitor has initialized the router, it uses the environment variables to locate and load the Cisco IOS XE software.

The *configuration register* is a software setting that controls how a router starts up. One of the primary uses of the configuration register is to control whether the router starts in ROM Monitor mode or Administration EXEC mode. The configuration register is set in either ROM Monitor mode or Administration EXEC mode as needed. Typically, you set the configuration register using the Cisco IOS XE software prompt when you need to use ROM Monitor mode. When the maintenance in ROM Monitor mode is complete, you change the configuration register so the router reboots with the Cisco IOS XE software.

Accessing ROM Monitor Mode with a Terminal Connection

When the router is in ROM Monitor mode, you can access the ROM Monitor software only from a terminal connected directly to the console port of the card. Because the Cisco IOS XE software (EXEC mode) is not operating, the nonmanagement interfaces are not accessible. Basically, all Cisco IOS XE software resources are unavailable.

Network Management Access and ROM Monitor Mode

ROM Monitor mode is a router mode, not a mode within the Cisco IOS XE software. ROM Monitor software and the Cisco IOS XE software are two separate programs that run on the same router. At any given time, the router is running one of these programs, but it never runs both at the same time.

One area that can be confusing when using ROM Monitor and the Cisco IOS XE software is the area that defines the IP configuration for the Management Ethernet interface. Most router users get comfortable with configuring the Management Ethernet interface in the Cisco IOS XE software. When the router is in ROM Monitor mode, however, the router is not running the Cisco IOS XE software, so that Management Ethernet interface configuration is not available.

When you want to access other devices, such as a TFTP server, while in ROM Monitor mode on the router, you must configure the ROM Monitor variables with IP access information.

Entering ROM Monitor Mode

The following sections describe how to enter the ROMMON mode, and contains the following sections:

Checking the Current ROMmon Version

To display the version of ROMmon running on a router, use the **show rom-monitor** command or the **show platform** command.

```
Router# show rom-monitor r0

System Bootstrap, Version 12.2[16.6(1r)RC3], DEVELOPMENT SOFTWARE
Copyright (c) 1994-2017 by cisco Systems, Inc.
Compiled at Fri Jul 28 13:07:32 2017 by user5

Router# show platform
Chassis type: C1111-8PLTELAWN

Slot      Type                State             Insert time (ago)
-----
0         C1111-8PLTELAWN    ok                00:04:56
0/0      C1111-2x1GE        ok                00:02:41
0/1      C1111-ES-8         ok                00:02:40
```

```

0/2      C1111-LTE          ok          00:02:41
0/3      ISR-AP1100AC-N   ok          00:02:41
R0       C1111-8PLTELAWN ok, active  00:04:56
F0       C1111-8PLTELAWN ok, active  00:04:56
P0       PWR-12V         ok          00:04:30

Slot     CPLD Version      Firmware Version
-----
0        17100501             16.6(1r)RC3
R0       17100501             16.6(1r)RC3
F0       17100501             16.6(1r)RC3

```

Commonly Used ROM Monitor Commands

This table summarizes the commands commonly used in ROM Monitor. For specific instructions on using these commands, refer to the relevant procedure in this document.

Table 9: Commonly Used ROM Monitor Commands

ROMMON Command	Description
<code>boot image</code>	Manually boots a Cisco IOS XE software image.
<code>confreg</code>	Changes the config-register setting.
<code>dev</code>	Displays the available local storage devices.
<code>dir</code>	Displays the files on a storage device.
<code>reset</code>	Resets the node.
<code>set</code>	Displays the currently set ROM Monitor environmental settings.
<code>sync</code>	Saves the new ROM Monitor environmental settings.
<code>unset</code>	Removes an environmental variable setting.

Displaying the Available ROM Monitor Commands

This topic describes the available `help` commands for ROM Monitor mode.

Table 10: Help Commands in ROMMON

Command	Description
<code>help</code> or <code>?</code>	Displays a summary of all available ROM Monitor commands.
<code>-?</code>	Displays information about command syntax.

**Note**

Commands are case-sensitive. You can halt any command by pressing **Ctrl-C**.

Examples

The following example shows what appears when you enter the **?** command on a router:

```
rommon 2 > ?
alias      set and display aliases command
boot       boot up an external process
confreg    configuration register utility
dev        list the device table
dir        list files in file system
help       monitor builtin command help
history    monitor command history
meminfo    main memory information
repeat     repeat a monitor command
reset      system reset
set        display the monitor variables
showmon    display currently selected ROM monitor
sync       write monitor environment to NVRAM
token      display board's unique token identifier
unalias    unset an alias
unset      unset a monitor variable
```

Changing the ROM Monitor Prompt

You can change the prompt in ROM Monitor mode by using the **PS1=** command as shown in the following example:

```
rommon 8 > PS1="ISR1110 rommon ! > "
ISR1110 rommon 9 >
```

Changing the prompt is useful if you are working with multiple routers in ROM Monitor at the same time. This example specifies that the prompt should be "ISR1110 rommon ", followed by the line number, and then followed by ">" by the line number.

Displaying the Configuration Register Setting

To display the current configuration register setting, enter the **confreg** command without parameters as follows:

```
rommon 3 > confreg
```

```
Configuration Summary
(Virtual Configuration Register: 0x0)
enabled are:
[ 0 ] break/abort has effect
[ 1 ] console baud: 9600
boot:..... the ROM Monitor
do you wish to change the configuration? y/n [n]: n
```

The configuration register setting is labeled *Virtual Configuration Register*. Enter the **no** command to avoid changing the configuration register setting.

Environment Variable Settings

The ROM Monitor environment variables define the attributes of the ROM Monitor. Environmental variables are entered like commands and are always followed by the equal sign (=). Environment variable settings are entered in capital letters, followed by a definition. For example:

```
IP_ADDRESS=10.0.0.2
```

Under normal operating conditions, you do not need to modify these variables. They are cleared or set only when you need to make changes to the way ROM Monitor operates.

This section includes the following topics:

Frequently Used Environmental Variables

The table shows the main ROM Monitor environmental variables. For instructions on how to use these variables, see the relevant instructions in this document.

Table 11: Frequently Used ROM Monitor Environmental Variables

Environmental variable	Description
IP_ADDRESS =ip_address	Sets the IP address for the Management Ethernet interface.
IP_SUBNET_MASK =ip_address	Sets the subnet mask for the Management Ethernet interface.
DEFAULT_GATEWAY =ip_address	Sets the default gateway that serves.
TFTP_SERVER =ip_address	Sets the IP address of the TFTP server where a bootable software image is located.
TFTP_FILE =path/file	Sets the directory and filename of a bootable software image.
BOOT =path/file	Identifies the boot software for a node. This variable is usually set automatically when the router boots.

Displaying Environment Variable Settings

To display the current environment variable settings, enter the **set** command :

```
rommon 1 > set
PS1=rommon ! >
LICENSE_SUITE=
LICENSE_BOOT_LEVEL=
MCP_STARTUP_TRACEFLAGS=00000000:00000000
RET_2_RTS=
RANDOM_NUM=1721712417
BSI=0
RET_2_RCALTS=
```

Entering Environment Variable Settings

Environment variable settings are entered in capital letters, followed by a definition. The following example shows the environmental variables used to configure the control Ethernet port on a router:

```
rommon > IP_ADDRESS=10.0.0.2
```

Saving Environment Variable Settings

To save the current environment variable settings, enter the **sync** command:

```
rommon > sync
```



Note

Environmental values that are not saved with the **sync** command are discarded whenever the system is reset or booted.

Exiting ROM Monitor Mode

To exit ROM Monitor mode, you must change the configuration register and reset the router.

SUMMARY STEPS

1. **confreg**
2. Respond to each prompt as instructed.
3. **reset**

DETAILED STEPS

	Command or Action	Purpose
Step 1	confreg Example: rommon 1> confreg	Initiates the configuration register configuration prompts.
Step 2	Respond to each prompt as instructed.	See the example that follows this procedure for more information.
Step 3	reset Example: rommon 2> reset	Resets and initializes the router.

Configuration Example

```
rommon 5 > confreg

Configuration Summary
(Virtual Configuration Register: 0x0)
enabled are:
[ 0 ] break/abort has effect
[ 1 ] console baud: 9600
boot:..... the ROM Monitor
do you wish to change the configuration? y/n [n]: y
enable "diagnostic mode"? y/n [n]:
disable "break/abort has effect"? y/n [n]:
enable "ignore system config info"? y/n [n]:
change console baud rate? y/n [n]:
change the boot characteristics? y/n [n]:

Configuration Summary
(Virtual Configuration Register: 0x0)
enabled are:
[ 0 ] break/abort has effect
[ 1 ] console baud: 9600
boot:..... the ROM Monitor
do you wish to change the configuration? y/n [n]:
```

Upgrading the ROMmon for a Router

Use this procedure to upgrade the ROMmon on a router:

SUMMARY STEPS

1. (Optional) Run the **show platform** command or the **show rom-monitor slot** command on the router to see the current release numbers of ROMmon on the hardware.
2. If the ROMmon image has not been copied onto the router, copy the PKG file that is made available as part of this ROMmon release onto the bootflash: or usb[0-1]: file system using the copy source-location destination-location command.
3. Run the **dir file-system** command to verify that the ROMmon file is copied into the specified directory.
4. Run the **upgrade rom-monitor filename location all** command to begin the ROMmon image upgrade, where *location* is the path to the ROMmon file.
5. Messages pertaining to the upgrade are displayed on the console. After the display of these messages stops and the router prompt is available, run the **reload** command to reload the router.
6. If autoboot has not been enabled by using the **config-register 0x2102** command, run the **boot filesystem:/file-location** command at the ROMmon prompt to boot the Cisco IOS XE image, where *filesystem:/file-location* is the path to the consolidated package file. The ROMmon upgrade is not permanent for any piece of hardware until the Cisco IOS XE image is booted.
7. Run the **enable** command at the user prompt to enter the privileged EXEC mode after the boot is complete.
8. Run the **show platform** command or the **show rom-monitor slot** command to verify whether the ROMmon has been upgraded.

DETAILED STEPS

- Step 1** (Optional) Run the **show platform** command or the **show rom-monitor slot** command on the router to see the current release numbers of ROMmon on the hardware.
- Step 2** If the ROMmon image has not been copied onto the router, copy the PKG file that is made available as part of this ROMmon release onto the bootflash: or usb[0-1]: file system using the copy source-location destination-location command.
- Step 3** Run the **dir file-system** command to verify that the ROMmon file is copied into the specified directory.
- Step 4** Run the **upgrade rom-monitor filename location all** command to begin the ROMmon image upgrade, where *location* is the path to the ROMmon file.
- Caution** Do not remove hardware, turn off power, or interrupt the router in any way during the ROMmon upgrade. Although the router should be able to recover from most interruptions during the ROMmon upgrade, certain scenarios may cause unpredictable problems.
- Step 5** Messages pertaining to the upgrade are displayed on the console. After the display of these messages stops and the router prompt is available, run the **reload** command to reload the router.
- Step 6** If autoboot has not been enabled by using the **config-register 0x2102** command, run the **boot filesystem:/file-location** command at the ROMmon prompt to boot the Cisco IOS XE image, where *filesystem:/file-location* is the path to the consolidated package file. The ROMmon upgrade is not permanent for any piece of hardware until the Cisco IOS XE image is booted.
- Step 7** Run the **enable** command at the user prompt to enter the privileged EXEC mode after the boot is complete.
- Step 8** Run the **show platform** command or the **show rom-monitor slot** command to verify whether the ROMmon has been upgraded.
-



Installing and Upgrading Internal Modules and FRUs

- [Installing and Upgrading Internal Modules and FRUs, page 49](#)

Installing and Upgrading Internal Modules and FRUs

This document describes how to install and upgrade internal modules and field replaceable units (FRUs) in the Cisco 1100 Series Integrated Services Routers (ISRs). The install and upgrade information is contained in these sections:

Safety Warnings



Warning

Class 1 laser product. Statement 1008



Warning

Only trained and qualified personnel should be allowed to install, replace, or service this equipment. Statement 1030

Accessing Internal Modules

To access the internal modules on the router, you must first disconnect from the power source and then remove the chassis cover. See the Replacing the Cover section for instructions on how to remove and later replace the chassis cover on the routers.



Warning

Before opening the unit, disconnect the telephone-network cables to avoid contact with telephone-network voltages. Statement 1041

Replacing the Chassis Cover

The Cisco 1100 Series ISRs have a removable cover.

Do not run the router with the cover off. Doing so can cause the router to overheat very quickly.

Use a number-2 Phillips screwdriver to perform the following tasks.

Removing the Cover

To remove the cover, perform the following steps.

-
- Step 1** Read the Safety Warnings and disconnect the power supply before you perform any module replacement.
 - Step 2** Confirm the router is turned off and disconnected from the power supply or power supplies. If a redundant power is used, disconnect from the redundant power supply.
 - Step 3** Place the chassis on a flat surface.
 - Step 4** Remove all the screws on the both sides of the router; seven on each side.
 - Step 5** Pull the cover to disengage the slots along the front (bezel) edge of the chassis, as shown in the figure below.

Figure 13: Removing the Cover

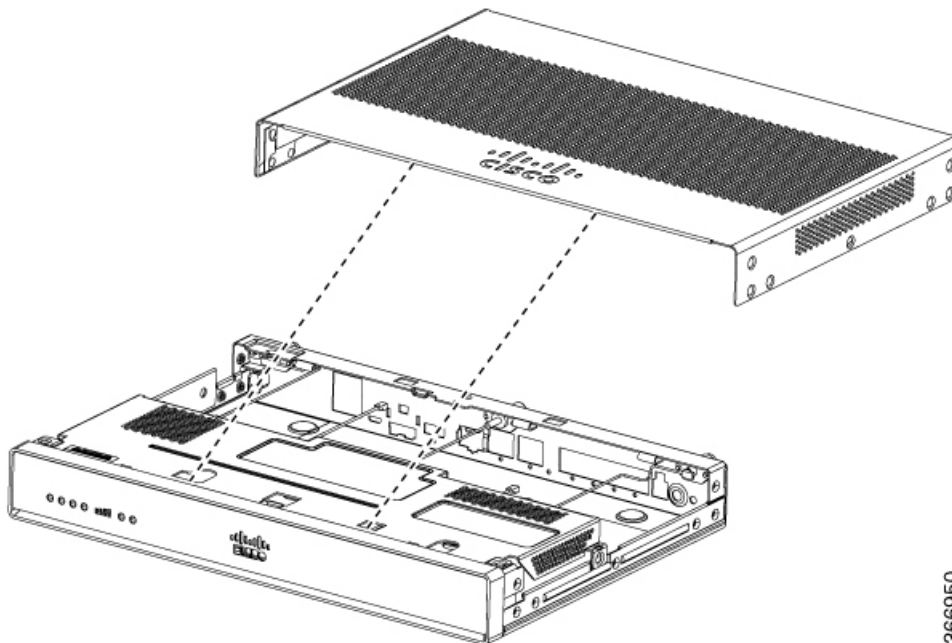

1	Slots
2	Screw holes (7 numbers on each side)

Replacing the Cover

To replace the cover, perform the following steps.

- Step 1** Read the [Safety Warnings](#), on page 49 and disconnect the power supply before you begin.
- Step 2** Confirm the router is turned off and disconnected from the power supply or power supplies. If a redundant power is used disconnect from the redundant power supply.
- Step 3** Place the chassis on a flat surface.
- Step 4** Locate the cover hooks on the mating slots and slide the cover towards the bezel side.
- Step 5** Install seven screws on each side.

Locating Internal and External Slots for Modules

This section describes the locations of internal modules on the router motherboard. Internal modules include PoE daughter card on the Cisco 1100 Series ISRs.

Figure 14: Module Location in the Cisco 1100 Series ISR

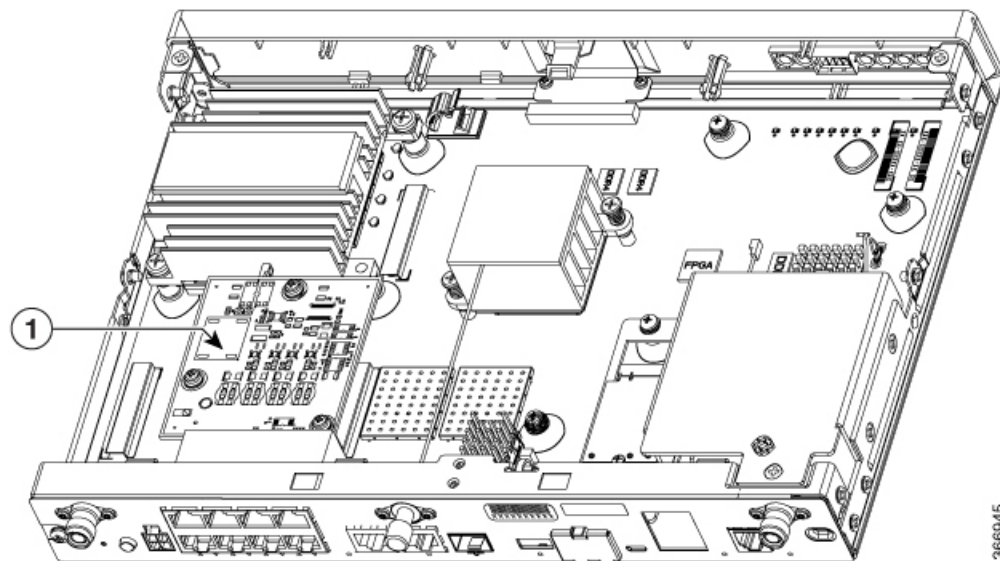

1	PoE Module
---	------------

Installing the Internal PoE Daughter Card

Use the following procedure to install an Internal PoE daughter card:

-
- Step 1** Read the Safety Warnings and disconnect the power supply before you perform any module installation.
- Step 2** Confirm the router is turned off and disconnected from the power supply.
- Step 3** Open the chassis according to the instructions in the Removing the Chassis section.
- Step 4** Locate the three metal standoff holes, and install the metal standoffs into the three holes. Make sure that the standoffs are straight when installed. Tighten them gently but firmly, to a torque of 6-8 in-lbf.
- Step 5** Place the PoE daughter card on top of the three metal standoffs, lining up the screw holes in the PoE daughter card with the metal standoffs.
- Step 6** Gently push the PoE daughter card down towards the system board until it is firmly fixed.
- Step 7** Insert the three M3 (48-0530-01) screws provided, through the PoE daughter card and into the metal standoffs. Tighten the screws using a torque of 5 in-lb.
- Step 8** Close the chassis cover according to the instructions in the Replacing the Cover section, and connect the power supply cable.

Figure 15: Internal PoE Daughter Card Assembly

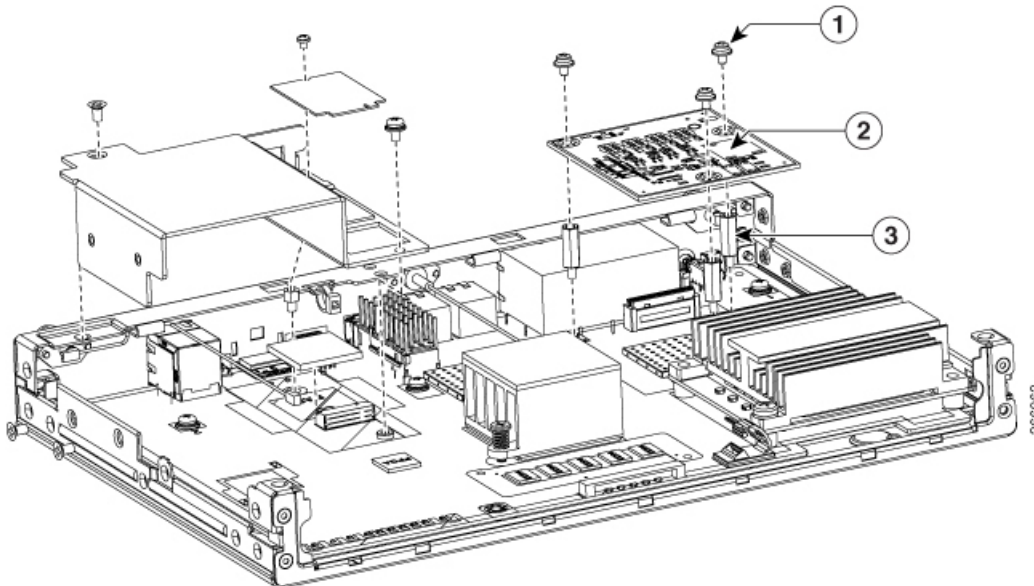

1	Screws	2	PoE Daughter Card
3	Metal Standoffs		

Removing and Replacing the Internal PoE Daughter Card

Use the following procedure to remove and replace the Internal PoE daughter card:

-
- Step 1** Read the Safety Warnings and disconnect the power supply before you remove or replace the module.
- Step 2** Open the chassis, locate the PoE daughter card assembly.
- Step 3** Remove the three M3 (48-0530-01) screws.
- Step 4** Pull the PoE daughter card out of the connector. If replacing the card, insert the new PoE daughter card and tighten the screws to a torque of 5 in-lb.
- Step 5** Place the removed card in an anti-static bag to protect it from ESD damage.
- Note** To upgrade the PoE daughter card, follow the steps mentioned in the Installing the Internal PoE Daughter Card section.
-

Removing and Replacing the USB Flash Token Memory Stick

The Cisco 1100 Series ISRs contain port for a 1 GB flash token memory stick to store configurations or Cisco IOS XE consolidated packages.



Note Only Cisco USB Flash memory modules are supported by Cisco routers.



Caution Do not remove a USB Flash memory module when issuing some file access command or a read/write operation to the Flash memory module when it is processing. The router might reload or the USB Flash memory module can be damaged. You can check to see if the USB activity LED on the router front panel is flashing, prior to the removal of the USB device

To remove and then replace a USB flash token memory stick from the router, follow these steps:

-
- Step 1** Pull the memory stick from the USB port.
- Step 2** To replace a Cisco USB Flash memory stick, simply insert the module into the USB port. The Flash memory module can be inserted in only one way, and can be inserted or removed regardless of whether the router is powered up or not.
-

What to Do Next

This completes the USB Flash memory installation procedure.

AC Power Supplies

Overview of the AC Power Supply

Power supply of the Cisco 1100 Series ISRs is an external AC to DC power adapter. The external power adapter DC power connector plugs in to the router 4-pin power connector, to power the unit.

Figure 16: Power Supply Unit

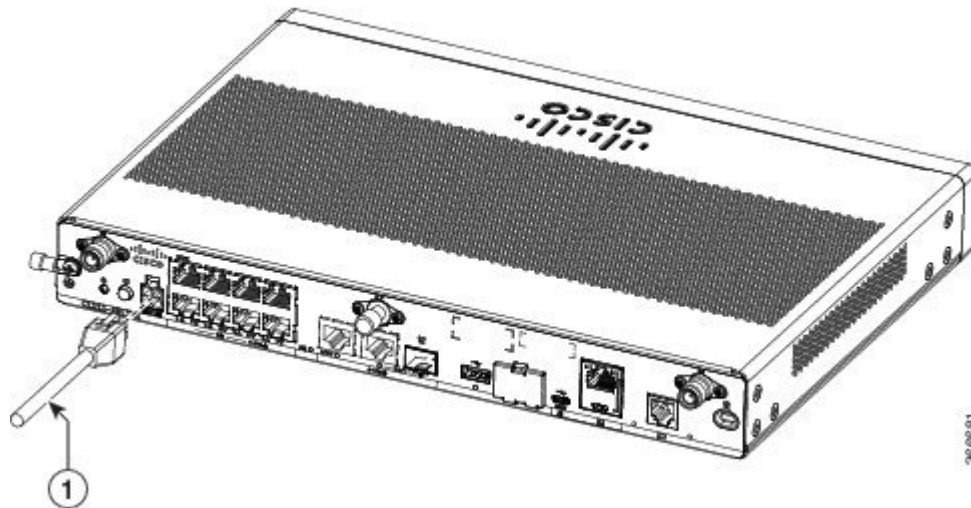

1	Power Cable
---	-------------

Installing and Removing SFP Modules

This section describes how to install optional small-form-factor pluggable (SFP) modules in the router to provide optical Gigabit Ethernet connectivity.

The SFP module installs into a slot on the router rear panel. When selected in Cisco IOS software, it is assigned port **gigabitethernet 0/0/0**. The default is the built-in RJ-45 1000Base-T connector, which is enabled on this port.

Only SFP modules certified by Cisco are supported on the routers.

Table 12: SFPs Supported on the Router

Cisco Model Number	Minimum IOS-XE Version	Description
GLC-EX-SMD	3.15	1000BASE-EX SFP transceiver module, SMF, 1310nm, DOM

Cisco Model Number	Minimum IOS-XE Version	Description
GLC-LH-SM	3.10	GE SFP, LC connector LX/LH transceiver
GLC-ZX-SM-X=	1000Base-ZX	9/125
GLC-LH-SMD	3.10	GE SFP, LC connector LX/LH transceiver; with DOM
GLC-SX-MM	3.10	GE SFP, LC connector SX transceiver
GLC-SX-MMD	3.10	GE SFP, LC connector SX transceiver; with DOM
GLC-ZX-SM	3.10	1000BASE-ZX SFP
GLC-ZX-SMD	3.16.1	1000BASE-ZX SFP; with DOM
GLC-FE-100FX	3.10	100BASE-FX SFP for FE port
GLC-FE-100LX	3.10	100BASE-LX SFP for FE port
GLC-FE-100ZX	3.10	100BASE-ZX SFP (80km)
GLC-FE-100EX	3.10	100BASE-EX SFP (40km)
GLC-FE-100BX-D	3.11	100BASE-BX10-D SFP
GLC-FE-100BX-U	3.11	100BASE-BX10-U SFP
GLC-GE-100 V02	3.10	100 V02 SFP on GE ports

Cisco Model Number	Minimum IOS-XE Version	Description
GLC-BX80-D-I	3.16.1	1000BASE-BX80 SFP, 1570NM
GLC-BX80-U-I	3.16.1	1000BASE-BX80 SFP, 1490NM
GLC-BX40-D-I	3.16.1	1000BASE-BX40 SFP, 1550NM
GLC-BX40-U-I	3.16.1	1000BASE-BX40 SFP, 1310NM
GLC-BX-D	3.10	1000BASE-BX SFP, 1490NM
GLC-BX-U	3.10	1000BASE-BX SFP, 1310NM
SFP-GE-S	3.13	1000BASE-SX SFP transceiver module for MMF, 850-nm wavelength, extended operating temperature range and DOM support, dual LC/PC connector
CWDM-SFP-1470	3.10	CWDM 1470 NM SFP Gigabit Ethernet and 1G/2G FC
CWDM-SFP-1490	3.10	CWDM 1490 NM SFP Gigabit Ethernet and 1G/2G FC
CWDM-SFP-1510	3.10	CWDM 1510 NM SFP Gigabit Ethernet and 1G/2G FC
CWDM-SFP-1530	3.10	CWDM 1530 NM SFP Gigabit Ethernet and 1G/2G FC

Cisco Model Number	Minimum IOS-XE Version	Description
CWDM-SFP-1550	3.10	CWDM 1550 NM SFP Gigabit Ethernet and 1G/2G FC
CWDM-SFP-1570	3.10	CWDM 1570 NM SFP Gigabit Ethernet and 1G/2G FC
CWDM-SFP-1590	3.10	CWDM 1590 NM SFP Gigabit Ethernet and 1G/2G FC
CWDM-SFP-1610	3.10	CWDM 1610 NM SFP Gigabit Ethernet and 1G/2G FC
DWDM-SFP-3033	3.10	DWDM SFP 1530.33 nm SFP (100 GHz ITU grid)
DWDM-SFP-3112	3.10	DWDM SFP 1531.12 nm SFP (100 GHz ITU grid)
DWDM-SFP-3190	3.10	DWDM SFP 1531.90 nm SFP (100 GHz ITU grid)
DWDM-SFP-3268	3.10	DWDM SFP 1532.68 nm SFP (100 GHz ITU grid)
DWDM-SFP-3425	3.10	DWDM SFP 1534.25 nm SFP (100 GHz ITU grid)
DWDM-SFP-3504	3.10	DWDM SFP 1535.04 nm SFP (100 GHz ITU grid)

Cisco Model Number	Minimum IOS-XE Version	Description
DWDM-SFP-3582	3.10	DWDM SFP 1535.82 nm SFP (100 GHz ITU grid)
DWDM-SFP-3661	3.10	DWDM SFP 1536.61 nm SFP (100 GHz ITU grid)
DWDM-SFP-3819	3.10	DWDM SFP 1538.19 nm SFP (100 GHz ITU grid)
DWDM-SFP-3898	3.10	DWDM SFP 1538.98 nm SFP (100 GHz ITU grid)
DWDM-SFP-3977	3.10	DWDM SFP 1539.77 nm SFP (100 GHz ITU grid)
DWDM-SFP-4056	3.10	DWDM SFP 1540.56 nm SFP (100 GHz ITU grid)
DWDM-SFP-4214	3.10	DWDM SFP 1542.14 nm SFP (100 GHz ITU grid)
DWDM-SFP-4294	3.10	DWDM SFP 1542.94 nm SFP (100 GHz ITU grid)
DWDM-SFP-4373	3.10	DWDM SFP 1543.73 nm SFP (100 GHz ITU grid)
DWDM-SFP-4453	3.10	DWDM SFP 1544.53 nm SFP (100 GHz ITU grid)

Cisco Model Number	Minimum IOS-XE Version	Description
DWDM-SFP-4612	3.10	DWDM SFP 1546.12 nm SFP (100 GHz ITU grid)
DWDM-SFP-4692	3.10	DWDM SFP 1546.92 nm SFP (100 GHz ITU grid)
DWDM-SFP-4772	3.10	DWDM SFP 1547.72 nm SFP (100 GHz ITU grid)
DWDM-SFP-4851	3.10	DWDM SFP 1548.51 nm SFP (100 GHz ITU grid)
DWDM-SFP-5012	3.10	DWDM SFP 1550.12 nm SFP (100 GHz ITU grid)
DWDM-SFP-5092	3.10	DWDM SFP 1550.92 nm SFP (100 GHz ITU grid)
DWDM-SFP-5172	3.10	DWDM SFP 1551.72 nm SFP (100 GHz ITU grid)
DWDM-SFP-5252	3.10	DWDM SFP 1552.52 nm SFP (100 GHz ITU grid)
DWDM-SFP-5413	3.10	DWDM SFP 1554.13 nm SFP (100 GHz ITU grid)
DWDM-SFP-5494	3.10	DWDM SFP 1554.94 nm SFP (100 GHz ITU grid)

Cisco Model Number	Minimum IOS-XE Version	Description
DWDM-SFP-5575	3.10	DWDM SFP 1555.75 nm SFP (100 GHz ITU grid)
DWDM-SFP-5655	3.10	DWDM SFP 1556.55 nm SFP (100 GHz ITU grid)
DWDM-SFP-5817	3.10	DWDM SFP 1558.17 nm SFP (100 GHz ITU grid)
DWDM-SFP-5898	3.10	DWDM SFP 1558.98 nm SFP (100 GHz ITU grid)
DWDM-SFP-5979	3.10	DWDM SFP 1559.79 nm SFP (100 GHz ITU grid)
DWDM-SFP-6061	3.10	DWDM SFP 1560.61 nm SFP (100 GHz ITU grid)

**Tip**

Use the **show controller** command at the Cisco IOS prompt to determine whether you are using an SFP certified by Cisco.

**Note**

Currently, GLC-GE-100FX V01 is not supported.

Installing SFPs

Removing SFP Modules

Follow these steps to remove an SFP from the router:

-
- Step 1** Read the Safety Warnings section and disconnect the power supply before you perform any module replacement.
- Step 2** Disconnect all cables from the SFP.
- Warning** Invisible laser radiation may be emitted from disconnected fibers or connectors. Do not stare into beams or view directly with optical instruments. Statement 1051
- Caution** The latching mechanism used on many SFPs locks the SFP into place when cables are connected. Do not pull on the cabling in an attempt to remove the SFP.
- Step 3** Disconnect the SFP latch.
- Note** SFP modules use various latch designs to secure the module in the SFP port. Latch designs are not linked to SFP model or technology type. For information on the SFP technology type and model, see the label on the side of the SFP.
- Tip** Use a pen, screwdriver, or other small straight tool to gently release a bale-clasp handle if you cannot reach it with your fingers.
- Step 4** Grasp the SFP on both sides and remove it from the router.
-



INDEX

? command (ROM Monitor) [43, 44](#)

1 GB flash token memory stick [53](#)

C

chassis [31](#)
 desktop installation [31](#)
confreg command (ROM Monitor) [44](#)
 displaying configuration register setting [44](#)
connections [20](#)
 Ethernet [20](#)
 network [20](#)

D

desktop installation [31](#)

E

environment variables [41, 45, 46](#)
 displaying [45](#)
 entering [46](#)
 introduction [41, 45](#)
 saving [46](#)
Ethernet cable types [20](#)

H

help command (ROM Monitor) [43](#)

I

installation [18, 20, 31](#)
 desktop [31](#)
 site requirements [18](#)
 tools required tools required for installation [20](#)

L

LAN [20, 38](#)
 connections [38](#)
 interface types [20](#)

N

network connections [20](#)

P

packing list [24](#)
power [18](#)
 requirements [18](#)
power supplies [18](#)
 requirements [18](#)

R

record keeping, site log [22](#)
ROM monitor [46](#)
 exiting [46](#)
ROM Monitor prompt [41](#)

S

set command (ROM Monitor) [45](#)
sync command (ROM Monitor) [46](#)

T

Tables [18](#)
power requirements [18](#)

W

Warnings [20, 23, 38](#)
lightning activity [38](#)
restricted access [23](#)
SELV circuit [20](#)
qualified personnel [23](#)