

Rocstor® Volt® C42 Charging Cart

User Manual



General Use

•The product is designed to charge up to 32 devices, Chromebook®, Netbooks, Laptops or Tablets, holds up to 16 inch Display .

1. Product Specifications	1
2. Package Contents	2
3. Feature & Product Overview	3, 4, 5
4. Cable Management and charge mode	6
5. Safty & Cautions	7

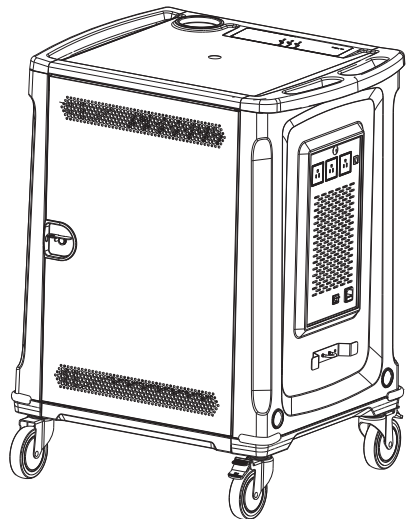

1. Product Specification

■ Volt® C42

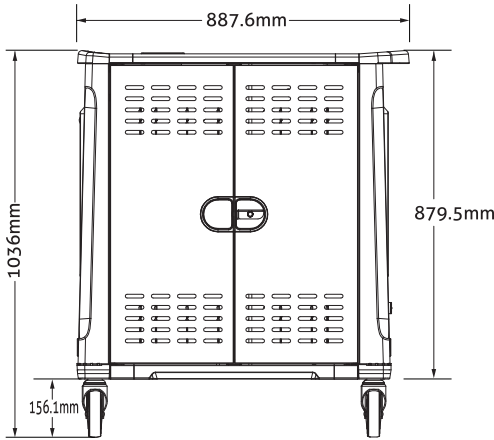

34 x 348 x 260 mm
(1.3" x 13.7" x 10.2")

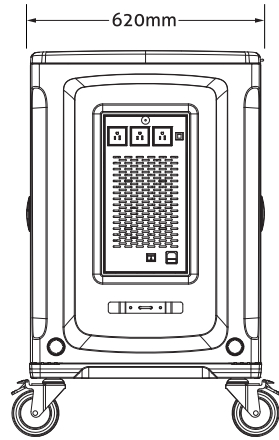

Product SPEC

Model Name	Volt®C42	Charging Type	Power receptacle
Capacity	42 Devices	Support Device	Chromebook®, Laptops or Tablets, up to 16 inch
Dim. with Packing	W950 x D710 x H1088 mm	Slot	H260 x D388 x W34 mm H10.24" x D15.28" x W1.34"
N.W. / G.W.	80 / 95 kgs (176.4 / 209.5 lbs)	Power Specification	Input: AC 100-125V, 50/60Hz, 12A AC 220-240V, 50/60Hz, 10A Output: AC 100-125V, 50/60Hz, 11A AC 220-240V, 50/60Hz, 9A

- Caution: 1. Adult operation and supervision is recommended at all times.
2. To reduce Risk of electric shock use only indoors.

2. Package Contents

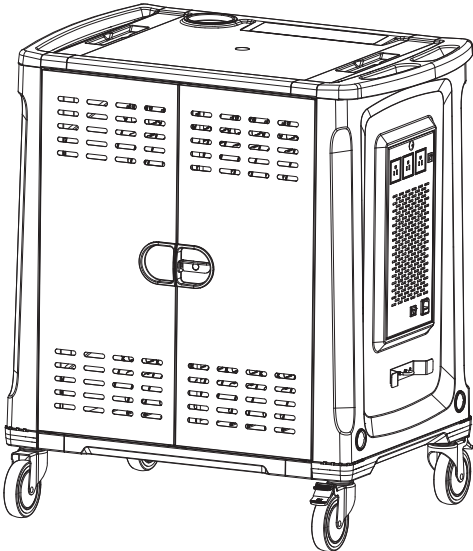

Package Contents



Cable Ties x 42 Units

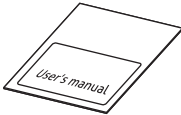

User Manual x 1 Unit

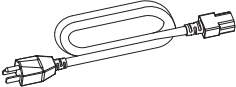

Power Cords x 1 Unit

Suggestion



For 100~125V 50/60Hz 12A



For 200~240V 50/60Hz 10A

3. Feature

1. Charge and store up to 42 Chromebooks, Netbooks, Laptops and Tablets.
2. **5" Healthcare grade Casters with brake lock (2 rigid / 2 swiveling).**
3. 3-point locking mechanism for security.
4. Smart charging mode will keep detect and identify the power current status and switch the charging mode automatically in full charge or cycle charge.
5. 3 external outlets to power all your peripherals from one standard wall outlet.
6. Sliding drawers for easy access to devices.
7. Over current / voltage protection.



A safety lock can be mounted door handle.



3 extra power outlets for external use.



5" Healthcare grade Casters with Brake lock (2 rigid / 2 swiveling).



Wire management for quick and easy storage of cable when not in use.

● Product Overview

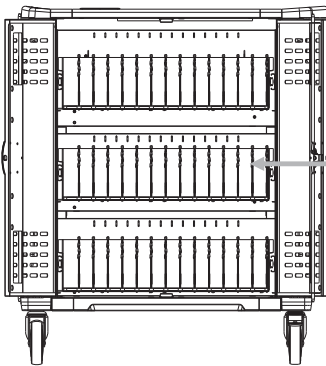
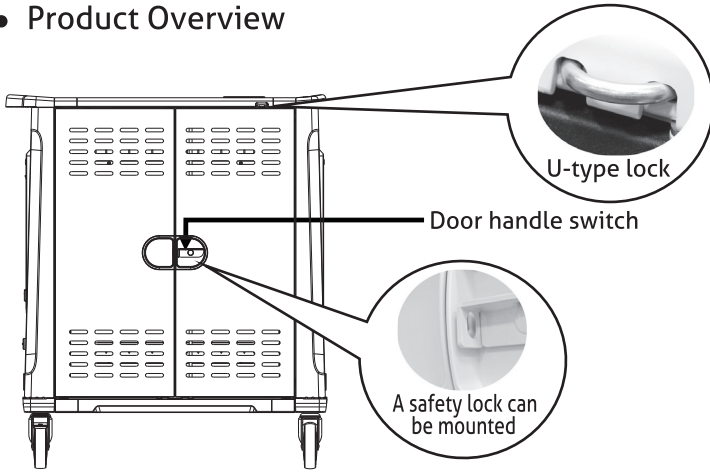

Storage compartments

Slot dimension : H10.24" x D15.28" x W1.34"

Quantity of storage compartments:
14 compartments each layer may
accommodate up to 42 laptops or
tablet PCs

● Back View of Inside

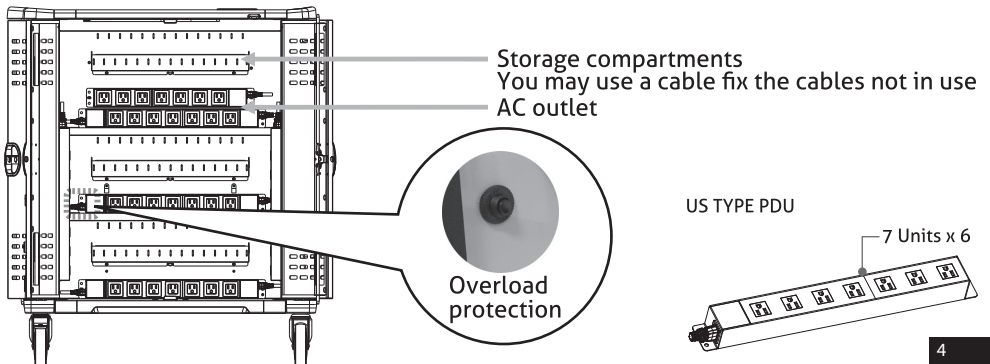

U chain security locking

- ▶ Two U hooks on the top & bottom of the charging cart provided security, the hook can be used to chain down the cart.

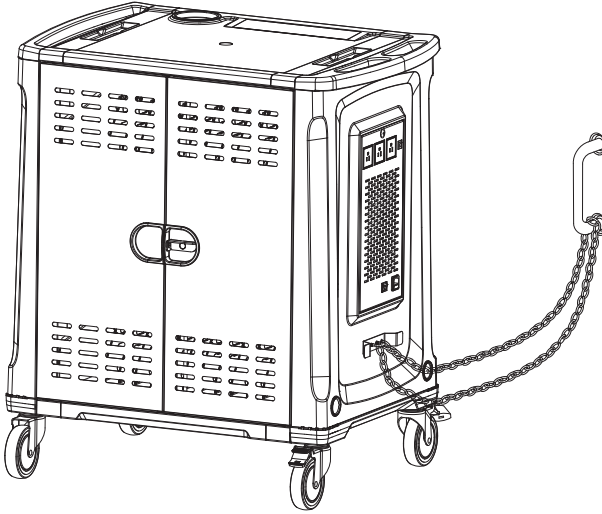

4. Cable Management and charge mode

■ Cable clips for cable management

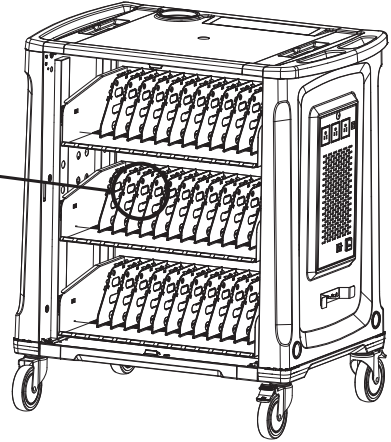
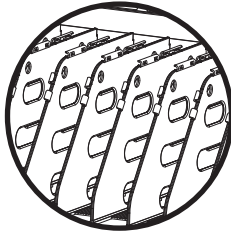

■ Top side of cart

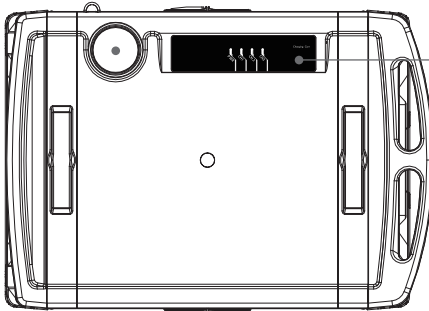

Led indicator

PWR : Color green → Power on
CH1-CH3 : Color white → charging

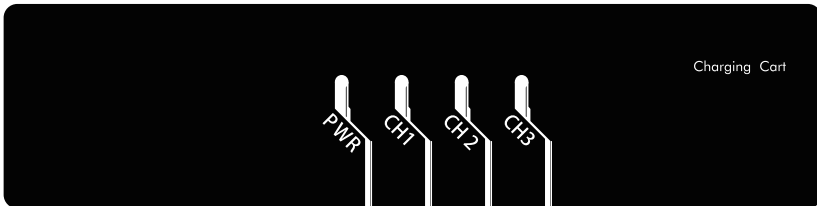

Smart charging

The built-in smart charging system monitors all 42 devices, and determines the best charging sequence. No programming required, the MCU(Micro Control Unit) controls power charging simultaneously on all the outlets to avoid overloading. It is automatic, safe, and Intelligent!

5. Safty & Cautions

Electrical Safety:



WARNING: Failure to observe the following Electrical Safety notices can result in fire or death by electric shock.

1. Inspect power cables carefully before each use.
2. Always turn OFF the power to the product before plugging IN or OUT.
3. Do not unplug by pulling on the cable.
4. Do not unplug the power cord from the outlet when your hands are wet.
5. Do not use cables that are damaged.
6. Do not walk or drive or place objects over the power cable.
7. Do not plug the cable into an extensive cable.
8. Keep the door closed and locked when in use.
9. Keep the Cart away from water.
10. Do not place the Cart close to flammable liquids or gases.

Safe Use Guideline and Recommendations



WARNING: Failure to observe the following Cart Use Safety notices may result in serious personal injury or equipment damage.

1. This product is designed to be used indoors only.
2. This product is not designed to be operated by a child or student. Only Adult operation and supervision is needed at all times.
3. Do not allow anyone to sit, stand or climb on the product.
4. Do not place TV or monitor or any heavy objects on top of the product.
5. Do not use the product to store liquids or cleaning supplies.
6. Move / Push the Cart with caution. (Do not pull the Cart)
7. Keep the door closed and locked when in use and when it is unattended.
8. Keep the castors locked when Cart is not in transit.
9. Keep the ventilation holes unblock for air circulation.
10. Disconnect the power cable from the wall before relocate the main unit.

Cautions when moving the Cart:

Before moving the Cart

1. Disconnect the power cable from the wall.
2. Make sure the cable is wrapped and secure.
3. Close and lock the doors.
4. Unlock the casters.
5. Move / Push the Cart with caution.
6. Do not move the Cart across rough, uneven or irregular surfaces/floor.

Cautions when parking the Cart:

1. Do not park the Cart in areas of heavy traffics.
2. Do not leave Cart in unattended areas where children have access.
3. Keep Cart doors closed and locked whenever it is unattended or parked for charging or storage.
4. Keep Cart casters locked whenever it is unattended or parked for charging or storage.

rocstor®

c  US
LISTED
I.T.E.
E341990



FC CE
Ver.1, Mar. 2017

Rocstor

12979 Arroyo Street
2nd Floor
San Fernando, CA, 91340
www.rocstor.com
+1 (818) 727 7000



ROCSTOR LIMITED WARRANTY - USA

This Limited Warranty is provided by Rocstorage, Inc. (hereinafter: Rocstor) for Volt Charging units.

General Terms

EXCEPT AS EXPRESSLY SET FORTH IN THIS LIMITED WARRANTY, ROCSTOR MAKES NO OTHER WARRANTIES OR CONDITIONS, EXPRESS OR IMPLIED, INCLUDING ANY IMPLIED WARRANTIES OF MERCHANTABILITY AND FITNESS FOR A PARTICULAR PURPOSE. ROCSTOR EXPRESSLY DISCLAIMS ALL WARRANTIES AND CONDITIONS NOT STATED IN THIS LIMITED WARRANTY. ANY IMPLIED WARRANTIES THAT MAY BE IMPOSED BY LAW ARE LIMITED IN DURATION TO THE LIMITED WARRANTY PERIOD. SOME STATES OR COUNTRIES DO NOT ALLOW A LIMITATION ON HOW LONG AN IMPLIED WARRANTY LASTS OR THE EXCLUSION OR LIMITATION OF INCIDENTAL OR CONSEQUENTIAL DAMAGES FOR CONSUMER PRODUCTS. IN SUCH STATES OR COUNTRIES, SOME EXCLUSIONS OR LIMITATIONS OF THIS LIMITED WARRANTY MAY NOT APPLY TO YOU.

This Limited Warranty applies to the Rocstor Volt Charging hardware products sold by or leased from Rocstorage, Inc., its worldwide subsidiaries, affiliates, authorized resellers, or country distributors (collectively referred to in this Limited Warranty as "Rocstor") with this Limited Warranty. This Limited Warranty is applicable in all countries and may be enforced in any country where Rocstor or its authorized service providers offer warranty service subject to the terms and conditions set forth in this Limited Warranty. However, warranty service availability and response times may vary from country to country and may also be subject to registration requirements in the country of purchase.

Rocstor warrants that the Rocstor hardware product and all the internal components of the product that you have purchased or leased from Rocstor are free from defects in materials or workmanship under normal use during the Limited Warranty Period. The Limited Warranty Period starts on the date of purchase or lease from Rocstor. Your dated sales or delivery receipt, showing the date of purchase or lease of the product, is your proof of the purchase or lease date. You may be required to provide proof of purchase or lease as a condition of receiving warranty service. You are entitled to warranty service according to the terms and conditions of this document if a repair to your Rocstor branded hardware is required within the Limited Warranty Period. This Limited Warranty extends only to the original purchaser or lessee of this Rocstor branded product and is not transferable to anyone who obtains ownership of the Rocstor branded product from the original purchaser or lessee.

Rocstor products are manufactured using new materials or new and used materials equivalent to new in performance and reliability. Spare parts may be new or equivalent to new. Spare parts are warranted to be free from defects in material or workmanship for thirty (30) days or for the remainder of the Limited Warranty Period of the Rocstor hardware product in which they are installed, whichever is longer.

Rocstor's Obligation under the Limited Warranty

During the Limited Warranty Period, Rocstor will repair or replace the defective component parts or the hardware product. All component parts or hardware products removed under this Limited Warranty become the property of Rocstor. The replacement part or product takes on either the Limited Warranty status of the removed part or product or the thirty (30) day limited warranty of the spare part. In the unlikely event that your Rocstor product has a recurring failure, Rocstor, at its discretion, may elect to provide you with a replacement unit of Rocstor's choosing that is at least equivalent to your Rocstor branded product in hardware performance. Rocstor reserves the right to elect, at its sole discretion, to give you a refund of your purchase price or lease payments (less interest) instead of a replacement. This is your exclusive remedy for defective products. The original Limited Warranty is not extended when the product, or a part of the product, is repaired or replaced during the Limited Warranty period. Rocstor shall not be responsible or liable for backing up any data that is on a drive being returned for service

YOU SHOULD MAKE PERIODIC BACKUP COPIES OF THE DATA STORED ON YOUR DEVICE HARD DRIVE STORAGE OR OTHER STORAGE DEVICES AS A PRECAUTION AGAINST POSSIBLE FAILURES, ALTERATION, OR LOSS OF THE DATA. BEFORE RETURNING ANY UNIT FOR SERVICE, BE SURE TO BACK UP DATA AND REMOVE ANY CONFIDENTIAL, PROPRIETARY, OR PERSONAL INFORMATION. ROCSTOR IS NOT RESPONSIBLE FOR DAMAGE TO OR LOSS OF ANY PROGRAMS, DATA, OR REMOVABLE STORAGE MEDIA. ROCSTOR IS NOT RESPONSIBLE FOR THE RESTORATION OR REINSTALLATION OF ANY PROGRAMS OR DATA OTHER THAN SOFTWARE INSTALLED BY ROCSTOR WHEN THE PRODUCT WAS MANUFACTURED.

Rocstor does not warrant that the operation of this product will be uninterrupted or error-free. Rocstor is not responsible for damage that occurs as a result of your failure to follow the instructions that came with the Rocstor branded product.

This Limited Warranty does not apply to expendable parts. This Limited Warranty does not extend to any product from which the serial number has been removed or that has been damaged or rendered defective (a) as a result of accident, misuse, abuse, or other external causes; (b) by operation outside the usage parameters stated in the user documentation that shipped with the product and/or posted on the Rocstor website; (c) by the use of parts not manufactured or sold by Rocstor; (d) as a result of normal wear; or (e) by modification or service by anyone other than (i) Rocstor, (ii) a Rocstor authorized service provider, or (iii) your own installation of end-user replaceable Rocstor or Rocstor approved parts if available for your product in the servicing country.

These terms and conditions constitute the complete and exclusive limited warranty agreement between Rocstor and you regarding the Rocstor branded product you have purchased or leased. These terms and conditions supersede any prior agreements or representations including representations made in Rocstor sales literature or advice given to you by Rocstor or an agent or employee of Rocstor that may have been made in connection with your purchase or lease of the Rocstor branded product. No change to the conditions of this Limited Warranty is valid unless it is made in writing and signed by an authorized representative of Rocstor.

Buyer's Obligation under the Warranty

The person requesting coverage under this warranty shall prove that he or she is the original purchaser and declares that the product has not been sold, leased, bartered or otherwise changed possession.

The buyer must notify Rocstor and show proof of notification, through any reasonable means of communication. See Full Street address email address and toll free phone numbers below or updated contact information are available on Rocstor.com website. The notification shall identify any defect, malfunction, or nonconformity promptly upon discovery. Rocstor will acknowledge receipt of the communication and issue a Return Merchandise Authorization (RMA) code. The buyer is obligated to securely and safely package(s) the product, preferably in the original packing materials, WITH THE RMA number, and deliver it together with a copy of the original purchase receipt and a description of the problem to the Rocstor home office. Buyer is responsible for the product until it is received by Rocstor. It is recommended that the product be insured during transportation by the sender. You must prepay any shipping charges, taxes, or duties associated with transportation of the product. In addition, you are responsible for insuring any product shipped or returned for service. You assume risk of loss during shipping.

Limitation of damages (Liability)

IF YOUR ROCSTOR BRANDED HARDWARE PRODUCT FAILS TO WORK AS WARRANTED ABOVE, THE ORIGINAL PURCHASER'S SOLE AND EXCLUSIVE REMEDY SHALL BE REPAIR OR REPLACEMENT. ROCSTOR'S MAXIMUM LIABILITY UNDER THIS LIMITED WARRANTY IS EXPRESSLY LIMITED TO THE LESSER OF THE PRICE YOU HAVE PAID FOR THE PRODUCT OR THE COST OF REPAIR OR REPLACEMENT OF ANY ROCSTOR HARDWARE COMPONENTS THAT

MALFUNCTION IN CONDITIONS OF NORMAL USE. ROCSTOR IS NOT LIABLE FOR ANY DAMAGE TO ANY OTHER PRODUCT CONNECTED TO A ROCSTOR PRODUCT.

Limitation on Consequential Damages

ROCSTOR IS NOT LIABLE FOR ANY DAMAGES CAUSED BY THE PRODUCT OR THE FAILURE OF THE PRODUCT TO PERFORM, INCLUDING ANY LOST PROFITS OR SAVINGS OR SPECIAL, INCIDENTAL OR CONSEQUENTIAL DAMAGES. ROCSTOR IS NOT LIABLE FOR ANY CLAIM MADE BY A THIRD PARTY OR MADE BY YOU FOR A THIRD PARTY. THIS LIMITATION OF LIABILITY ALSO APPLIES WHETHER DAMAGES ARE SOUGHT OR A CLAIM IS MADE UNDER THIS LIMITED WARRANTY OR AS A TORT CLAIM (INCLUDING NEGLIGENCE AND STRICT PRODUCT LIABILITY), A CONTRACT CLAIM OR ANY OTHER CLAIM. THIS LIMITATION OF LIABILITY CANNOT BE WAIVED OR AMENDED BY ANY PERSON. THIS LIMITATION OF LIABILITY WILL BE EFFECTIVE EVEN IF YOU HAVE ADVISED ROCSTOR OR AN AUTHORIZED REPRESENTATIVE OF ROCSTOR OF THE POSSIBILITY OF ANY SUCH DAMAGES.

THIS LIMITED WARRANTY GIVES YOU SPECIFIC LEGAL RIGHTS. YOU MAY ALSO HAVE OTHER RIGHTS THAT MAY VARY FROM STATE TO STATE OR FROM COUNTRY TO COUNTRY. YOU ARE ADVISED TO CONSULT APPLICABLE STATE OR COUNTRY LAWS FOR A FULL DETERMINATION OF YOUR RIGHTS.

Disclaimer

We accept no liability for any loss of data, damages and the inability of Rocstor products to work with any third party equipment. Nor can Rocstor accept any liability or responsibility for software or third party hardware products.

Limited Warranty Period

The limited warranty period for Rocstor Volt Charging units are stated below. This Limited Warranty extends only to the original purchaser or lessee of this Rocstor branded product and is not transferable to anyone who obtains ownership of the Rocstor branded product from the original purchaser or lessee.

Model	Cart/Station/Locker & Trays	Electrical Components
SC10	3 Years	2 Years
SC8	5 Years	5 Years
CW12	5 Years	5 Years
C14	3 Years	2 Years
C24	5 Years	5 Years
C32	5 Years	5 Years
C42	5 Years	5 Years
SC32	5 Years	5 Years
SCL32	5 Years	5 Years
L51	5 Years	5 Years

Types of Limited Warranty Service

Your Rocstor Limited Warranty consists of repair or replacement of defective parts, including hard drives identified by Rocstor Support Organization as "pre-failure."

YOU SHOULD MAKE PERIODIC BACKUP COPIES OF THE DATA STORED ON YOUR HARD DRIVE OR OTHER STORAGE DEVICES AS A PRECAUTION AGAINST POSSIBLE FAILURES, ALTERATION OR LOSS OF THE DATA. BEFORE RETURNING ANY UNIT FOR SERVICE, BE SURE TO BACK UP DATA AND REMOVE ANY CONFIDENTIAL, PROPRIETARY OR PERSONAL INFORMATION. ROCSTORAGE IS NOT RESPONSIBLE FOR DAMAGE TO OR LOSS OF ANY PROGRAMS, DATA OR REMOVABLE STORAGE MEDIA. ROCSTORAGE IS NOT RESPONSIBLE FOR THE RESTORATION OR REINSTALLATION OF ANY PROGRAMS OR DATA OTHER THAN SOFTWARE INSTALLED BY ROCSTORAGE WHEN THE PRODUCT WAS MANUFACTURED.

Rocstorage shall not be responsible or liable for backing up any data that is on a drive being returned for service. Expect that all data on the drive will be destroyed and not retrievable when returned for warranty service.

Carry-in Limited Warranty Service Available Monday - Friday Under the terms of carry-in service, you may be required to deliver your Rocstor product to the Rocstor Service Center or an authorized service location for warranty repair. You must prepay any shipping charges, taxes or duties associated with transportation of the product. In addition, you are responsible for insuring any product shipped or returned for service. You assume risk of loss during shipping.

Rocstor Replaceable Parts Program

Where available, the Rocstor Replaceable Parts program ships approved replacement parts directly to you to fulfill your warranty. This will save considerable repair time. After you call the Rocstor Technical Support Center at **818.727.7000** a replaceable part can be sent directly to you. Once the part arrives, call the Rocstor Technical Support Center. A technician will assist you over the phone to ensure that the installation is quick and easy.

Service Upgrades

Rocstor offers extra coverage for your product. For information on service upgrades, visit www.rocstor.com. Service upgrades purchased in one country are not transferable to another country.

Options and Software

The Limited Warranty terms and conditions for Rocstor options are as indicated in the Limited Warranty applicable to Rocstor options. **ROCSTOR DOES NOT WARRANTY SOFTWARE PRODUCTS, INCLUDING ANY SOFTWARE PRODUCTS OR THE OPERATING SYSTEM PREINSTALLED BY ROCSTOR.** Rocstor's only obligations with respect to software distributed by Rocstor under the Rocstor brand name are set forth in the applicable end-user license or program license agreement. Non-Rocstor hardware and software products are provided "AS IS" and without any Warranty. However, non-Rocstor manufacturers, suppliers or publishers may provide their own warranties directly to you.

The data stored in Rocstor and Rocsecure storage product lines are not guaranteed by Rocstor (or the hard disk manufacturer.) We are not responsible for any loss of data. Always back up data regularly

TECHNICAL SUPPORT

Software Technical Support

Software technical support is defined as assistance with questions and issues about the software that was either preinstalled by Rocstor on the Rocstor branded product or that was included with the Rocstor branded product at the time of your purchase or lease of the product. Technical support for software is available for the first ninety (90) days from date of product purchase or lease. Your dated sales or delivery receipt, showing the date of purchase or lease of the product, is your proof of the purchase or lease date. You may be required to provide proof of purchase or lease as a condition of receiving software technical support. After the first ninety (90) days, technical support for software that was either preinstalled by Rocstor on the Rocstor branded product or included with the Rocstor branded product at the time of your purchase or lease of the product is available for a fee.

WARNING: The individual user should take care to determine prior to use whether this device is suitable, adequate or safe for the use intended. Since individual applications are subject to great variation, the manufacturer

"Rocstor" makes no representation or warranty as to the suitability or fitness of these devices for any specific application.

Technical Support

All Rocstor hard drives are backed by free telephone technical support for two (3) years from the date of purchase. Please register your product with Rocstor. To register, fill in the Limited Warranty Registration form in the Support tab at www.rocstor.com.

Free telephone technical support is available weekdays from 9 AM until 6 PM Pacific Standard Time. Customers in the United States and Canada can call toll-free: **(818) 727-7000**; all others must call **(818) 727-7000**.

When calling for support, please have the product's serial number (printed on the label on the bottom of the drive) and system hardware information available.

Trademarks Acknowledgements

© 2019, Rocstorage, Inc; acknowledges the following trademarks for company names or products mentioned within the Rocstor site, portal pages and articles/text/manuals:

Rocstor, Rocsecure and Rocpower are registered trademarks of Rocstorage, Inc. Amphibious, Rocport, Rocbit, Rocsafe, Enteroc, Volt, PrivacyView, Rocbolt are the trademarks of Rocstorage, Inc. "store your future", "secure your future" and "power your future" are the slogan marks of Rocstorage, Inc.

Apple, the Apple logo, Mac, Power Macintosh, FireWire, and Mac Pro, Leopard, Snow Leopard ... are trademarks of Apple Computer, Inc. in the United States and other countries.

Microsoft, MS-DOS, Windows CE, Windows NT, Windows 98, Soft Windows, Vista, Windows 7, 8, 10 are registered trademarks of Microsoft Corporation in the United States and other countries.

Intel, Itanium, Pentium, Celeron, and Xeon MMX are registered U.S. trademarks of Intel Corporation or its subsidiaries in the United States and other countries.

This product is (may also be) integrated with SATA hard drives from the following manufactures: Seagate, Samsung, Western Digital, Hitachi, Toshiba, Fujitsu ...

All other names are trademarks of their respective companies.

Rocstor wishes to acknowledge the use of tables, charts, graphs and texts from the Wikipedia website.

© 2000 - 2019

Rocstor is a California Company; U.S.A.

Contact Information

Corporate Headquarters

12979 Arroyo Street, 2nd Floor
San Fernando, California 91340
U.S.A. Office: +1 (818) 727-7000
Email: info@Rocstor.com

Technical Support / RMA

Tel: (818) 727-7000 (USA and Canada)
Tel: +1 (818) 727-7000 (Domestic and

Hours: 9:00 am - 5:00 pm PST
Mon - Fri (excluding holidays)
Email: support@Rocstor.com

Sales Info

Hours: 9:00 am - 5:00 pm PST
Mon - Fri (excluding holidays)
Email: sales@Rocstor.com

Corporate, Government and Academic Customers

Our Corporate Sales Team's goal is to help our U.S.A. and Canadian customers find a storage solution that best serves their needs. We will help you determine your best purchasing options. For more information please contact the appropriate department below or call us at +1 (888) 877-7716

General sales information: sales@Rocstor.com
Corporate sales information: corporate_sales@Rocstor.com
Educational sales information: academic_sales@Rocstor.com
Federal, State & Local government sales information: government_sales@Rocstor.com

© 2019 Rocstorage, Inc. This Manual is protected by United States copyright law and may not be reproduced, distributed, transmitted, displayed, published or broadcast without the prior written permission of Rocstorage, Inc. You may not alter or remove any trademark, copyright or other notice from copies of this Manual.