



SRX300 Services Gateway Hardware Guide



Modified: 2017-02-27

Juniper Networks, Inc.
1133 Innovation Way
Sunnyvale, California 94089
USA
408-745-2000
www.juniper.net

Copyright © 2017, Juniper Networks, Inc. All rights reserved.

Juniper Networks, Junos, Steel-Belted Radius, NetScreen, and ScreenOS are registered trademarks of Juniper Networks, Inc. in the United States and other countries. The Juniper Networks Logo, the Junos logo, and JunosE are trademarks of Juniper Networks, Inc. All other trademarks, service marks, registered trademarks, or registered service marks are the property of their respective owners.

Juniper Networks assumes no responsibility for any inaccuracies in this document. Juniper Networks reserves the right to change, modify, transfer, or otherwise revise this publication without notice.

SRX300 Services Gateway Hardware Guide

Copyright © 2017, Juniper Networks, Inc.
All rights reserved.

The information in this document is current as of the date on the title page.

YEAR 2000 NOTICE

Juniper Networks hardware and software products are Year 2000 compliant. Junos OS has no known time-related limitations through the year 2038. However, the NTP application is known to have some difficulty in the year 2036.

END USER LICENSE AGREEMENT

The Juniper Networks product that is the subject of this technical documentation consists of (or is intended for use with) Juniper Networks software. Use of such software is subject to the terms and conditions of the End User License Agreement ("EULA") posted at <http://www.juniper.net/support/eula.html>. By downloading, installing or using such software, you agree to the terms and conditions of that EULA.

Table of Contents

	About the Documentation	xi
	Documentation and Release Notes	xi
	Supported Platforms	xi
	Documentation Conventions	xi
	Documentation Feedback	xiii
	Requesting Technical Support	xiv
	Self-Help Online Tools and Resources	xiv
	Opening a Case with JTAC	xiv
Part 1	Overview	
Chapter 1	System Overview	3
	SRX300 Services Gateway Description	3
	SRX300 Services Gateway CLI and J-Web Access	3
Chapter 2	Chassis Description	5
	SRX300 Services Gateway Chassis Overview	5
	Understanding the SRX300 Services Gateway Front Panel	5
	Understanding the SRX300 Services Gateway Back Panel	7
Chapter 3	Power System Description	9
	Understanding the SRX300 Services Gateway Power Supply	9
Part 2	Site Planning and Specifications	
Chapter 4	Planning and Preparing the Site	13
	SRX300 Services Gateway Physical Specifications	13
	SRX300 Services Gateway Environmental Specifications	13
	Site Preparation Checklist for the SRX300 Services Gateway	14
	General Site Installation Guidelines for the SRX300 Services Gateway	16
Chapter 5	Rack Requirements	19
	SRX300 Services Gateway Rack-Mounting Requirements and Warnings	19
	SRX300 Services Gateway Rack Size and Strength Requirements	23
	SRX300 Services Gateway Spacing of Mounting Brackets and Flange Holes	23
	SRX300 Services Gateway Clearance Requirements for Airflow and Hardware Maintenance	24
Chapter 6	Cabinet Requirements	25
	SRX300 Services Gateway Cabinet Size and Clearance Requirements	25
	SRX300 Services Gateway Cabinet Airflow Requirements	25

Chapter 7	Power Requirements and Specifications	27
	SRX300 Services Gateway Electrical Wiring Guidelines	27
	SRX300 Services Gateway Power Specifications and Requirements	28
Chapter 8	Cable Specifications and Pinouts	29
	RJ-45 Connector Pinouts for the SRX300 Services Gateway Ethernet Port	29
	RJ-45 Connector Pinouts for the SRX300 Services Gateway Console Port	29
	Mini-USB Connector Pinouts for the SRX300 Services Gateway Console Port	30
Part 3	Initial Installation and Configuration	
Chapter 9	Installation Overview	35
	SRX300 Services Gateway Installation Overview	35
	Required Tools and Parts for Installing the SRX300 Services Gateway	36
	SRX300 Services Gateway Autoinstallation Overview	36
Chapter 10	Unpacking the SRX300 Services Gateway	37
	Unpacking the SRX300 Services Gateway	37
	Verifying Parts Received with the SRX300 Services Gateway	37
Chapter 11	Installing the Rack Mounting Hardware	39
	Preparing the SRX300 Services Gateway for Rack-Mount Installation	39
	Preparing the SRX300 Services Gateway for Wall-Mount Installation	40
	Preparing the SRX300 Services Gateway for Desk-Mount Installation	40
	Connecting the SRX300 Services Gateway to the Building Structure	41
Chapter 12	Installing the SRX300 Services Gateway in a Rack	43
	Installing the SRX300 Services Gateway in a Rack	43
	Installing the SRX300 Services Gateway on a Wall	45
	Installing the SRX300 Services Gateway on a Desk	47
Chapter 13	Connecting the SRX300 Services Gateway to Ground	49
	Required Tools and Parts for Grounding the SRX300 Services Gateway	49
	SRX300 Services Gateway Grounding Specifications	49
	Connecting the SRX300 Services Gateway Grounding Cable	50
Chapter 14	Connecting the SRX300 Services Gateway to External Devices	53
	Connecting the Dial-Up Modem to the Console Port on the SRX300 Services Gateway	53
	Connecting to the SRX300 Services Gateway CLI Using a Dial-Up Modem	54
Chapter 15	Providing Power to the SRX300 Services Gateway	55
	Connecting the SRX300 Services Gateway to the Power Supply	55
	Powering On the SRX300 Services Gateway	56
	Powering Off the SRX300 Services Gateway	56

Chapter 16	Performing the Initial Configuration	59
	SRX300 Services Gateway Software Configuration Overview	59
	Understanding SRX300 Services Gateway Factory-Default Settings	59
	Viewing SRX300 Services Gateway Factory-Default Settings	60
	Accessing J-Web on the SRX300 Services Gateway	62
	Configuring the SRX300 Services Gateway Using the J-Web Setup Wizard	63
	About the Setup Wizard	63
	About the Default Setup Mode	64
	About the Guided Setup Mode	64
	Accessing the CLI on the SRX300 Services Gateway	65
	Connecting to the SRX300 Services Gateway from the CLI Remotely	66
	Configuring the SRX300 Services Gateway Using the CLI	67
	Verifying Settings for the SRX300 Services Gateway	69
Part 4	Maintaining and Troubleshooting Components	
Chapter 17	Maintaining Components	73
	Required Tools and Parts for Maintaining the SRX300 Services Gateway	
	Hardware Components	73
	Routine Maintenance Procedures for the SRX300 Services Gateway	73
	Maintaining the SRX300 Services Gateway Power Supply	74
Chapter 18	Troubleshooting Components	75
	Troubleshooting Resources for the SRX300 Services Gateway Overview	75
	Troubleshooting Chassis and Interface Alarm Messages on the SRX300 Services Gateway	76
	Troubleshooting the Power System on the SRX300 Services Gateway	77
	Using the RESET CONFIG Button on the SRX300 Services Gateway	77
	Changing the RESET CONFIG Button Behavior on the SRX300 Services Gateway	78
Part 5	Replacing Components	
Chapter 19	Contacting Customer Support and Returning Components	81
	Contacting Customer Support	81
	Returning a SRX300 Services Gateway Component to Juniper Networks	82
	Locating the SRX300 Services Gateway Chassis Serial Number and Agency Labels	83
	Listing the SRX300 Services Gateway Component Details with the CLI	83
	Information You Might Need to Supply to JTAC	84
	Required Tools and Parts for Packing the SRX300 Services Gateway	84
	Packing the SRX300 Services Gateway for Shipment	84
	Packing SRX300 Services Gateway Components for Shipment	85
Part 6	Safety and Regulatory Compliance Information	
Chapter 20	General Safety Guidelines and Warnings	89
	SRX300 Services Gateway Definition of Safety Warning Levels	89
	SRX300 Services Gateway General Safety Guidelines and Warnings	91
	SRX300 Services Gateway Safety Requirements, Warnings, and Guidelines	92

	Restricted Access Area Warning	92
	Qualified Personnel Warning	94
	Preventing Electrostatic Discharge Damage to the SRX300 Services Gateway	95
Chapter 21	Fire Safety Requirements	97
	SRX300 Services Gateway Fire Safety Requirements and Fire Suppression Equipment	97
Chapter 22	Laser and LED Safety Guidelines and Warnings	99
	General Laser Safety Guidelines	99
	Class 1 Laser Warning	100
	Class 1 LED Product Warning	100
	Laser Beam Warning	101
	Radiation from Open Port Apertures Warning	102
Chapter 23	Maintenance and Operational Safety Guidelines and Warnings	103
	Battery-Handling Warning	103
	Lightning Activity Warning	104
	Jewelry Removal Warning	105
	Operating Temperature Warning	106
	Product Disposal Warning	108
Chapter 24	Electrical Safety Guidelines and Warnings	111
	In Case of Electrical Accident	111
	General Electrical Safety Guidelines and Warnings	111
Chapter 25	Agency Approvals and Regulatory Compliance Information	113
	SRX300 Services Gateway Agency Approvals	113
	SRX300 Services Gateway EMC Requirements	114
	Canada	114
	European Community	114
	Israel	115
	Japan	115
	United States	115

List of Figures

Part 1	Overview	
Chapter 2	Chassis Description	5
	Figure 1: SRX300 Services Gateway Front Panel	5
	Figure 2: SRX300 Services Gateway Front Panel LEDs	7
	Figure 3: SRX300 Services Gateway Back Panel	8
Part 3	Initial Installation and Configuration	
Chapter 12	Installing the SRX300 Services Gateway in a Rack	43
	Figure 4: SRX300 Services Gateway Rack Installation — Positioning the Mounting Brackets	44
	Figure 5: SRX300 Services Gateway Rack Installation — Securing the Mounting Brackets and Power Supply Adapter Tray	44
	Figure 6: SRX300 Services Gateway Rack Installation — Positioning the Power Supply Adapter Tray	44
	Figure 7: SRX300 Services Gateway Rack Installation — Positioning the SRX300 Services Gateway in a Rack	45
	Figure 8: Attaching Wall-Mount Brackets	46
	Figure 9: Orienting the SRX300 Services Gateway on a Wall	46
	Figure 10: Mounting the SRX300 Services Gateway on a Wall	47
Chapter 13	Connecting the SRX300 Services Gateway to Ground	49
	Figure 11: Connecting the Grounding Cable to the SRX300 Services Gateway	51
Chapter 15	Providing Power to the SRX300 Services Gateway	55
	Figure 12: Connecting the SRX300 Services Gateway to the Power Supply	55
Chapter 16	Performing the Initial Configuration	59
	Figure 13: Connecting to the Ethernet Port on the SRX300 Services Gateway	62
	Figure 14: Connecting to the Console Port on the SRX300 Services Gateway	66
Part 6	Safety and Regulatory Compliance Information	
Chapter 20	General Safety Guidelines and Warnings	89
	Figure 15: Placing a Component into an Electrostatic Bag	95

List of Tables

	About the Documentation	xi
	Table 1: Notice Icons	xii
	Table 2: Text and Syntax Conventions	xii
Part 1	Overview	
Chapter 2	Chassis Description	5
	Table 3: SRX300 Services Gateway Front Panel Components	6
	Table 4: SRX300 Services Gateway Front Panel LEDs	7
	Table 5: SRX300 Services Gateway Back Panel Components	8
Part 2	Site Planning and Specifications	
Chapter 4	Planning and Preparing the Site	13
	Table 6: Physical Specifications for the SRX300 Services Gateway	13
	Table 7: Environmental Specifications for the SRX300 Services Gateway	14
	Table 8: Site Preparation Checklist for SRX300 Services Gateway Installation	14
Chapter 7	Power Requirements and Specifications	27
	Table 9: Site Electrical Wiring Guidelines for the SRX300 Services Gateway	27
	Table 10: Power Specifications for the SRX300 Services Gateway Power Supply Adapter	28
Chapter 8	Cable Specifications and Pinouts	29
	Table 11: RJ-45 Connector Pinouts for the SRX300 Services Gateway Ethernet Port	29
	Table 12: RJ-45 Connector Pinouts for the SRX300 Services Gateway Console Port	30
	Table 13: Mini-USB Type-B Connector Pinouts for the Services Gateway Console Port	30
Part 3	Initial Installation and Configuration	
Chapter 10	Unpacking the SRX300 Services Gateway	37
	Table 14: Parts List for a Fully Configured SRX300 Services Gateway	38
	Table 15: Accessory/Upgrade Parts List for the SRX300 Services Gateway	38
Chapter 13	Connecting the SRX300 Services Gateway to Ground	49
	Table 16: Grounding Cable Specifications for the Services Gateway	50
Chapter 16	Performing the Initial Configuration	59
	Table 17: Default Interface Configuration for the SRX300 Services Gateway	60

Part 4	Maintaining and Troubleshooting Components	
Chapter 18	Troubleshooting Components	75
	Table 18: SRX300 Services Gateway Chassis Alarm Conditions and Corrective Actions	76
	Table 19: Services Gateway Power LED Status	77

About the Documentation

- Documentation and Release Notes on page xi
- Supported Platforms on page xi
- Documentation Conventions on page xi
- Documentation Feedback on page xiii
- Requesting Technical Support on page xiv

Documentation and Release Notes

To obtain the most current version of all Juniper Networks[®] technical documentation, see the product documentation page on the Juniper Networks website at <http://www.juniper.net/techpubs/>.

If the information in the latest release notes differs from the information in the documentation, follow the product Release Notes.

Juniper Networks Books publishes books by Juniper Networks engineers and subject matter experts. These books go beyond the technical documentation to explore the nuances of network architecture, deployment, and administration. The current list can be viewed at <http://www.juniper.net/books>.

Supported Platforms

For the features described in this document, the following platforms are supported:

- SRX300

Documentation Conventions

Table 1 on page xii defines notice icons used in this guide.

Table 1: Notice Icons







Icon	Meaning	Description
	Informational note	Indicates important features or instructions.
	Caution	Indicates a situation that might result in loss of data or hardware damage.
	Warning	Alerts you to the risk of personal injury or death.
	Laser warning	Alerts you to the risk of personal injury from a laser.
	Tip	Indicates helpful information.
	Best practice	Alerts you to a recommended use or implementation.

Table 2 on page xii defines the text and syntax conventions used in this guide.

Table 2: Text and Syntax Conventions

Convention	Description	Examples
Bold text like this	Represents text that you type.	To enter configuration mode, type the configure command: user@host> configure
Fixed-width text like this	Represents output that appears on the terminal screen.	user@host> show chassis alarms No alarms currently active
<i>Italic text like this</i>	<ul style="list-style-type: none"> Introduces or emphasizes important new terms. Identifies guide names. Identifies RFC and Internet draft titles. 	<ul style="list-style-type: none"> A policy <i>term</i> is a named structure that defines match conditions and actions. <i>Junos OS CLI User Guide</i> RFC 1997, <i>BGP Communities Attribute</i>
<i>Italic text like this</i>	Represents variables (options for which you substitute a value) in commands or configuration statements.	Configure the machine's domain name: [edit] root@# set system domain-name <i>domain-name</i>

Table 2: Text and Syntax Conventions (*continued*)

Convention	Description	Examples
Text like this	Represents names of configuration statements, commands, files, and directories; configuration hierarchy levels; or labels on routing platform components.	<ul style="list-style-type: none"> To configure a stub area, include the stub statement at the <code>[edit protocols ospf area area-id]</code> hierarchy level. The console port is labeled CONSOLE.
< > (angle brackets)	Encloses optional keywords or variables.	stub <default-metric <i>metric</i> >;
(pipe symbol)	Indicates a choice between the mutually exclusive keywords or variables on either side of the symbol. The set of choices is often enclosed in parentheses for clarity.	broadcast multicast <i>(string1 string2 string3)</i>
# (pound sign)	Indicates a comment specified on the same line as the configuration statement to which it applies.	rsvp { # Required for dynamic MPLS only
[] (square brackets)	Encloses a variable for which you can substitute one or more values.	community name members [community-ids]
Indentation and braces ({ })	Identifies a level in the configuration hierarchy.	<code>[edit] routing-options { static { route default { nexthop <i>address</i>; retain; } } }</code>
;(semicolon)	Identifies a leaf statement at a configuration hierarchy level.	
GUI Conventions		
Bold text like this	Represents graphical user interface (GUI) items you click or select.	<ul style="list-style-type: none"> In the Logical Interfaces box, select All Interfaces. To cancel the configuration, click Cancel.
> (bold right angle bracket)	Separates levels in a hierarchy of menu selections.	In the configuration editor hierarchy, select Protocols>Ospf .

Documentation Feedback

We encourage you to provide feedback, comments, and suggestions so that we can improve the documentation. You can provide feedback by using either of the following methods:

- Online feedback rating system—On any page of the Juniper Networks TechLibrary site at <http://www.juniper.net/techpubs/index.html>, simply click the stars to rate the content, and use the pop-up form to provide us with information about your experience. Alternately, you can use the online feedback form at <http://www.juniper.net/techpubs/feedback/>.

- E-mail—Send your comments to techpubs-comments@juniper.net. Include the document or topic name, URL or page number, and software version (if applicable).

Requesting Technical Support

Technical product support is available through the Juniper Networks Technical Assistance Center (JTAC). If you are a customer with an active J-Care or Partner Support Service support contract, or are covered under warranty, and need post-sales technical support, you can access our tools and resources online or open a case with JTAC.

- JTAC policies—For a complete understanding of our JTAC procedures and policies, review the *JTAC User Guide* located at <http://www.juniper.net/us/en/local/pdf/resource-guides/7100059-en.pdf>.
- Product warranties—For product warranty information, visit <http://www.juniper.net/support/warranty/>.
- JTAC hours of operation—The JTAC centers have resources available 24 hours a day, 7 days a week, 365 days a year.

Self-Help Online Tools and Resources

For quick and easy problem resolution, Juniper Networks has designed an online self-service portal called the Customer Support Center (CSC) that provides you with the following features:

- Find CSC offerings: <http://www.juniper.net/customers/support/>
- Search for known bugs: <http://www2.juniper.net/kb/>
- Find product documentation: <http://www.juniper.net/techpubs/>
- Find solutions and answer questions using our Knowledge Base: <http://kb.juniper.net/>
- Download the latest versions of software and review release notes: <http://www.juniper.net/customers/csc/software/>
- Search technical bulletins for relevant hardware and software notifications: <http://kb.juniper.net/InfoCenter/>
- Join and participate in the Juniper Networks Community Forum: <http://www.juniper.net/company/communities/>
- Open a case online in the CSC Case Management tool: <http://www.juniper.net/cm/>

To verify service entitlement by product serial number, use our Serial Number Entitlement (SNE) Tool: <https://tools.juniper.net/SerialNumberEntitlementSearch/>

Opening a Case with JTAC

You can open a case with JTAC on the Web or by telephone.

- Use the Case Management tool in the CSC at <http://www.juniper.net/cm/>.
- Call 1-888-314-JTAC (1-888-314-5822 toll-free in the USA, Canada, and Mexico).

For international or direct-dial options in countries without toll-free numbers, see <http://www.juniper.net/support/requesting-support.html>.

PART 1

Overview

- [System Overview on page 3](#)
- [Chassis Description on page 5](#)
- [Power System Description on page 9](#)

CHAPTER 1

System Overview

- [SRX300 Services Gateway Description on page 3](#)
- [SRX300 Services Gateway CLI and J-Web Access on page 3](#)

SRX300 Services Gateway Description

The SRX300 Services Gateway consolidates networking and security capabilities for small retail offices. The services gateway provides cost-effective, scalable integration of routing, security, and switching in a single device. The SRX300 Services Gateway provides firewall support with key features such as IP security (IPsec) VPN and Unified Threat Management (UTM).

With a desktop form-factor chassis, the SRX300 Services Gateway has eight 1 G Ethernet ports, two 1 G SFP ports, 4 GB of DRAM memory, and 8 GB of flash memory.

The SRX300 Services Gateway runs the Junos operating system (Junos OS) and supports the following features:

- Firewall support with key features such as IPsec and VPN
- Intrusion Detection and Prevention (IDP)
- High availability
- QoS
- MPLS

Related Documentation

- [SRX300 Services Gateway Chassis Overview on page 5](#)
- [Understanding the SRX300 Services Gateway Front Panel on page 5](#)
- [Understanding the SRX300 Services Gateway Back Panel on page 7](#)

SRX300 Services Gateway CLI and J-Web Access

The SRX300 Services Gateway runs the Junos operating system (Junos OS). You can use two user interfaces to monitor, configure, troubleshoot, and manage the services gateway:

- J-Web interface—A Web-based graphical interface that allows you to operate the services gateway without commands.
- Junos OS command-line interface (CLI)—Juniper Networks command shell that runs on top of a UNIX-based operating system kernel. The CLI is a straightforward command interface. On a single line, you type commands that are executed when you press the Enter key. The CLI provides command help and command completion.

In addition, you can also use Junos Space Security Director to define and manage security policies on the services gateway.

**Related
Documentation**

- [SRX300 Services Gateway Chassis Overview on page 5](#)

Table 3 on page 6 provides details about the front panel components.

Table 3: SRX300 Services Gateway Front Panel Components

Number	Component	Description
1	Reset Config button	Returns the services gateway to the rescue configuration or the factory-default configuration.
2	Serial Console port	Connects a laptop to the services gateway for CLI management. The port uses an RJ-45 serial connection and supports the RS-232 (EIA-232) standard.
3	1 G Ethernet ports	<p>Six Gigabit Ethernet LAN ports (0/0 to 0/5)</p> <p>The Gigabit Ethernet ports have the following characteristics:</p> <ul style="list-style-type: none"> • Use an RJ-45 connector • Operate in full-duplex and half-duplex modes • Support flow control • Support autonegotiation <p>The Gigabit Ethernet ports can be used to:</p> <ul style="list-style-type: none"> • Function as front-end network ports • Provide LAN and WAN connectivity to hubs, switches, local servers, and workstations • Forward incoming data packets to the services gateway • Receive outgoing data packets from the services gateway
4	1 G SFP ports	Two 1 G small form-factor pluggable (SFP) ports for network traffic
5	ESD point	For personal safety, while working on the services gateway, use the ESD outlet to plug in an ESD grounding strap to prevent your body from sending static charges to the services gateway.
6	Mini-USB console port	Connects a laptop to the services gateway for CLI management through a USB interface. The port accepts a Mini-B type USB cable plug. A USB cable with Mini-B and Type A USB plugs is supplied with the services gateway. To use the USB console port, you must download a USB driver to the management device from the SRX300 Software Download page or Silicon Labs page.
7	USB port	The services gateway has one USB port that accepts a USB storage device.
8	LEDs	Indicates component and system status, and troubleshooting information at a glance.
9	Power button	Use the Power button to shut down the services gateway.

Figure 2 on page 7 shows the LEDs on the front panel.

Figure 2: SRX300 Services Gateway Front Panel LEDs

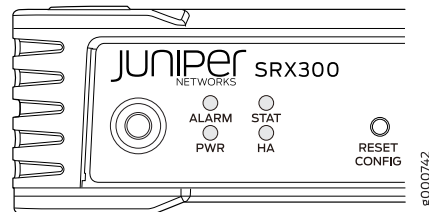

Table 4 on page 7 lists the front panel LEDs.

Table 4: SRX300 Services Gateway Front Panel LEDs

Component	Description
ALARM	<ul style="list-style-type: none"> • Solid amber (noncritical alarm) • Solid red (critical alarm) • Off (no alarms)
STAT	<ul style="list-style-type: none"> • Solid green (operating normally) • Solid amber <ul style="list-style-type: none"> • Device is starting up • Committing rescue configuration • Committing clear configuration • Solid red (error detected)
PWR	<ul style="list-style-type: none"> • Solid green (receiving power) • Solid red (power failure) • Off (no power)
HA	<ul style="list-style-type: none"> • Solid green (all HA links are available) • Solid amber (some HA links are unavailable) • Solid red (HA links are not functional) • Off (HA is disabled)

- Related Documentation**
- [SRX300 Services Gateway Chassis Overview on page 5](#)
 - [Understanding the SRX300 Services Gateway Back Panel on page 7](#)

Understanding the SRX300 Services Gateway Back Panel

Figure 3 on page 8 shows the back panel of the SRX300 Services Gateway and Table 5 on page 8 lists the back panel components.

Figure 3: SRX300 Services Gateway Back Panel

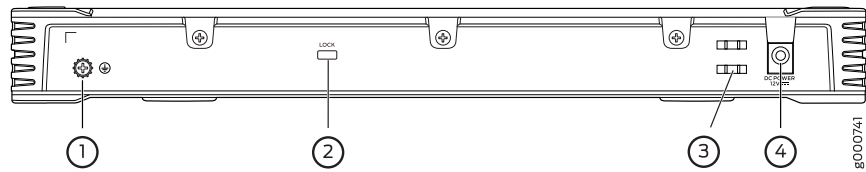

Table 5: SRX300 Services Gateway Back Panel Components

Number	Component	Description
1	Grounding point	Connects the services gateway chassis to earth ground (optional). <i>NOTE:</i> We recommend connecting the services gateway to ground if required.
2	Lock	Provides the capability to lock and secure the device at the installation site.
3	Cable tie holder	Secures the DC power cord connection to the adapter.
4	Power supply input	Connects the services gateway to the external power supply.

Related Documentation

- [SRX300 Services Gateway Chassis Overview on page 5](#)
- [Understanding the SRX300 Services Gateway Front Panel on page 5](#)

CHAPTER 3

Power System Description

- [Understanding the SRX300 Services Gateway Power Supply on page 9](#)

Understanding the SRX300 Services Gateway Power Supply

The power supply for the SRX300 Services Gateway is external. You must use the AC to DC, 60 W power supply adapter provided by Juniper Networks to provide power to the services gateway. The adapter provides an output of 12 VDC, 5 A.

Related Documentation

- [Connecting the SRX300 Services Gateway to the Power Supply on page 55](#)
- [Powering On the SRX300 Services Gateway on page 56](#)
- [Powering Off the SRX300 Services Gateway on page 56](#)

PART 2

Site Planning and Specifications

- Planning and Preparing the Site on page 13
- Rack Requirements on page 19
- Cabinet Requirements on page 25
- Power Requirements and Specifications on page 27
- Cable Specifications and Pinouts on page 29

CHAPTER 4

Planning and Preparing the Site

- [SRX300 Services Gateway Physical Specifications on page 13](#)
- [SRX300 Services Gateway Environmental Specifications on page 13](#)
- [Site Preparation Checklist for the SRX300 Services Gateway on page 14](#)
- [General Site Installation Guidelines for the SRX300 Services Gateway on page 16](#)

SRX300 Services Gateway Physical Specifications

[Table 6 on page 13](#) lists the physical specifications for the services gateway.

Table 6: Physical Specifications for the SRX300 Services Gateway

Physical Specification of Chassis	Value
Height	1.37 in.
Width	12.63 in.
Depth	7.52 in.
Weight	4.38 lb

Related Documentation

- [SRX300 Services Gateway Description on page 3](#)
- [SRX300 Services Gateway Chassis Overview on page 5](#)
- [SRX300 Services Gateway Environmental Specifications on page 13](#)
- [Understanding the SRX300 Services Gateway Front Panel on page 5](#)
- [Understanding the SRX300 Services Gateway Back Panel on page 7](#)

SRX300 Services Gateway Environmental Specifications

[Table 7 on page 14](#) provides the required environmental conditions for normal SRX300 Services Gateway operations.

Table 7: Environmental Specifications for the SRX300 Services Gateway

Description	Value
Altitude	No performance degradation up to 10,000 ft (3048 m)
Relative humidity	5% to 95%, noncondensing
Temperature	<ul style="list-style-type: none"> Operational temperature—32° F (0° C) to 104° F (40° C) Nonoperational temperature—4° F (-20° C) to 158° F (70° C)
Average power consumption	15.4 W
DC Input rating	12 VDC, 2.8 A maximum
Average heat dissipation	85 BTU/hr
Noise level	0 dB (fanless)

Related Documentation

- [Site Preparation Checklist for the SRX300 Services Gateway on page 14](#)
- [General Site Installation Guidelines for the SRX300 Services Gateway on page 16](#)
- [SRX300 Services Gateway Physical Specifications on page 13](#)

Site Preparation Checklist for the SRX300 Services Gateway

Table 8 on page 14 provides a checklist of tasks you need to perform when preparing a site for installing the SRX300 Services Gateway.

Table 8: Site Preparation Checklist for SRX300 Services Gateway Installation

Item or Task	Additional Information	Performed By	Date	Notes
Environment				
Verify that environmental factors such as temperature and humidity do not exceed device tolerances.	"SRX300 Services Gateway Environmental Specifications" on page 13			
Power				

Table 8: Site Preparation Checklist for SRX300 Services Gateway Installation (*continued*)

Item or Task	Additional Information	Performed By	Date	Notes
<ul style="list-style-type: none"> Measure the distance between the external power sources and the device installation site. Locate sites for connection of system grounding. Calculate the power consumption and requirements. 	<p>“SRX300 Services Gateway Electrical Wiring Guidelines” on page 27</p> <p>“SRX300 Services Gateway Power Specifications and Requirements” on page 28</p>			
Rack Requirements				
Verify that your rack meets the minimum requirements.	“SRX300 Services Gateway Rack-Mounting Requirements and Warnings” on page 19			
Rack Installation				
<ul style="list-style-type: none"> Plan the rack location, including required space clearances. Secure the rack to the floor and building structure. 	“Preparing the SRX300 Services Gateway for Rack-Mount Installation” on page 39			
Cabinet Requirements				
<ul style="list-style-type: none"> Verify that your cabinet meets the minimum requirements. Plan the cabinet location, including required space clearances. 	“SRX300 Services Gateway Cabinet Size and Clearance Requirements” on page 25			
Wall Installation				

Table 8: Site Preparation Checklist for SRX300 Services Gateway Installation (continued)

Item or Task	Additional Information	Performed By	Date	Notes
<ul style="list-style-type: none"> Verify that the area selected meets the minimum requirements. Verify that you have the required hardware to proceed with the installation. 	“Preparing the SRX300 Services Gateway for Wall-Mount Installation” on page 40			
Desktop Installation				
<ul style="list-style-type: none"> Verify that the area selected meets the minimum requirements. Plan the installation location, including required space clearances and airflow requirements. 	“Preparing the SRX300 Services Gateway for Desk-Mount Installation” on page 40			
Cables				
<ul style="list-style-type: none"> Acquire cables and connectors. Review the maximum distance allowed for each cable. Choose the length of cable based on the distance between the hardware components being connected. Plan the cable routing and management. 				

Related Documentation

- [General Site Installation Guidelines for the SRX300 Services Gateway on page 16](#)

General Site Installation Guidelines for the SRX300 Services Gateway

The following precautions help you plan an acceptable operating environment for your SRX300 Services Gateway and avoid environmentally caused equipment failures:

- For the operating temperature of the services gateway to be optimal, the airflow around the chassis must be unrestricted. Allow sufficient clearance between the front and back of the chassis and adjacent equipment. Ensure that there is adequate circulation in the installation location.

- Follow the ESD procedures to avoid damaging equipment. Static discharge can cause components to fail completely or intermittently over time. For more information, see [“Preventing Electrostatic Discharge Damage to the SRX300 Services Gateway”](#) on page 95.



.....

NOTE: The SRX300 Services Gateway does not include a fan and does not generate any acoustic noise.

.....

**Related
Documentation**

- [Site Preparation Checklist for the SRX300 Services Gateway](#) on page 14

CHAPTER 5

Rack Requirements

- [SRX300 Services Gateway Rack-Mounting Requirements and Warnings on page 19](#)
- [SRX300 Services Gateway Rack Size and Strength Requirements on page 23](#)
- [SRX300 Services Gateway Spacing of Mounting Brackets and Flange Holes on page 23](#)
- [SRX300 Services Gateway Clearance Requirements for Airflow and Hardware Maintenance on page 24](#)

SRX300 Services Gateway Rack-Mounting Requirements and Warnings

Ensure that the equipment rack into which the services gateway is installed is evenly and securely supported to avoid hazardous conditions that could result from uneven mechanical loading.



WARNING: To prevent bodily injury when mounting or servicing the services gateway in a rack, take the following precautions to ensure that the system remains stable. The following directives help maintain your safety:

- The services gateway must be installed into a rack that is secured to the building structure.
- The services gateway should be mounted at the bottom of the rack if it is the only unit in the rack.
- When mounting the services gateway in a partially filled rack, load the rack from the bottom to the top with the heaviest component at the bottom of the rack.
- If the rack is provided with stabilizing devices, install the stabilizers before mounting or servicing the services gateway in the rack.

Waarschuwing Om lichamelijk letsel te voorkomen wanneer u dit toestel in een rek monteert of het daar een servicebeurt geeft, moet u speciale voorzorgsmaatregelen nemen om ervoor te zorgen dat het toestel stabiel blijft. De onderstaande richtlijnen worden verstrekt om uw veiligheid te verzekeren:

- De Juniper Networks services gateway moet in een stelling worden geïnstalleerd die aan een bouwsel is verankerd.
- Dit toestel dient onderaan in het rek gemonteerd te worden als het toestel het enige in het rek is.
- Wanneer u dit toestel in een gedeeltelijk gevuld rek monteert, dient u het rek van onderen naar boven te laden met het zwaarste onderdeel onderaan in het rek.
- Als het rek voorzien is van stabiliseringshulpmiddelen, dient u de stabilisatoren te monteren voordat u het toestel in het rek monteert of het daar een servicebeurt geeft.

Varoitus Kun laite asetetaan telineeseen tai huolletaan sen ollessa telineessä, on noudatettava erityisiä varotoimia järjestelmän vakavuuden säilyttämiseksi, jotta vältytään loukkaantumiselta. Noudata seuraavia turvallisuusohjeita:

- Juniper Networks services gateway on asennettava telineeseen, joka on kiinnitetty rakennukseen.
- Jos telineessä ei ole muita laitteita, aseta laite telineen alaosaan.
- Jos laite asetetaan osaksi täytettyyn telineeseen, aloita kuormittaminen sen alaosasta kaikkein raskaimmalla esineellä ja siirry sitten sen yläosaan.
- Jos telinettä varten on vakaimet, asenna ne ennen laitteen asettamista telineeseen tai sen huoltamista siinä.

Attention Pour éviter toute blessure corporelle pendant les opérations de montage ou de réparation de cette unité en casier, il convient de prendre des précautions spéciales afin de maintenir la stabilité du système. Les directives ci-dessous sont destinées à assurer la protection du personnel:

- Le rack sur lequel est monté le Juniper Networks services gateway doit être fixé à la structure du bâtiment.
- Si cette unité constitue la seule unité montée en casier, elle doit être placée dans le bas.
- Si cette unité est montée dans un casier partiellement rempli, charger le casier de bas en haut en plaçant l'élément le plus lourd dans le bas.
- Si le casier est équipé de dispositifs stabilisateurs, installer les stabilisateurs avant de monter ou de réparer l'unité en casier.

Warnung Zur Vermeidung von Körperverletzung beim Anbringen oder Warten dieser Einheit in einem Gestell müssen Sie besondere Vorkehrungen treffen, um sicherzustellen, daß das System stabil bleibt. Die folgenden Richtlinien sollen zur Gewährleistung Ihrer Sicherheit dienen:

- Der Juniper Networks services gateway muß in einem Gestell installiert werden, das in der Gebäudestruktur verankert ist.
- Wenn diese Einheit die einzige im Gestell ist, sollte sie unten im Gestell angebracht werden.
- Bei Anbringung dieser Einheit in einem zum Teil gefüllten Gestell ist das Gestell von unten nach oben zu laden, wobei das schwerste Bauteil unten im Gestell anzubringen ist.
- Wird das Gestell mit Stabilisierungszubehör geliefert, sind zuerst die Stabilisatoren zu installieren, bevor Sie die Einheit im Gestell anbringen oder sie warten.

Avvertenza Per evitare infortuni fisici durante il montaggio o la manutenzione di questa unità in un supporto, occorre osservare speciali precauzioni per garantire che il sistema rimanga stabile. Le seguenti direttive vengono fornite per garantire la sicurezza personale:

- Il Juniper Networks services gateway deve essere installato in un telaio, il quale deve essere fissato alla struttura dell'edificio.
- Questa unità deve venire montata sul fondo del supporto, se si tratta dell'unica unità da montare nel supporto.
- Quando questa unità viene montata in un supporto parzialmente pieno, caricare il supporto dal basso all'alto, con il componente più pesante sistemato sul fondo del supporto.
- Se il supporto è dotato di dispositivi stabilizzanti, installare tali dispositivi prima di montare o di procedere alla manutenzione dell'unità nel supporto.

Advarsel Unngå fysiske skader under montering eller reparasjonsarbeid på denne enheten når den befinner seg i et kabinett. Vær nøye med at systemet er stabilt. Følgende retningslinjer er gitt for å verne om sikkerheten:

- Juniper Networks services gateway må installeres i et stativ som er forankret til bygningsstrukturen.
- Denne enheten bør monteres nederst i kabinettet hvis dette er den eneste enheten i kabinettet.
- Ved montering av denne enheten i et kabinett som er delvis fylt, skal kabinettet lastes fra bunnen og opp med den tyngste komponenten nederst i kabinettet.
- Hvis kabinettet er utstyrt med stabiliseringsutstyr, skal stabilisatorene installeres før montering eller utføring av reparasjonsarbeid på enheten i kabinettet.

Aviso Para se prevenir contra danos corporais ao montar ou reparar esta unidade numa estante, deverá tomar precauções especiais para se certificar

de que o sistema possui um suporte estável. As seguintes directrizes ajudá-lo-ão a efectuar o seu trabalho com segurança:

- O Juniper Networks services gateway deverá ser instalado numa prateleira fixa à estrutura do edifício.
- Esta unidade deverá ser montada na parte inferior da estante, caso seja esta a única unidade a ser montada.
- Ao montar esta unidade numa estante parcialmente ocupada, coloque os itens mais pesados na parte inferior da estante, arrumando-os de baixo para cima.
- Se a estante possuir um dispositivo de estabilização, instale-o antes de montar ou reparar a unidade.

¡Atención! Para evitar lesiones durante el montaje de este equipo sobre un bastidor, o posteriormente durante su mantenimiento, se debe poner mucho cuidado en que el sistema quede bien estable. Para garantizar su seguridad, proceda según las siguientes instrucciones:

- El Juniper Networks services gateway debe instalarse en un bastidor fijado a la estructura del edificio.
- Colocar el equipo en la parte inferior del bastidor, cuando sea la única unidad en el mismo.
- Cuando este equipo se vaya a instalar en un bastidor parcialmente ocupado, comenzar la instalación desde la parte inferior hacia la superior colocando el equipo más pesado en la parte inferior.
- Si el bastidor dispone de dispositivos estabilizadores, instalar éstos antes de montar o proceder al mantenimiento del equipo instalado en el bastidor.

Varning! För att undvika kroppsskada när du installerar eller utför underhållsarbete på denna enhet på en ställning måste du vidta särskilda försiktighetsåtgärder för att försäkra dig om att systemet står stadigt. Följande riktlinjer ges för att trygga din säkerhet:

- Juniper Networks services gateway måste installeras i en ställning som är förankrad i byggnadens struktur.
- Om denna enhet är den enda enheten på ställningen skall den installeras längst ned på ställningen.
- Om denna enhet installeras på en delvis fylld ställning skall ställningen fyllas nedifrån och upp, med de tyngsta enheterna längst ned på ställningen.
- Om ställningen är försedd med stabiliseringsdon skall dessa monteras fast innan enheten installeras eller underhålls på ställningen.

Related Documentation • [SRX300 Services Gateway Rack Size and Strength Requirements on page 23](#)

- [SRX300 Services Gateway Spacing of Mounting Brackets and Flange Holes on page 23](#)
- [SRX300 Services Gateway Clearance Requirements for Airflow and Hardware Maintenance on page 24](#)

SRX300 Services Gateway Rack Size and Strength Requirements

When installing the services gateway in a rack, you must ensure that the rack complies with a 1U (19 in. or 48.7 cm) rack as defined in Cabinets, Racks, Panels, and Associated Equipment (document number EIA-310-D), published by the Electronic Industries Alliance (<http://www.ecaus.org/eia/site/index.html>).

When selecting a rack, ensure that the physical characteristics of the rack comply with the following specifications:

- The outer edges of the mounting brackets extend the width of either chassis to 19 in. (48.3 cm).
- The front of the chassis extends approximately 0.5 in. (1.27 cm) beyond the mounting ears.
- Maximum permissible ambient temperature when two devices are placed side by side in a 19 in. rack is 40° C.

Related Documentation

- [SRX300 Services Gateway Rack-Mounting Requirements and Warnings on page 19](#)
- [SRX300 Services Gateway Spacing of Mounting Brackets and Flange Holes on page 23](#)
- [SRX300 Services Gateway Clearance Requirements for Airflow and Hardware Maintenance on page 24](#)

SRX300 Services Gateway Spacing of Mounting Brackets and Flange Holes

The spacing of the mounting brackets and flange holes on the rack and device mounting brackets are as follows:

- The holes within each rack set are spaced at 1 U (1.75 in. or 4.5 cm).
- The mounting brackets and front-mount flanges used to attach the chassis to a rack are designed to fasten to holes spaced at rack distances of 1 U (1.75 in.).
- The mounting holes in the mounting brackets provided with the device are spaced 1.25 in. (3.2 cm) apart (top and bottom mounting hole).

Related Documentation

- [SRX300 Services Gateway Rack-Mounting Requirements and Warnings on page 19](#)
- [SRX300 Services Gateway Rack Size and Strength Requirements on page 23](#)
- [SRX300 Services Gateway Clearance Requirements for Airflow and Hardware Maintenance on page 24](#)

SRX300 Services Gateway Clearance Requirements for Airflow and Hardware Maintenance

When planning the installation site for the SRX300 Services Gateway, you need to allow sufficient clearance around the device. Consider the following:

- The SRX300 Services Gateway does not include a fan and uses natural convection cooling. For the operating temperature of the services gateway to be optimal, the airflow around the chassis must be unrestricted.
- For service personnel to remove and install hardware components, there must be adequate space at the front and back of the device. Allow at least 24 in. (61 cm) both in front of and behind the device.
- If you are mounting the device in a rack with other equipment, or if you are placing it on the desktop near other equipment, ensure that the exhaust from other equipment does not blow into the intake vents of the chassis.

Related Documentation

- [SRX300 Services Gateway Rack-Mounting Requirements and Warnings on page 19](#)
- [SRX300 Services Gateway Rack Size and Strength Requirements on page 23](#)
- [SRX300 Services Gateway Spacing of Mounting Brackets and Flange Holes on page 23](#)

CHAPTER 6

Cabinet Requirements

- SRX300 Services Gateway Cabinet Size and Clearance Requirements on page 25
- SRX300 Services Gateway Cabinet Airflow Requirements on page 25

SRX300 Services Gateway Cabinet Size and Clearance Requirements

You can install the SRX300 Services Gateway in a 19 in. (48.7 cm) cabinet as defined in Cabinets, Racks, Panels, and Associated Equipment (document number EIA-310-D) published by the Electronic Industries Alliance (<http://www.ecaus.org/eia/site/index.html>). You must mount the services gateway horizontally in the cabinet using appropriate rack adapters.

When selecting a cabinet, ensure that it meets the following specifications:

- The cabinet is at least 1U (3.50 in. or 8.89 cm) and can accommodate the services gateway.
- The outer edges of the mounting brackets extend the width of either chassis to 19 in. (48.7 cm), and the front of the chassis extends approximately 0.5 in. (1.27 cm) beyond the mounting brackets.
- The minimum total clearance inside the cabinet is 30.7 in. (78 cm) between the inside of the front door and the inside of the rear door.



NOTE: A cabinet larger than the minimum required provides better airflow and reduces the chance of overheating.

Related Documentation

- SRX300 Services Gateway Cabinet Airflow Requirements on page 25

SRX300 Services Gateway Cabinet Airflow Requirements

When you mount the SRX300 Services Gateway in a cabinet, you must ensure that ventilation through the cabinet is sufficient to prevent overheating. Consider the following when planning for chassis cooling:

- Ensure that the cool air supply you provide through the cabinet can adequately dissipate the thermal output of the services gateway.
- Install the services gateway as close as possible to the front of the cabinet so that the cable management system clears the inside of the front door. Installing the chassis close to the front of the cabinet maximizes the clearance in the rear of the cabinet for critical airflow.
- Route and dress all cables to minimize the blockage of airflow to and from the chassis.

**Related
Documentation**

- [SRX300 Services Gateway Cabinet Size and Clearance Requirements on page 25](#)

Power Requirements and Specifications

- [SRX300 Services Gateway Electrical Wiring Guidelines on page 27](#)
- [SRX300 Services Gateway Power Specifications and Requirements on page 28](#)

SRX300 Services Gateway Electrical Wiring Guidelines

Table 9 on page 27 describes the factors you must consider while planning the electrical wiring for the services gateway at your site.



CAUTION: It is particularly important to provide a properly grounded and shielded environment and to use electrical surge-suppression devices.

Table 9: Site Electrical Wiring Guidelines for the SRX300 Services Gateway

Site Wiring Factor	Guideline
Signaling Limitations	<p>To ensure that signaling functions optimally:</p> <ul style="list-style-type: none"> • Install wires correctly. Improperly installed wires can emit radio interference. • Do not exceed the recommended distances or pass wires between buildings. The potential for damage from lightning strikes increases if wires exceed recommended distances or if wires pass between buildings. • Shield all conductors. The electromagnetic pulse (EMP) caused by lightning can damage unshielded conductors and destroy electronic devices.
Radio Frequency Interference (RFI)	<p>To reduce or eliminate the emission of RFI from your site wiring:</p> <ul style="list-style-type: none"> • Use twisted-pair cable with a good distribution of grounding conductors. • Use a high-quality twisted-pair cable with one ground conductor for each data signal when applicable, if you must exceed the recommended distances.

Table 9: Site Electrical Wiring Guidelines for the SRX300 Services Gateway (continued)

Site Wiring Factor	Guideline
Electromagnetic Compatibility (EMC)	<p>Provide a properly grounded and shielded environment and use electrical surge-suppression devices.</p> <p>Strong sources of electromagnetic interference (EMI) can cause the following damage:</p> <ul style="list-style-type: none"> • Destroy the signal drivers and receivers in the device • Conduct power surges over the lines into the equipment, resulting in an electrical hazard <p>NOTE: If your site is susceptible to problems with EMC, particularly from lightning or radio transmitters, you may want to seek expert advice.</p>



CAUTION: To comply with intrabuilding lightning/surge requirements, the intrabuilding wiring must be shielded. The shielding for the wiring must be grounded at both ends.

Related Documentation

- [SRX300 Services Gateway Power Specifications and Requirements on page 28](#)
- [General Electrical Safety Guidelines and Warnings on page 111](#)

SRX300 Services Gateway Power Specifications and Requirements

Table 10 on page 28 lists the power specifications for the SRX300 Services Gateway power supply adapter.

Table 10: Power Specifications for the SRX300 Services Gateway Power Supply Adapter

Power Supply Adapter Requirement	Specification
AC input	100 to 240 VAC
AC input line frequency	50 to 60 Hz
Current	1 A maximum



WARNING: The AC power cord for the services gateway is intended for use with only the power supply adapter provided with the device .

Related Documentation

- [SRX300 Services Gateway Electrical Wiring Guidelines on page 27](#)

CHAPTER 8

Cable Specifications and Pinouts

- [RJ-45 Connector Pinouts for the SRX300 Services Gateway Ethernet Port on page 29](#)
- [RJ-45 Connector Pinouts for the SRX300 Services Gateway Console Port on page 29](#)
- [Mini-USB Connector Pinouts for the SRX300 Services Gateway Console Port on page 30](#)

RJ-45 Connector Pinouts for the SRX300 Services Gateway Ethernet Port

[Table 11 on page 29](#) describes the RJ-45 connector pinouts for the Ethernet port.

Table 11: RJ-45 Connector Pinouts for the SRX300 Services Gateway Ethernet Port

Pin	Signal
1	BI_DA+
2	BI_DA
3	BI_DB+
4	BI_DC+
5	BI_DC
6	BI_DB
7	BI_DD+
8	BI_DD

Related Documentation

- [RJ-45 Connector Pinouts for the SRX300 Services Gateway Console Port on page 29](#)

RJ-45 Connector Pinouts for the SRX300 Services Gateway Console Port

[Table 12 on page 30](#) describes the RJ-45 connector pinouts for the console port.

Table 12: RJ-45 Connector Pinouts for the SRX300 Services Gateway Console Port

Pin	Signal	Description
1	RTS	Request to Send
2	DTR	Data Terminal Ready
3	TXD	Transmit Data
4	Ground	Signal Ground
5	Ground	Signal Ground
6	RXD	Receive Data
7	DSR/DCD	Data Set Ready
8	CTS	Clear to Send

Related Documentation

- [RJ-45 Connector Pinouts for the SRX300 Services Gateway Ethernet Port on page 29](#)

Mini-USB Connector Pinouts for the SRX300 Services Gateway Console Port

The SRX300 Services Gateway has two console ports: an RJ-45 Ethernet port and a mini-USB Type-B port. If your management device (laptop or PC) does not have a DB-9 male connector pin or an RJ-45 connector pin, you can connect your management device to the Mini-USB Type-B console port of the services gateway by using a cable that has a standard Type-A USB connector on one end and a Mini-USB Type-B (5-pin) connector on the other end. [Table 13 on page 30](#) describes the Mini-USB Type-B connector pinouts for the console port.



NOTE: By design, the mini-USB console port has higher priority over the RJ-45 console port. If the mini-USB and RJ-45 console ports are both connected, then the mini-USB console port will be active.

Table 13: Mini-USB Type-B Connector Pinouts for the Services Gateway Console Port

Pin	Signal	Cable Color	Description
1	VCC	Red	+5 VDC
2	D-	White	Data -
3	D+	Green	Data +

Table 13: Mini-USB Type-B Connector Pinouts for the Services Gateway Console Port (continued)

Pin	Signal	Cable Color	Description
X	N/C		Could be not connected (N/C), connected to ground (GND), or used as an attached device presence indicator
4	GND	Black	Ground

- Related Documentation**
- [RJ-45 Connector Pinouts for the SRX300 Services Gateway Ethernet Port on page 29](#)
 - [RJ-45 Connector Pinouts for the SRX300 Services Gateway Console Port on page 29](#)

PART 3

Initial Installation and Configuration

- [Installation Overview on page 35](#)
- [Unpacking the SRX300 Services Gateway on page 37](#)
- [Installing the Rack Mounting Hardware on page 39](#)
- [Installing the SRX300 Services Gateway in a Rack on page 43](#)
- [Connecting the SRX300 Services Gateway to Ground on page 49](#)
- [Connecting the SRX300 Services Gateway to External Devices on page 53](#)
- [Providing Power to the SRX300 Services Gateway on page 55](#)
- [Performing the Initial Configuration on page 59](#)

CHAPTER 9

Installation Overview

- [SRX300 Services Gateway Installation Overview on page 35](#)
- [Required Tools and Parts for Installing the SRX300 Services Gateway on page 36](#)
- [SRX300 Services Gateway Autoinstallation Overview on page 36](#)

SRX300 Services Gateway Installation Overview

After you have prepared the site for installation and unpacked the SRX300 Services Gateway, you are ready to install the device. It is important to proceed through the installation process in the following order:

1. Review the safety guidelines explained in [“SRX300 Services Gateway General Safety Guidelines and Warnings” on page 91](#).
2. Prepare your site for the installation of the services gateway as described in [“Site Preparation Checklist for the SRX300 Services Gateway” on page 14](#).
3. Prepare the services gateway for installation. See:
 - [Preparing the SRX300 Services Gateway for Rack-Mount Installation on page 39](#)
 - [Preparing the SRX300 Services Gateway for Wall-Mount Installation on page 40](#)
 - [Preparing the SRX300 Services Gateway for Desk-Mount Installation on page 40](#)
4. Install the services gateway. See:
 - [Installing the SRX300 Services Gateway in a Rack on page 43](#)
 - [Installing the SRX300 Services Gateway on a Wall on page 45](#)
 - [Installing the SRX300 Services Gateway on a Desk on page 47](#)
5. Connect the grounding cable as described in [“Connecting the SRX300 Services Gateway Grounding Cable” on page 50](#).
6. Power on the services gateway as described in [“Powering On the SRX300 Services Gateway” on page 56](#).

**Related
Documentation**

- [SRX300 Services Gateway Autoinstallation Overview on page 36](#)
- [Site Preparation Checklist for the SRX300 Services Gateway on page 14](#)

- [General Site Installation Guidelines for the SRX300 Services Gateway on page 16](#)

Required Tools and Parts for Installing the SRX300 Services Gateway

To install the services gateway, you need the following tools and parts:

- Phillips (+) screwdriver, number 2
- Tie-wrap
- Electrostatic discharge (ESD) grounding wrist strap

Related Documentation

- [SRX300 Services Gateway Installation Overview on page 35](#)

SRX300 Services Gateway Autoinstallation Overview

The autoinstallation process begins any time a services gateway is powered on and cannot locate a valid configuration file in the internal flash. Typically, a configuration file is unavailable when a services gateway is powered on for the first time or if the configuration file is deleted from the internal flash. The autoinstallation feature enables you to deploy multiple services gateways from a central location in the network.

If you are setting up many devices, autoinstallation can help automate the configuration process by loading configuration files onto new or existing devices automatically over the network. You can use either the J-Web interface or the CLI to configure a device for autoinstallation.

For the autoinstallation process to work, you must store one or more host-specific or default configuration files on a configuration server in the network and have a service available—typically Dynamic Host Configuration Protocol (DHCP)—to assign an IP address to the services gateway.

Autoinstallation takes place automatically when you connect an Ethernet port on a new services gateway to the network and power on the device. To simplify the process, you can explicitly enable autoinstallation on a device and specify a configuration server, an autoinstallation interface, and a protocol for IP address acquisition.

For more information about configuring autoinstallation, see the following topics:

- [Installation and Upgrade Guide for Security Devices](#)
- [Monitoring and Troubleshooting Guide for Security Devices](#)

Related Documentation

- [SRX300 Services Gateway Installation Overview on page 35](#)

CHAPTER 10

Unpacking the SRX300 Services Gateway

- [Unpacking the SRX300 Services Gateway on page 37](#)
- [Verifying Parts Received with the SRX300 Services Gateway on page 37](#)

Unpacking the SRX300 Services Gateway

The SRX300 Services Gateway is shipped in a cardboard carton and secured with foam packing material. The carton also contains an accessory box and quick-start instructions.

To unpack the SRX300 Services Gateway:

1. Move the cardboard carton to a staging area as close to the installation site as possible, where you have enough room to remove the components from the chassis.
2. Position the cardboard carton with the arrows pointing up.
3. Carefully open the top of the cardboard carton.
4. Remove the foam covering the top of the services gateway.
5. Remove the accessory box.
6. Verify the parts received against the lists in “[Verifying Parts Received with the SRX300 Services Gateway](#)” on page 37.
7. Store the brackets and bolts inside the accessory box.
8. Save the shipping carton and packing materials in case you need to move or ship the services gateway at a later time.

Related Documentation

- [Verifying Parts Received with the SRX300 Services Gateway on page 37](#)

Verifying Parts Received with the SRX300 Services Gateway

The SRX300 Services Gateway shipment package contains a packing list. Check the parts in the shipment against the items on the packing list. The packing list specifies the part numbers and carries a brief description of each part in your order.

If any part is missing, contact a customer service representative.

A fully configured services gateway contains the chassis with installed components, listed in [Table 14 on page 38](#), and an accessory box, which contains the parts listed in [Table 15 on page 38](#).



NOTE: The parts shipped with your services gateway can vary depending on the configuration you ordered.

Table 14: Parts List for a Fully Configured SRX300 Services Gateway

Component	Quantity
SRX300 Services Gateway chassis with six Gigabit Ethernet LAN ports and two 1 G SFP ports	1
CAT5E cable	1
DB9-to-RJ45 adapter	1
USB console cable with Type-A and Mini-B USB plugs	1
How to Set Up Your SRX300 Services Gateway	1
Power supply adapter and power cord	1

Table 15: Accessory/Upgrade Parts List for the SRX300 Services Gateway

Part	Quantity
Juniper Networks Product Warranty and RoHS Card	1
End User License Agreement	1
Safety Guide	1

Related Documentation

- [Unpacking the SRX300 Services Gateway on page 37](#)

Installing the Rack Mounting Hardware

- [Preparing the SRX300 Services Gateway for Rack-Mount Installation on page 39](#)
- [Preparing the SRX300 Services Gateway for Wall-Mount Installation on page 40](#)
- [Preparing the SRX300 Services Gateway for Desk-Mount Installation on page 40](#)
- [Connecting the SRX300 Services Gateway to the Building Structure on page 41](#)

Preparing the SRX300 Services Gateway for Rack-Mount Installation

You can mount an SRX300 Services Gateway in four-post (telco) racks, enclosed cabinets, and open-frame racks.



NOTE: The SRX300 Services Gateway cannot be center-mounted in racks.

Before mounting the SRX300 Services Gateway in a rack:

- Verify that the installation site meets the requirements described in [“Site Preparation Checklist for the SRX300 Services Gateway” on page 14](#).
- Verify that the racks or cabinets meet the specific requirements described in [“SRX300 Services Gateway Rack-Mounting Requirements and Warnings” on page 19](#).
- Place the rack or cabinet in its permanent location, allowing adequate clearance for airflow and maintenance, and secure it to the building structure. For more information, see [“SRX300 Services Gateway Clearance Requirements for Airflow and Hardware Maintenance” on page 24](#).
- Remove the services gateway chassis from the shipping carton. For unpacking instructions, see [“Unpacking the SRX300 Services Gateway” on page 37](#).
- Verify that you have the following parts available in your rack-mounting kit:
 - Rack-mount tray
 - Screws



NOTE: The rack-mounting kit is not shipped with the device and must be ordered separately.

- Related Documentation**
- [Installing the SRX300 Services Gateway in a Rack on page 43](#)
 - [Preparing the SRX300 Services Gateway for Wall-Mount Installation on page 40](#)
 - [Preparing the SRX300 Services Gateway for Desk-Mount Installation on page 40](#)

Preparing the SRX300 Services Gateway for Wall-Mount Installation

You can mount an SRX300 Services Gateway on a wall. The four rubber feet attached to the chassis provide stability. Before mounting the SRX300 Services Gateway on a wall:

- Verify that the installation site meets the requirements described in “[Site Preparation Checklist for the SRX300 Services Gateway](#)” on page 14.
- Remove the services gateway chassis from the shipping carton. For unpacking instructions, see “[Unpacking the SRX300 Services Gateway](#)” on page 37.
- Verify that you have the following parts available in your wall-mounting kit:
 - Wall-mounting brackets
 - Screws



NOTE: The wall-mounting kit is not shipped with the device and must be ordered separately.

- Related Documentation**
- [Installing the SRX300 Services Gateway on a Wall on page 45](#)
 - [Preparing the SRX300 Services Gateway for Rack-Mount Installation on page 39](#)
 - [Preparing the SRX300 Services Gateway for Desk-Mount Installation on page 40](#)

Preparing the SRX300 Services Gateway for Desk-Mount Installation

You can mount an SRX300 Services Gateway on a desk or any other level surface horizontally or vertically. The four rubber feet attached to the chassis provide stability. Before mounting an SRX300 Services Gateway on a desk or level surface:

- Verify that the installation site meets the requirements described in “[Site Preparation Checklist for the SRX300 Services Gateway](#)” on page 14.
- Place the desk in its permanent location, allowing adequate clearance for airflow and maintenance, and secure it to the building structure.
- Remove the services gateway chassis from the shipping carton. For unpacking instructions, see “[Unpacking the SRX300 Services Gateway](#)” on page 37.

- Related Documentation**
- [Installing the SRX300 Services Gateway on a Desk on page 47](#)
 - [Preparing the SRX300 Services Gateway for Rack-Mount Installation on page 39](#)

- [Preparing the SRX300 Services Gateway for Wall-Mount Installation on page 40](#)

Connecting the SRX300 Services Gateway to the Building Structure

Always secure the rack in which you are installing the services gateway to the structure of the building. If your geographical area is subject to earthquakes, bolt the rack to the floor. For maximum stability, also secure the rack to ceiling brackets.

Related Documentation

- [Preparing the SRX300 Services Gateway for Rack-Mount Installation on page 39](#)
- [Installing the SRX300 Services Gateway in a Rack on page 43](#)

Installing the SRX300 Services Gateway in a Rack

- Installing the SRX300 Services Gateway in a Rack on page 43
- Installing the SRX300 Services Gateway on a Wall on page 45
- Installing the SRX300 Services Gateway on a Desk on page 47

Installing the SRX300 Services Gateway in a Rack

You can front-mount the SRX300 Services Gateway in a rack. Many types of racks are acceptable, including four-post (telco) racks, enclosed cabinets, and open-frame racks. For more information about the type of rack or cabinet the SRX300 Services Gateway can be installed in, see “SRX300 Services Gateway Rack Size and Strength Requirements” on page 23.



NOTE: The rack-mounting kit is not shipped with the device and must be ordered separately.



NOTE: If you are installing multiple devices in one rack, install the lowest one first and proceed upward in the rack. Ensure that the rubber feet from the base of the chassis are removed for rack installation.

To install the device in a rack:

1. Position a mounting bracket on each side of the chassis as shown in [Figure 4 on page 44](#).

Figure 4: SRX300 Services Gateway Rack Installation — Positioning the Mounting Brackets

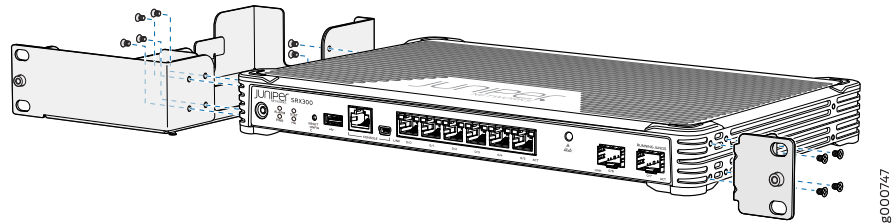

2. Use a number-1 Phillips screwdriver to install the screws that secure the mounting brackets and power supply adapter tray to the chassis as shown in [Figure 5 on page 44](#).

Figure 5: SRX300 Services Gateway Rack Installation — Securing the Mounting Brackets and Power Supply Adapter Tray

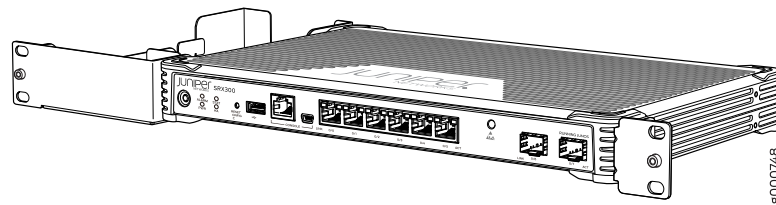

3. Place the power supply adapter in the tray as shown in [Figure 6 on page 44](#).

Figure 6: SRX300 Services Gateway Rack Installation — Positioning the Power Supply Adapter Tray

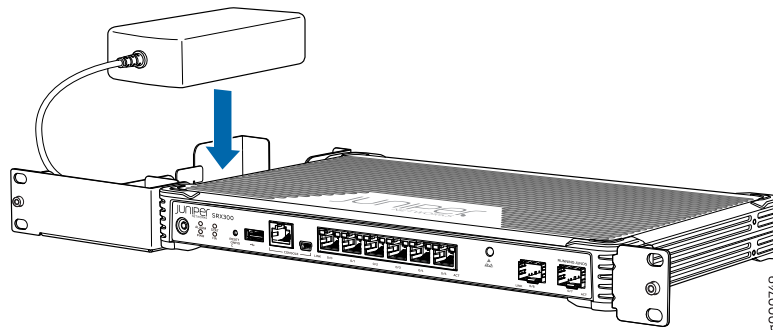

4. Have one person grasp the sides of the device, lift it, and position it in the rack.
5. Align the bottom hole in each mounting bracket with a hole in each rack rail as shown in [Figure 7 on page 45](#), making sure the chassis is level.

Figure 7: SRX300 Services Gateway Rack Installation — Positioning the SRX300 Services Gateway in a Rack

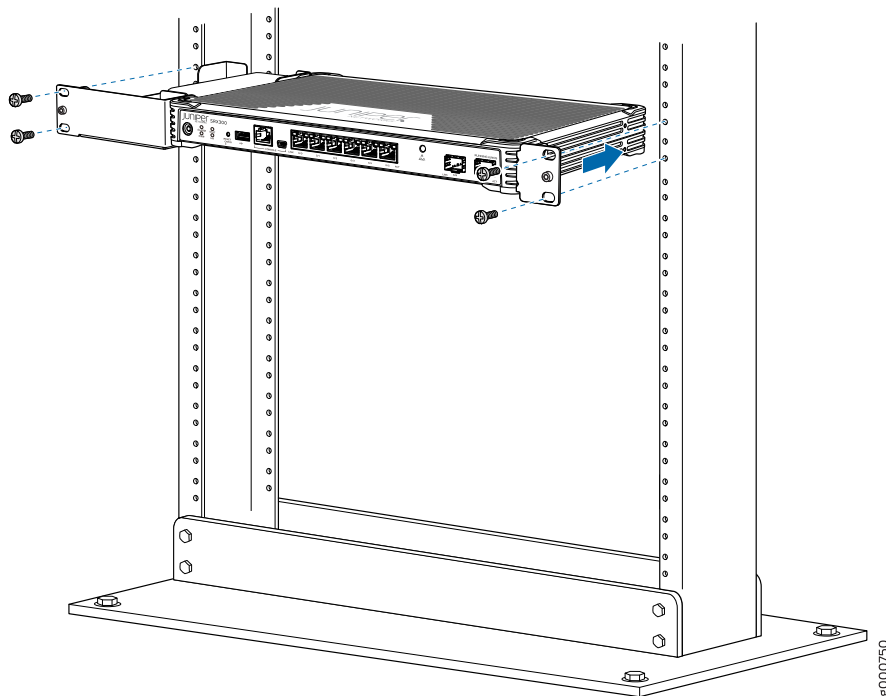

6. Have a second person install a mounting screw into each of the two aligned holes. Use a number-1 Phillips screwdriver to tighten the mounting screws.
7. Install the second screw in each mounting bracket.
8. Verify that the mounting screws on one side of the rack are aligned with the mounting screws on the opposite side and that the device is level.

Related Documentation

- [Installing the SRX300 Services Gateway on a Wall on page 45](#)
- [Installing the SRX300 Services Gateway on a Desk on page 47](#)

Installing the SRX300 Services Gateway on a Wall

You can install the SRX300 Services Gateway on a wall.



NOTE: The wall-mounting kit is not shipped with the device and must be ordered separately.

To install the device on a wall:

1. Place the device on a flat, level surface with the Juniper Networks logo, which is embossed on the top cover, facing up. Ensure that the rubber feet are attached to the bottom of the chassis.
2. Position a mounting bracket on each side of the chassis as shown in [Figure 8 on page 46](#).

Figure 8: Attaching Wall-Mount Brackets

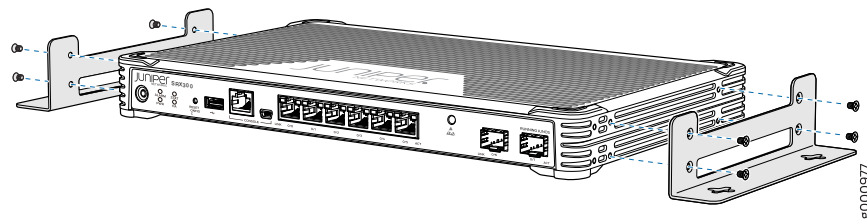

3. Use a number-1 Phillips screwdriver to install the screws that secure the mounting brackets to the chassis.
4. If you are using wall anchors to support the chassis, install two pairs of anchors on the wall with the mounting brackets attached.
5. Have one person grasp the sides of the device, lift it, and position it on the wall. [Figure 9 on page 46](#) shows the four different orientations in which you can mount the services gateway on a wall.

Figure 9: Orienting the SRX300 Services Gateway on a Wall

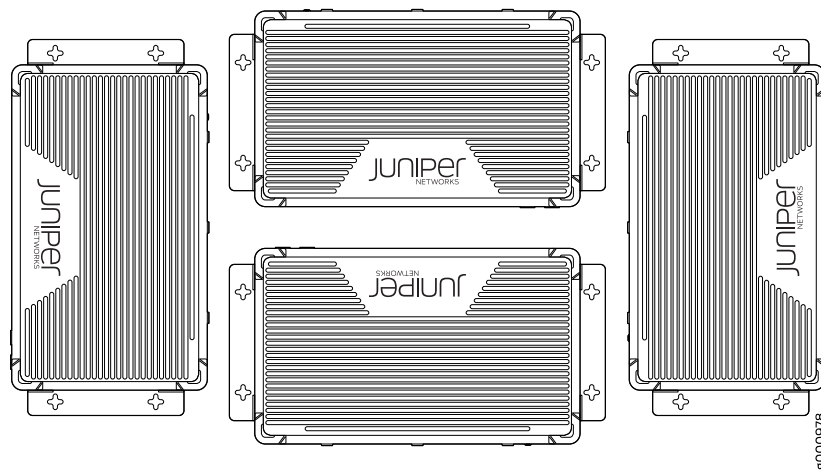

6. Have a second person install two pairs of mounting screws through the bracket holes on either side of the device to secure it to the wall.
7. Verify that the mounting screws on one side are aligned with the mounting screws on the opposite side and that the device is level (see [Figure 10 on page 47](#)).

Figure 10: Mounting the SRX300 Services Gateway on a Wall

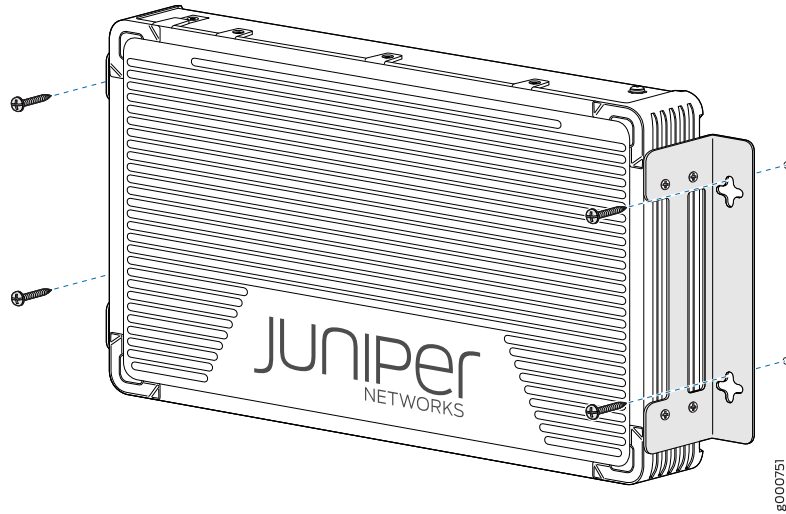

- Related Documentation**
- [Installing the SRX300 Services Gateway in a Rack on page 43](#)
 - [Installing the SRX300 Services Gateway on a Desk on page 47](#)

Installing the SRX300 Services Gateway on a Desk

Follow these guidelines when installing the SRX300 Services Gateway on a desk:

- You can install the SRX300 Services Gateway on a desk, table, or other level surface.
- The device is shipped with the rubber feet attached. The rubber feet are necessary to stabilize the device on the desk.

The horizontal position is the standard installation position. To install the device in a horizontal position:

1. Make sure that the rubber feet are attached to the chassis.
2. Place the device on a desk with the Juniper Networks logo, which is embossed on the top cover, facing up.

- Related Documentation**
- [Installing the SRX300 Services Gateway in a Rack on page 43](#)
 - [Installing the SRX300 Services Gateway on a Wall on page 45](#)

Connecting the SRX300 Services Gateway to Ground

- [Required Tools and Parts for Grounding the SRX300 Services Gateway on page 49](#)
- [SRX300 Services Gateway Grounding Specifications on page 49](#)
- [Connecting the SRX300 Services Gateway Grounding Cable on page 50](#)

Required Tools and Parts for Grounding the SRX300 Services Gateway

To ground and to provide power to the services gateway, you need the following tools:

- Phillips (+) screwdrivers, numbers 1 and 2
- Electrostatic discharge (ESD) grounding wrist strap
- Wire cutters

Related Documentation

- [Connecting the SRX300 Services Gateway Grounding Cable on page 50](#)
- [SRX300 Services Gateway Grounding Specifications on page 49](#)

SRX300 Services Gateway Grounding Specifications

To meet safety and electromagnetic interference (EMI) requirements and to ensure proper operation, the SRX300 Services Gateway must be adequately grounded before power is connected. You must provide a grounding lug to connect the services gateway to earth ground.



WARNING: Before you connect power to the services gateway, a licensed electrician must attach a cable lug to the grounding and power cables that you supply. A cable with an incorrectly attached lug can damage the services gateway (for example, by causing a short circuit).

The services gateway chassis has one grounding point on the back panel. The grounding point hole fits M5 screws.

[Table 16 on page 50](#) lists the specifications of the grounding cable used with the device.

Table 16: Grounding Cable Specifications for the Services Gateway

Grounding Requirement	Specification
Grounding cable	14 AWG single-strand wire cable
Amperage of grounding cable	Up to 4 A
Grounding lug	Ring-type, vinyl-insulated TV14-6R lug or equivalent

Related Documentation

- [Required Tools and Parts for Grounding the SRX300 Services Gateway on page 49](#)
- [Connecting the SRX300 Services Gateway Grounding Cable on page 50](#)

Connecting the SRX300 Services Gateway Grounding Cable

You ground the services gateway by connecting a grounding cable to earth ground and then attaching it to the chassis grounding point located on the back panel of the device using a metric M5 x 0.8, 12-mm-long grounding screw.

You must provide the following items:

- One metric M5 x 0.8, 12-mm-long grounding screw
- Grounding cables
- Cable lugs (for example, Panduit LCC6-10A-L)



CAUTION: Before you connect power to the services gateway, a licensed electrician must attach a cable lug to the grounding and power cables that you supply. A cable with an incorrectly attached lug can damage the services gateway (for example, by causing a short circuit).

To ground the device:

1. Attach an electrostatic discharge (ESD) grounding strap to your bare wrist, and connect the strap to the ESD point on the chassis. For more details, see [“Preventing Electrostatic Discharge Damage to the SRX300 Services Gateway” on page 95](#).
2. Ensure that all grounding surfaces are clean and brought to a bright finish before grounding connections are made.
3. Connect the grounding cable to a proper earth ground.
4. Place the grounding cable lug over the grounding point (sized for metric M5 x 0.8, 12-mm-long grounding screws) on the rear of the chassis as shown in [Figure 11 on page 51](#).

Figure 11: Connecting the Grounding Cable to the SRX300 Services Gateway

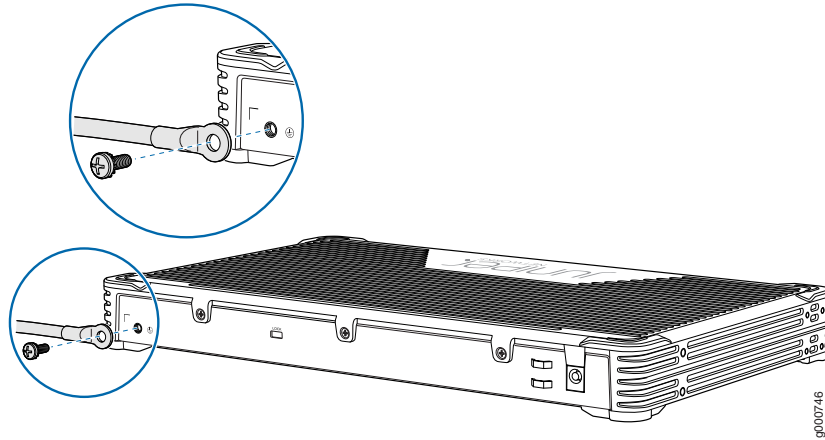

5. Secure the grounding cable lug to the grounding point, first with the washer, then with the screw.
6. Dress the grounding cable and verify that it does not touch or block access to the services gateway components and that it does not drape where people could trip on it.



NOTE: The device should be permanently connected to ground during operation.

Related Documentation

- [Required Tools and Parts for Grounding the SRX300 Services Gateway on page 49](#)
- [SRX300 Services Gateway Grounding Specifications on page 49](#)

Connecting the SRX300 Services Gateway to External Devices

- [Connecting the Dial-Up Modem to the Console Port on the SRX300 Services Gateway on page 53](#)
- [Connecting to the SRX300 Services Gateway CLI Using a Dial-Up Modem on page 54](#)

Connecting the Dial-Up Modem to the Console Port on the SRX300 Services Gateway

To connect the dial-up modem to the console port on the services gateway:

1. Turn off power to the services gateway.
2. Turn off power to the modem.
3. Connect one end of the Ethernet cable supplied with your services gateway into the console port on the services gateway.
4. Connect the other end of the CAT-5e cable (Ethernet cable) into the RJ-45 to DB-9 serial port adapter supplied with your services gateway.
5. Connect the serial port adapter to a separately purchased DB-9 female to DB-25 male adapter or other adapter appropriate for your modem.
6. Plug the modem adapter into the DB-25 connector on the modem.
7. Connect the modem to your telephone network.
8. Turn on the power to the modem.
9. Power on the services gateway by pressing the Power button on the front panel. Verify that the PWR LED on the front panel turns green.



NOTE: Most modems have an RS-232 DB-25 connector. You must separately purchase an adapter to connect your modem to the RJ-45 to DB-9 adapter and the Ethernet cable supplied with the services gateway.

Related Documentation

- [Connecting to the SRX300 Services Gateway CLI Using a Dial-Up Modem on page 54](#)

Connecting to the SRX300 Services Gateway CLI Using a Dial-Up Modem

To remotely connect to the CLI through a dial-up modem connected to the console port on the services gateway:

1. Connect a modem at your remote location to a management device such as a PC or laptop computer.
2. Start your asynchronous terminal emulation application (such as Microsoft Windows HyperTerminal) on the PC or laptop computer.
3. Select the COM port to which the modem is connected (for example, COM1).
4. Configure the port settings :
 - Bits per second—9600
 - Data bits—8
 - Parity—None
 - Stop bits—1
 - Flow control—None
5. In the HyperTerminal window, enter **AT**.

An **OK** response verifies that the modem can communicate successfully with the COM port on the PC or laptop.

6. Dial the modem that is connected to the console port on the services gateway by entering **ATDT *remote-modem-number***. For example, if the number of the modem connected to the console port on the services gateway is 0013033033030, enter **ATDT 0013033033030**.

The services gateway login prompt appears.

7. Log in as the root user. No password is required at initial connection, but you must assign a root password before committing any configuration settings.

Related Documentation

- [Connecting the Dial-Up Modem to the Console Port on the SRX300 Services Gateway on page 53](#)

Providing Power to the SRX300 Services Gateway

- [Connecting the SRX300 Services Gateway to the Power Supply on page 55](#)
- [Powering On the SRX300 Services Gateway on page 56](#)
- [Powering Off the SRX300 Services Gateway on page 56](#)

Connecting the SRX300 Services Gateway to the Power Supply

To connect the device to the power supply:



CAUTION: Before connecting the device to the power supply, attach an ESD strap to an ESD point and place the other end of the strap around your bare wrist.

1. Plug the DC connector end of the power cable into the power connector on the back of the device as shown in [Figure 12 on page 55](#).
2. Plug the AC adapter end of the power cable into an AC power outlet.

Figure 12: Connecting the SRX300 Services Gateway to the Power Supply

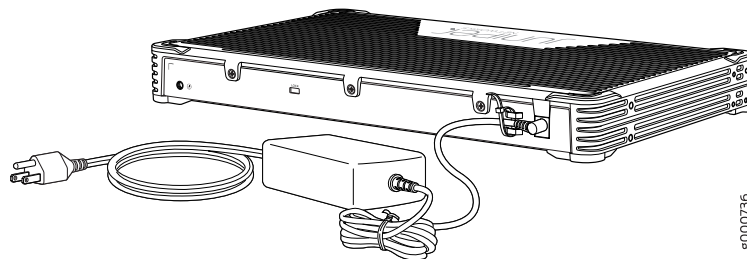

Related Documentation

- [Powering On the SRX300 Services Gateway on page 56](#)
- [Powering Off the SRX300 Services Gateway on page 56](#)

Powering On the SRX300 Services Gateway

To power on the services gateway:

1. Ensure that you have connected the power supply to the device.
2. Insert the plug of the power supply adapter into an AC power source receptacle.
3. Turn on the power to the AC power receptacle.

The device starts automatically as the power supply completes its startup sequence. The PWR LED lights during startup and remains on when the device is operating normally.



NOTE: After the power supply is turned on, it can take up to 60 seconds for status indicators—such as the STAT and PWR LEDs—to show that the power supply is functioning normally. Ignore error indicators that appear during the first 60 seconds.



NOTE: When the system is completely powered off and you turn on the power supply, the device starts as the power supply completes its startup sequence. If the device finishes starting and you need to power off the system again, first issue the CLI request `system power-off` command.

Related Documentation

- [Powering Off the SRX300 Services Gateway on page 56](#)

Powering Off the SRX300 Services Gateway

You can power off the services gateway in one of the following ways:

- Graceful shutdown—Press and immediately release the Power button. The device begins gracefully shutting down the operating system and then powers itself off.



WARNING: Use the graceful shutdown method to power off or reboot the services gateway.

- Forced shutdown—Press the Power button and hold it for ten seconds. The device immediately powers itself off without shutting down the operating system.



WARNING: Use the forced shutdown method as a last resort to recover the services gateway if the services gateway operating system is not responding to the graceful shutdown method.



WARNING: Do not press the Power button while the device is shutting down.



CAUTION: Forced shutdown can result in data loss and corruption of the file system.



NOTE: To remove power completely from the device, unplug the power cord or switch off the AC power source.

After powering off a power supply, wait at least 10 seconds before turning it back on. After powering on a power supply, wait at least 10 seconds before turning it off.

The power button on the services gateway is a standby power switch, which will not turn off the input power to the services gateway.



TIP: When you are powering off the device, the CLI displays the following message: `Turning the system power off. You can now safely remove the power cable to completely power off the device.`



NOTE: You can use the `request system reboot` CLI command to schedule a reboot.

Related Documentation

- [Powering On the SRX300 Services Gateway on page 56](#)

Performing the Initial Configuration

- [SRX300 Services Gateway Software Configuration Overview on page 59](#)
- [Understanding SRX300 Services Gateway Factory-Default Settings on page 59](#)
- [Viewing SRX300 Services Gateway Factory-Default Settings on page 60](#)
- [Accessing J-Web on the SRX300 Services Gateway on page 62](#)
- [Configuring the SRX300 Services Gateway Using the J-Web Setup Wizard on page 63](#)
- [Accessing the CLI on the SRX300 Services Gateway on page 65](#)
- [Connecting to the SRX300 Services Gateway from the CLI Remotely on page 66](#)
- [Configuring the SRX300 Services Gateway Using the CLI on page 67](#)
- [Verifying Settings for the SRX300 Services Gateway on page 69](#)

SRX300 Services Gateway Software Configuration Overview

The services gateway is shipped with the Juniper Networks Junos operating system (Junos OS) preinstalled and ready to be configured when the device is powered on. You can perform the initial software configuration of the services gateway by using the browser-based setup wizard or by using the command-line interface (CLI).

Before configuring the device, gather the configuration information required to deploy the device in your network. At a minimum, the setup wizard requires the following information:

- Device name
- Password for the root user
- Time information for the services gateway location

**Related
Documentation**

- [Configuring the SRX300 Services Gateway Using the J-Web Setup Wizard on page 63](#)
- [Configuring the SRX300 Services Gateway Using the CLI on page 67](#)

Understanding SRX300 Services Gateway Factory-Default Settings

Your services gateway comes configured with a factory-default configuration. The default configuration includes the following security configuration:

- Two security zones are created: trust and untrust.
- Interface ge-0/0/0 is in the untrust zone, while interfaces ge-0/0/1 through ge-0/0/5 are in the trust zone.
- A security policy is created that permits outbound traffic from the trust zone to the untrust zone.
- Source Network Address Translation (NAT) is configured on the trust zone.

Table 17 on page 60 lists the default interface configuration.

Table 17: Default Interface Configuration for the SRX300 Services Gateway

Port Label	Interface	Security Zone	DHCP State	IP Address
0/0	ge-0/0/0	untrust	Client	Dynamically assigned
0/1	ge-0/0/1	trust	Server	192.168.1.1/24
0/2	ge-0/0/2	trust	Server	192.168.2.1/24
0/3	ge-0/0/3	trust	Server	192.168.3.1/24
0/4	ge-0/0/4	trust	Server	192.168.4.1/24
0/5	ge-0/0/5	trust	Server	192.168.5.1/24

If the current active configuration fails, you can use the **load factory-default** command to revert to the factory-default configuration.

Related Documentation

- [Viewing SRX300 Services Gateway Factory-Default Settings on page 60](#)

Viewing SRX300 Services Gateway Factory-Default Settings

To view the factory-default configuration of the services gateway using the CLI:

1. Verify that the services gateway is powered on.
2. Log in as the root user and provide your credentials.
3. In shell mode, navigate to the `/etc/config` folder.

```
% cd /etc/config
```

4. View the list of default config files.

```
% ls
```

The following sample output displays the list of factory-default configuration files:

```
b1v-defaults.conf          srx210he2-factory.conf
ex9204-factory.conf       srx210he2-poe-defaults.conf
ex9208-factory.conf       srx210he2-poe-factory.conf
ex9214-factory.conf       srx220-8xge-factory.conf
j-series-defaults.conf    srx220-poe-8xge-factory.conf
```

```

jnu-factory.conf
jsrxsme-series-defaults.conf
jsrxsme-series-factory.conf
junos-defaults.conf
junos-factory.conf
junos-fips-defaults.conf
ptx-series-defaults.conf
shmlog
srx100-8xfe-factory.conf
srx100b-defaults.conf
srx100b-factory.conf
srx100h-defaults.conf
srx100h-factory.conf
srx100h2-defaults.conf
srx100h2-factory.conf
srx110-8xfe-vdsl-factory.conf
srx110-8xfe-vdsl-wl-factory.conf
srx110-8xfe-wl-factory.conf
srx110b-defaults.conf
srx110b-va-defaults.conf
srx110b-va-factory.conf
srx110b-vb-defaults.conf
srx110b-vb-factory.conf
srx110b-wl-defaults.conf
srx110b-wl-factory.conf
srx110h-defaults.conf
srx110h-va-defaults.conf
srx110h-va-factory.conf
srx110h-va-wl-defaults.conf
srx110h-va-wl-factory.conf
srx110h-vb-defaults.conf
srx110h-vb-factory.conf
srx110h-vb-wl-defaults.conf
srx110h-vb-wl-factory.conf
srx110h-wl-defaults.conf
srx110h-wl-factory.conf
srx110h2-va-defaults.conf
srx110h2-va-factory.conf
srx110h2-vb-defaults.conf
srx110h2-vb-factory.conf
srx210-2xge-6xfe-factory.conf
srx210-poe-2xge-6xfe-factory.conf
srx210b-defaults.conf
srx210b-factory.conf
srx210be-defaults.conf
srx210be-factory.conf
srx210h-defaults.conf
srx210h-factory.conf
srx210h-poe-defaults.conf
srx210h-poe-factory.conf
srx210he-defaults.conf
srx210he-factory.conf
srx210he-poe-defaults.conf
srx210he-poe-factory.conf
srx210he2-defaults.conf
srx220h-defaults.conf
srx220h-factory.conf
srx220h-poe-defaults.conf
srx220h-poe-factory.conf
srx220h2-defaults.conf
srx220h2-factory.conf
srx220h2-poe-defaults.conf
srx220h2-poe-factory.conf
srx240-16xge-factory.conf
srx240-poe-16xge-factory.conf
srx240b-factory.conf
srx240b2-factory.conf
srx240h-dc-defaults.conf
srx240h-dc-factory.conf
srx240h-defaults.conf
srx240h-factory.conf
srx240h-poe-defaults.conf
srx240h-poe-factory.conf
srx240h2-dc-defaults.conf
srx240h2-dc-factory.conf
srx240h2-defaults.conf
srx240h2-factory.conf
srx240h2-poe-defaults.conf
srx240h2-poe-factory.conf
srx300-8xge-factory.conf
srx300-defaults.conf
srx300-factory.conf
srx300-lem-factory.conf
srx320-8xge-factory.conf
srx320-defaults.conf
srx320-factory.conf
srx320-lem-factory.conf
srx320-poe-8xge-factory.conf
srx320-poe-defaults.conf
srx320-poe-factory.conf
srx320-poe-lem-factory.conf
srx340-16xge-factory.conf
srx340-defaults.conf
srx340-factory.conf
srx340-lem-factory.conf
srx345-defaults.conf
srx345-factory.conf
srx345-lem-factory.conf
srx550-6xge-factory.conf
srx550-defaults.conf
srx550-factory.conf
srx550m-6xge-factory.conf
srx550m-defaults.conf
srx550m-factory.conf
srx650-4xge-factory.conf
srx650-defaults.conf
srx650-factory.conf
subs-mgmt-proc-set
vrr-series-defaults.conf

```

5. View the required default config file.

```
% vi config filename
```

- Related Documentation**
- [Understanding SRX300 Services Gateway Factory-Default Settings on page 59](#)

Accessing J-Web on the SRX300 Services Gateway

The J-Web interface is a Web-based graphical interface that allows you to operate a services gateway without commands.



NOTE: To access the J-Web interface, your management device requires one of the following supported browsers:

- Microsoft Internet Explorer version 9.0 or 10.0
- Mozilla Firefox versions 24 through 38
- Google Chrome versions 27 through 43

To access J-Web:

1. Connect any of the network ports numbered 0/1 through 0/5 to the Ethernet port on the management device, using an RJ-45 cable as shown in [Figure 13 on page 62](#).

Figure 13: Connecting to the Ethernet Port on the SRX300 Services Gateway

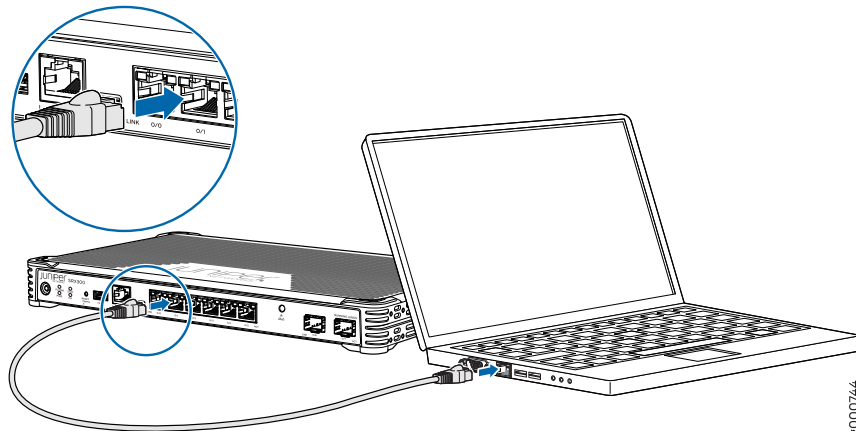

2. Ensure that the management device acquires an IP address. The IP address should be on the corresponding IP subnet for the interface you connected to in Step 1. The device functions as a DHCP server and will assign an IP address to the management device.

For example, if you are connected to port 0/1, then the IP address of the management device should be from the 192.168.1.x network. If an IP address is not assigned to the management device, manually configure an IP address. Do not assign the 192.168.1.1 IP address to the management device, as this IP address is assigned to the device. You can use the `ipconfig` (or `ifconfig` for Macintosh or Linux users) command to verify the IP address.

For information on the subnet for each interface, see “[Understanding SRX300 Services Gateway Factory-Default Settings](#)” on page 59.

3. Open a Web browser on the management device and enter the IP address **http://192.168.x.1** in the address field, where x is the port number to which you are connected on the services gateway.

Related Documentation

- [Configuring the SRX300 Services Gateway Using the J-Web Setup Wizard on page 63](#)

Configuring the SRX300 Services Gateway Using the J-Web Setup Wizard

This topic describes how to perform the initial software configuration of your services gateway using the setup wizard.

This topic includes the following sections:

- [About the Setup Wizard on page 63](#)
- [About the Default Setup Mode on page 64](#)
- [About the Guided Setup Mode on page 64](#)

About the Setup Wizard

The setup wizard guides you through the step-by-step configuration of a services gateway that can securely pass traffic. To help guide you through the process, the wizard:

- Provides recommended settings based on your previous selections. For example, the wizard recommends security policies based on the security topology you have defined.
- Determines which configuration tasks to present to you based on your selections.
- Flags any missing required configuration when you attempt to leave a page.
- Indicates which configuration elements or tasks are unavailable to you based on your previous selections by graying them out.

You can choose one of the following setup modes to configure the services gateway:

- **Default Setup mode**—This mode allows you to quickly set up a services gateway in a default security configuration. In this mode, you can configure basic system settings, such as the administrator password, and download purchased licenses. Any additional configuration can be carried out after completing the wizard setup.
- **Guided Setup mode**—This mode allows you to set up a services gateway in a custom security configuration.



NOTE: It is mandatory to configure only the device name and root password. You can skip all the other steps by clicking **Next** to go directly to the **Confirm & Apply** page to apply the configuration.

About the Default Setup Mode

If you choose the Default Setup mode, the wizard takes you through the minimal configuration needed to set up the services gateway that can securely pass traffic in the default configuration.

In the Default Setup mode, you configure:

- Device name
- Password for the root account
- Time information for the services gateway location:
 - Local time zone
 - Name or IP address of a Network Time Protocol (NTP) server, if NTP is used to set the time on the services gateway
 - Local date and time if an NTP server is not used to set the time

You cannot do additional configuration in the Default Setup mode. You must commit your changes and exit the wizard to perform any additional configuration. You can perform additional configuration by rerunning the wizard in the Guided Setup mode, by using the J-Web interface, or by using the CLI.

See the [How to Set Up Your SRX300 Services Gateway](#) for step-by-step instructions on how to configure your services gateway in the Default Setup mode.

About the Guided Setup Mode

If you choose the Guided Setup mode, the wizard guides you through configuring your services gateway in a custom security configuration. You can choose between the Basic and Expert levels based on your experience level. The following table compares the Basic and Expert levels.

Basic	Expert
Can configure only three internal zones	Can configure more than three internal zones
Can configure static and dynamic IP for the Internet zone	Can configure static IP, static pool, and dynamic IP for the Internet zone
Can configure internal zone service	Can configure internal zone service
Cannot configure internal destination NAT	Can configure internal destination NAT

Configurations you can perform with the setup wizard include:

- Configuring basic options such as device name, root password, and system time
- Configuring the security topology
 - Internet zone

- Internal zones
- DMZ
- Defining security policies and Network Address Translation (NAT) rules
- Configuring remote access



NOTE: Before applying the configuration changes to the services gateway, check the connectivity to the services gateway. You might lose connectivity if you have changed the management zone IP. Click the URL for reconnection instructions for information on how to reconnect to the device.

After you finish configuring the services gateway with the setup wizard and commit your configuration, you are redirected to the J-Web interface. Thereafter, whenever you connect to the services gateway, you are placed in the J-Web interface. You can access the setup wizard from the J-Web interface and use it to reconfigure your services gateway. To do so, select **Configuration Wizards>Set Up**. You can either edit an existing configuration or create a new configuration.



NOTE: If you elect to create a new configuration, then all the current configuration in the services gateway will be deleted.

Related Documentation

- [Accessing J-Web on the SRX300 Services Gateway on page 62](#)
- [Accessing the CLI on the SRX300 Services Gateway on page 65](#)
- [Connecting to the SRX300 Services Gateway from the CLI Remotely on page 66](#)
- [Configuring the SRX300 Services Gateway Using the CLI on page 67](#)
- [Verifying Settings for the SRX300 Services Gateway on page 69](#)

Accessing the CLI on the SRX300 Services Gateway

To access the CLI on the SRX300 Services Gateway:

1. Connect one end of the Ethernet cable to the serial console port on the services gateway.



NOTE: Alternately, you can use the USB cable to connect to the mini-USB console port on the services gateway. To use the USB console port, you must download a USB driver to the management device from the [SRX300 Software Download page](#) or [Silicon Labs page](#).

2. Connect the other end of the Ethernet cable to the RJ-45 to DB-9 serial port adapter supplied with your services gateway.

3. Connect the RJ-45 to DB-9 serial port adapter into the serial port on the management device as shown in [Figure 14 on page 66](#).

Figure 14: Connecting to the Console Port on the SRX300 Services Gateway

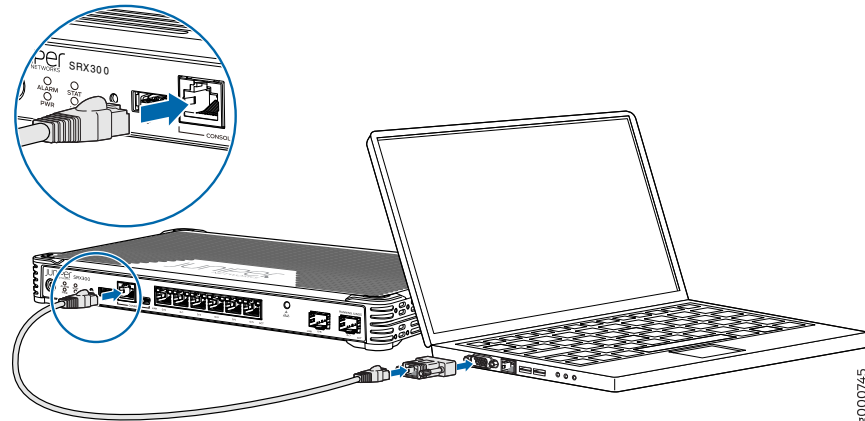

4. Start your asynchronous terminal emulation application (such as Microsoft Windows HyperTerminal) and select the appropriate COM port to use (for example, COM1).
5. Configure the serial port settings with the following values:
 - Baud rate—9600
 - Parity—N
 - Data bits—8
 - Stop bits—1
 - Flow control—none
6. Power on the services gateway. You can start performing initial software configuration on the services gateway after the device is up.

Related Documentation

- [Connecting to the SRX300 Services Gateway from the CLI Remotely on page 66](#)
- [Configuring the SRX300 Services Gateway Using the CLI on page 67](#)

Connecting to the SRX300 Services Gateway from the CLI Remotely

You can connect an SRX300 Services Gateway to the CLI from a remote location through two dial-up modems:

- A modem that is connected to the console port on the services gateway
- A second modem connected to a remote management device

The modem connection allows you to remotely perform the same console operations that you can perform locally.

- Related Documentation**
- [Configuring the SRX300 Services Gateway Using the CLI on page 67](#)

Configuring the SRX300 Services Gateway Using the CLI

This procedure connects the device to the network but does not enable it to forward traffic. For complete information about enabling the device to forward traffic, including examples, see the appropriate Junos OS configuration guides.

To configure the software:

1. Verify that the device is powered on.
2. Log in as the root user. There is no password.
3. Start the CLI.

```
root@%cli
root>
```

4. Enter configuration mode.

```
configure
[edit]
root#
```

5. Set the root authentication password by entering a cleartext password, an encrypted password, or an SSH public key string (DSA or RSA).

```
[edit]
root# set system root-authentication plain-text-password
New password: password
Retype new password: password
```

6. Configure an administrator account on the device.

```
[edit]
root# set system login user admin class super-user authentication plain-text-password
```

7. Commit the configuration to activate it on the device.

```
[edit]
root# commit
```

8. Log in as the administrative user you configured in Step 6.
9. Configure the name of the device. If the name includes spaces, enclose the name in quotation marks (" ").

```
configure
[edit]
admin# set system host-name host-name
```



NOTE: For information on the factory-default settings, see [“Understanding SRX300 Services Gateway Factory-Default Settings” on page 59](#).

10. Configure the traffic interface.

```
[edit]
admin# set interfaces ge-0/0/1 unit 0 family inet address address/prefix-length
```

11. Configure the default route.

```
[edit]
admin# set routing-options static route 0.0.0.0/0 next-hop gateway
```

12. Configure basic security zones and bind them to traffic interfaces.

```
[edit]
admin# set security zones security-zone untrust interfaces ge-0/0/0
admin# set security zones security-zone trust interfaces ge-0/0/1
admin# set security zones security-zone trust interfaces ge-0/0/1.0
      host-inbound-traffic system-services all
admin# set security zones security-zone trust interfaces ge-0/0/1.0
      host-inbound-traffic protocols all
```

13. Configure basic security policies.

```
[edit]
admin# set security policies from-zone trust to-zone untrust policy policy-name match
      source-address any destination-address any application any
admin# set security policies from-zone trust to-zone untrust policy policy-name then
      permit
```

14. Create a Network Address Translation (NAT) rule for source translation of all Internet-bound traffic.

```
[edit]
admin# set security nat source rule-set interface-nat from zone trust
admin# set security nat source rule-set interface-nat to zone untrust
admin# set security nat source rule-set interface-nat rule rule1 match source-address
      0.0.0.0/0 destination-address 0.0.0.0/0
admin# set security nat source rule-set interface-nat rule rule1 then source-nat interface
```

15. Check the configuration for validity.

```
[edit]
admin# commit check
configuration check succeeds
```

16. Commit the configuration to activate it on the device.

```
[edit]
admin# commit
commit complete
```

17. Optionally, display the configuration to verify that it is correct.

```
[edit]
admin# show
```

18. Optionally, configure additional properties by adding the necessary configuration statements. Then commit the changes to activate them on the services gateway.

```
[edit]
admin@device# commit
```

19. When you have finished configuring the services gateway, exit configuration mode.

```
[edit]
```

```
admin@device# exit
admin@device>
```

- Related Documentation**
- [Configuring the SRX300 Services Gateway Using the J-Web Setup Wizard on page 63](#)

Verifying Settings for the SRX300 Services Gateway

Access <http://www.juniper.net> to verify connectivity. If the page does not load, perform the following checks to see if you can identify the problem:

- Check if the cable connecting the ISP-supplied device to the SRX Series device is firmly seated.
- Check if the ISP-supplied device connecting your SRX Series device to the Internet is turned on and working properly. Try turning it on and off again.
- Check if the management device has an IP address in the 192.168.1.0/24 subnetwork.

After you complete these steps, the device can pass traffic from any trust port to the untrust port. You can connect other devices to the SRX Series device.

- Related Documentation**
- [Configuring the SRX300 Services Gateway Using the CLI on page 67](#)
 - [Configuring the SRX300 Services Gateway Using the J-Web Setup Wizard on page 63](#)

PART 4

Maintaining and Troubleshooting Components

- [Maintaining Components on page 73](#)
- [Troubleshooting Components on page 75](#)

Maintaining Components

- [Required Tools and Parts for Maintaining the SRX300 Services Gateway Hardware Components on page 73](#)
- [Routine Maintenance Procedures for the SRX300 Services Gateway on page 73](#)
- [Maintaining the SRX300 Services Gateway Power Supply on page 74](#)

Required Tools and Parts for Maintaining the SRX300 Services Gateway Hardware Components

The following tools and parts are required to maintain the hardware components of the services gateway:

- Electrostatic bag or antistatic mat
- Electrostatic discharge (ESD) grounding wrist strap
- Flat-blade screw-blade screwdriver, approximately 1/8 in. (3 mm)
- Phillips (+) screwdrivers, numbers 1 and 2

Related Documentation

- [Routine Maintenance Procedures for the SRX300 Services Gateway on page 73](#)
- [Maintaining the SRX300 Services Gateway Power Supply on page 74](#)

Routine Maintenance Procedures for the SRX300 Services Gateway

For optimum performance of the services gateway, perform the following preventive maintenance procedures regularly:

- Inspect the installation site for moisture, loose wires or cables, and excessive dust.
- Make sure that airflow is unobstructed around the device and into the air intake vents.
- Check the status LEDs on the front panel of the services gateway.

Related Documentation

- [Required Tools and Parts for Maintaining the SRX300 Services Gateway Hardware Components on page 73](#)
- [Maintaining the SRX300 Services Gateway Power Supply on page 74](#)

Maintaining the SRX300 Services Gateway Power Supply

To maintain the power supply on the services gateway:

- Make sure that the power and grounding cables are arranged so that they do not obstruct access to other device components.
- Routinely check the PWR LED on the front panel. If this LED is solid green, the power supplies are functioning normally.
- Periodically inspect the site to ensure that the grounding and power cables connected to the services gateway are securely in place and that there is no moisture accumulating near the services gateway.



.....
CAUTION: We recommend using a surge protector for the power connection.
.....

Related Documentation

- [Required Tools and Parts for Maintaining the SRX300 Services Gateway Hardware Components on page 73](#)
- [Routine Maintenance Procedures for the SRX300 Services Gateway on page 73](#)

Troubleshooting Components

- [Troubleshooting Resources for the SRX300 Services Gateway Overview on page 75](#)
- [Troubleshooting Chassis and Interface Alarm Messages on the SRX300 Services Gateway on page 76](#)
- [Troubleshooting the Power System on the SRX300 Services Gateway on page 77](#)
- [Using the RESET CONFIG Button on the SRX300 Services Gateway on page 77](#)
- [Changing the RESET CONFIG Button Behavior on the SRX300 Services Gateway on page 78](#)

Troubleshooting Resources for the SRX300 Services Gateway Overview

To troubleshoot a services gateway, you use the Junos OS command-line interface (CLI) and LEDs on the components:

- **LEDs**—When the services gateway detects an alarm condition, the alarm LED on the interfaces glows red or yellow.
- **CLI**—The CLI is the primary tool for controlling and troubleshooting hardware, Junos OS, and network connectivity. Use the CLI to display more information about alarms. CLI commands display information about network connectivity derived from the ping and traceroute utilities. For information about using the CLI to troubleshoot Junos OS, see the appropriate Junos OS configuration guide.
- **JTAC**—If you need assistance during troubleshooting, you can contact the Juniper Networks Technical Assistance Center (JTAC) by using the Web or by telephone. If you encounter software problems, or problems with hardware components not discussed here, contact JTAC.

**Related
Documentation**

- [Troubleshooting Chassis and Interface Alarm Messages on the SRX300 Services Gateway on page 76](#)
- [Troubleshooting the Power System on the SRX300 Services Gateway on page 77](#)

Troubleshooting Chassis and Interface Alarm Messages on the SRX300 Services Gateway

When the services gateway detects an alarm condition, the alarm LED on the front panel turns red or amber as appropriate. To view a more detailed description of the alarm cause, issue the **show chassis alarms** CLI command.

Table 18 on page 76 describes alarms that can occur for an SRX300 Services Gateway chassis component.

Table 18: SRX300 Services Gateway Chassis Alarm Conditions and Corrective Actions

Component	Alarm Conditions	Action	Alarm Severity
Boot media	The services gateway boots from an alternate boot device.	<ul style="list-style-type: none"> If the internal flash memory fails at startup, the services gateway automatically boots itself from the alternative boot device (USB storage device). <p>NOTE: If you configured your services gateway to boot from an alternative boot device, ignore this alarm condition.</p> <ul style="list-style-type: none"> Reformat the internal flash memory and install a bootable image. (See the Installation and Upgrade Guide and Network Monitoring and Troubleshooting Guide) If you did not configure the services gateway to boot from an alternative boot device, contact JTAC. 	Amber (minor)
Hardware components on the services gateway	The services gateway chassis temperature or chassis is too warm	Check the room temperature. See "SRX300 Services Gateway Environmental Specifications" on page 13.	Amber (minor)
	The services gateway temperature is too high, either because of an internal overheating condition or because the maximum recommended room temperature has been exceeded.	The services gateway shuts down automatically in 4 minutes.	Red (major)

Related Documentation

- [Troubleshooting the Power System on the SRX300 Services Gateway on page 77](#)

Troubleshooting the Power System on the SRX300 Services Gateway

The LEDs on the services gateway enable you to determine the performance and operation. The PWR LED, located on the front panel of the services gateway, indicates the different settings with respect to the power system.

Table 19 on page 77 describes different PWR LED status settings and their corrective actions.

Table 19: Services Gateway Power LED Status

LED Status	Meaning	Possible Cause and Corrective Action
Green	Device is receiving power.	Normal indication. No action is required.
Amber	Indicates that the power button has been pressed and quickly released.	Normal indication. No action is required.
Off	Indicates that the device is not receiving power.	<ul style="list-style-type: none"> Verify that the AC power cord from the power source to the device is not damaged. If the insulation is cracked or broken, immediately replace the cord or cable. Ensure that the socket you plug in is in working condition. Ensure the device has an AC input voltage between 100 and 240 VAC. If you cannot determine the cause of the problem or need additional assistance, contact JTAC.

- Related Documentation**
- [Troubleshooting Chassis and Interface Alarm Messages on the SRX300 Services Gateway on page 76](#)

Using the RESET CONFIG Button on the SRX300 Services Gateway

If a configuration fails or denies management access to the services gateway, you can use the RESET CONFIG button to restore the device to the factory-default configuration or a rescue configuration. For example, if someone inadvertently commits a configuration that denies management access to a services gateway, you can delete the invalid configuration and replace it with a rescue configuration by pressing the RESET CONFIG button.



NOTE: The RESET CONFIG button is recessed to prevent it from being pressed accidentally.

The rescue configuration is a previously committed, valid configuration. You must have previously set the rescue configuration through the J-Web interface or the CLI. To press the RESET CONFIG button, insert a small probe (such as a straightened paper clip) into the pinhole on the front panel.

- By default, pressing and quickly releasing the RESET CONFIG button loads and commits the rescue configuration through the J-Web interface or the CLI. The Status LED is solid amber during this time.
- By default, pressing and holding the RESET CONFIG button for 15 seconds or more—until the Status LED is solid amber — deletes all configurations on the device, including the backup configurations and rescue configuration, and loads and commits the factory configuration.

**Related
Documentation**

- [Changing the RESET CONFIG Button Behavior on the SRX300 Services Gateway on page 78](#)

Changing the RESET CONFIG Button Behavior on the SRX300 Services Gateway

You can change the default operation of the RESET CONFIG button by limiting how the button resets the services gateway:

- To prevent the RESET CONFIG button from setting the device to the factory-default configuration and deleting all other configurations:

```
admin@host# set chassis config-button no-clear
```

You can still press and quickly release the button to reset it to the rescue configuration.

- To prevent the RESET CONFIG button from setting the device to the rescue configuration:

```
admin@host# set chassis config-button no-rescue
```

You can still press and hold the button for 15 seconds or more to reset the gateway to the factory-default configuration.

- To disable the button and prevent the device from resetting to either configuration:

```
admin@host# set chassis config-button no-clear no-rescue
```

The **no-clear** option prevents the RESET CONFIG button from deleting all configurations on the services gateway. The **no-rescue** option prevents the RESET CONFIG button from loading the rescue configuration.

To return the function of the RESET CONFIG button to its default behavior, remove the **config-button** statement from the device configuration.

**Related
Documentation**

- [Using the RESET CONFIG Button on the SRX300 Services Gateway on page 77](#)

PART 5

Replacing Components

- [Contacting Customer Support and Returning Components on page 81](#)

Contacting Customer Support and Returning Components

- Contacting Customer Support on page 81
- Returning a SRX300 Services Gateway Component to Juniper Networks on page 82
- Locating the SRX300 Services Gateway Chassis Serial Number and Agency Labels on page 83
- Listing the SRX300 Services Gateway Component Details with the CLI on page 83
- Information You Might Need to Supply to JTAC on page 84
- Required Tools and Parts for Packing the SRX300 Services Gateway on page 84
- Packing the SRX300 Services Gateway for Shipment on page 84
- Packing SRX300 Services Gateway Components for Shipment on page 85

Contacting Customer Support

Once you have located the serial numbers of the device or component, you can return the device or component for repair or replacement. For this, you need to contact Juniper Networks Technical Assistance Center (JTAC).

You can contact JTAC 24 hours a day, 7 days a week, using any of the following methods:

- On the Web: Using the Case Manager link at <http://www.juniper.net/support/>
- By telephone:
 - From the US and Canada: 1-888-314-JTAC
 - From all other locations: 1-408-745-9500



NOTE: If contacting JTAC by telephone, enter your 11-digit case number followed by the pound (#) key if this is an existing case, or press the star (*) key to be routed to the next available support engineer.

Related Documentation

- Returning a SRX300 Services Gateway Component to Juniper Networks on page 82

- [Locating the SRX300 Services Gateway Chassis Serial Number and Agency Labels on page 83](#)
- [Listing the SRX300 Services Gateway Component Details with the CLI on page 83](#)
- [Information You Might Need to Supply to JTAC on page 84](#)
- [Required Tools and Parts for Packing the SRX300 Services Gateway on page 84](#)
- [Packing the SRX300 Services Gateway for Shipment on page 84](#)
- [Packing SRX300 Services Gateway Components for Shipment on page 85](#)

Returning a SRX300 Services Gateway Component to Juniper Networks

To return an SRX300 Services Gateway or component to Juniper Networks for repair or replacement:

1. Determine the part number and serial number of the services gateway or component.
2. Obtain a Return Materials Authorization (RMA) number from JTAC.



NOTE: Do not return the services gateway or any component to Juniper Networks unless you have first obtained an RMA number. Juniper Networks reserves the right to refuse shipments that do not have an RMA. Refused shipments are returned to the customer via collect freight.

3. Pack the SRX300 Services Gateway or component for shipping.

For more information about return and repair policies, see the customer support webpage at <http://www.juniper.net/support/guidelines.html>.

For product problems or technical support issues, open a support case using the Case Manager link at <http://www.juniper.net/support/> or call 1-888-314-JTAC (within the United States) or 1-408-745-9500 (outside the United States).

Related Documentation

- [Contacting Customer Support on page 81](#)
- [Locating the SRX300 Services Gateway Chassis Serial Number and Agency Labels on page 83](#)
- [Listing the SRX300 Services Gateway Component Details with the CLI on page 83](#)
- [Information You Might Need to Supply to JTAC on page 84](#)
- [Required Tools and Parts for Packing the SRX300 Services Gateway on page 84](#)
- [Packing the SRX300 Services Gateway for Shipment on page 84](#)
- [Packing SRX300 Services Gateway Components for Shipment on page 85](#)

Locating the SRX300 Services Gateway Chassis Serial Number and Agency Labels

The chassis serial number is located on the side of the chassis.

Related Documentation

- [Contacting Customer Support on page 81](#)
- [Returning a SRX300 Services Gateway Component to Juniper Networks on page 82](#)
- [Listing the SRX300 Services Gateway Component Details with the CLI on page 83](#)
- [Information You Might Need to Supply to JTAC on page 84](#)
- [Required Tools and Parts for Packing the SRX300 Services Gateway on page 84](#)
- [Packing the SRX300 Services Gateway for Shipment on page 84](#)
- [Packing SRX300 Services Gateway Components for Shipment on page 85](#)

Listing the SRX300 Services Gateway Component Details with the CLI

Before contacting Juniper Networks to request an RMA, you must find the serial number on the SRX300 Services Gateway or component.

To list all of the SRX300 Services Gateway components and their serial numbers, enter the following command:

```
user@host> show chassis hardware
Hardware inventory:
Item          Version  Part number  Serial number  Description
Chassis
Routing Engine  REV 02   650-065039  CV3315AN0010  RE-SRX300
FPC 0
  PIC 0
Power Supply 0
  6xGE,2xGE SFP Base PIC
```

Related Documentation

- [Contacting Customer Support on page 81](#)
- [Returning a SRX300 Services Gateway Component to Juniper Networks on page 82](#)
- [Locating the SRX300 Services Gateway Chassis Serial Number and Agency Labels on page 83](#)
- [Information You Might Need to Supply to JTAC on page 84](#)
- [Required Tools and Parts for Packing the SRX300 Services Gateway on page 84](#)
- [Packing the SRX300 Services Gateway for Shipment on page 84](#)
- [Packing SRX300 Services Gateway Components for Shipment on page 85](#)

Information You Might Need to Supply to JTAC

When requesting support from JTAC by telephone, be prepared to provide the following information:

- Your existing case number, if you have one
- Details of the failure or problem
- Type of activity being performed on the services gateway when the problem occurred
- Configuration data displayed by one or more **show** commands
- Your name, organization name, telephone number, fax number, and shipping address

**Related
Documentation**

- [Contacting Customer Support on page 81](#)
- [Returning a SRX300 Services Gateway Component to Juniper Networks on page 82](#)

Required Tools and Parts for Packing the SRX300 Services Gateway

To remove the components from the SRX300 Services Gateway or to remove the services gateway from a rack, you need the following tools and parts:

- Electrostatic bag or antistatic mat for each component
- Electrostatic discharge (ESD) grounding wrist strap
- Flat-blade screwdriver, approximately 1/4 in. (6 mm)
- Phillips (+) screwdrivers, numbers 1 and 2

**Related
Documentation**

- [Contacting Customer Support on page 81](#)
- [Information You Might Need to Supply to JTAC on page 84](#)
- [Packing the SRX300 Services Gateway for Shipment on page 84](#)
- [Packing SRX300 Services Gateway Components for Shipment on page 85](#)

Packing the SRX300 Services Gateway for Shipment

To pack the SRX300 Services Gateway for shipment:

1. Retrieve the shipping carton and packing materials in which the services gateway was originally shipped. If you do not have these materials, contact your Juniper Networks representative about approved packaging materials.
2. Attach an electrostatic discharge (ESD) grounding strap to your bare wrist and connect the strap to the ESD point on the chassis or to an outside ESD point if the device is disconnected from earth ground. For more information about ESD, see [“Preventing Electrostatic Discharge Damage to the SRX300 Services Gateway” on page 95](#).

3. On the console or other management device connected to the services gateway, enter CLI operational mode and issue the following command to shut down the services gateway software:

```
user@host> request system halt
```

Wait until a message appears on the console confirming that the operating system has halted.

4. Shut down power to the services gateway by pressing the Power button on the front of the services gateway.
5. Disconnect power from the services gateway.
6. Remove the cables that connect to all external devices.
7. If the device is installed on a wall or rack, have one person support the weight of the device while another person unscrews and removes the mounting screws.
8. Place the services gateway in the shipping carton.
9. Cover the services gateway with an ESD bag, and place the packing foam on top of and around the device.
10. Replace the accessory box on top of the packing foam.
11. Securely tape the box closed.
12. Write the Return Materials Authorization (RMA) number on the exterior of the box to ensure proper tracking.

Related Documentation

- [Contacting Customer Support on page 81](#)
- [Returning a SRX300 Services Gateway Component to Juniper Networks on page 82](#)
- [Information You Might Need to Supply to JTAC on page 84](#)
- [Required Tools and Parts for Packing the SRX300 Services Gateway on page 84](#)
- [Packing SRX300 Services Gateway Components for Shipment on page 85](#)

Packing SRX300 Services Gateway Components for Shipment

Follow these guidelines for packing and shipping individual components of the services gateway:

- When you return a component, make sure that it is adequately protected with packing materials and packed so that the pieces are prevented from moving around inside the carton.
- Use the original shipping materials if they are available.
- Place the individual component in an electrostatic bag.
- Write the Return Materials Authorization (RMA) number on the exterior of the box to ensure proper tracking.

**Related
Documentation**

- [Contacting Customer Support on page 81](#)
- [Returning a SRX300 Services Gateway Component to Juniper Networks on page 82](#)
- [Required Tools and Parts for Packing the SRX300 Services Gateway on page 84](#)
- [Packing the SRX300 Services Gateway for Shipment on page 84](#)

PART 6

Safety and Regulatory Compliance Information

- [General Safety Guidelines and Warnings on page 89](#)
- [Fire Safety Requirements on page 97](#)
- [Laser and LED Safety Guidelines and Warnings on page 99](#)
- [Maintenance and Operational Safety Guidelines and Warnings on page 103](#)
- [Electrical Safety Guidelines and Warnings on page 111](#)
- [Agency Approvals and Regulatory Compliance Information on page 113](#)

General Safety Guidelines and Warnings

- [SRX300 Services Gateway Definition of Safety Warning Levels on page 89](#)
- [SRX300 Services Gateway General Safety Guidelines and Warnings on page 91](#)
- [SRX300 Services Gateway Safety Requirements, Warnings, and Guidelines on page 92](#)
- [Restricted Access Area Warning on page 92](#)
- [Qualified Personnel Warning on page 94](#)
- [Preventing Electrostatic Discharge Damage to the SRX300 Services Gateway on page 95](#)

SRX300 Services Gateway Definition of Safety Warning Levels

This topic defines the following four levels of safety warnings used in Juniper Networks technical publications:



NOTE: You might find this information helpful in a particular situation or might otherwise overlook it.



CAUTION: You need to observe the specified guidelines to avoid minor injury or discomfort to you or severe damage to the services gateway.



WARNING: This symbol is used with laser warnings. Unterminated optical connectors can emit invisible laser radiation. Focusing your eye directly on a laser source—even a low-power laser—could permanently damage the eye.



WARNING: This symbol means danger. You are in a situation that could cause bodily injury. Before you work on any equipment, be aware of the hazards involved with electrical circuitry and be familiar with standard practices for preventing accidents.

Waarschuwing Dit waarschuwingssymbool betekent gevaar. U verkeert in een situatie die lichamelijk letsel kan veroorzaken. Voordat u aan enige apparatuur gaat werken, dient u zich bewust te zijn van de bij elektrische schakelingen betrokken risico's en dient u op de hoogte te zijn van standaard maatregelen om ongelukken te voorkomen.

Varoitus Tämä varoitusmerkki merkitsee vaaraa. Olet tilanteessa, joka voi johtaa ruumiinvammaan. Ennen kuin työskentelet minkään laitteiston parissa, ota selvää sähkökytkentöihin liittyvistä vaaroista ja tavanomaisista onnettomuuksien ehkäisykeinoista.

Attention Ce symbole d'avertissement indique un danger. Vous vous trouvez dans une situation pouvant causer des blessures ou des dommages corporels. Avant de travailler sur un équipement, soyez conscient des dangers posés par les circuits électriques et familiarisez-vous avec les procédures couramment utilisées pour éviter les accidents.

Warnung Dieses Warnsymbol bedeutet Gefahr. Sie befinden sich in einer Situation, die zu einer Körperverletzung führen könnte. Bevor Sie mit der Arbeit an irgendeinem Gerät beginnen, seien Sie sich der mit elektrischen Stromkreisen verbundenen Gefahren und der Standardpraktiken zur Vermeidung von Unfällen bewußt.

Avvertenza Questo simbolo di avvertenza indica un pericolo. La situazione potrebbe causare infortuni alle persone. Prima di lavorare su qualsiasi apparecchiatura, occorre conoscere i pericoli relativi ai circuiti elettrici ed essere al corrente delle pratiche standard per la prevenzione di incidenti.

Advarsel Dette varselsymbolet betyr fare. Du befinner deg i en situasjon som kan føre til personskade. Før du utfører arbeid på utstyr, må du være oppmerksom på de faremomentene som elektriske kretser innebærer, samt gjøre deg kjent med vanlig praksis når det gjelder å unngå ulykker.

Aviso Este símbolo de aviso indica perigo. Encontra-se numa situação que lhe poderá causar danos físicos. Antes de começar a trabalhar com qualquer equipamento, familiarize-se com os perigos relacionados com circuitos eléctricos, e com quaisquer práticas comuns que possam prevenir possíveis acidentes.

¡Atención! Este símbolo de aviso significa peligro. Existe riesgo para su integridad física. Antes de manipular cualquier equipo, considerar los riesgos que entraña la corriente eléctrica y familiarizarse con los procedimientos estándar de prevención de accidentes.

Varning! Denna varningssymbol signalerar fara. Du befinner dig i en situation som kan leda till personskada. Innan du utför arbete på någon utrustning måste du vara medveten om farorna med elkretsar och känna till vanligt förfarande för att förebygga skador.

- Related Documentation**
- [SRX300 Services Gateway General Safety Guidelines and Warnings on page 91](#)
 - [SRX300 Services Gateway Safety Requirements, Warnings, and Guidelines on page 92](#)
 - [Restricted Access Area Warning on page 92](#)
 - [Qualified Personnel Warning on page 94](#)
 - [Preventing Electrostatic Discharge Damage to the SRX300 Services Gateway on page 95](#)

SRX300 Services Gateway General Safety Guidelines and Warnings

The following guidelines help ensure your safety and protect the services gateway from damage. The list of guidelines might not address all potentially hazardous situations in your working environment, so be alert and exercise good judgment at all times.

- Perform only the procedures explicitly described in these topics. Ensure that only authorized service personnel perform other system services.
- Keep the area around the chassis clear and free from dust before, during, and after installation.
- Keep tools away from areas where people could trip on them.
- Wear safety glasses if you are working under any conditions that could be hazardous to your eyes.
- Do not perform any actions that create a potential hazard to people or make the equipment unsafe.
- Never install or manipulate wiring during electrical storms.
- Never install electrical jacks in wet locations unless the jacks are specifically designed for wet environments.
- Do not open or remove chassis covers or sheet metal parts unless instructions are provided in this guide. Such an action could cause severe electrical shock.
- Do not push or force any objects through any opening in the chassis frame. Such an action could result in electrical shock or fire.
- Avoid spilling liquid onto the services gateway chassis or onto any services gateway component. Such an action could cause electrical shock or damage the services gateway.
- Avoid touching uninsulated electrical wires or terminals that have not been disconnected from their power source. Such an action could cause electrical shock.

- Related Documentation**
- [SRX300 Services Gateway General Safety Guidelines and Warnings on page 91](#)
 - [SRX300 Services Gateway Safety Requirements, Warnings, and Guidelines on page 92](#)
 - [Restricted Access Area Warning on page 92](#)
 - [Qualified Personnel Warning on page 94](#)

- [Preventing Electrostatic Discharge Damage to the SRX300 Services Gateway on page 95](#)

SRX300 Services Gateway Safety Requirements, Warnings, and Guidelines

To avoid harm to yourself or the device as you install and maintain it, follow the guidelines for working with and near electrical equipment, as well as the safety procedures for working with devices. For a discussion of how to make the installation site a safe environment and a list of safety warnings, see “[General Site Installation Guidelines for the SRX300 Services Gateway](#)” on page 16 and “[SRX300 Services Gateway General Safety Guidelines and Warnings](#)” on page 91.



NOTE: Providing an exhaustive set of guidelines for working with electrical equipment is beyond the scope of this guide.

Related Documentation

- [SRX300 Services Gateway Definition of Safety Warning Levels on page 89](#)
- [SRX300 Services Gateway General Safety Guidelines and Warnings on page 91](#)
- [Restricted Access Area Warning on page 92](#)
- [Qualified Personnel Warning on page 94](#)
- [Preventing Electrostatic Discharge Damage to the SRX300 Services Gateway on page 95](#)

Restricted Access Area Warning



WARNING: The services gateway is intended for installation in restricted access areas. A restricted access area is an area to which access can be gained only by service personnel through the use of a special tool, lock and key, or other means of security, and which is controlled by the authority responsible for the location.

Waarschuwing Dit toestel is bedoeld voor installatie op plaatsen met beperkte toegang. Een plaats met beperkte toegang is een plaats waar toegang slechts door servicepersoneel verkregen kan worden door middel van een speciaal instrument, een slot en sleutel, of een ander veiligheidsmiddel, en welke beheerd wordt door de overheidsinstantie die verantwoordelijk is voor de locatie.

Varoitus Tämä laite on tarkoitettu asennettavaksi paikkaan, johon pääsy on rajoitettua. Paikka, johon pääsy on rajoitettua, tarkoittaa paikkaa, johon vain huoltohenkilöstö pääsee jonkin erikoistyökalun, lukkoon sopivan avaimen tai jonkin muun turvalaitteen avulla ja joka on paikasta vastuussa olevien toimivaltaisten henkilöiden valvoma.

Attention Cet appareil est à installer dans des zones d'accès réservé. Ces dernières sont des zones auxquelles seul le personnel de service peut accéder en utilisant un outil spécial, un mécanisme de verrouillage et une clé, ou tout autre moyen de sécurité. L'accès aux zones de sécurité est sous le contrôle de l'autorité responsable de l'emplacement.

Warnung Diese Einheit ist zur Installation in Bereichen mit beschränktem Zutritt vorgesehen. Ein Bereich mit beschränktem Zutritt ist ein Bereich, zu dem nur Wartungspersonal mit einem Spezialwerkzeugs, Schloß und Schlüssel oder anderer Sicherheitsvorkehrungen Zugang hat, und der von dem für die Anlage zuständigen Gremium kontrolliert wird.

Avvertenza Questa unità deve essere installata in un'area ad accesso limitato. Un'area ad accesso limitato è un'area accessibile solo a personale di assistenza tramite un'attrezzo speciale, lucchetto, o altri dispositivi di sicurezza, ed è controllata dall'autorità responsabile della zona.

Advarsel Denne enheten er laget for installasjon i områder med begrenset adgang. Et område med begrenset adgang gir kun adgang til servicepersonale som bruker et spesielt verktøy, lås og nøkkel, eller en annen sikkerhetsanordning, og det kontrolleres av den autoriteten som er ansvarlig for området.

Aviso Esta unidade foi concebida para instalação em áreas de acesso restrito. Uma área de acesso restrito é uma área à qual apenas tem acesso o pessoal de serviço autorizado, que possua uma ferramenta, chave e fechadura especial, ou qualquer outra forma de segurança. Esta área é controlada pela autoridade responsável pelo local.

¡Atención! Esta unidad ha sido diseñada para instalarse en áreas de acceso restringido. Área de acceso restringido significa un área a la que solamente tiene acceso el personal de servicio mediante la utilización de una herramienta especial, cerradura con llave, o algún otro medio de seguridad, y que está bajo el control de la autoridad responsable del local.

Varning! Denna enhet är avsedd för installation i områden med begränsat tillträde. Ett område med begränsat tillträde får endast tillträdas av servicepersonal med ett speciellt verktyg, lås och nyckel, eller annan säkerhetsanordning, och kontrolleras av den auktoritet som ansvarar för området.

Related Documentation

- [SRX300 Services Gateway Definition of Safety Warning Levels on page 89](#)
- [SRX300 Services Gateway General Safety Guidelines and Warnings on page 91](#)
- [SRX300 Services Gateway Safety Requirements, Warnings, and Guidelines on page 92](#)
- [Qualified Personnel Warning on page 94](#)
- [Preventing Electrostatic Discharge Damage to the SRX300 Services Gateway on page 95](#)

Qualified Personnel Warning



WARNING: Only trained and qualified personnel should install or replace the services gateway.

Waarschuwing Installatie en reparaties mogen uitsluitend door getraind en bevoegd personeel uitgevoerd worden.

Varoitus Ainoastaan koulutettu ja pätevä henkilökunta saa asentaa tai vaihtaa tämän laitteen.

Attention Tout installation ou remplacement de l'appareil doit être réalisé par du personnel qualifié et compétent.

Warnung Gerät nur von geschultem, qualifiziertem Personal installieren oder auswechseln lassen.

Avvertenza Solo personale addestrato e qualificato deve essere autorizzato ad installare o sostituire questo apparecchio.

Advarsel Kun kvalifisert personell med riktig opplæring bør montere eller bytte ut dette utstyret.

Aviso Este equipamento deverá ser instalado ou substituído apenas por pessoal devidamente treinado e qualificado.

¡Atención! Estos equipos deben ser instalados y reemplazados exclusivamente por personal técnico adecuadamente preparado y capacitado.

Varning! Denna utrustning ska endast installeras och bytas ut av utbildad och kvalificerad personal.

Related Documentation

- [SRX300 Services Gateway Definition of Safety Warning Levels on page 89](#)
- [SRX300 Services Gateway General Safety Guidelines and Warnings on page 91](#)
- [SRX300 Services Gateway Safety Requirements, Warnings, and Guidelines on page 92](#)
- [Restricted Access Area Warning on page 92](#)
- [Preventing Electrostatic Discharge Damage to the SRX300 Services Gateway on page 95](#)

Preventing Electrostatic Discharge Damage to the SRX300 Services Gateway

Many services gateway hardware components are sensitive to damage from static electricity. Some components can be impaired by voltages as low as 30 V. You can easily generate potentially damaging static voltages whenever you handle plastic or foam packing material or if you move components across plastic or carpets. Observe the following guidelines to minimize the potential for electrostatic discharge (ESD) damage, which can cause intermittent or complete component failures:

- Always use an ESD wrist strap or ankle strap, and verify that it is in direct contact with your skin.



CAUTION: For safety, periodically check the resistance value of the ESD strap. The resistance must be in the range of 1 to 10 Mohm.

- When handling any component that is removed from the chassis, verify that the equipment end of your ESD strap is attached to one of the ESD points on the chassis.
- Avoid contact between the component and your clothing. ESD voltages emitted from clothing can damage components.
- When removing or installing a component, always place it component-side up on an antistatic surface, in an antistatic card rack, or in an electrostatic bag. See [Figure 15 on page 95](#). If you are returning a component, place it into an electrostatic bag before packing it.

Figure 15: Placing a Component into an Electrostatic Bag

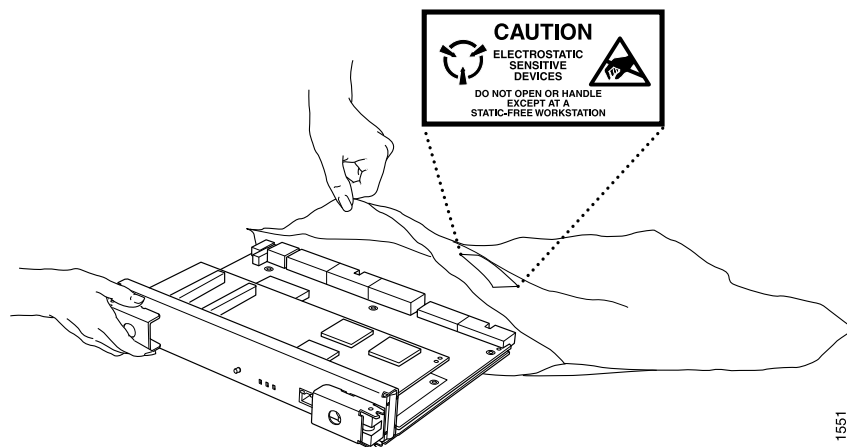

Related Documentation

- [SRX300 Services Gateway Definition of Safety Warning Levels on page 89](#)
- [SRX300 Services Gateway General Safety Guidelines and Warnings on page 91](#)
- [SRX300 Services Gateway Safety Requirements, Warnings, and Guidelines on page 92](#)
- [Restricted Access Area Warning on page 92](#)
- [Qualified Personnel Warning on page 94](#)

Fire Safety Requirements

- [SRX300 Services Gateway Fire Safety Requirements and Fire Suppression Equipment on page 97](#)

SRX300 Services Gateway Fire Safety Requirements and Fire Suppression Equipment

In the event of a fire emergency involving devices and other network equipment, the safety of people is the primary concern. Establish procedures for protecting people in the event of a fire emergency, provide safety training, and properly provision fire control equipment and fire extinguishers.

In addition, establish procedures to protect your equipment in the event of a fire emergency. Juniper Networks products should be installed in an environment suitable for electronic equipment. We recommend that fire suppression equipment be available in the event of a fire in the vicinity of the equipment and that all local fire, safety, and electrical codes and ordinances be observed when installing and operating your equipment.

In the event of an electrical hazard or an electrical fire, first turn power off to the equipment at the source. Then use a Type C fire extinguisher to extinguish the fire. Type C fire extinguishers, which use noncorrosive fire retardants such as carbon dioxide (CO₂) and Halotron, are most effective for suppressing electrical fires. Type C fire extinguishers displace the oxygen from the point of combustion to eliminate the fire. For extinguishing fire on or around equipment that draws air from the environment for cooling, use this type of inert oxygen displacement extinguisher instead of an extinguisher that leave residues on equipment.

Do not use multipurpose Type ABC chemical fire extinguishers (dry chemical fire extinguishers) near Juniper Networks equipment. The primary ingredient in these fire extinguishers is monoammonium phosphate, which is very sticky and difficult to clean. In addition, in minute amounts of moisture, monoammonium phosphate can become highly corrosive and corrodes most metals.

Any equipment in a room in which a chemical fire extinguisher has been discharged is subject to premature failure and unreliable operation. The equipment is considered to be irreparably damaged.



NOTE: To keep warranties effective, do not use a dry chemical fire extinguisher to control a fire at or near a Juniper Networks services gateway. If a dry chemical fire extinguisher is used, the unit is no longer eligible for coverage under a service agreement.

We recommend that you dispose of any irreparably damaged equipment in an environmentally responsible manner.

Related Documentation

- [SRX300 Services Gateway Definition of Safety Warning Levels on page 89](#)
- [SRX300 Services Gateway General Safety Guidelines and Warnings on page 91](#)
- [SRX300 Services Gateway Safety Requirements, Warnings, and Guidelines on page 92](#)

CHAPTER 22

Laser and LED Safety Guidelines and Warnings

- [General Laser Safety Guidelines on page 99](#)
- [Class 1 Laser Warning on page 100](#)
- [Class 1 LED Product Warning on page 100](#)
- [Laser Beam Warning on page 101](#)
- [Radiation from Open Port Apertures Warning on page 102](#)

General Laser Safety Guidelines

When working around the services gateway, observe the following safety guidelines to prevent eye injury:

- Do not look into unterminated ports or at fibers that connect to unknown sources.
- Do not examine unterminated optical ports with optical instruments.
- Avoid direct exposure to the beam.



WARNING: Unterminated optical connectors can emit invisible laser radiation. The lens in the human eye focuses all the laser power on the retina, so focusing the eye directly on a laser source—even a low-power laser—could permanently damage the eye.

Related Documentation

- [Class 1 Laser Warning on page 100](#)
- [Class 1 LED Product Warning on page 100](#)
- [Laser Beam Warning on page 101](#)
- [Radiation from Open Port Apertures Warning on page 102](#)

Class 1 Laser Warning



WARNING: Class 1 laser product.

Waarschuwing Klasse-1 laser produkt.

Varoitus Luokan 1 lasertuote.

Attention Produit laser de classe I.

Warnung Laserprodukt der Klasse 1.

Avvertenza Prodotto laser di Classe 1.

Advarsel Laserprodukt av klasse 1.

Aviso Produto laser de classe 1.

¡Atención! Producto láser Clase I.

Varning! Laserprodukt av klass 1.

Related Documentation

- [General Laser Safety Guidelines on page 99](#)
- [Class 1 LED Product Warning on page 100](#)
- [Laser Beam Warning on page 101](#)
- [Radiation from Open Port Apertures Warning on page 102](#)

Class 1 LED Product Warning



WARNING: Class 1 LED product.

Waarschuwing Klasse 1 LED-product.

Varoitus Luokan 1 valodiodituote.

Attention Alarme de produit LED Class I.

Warnung Class 1 LED-Produktwarnung.

Avvertenza Avvertenza prodotto LED di Classe 1.

Advarsel LED-produkt i klasse 1.

Aviso Produto de classe 1 com LED.

¡Atención! Aviso sobre producto LED de Clase 1.

Varning! Lysdiodprodukt av klass 1.**Related
Documentation**

- [General Laser Safety Guidelines on page 99](#)
- [Class 1 Laser Warning on page 100](#)
- [Laser Beam Warning on page 101](#)
- [Radiation from Open Port Apertures Warning on page 102](#)

Laser Beam Warning

WARNING: Do not stare into the laser beam or view it directly with optical instruments.

Waarschuwing Niet in de straal staren of hem rechtstreeks bekijken met optische instrumenten.

Varoitus Älä katso säteeseen äläkä tarkastele sitä suoraan optisen laitteen avulla.

Attention Ne pas fixer le faisceau des yeux, ni l'observer directement à l'aide d'instruments optiques.

Warnung Nicht direkt in den Strahl blicken und ihn nicht direkt mit optischen Geräten prüfen.

Avvertenza Non fissare il raggio con gli occhi né usare strumenti ottici per osservarlo direttamente.

Advarsel Stirr eller se ikke direkte på strålen med optiske instrumenter.

Aviso Não olhe fixamente para o raio, nem olhe para ele diretamente com instrumentos ópticos.

¡Atención! No mirar fijamente el haz ni observarlo directamente con instrumentos ópticos.

Varning! Rikta inte blicken in mot strålen och titta inte direkt på den genom optiska instrument.

**Related
Documentation**

- [General Laser Safety Guidelines on page 99](#)
- [Class 1 Laser Warning on page 100](#)
- [Class 1 LED Product Warning on page 100](#)
- [Radiation from Open Port Apertures Warning on page 102](#)

Radiation from Open Port Apertures Warning



WARNING: Because invisible radiation can be emitted from the aperture of the port when no fiber cable is connected, avoid exposure to radiation and do not stare into open apertures.

Waarschuwing Aangezien onzichtbare straling vanuit de opening van de poort kan komen als er geen fiberkabel aangesloten is, dient blootstelling aan straling en het kijken in open openingen vermeden te worden.

Varoitus Koska portin aukosta voi emittoitua näkymätöntä säteilyä, kun kuitukaapelia ei ole kytkettynä, vältä säteilylle altistumista äläkä katso avoimiin aukkoihin.

Attention Des radiations invisibles à l'il nu pouvant traverser l'ouverture du port lorsqu'aucun câble en fibre optique n'y est connecté, il est recommandé de ne pas regarder fixement l'intérieur de ces ouvertures.

Warnung Aus der Port-Öffnung können unsichtbare Strahlen emittieren, wenn kein Glasfaserkabel angeschlossen ist. Vermeiden Sie es, sich den Strahlungen auszusetzen, und starren Sie nicht in die Öffnungen!

Avvertenza Quando i cavi in fibra non sono inseriti, radiazioni invisibili possono essere emesse attraverso l'apertura della porta. Evitate di esporvi alle radiazioni e non guardate direttamente nelle aperture.

Advarsel Unngå utsettelse for stråling, og stirr ikke inn i åpninger som er åpne, fordi usynlig stråling kan emitteres fra portens åpning når det ikke er tilkoblet en fiberkabel.

Aviso Dada a possibilidade de emissão de radiação invisível através do orifício da via de acesso, quando esta não tiver nenhum cabo de fibra conectado, deverá evitar a exposição à radiação e não deverá olhar fixamente para orifícios que se encontrarem a descoberto.

¡Atención! Debido a que la apertura del puerto puede emitir radiación invisible cuando no existe un cable de fibra conectado, evite mirar directamente a las aperturas para no exponerse a la radiación.

Varning! Osynlig strålning kan avges från en portöppning utan ansluten fiberkabel och du bör därför undvika att bli utsatt för strålning genom att inte stirra in i oskyddade öppningar.

Related Documentation

- [General Laser Safety Guidelines on page 99](#)
- [Class 1 Laser Warning on page 100](#)
- [Class 1 LED Product Warning on page 100](#)
- [Laser Beam Warning on page 101](#)

Maintenance and Operational Safety Guidelines and Warnings

- [Battery-Handling Warning on page 103](#)
- [Lightning Activity Warning on page 104](#)
- [Jewelry Removal Warning on page 105](#)
- [Operating Temperature Warning on page 106](#)
- [Product Disposal Warning on page 108](#)

Battery-Handling Warning



WARNING: Replacing the battery incorrectly might result in an explosion. Replace the battery only with the same or equivalent type recommended by the manufacturer. Dispose of used batteries according to the manufacturer's instructions.

Waarschuwing Er is ontploffingsgevaar als de batterij verkeerd vervangen wordt. Vervang de batterij slechts met hetzelfde of een equivalent type dat door de fabrikant aanbevolen is. Gebruikte batterijen dienen overeenkomstig fabrieksvoorschriften weggeworpen te worden.

Varoitus Räjähdyksen vaara, jos akku on vaihdettu väärään akkuun. Käytä vaihtamiseen ainoastaan saman- tai vastaaventyyppistä akkua, joka on valmistajan suosittelema. Hävitä käytetyt akut valmistajan ohjeiden mukaan.

Attention Danger d'explosion si la pile n'est pas remplacée correctement. Ne la remplacer que par une pile de type semblable ou équivalent, recommandée par le fabricant. Jeter les piles usagées conformément aux instructions du fabricant.

Warnung Bei Einsetzen einer falschen Batterie besteht Explosionsgefahr. Ersetzen Sie die Batterie nur durch den gleichen oder vom Hersteller empfohlenen Batterietyp. Entsorgen Sie die benutzten Batterien nach den Anweisungen des Herstellers.

Avvertenza Pericolo di esplosione se la batteria non è installata correttamente. Sostituire solo con una di tipo uguale o equivalente, consigliata dal produttore. Eliminare le batterie usate secondo le istruzioni del produttore.

Advarsel Det kan være fare for eksplosjon hvis batteriet skiftes på feil måte. Skift kun med samme eller tilsvarende type som er anbefalt av produsenten. Kasser brukte batterier i henhold til produsentens instruksjoner.

Aviso Existe perigo de explosão se a bateria for substituída incorrectamente. Substitua a bateria por uma bateria igual ou de um tipo equivalente recomendado pelo fabricante. Destrua as baterias usadas conforme as instruções do fabricante.

¡Atención! Existe peligro de explosión si la batería se reemplaza de manera incorrecta. Reemplazar la batería exclusivamente con el mismo tipo o el equivalente recomendado por el fabricante. Desechar las baterías gastadas según las instrucciones del fabricante.

Varning! Explosionsfara vid felaktigt batteribyte. Ersätt endast batteriet med samma batterityp som rekommenderas av tillverkaren eller motsvarande. Följ tillverkarens anvisningar vid kassering av använda batterier.

**Related
Documentation**

- [Lightning Activity Warning on page 104](#)
- [Jewelry Removal Warning on page 105](#)
- [Operating Temperature Warning on page 106](#)
- [Product Disposal Warning on page 108](#)

Lightning Activity Warning



WARNING: Do not work on the system or connect or disconnect cables during periods of lightning activity.

Waarschuwing Tijdens onweer dat gepaard gaat met bliksem, dient u niet aan het systeem te werken of kabels aan te sluiten of te ontkoppelen.

Varoitus Älä työskentele järjestelmän parissa äläkä yhdistä tai irrota kaapeleita ukkosilmalla.

Attention Ne pas travailler sur le système ni brancher ou débrancher les câbles pendant un orage.

Warnung Arbeiten Sie nicht am System und schließen Sie keine Kabel an bzw. trennen Sie keine ab, wenn es gewittert.

Avvertenza Non lavorare sul sistema o collegare oppure scollegare i cavi durante un temporale con fulmini.

Advarsel Utfør aldri arbeid på systemet, eller koble kabler til eller fra systemet når det tordner eller lynet.

Aviso Não trabalhe no sistema ou ligue e desligue cabos durante períodos de mau tempo (trovoada).

¡Atención! No operar el sistema ni conectar o desconectar cables durante el transcurso de descargas eléctricas en la atmósfera.

Varning! Vid åska skall du aldrig utföra arbete på systemet eller ansluta eller koppla loss kablar.

- Related Documentation**
- [Battery-Handling Warning on page 103](#)
 - [Jewelry Removal Warning on page 105](#)
 - [Operating Temperature Warning on page 106](#)
 - [Product Disposal Warning on page 108](#)

Jewelry Removal Warning



WARNING: Before working on equipment that is connected to power lines, remove jewelry, including rings, necklaces, and watches. Metal objects heat up when connected to power and ground and can cause serious burns or weld the metal object to the terminals.

Waarschuwing Alvorens aan apparatuur te werken die met elektrische leidingen is verbonden, sieraden (inclusief ringen, kettingen en horloges) verwijderen. Metalen voorwerpen worden warm wanneer ze met stroom en aarde zijn verbonden, en kunnen ernstige brandwonden veroorzaken of het metalen voorwerp aan de aansluitklemmen lassen.

Varoitus Ennen kuin työskentelet voimavirtajohtoihin kytkettyjen laitteiden parissa, ota pois kaikki korut (sormukset, kaulakorut ja kellot mukaan lukien). Metalliesineet kuumenevat, kun ne ovat yhteydessä sähkövirran ja maan kanssa, ja ne voivat aiheuttaa vakavia palovammoja tai hitsata metalliesineet kiinni liitäntänapoihin.

Attention Avant d'accéder à cet équipement connecté aux lignes électriques, ôter tout bijou (anneaux, colliers et montres compris). Lorsqu'ils sont branchés à l'alimentation et reliés à la terre, les objets métalliques chauffent, ce qui peut provoquer des blessures graves ou souder l'objet métallique aux bornes.

Warnung Vor der Arbeit an Geräten, die an das Netz angeschlossen sind, jeglichen Schmuck (einschließlich Ringe, Ketten und Uhren) abnehmen. Metallgegenstände erhitzen sich, wenn sie an das Netz und die Erde

angeschlossen werden, und können schwere Verbrennungen verursachen oder an die Anschlußklemmen angeschweißt werden.

Avvertenza Prima di intervenire su apparecchiature collegate alle linee di alimentazione, togliersi qualsiasi monile (inclusi anelli, collane, braccialetti ed orologi). Gli oggetti metallici si riscaldano quando sono collegati tra punti di alimentazione e massa: possono causare ustioni gravi oppure il metallo può saldarsi ai terminali.

Advarsel Fjern alle smykker (inkludert ringer, halskjeder og klokker) før du skal arbeide på utstyr som er koblet til kraftledninger. Metallgjenstander som er koblet til kraftledninger og jord blir svært varme og kan forårsake alvorlige brannskader eller smelte fast til polene.

Aviso Antes de trabalhar em equipamento que esteja ligado a linhas de corrente, retire todas as jóias que estiver a usar (incluindo anéis, fios e relógios). Os objectos metálicos aquecerão em contacto com a corrente e em contacto com a ligação à terra, podendo causar queimaduras graves ou ficarem soldados aos terminais.

¡Atención! Antes de operar sobre equipos conectados a líneas de alimentación, quitarse las joyas (incluidos anillos, collares y relojes). Los objetos de metal se calientan cuando se conectan a la alimentación y a tierra, lo que puede ocasionar quemaduras graves o que los objetos metálicos queden soldados a los bornes.

Varning! Tag av alla smycken (inklusive ringar, halsband och armbandsur) innan du arbetar på utrustning som är kopplad till kraftledningar. Metallobjekt hettas upp när de kopplas ihop med ström och jord och kan förorsaka allvarliga brännskador; metallobjekt kan också sammansvetsas med kontakterna.

**Related
Documentation**

- [Battery-Handling Warning on page 103](#)
- [Lightning Activity Warning on page 104](#)
- [Operating Temperature Warning on page 106](#)
- [Product Disposal Warning on page 108](#)

Operating Temperature Warning



WARNING: To prevent the services gateway from overheating, do not operate it in an area that exceeds the maximum recommended ambient temperature of 104°F (40°C). To prevent airflow restriction, allow at least 6 in. (15.2 cm) of clearance around the ventilation openings.

Waarschuwing Om te voorkomen dat welke services gateway van de Juniper Networks services gateway dan ook oververhit raakt, dient u deze niet te bedienen op een plaats waar de maximale aanbevolen omgevingstemperatuur van 40°C wordt overschreden. Om te voorkomen dat de luchtstroom wordt beperkt, dient er minstens 15,2 cm speling rond de ventilatie-openingen te zijn.

Varoitus Ettei Juniper Networks services gateway-sarjan reititin ylikuumentuisi, sitä ei saa käyttää tilassa, jonka lämpötila ylittää korkeimman suositellun ympäristölämpötilan 40°C. Ettei ilmanvaihto estyisi, tuuletusaukkojen ympärille on jätettävä ainakin 15,2 cm tilaa.

Attention Pour éviter toute surchauffe des routeurs de la gamme Juniper Networks services gateway, ne l'utilisez pas dans une zone où la température ambiante est supérieure à 40°C. Pour permettre un flot d'air constant, dégagez un espace d'au moins 15,2 cm autour des ouvertures de ventilations.

Warnung Um einen services gateway der services gateway vor Überhitzung zu schützen, darf dieser nicht in einer Gegend betrieben werden, in der die Umgebungstemperatur das empfohlene Maximum von 40°C überschreitet. Um Lüftungsverschluß zu verhindern, achten Sie darauf, daß mindestens 15,2 cm lichter Raum um die Lüftungsöffnungen herum frei bleibt.

Avvertenza Per evitare il surriscaldamento dei services gateway, non adoperateli in un locale che ecceda la temperatura ambientale massima di 40°C. Per evitare che la circolazione dell'aria sia impedita, lasciate uno spazio di almeno 15.2 cm di fronte alle aperture delle ventole.

Advarsel Unngå overoppheting av eventuelle rutere i Juniper Networks services gateway Disse skal ikke brukes på steder der den anbefalte maksimale omgivelsestemperaturen overstiger 40°C. Sørg for at klaringen rundt lufteåpningene er minst 15,2 cm for å forhindre nedsatt luftsirkulasjon.

Aviso Para evitar o sobreaquecimento do encaminhador Juniper Networks services gateway, não utilize este equipamento numa área que exceda a temperatura máxima recomendada de 40°C. Para evitar a restrição à circulação de ar, deixe pelo menos um espaço de 15,2 cm à volta das aberturas de ventilação.

¡Atención! Para impedir que un encaminhador de la serie Juniper Networks services gateway se recaliente, no lo haga funcionar en un área en la que se supere la temperatura ambiente máxima recomendada de 40°C. Para impedir la restricción de la entrada de aire, deje un espacio mínimo de 15,2 cm alrededor de las aperturas para ventilación.

Varning! Förhindra att en Juniper Networks services gateway överhettas genom att inte använda den i ett område där den maximalt rekommenderade omgivningstemperaturen på 40°C överskrids. Förhindra att luftcirkulationen

inskränks genom att se till att det finns fritt utrymme på minst 15,2 cm omkring ventilationsöppningarna.

.....

.....



WARNING: Power off the device before installing or removing components. Check the device temperature before touching the device.

.....

.....

Related Documentation

- [Battery-Handling Warning on page 103](#)
- [Lightning Activity Warning on page 104](#)
- [Jewelry Removal Warning on page 105](#)
- [Product Disposal Warning on page 108](#)

Product Disposal Warning



WARNING: Disposal of this product must be handled according to all national laws and regulations.

Waarschuwing Dit produkt dient volgens alle landelijke wetten en voorschriften te worden afgedankt.

Varoitus Tämän tuotteen lopullisesta hävittämisestä tulee huolehtia kaikkia valtakunnallisia lakeja ja säännöksiä noudattaen.

Attention La mise au rebut définitive de ce produit doit être effectuée conformément à toutes les lois et réglementations en vigueur.

Warnung Dieses Produkt muß den geltenden Gesetzen und Vorschriften entsprechend entsorgt werden.

Avvertenza L'eliminazione finale di questo prodotto deve essere eseguita osservando le normative italiane vigenti in materia

Advarsel Endelig disponering av dette produktet må skje i henhold til nasjonale lover og forskrifter.

Aviso A descartagem final deste produto deverá ser efectuada de acordo com os regulamentos e a legislação nacional.

¡Atención! El desecho final de este producto debe realizarse según todas las leyes y regulaciones nacionales

Varning! Slutlig kassering av denna produkt bör skötas i enlighet med landets alla lagar och föreskrifter.

.....

.....

**Related
Documentation**

- [Battery-Handling Warning on page 103](#)
- [Lightning Activity Warning on page 104](#)
- [Jewelry Removal Warning on page 105](#)
- [Operating Temperature Warning on page 106](#)

Electrical Safety Guidelines and Warnings

- [In Case of Electrical Accident on page 111](#)
- [General Electrical Safety Guidelines and Warnings on page 111](#)

In Case of Electrical Accident

If an electrical accident results in an injury, take the following actions in this order:

1. Use caution. Be aware of potentially hazardous conditions that could cause further injury.
2. Disconnect power from the services gateway.
3. If possible, send another person to get medical aid. Otherwise, assess the condition of the victim, then call for help.

**Related
Documentation**

- [General Electrical Safety Guidelines and Warnings on page 111](#)

General Electrical Safety Guidelines and Warnings

- Install the services gateway in compliance with the following local, national, or international electrical codes:
 - United States—National Fire Protection Association (NFPA 70), United States National Electrical Code
 - Canada—Canadian Electrical Code, Part 1, CSA C22.1
 - Other countries—International Electromechanical Commission (IEC) 60364, Part 1 through Part 7
 - Evaluated to the TN power system
- Locate the emergency power-off switch for the room in which you are working so that if an electrical accident occurs, you can quickly turn off the power.
- Do not work alone if potentially hazardous conditions exist anywhere in your workspace.
- Never assume that power is disconnected from a circuit. Always check the circuit before starting to work.

- Carefully look for possible hazards in your work area, such as moist floors, ungrounded power extension cords, and missing safety grounds.
- Operate the services gateway within marked electrical ratings and product usage instructions.
- For the services gateway and peripheral equipment to function safely and correctly, use the cables and connectors specified for the attached peripheral equipment, and make certain they are in good condition.

**Related
Documentation**

- [In Case of Electrical Accident on page 111](#)

CHAPTER 25

Agency Approvals and Regulatory Compliance Information

- [SRX300 Services Gateway Agency Approvals on page 113](#)
- [SRX300 Services Gateway EMC Requirements on page 114](#)

SRX300 Services Gateway Agency Approvals

The services gateway complies with the following standards:

- Safety
 - CAN/CSA-C22.2 No.60950-1 (2007) Information Technology Equipment
 - UL 60950-1 (2nd Ed.) Information Technology Equipment
 - EN 60950-1 (2006+ A11:2010) Information Technology Equipment - Safety
 - IEC 60950-1 (2005 +A1:2009) Information Technology Equipment - Safety (All country deviations): CB Scheme report
 - EN 60825-1 (2007) Safety of Laser Products - Part 1: Equipment classification and requirements
- EMC
 - EN 300 386 V1.6.1 Telecom Network Equipment - EMC requirements
 - EN 55032:2012 + EN55032:2012/AC:2013 Electromagnetic compatibility of multimedia equipment - Emission requirements
 - CISPR 32:2012
 - EN 55022:2010/AC:2011 European Radiated Emissions
 - CISPR 22 edition 6.0 : 2008-09
 - EN 55024: 2010 Information Technology Equipment Immunity Characteristics
 - CISPR 24 edition 2b :2010 COREC 2011 IT Equipment Immunity Characteristics
- EMI

- FCC 47CFR , Part 15 Class A (2012) USA Radiated Emissions
- ICES-003 Issue 5, August 2012 Canada Radiated Emissions
- VCCI-V-3/2013.04 and V-4/2012.04 Japanese Radiated Emissions
- BSMI CNS 13438 and NCC C6357 Taiwan Radiated Emissions
- Immunity
 - EN-61000-3-2 Power Line Harmonics
 - EN-61000-3-3 Voltage Fluctuations and Flicker
 - EN-61000-4-2 Electrostatic Discharge
 - EN-61000-4-3 Radiated Immunity
 - EN-61000-4-4 (2004) Electrical Fast Transients
 - EN-61000-4-5 (2006) Surge
 - EN-61000-4-6 (2007) Low Frequency Common Immunity
 - EN-61000-4-11 (2004) Voltage Dips and Sags
 - EN 55024 +A1+A2 (1998) Information Technology Equipment Immunity Characteristics
- Environmental
 - Reduction of Hazardous Substances (ROHS) 6
- Telco
 - Common Language Equipment Identifier (CLEI) code

**Related
Documentation**

- [SRX300 Services Gateway EMC Requirements on page 114](#)

SRX300 Services Gateway EMC Requirements

Canada

This Class A digital apparatus complies with Canadian ICES-003.

Cet appareil numérique de la classe A est conforme à la norme NMB-003 du Canada.

European Community

This is a Class A product. In a domestic environment this product may cause radio interference in which case the user may be required to take adequate measures.

Israel

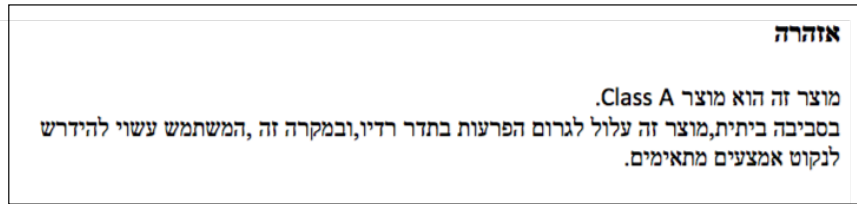

The preceding translates as follows:

This product is Class A. In residential environments, the product may cause radio interference, and in such a situation, the user may be required to take adequate measures.

Japan

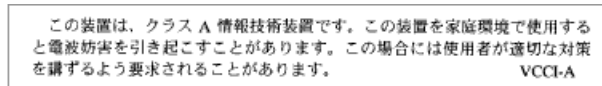

The preceding translates as follows:

This is a Class A product. In a domestic environment this product may cause radio interference in which case the user may be required to take adequate measures.

VCCI-A

United States

The services gateway has been tested and found to comply with the limits for a Class A digital device of the FCC Rules. These limits are designed to provide reasonable protection against harmful interference when the equipment is operated in a commercial environment. This equipment generates, uses, and can radiate radio frequency energy and, if not installed and used in accordance with the instruction manual, may cause harmful interference to radio communications. Operation of this equipment in a residential area is likely to cause harmful interference in which case the user will be required to correct the interference at his own expense.

Related Documentation

- [SRX300 Services Gateway Agency Approvals on page 113](#)

