



USER'S GUIDE

Thermal Printer

MP-B20 SERIES

Read this USER'S GUIDE carefully before using the printer.
Keep this USER'S GUIDE in a place where it can be accessed quickly.

Seiko Instruments Inc.

Rev.01 April 2017
Rev.02 November 2017
Rev.03 June 2018
Rev.04 November 2018
Rev.05 April 2020
Rev.06 July 2020
Rev.07 October 2021

Copyright ©2017-2021 by Seiko Instruments Inc.
All rights reserved.

The information contained herein is the property of SII and shall not be reproduced in whole or in part without prior written approval of SII.

SII reserves the right to make changes in the specifications and materials contained herein without notice and shall not be responsible for any damages (including consequential) caused by reliance on the materials presented, including but not limited to typographical, arithmetic, and listing errors.

This product is developed as a product for industrial equipment use.

SII ● is a trademark of Seiko Instruments Inc.
Bluetooth® is a registered trademark of Bluetooth SIG, Inc.
IOS is a trademark or registered trademark of Cisco in the U.S.
and other countries and is used under license.
All other trademarks are the properties of their respective companies.

Applicable EC Directive and Standards

Product:	Thermal Printer MP-B20
Directive:	Title
2014/53/EU	Radio Equipment Directive
2011/65/EU (Commission Delegated Directive (EU) 2015/863)	Restriction of the use of certain hazardous substances (RoHS) Directive

Standards

EN 301 489-1
EN 301 489-17
EN 300 328
EN 62368-1
EN 55032 Class A
EN 55024
EN IEC 63000



Restrictions: This product is for use only with nominal voltage in each country.

This product may be used in following all EU and EFTA countries:

EU

Austria, Belgium, Bulgaria, Croatia, Cyprus, Czech Republic, Denmark, Estonia,
Finland, France, Germany, Greece, Hungary, Ireland, Italy, Latvia, Lithuania,
Luxembourg, Malta, Poland, Portugal, Romania, Slovakia, Slovenia,
Spain, Sweden, Netherlands

EFTA

Iceland, Norway, Switzerland, Liechtenstein

Applicable UK Directive and Standards

Product: Thermal Printer MP-B20

Directive:

Radio Equipment Regulations 2017

The Restriction of the Use of Certain Hazardous Substances in Electrical and Electronic Equipment Regulations 2012

Standards

BS EN 301 489-1

BS EN 301 489-17

BS EN 300 328

BS EN 62368-1

BS EN IEC 63000



Restrictions: This product is for use only with nominal voltage in each country.

Federal Communications Commission (FCC) compliance statement

NOTE: This equipment has been tested and found to comply with the limits for a Class A digital device, pursuant to part 15 of the FCC Rules. These limits are designed to provide reasonable protection against harmful interference when the equipment is operated in a commercial environment. This equipment generates uses and can radiate radio frequency energy and, if not installed and used in accordance with the instruction manual, may cause harmful interference to radio communications. Operation of this equipment in a residential area is likely to cause harmful interference in which case the user will be required to correct the interference at his own expense.

The changes or modifications not expressly approved by the party responsible for compliance could void the user's authority to operate the device.

Industry Canada (IC) compliance statement

This device complies with Industry Canada's licence-exempt RSSs. Operation is subject to the following two conditions:

- (1) This device may not cause interference; and
- (2) This device must accept any interference, including interference that may cause undesired operation of the device.

RF exposure compliance

This transmitter must not be co-located or operating in conjunction with any other antenna or transmitter.

Contains FCC ID: SQK-MBH7BTZXXC2

Contains IC: 337L-MBH7BTZXXC2

1. INTRODUCTION

This manual describes how to handle the thermal printer MP-B20 (hereinafter referred to as the printer), cradle CDL-B01K-1 (optional accessory; hereinafter referred to as the cradle), battery pack BP-B0326-A1 (installed in the printer at the factory shipment; hereinafter referred to as the battery pack), and battery pack BP-B0326-B1 (optional accessory; hereinafter referred to as the battery pack).

Read through "2. SAFETY PRECAUTIONS" and "3. OPERATING PRECAUTIONS" carefully before using the products, and handle them safely and properly.

Keep this manual in a place where it can be accessed quickly.



See "MP-B20 SERIES THERMAL PRINTER TECHNICAL REFERENCE" for more detailed function and specifications on the printer.

This manual consists of the following sections.

1. INTRODUCTION	1
2. SAFETY PRECAUTIONS.....	2
3. OPERATING PRECAUTIONS.....	6
4. PREPARATION.....	9
5. IDENTIFYING MODEL TYPE.....	11
6. EACH PART OF PRINTER.....	12
7. LED DISPLAY OF PRINTER.....	14
8. CHARGING BATTERY PACK	17
9. THERMAL PAPER SETTING.....	22
10. TEST PRINT	26
11. FUNCTION SETTINGS	28
12. CONNECTING TO HOST DEVICE	31
13. ATTACHING/DETACHING BELT CLIP	33
14. ATTACHING CRADLE	34
15. REPLACING BATTERY PACK.....	36
16. PRINTER MAINTENANCE.....	38
17. TROUBLESHOOTING	39
18. SPECIFICATIONS	40
19. ACCESSORIES AND CONSUMABLE PARTS	42
20. MS SETTINGS LIST.....	43

2. SAFETY PRECAUTIONS

In this SAFETY PRECAUTIONS, the following symbols are used to ensure safe and proper use of products and prevent from damaging devices.

 WARNING	Failure to follow the instructions marked with this symbol could result in severe personal injury or death.
 CAUTION	Failure to follow the instructions marked with this symbol could result in minor personal injury or property damage.

■ About symbols



The symbol indicates information which you should pay attention to (including danger and warnings).



The symbol indicates information about prohibited procedures.



indicates "Disassembly is prohibited."



The symbol indicates information about obligated or instructed procedures.

















indicates "Unplug the USB cable from the printer."

OPERATING PRECAUTIONS





The "products" shall collectively mean the printer, the cradle, the battery pack and the USB cable.

WARNING



Never attempt the followings. Failure to follow the instructions leads to fire, electric shock, or accident.	
	DO NOT disassemble or reconstruct the products.
	Take care not to spill liquid on the products.
	DO NOT touch the products with wet hands.
	DO NOT insert any foreign objects such as a piece of metal or any liquid into the products.
	Keep the terminals of the products away from dust and metal objects.
	DO NOT touch the terminals of the products. To avoid short circuits, prevent terminals of the products from touching any conductor such as metal.
	Use the printer only with the specified battery pack. If use battery packs other than our specified product, it may cause leakage, overheating, explosion or fire.
	Be sure to charge the battery pack under the specified temperature range. Otherwise, it may cause leakage, overheating, explosion or fire.
	DO NOT expose the printer in a fire and heat it.
	DO NOT leave the printer under high temperature conditions such as in scorching heat, inside a car, or near a fire. It may cause leakage, overheating, explosion or fire.
	DO NOT apply strong impact to the printer with a hammer or a nail, and DO NOT crush it.
	DO NOT print out during a vehicle driving. Ejected thermal paper may hinder a vehicle driving.

Be sure to observe the following instructions. Failure to follow the instructions may lead fire, electric shock, or accident.	
	Be sure to use only in countries where the products meet the regulations. Using non-compliant products may endanger the safety of products or be considered against regulations.
	Make sure to turn off the printer when installing/removing the battery pack.



Procedures to take when in trouble





Follow the instructions in the following cases. Failure to follow the instructions may lead fire, electric shock, or accident.	
	<p>Turn off the printer, and unplug the USB cable from the printer in any of the following cases. And then, remove the battery pack from the printer.</p> <ul style="list-style-type: none"> ◆ Abnormal status continues. ◆ The products are giving off an unusual smell, smoke, excessive heat or unusual noise. ◆ A piece of metal, water or other foreign objects get into the products. ◆ The case is broken.
	DO NOT use a damaged USB cable.
	<p>In any of the following cases, remove the battery pack from the printer. Then, stop using the battery pack and never put it close to fire.</p> <ul style="list-style-type: none"> ◆ The battery pack is giving off an unusual smell, smoke or excessive heat. ◆ The case is broken. ◆ Liquid is leaking.
	When leaking liquid from battery pack gets into eyes, flush them immediately with clean water and see a doctor immediately. Otherwise it may cause vision loss.
	When leaking liquid from battery pack contacts your skin or clothing, flush them immediately with clean water.

For wireless communication

Observe the following instructions.	
	Always turn off the printer in areas or regions where its use is prohibited, such as on the airplane.
	The printer may affect medical or other electronic devices. Obtain information and data concerning influence due to radio interference from the respective manufacturers or dealers.

CAUTION

Observe the following instructions. Failure to follow the instructions may lead fire, electric shock, or accident.	
	Turn off the products when not in use for a long time or before maintenance.
	<p>DO NOT use or store the products in the following locations:</p> <ul style="list-style-type: none"> ◆ Locations exposed to direct sunlight or high temperature such as in a car. ◆ Locations exposed to high humidity, a lot of dust, and liquid. ◆ Locations subject to strong vibration or unstable locations.
	DO NOT cover the products with a cloth when in use.

	NEVER touch the thermal head immediately after printing because it may get hot. Be sure to allow it to cool down before clearing a paper jam or cleaning its head.
	The printer has 2 paper cutters on the paper outlet: one is on the printer side, and the other is on the paper cover side. DO NOT touch the cutters directly with hands. Especially, make sure not to touch the exposed cutters while the printer cover is open.
	Keep loose objects such as long hair away from the printer while the printer operates. When they fall into the printer, it may cause personal injury or damage the printer.
	To prevent the battery pack from dropping off, be sure to install and fix the battery pack securely to the printer. Dropped battery pack may cause personal injury or malfunction.
	Keep the products away from infants and children.

3. OPERATING PRECAUTIONS

Be careful of the following precautions and use the products properly in order to deliver and maintain the full performance of the products.

■ Using Products

Precautions for using conditions

- ◆ Be careful not to drop or bump the products on a hard surface.
- ◆ DO NOT install the products in direct sunlight.
- ◆ Be careful about the ambient temperature and humidity.
Suitable environment for the use of the printer is as follows:

	Range of the temperature	Range of the humidity
Printing	-10°C to 50°C (14°F to 122°F)	30%RH to 85%RH (Non condensing)
Charging	0°C to 40°C (32°F to 104°F)	30%RH to 75%RH (Non condensing)

See "MP-B20 SERIES THERMAL PRINTER TECHNICAL REFERENCE" for the certifiable humidity range at each temperature.

- ◆ DO NOT install the products near devices that generate strong electromagnetic fields such as a copy machine motor.
- ◆ DO NOT install the products in a location that is subject to corrosive gas, siloxane and so on.

Precautions when using or driving

- ◆ DO NOT print without the thermal paper.
- ◆ DO NOT use thermal papers taped together.
- ◆ NEVER pull out the thermal paper when the thermal paper is set.
- ◆ DO NOT open the paper cover during printing.
- ◆ DO NOT touch the thermal paper during printing. Covering the paper outlet or pulling out the thermal paper when ejecting may cause a paper jam or line feed failure.
- ◆ DO NOT connect or disconnect the USB cable during printing or transmission.
DO NOT touch the USB cable plug during printing.
- ◆ When handling the printer, be aware of static electricity. When the static electricity is discharged, this could cause a USB interface failure.
When this problem occurs, disconnect the USB cable plug that is connected to the printer from the host device, and wait a few seconds before connecting it again.
- ◆ DO NOT use the thermal head when it is wet. Doing so may damage the printer.
- ◆ Using the printer under low temperature environment or printing at a high print rate might cause unclear printing or generate loud sound. This is not a failure in the printer but an inherent paper phenomenon.
- ◆ Continuous printing with high print rate might cause temporarily stop printing by temperature detection of the printer. Printing resumes when the printer's temperature cools down. When this error occurs and "Data discarding when error occurs" in the Function Settings is "Enabled", the transmitted print data while this error occurs is discarded.

- ◆ When the battery pack is used at low temperature, the operating time of the printer can be used may be shortened.
- ◆ The indicator of battery remaining capacity displayed in the POWER LED is for reference. The battery level may be changed depending on the printer operation, so charge the battery pack before the battery becomes low.
- ◆ The battery pack should be charged at 0°C to 40°C (32°F to 104°F).
- ◆ The charging time depends on the ambient temperature and the voltage level of the battery pack.
- ◆ The battery pack may get hot when in use. This is normal and not a malfunction.
- ◆ Be sure to fix the printer to the cradle when using the printer as a stand-alone type.
- ◆ Always use the specified thermal paper. See "19. ACCESSORIES AND CONSUMABLE PARTS" for details.
- ◆ DO NOT touch the thermal head directly. Doing so may result in poor printing quality due to the dirt or damage by the static electricity.
- ◆ NEVER touch the thermal head, paper sensor, or platen roller directly while opening the paper cover to install the thermal paper. Doing so may cause injury or other accidents.
- ◆ The printer has 2 paper cutters on the paper outlet: one is on the printer side, and the other is on the paper cover side.
DO NOT touch the cutters directly with hands. Especially, make sure not to touch the exposed cutters while the printer cover is open.
- ◆ Be careful not to get your fingers or hands caught in the printer when opening or closing the paper cover.
- ◆ DO NOT drop or insert any foreign objects such as clips, pins, and screws into the internal parts or slot of the products.
- ◆ DO NOT drop any liquid or spray a solvent to the products.
- ◆ NEVER use sharp object such as pen tip to push the switch on the operation panel.
- ◆ Make sure not to injure your body or other objects by the plate edge.
- ◆ When something goes wrong with the printer during use, stop using it immediately, and remove the battery pack.
- ◆ NEVER disassemble the printer without a serviceman.

Precautions for Wireless communication

- ◆ When using the Bluetooth interface, the communication may become unstable due to the influence from any external radio waves. This is the specification of Bluetooth for wireless communication standard.
- ◆ The Bluetooth interface uses 2.4GHz frequency range. So if these models are used around any equipment with the same frequency range such as wireless equipment and microwave oven, radio frequency interference may occur, and the communication may become unstable. When it happens, turn off the interfering equipment or increase the distance. In addition, shorten the distance between the host device and the printer as much as possible.

Precautions for maintenance

- ◆ Clean the products' cases using a soft and lint-free cloth. DO NOT use alcohol or other solvent.
- ◆ Before using, always clean the terminals using a dry, soft, and lint-free cloth. When the terminals are dirty, it may cause contact failure.
- ◆ When cleaning the thermal head, wipe the thermal head with a cotton swab or other soft material.

Precautions for storing

- ◆ Turn off the printer when not in use.
In addition, when the printer is not used for a long time,
 - Set thermal paper to protect the platen.
 - Avoid storing the printer for a long time with fully charged condition as much as possible because it may shorten the life span of the battery pack.

■ Thermal Paper Handling

- ◆ Store the thermal paper in a cool, dry, and dark place.
- ◆ DO NOT rub the thermal paper with hard objects.
- ◆ DO NOT leave the thermal paper near organic solvents.
- ◆ DO NOT allow plastic film, erasers, or adhesive tape to touch the thermal paper for long periods.
- ◆ DO NOT stack the thermal paper with diazo copies immediately after copying.
- ◆ DO NOT use chemical glue.

■ Precautions on Discarding

When discarding used products, discard them according to the disposal regulations and rules of each respective district.

■ Notations

The following 2 types of notations are used throughout this manual to denote the operating precautions and items to remember besides the symbols shown in "2. SAFETY PRECAUTIONS":

NOTE
◆ Operating Precautions

This box contains items that may lead to a malfunction or deterioration of performance when not followed.

HINT
• Items to Remember

This box contains helpful hints to remember when using the products.

4. PREPARATION

Make sure that the printer and its accessories are contained.
Keep the package and packing materials for future transportation or long-term storage.



**Printer
(Battery pack installed)**

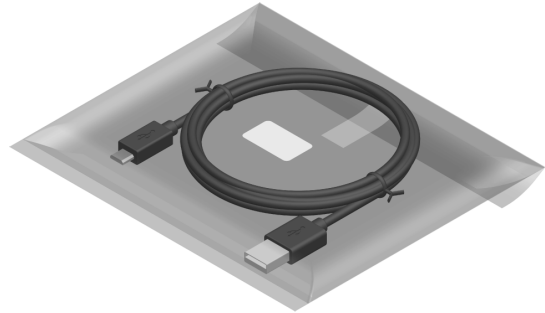

USB Cable

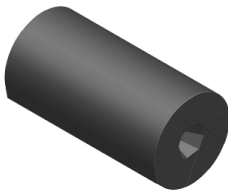

Sample thermal paper



Quick Start Guide



**Safety Precautions: 1 set
(3 sheets)**

The available accessories are shown below.

See "18. SPECIFICATION" and "19. ACCESSORIES AND CONSUMABLE PARTS", and be sure to purchase our specified products listed on these references.

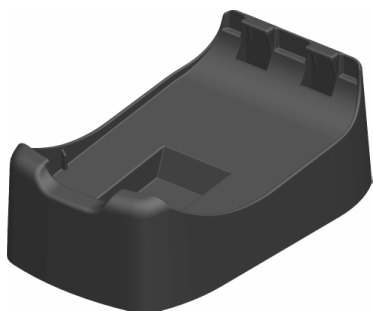

Cradle

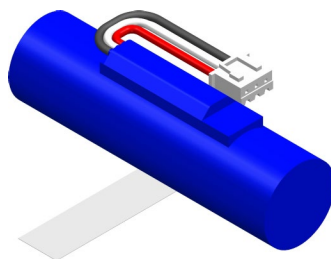

Battery Pack*1

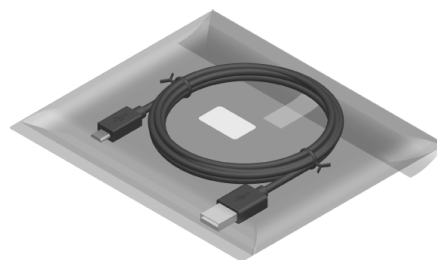

USB Cable*2

*1: It is installed in the printer at the factory shipment.

*2: It is included with the printer at the factory shipment.

5. IDENTIFYING MODEL TYPE

The printer model is identified as follows:

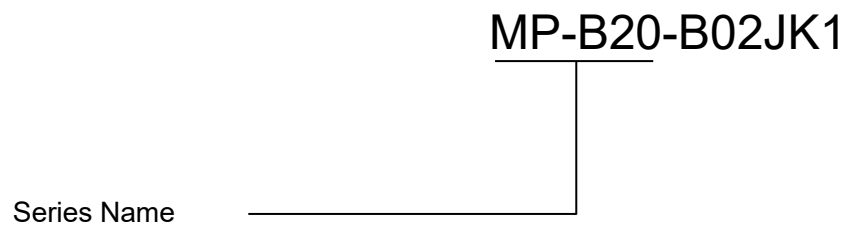

6. EACH PART OF PRINTER

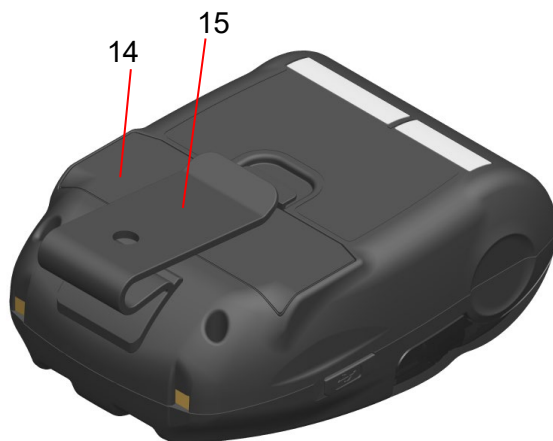
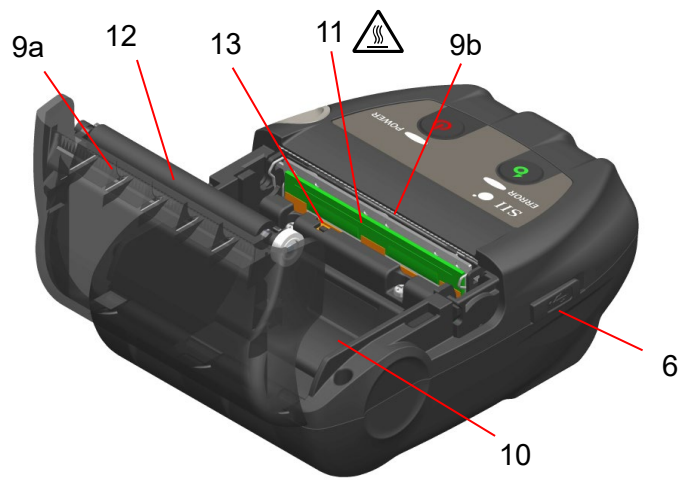
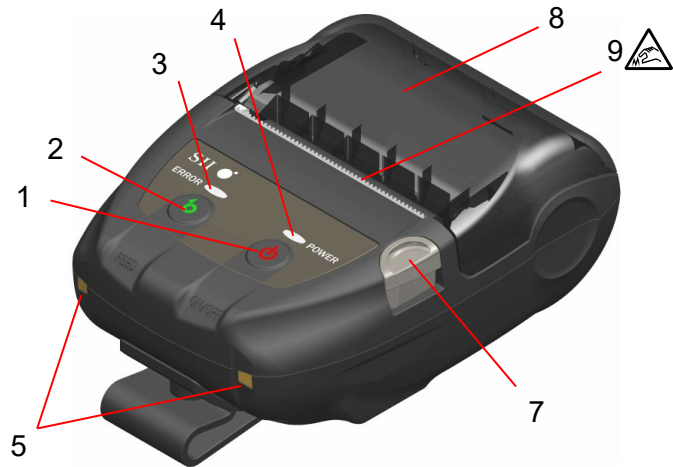

Each Part of Printer

1 POWER Switch

The POWER Switch turns the power on or off. The POWER LED lights when turning on the power. To turn off the power, hold down the switch for longer than 1 second.

2 FEED Switch

The FEED Switch operates paper feed. When holding down the switch for a few seconds, the printer feeds the thermal paper continuously for the period of held.

3 ERROR LED

The ERROR LED lights when something is wrong with the printer. For more details, see "7. LED DISPLAY OF PRINTER".

4 POWER LED

The POWER LED lights when turning on the power. For more details, see "7 LED DISPLAY OF PRINTER".

5 Charging terminal

The terminal is for charging the battery pack by using the optional cradle. DO NOT touch this charging terminal.

6 USB connector

This connector is for charging without the cradle, or using USB interface.

7 Paper cover open button

The button is for opening the paper cover.

8 Paper cover

The platen is released from the thermal paper when opening this cover. Open this cover when replacing the thermal paper or cleaning the thermal head.

9 Paper outlet

Thermal paper is ejected from here. Two paper cutters are installed: one is on the printer side, and the other is on the paper cover side (9a, 9b). Be careful not to touch these paper cutters.

10 Paper holder

The paper holder holds the thermal paper.

11 Thermal head

The thermal head prints data on the thermal paper. NEVER touch the thermal head with hands immediately after printing because it may get hot.

12 Platen

The platen brings the thermal paper into contact with the thermal head. The platen is turned to feed the paper.

13 Paper sensor

The sensor detects thermal paper presence.

14 Battery cover

Open this cover when replacing the battery pack. For more details, see "15. REPLACING BATTERY PACK".

15 Belt clip

The belt clip is used for hooking to your belt to carry the printer.

7. LED DISPLAY OF PRINTER

■ LED Display of Printer

The ERROR LED and the POWER LED show the printer status.

Table 7-1 Printer Status

Description	Printer Status		ERROR LED		POWER LED	
			Color	Lighting Pattern	Color	Lighting Pattern
Power status	Power off		-	Off	-	Off
	Power on	Battery remaining capacity: Full	Display "Error status"		Green	On
		Battery remaining capacity: Middle			Green	Blink-6
		Battery remaining capacity: Low			Orange	Blink-6
		Voltage error			Orange	Blink-3
		Battery temperature error			Orange	Blink-4
		Charging battery temperature error			Orange	Blink-5
		Charging			Orange	On
Error status	Output buffer full				Orange	Blink-6
	Out-of-paper error		Orange	Blink-1		
	Head temperature error		Orange	Blink-2		
	Hardware error		-	Off	Red	Blink-4
	Battery hardware error		-	Off	Red	Blink-5
Operating mode	Initializing		Orange	On	Green	On
	Rewriting FLASH memory ^{*1}		-	Off	Green	Blink-2
	Rewriting firmware ^{*2}		-	Off	Green/Orange	Blink-5
	In function setting mode		Orange	On	Orange	On
	In pairing mode ^{*3}		-	Off	Green	Blink-5

*1: Since the printer is rewriting the FLASH memory, do not turn it off while this mode is displayed.

*2: Since the printer is rewriting the firmware, do not turn it off while this mode is displayed.

*3: Only when the Inquiry Response in the Function Settings is set to Pairing Mode.

Table 7-2 Blink Pattern

Status	Pattern
Blink-1	
Blink-2	
Blink-3	
Blink-4	
Blink-5	
Blink-6	

Table 7-3 Guide of Battery Remaining Capacity

Battery Status	Battery Remaining Capacity
Battery remaining capacity level: Full	Approx. 80%
Battery remaining capacity level: Middle	Approx. 40%
Battery remaining capacity level: Low*	Approx. 10%

*: Charge the battery as soon as possible. Or printing may be stopped depending on print contents.

HINT

- The indicator of battery remaining capacity displayed in the POWER LED is for reference. The battery level may be significantly changed depending on the printer operation, so charge the battery pack before the battery becomes low.

■ Error and Recovery Procedure

When an error occurs, the printer stops printing operation. However, the data receiving is enabled. The table below lists errors and their recovery procedures.

Table 7-4 Error and Recovery Procedure

Error	Detail	Recovery Procedure	Priority*	
			ERROR	POWER
Output buffer full	Output buffer of the printer is full.	Read response data from the host device.	1	-
Out-of-paper error	No thermal paper.	Open the paper cover, set thermal paper, and then close the paper cover.	2	-
Head temperature error	The thermal head temperature is out of the operating temperature range.	The printer automatically recovers when thermal head temperature is within the operating temperature range. Wait for a while in the place where the ambient temperature is -10°C to 50°C (14°F to 122°F).	3	-
Voltage error	The battery pack voltage is out of the allowable range.	Charge the battery pack.	-	1
Charging battery temperature error	The printer suspends charging because the battery pack temperature is out of operating temperature range (charging).	The printer automatically resumes charging when the battery pack temperature is within the operating temperature range (charging). Wait for a while in the place where the ambient temperature is 0°C to 40°C (32°F to 104°F).	-	2
Battery temperature error	The battery pack temperature is out of the operating temperature range (printing).	The printer automatically recovers when the battery pack temperature is within the operating temperature range (printing). Wait for a while in the place where the ambient temperature is -10°C to 50°C (14°F to 122°F).	-	3
Hardware error	An abnormality occurs in the thermal head or the circuit board	Recovery is not possible. Request for repair.	4	4
Battery hardware error	There is an abnormality in the battery pack	Remove the battery pack from the printer and install it again. If the problem is unsolved, replace the battery pack.	5	5

*: This indicates the priority when multiple errors occur simultaneously. The bigger number indicates higher priority. For example, when "Output buffer full" and "Out-of-paper" occur simultaneously, the ERROR LED displays "Out-of-paper" based on the priority.

8. CHARGING BATTERY PACK

The battery pack can be charged using the printer or the cradle.

When a battery remaining capacity falls down the battery level: Middle or less, recharging starts automatically.

This battery pack does not need to be used up or discharged before charging.

For the battery remaining capacity and the error status, see "7. LED DISPLAY OF PRINTER".

■ Charging by Printer

By connecting the USB cable to the printer, the battery pack installed in the printer can be charged.

1. Open the cover of the USB connector on the printer, and connect the USB cable plug to the USB connector as shown in Figure 8-1.



Figure 8-1 Printer and USB Cable Connection

2. Connect the other USB cable plug to the USB port of your PC or USB battery charger.
3. The printer is automatically turned on when the printer is off.
After the POWER LED displays the battery remaining capacity for approximate 3 seconds, the POWER LED changes to orange, and then charging starts.
During charging, the POWER LED lights in orange.
4. When charging is successfully complete to full charge, the printer goes into one of the following statuses.
 - When the printer is off at the start of charging:
The printer is automatically turned off.
 - When the printer is on at the start of charging, or the printer is operated during charging:
The POWER LED changes to green.
 - When an error occurs during charging:
The LED displays that error status.

NOTE

- ◆ DO NOT remove the battery pack during charging.
- ◆ The battery pack should be charged at 0°C to 40°C (32°F to 104°F).

HINT

- The printer can print or receive data while charging.
During printing, the POWER LED displays the battery remaining capacity continuously and the printer pauses charging.
After printing is completed, the printer resumes charging, and the POWER LED changes to orange.
If the printer performs printing or receiving data during charging, the printer is not automatically turned off even when charging is completed.
- To stop charging, press the power switch to turn off the printer.
To resume charging, disconnect the USB cable from the printer and connect it again.
- The charging time depends on the ambient temperature and the voltage level of the battery pack.
- This product supports USB BC1.2 (USB Battery Charging Specification 1.2).
The time for charging the battery from empty to full is about 4.5 hours using USB BC1.2 enabled PC or USB battery charger, or about 8 hours using USB BC1.2 disabled PC.

■ Charging by Cradle

Using the cradle, the battery pack installed in the printer can be charged. See "14. ATTACHING CRADLE" for each part of the cradle.

1. Connect the USB cable plug to the USB connector of the cradle as shown in Figure 8-2.

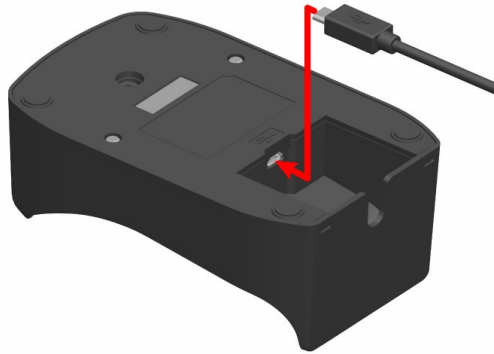

Figure 8-2 Cradle and USB Cable Connection

2. Connect the other USB cable plug to the USB port of your PC or your USB battery charger.
3. Set the printer in the cradle by aligning the charging terminal of the printer with the charging terminal of the cradle as shown in Figure 8-3.

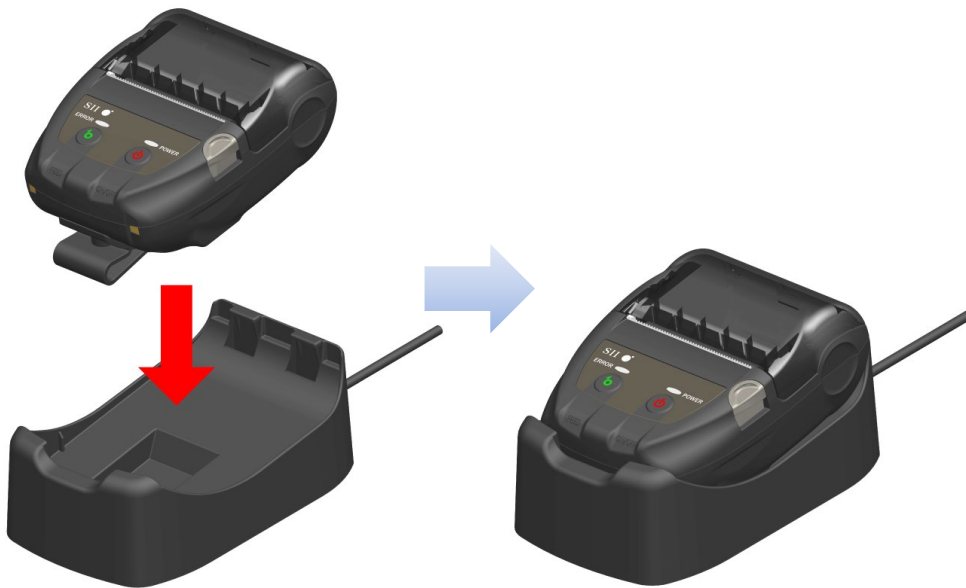

Figure 8-3 Printer and Cradle Connection

4. The printer is automatically turned on when the printer is off. After the POWER LED displays the battery remaining capacity for approximate 3 seconds, the POWER LED changes to orange, and then charging starts. During charging, the POWER LED lights in orange.

5. When charging is successfully complete to full charge, the printer goes into one of the following statuses.
- When the printer is off at the start of charging:
The printer is automatically turned off.
 - When the printer is on at the start of charging, or the printer is operated during charging:
The POWER LED changes to green.
 - When an error occurs during charging:
The LED displays that error status.

NOTE

- ◆ The battery pack should be charged at 0°C to 40°C (32°F to 104°F).
- ◆ Keep the terminal of the cradle away from dust and metal objects.
- ◆ When using the cradle for charging, DO NOT connect the USB cable to the USB connector of the printer.

HINT

- The printer can print or receive data while charging.
During printing, the POWER LED displays the battery remaining capacity continuously and the printer pauses charging.
After printing is completed, the printer resumes charging, and the POWER LED changes to orange.
If the printer performs printing or receiving data during charging, the printer is not automatically turned off even when charging is completed.
- To stop charging, press the power switch to turn off the printer.
To resume charging, set the printer in the cradle again.
- The charging time depends on the ambient temperature and the voltage level of the battery pack.
The time for charging the battery from empty to full is about 8 hours.

■ Error Handling Procedure

Table 8-1 Error Handling Procedure

Phenomenon	Possible Cause	Corrective Action
POWER LED doesn't light up	The USB cable is not connected.	Securely connect the USB cable to receive the power.
	The USB cable is broken.	Replace the USB cable with a new one.
POWER LED displays charging battery temperature error	The printer suspends charging because the battery pack temperature is out of the operating temperature range (charging).	The printer automatically resumes charging when the battery pack temperature is within the operating temperature range (charging). Wait for a while in the place where the ambient temperature is 0°C to 40°C (32°F to 104°F).
POWER LED displays battery hardware error	There is an abnormality in the battery pack.	Remove the battery pack from the printer and install it again. If the problem is unsolved, replace the battery pack.
POWER LED displays hardware error	An abnormality occurs in the thermal head or the circuit board.	Recovery is not possible. Request for repair.

9. THERMAL PAPER SETTING

The printer uses the thermal paper roll (hereinafter referred to as thermal paper).

Use the thermal paper with printing surface rolled outwards.

The function settings of the printer differ depending on the thermal paper. See "11. FUNCTION SETTINGS" for details.

■ Thermal Paper Setting

1. Press the paper cover open button in the direction of the arrow shown in Figure 9-1 and open the paper cover.



Figure 9-1 Paper cover open button

NOTE

- ◆ Press the paper cover open button to the end.
If not, the paper cover may not open.

2. Set the thermal paper into the paper holder with its printing surface facing to the thermal head. If the setting direction is wrong, the printer cannot print.



Figure 9-2 Thermal Paper Setting

NOTE

- ◆ The printer has 2 paper cutters on the paper outlet: one is on the printer side, and the other is on the paper cover side. Be careful not to cut your fingers by the paper cutters during setting the thermal paper.
- ◆ NEVER touch the thermal head immediately after printing because it may get hot.
- ◆ DO NOT touch the platen and gears in the printer. Doing so may cause loss of printing quality or damage.

3. Pull the thermal paper straightly until the tip of the thermal paper appears 5 cm or longer from the paper outlet.
Make sure that the thermal paper does not slant.



Figure 9-3 Thermal Paper Setting Direction Example

NOTE

- ◆ If the thermal paper is set into the paper holder at an angle, the thermal paper may not be ejected straightly. If so, set the thermal paper correctly.

4. Push firmly the center of the paper cover (the arrow in Figure 9-4) to close the paper cover.

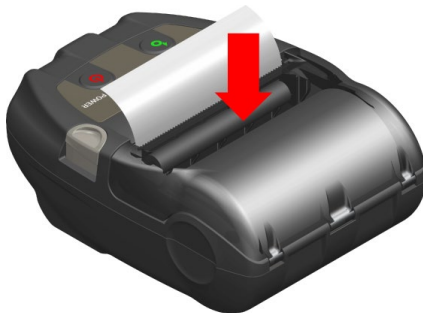

Figure 9-4 Paper Cover

NOTE

- ◆ When the paper cover is closed, the top of thermal paper may be colored because of the friction with a part of the printer. In that case, feed the thermal paper a few centimeters and cut the top of the thermal paper before starting printing.
- ◆ DO NOT cover the paper outlet or hold down the thermal paper ejected. Doing so may cause a paper jam.

HINT

- Leaving the printer with the thermal paper for a long time may cause a paper feeding problem because the surface of the thermal paper sticks to the thermal head due to the environmental changes. In that case, open the paper cover to separate the thermal paper from the thermal head, and then close the paper cover before use.

■ Thermal Paper Shape

Always use the specified thermal paper. See "19. ACCESSORIES AND CONSUMABLE PARTS" for details.

NOTE

- ◆ Use the thermal paper whose maximum diameter is 40 mm or less.
- ◆ Use the thermal paper whose maximum width is equal or less than each paper width +0.5 mm including winding deviation.
- ◆ DO NOT use the thermal paper with glued or taped end.
- ◆ Use the thermal paper whose core inside diameter is 8 mm or more.

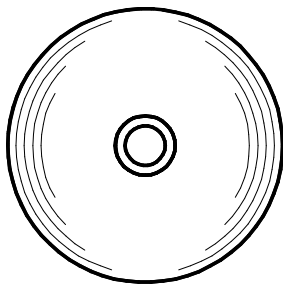

CORRECT

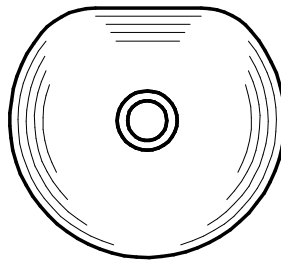

INCORRECT

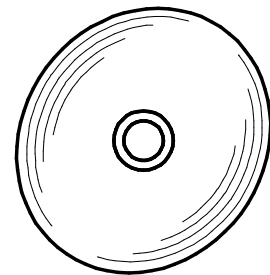

INCORRECT

NOTE

- ◆ DO NOT use deformed thermal paper. Doing so may cause the printer damaged.

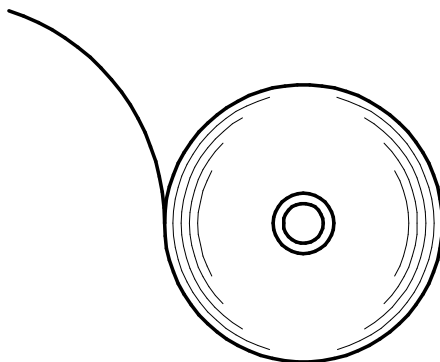

CORRECT

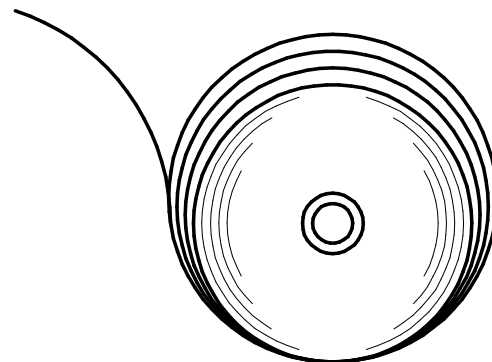

INCORRECT

NOTE

- ◆ In case of using loosened thermal paper roll, rewind the roll before using it.

10. TEST PRINT

The printer can perform a test print.

In the test print, the firmware version, setting values of the function settings, etc. are printed.

■ Test Print Procedure

1. Install the thermal paper in the printer as instructed in "9. THERMAL PAPER SETTING". Ensure that no error occurs, and then turn off the printer.
2. Press the POWER Switch while holding down the FEED Switch. Release the POWER Switch. When the test print is started, release the FEED Switch.

```

Thermal Printer
MP-B20 [ Ver X.XX.XX ]
  DD, MMM, YYYY
Copyright (C):SII

* MS1 *
1) Interface: Wireless

* MS3 *
1) Auto Status Back: Enable
2) Init. Response: Enable
3) Realtime Command: Enable
4) Error Through: Enable
5) Response Data Discarding:
  Disable
7) Kanji Code: JIS
8) Reverse Function: Disable

* MS4 *
* Print Density: 100[%]

* MS5 *
* Thermal Paper: TF50KS-EY

* MS7-8 *
* Auto Power Off Time:
  0[sec]

* USB Communication *
* USB Device Class: Printer

* Bluetooth Communication *
* Printer name:
  MP-B20
* Address: XX:XX:XX:XX:XX:XX
* iOS Auto Connection: Enable
* Security Mode: SSP
* Inquiry Response:Pairing Mode
* AssocModel:Just Works

* Font Information *
JIS X 0208-1997 Font Exist
* Gaiji Font: Enable
* Download Font: Enable
* Character Code Table:
  Code Page 437
* International Character:
  USA

* Serial Number Information *
XXXXXXXXXX

████████████████████
  
```

Figure 10-1 Test Print Sample

```

* Bluetooth Communication *
* Printer Name:
  MP-B20
* Address: XX:XX:XX:XX:XX:XX
* iOS Auto Connection: Enable
* Security Mode: SSP
* Inquiry Response: Pairing Mode
* AssocModel:Just Works
  
```

Figure 10-2 Bluetooth Information Printing Sample

Table 10-1 Bluetooth Interface Information

Item	Description
Printer Name	Bluetooth Device Name
Address	Bluetooth Address
iOS Auto Connection	Selected iOS Auto Connection
Security Mode	Selected Security Mode
Inquiry Response	Selected Searching Mode
AssocModel	Selected Association Model

3. After the test print, the mode selection message is printed as shown in Figure 10-3. To return to the print-ready status, select "0 : Normal Mode". (Press the POWER Switch without pressing the FEED Switch.)
To select other modes, press the FEED Switch the number of times corresponding to the selected mode number, and then press the POWER Switch.

```
[Mode Select]
0 : Normal Mode
1 : Setting Mode
2 : Change Communication I/F
3 : Hex Dump Mode

Press the FEED switch an equal
number of times to the selected
number. After that, press the
POWER switch.
```

Figure 10-3 Mode Selection Message

11. FUNCTION SETTINGS

This printer can set various functions according to use conditions and intended use. The setting contents are stored in the Memory Switch (hereinafter referred to as MS) in the FLASH memory mounted in the printer, and it is possible to set MS by using the switches, software, or command input.

This section describes the setting procedure by using the switches.

See "20. MS SETTINGS LIST" for the MS setting list.

NOTE

- ◆ Be sure to set the value as instructed when "Fixed" is stated for 0 or 1 in the table. Otherwise, the printer may not work correctly or may crash.

HINT

- When neither switch is pressed within 30 seconds after the message is printed, the printer exits the Setting Mode and returns to the print-ready status.
- The memory switch can also be set from software. Download software from the download page listed on the rear cover.
The following software can be set.
 - For Windows:
"Memory Switch" in the "Tool" that can be started from the property in the printer driver.
 - For iOS and Android:
App "SII Printer Utility" provided by App Store or Google Play.

■ Procedure for Setting Functions Using Switches

To set the functions using the switches, set the printer in the Setting Mode.

To enter the Setting Mode, follow the procedure below.

1. Install the thermal paper in the printer as instructed in "9. THERMAL PAPER SETTING". Ensure that no error occurs, and then turn off the printer. See "7. LED DISPLAY OF PRINTER" for the error status.
2. Press the POWER Switch while holding down the FEED Switch. Release the POWER Switch. When the test print is started, release the FEED Switch.
3. After the test print, the mode selection message is printed as shown in Figure 11-1. To enter the Setting Mode, select "1 : Setting Mode". (Press the FEED Switch once, and then press the POWER Switch.)

```
[Mode Select]
0 : Normal Mode
1 : Setting Mode
2 : Change Communication I/F
3 : Hex Dump Mode

Press the FEED switch an equal
number of times to the selected
number. After that, press the
POWER switch.
```

- When pressing the FEED Switch once, "1 : Setting Mode" is selected.
- When pressing the POWER Switch without pressing the FEED Switch, "0: Normal Mode" is selected.

Figure 11-1 Mode Selection Message

4. When the printer enters the Setting Mode, a message for selecting MS to be set is printed as shown in Figure 11-2.
Press the FEED Switch the number of times corresponding to the selected MS number, and then press the POWER Switch.

```
[MS Selection]
0 : Exit
1 : MS1 Setting
2 : MS3 Setting
3 : MS4 Setting
4 : MS5 Setting
5 : MS7,8 Setting
6 : Wireless Setting
7 : USB Setting
8 : International Character
9 : Character Code Table
10: MS Default Setting

Press the FEED switch an equal
number of times to the selected
number. After that, press the
POWER switch.
```

- When pressing the FEED Switch once, "1 : MS1 Setting" is selected.
- When pressing the POWER Switch without pressing the FEED Switch, "0 : Exit" is selected.

Figure 11-2 MS Selection Message

5. A message for selecting the functions assigned to the selected MS is printed as a sample shown in Figure 11-3.
Press the FEED Switch the number of times corresponding to the selected function number, and then press the POWER Switch.

```
[MS1 Setting]
0 : Return to MS selection
1 : Interface

Press the FEED switch an equal
number of times to the selected
number. After that, press the
POWER switch.
```

- When pressing the FEED Switch once, "1 : Interface" is selected.
- When pressing the POWER Switch without pressing the FEED Switch, "0 : Return to MS Selection" is selected.

**Figure 11-3 Function Selection Message
(Example: Selected MS1 Setting)**

6. A message for selecting the setting value of the selected function is printed as a sample shown in Figure 11-4.
Press the FEED Switch the number of times corresponding to the selected setting value number, and then press the POWER Switch.

```
[Interface]
0 : Return to function selection
1 : USB
2 : Wireless

Press the FEED switch an equal
number of times to the selected
number. After that, press the
POWER switch.
```

· When pressing the FEED Switch twice, "2 : Wireless" is selected.

**Figure 11-4 Setting Value Selection Message
(Example: Selected Interface)**

7. A message for confirming the selected setting value is printed as a sample shown in Figure 11-5.

```
[Interface]
Set "Wireless" ?
Save : FEED Switch
Discard : POWER Switch
```

**Figure 11-5 Setting Value Confirmation Message
(Example: Selected Wireless)**

To save the setting value to the memory, press the FEED Switch. Figure 11-2 MS Selection Message is printed.

To discard the selected item, press the POWER Switch. Function Selection Message is printed as a sample shown in Figure 11-3. If select "0 : Return to MS Selection", function selection is not performed, and Figure 11-2 MS Selection Message is printed. (Press the POWER Switch without pressing the FEED Switch.)

To continue to set functions, return to 4.

8. To exit the Setting Mode, select "0 : Exit" in Figure 11-2 MS Selection Message. (Press the POWER Switch without pressing the FEED Switch.)
The test print and Figure 11-1 Mode Selection Message printing start again. Verify that the functions are properly set.

To return to the print-ready status, select "0 : Normal Mode" in Mode Selection Message. (Press the POWER Switch without pressing the FEED Switch.)

To set functions again, return to 3.

12. CONNECTING TO HOST DEVICE

The printer supports the USB interface and the Bluetooth interface.

The function settings of the printer differ depending on the interface to use. See "MP-B20 SERIES THERMAL PRINTER TECHNICAL REFERENCE" for details.

The communication speed may be decreased depending on processing by software or print contents.

The interface is required to be set to USB in places where emitting radio waves is prohibited.

To temporarily switch the interface, press the POWER Switch 3 times within 3 seconds while the printer is on.

■ USB Interface

1. Ensure that the power of the printer is off.
2. Open the cover of the USB connector on the printer, and connect the USB cable plug to the USB connector as shown in Figure 12-1.



Figure 12-1 Printer and USB Cable Connection

3. Turn on the printer, and send data from the host device to the printer.
4. Verify that the data is printed correctly.

NOTE

- ◆ When connecting the USB cable to the USB connector, push the plug to the end.
- ◆ When connecting or disconnecting the cable, hold the plug and never pull the cable.

■ Bluetooth Interface

1. Turn on the printer and pair it with the host device.
In the factory shipment state, the printer enters pairing mode for about 60 seconds by pushing the power switch for 7 seconds or more. When the pairing mode starts, the POWER LED blinks in green 5 times per second. During this time, pair the printer with the host device.
In the factory shipment state, pairing is conducted by SSP (Simple Secure Pairing). However, PIN code is used when the host device does not support SSP, or Security Mode in the Function Settings is set to PIN. The PIN code is "0000" at the shipping.
2. Conduct Bluetooth connection with the host device.
3. Check the communication status on the host device.
4. Send data from the host device, and verify that the data is printed correctly.



WARNING

- ◆ The printer may affect medical or other electronic devices. Obtain information and data concerning influence due to radio interference from the respective manufacturers or dealers.
- ◆ When using the printer in medical institutions, follow their guidelines.
- ◆ DO NOT use the printer in any area or district where its use is prohibited.

HINT

- The distance of communication is approximately 10 m. However, the distance may differ depending on the radio interference and environment.

13. ATTACHING/DETACHING BELT CLIP

The belt clip convenient for carrying the printer can be attached to this printer.

The belt clip is already attached to the printer at the factory shipment.

When using the printer as a stand-alone type, detach the belt clip, attach the spacer that is an attachment of the cradle, and fix the printer to the cradle. For more details, see "14. ATTACHING CRADLE".

■ Attaching/Detaching Belt clip

The belt clip is fixed to the printer with a screw (at 1 place).

To detach the belt clip, remove the screw from the printer.

To attach the belt clip, align the belt clip with the screw hole of the belt clip attaching part, and fix it with the screw.



Figure 13-1 Attaching/Detaching Belt Clip

14. ATTACHING CRADLE

The cradle for using the printer as a stand-alone type or using as the charging stand can be attached to this printer.

The cradle is an optional accessory. See "18. SPECIFICATIONS" and "19. ACCESSORIES AND CONSUMABLE PARTS", and be sure to purchase our specified products listed on these references.

NOTE

- ◆ Be sure to fix the printer to the cradle when using the printer as a stand-alone type. When using the cradle only as the charging stand of the printer, it is no need to fix the printer to the cradle with the screw.

■ Each Part of Cradle

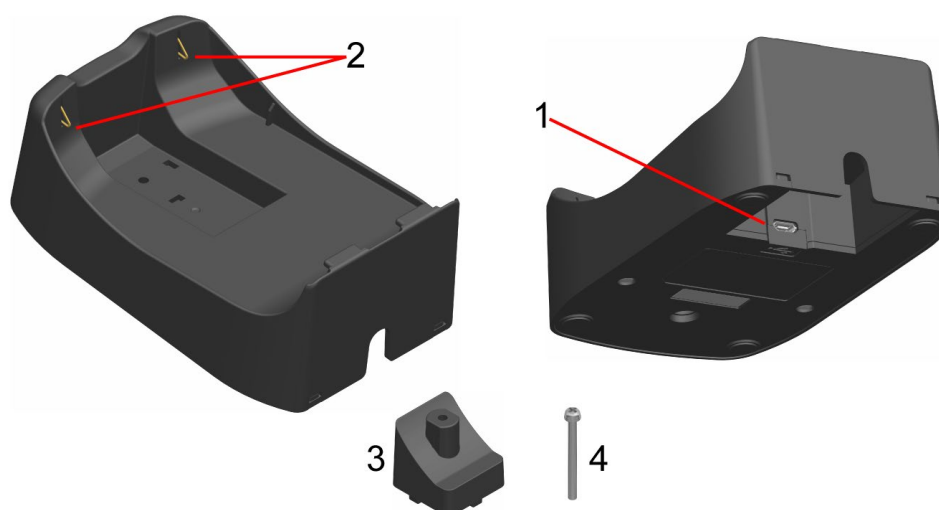

Figure 14-1 Each Part of Cradle (CDL-B01K-1)

1 USB connector

The USB cable is connected to here.

2 Charging terminal

When setting the printer, this charging terminal is connected to the charging terminal of the printer.

3 Spacer

The spacer is used for fixing the printer to the cradle with the screw when using the printer as a stand-alone type.

4 Screw

The screw is used for fixing the printer to the cradle with the spacer when using the printer as a stand-alone type.

■ Attaching Cradle

1. Turn over the printer, and remove the belt clip from the printer.
See "13. ATTACHING/DETACHING BELT CLIP" for removing the belt clip.
2. Align the spacer with the screw hole of the belt clip attaching part in the direction of the arrow 1 in Figure 14-2.
3. Turn over the cradle, set the cradle to the printer with the spacer attached in the direction of the arrow 2 in Figure 14-2.
4. Fix the cradle to the printer with the screw in the direction of the arrow 3 in Figure 14-2.

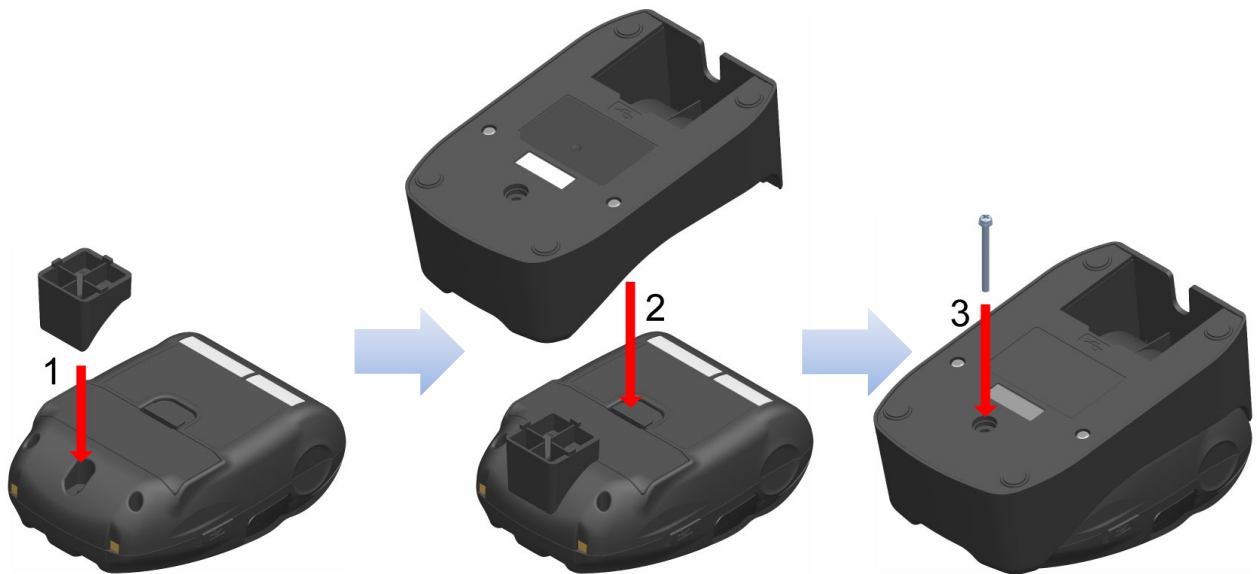

Figure 14-2 Attaching Cradle to Printer

15. REPLACING BATTERY PACK

The battery pack is already installed in the printer at the factory shipment, however, it needs to be replaced with a new one in case of battery failure or end of life.

The battery pack is an optional accessory. See "18. SPECIFICATIONS" and "19. ACCESSORIES AND CONSUMABLE PARTS", and be sure to purchase our specified products listed on these references.

■ Replacing Battery Pack

1. Ensure that the printer is off.
2. Turn over the printer, and remove the belt clip from the printer. See "13. ATTACHING/DETACHING BELT CLIP" for removing the belt clip.
3. As shown in Figure 15-1, pressing the lever "A" of the battery cover in the direction of the arrow 1, remove it by pulling up in the direction of the arrow 2.

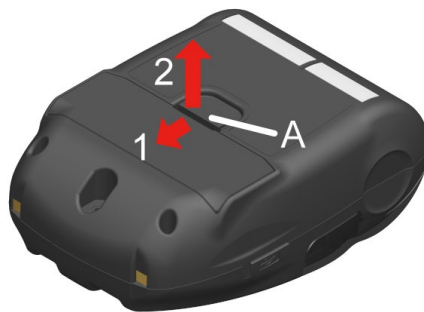

Figure 15-1 Removing Battery Pack (1)

4. Pull up the battery pack from the printer by holding the tab "b" of the battery pack.

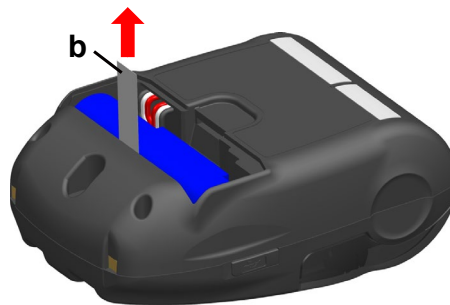

Figure 15-2 Removing Battery Pack (2)

5. Pull out the connector of the battery pack.

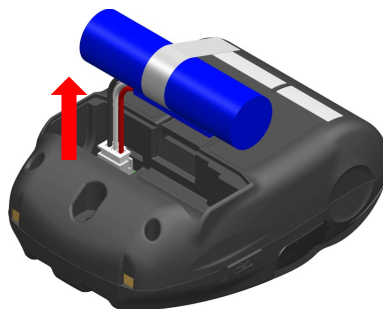

Figure 15-3 Removing Battery Pack (3)

6. Insert the connector of a battery pack to be installed.

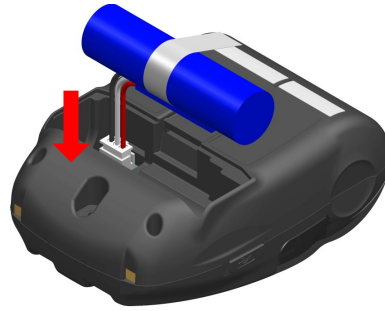

Figure 15-4 Installing Battery Pack (1)

7. Install the battery pack as shown in Figure 15-5. Place the projection "c" and the lead wire "d" of the battery pack into the recess "C" and the space "D" of the printer respectively. The battery cover can be closed only when the battery pack is properly placed.

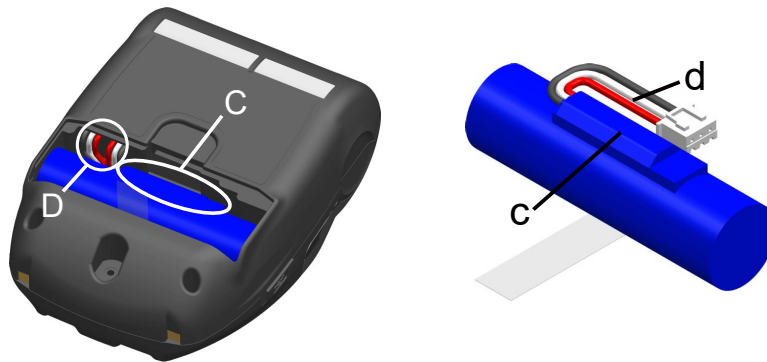

Figure 15-5 Installing Battery Pack (2)

8. Close the battery cover.

NOTE

- ◆ Make sure to turn off the printer when replacing the battery pack.
- ◆ If the battery pack is removed during saving the registration data by registration command or settings by function setting command, the data may be lost.
- ◆ See "2. SAFETY PRECAUTIONS" and "3. OPERATING PRECAUTIONS" for the precautions of the battery pack.

HINT

- The battery pack may get hot when in use. This is normal and not a malfunction.
- If the usable time of the battery pack has become shorter significantly, the battery is at the end of life. Please purchase a new battery pack.
- When the battery pack is used at low temperature, the usable operating time of the printer may be shortened.
- The battery may deteriorate even if not used.
- When Auto Power Off Setting is set to Enable, the printer is automatically turned off after not operated for the set time, and this can prevent the useless consumption of the battery. For details, see "11. FUNCTION SETTINGS".
- By twisting a full turn, the lead wire d is easier to fit in the space D.
- Dispose the used or unnecessary batteries according to local regulations.

16. PRINTER MAINTENANCE

The thermal head of the printer does not require user maintenance.

When paper powder accumulates, cleaning the thermal head can maintain the print quality for an extended period of time.

■ Cleaning Thermal Head / Platen

1. Turn off the printer.
2. Remove the battery pack from the printer.
3. Open the paper cover.
4. Clean the thermal head and/or the platen with a cotton swab moistened with a small amount of ethyl alcohol. (See Figure 16-1.)

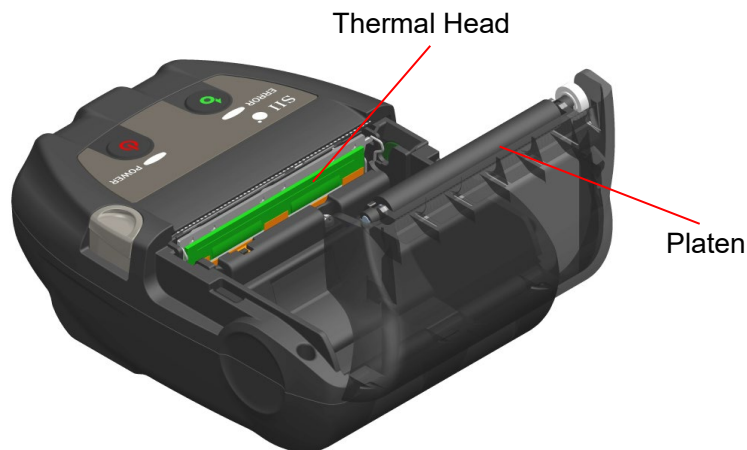

Figure 16-1 Cleaning Thermal Head / Platen

5. Wait until any ethyl alcohol remaining on the thermal head and the platen dries out completely, and then close the paper cover.

NOTE

- ◆ Clean the thermal head after it cools down.
- ◆ Be sure to wipe the thermal head with a cotton swab or other soft material.
- ◆ The printer has 2 paper cutters on the paper outlet: one is on the printer side, and the other is on the paper cover side. Be careful not to cut your fingers by the paper cutters during cleaning.
- ◆ DO NOT touch the gear of the platen. Doing so may cause loss of printing quality or damage.

17. TROUBLESHOOTING

Check the following points before requesting for repair:

■ The power does not turn on

- Is the specified battery pack being used?
- Is the battery pack sufficiently charged?
- Is the battery pack installed correctly?

■ The printer does not print or connect

- Is the USB cable connected correctly?
- Do the specifications of the USB cable conform to its specifications of this manual?
- Does the used interface conform to the printer?
- Is the Bluetooth communication status normal?
- Is the communication condition between the printer and the host device correct?
- Is the specified thermal paper being used? Is the paper orientation (surface/back) correct?

■ An error is displayed

- See "7. LED DISPLAY OF PRINTER".
- Are the function settings of the printer correct?

■ The battery pack cannot be installed

- Is the battery pack connected correctly?
- Is the specified battery pack being used?

■ The battery runs out soon even if charged

- Has the battery been charged correctly?
- If the battery pack is charged correctly but does not last for a long time, it is almost dead. Replace it with a new one.

18. SPECIFICATIONS

■ Printer Specifications

Item	Specifications
Model	MP-B20-B02JK1
Printing method	Thermal printing
Dot density	8 dots/mm
Paper width / Printing width (Number of effective dots)	58 mm / 48 mm (384 dots)
Number of characters per line*1	24 dots × 12 dots 32 digits 16 dots × 8 dots 48 digits
Character size (H × W)	1-byte: H 24 dots × W 12 dots, H 16 dots × W 8 dots 2-byte: H 24 dots × W 24 dots, H 16 dots × W 16 dots
Printing speed max.	80 mm/s
Operating temperature	-10°C to 50°C (14°F to 122°F)
Relative humidity*2	30%RH to 85%RH
Dimensions (W × D × H)	79 mm × 110 mm × 44 mm
Mass	Approx. 180 g (including battery pack, excluding belt clip and thermal paper)

*1: The number is for 1-byte character, and when character spacing is 0 dots.

*2: See "MP-B20 SERIES THERMAL PRINTER TECHNICAL REFERENCE" for the certifiable humidity range at each temperature.

■ Battery Pack Specifications

(Installed in Printer at Shipment)

Item	Specifications
Model	BP-B0326-A1
Battery	Lithium ion
Rated voltage	DC3.7 V
Rated capacity	2600 mAh
Operating temperature	-10°C to 50°C (14°F to 122°F) (printing) 0°C to 40°C (32°F to 104°F) (charging)
Mass	Approx. 49 g

(Specified Accessories)

Item	Specifications
Model	BP-B0326-B1
Battery	Lithium ion
Rated voltage	DC3.7 V
Rated capacity	2600 mAh
Operating temperature	-10°C to 50°C (14°F to 122°F) (printing) 0°C to 40°C (32°F to 104°F) (charging)
Mass	Approx. 49 g

■ Cradle Specifications

(Specified Accessories)

Item	Specifications
Model	CDL-B01K-1
Operating temperature	-10°C to 50°C (14°F to 122°F)
Relative humidity*	30%RH to 85%RH
Dimensions (W × D × H)	81 mm × 128 mm × 50 mm
Mass	Approx. 100 g

*: See "MP-B20 SERIES THERMAL PRINTER TECHNICAL REFERENCE" for the certifiable humidity range at each temperature.

■ USB Cable Specifications

(Specified Accessories)

Item	Specifications
Model	IFC-U03-1
Color	Black
Length	Approx. 1500 mm
Plug C1	Series "A" plug
Plug C2	Series "micro-B" plug

■ Interface Specifications

USB interface specifications

Item	Specifications
Version	Ver. 2.0
Printer data transmission mode	Bulk transfer (12 Mbps)

Bluetooth interface specifications

Item	Specifications
Version	Ver. 3.0
Transmission power class	Class 2
Profile	SPP, iAP2

■ Sale Destinations

Sale destinations of the printer and specified accessories are listed below.

Country/Region*	Printer	Cradle	Battery Pack
Japan	MP-B20-B02JK1	CDL-B01K-1	BP-B0326-B1
USA, Canada			
EU, EFTA, UK			
Turkey			

*: Ask your SII sales representative when you want to operate the products in countries/regions other than those listed above.

19. ACCESSORIES AND CONSUMABLE PARTS

■ Specified Accessories

Name	Model
Cradle	CDL-B01K-1
Battery Pack	BP-B0326-B1
USB Cable*	IFC-U03-1

*: It is included with the printer at the factory shipment.

■ Specified Thermal Paper*

Model	Manufacturer
TF50KS-E2D	Nippon Paper
TF50KS-EY	Nippon Paper
PD160R-63	Oji Paper
AF50KS-E	Jujo Thermal
KT55F20	Papierfabrik August Koehler
F5041	Mitsubishi HiTec Paper
KT48PF	Papierfabrik August Koehler

*: Use the thermal paper whose maximum diameter is 40 mm or less.

Use the thermal paper whose maximum width is equal or less than the each paper width +0.5 mm including winding deviation.

When using different thermal paper from the one specified, the printing quality or specified life of the thermal head would not be guaranteed.

20. MS SETTINGS LIST

 : Default value

General Setting 1

MS	Function	Value	
		0	1
1-1	Interface Selection (Interface)	USB	Wireless
1-2 to 8	Reserved	-	Fixed

General Setting 3

MS	Function	Value	
		0	1
3-1	Automatic Status Response Selection (Auto Status Back)	Enable	Disable
3-2	Initialized Response Selection (Init. Response)	Enable	Disable
3-3	Realtime Command Selection (Realtime Command)	Enable	Disable
3-4	Data Discard Selection When an Error Occurs (Error Through)	Enable	Disable
3-5	Data Discard Selection When Output Buffer Full Occurs (Response Data Discarding)	Enable	Disable
3-6	Reserved	-	Fixed
3-7	Kanji Code System Selection (Kanji Code)	Shift-JIS Code	JIS code
3-8	Reserved	-	Fixed

General Setting 4

MS	Function	Value	
		0	1
4-1 to 8	Print Density Selection (Print Density)	01000110B: 70% 01001011B: 75% 01010000B: 80% 01010101B: 85% 01011010B: 90% 01011111B: 95% 01100100B: 100% 01101001B: 105% 01101110B: 110% 01110011B: 115% 01111000B: 120% 01111101B: 125% 10000010B: 130%	

General Setting 5

MS	Function	Value	
		0	1
5-1 to 8	Thermal paper selection (Thermal Paper)	00000000B: TF50KS-E2D 00000001B: TF50KS-EY 00000011B: PD160R-63 00000101B: AF50KS-E 00000110B: KT55F20 00000111B: F5041 00001000B: KT48PF Other than those above: Prohibition	

Auto Power Off Time Setting

MS	Function	Value	
		0	1
7 to 8	Auto Power Off Time Setting (Auto Power Off Time) MS7 : Lower 8 bits MS8 : Higher 8 bits	Set in seconds Total of higher 8 bits and lower 8 bits: 0 or 60 to 65535 seconds (0: Disable)	

International Character Setting

MS	Function	Value	
		0	1
15	International Character Selection (International Character Select)	00000000B: USA 00000001B: France 00000010B: Germany 00000011B: United Kingdom 00000100B: Denmark I 00000101B: Sweden 00000110B: Italy 00000111B: Spain I 00001000B: Japan 00001001B: Norway 00001010B: Denmark II 00001011B: Spain II 00001100B: Latin America 00001101B: Prohibition 00001110B: Prohibition 00001111B: Prohibition 00010000B: Prohibition 00010001B: Arabia Other than those above: Prohibition	

Character Code Table Setting

MS	Function	Value	
		0	1
16	Character Code Table Setting (Character Code Table Select)	00000000B: USA, Standard Europe (Code Page 437) 00000001B: Katakana 00000010B: Multilingual (Code Page 850) 00000011B: Portuguese (Code Page 860) 00000100B: Canadian-French (Code Page 863) 00000101B: Nordic (Code Page 865) 00001101B: Turkish (Code Page 857) 00001110B: Greek (Code Page 737) 00001000B: Latin (Code Page 1252) 00001001B: Russian (Code Page 866) 00001010B: Eastern Europe (Code Page 852) 00001011B: Euro (Code Page 858) 00100010B: Cyrillic (Code Page 855) 00100101B: Arabic (Code Page 864) 00101101B: Central European (Code Page 1250) 00101110B: Cyrillic (Code Page 1251) 00101111B: Greek (Code Page 1253) 00110000B: Turkish (Code Page 1254) 11111111B: User Page Other than those above: Prohibition	



Seiko Instruments Inc.
1-8, Nakase, Mihama-ku, Chiba-shi,
Chiba 261-8507, Japan
Print System Division
Telephone:+81-43-211-1106
Facsimile:+81-43-211-8037

Seiko Instruments USA Inc.
Thermal Printer Div.
21221 S. Western Avenue, Suite 250, Torrance, CA 90501, USA
Telephone:+1-310-517-7778 Facsimile:+1-310-517-7779

Seiko Instruments GmbH (Economic operator)
Siemensstrasse 9, D-63263 Neu-Isenburg, Germany
Telephone:+49-6102-297-0 Facsimile:+49-6102-297-222
info@seiko-instruments.de

Seiko Instruments (H.K.) Ltd.
4-5/F, Wyler Center 2,200 Tai Lin Pai Road, Kwai Chung, N.T., Kowloon, Hong Kong
Telephone:+852-2494-5160 Facsimile:+852-2424-0901

Download page:<https://www.sii.co.jp/sps/eg/download/index.html>

(Specifications are subject to change without notice.)