

ViewSonic®



IFP5550/IFP6550 IFP7550/IFP8650 Commercial Touch Display User Guide

IMPORTANT: Please read this User Guide to obtain important information on installing and using your product in a safe manner, as well as registering your product for future service. Warranty information contained in this User Guide will describe your limited coverage from ViewSonic Corporation, which is also found on our web site at <http://www.viewsonic.com> in English, or in specific languages using the Regional selection box in the upper right corner of our website. "Antes de operar su equipo lea cuidadosamente las instrucciones en este manual"

Model No. VS17121/VS16954/VS16876/VS16874

Thank you for choosing ViewSonic

As a world leading provider of visual solutions, ViewSonic is dedicated to exceeding the world's expectations for technological evolution, innovation, and simplicity. At ViewSonic, we believe that our products have the potential to make a positive impact in the world, and we are confident that the ViewSonic product you have chosen will serve you well.

Once again, thank you for choosing ViewSonic !



Compliance Information

NOTE: This section addresses all connected requirements and statements regarding regulations. Confirmed corresponding applications shall refer to nameplate labels and relevant markings on unit.

FCC Compliance Statement

This device complies with part 15 of FCC Rules. Operation is subject to the following two conditions: (1) this device may not cause harmful interference, and (2) this device must accept any interference received, including interference that may cause undesired operation.

This equipment has been tested and found to comply with the limits for a Class B digital device, pursuant to part 15 of the FCC Rules. These limits are designed to provide reasonable protection against harmful interference in a residential installation. This equipment generates, uses, and can radiate radio frequency energy, and if not installed and used in accordance with the instructions, may cause harmful interference to radio communications. However, there is no guarantee that interference will not occur in a particular installation. If this equipment does cause harmful interference to radio or television reception, which can be determined by turning the equipment off and on, the user is encouraged to try to correct the interference by one or more of the following measures:

- Reorient or relocate the receiving antenna.
- Increase the separation between the equipment and receiver.
- Connect the equipment into an outlet on a circuit different from that to which the receiver is connected.
- Consult the dealer or an experienced radio/TV technician for help.

Warning: You are cautioned that changes or modifications not expressly approved by the party responsible for compliance could void your authority to operate the equipment.

Industry Canada Statement

CAN ICES-3 (B)/NMB-3(B)

Contains FCC ID: 2AFG6-RK3399

IC ID: 22166-RK3399

CE Conformity for European Countries

 The device complies with the EMC Directive 2014/30/EU and Low Voltage Directive 2014/35/EU.

Following information is only for EU-member states:

The mark shown to the right is in compliance with the Waste Electrical and Electronic Equipment Directive 2012/19/EU (WEEE). The mark indicates the requirement NOT to dispose the equipment as unsorted municipal waste, but use the return and collection systems according to local law.



Indian Restriction of Hazardous Substances

Restriction on Hazardous Substances statement (India) This product complies with the “India E-waste Rule 2011” and prohibits use of lead, mercury, hexavalent chromium, polybrominated biphenyls or polybrominated diphenyl ethers in concentrations exceeding 0.1 weight % and 0.01 weight % for cadmium, except for the exemptions set in Schedule 2 of the Rule.

Declaration of RoHS2 Compliance

This product has been designed and manufactured in compliance with Directive 2011/65/EU of the European Parliament and the Council on restriction of the use of certain hazardous substances in electrical and electronic equipment (RoHS2 Directive) and is deemed to comply with the maximum concentration values issued by the European Technical Adaptation Committee (TAC) as shown below:

Substance	Proposed Maximum Concentration	Actual Concentration
Lead (Pb)	0.1%	< 0.1%
Mercury (Hg)	0.1%	< 0.1%
Cadmium (Cd)	0.01%	< 0.01%
Hexavalent Chromium (Cr ⁶⁺)	0.1%	< 0.1%
Polybrominated biphenyls (PBB)	0.1%	< 0.1%
Polybrominated diphenyl ethers (PBDE)	0.1%	< 0.1%
Bis (2-ethylhexyl) phthalate (DEHP)	0.1%	< 0.1%
Butyl benzyl phthalate (BBP)	0.1%	< 0.1%
Dibutyl phthalate (DBP)	0.1%	< 0.1%
Diisobutyl phthalate (DIBP)	0.1%	< 0.1%

Certain components of products as stated above are exempted under the Annex III of the RoHS2 Directives as noted below:

Examples of exempted components are:

1. Mercury in cold cathode fluorescent lamps and external electrode fluorescent lamps (CCFL and EEFL) for special purposes not exceeding (per lamp):
 - (1) Short length (≤ 500 mm): maximum 3.5 mg per lamp.
 - (2) Medium length (> 500 mm and $\leq 1,500$ mm): maximum 5 mg per lamp.
 - (3) Long length ($> 1,500$ mm): maximum 13 mg per lamp.
2. Lead in glass of cathode ray tubes.
3. Lead in glass of fluorescent tubes not exceeding 0.2% by weight.
4. Lead as an alloying element in aluminium containing up to 0.4% lead by weight.
5. Copper alloy containing up to 4% lead by weight.

6. Lead in high melting temperature type solders (i.e. lead-based alloys containing 85% by weight or more lead).
7. Electrical and electronic components containing lead in a glass or ceramic other than dielectric ceramic in capacitors, e.g. piezoelectronic devices, or in a glass or ceramic matrix compound.

Cautions and Warnings

1. Read these instructions completely before using the equipment.
2. Keep these instructions in a safe place.
3. Heed all warnings and follow all instructions.
4. Always handle the LCD display with care when moving it.
5. Never remove the rear cover. This LCD display contains high-voltage parts. You may be seriously injured if you touch them.
6. Do not use this equipment near water. **Warning:** To reduce the risk of fire or electric shock, do not expose this apparatus to rain or moisture.
7. Avoid exposing the LCD display to direct sunlight or another heat source. Orient the LCD display away from direct sunlight to reduce glare.
8. Clean with a soft, dry cloth. If further cleaning is required, see the “Care and Maintenance” section in this guide for further instructions.
9. Do not block any ventilation openings. Install the equipment in accordance with the manufacturer’s instructions.
10. Do not install near any heat sources such as radiators, heat registers, stoves, or other devices (including amplifiers) that produce heat.
11. Place the LCD display in a well ventilated area. Do not place anything on the LCD display that prevents heat dissipation.
12. Do not place heavy objects on the LCD display, video cable, or power cord.
13. If smoke, an abnormal noise, or a strange odor is present, immediately switch the LCD display off and call your dealer or ViewSonic. It is dangerous to continue using the LCD display.
14. Do not attempt to circumvent the safety provisions of the polarized or grounding-type plug. A polarized plug has two blades with one wider than the other. A grounding type plug has two blades and a third grounding prong. The wide blade and the third prong are provided for your safety. If the plug does not fit into your outlet, consult an electrician for replacement of the outlet.
15. Protect the power cord from being tread upon or pinched, particularly at the plug, and the point where it emerges from the equipment. Be sure that the power outlet is located near the equipment so that it is easily accessible.

(Continued on next page)

16. Only use attachments/accessories specified by the manufacturer.

17. Use only with the cart, stand, tripod, bracket, or table specified by the manufacturer, or sold with the equipment. When a cart is used, use caution when moving the cart/equipment combination to avoid injury from tipping over.



18. Unplug this equipment when it will be unused for long periods of time.

19. Refer all servicing to qualified service personnel. Service is required when the unit has been damaged in any way, such as: if the power-supply cord or plug is damaged, if liquid is spilled onto or objects fall into the unit, if the unit is exposed to rain or moisture, or if the unit does not operate normally or has been dropped.

20. The Unit is a Monitor with LED backlight intended for general office used.

Contents

Compliance Information

FCC Compliance Statement.....	i
Industry Canada Statement.....	i
CE Conformity for European Countries.....	i
Indian Restriction of Hazardous Substances	ii
Declaration of RoHS2 Compliance.....	ii
Cautions and Warnings	iii

Copyright Information

For Your Records	1
------------------------	---

1. Getting Started

1.1 Package Contents	2
1.2 Wall Mount Kit Specifications (VESA).....	3

2. Smart Whiteboard/LCD Display

Features

2.1 Control Panel Overview.....	4
2.2 Terminal Interface Overview	5
2.3 Remote Control Overview	6
2.4 Inserting Remote Control Batteries	7
2.5 Remote Control Receiver Range	8

3. Setting Up Your Display

3.1 Connecting an External Device	9
3.2 RS232 Connections	10
3.3 Connecting USB Peripherals.....	11
3.4 AV IN Connections	12
3.5 Connecting to a media player.....	13
3.6 Coaxial Connections	13
3.7 Video Output Connection	14

4. ViewBoard Basic Operation

4.1 vLauncher for customized welcome screen	16
4.2 Tool Bar	
4.3 ViewBoard OSD (on screen display) Menu	24

5. ViewBoard Embedded Application and Setting

5.1 Embedded Digital Whiteboard App	49
5.2 ViewBoard Cast.....	55
5.3 Air Class	59
5.4 Other default apps.....	63

6. Trouble Shooting

7. Care and Maintenance

8. Display Modes

8.1 VGA Mode.....	75
8.2 HDMI Mode	76
8.3 DP Mode	77

9. Specifications

10. RS-232 Protocol

10.1 Introduction.....	79
10.2 Description	79
10.3 Protocol	81

Warranty Statement

Limited Warranty	97
Mexico Limited Warranty.....	99

Copyright Information

Copyright © ViewSonic Corporation, 2018. All rights reserved.

Macbook, Macbook Pro, Mac OS, iOS are registered trademarks of Apple Inc.

Microsoft, Windows, and the Windows logo are registered trademarks of Microsoft Corporation in the United States and other countries.

ViewSonic, the three birds logo, OnView, ViewMatch, and ViewMeter are registered trademarks of ViewSonic Corporation.

VESA is a registered trademark of the Video Electronics Standards Association.

DPMS, DisplayPort, and DDC are trademarks of VESA.

Disclaimer: ViewSonic Corporation shall not be liable for technical or editorial errors or omissions contained herein; nor for incidental or consequential damages resulting from furnishing this material, or the performance or use of this product.

In the interest of continuing product improvement, ViewSonic Corporation reserves the right to change product specifications without notice. Information in this document may change without notice.

No part of this document may be copied, reproduced, or transmitted by any means, for any purpose without prior written permission from ViewSonic Corporation.

For Your Records

Product Name:	IFP5550/IFP6550/IFP7550/IFP8650 ViewSonic Commercial Touch Display
Model Number:	VS17121/VS16954/VS16876/VS16874
Document Number:	IFP5550/IFP6550/IFP7550/IFP8650_UG_ENG Rev. 1E 11-05-18
Serial Number:	_____
Purchase Date:	_____

Product disposal at end of product life

ViewSonic respects the environment and is committed to working and living green. Thank you for being part of Smarter, Greener Computing.

Please visit ViewSonic website to learn more.

USA & Canada: <http://www.viewsonic.com/company/green/recycle-program/>

Europe: <http://www.viewsoniceurope.com/eu/support/call-desk/>

Taiwan: <http://recycle.epa.gov.tw/>

1. Getting Started

Congratulations on your purchase of a ViewBoard

Important! Save the original box and all packing material for future shipping needs.

Note: The word “Windows” in this user guide refers to Microsoft Windows operating system.

1.1 Package Contents

- VGA cable
- Power cable x 4
- Remote control
- AAA battery x 2
- USB cable
- Audio cable
- AV cable
- Stylus pen x 3
- User manual CD wizard
- Quick start guide
- RS232 adapter
- Clamp x 5
- Plate
- Screw x 3

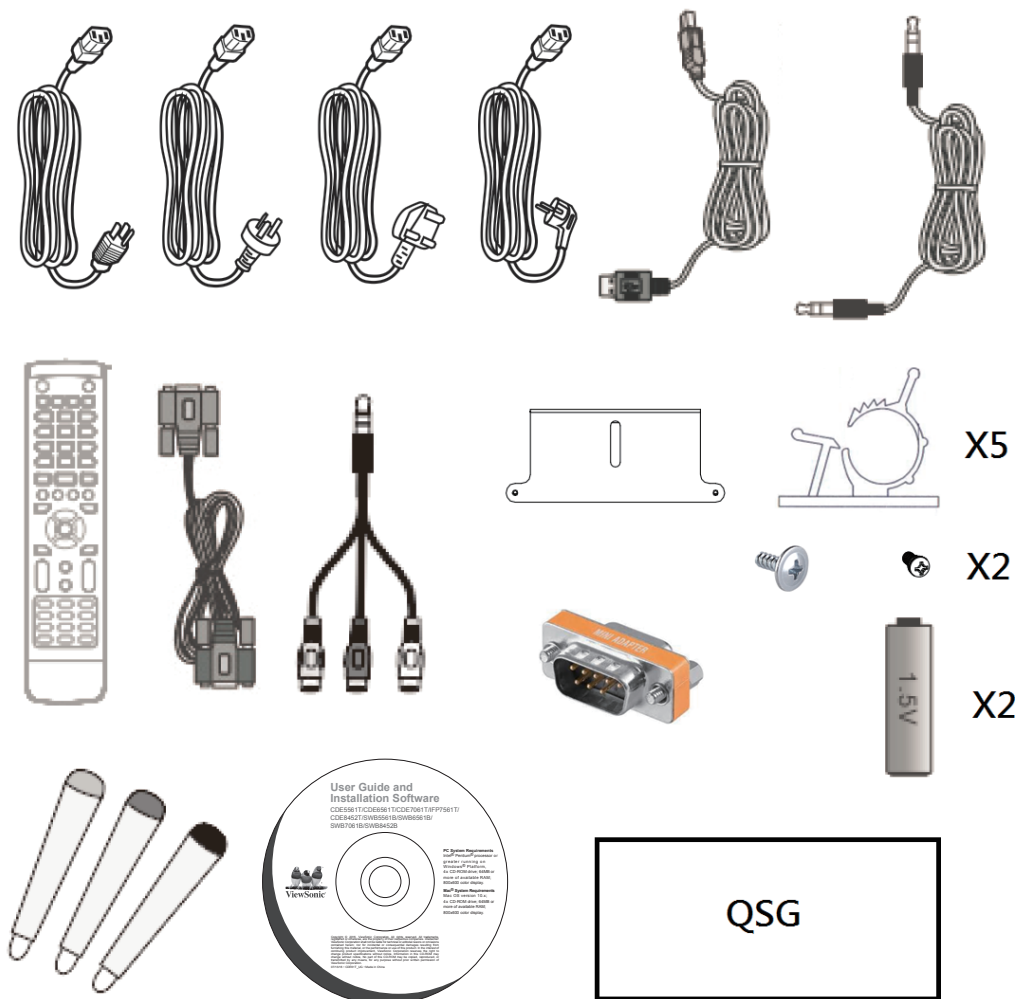

1.2 Wall Mount Kit Specifications (VESA)

Please follow the instructions in the wall mount installation guide to install your wall mount or mobile mount bracket. If attaching to other building materials, please contact your nearest dealer.

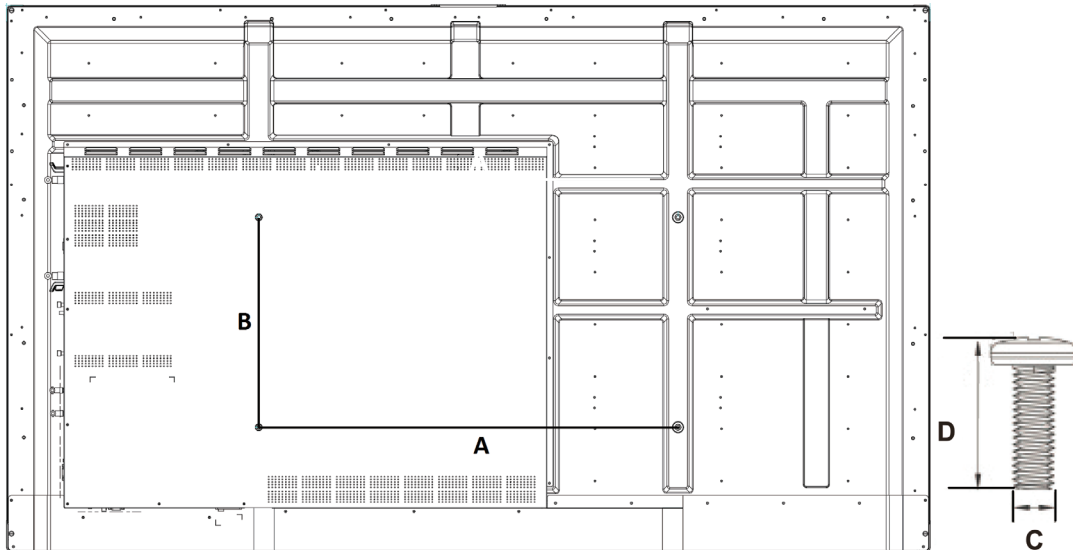

inch	VESA Spec. (A x B)	Standard Screw (C x D)	Quantity
IFP5550 - 55"	400 x 400mm	M8 x 25 mm	4
IFP6550 - 65"	600 x 400 mm	M8 x 25 mm	4
IFP7550 - 75"	800 x 400 mm	M8 x 25 mm	4
IFP8650 - 86"	800 x 400 mm	M8 x 25 mm	4

- ViewSonic provides the standard dimensions for wall mount kits as shown in the table above.
- To find the perfect mount, please browse www.viewsonic.com or call our service team.
- When purchasing our wall mount kit, a detailed install manual and all parts necessary for assembly are provided.
- Do not use the screws that longer than the standard dimension, as they may cause damage to the inside of the LCD display set.

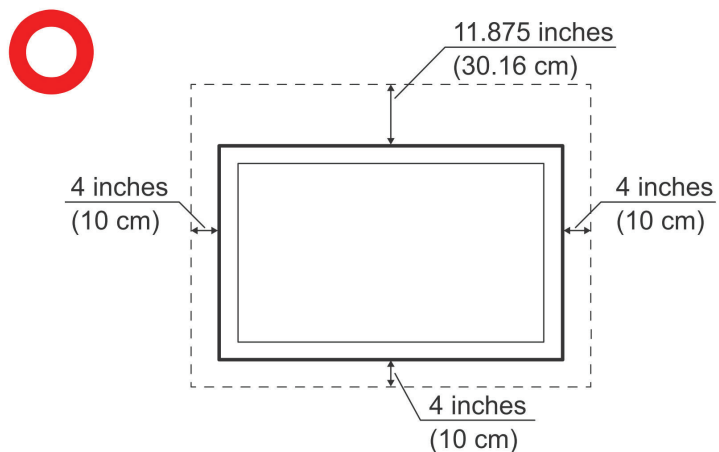
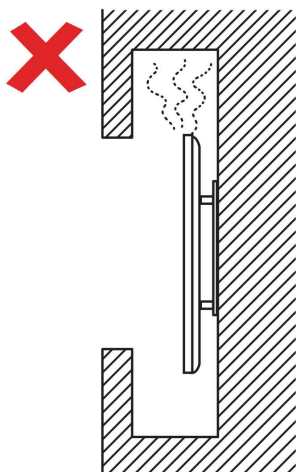

2. Smart Whiteboard/LCD Display Features

This section introduces you to the features of ViewBoard hardware platform.

Note: The features or applications described in this User's manual may vary depending on the device model purchased.

2.1 Control Panel Overview

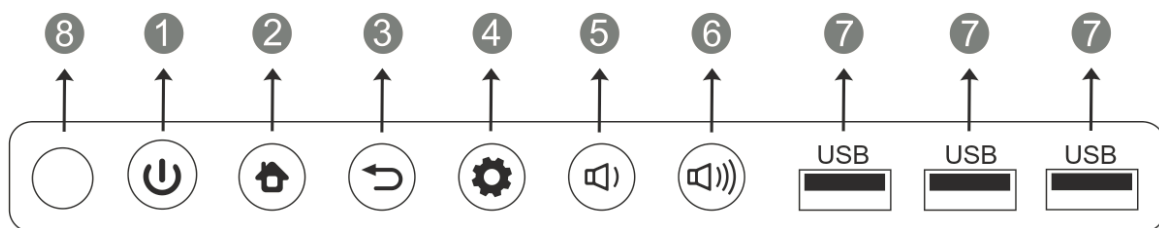





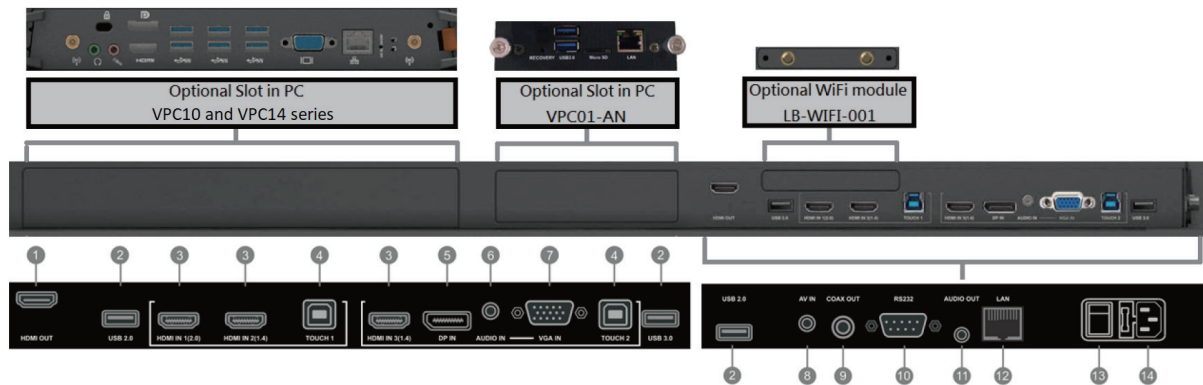



Item	Description
1	Press the key to turn on the device Press the key to turn on/off the screen Press and hold the key to turn off the device
2	Back to Embedded Player main interface
3	Return to Embedded Player previous level
4	Call up function menu
5	Decrease volume
6	Increase volume
7	USB port for Embedded Player and internal PC
8	Receives signals from the remote control

2.2 Terminal Interface Overview



Item	Description
①	Extend content out to another display devices
②	USB port for Embedded Player
③	High-definition multimedia interface signal input, connect to PC with HDMI output, set-top box, or other video device HDMI 1 supports up to 3840x2160@60Hz HDMI 2 and 3 support up to 3840x2160@30Hz
④	Touch signal output to the external PC Touch 1 for HDMI IN 1 and 2 Touch 2 for HDMI IN 3, DP IN and VGA IN
⑤	Connected to devices with DisplayPort output function DP supports up to 3840x2160@30Hz
⑥	External computer audio input
⑦	External computer image input
⑧	Composite video and audio input
⑨	Coaxial output
⑩	Serial interface, used for mutual transfer of data between devices
⑪	Audio output to the external speaker
⑫	Standard RJ45 (10/100MHz) Internet connection interface(This network port is used for Embedded Player and Slot in PC)
⑬	Power On / Off switch
⑭	AC power input

2.3 Remote Control Overview

- 1  :
Press to turn the display ON/OFF
- 2  :
Mute / Unmute
- 3 DISPLAY :
Display information of the current input source
- 4 P.MODE :
Blank screen
- 5 S.MODE :
Freeze screen
- 6 Numeric button:
Numeric input button
- 7 -/--, ALT+TAB:
Press to switch between PC applications
- 8 0 :
Numeric input button
- 9  , ALT+F4 :
Close current PC window
- 10 INPUT:
Source selection button
- 11 MENU:
Press to display Menu
- 12 RED+ALT:
Screen capture
- 13 GREEN+TAB:
PC 'Tab' button
- 14 YELLOW+DESKTOP:
Switch to slot in PC desktop
- 15 BLUE+BACKSPACE:
PC 'Backspace' button
- 16 START , D. MENU:
PC 'Windows' button
- 17  , D. TITLE:
PC 'Menu' button
- 18  :
Press to scroll up
- 19  :
Press to scroll left
- 20  :
Press to scroll right
- 21  :
Press to scroll down
- 22 ENTER:
Enter button. Press it to select options.
- 23  , D. USB:
Writing software startup
- 24 ESC/EXIT, D. SETUP:
Shortcut button to exit dialog boxes
- 25 EPG:
Back
- 26 FAV, SPACE:
PC 'Space' button
- 27 CH. +, CH. - :
CH+ : PC previous page
CH- : PC next page
- 28 VOL+, VOL- :
Increase / Decrease volume
- 29 F1:
Windows F1 Function
- 30 F2:
Windows F2 Function
- 31 F3:
Windows F3 Function
- 32 F4:
Windows F4 Function
- 33 F5:
Windows F5 Function
- 34 F6:
Windows F6 Function
- 35 F7:
Windows F7 Function
- 36 F8:
Windows F8 Function
- 37 F9:
Windows F9 Function
- 38 F10:
Windows F10 Function
- 39 F11:
Windows F11 Function
- 40 F12:
Windows F12 Function
- 41 ASPECT:
Back to Embedded Player main interface

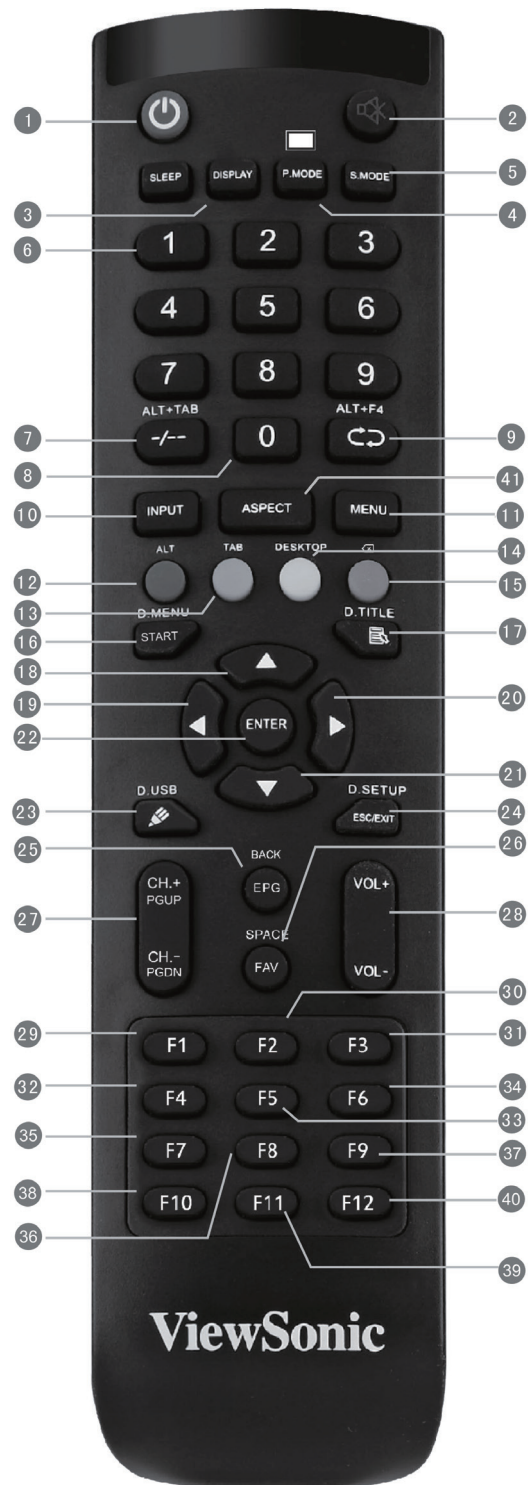

2.4 Inserting Remote Control Batteries

To insert the provided batteries into the remote control follow these instructions. We recommend that you don't mix battery types.

1. Remove the cover on the rear of the remote control.
2. Insert two "AAA" batteries, ensuring the "+" symbol on the battery matches the "+" on the battery post.
3. Replace the cover by aligning it with the slot on the remote control and snapping the latch shut.

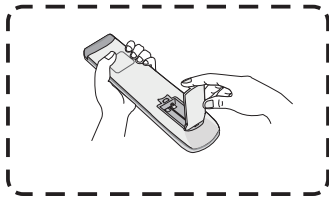

(1)

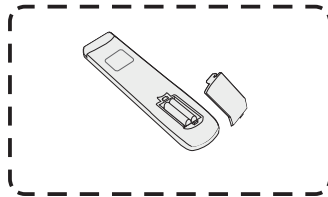

(2)

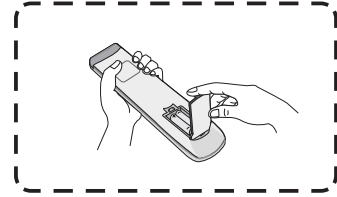

(3)

Warning: There is a risk of explosion if batteries are replaced with the incorrect type.

Note: Always dispose of old batteries in an environmentally friendly way. Contact your local government for more information on how to dispose batteries safely.

2.5 Remote Control Receiver Range

The working range of the remote control receiver is shown here. It has an effective range of 8 meters. Make sure there is nothing obstructing the remote control's signal to the receiver.

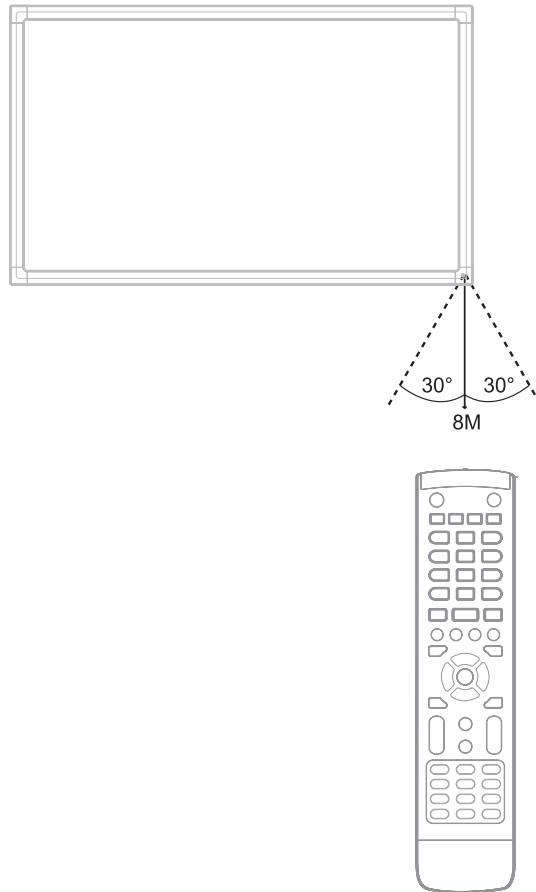

3. Setting Up Your Display

Warning: For the safety of you and your unit, please do not connect to a power supply before the external device is prepared.

3.1 Connecting an External Device

1. To display video via VGA cable.

- Connect a VGA cable (15-pin) from your external device to the VGA IN port on the display.
- Connect an audio cable from the AUDIO OUT port on your external device to the AUDIO IN port on the display.
- Connect a USB cable to the external device from the TOUCH OUT port of the display.

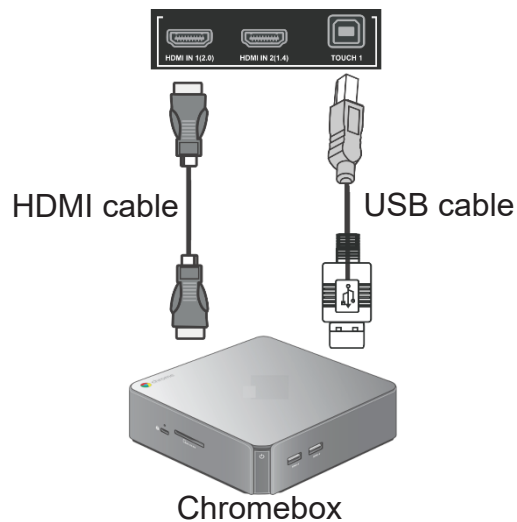

2. To display video via HDMI cable.

- Connect a HDMI cable from your external device to the HDMI IN port on the display.
- Connect a USB cable to the external device from the TOUCH OUT port of the display.

3.2 RS232 Connections

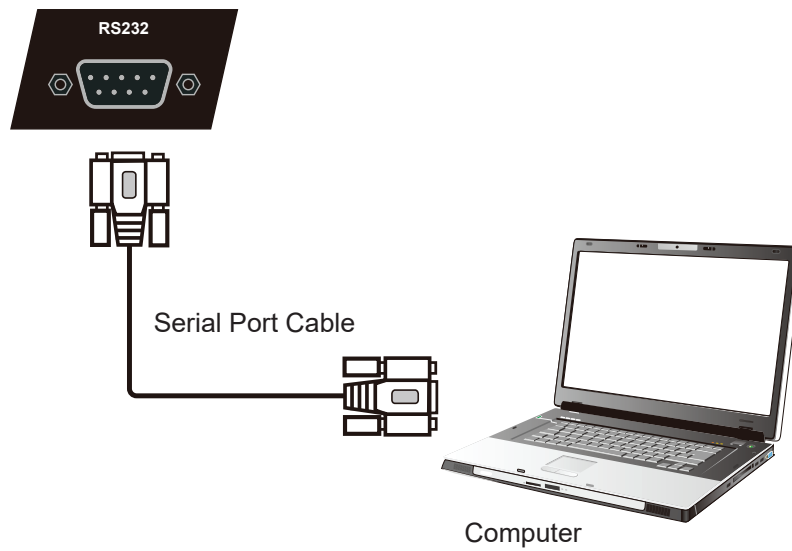

When you use a RS232 serial port cable to connect your display to an external computer, certain functions can be controlled remotely by the PC, including power on/off, volume adjustment and more.

ViewSonic offer a complimentary software, vController, that integrated the common control comments that user could perform from remote PC to control the ViewSonic commercial displays. Please find more introduction about control commends via series port in Chapter 10.

3.3 Connecting USB Peripherals

Just like a regular PC, it is easy to connect various USB devices and other peripherals with your smart whiteboard.

1. USB Peripherals: Plug the USB device cable into the USB IN port.
2. Networking and modem cables: Plug the router cable into the LAN IN port.
3. Microphone: Plug the microphone cable into the MIC port.

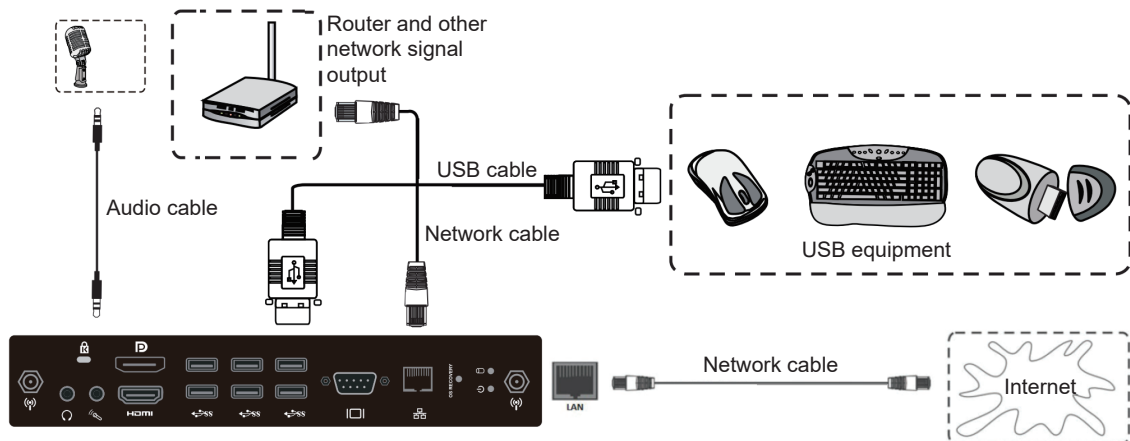

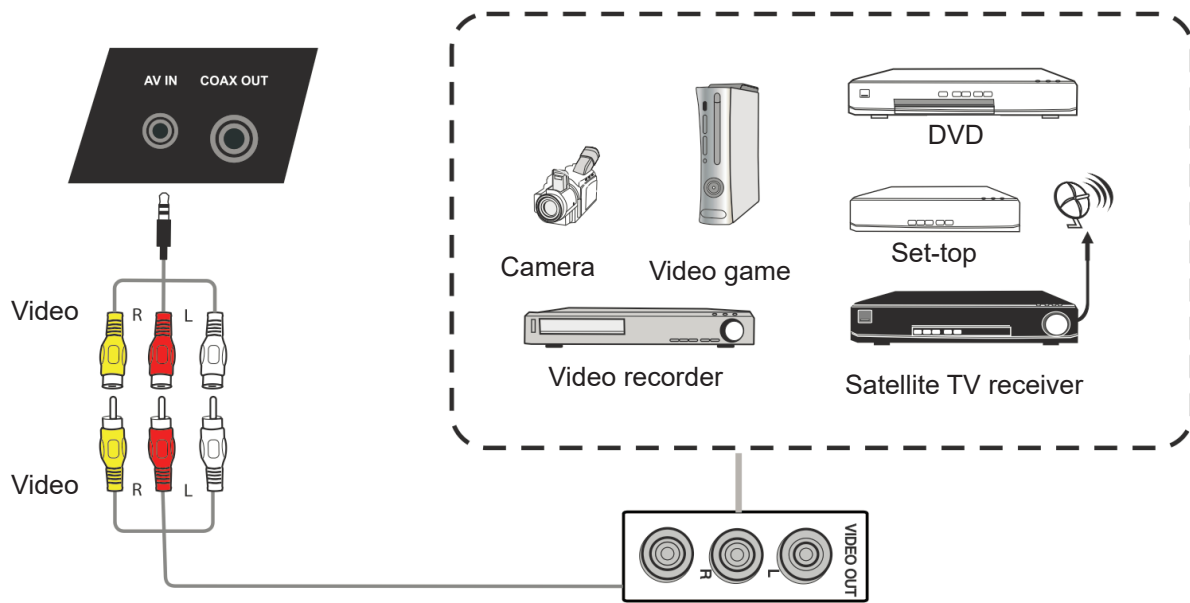

3.4 AV IN Connections

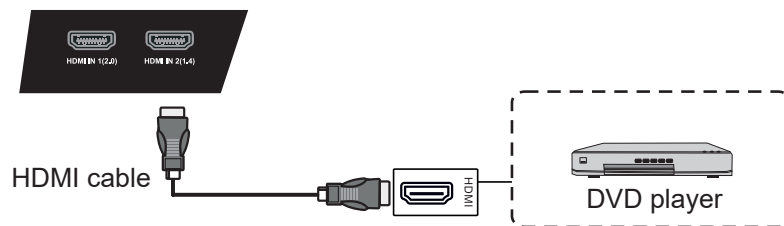

1. Connect a 3-color AV cable from the AV IN ports on your display to the AV OUT ports of a peripheral device (AV cable: Yellow is Video, Red is Audio-R, White is Audio-L).
2. Plug in the power cord, and turn on the rear-panel power supply switch.
3. Press the  button on the right-hand side of the display to turn the screen on.
4. Press the INPUT button to switch to the "AV" source.

3.5 Connecting to a media player



1. Connect the HDMI cable to the HDMI ports on your display and peripheral device.
2. Plug in the power cord, and turn on the rear-panel power supply switch.
3. Press the  button on the right-hand side of the display to turn the screen on.
4. Press the INPUT button to switch to the HDMI source.

Note: HDMI 1 supports up to 3840x2160@60Hz
HDMI 2/3 supports up to 3840x2160@30Hz

3.6 Coaxial Connections

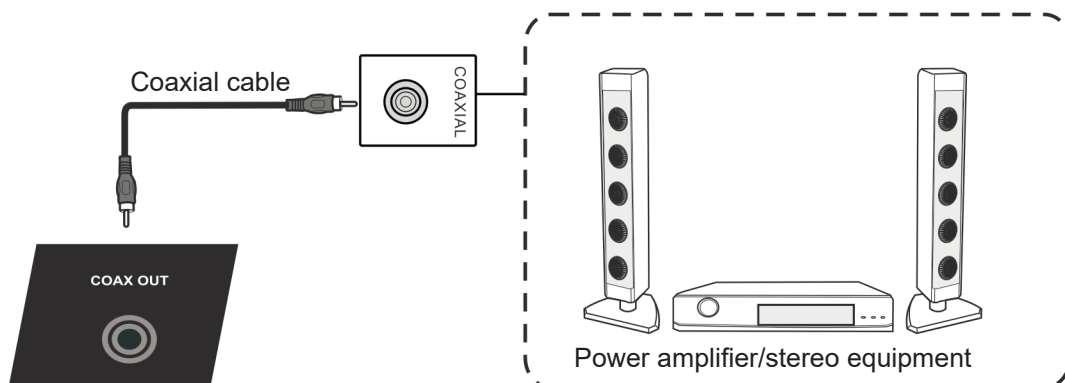

1. Connect a coaxial cable from DIGITAL OUT to your sound system's coaxial connector.
2. Plug in the power cord, and turn on the rear-panel power supply switch.
3. Press the  button on the right-hand side of the display to turn the screen on.

3.7 Video Output Connection

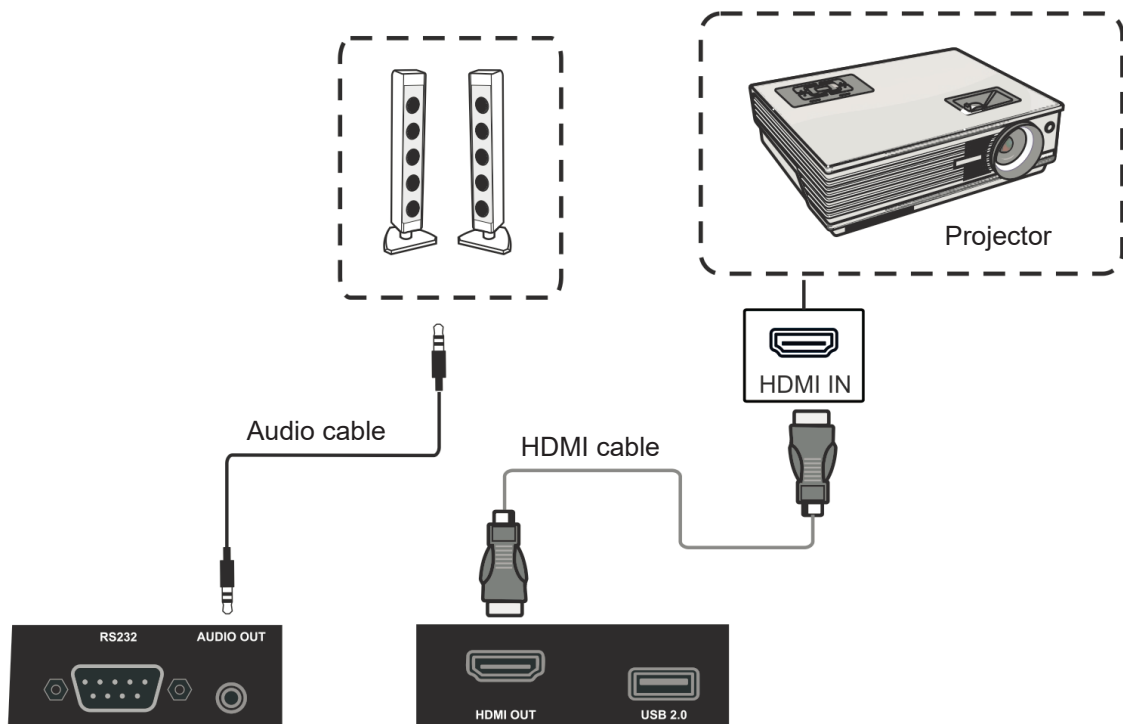

1. Use HDMI cable to connect display devices with HDMI in, and use audio cable to connect sound input.
2. Plug in the power cord, and turn on the rear-panel power supply switch.
3. Press the POEWR button on the right-hand side of the display to turn the screen on.

Note: The HDMI OUT can output any source signal, and the maximal resolution is 1080P@60Hz.

4. ViewBoard Basic Operation

Power on ViewBoard

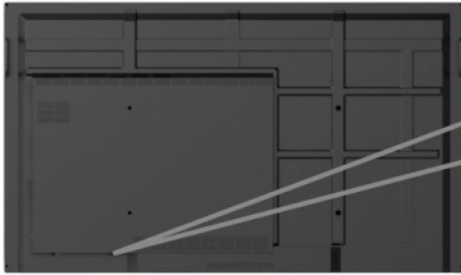

The AC Power input and switch button located on the bottom of the unit.



Press  to turn on ViewBoard





4.1 vLauncher for customized welcome screen



Customizable - choose your “top4” default app

Editable - change your default message

Switchchable - change your launcher theme image

Item	Description
 vBoard	Click to vBoard software The icon can be replaced or removed
 ViewBoard Cast	Click to ViewBoard Cast software The icon can be replaced or removed
 Chromium	Click to enter internet page The icon can be replaced or removed
 APPs	Click to enter Embedded Player application management page
 Network	Click to enter Ethernet settings

Viewboard will offer two background images design: One with corporate oriented theme and the other with education oriented theme for user to choose from.

Initial setting for Education mode or Corporate mode

ViewBoard will run setup wizard when user first time to power on it.

Step 1: Select your language.

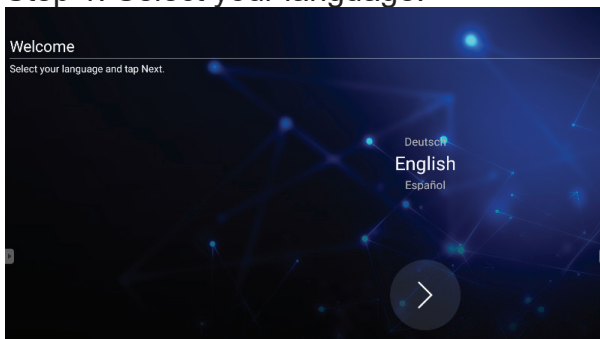

Step 2: To verify LAN connected.

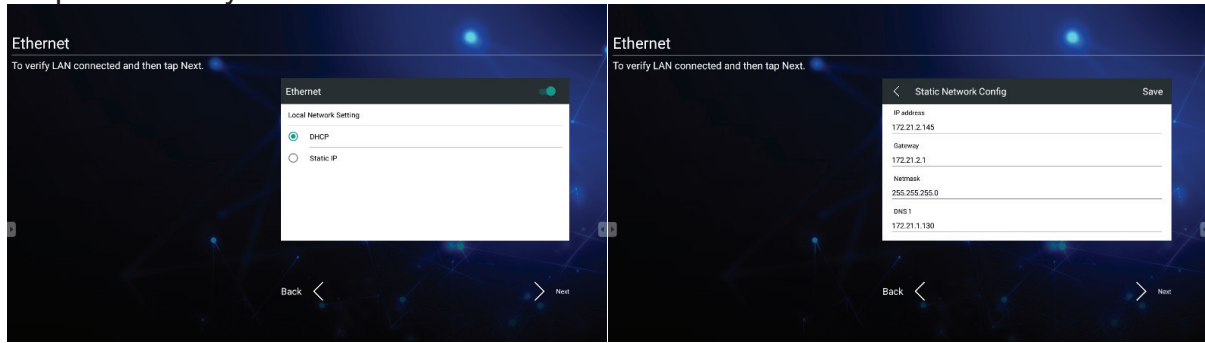

Step 3: Select the appropriate time zone to set the date and time.

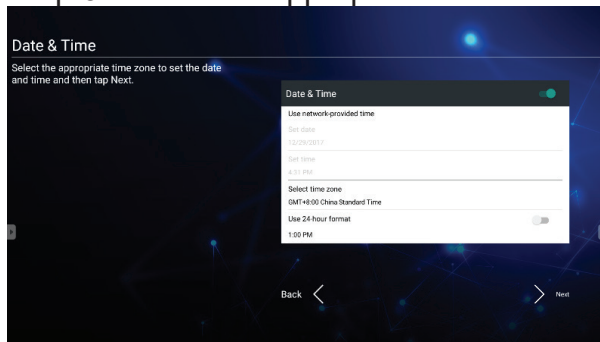

Step 4: Select the preferred vBoard or vLauncher mode.

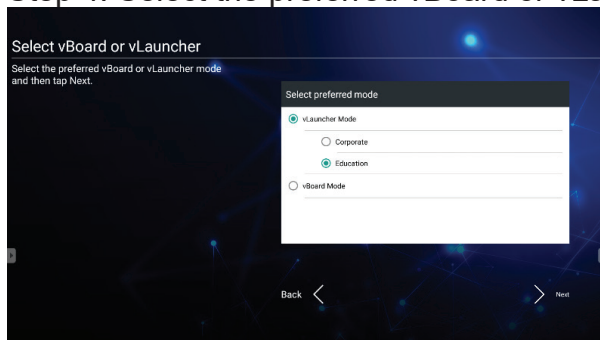

How to customize the default app:

Step 1:
click the “app” icon to go to the app listing page

Step 2:
long press the preferred app icon e.g. WPS and drag to launcher page

Step 3:
the chosen app e.g. WPS will be appeared in the launcher as the short-cut to launch the program

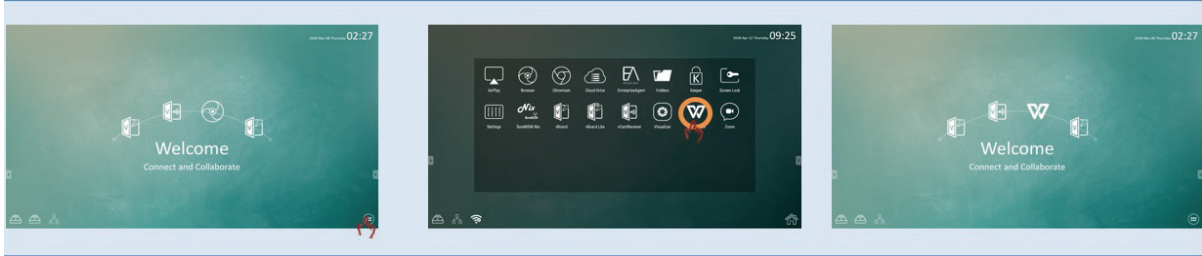





4.2 Tool Bar

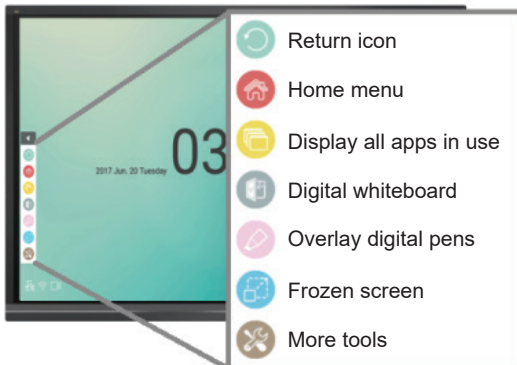

Tool bar trigger icons are in the edge of the ViewBoard launcher

Click the tool bar icons to pop up the full tools that could facilitate the interactive usage of ViewBoard. Users could shift the tool bar icon to the higher or lower position based on different usage scenarios. Default settings of the tool bar will be available in all input channel sources; user could go to advanced setting page to change to tool bar options for below options: (1) available in all channel, (2) available in all channel but Pc, (3) disable tool bar



Item	Description
 Return	Click to return to previous operation interface. (Only for Embedded Player source)
 Home	Click to return to home interface of Embedded Player.
 Display all	Click the “display all” icon to display all the embedded app that being used on this Viewboard
 vBoard	Click to enter vBoard software



Pen

Click the pen tool icon and pop up the “Pen, Clear, and Save option” tool bar



- ① Digital pen
With four colors options in red, black, blue, and green (rotate in sequence), that can annotate overlay any input source.
Note: default setting of digital pen supports up to 10-point writing
- ② Digital highlighter pen
With the transparency setting and four color options of yellow, orange, blue, and green (rotate in sequence). Default setting is 10-point marking
- ③ Brush
Click the “brush icon” to clean all the digital inking on the screen
- ④ Save as
Click to save the on-screen image into internal storage
- ⑤ Cloud drive
Click to save the image into cloud drive. The initial cloud drive setting is required.
- ⑥ Writing mode
Transparent mode: Screen won't be froze, the screen resolution won't be reduce to 1080P.
Opaque mode: Screen will be froze, the screen resolution will be reduce to 1080P.
- ⑦ Picture save
Speed priority: Save the on-screen image to 1920x1080, the save speed is fast.
Quality priority: Save the on-screen image to 3840x2160, it will spend around 10 seconds for saving.
Note: In opaque(non-transparent) mode, user can't select picture save setting.
- ⑧ Close
Click to close the digital pen icon



Frozen screen

Click the “Frozen screen” icon to convert the current display content into a stilled image and then able to zoom in or zoom out for different discuss usage

Note: IFP will spend 6 seconds to reduce the screen resolution to 1080P.



①



②



③



④

① Zoom in

Click to enlarge the “frozen” screen capture image

Note: the screen resolution will be reduced after zoom-in effect

② Zoom out

Click to shrink the “frozen” screen capture image

③ Back to full screen

Click to reset the zoom in/ zoom out effects to the original full screen

④ Close

Click to close the digital pen icon



More Tools

Click the “More tools” icon to pop up the more apps within ViewBoard tool bar. There are 5 tools; touch swipe to show 2nd page of the tool options.



① Spotlight

Click to spotlight to highlight the focus content zone. Click the setting icon to adjust the spotlight size and alpha blending effect.

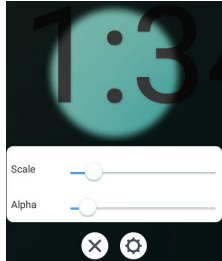

② Count down

Click to open the count-down timer, with optional alarm setting. Touch swipe to adjust the value then click the start icon

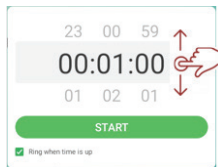

User can pause, resume and reset the count-down timer.

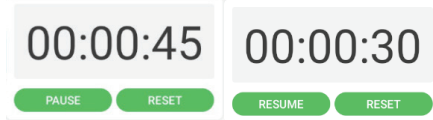

Count-down timer will reduce size then move to lower center side automatically when user touch other area. User just need to click Count-down timer again, it will return to normal size and original location.

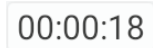



More Tools

③ Stop Watch

Click to open "stop watch" function then click the start icon.

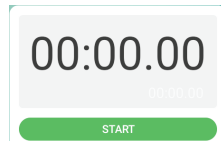

User can pause, continue, reset stop watch and note the figure.

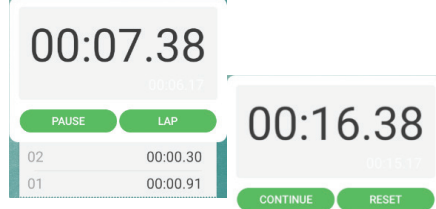

Stop Watch will reduce size then move to lower center side automatically when user touch other area. User just need to click Stop Watch again, it will return to normal size and original location.

00:00:18

④ Air Class

Interactive teaching tool for classroom usage. See more introduction in the chapter 5.3

⑤ Folder

A short cut to access the folder function and retrieve document. See more introduction in the chapter 5.4

4.2.1 vPen

Besides tool bar as the short cut to access for the embedded app; ViewBoard also have another annotation tool – vPen.

In any input source, to place two fingers on the screen (about 20~50mm spacing) and stay more than two seconds to call up annotation menu. In this mode, user can only use touch pen to operate.



Annotation Menu



Floating Pen Menu



Short cut Menu

Item	Description
Annotation menu	Pop up sub-menu.
Return	Click to return to previous operation interface.
Main	Click to return to main interface of Embd Player.
Pen	Pop up Pen menu. Click to make annotation in the picture, click again to change color.
Screen capture	Click and drag a rectangle on screen. It can arbitrarily adjust position and shape of the rectangular. Storage location: /Storage/vBoard
Save as	Click to save the current image to internal storage, Google Drive or OneDrive. Internal storage location: /Storage/vBoard
Eraser	Click to erase handwriting as required.
Short cut	Pop up short cut menu.
vBoard	Click to enter vBoard software.
ViewBoard Cast	Click to enter ViewBoard Cast software.
App	Click to App interface of Embedded Player.
Close	Click to close annotation menu.

4.3 ViewBoard OSD (on screen display) Menu

ViewBoard has two options to open up the OSD menu setting:

Option 1: gesture from edge of bottom screen

Option 2: click the setting button on the function keypad



4.3.1 Basic setting

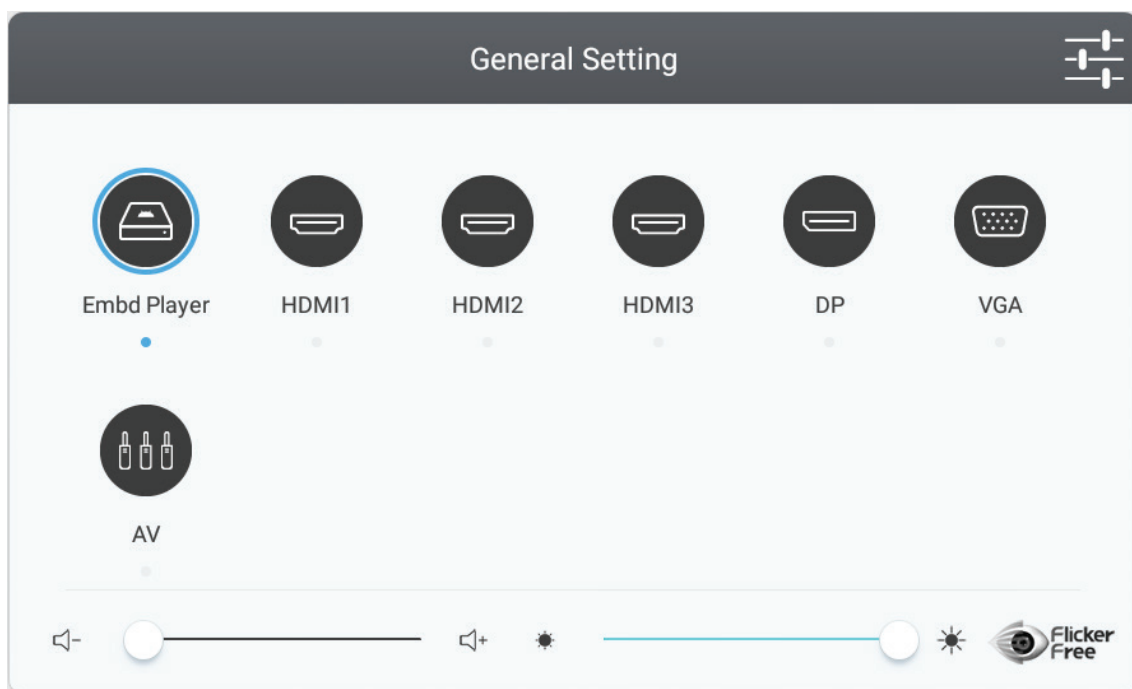

To select an input source:

1. Press INPUT button on remote control to display the general setting menu, then press DOWN to enter the input source menu..
2. Press DOWN / UP / LEFT/ RIGHT to select the input source you want.
3. Press Enter button on remote control or click with touch pen to select the input source.

4. Press BACK key on remote control or click blank area outside menu with touch pen to quit the on-screen menu.



To adjust the backlight and enable/disable Flicker Free:

1. Press INPUT button on remote control to display the general setting menu.
2. Drag icon directly with touch pen to adjust the backlight value.
3. Click Flicker Free icon to enable/disable the function.
4. Press EXIT key on remote control or click blank area outside menu with touch pen to quit the on-screen menu.



To adjust the volume:

1. Press INPUT button on remote control to display the general setting menu.
2. Drag icon directly with touch pen to adjust the value.
3. Press < Mute > button on remote control to enable or disable mute function.
4. Press EXIT key on remote control or click blank area outside menu with touch pen to quit the on-screen menu.

4.3.2 More OSD settings

Press MENU button (in any source but not Embedded Player source) on remote control to display general settings menu.

Audio Setting

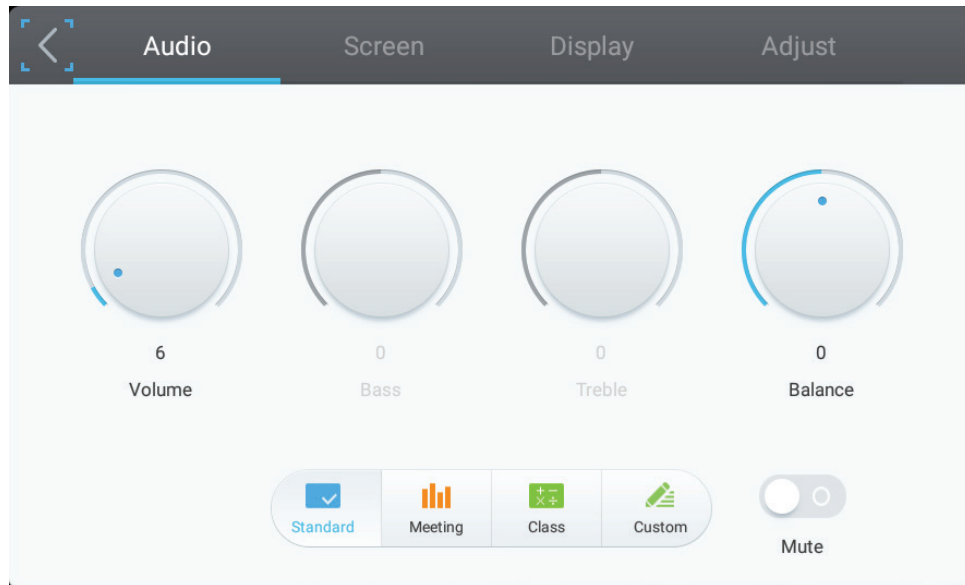

1. Turn the volume, bass, treble and balance icons directly with touch pen to adjust value. Or press DOWN / UP / LEFT/ RIGHT to select icon then press VOL+/VOL- to adjust value.
2. Click the Standard, Standard, Meeting, Class, Custom icons directly to change the audio efficacy.
3. Click the Mute icon directly to enable/disable mute function.

Screen Setting

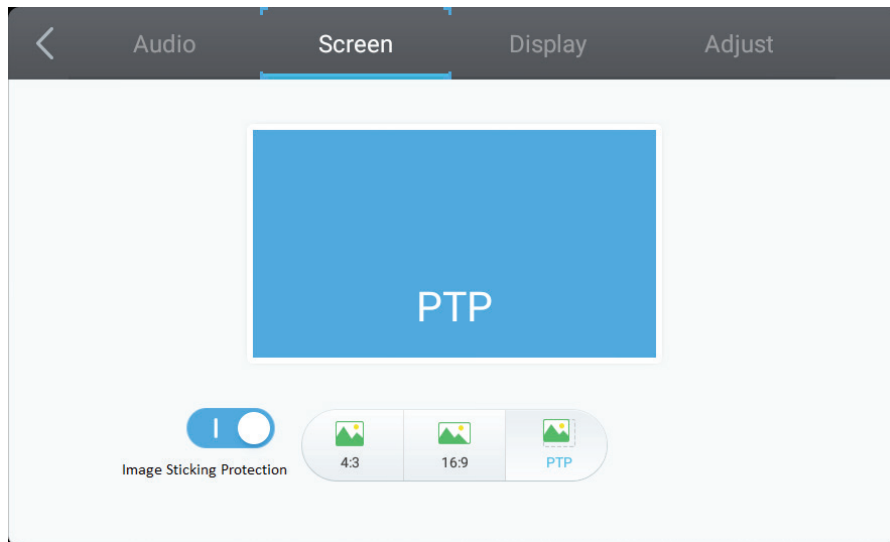

1. Image Sticking Protection

To reduce the possibility of screen burn, this unit is equipped with image sticking protection technology.

If the screen displays a still image for a certain period of time you define, the product activates the screen saver to prevent the formation of burnt in ghost images on the screen.

Image sticking protection moves the picture slightly on the screen.

The image sticking protection Time setting allows you to programmer the time between movements of the picture in minutes.

Minimize image retention by finely moving pixels horizontally and vertically.

2. Click the 4:3 and 16:9 icons directly to change the ratio.

Display Setting



1. Turn the Brightness, Contrast, Hue and Sharpness icons directly with touch pen to adjust value. Or press DOWN / UP / LEFT/ RIGHT to select icon then press VOL+/VOL- to adjust value.
2. Click the Standard, Bright, Soft and Customer icons to change the display efficacy.
3. Click the Standard, Cold and Warm icons to change the color temperature.
4. Drag  icon directly with touch pen to adjust the blue light value.

Adjust Setting

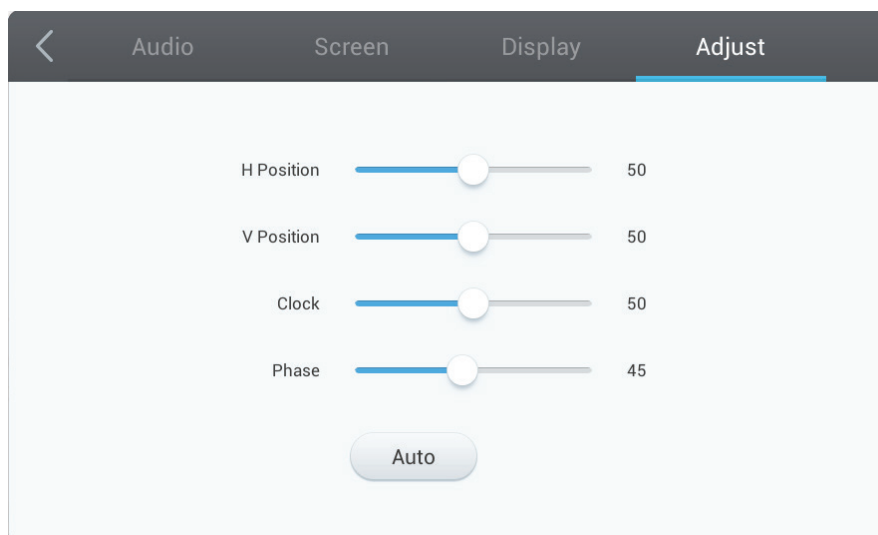

1. Drag icon directly with touch pen to adjust the value.
2. Click the Auto icon directly to do the auto adjustment.

4.3.3 Advanced setting

When Viboard in Embd Player source, click advanced setting button in the OSD menu to enter the advanced setting toward the ViewBoard embedded player.

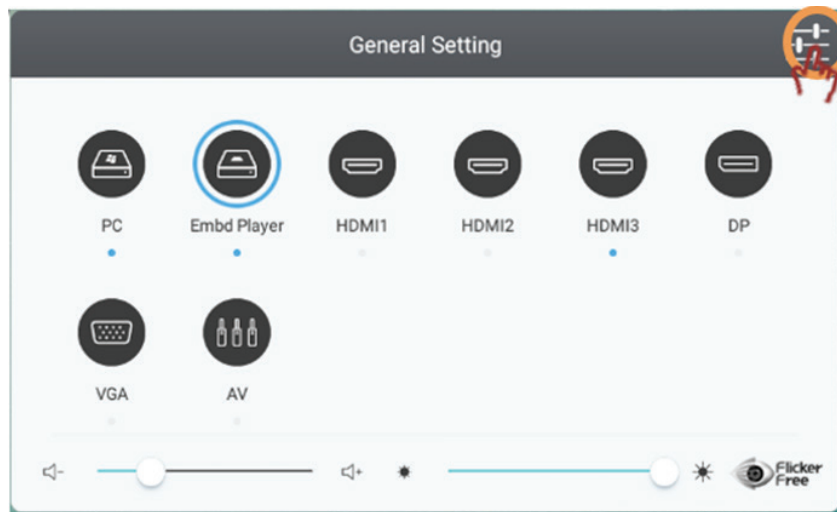

- **Wireless & network:** Check the current network connection status and the network parameters of the device.

Note: WiFi, WiFi hot spot and BT settings will appear when LB-WIFI-001(optional) has installed.

Ethernet will disable automatically when WiFi is enable.

WiFi will disable automatically when Ethernet is enable.

WiFi will disable when Wireless hotspot is enable.

The device cannot connect to Internet when it connects to Wireless hotspot.

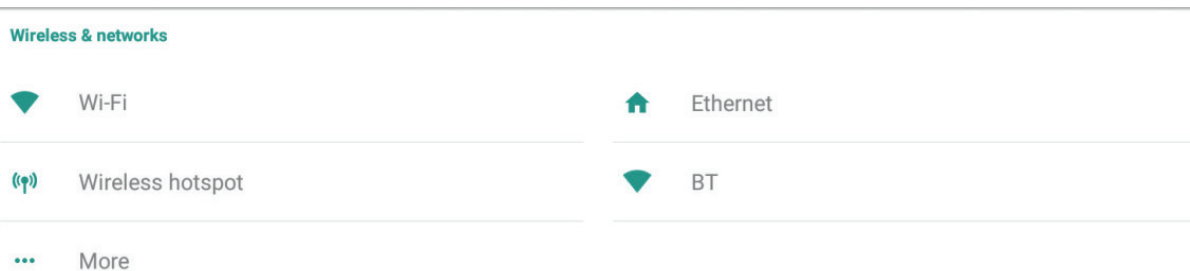

Wi-fi

Click On/Off icon to on/off WiFi function.

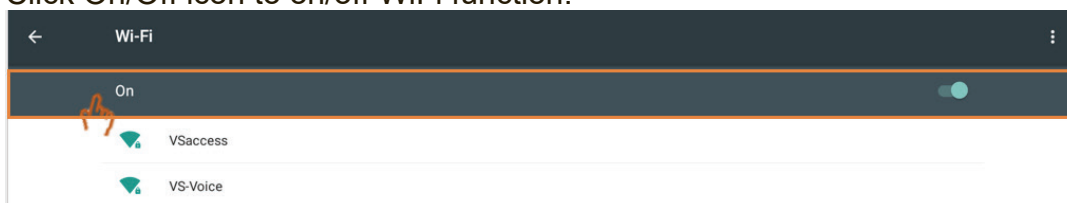

Click more settings to add network, save networks, refresh or entry advanced setting.

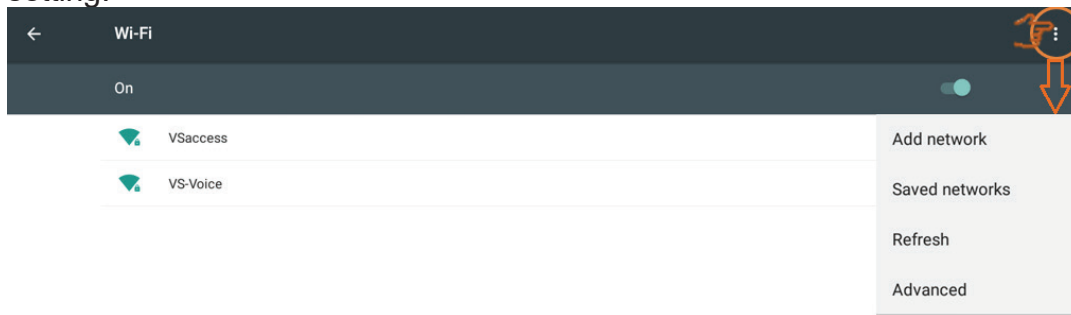

Select a SSID then click connect, user can key in password if needed.

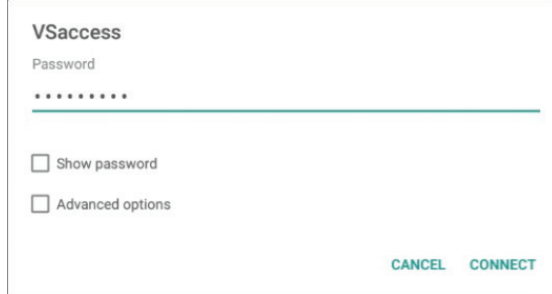

In advanced options, user can set proxy and IP settings.

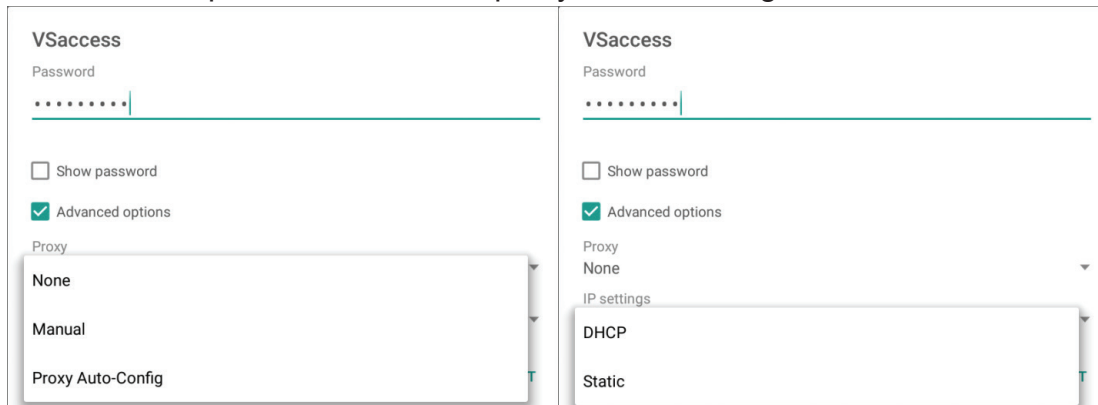

Ethernet

Click On/Off icon to on/off Ethernet function.



Click more settings to entry advanced setting.

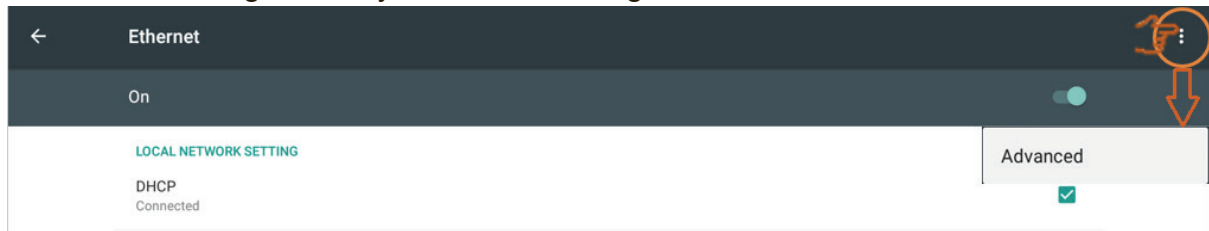

Click static IP setting to set related settings if needed.

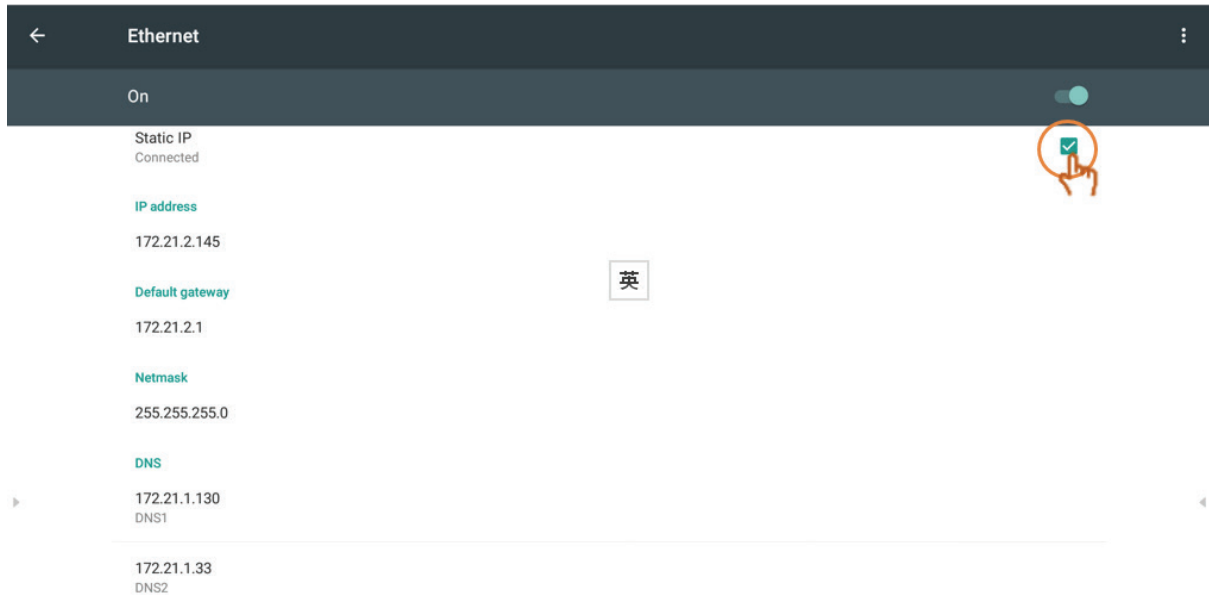

Click Proxy setting to change related settings if needed.

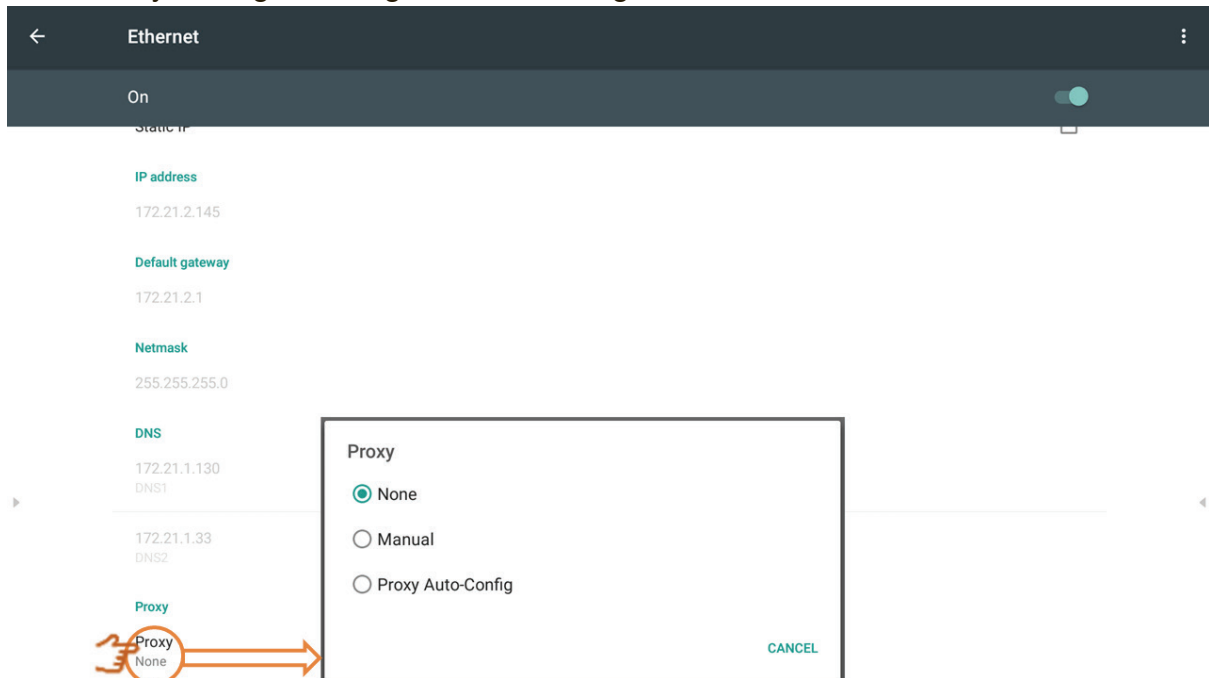

Wireless hotspot

Click Portable Wi-Fi hotspot icon to on/off Wi-Fi hotspot function.

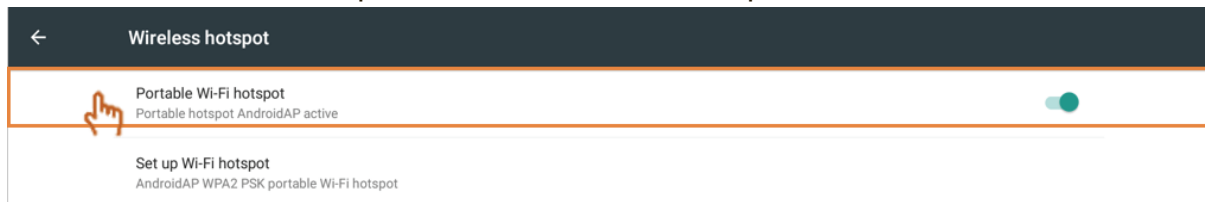

Click Set up Wi-Fi hotspot to set network name and security then click save.

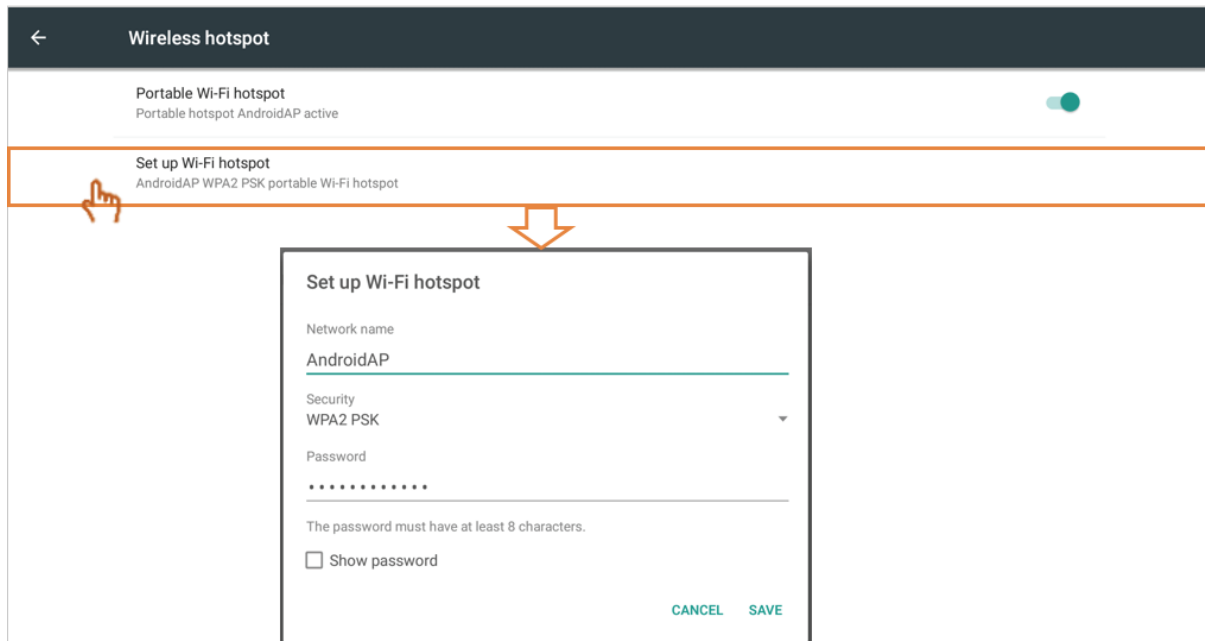

BT

Click On/Off icon to on/off BT function.

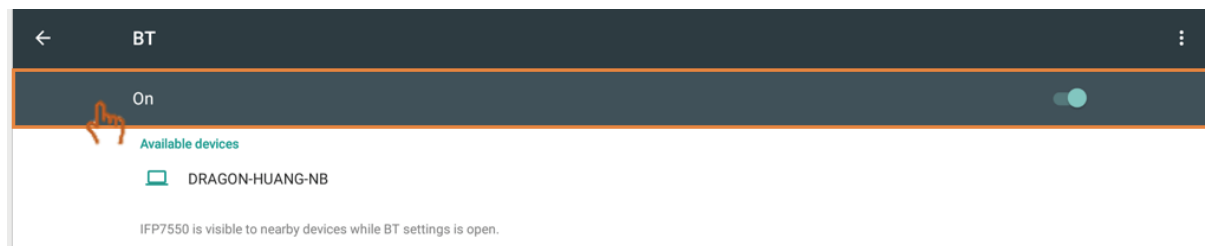

Click more settings to refresh, rename this device and show received files.

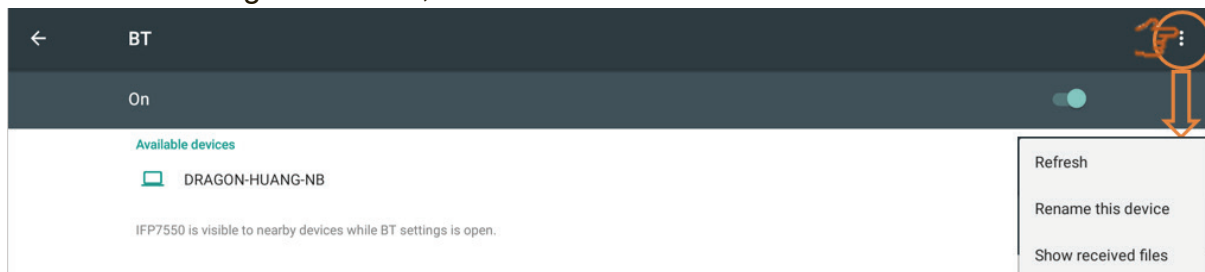

Click a device to pair and connect.

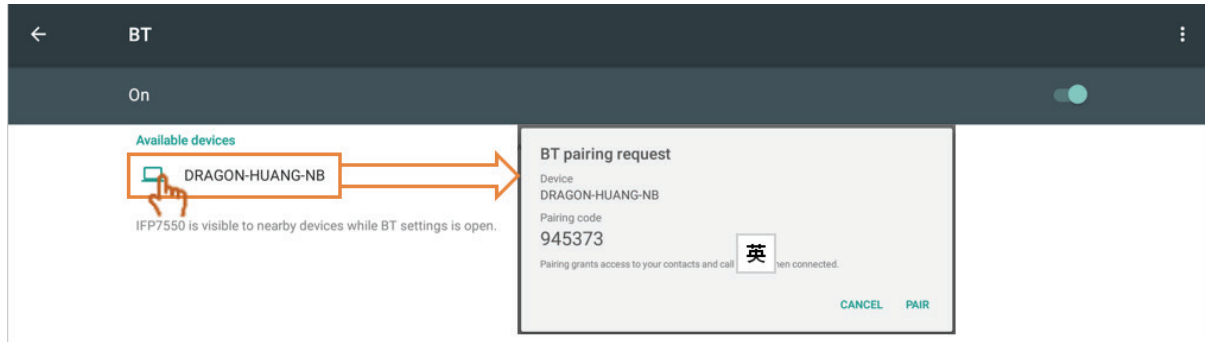

More

Click VPN icon and more icon to always on VPN if needed.



Click + to edit VPN profile.

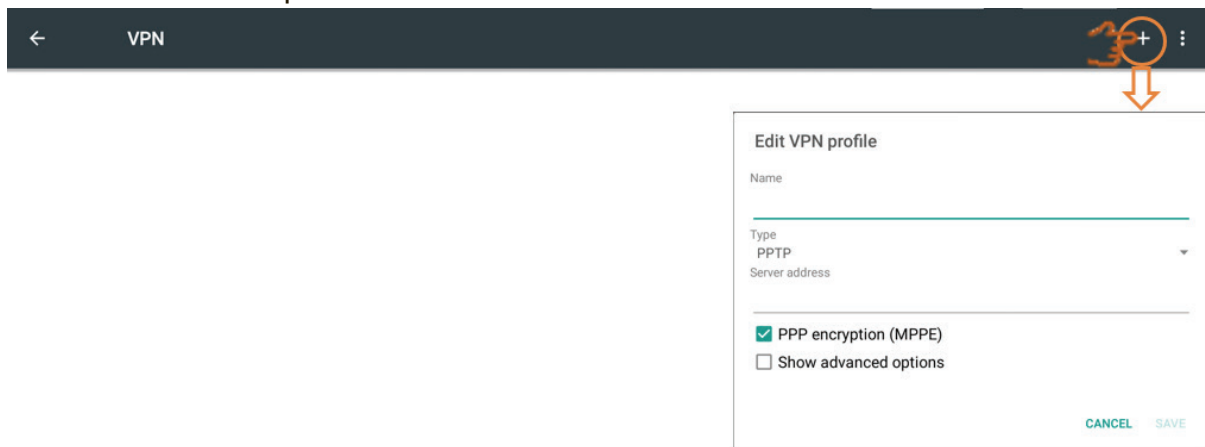

Click to key in name.

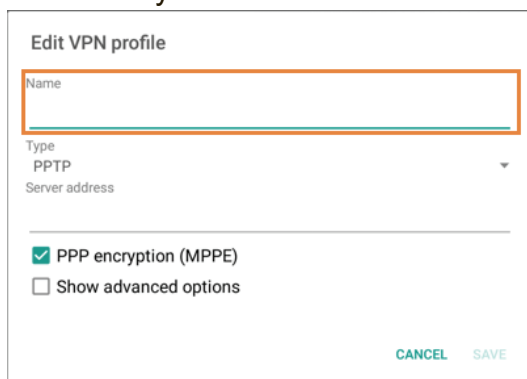

Click to select type.

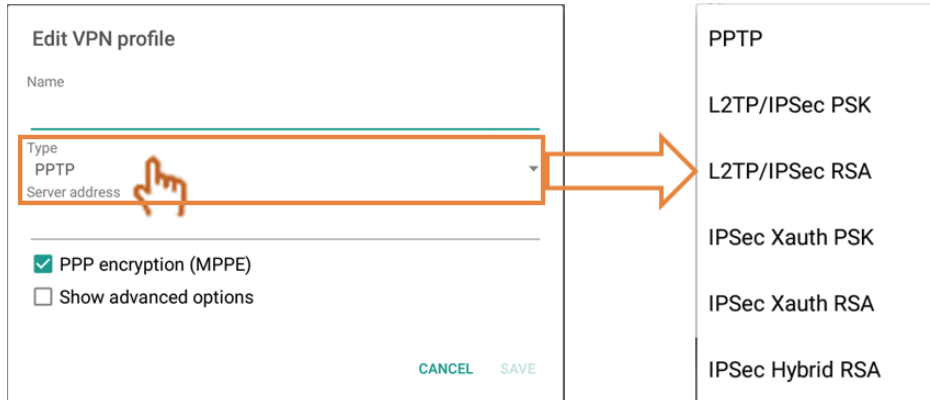

The screenshot shows the 'Edit VPN profile' dialog box. The 'Type' dropdown menu is open, displaying a list of VPN protocols: PPTP, L2TP/IPSec PSK, L2TP/IPSec RSA, IPSec Xauth PSK, IPSec Xauth RSA, and IPSec Hybrid RSA. An orange hand icon points to the 'Type' dropdown, and an orange arrow points from the dropdown to the list of options.

Click to enable/disable PPP encryption.

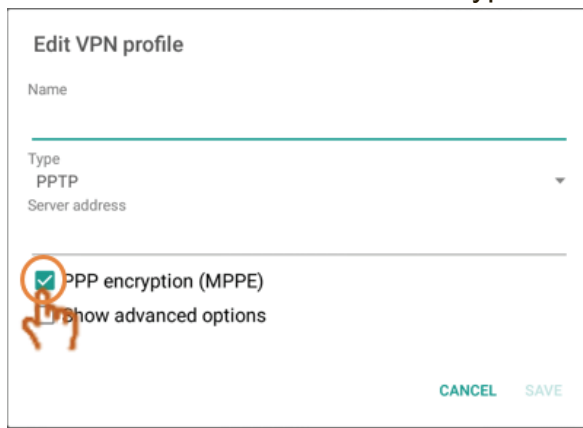

The screenshot shows the 'Edit VPN profile' dialog box. The 'PPP encryption (MPPE)' checkbox is checked, and an orange hand icon points to it. The 'Show advanced options' checkbox is unchecked.

Click to show advanced options.

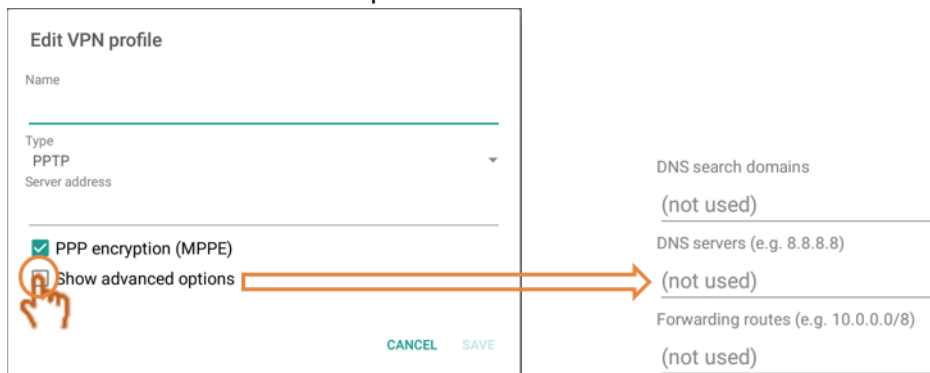

The screenshot shows the 'Edit VPN profile' dialog box. The 'Show advanced options' checkbox is checked, and an orange hand icon points to it. An orange arrow points from the 'Show advanced options' checkbox to the right, where a list of advanced options is displayed: DNS search domains (not used), DNS servers (e.g. 8.8.8.8) (not used), and Forwarding routes (e.g. 10.0.0.0/8) (not used).

- **Share:** SAMBA provides file sharing services in a LAN. When enable the SAMBA service, user can explore the IFP file system with a PC or mobile equipment.

SHARE

 SAMBA Service

Click to enable SAMBA service then set password if needed.

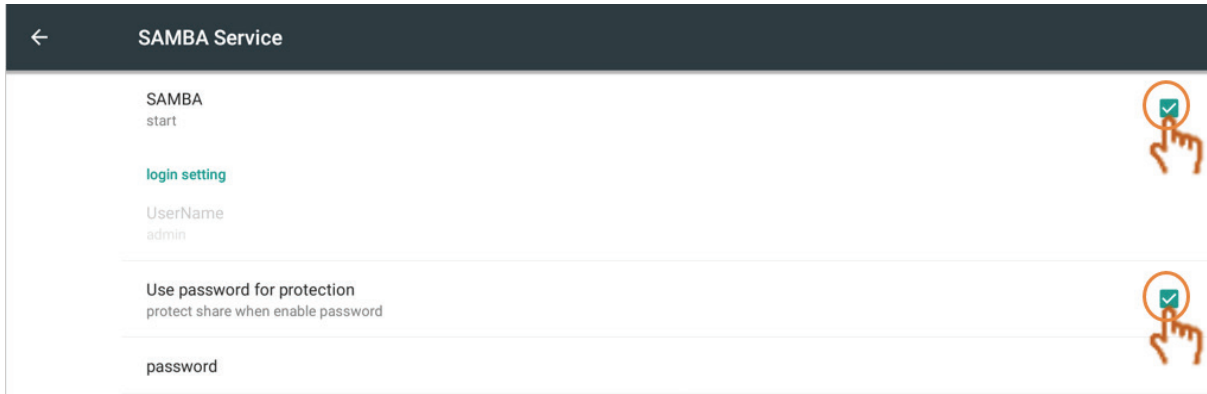

Connect the IFP and client equipment to the same network. Make sure they are reachable with each other.

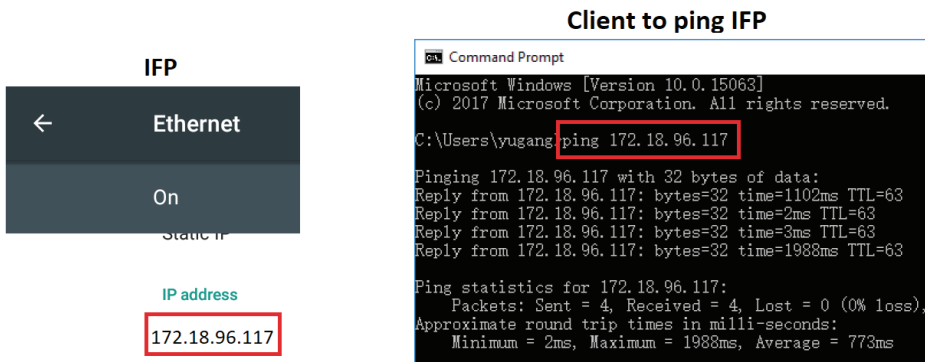

Login the IFP with the client equipment, Windows PC for example. Input the IFP IP address.

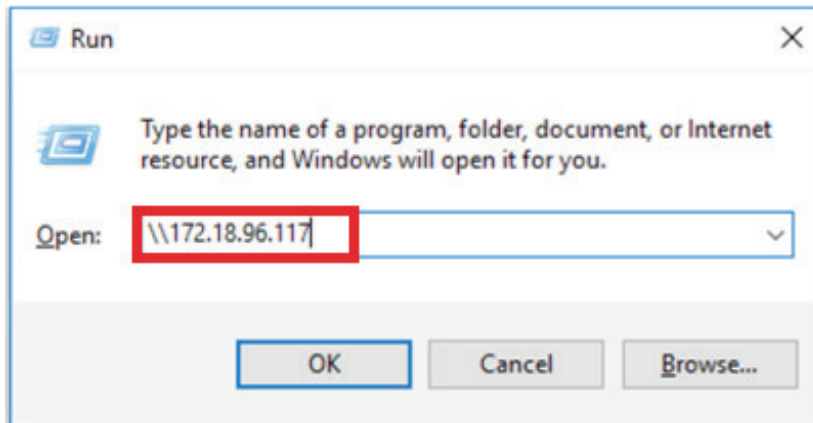

Key in the user name and password then click OK.

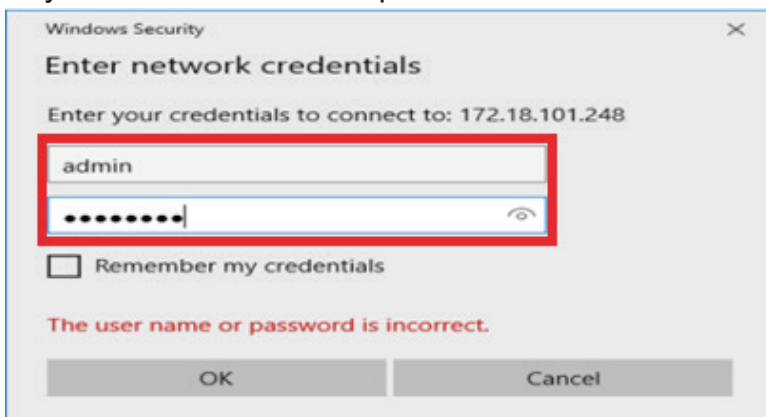

After login success, IFP files will be shown.

> Network > .172.18.96.117 > share

Name	Date modified	Type
asec		File folder
obb		File folder
sdcard	11/6/2017 5:15 AM	File folder
secure		File folder
shell		File folder

- **Device:** Adjust default home page, wallpaper, HDMI out encryption, Burn-in Protection Interval.

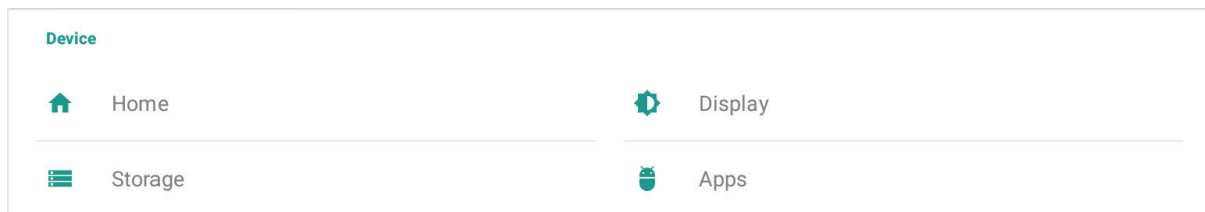

Home

User can set to different home app.

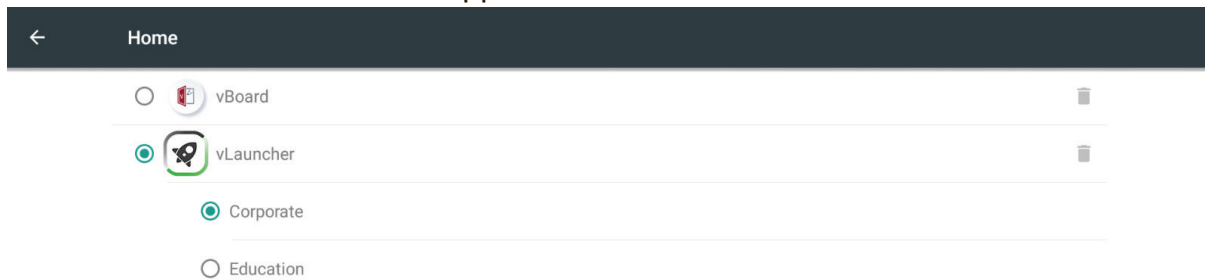

Note: vBoard and vLauncher can't be removed.

Display

User can set wallpaper, HDMI out encryption and burn-in protection interval.

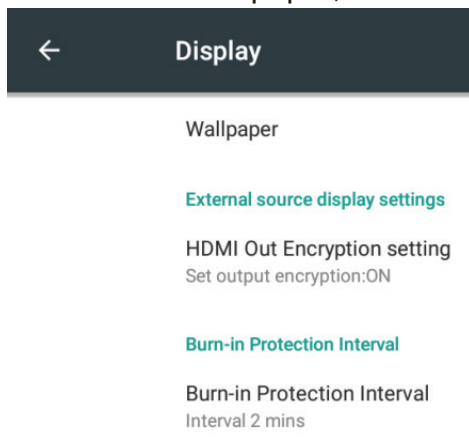

Wallpaper: User can click default image to change the wallpaper directly.

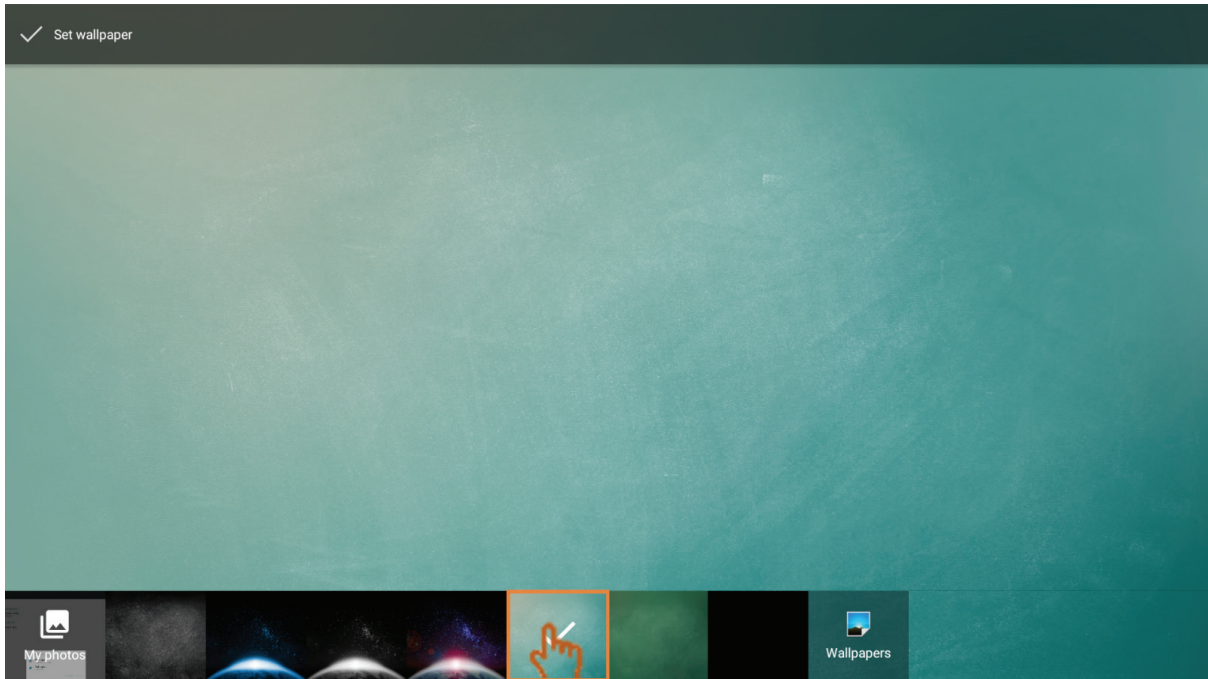

User also can click my photo icon to select the file that user wanted.

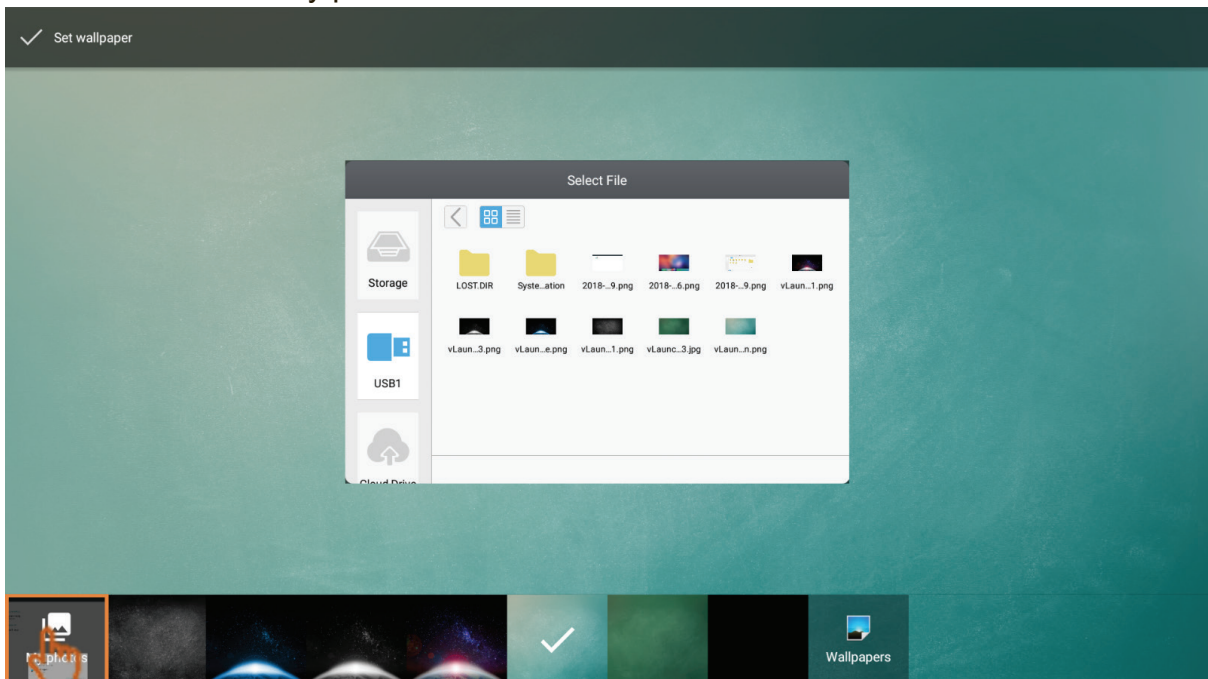

HDMI Out Encryption setting: User can set ON for HDMI signal out or set OFF for DVI signal out.

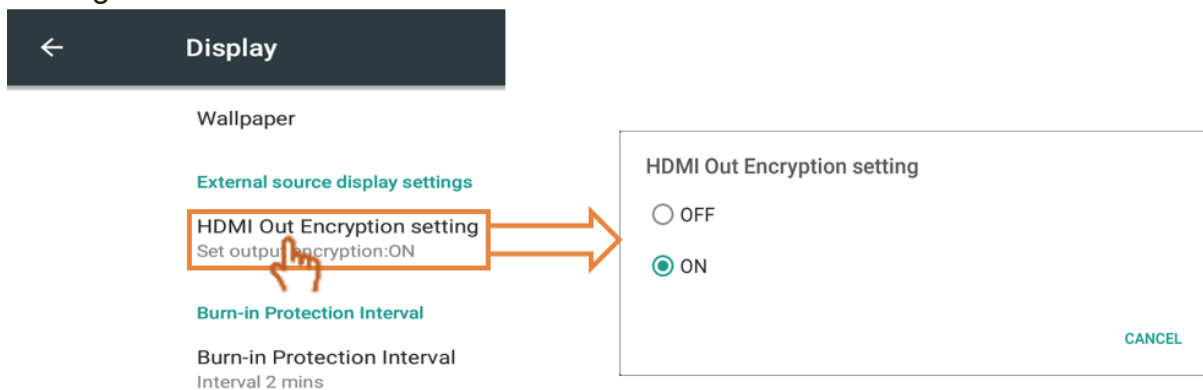

Burn-in Protection Interval: The Burn-in Protection Interval setting allows you to programme the time between movements of the picture in minutes.

Note: The burn-in protection function that in OSD screen setting must enable first.

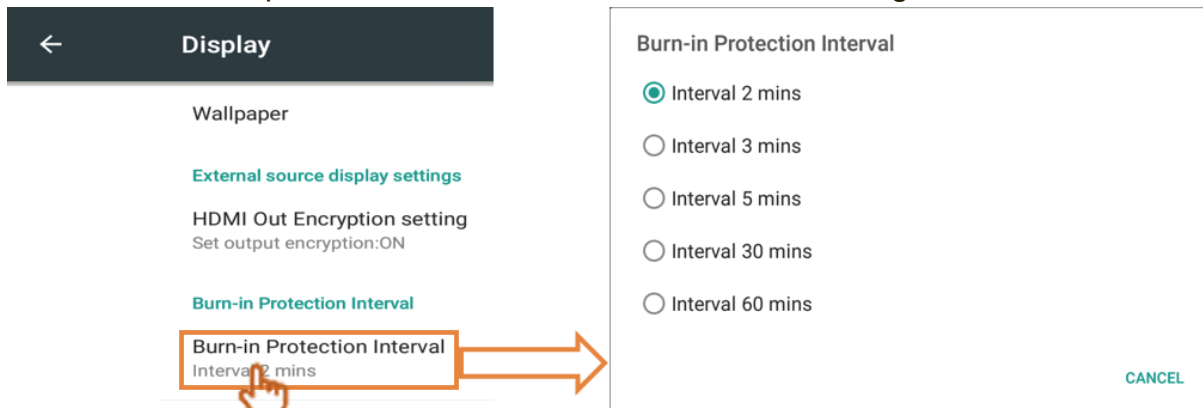

Storage: Click to check the storage status.

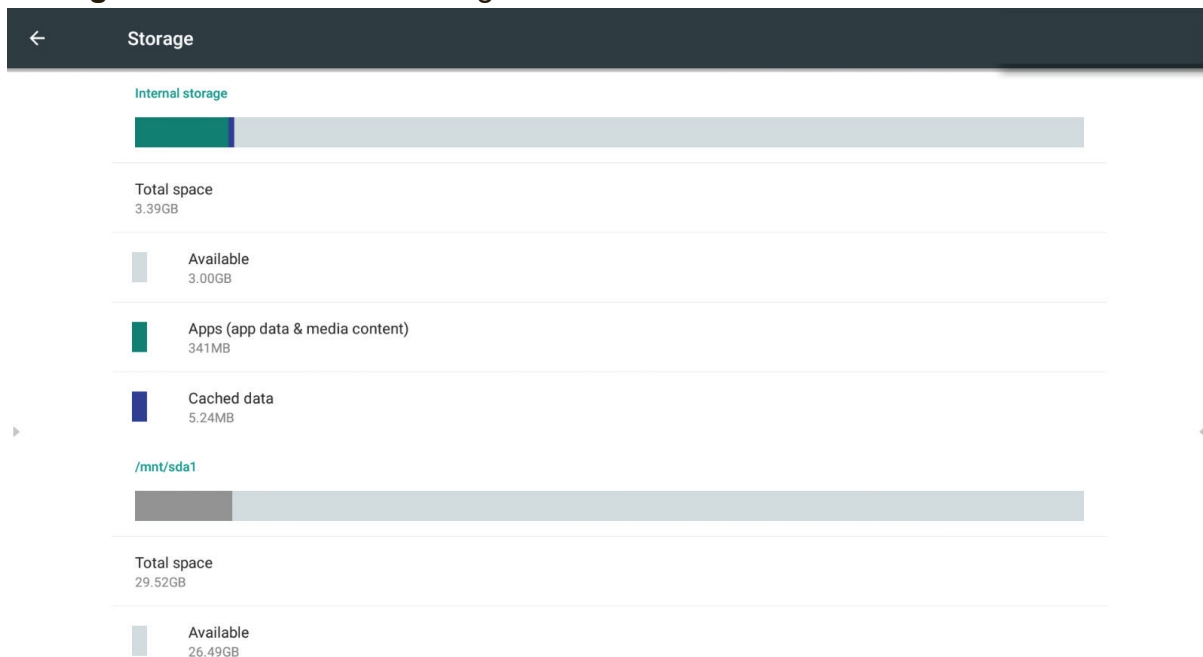

Click right upper icon to open USB computer connection settings.

Media device (MTP): Let user transfers media files on Windows, or using player file transfer on Mac.

Camera (PTP): Let user transfers photos using camera software, and transfer any files on computers that don't support MTP



Apps

User can see the apps information and to force stop, uninstall, move to USB storage, clear data, clear cache and clear defaults.

Note: Build in apps can't be uninstalled.

Not all apps support move to USB storage feature.

Not all apps support clear defaults.

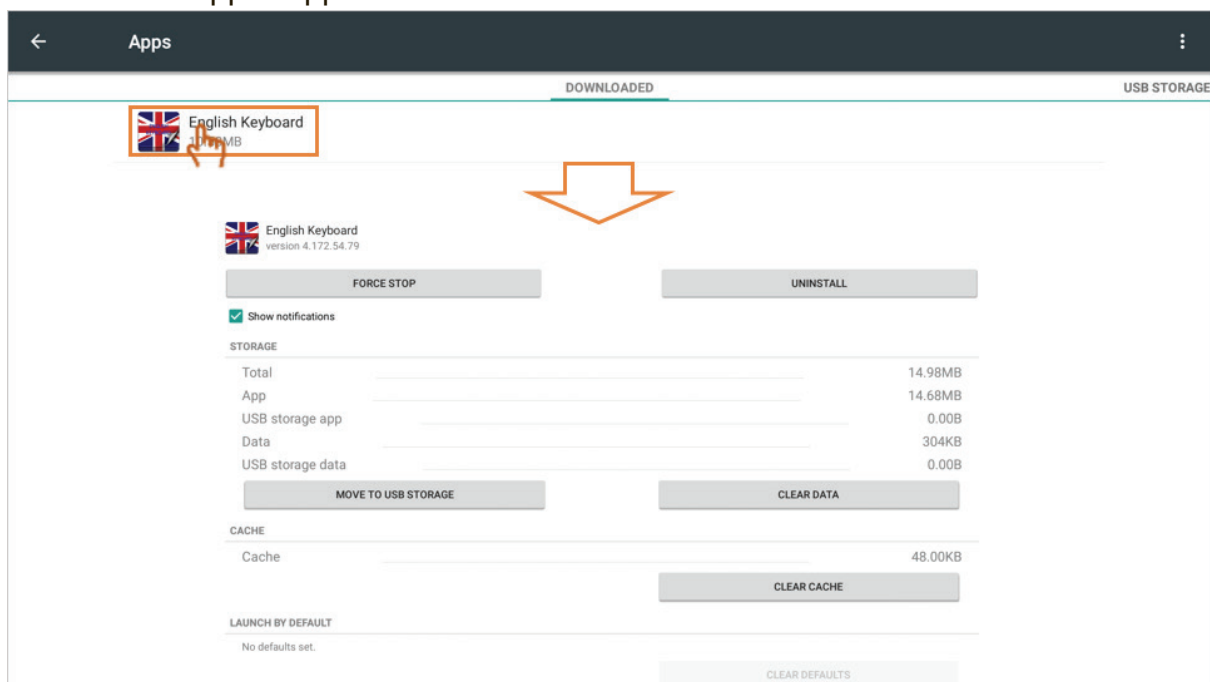

Click right upper icon to sort apps by size, by name and reset app preferences.

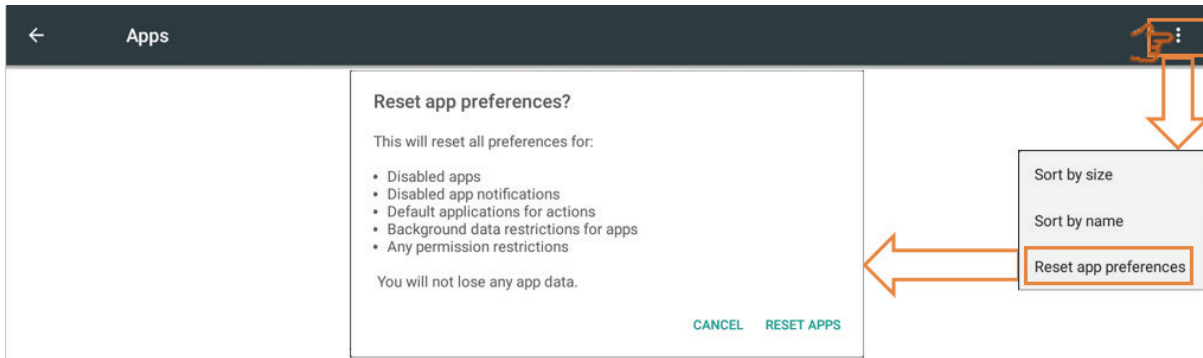

- **Personal:** The group include security, language & input, startup and shutdown, password, input setting and other settings.

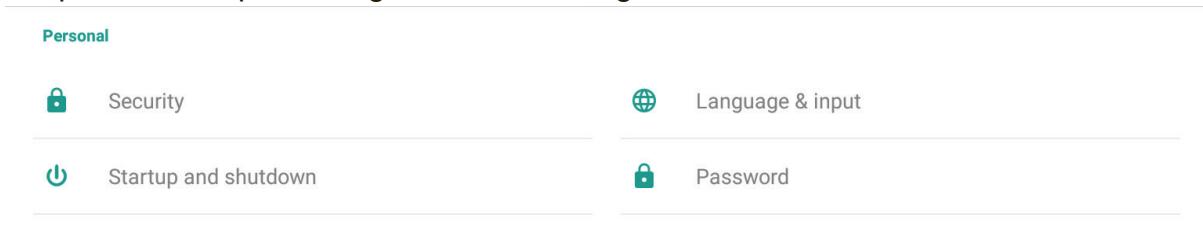

Security

Trusted credentials: Click to show all CA credentials that IFP has install.

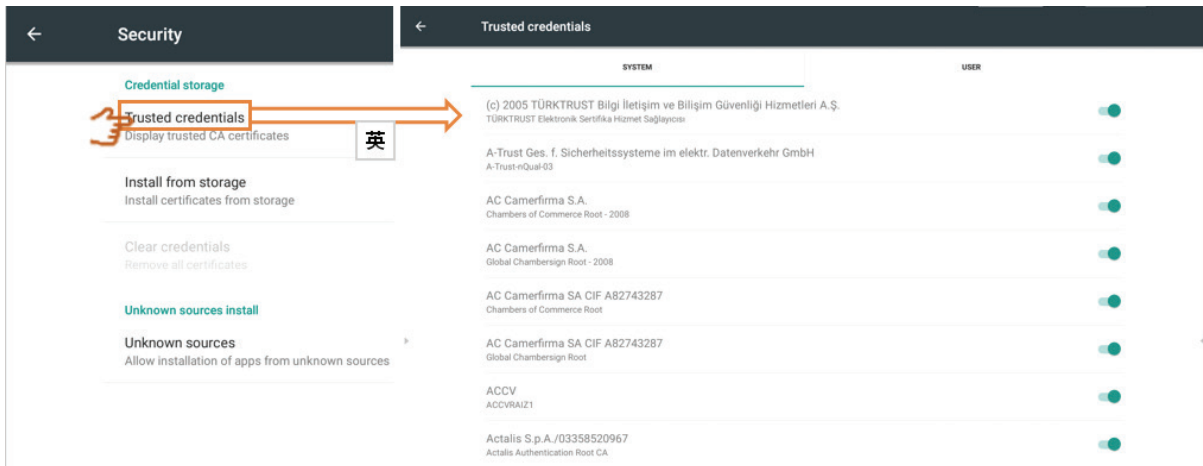

Install from storage: Click to install needed credentials from internal storage or USB drive.

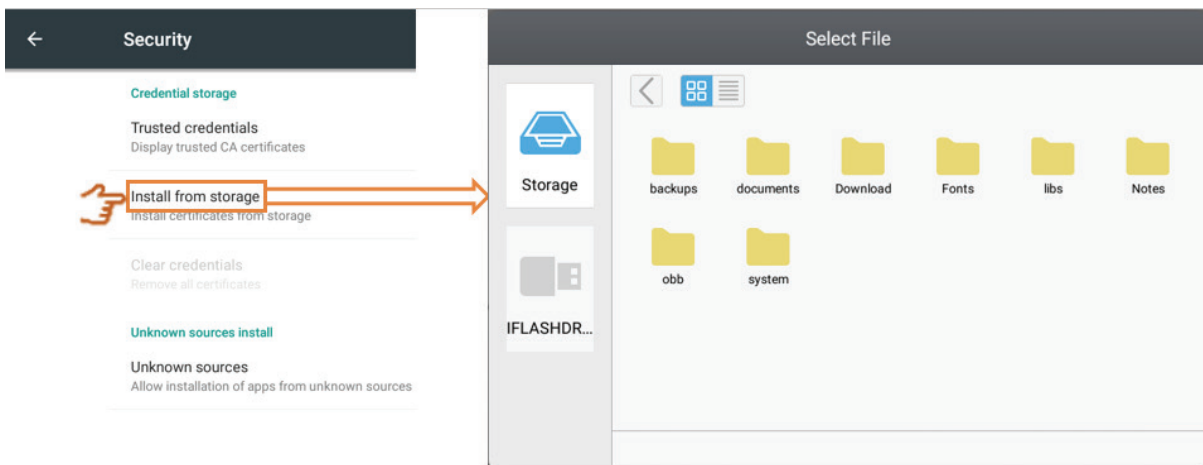

Clear credentials: Click to clear installed credentials.
Note: The preloaded credentials can't be clear.

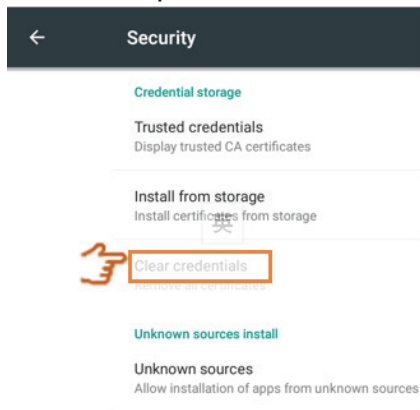

Unknown sources: Click to enable unknown source function.
Note: User needs to enable unknown source function before install apps.
No guarantee all APK compatible.

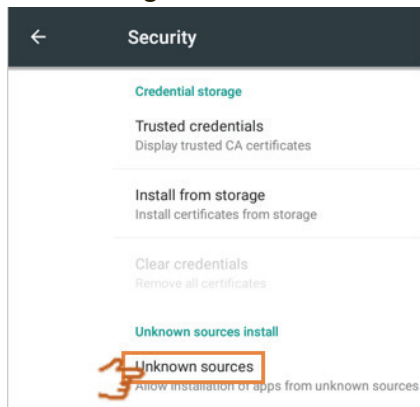

Language & inputs: Adjust language and input method of Embedded Player.
Language: Click to select language.

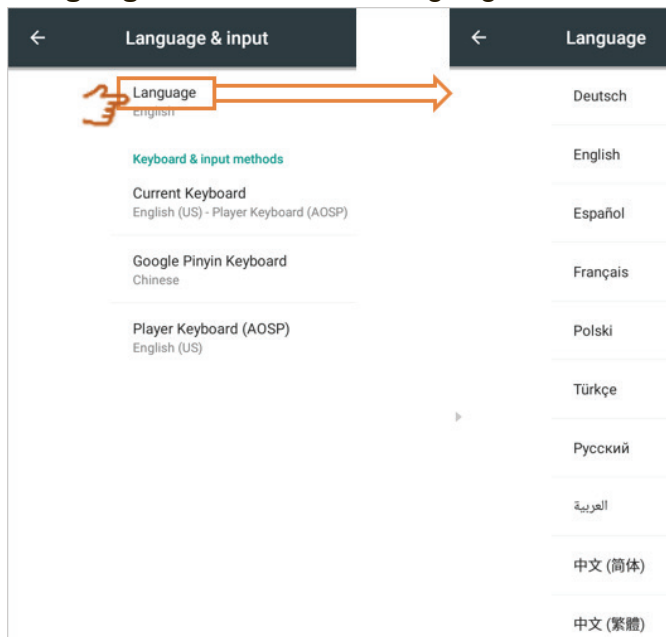

Current Keyboard: Click to enable/disable visual keyboard or change default input method.

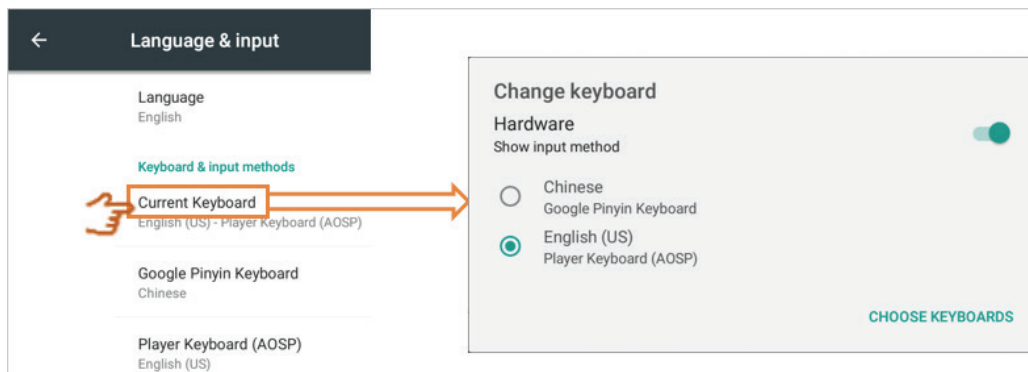

Existing keyboard: Click to entry advanced settings.

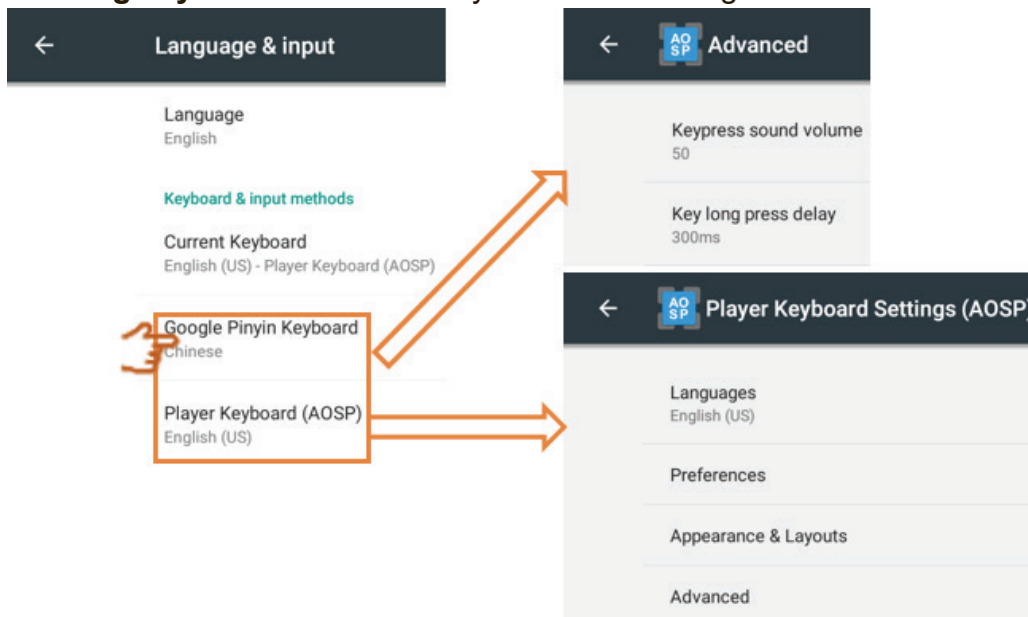

- **Startup and shutdown:** Set the Startup channel, Standby Mode, Black screen after startup and On/Off timer.

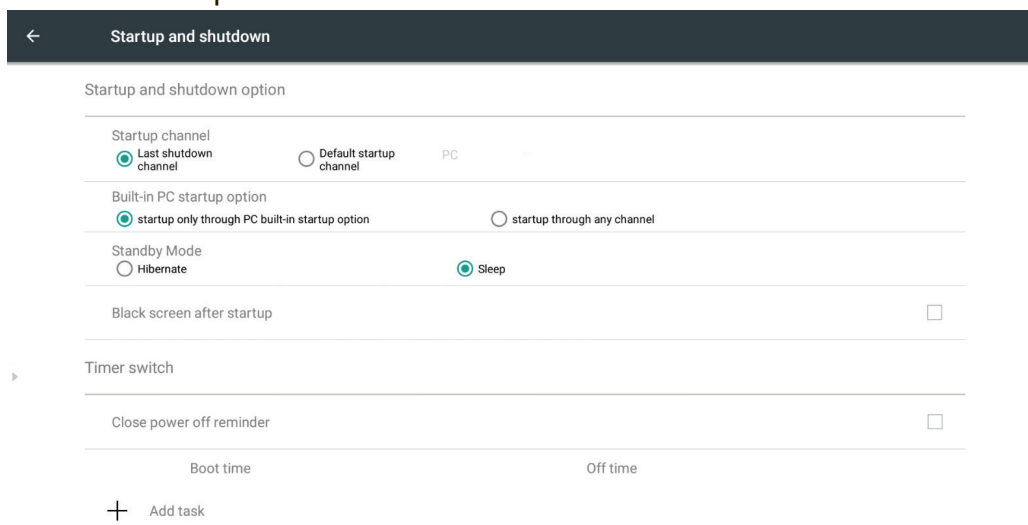

Startup channel: Click to change startup channel method.

Startup channel

Last shutdown channel

Default startup channel

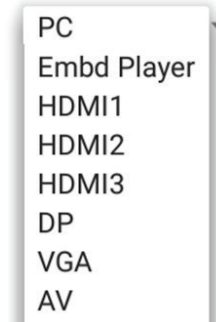

Built-in PC startup option: Click to change built-in PC startup method.

Built-in PC startup option

startup only through PC built-in startup option

startup through any channel

Standby mode: Click to change standby mode.

Hibernate: To press power button or set power off to turn off IFP, IFP will turn off all systems.

Sleep: To press power button or set power off to turn off IFP, IFP will turn off backlight and system still running. If user wants to use LAN RS232 and HDMI CEC function, the mode can support power on function.

How to enable sleep mode:

1. User needs to provide IFP S/N to ViewSonic. The S/N label is located near I/O side.

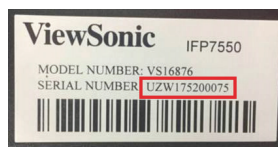

2. ViewSonic will provide the KEY (FakePowerOff) file to user.

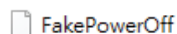

3. After getting the KEY file, copy the file to USB drive root.
4. Insert the USB drive to the USB port of IFP. (The KEY file MUST match the IFP S/N).
5. Select Sleep.

Note: User does not need to restart the system.

If user sets the Standby Mode to Hibernate then set to Sleep again, user needs to do step 3 to 5 again.

The KEY file must be paired with the specific S/N which is provided by user as request.

Reminder: When Sleep mode is enabled, the system is still running on standby.

For energy-saving and product reliability assurance, please only enable Sleep mode when it is necessary to do so.

Standby Mode

Hibernate

Sleep

Black screen after startup: When the function is enable, IFP will turn off backlight automatically after boot time schedule.

Black screen after startup



Close power off reminder: When the function is enable, IFP will turn off directory without any reminder after off time schedule.

Touch swipe to adjust the value and select day then click ✓ to save.

Close power off reminder



On/off timer:

Click + to add a schedule.

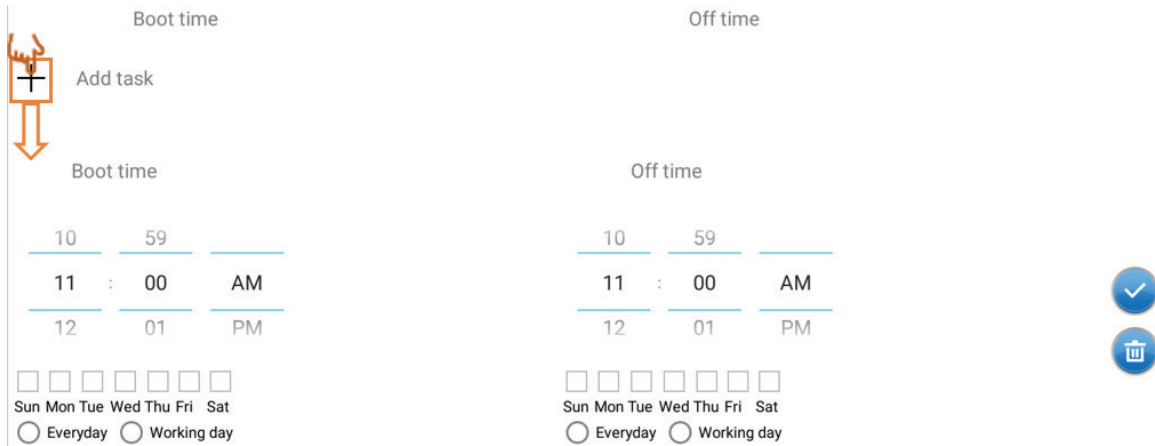

Touch swipe to adjust the value and select day then click □ to save.

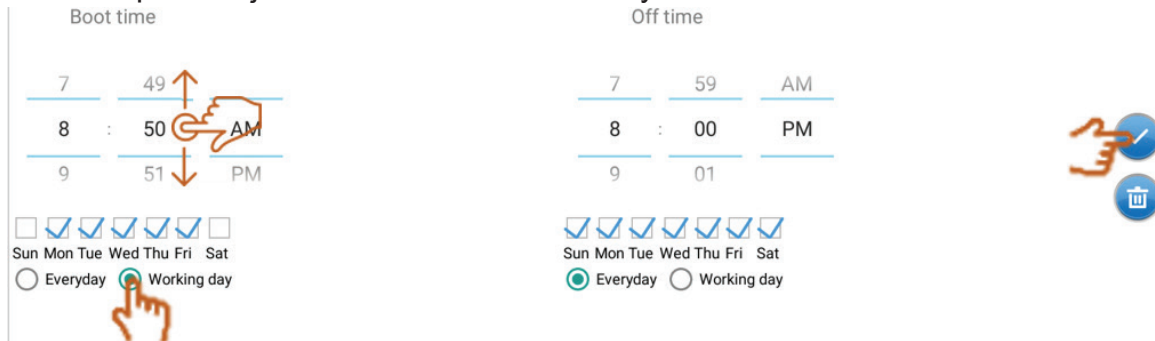

- **Password:** Click to set the screen lock password then click OK to save.

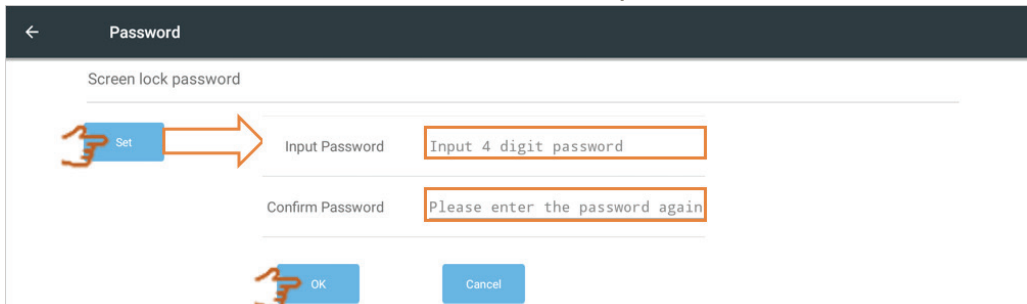

- **Input setting:** To enable/disable and edit input alias. To enable/disable Wake On Active Source, Channel auto switch, Auto search and set No signal power off timer.

Input alias switch: Click to enable then user can edit input alias.



Wake on active source: When the function enable, IFP will detect HDMI and VGA signal in standby mode. If HDMI or VGA has signal output, IFP will power on automatically.

Note: Only HDMI and VGA ports support the function.

Auto search: When the function enable and existing source has no signal, IFP will search input source automatically one time.

Channel auto switch: When the function enable and IFP detect new signal input, IFP will switch input source automatically.

No signal power off: Click to adjust no signal power off timer.

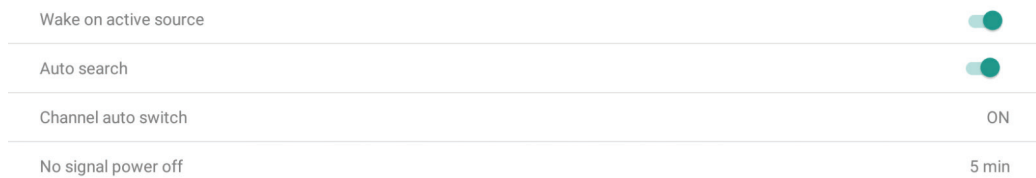

- **Other settings:** To set vPen, Side Tool Bar channel setting, and vBoard Lite writing setting.
vPen channel setting: Click to set vPen available channel.
Side toolbar channel setting: Click to set side toolbar available channel.
vBoard Lite writing: Click to change the vBoard Lite touch function for single or multi finger.

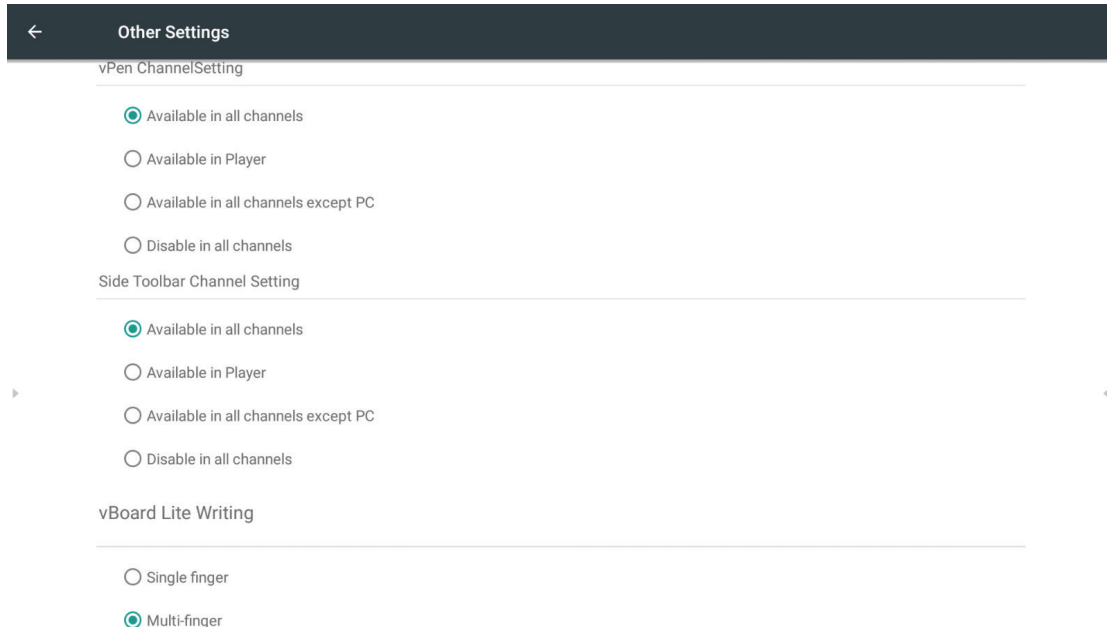

- **Date & time:** Set the system time and format.
Automatic date & time: When the function enable, IFP will synchronize date and time with Internet.
Note: The Ethernet or WiFi connection needed.

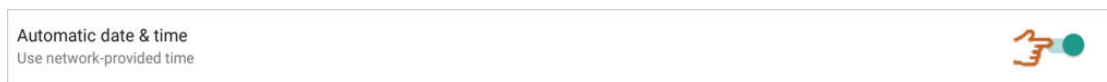

Set date: Touch swipe to adjust the value then click OK to save.

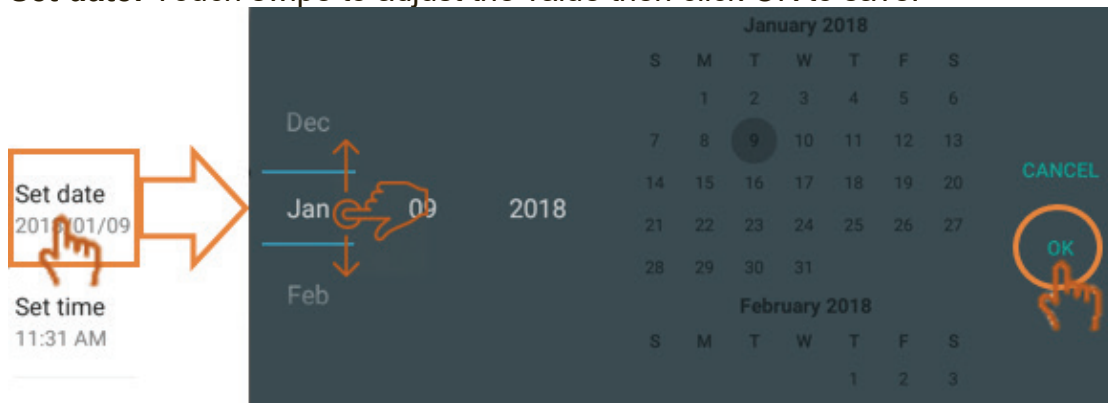

Set time: Touch swipe to adjust the value then click OK to save.

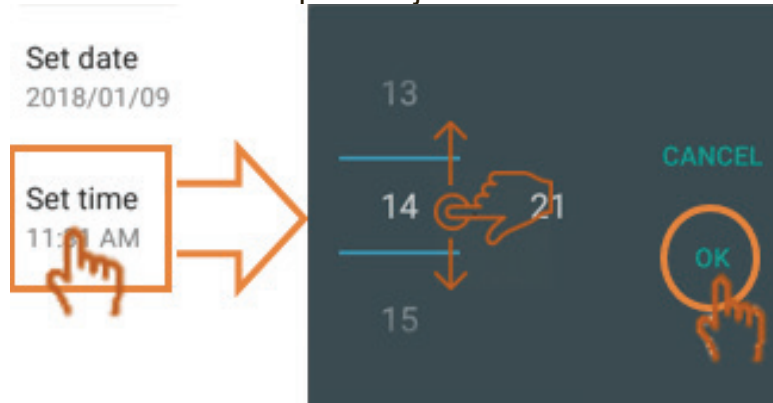

Select time zone: Click to select different time zone.



Select time format: Click to select different time format.



Choose date format: Click to choose different date format.

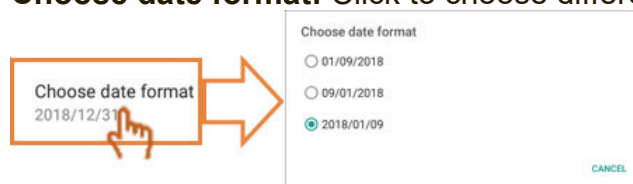

- **Device information:** Display Embedded Player information, system updates and display ID setting.
System update: Click to upgrade firmware via OTA.

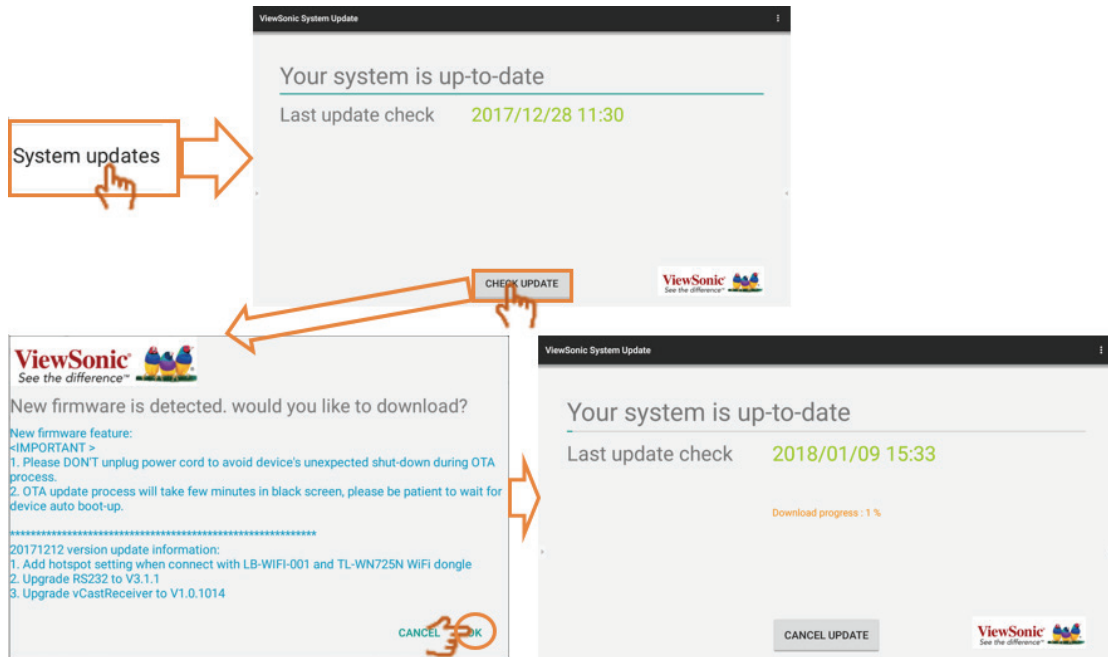

Legal information: Click to check the open source licenses

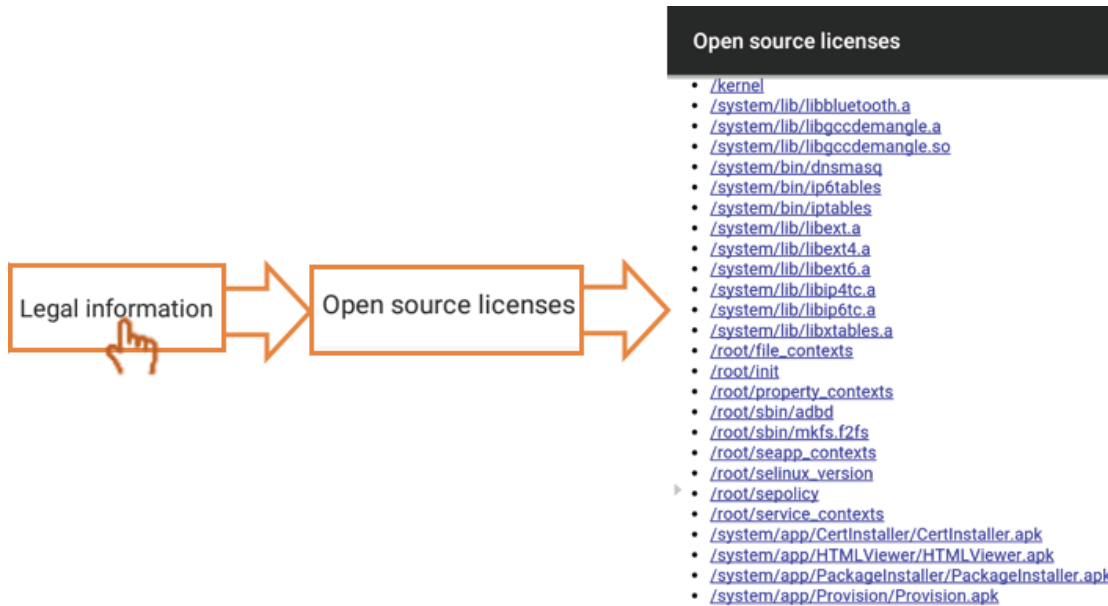

Display ID: Click to change display ID then click OK to save.

Note: The display ID is for RS232 uses.
The display ID range is 01~98.

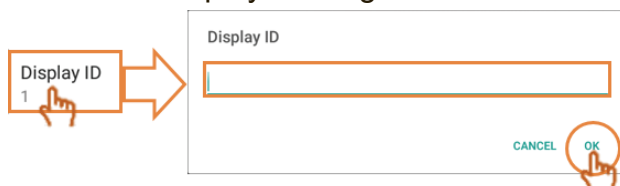

5. ViewBoard Embedded Application and Setting

5.1 Embedded Digital Whiteboard App

Within ViewBoard, Viewsonic offers two version of the embedded digital whiteboard app for users to choose and annotate.

5.1.1 vBoard

vBoard user interface:

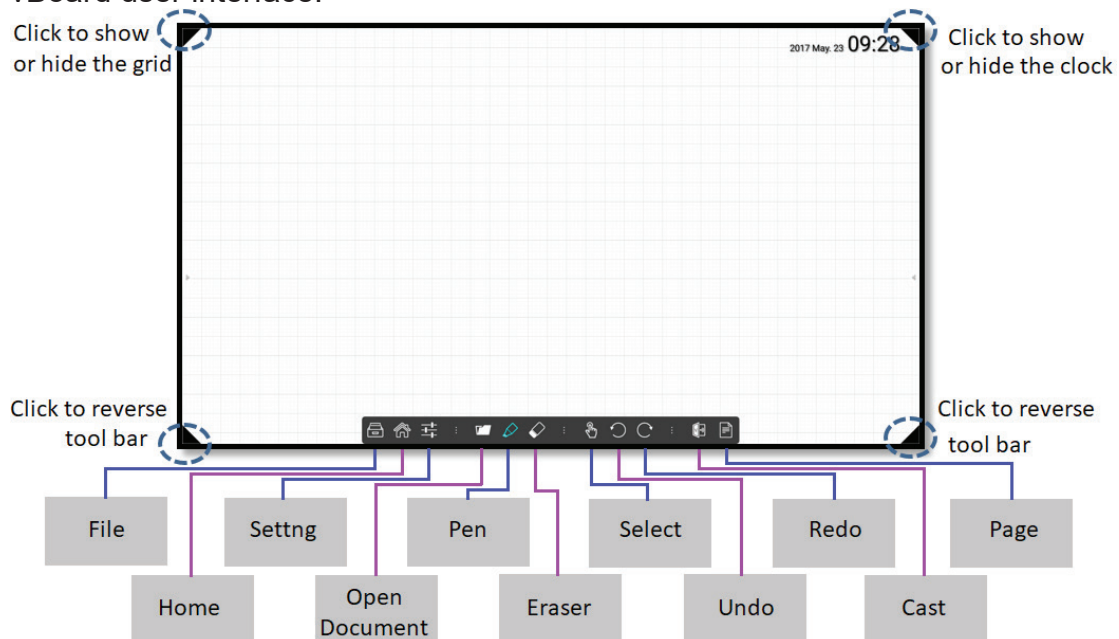

- Click  to open up the setting window.



(1) Brightness adjustment



(2) Background color adjustment



(3) Volume adjustment



(4) More setting option: Quick link to the embedded player setting, vBoard supports 10-point writing by default user could go the setting mode and switch back to single point writing.

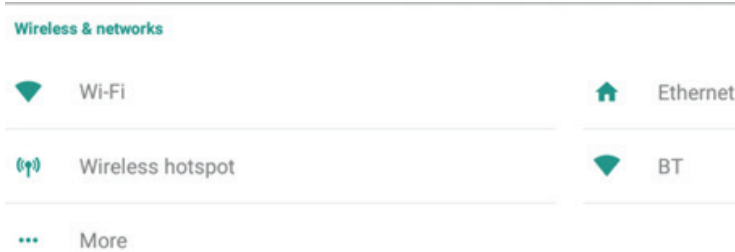

(5) Information “about” this vBoard.

- Pen: click  to open more pen option.

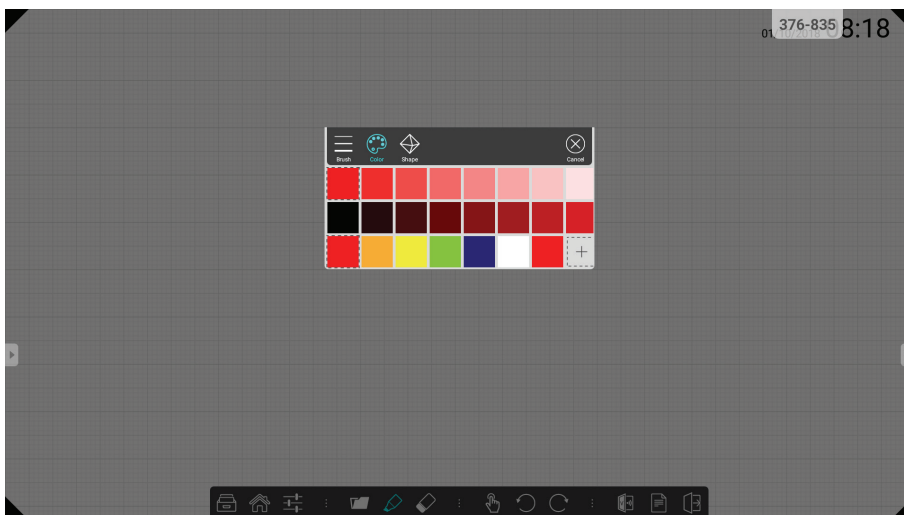

Select pen thickness and type



Change pen color



Tool to draw line and different shapes



- Open Document: click  to open document and content files

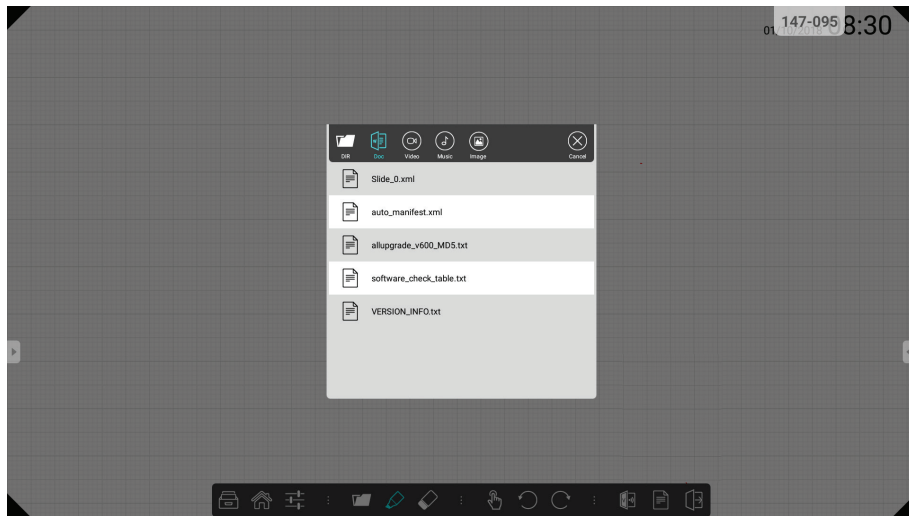

Click to view document directory



Select document in vBoard format



Import video into vBoard



Import audio into vBoard



Import image file into vBoard

- Page: click  to conduct page management

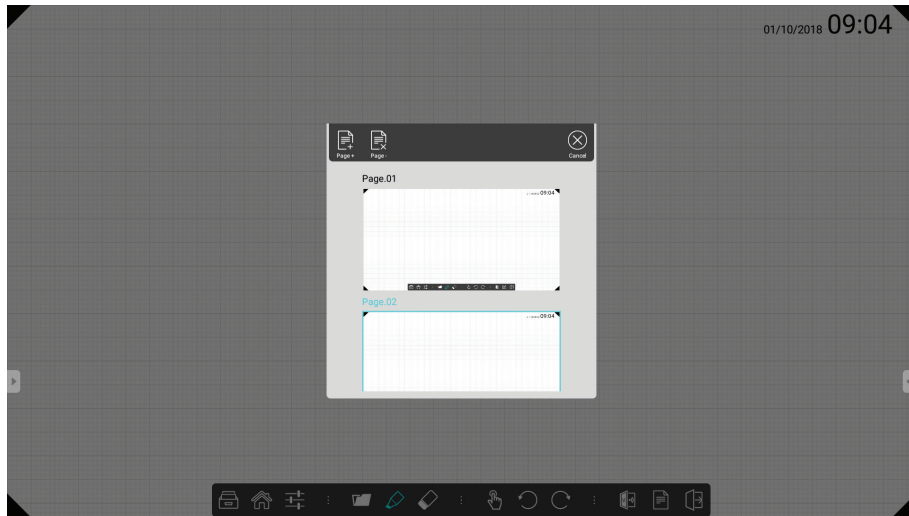

Click to add one more page



Click to delete one page









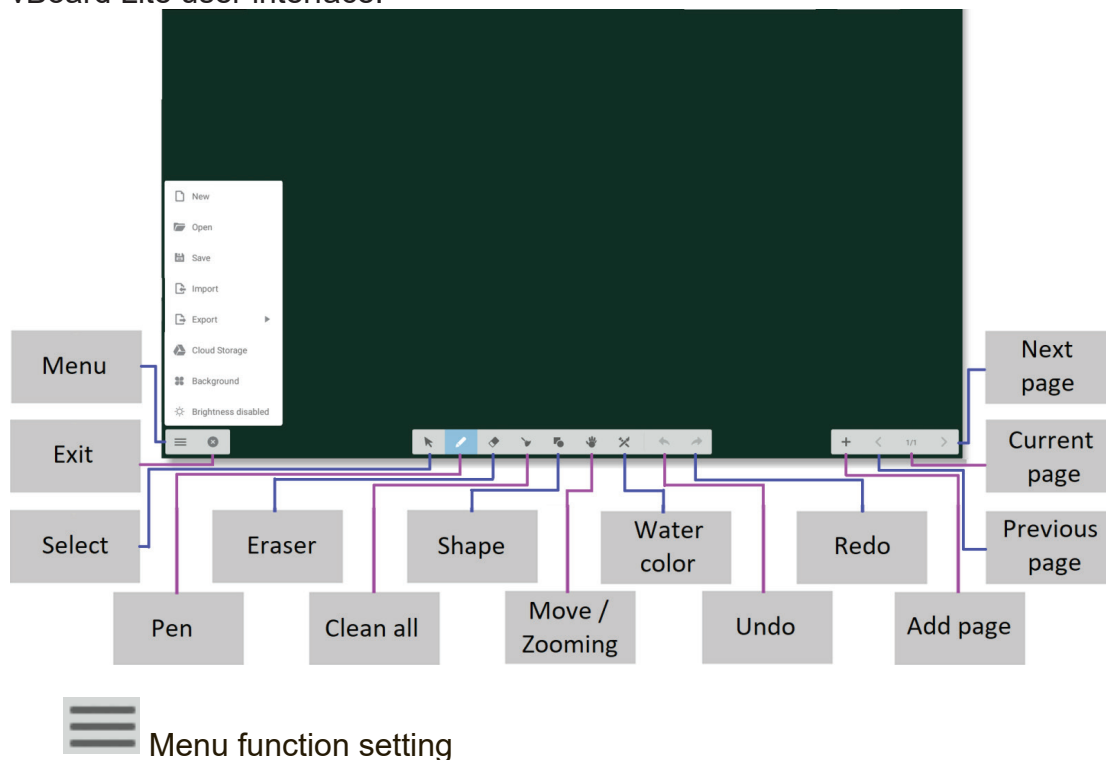









Click the page to move to

5.1.2 vBoard Lite

vBoard Lite user interface:









 New	 New	Click to create new file
 Open	 Open	Click to open *.enb format file
 Save	 Import	Click to import *.jpg format file
 Import	 Save	Click to save current content to *.enb format
 Export	 Export	Click to export current content
 Cloud Storage	 Cloudy Storage	Click to upload the current image to cloud storage.
 Background	 Back-ground	Click to change background
 Brightness disabled	 Auto bright-ness	Click to enable/disable auto brightness

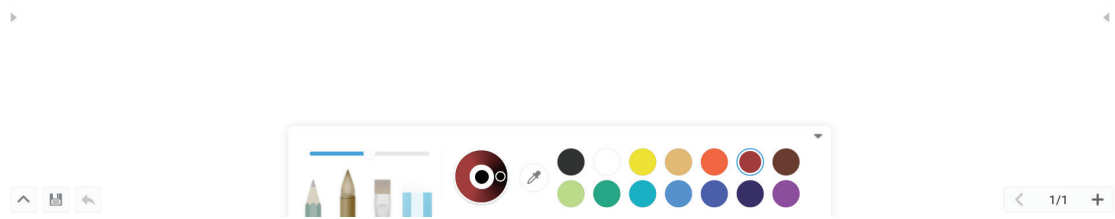

Watercolor – another annotation tool option within vBoard lite

Watercolor



Item	Description
 Pen	Click to select different type Note: In pen mode, it supports up to 10 points for writing
 Thickness	Click to change thickness
 Palette	Select color then press and rotate the circle on palette to adjust color
 Dipper	Click dipper to dip up color for pen
 Color disc	Click to change pen color

5.2 ViewBoard Cast

ViewBoard Cast is the built-in wireless screen sharing receiver app within ViewBoard that allow users to cast in their presentation content, including mirroring screen content, images, videos, and audios. Before use ViewBoard Cast function, please be noted that proper network infrastructure setting is required.

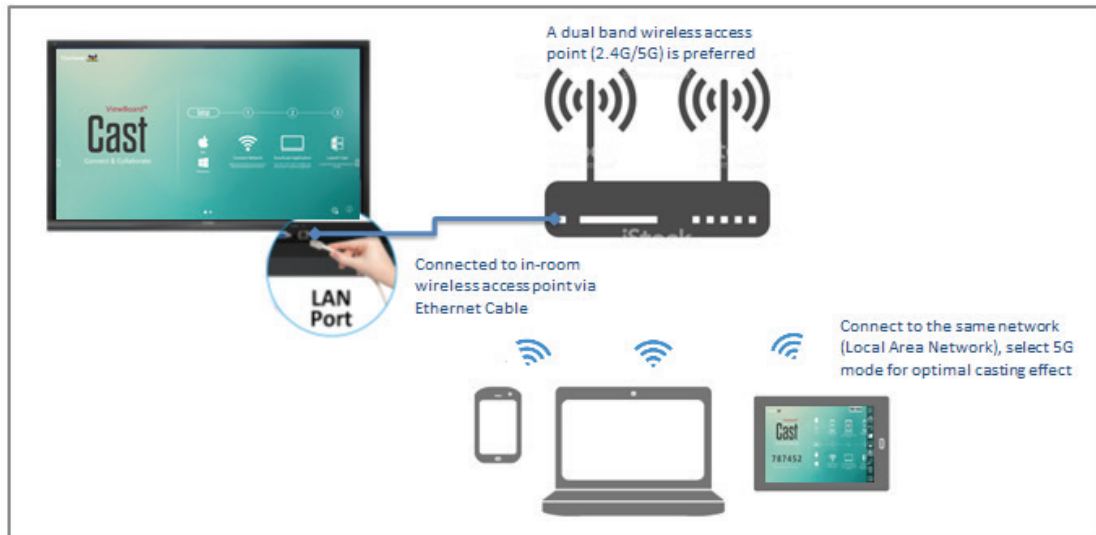

ViewBoard Cast is the wireless peer to peer data communication so that a proper ports setting is required.

Ports:

- TCP: 56789, 25123, 8121, and 8000 ports
- UDP: 48689, 25123

Port for activation:

- Port: 8001

[Remark] please be noted that screen sharing or video casting in/out is highly dependant on the each school's or corporate's IT network configuration and WiFi network bandwidth. The variation might be cause from internal network speed, routing, WiFi configuration, and QoS setting. Please consult your IT for related details.

5.2.1 Cast sender from Windows-based devices, Macbook, and Chrome devices

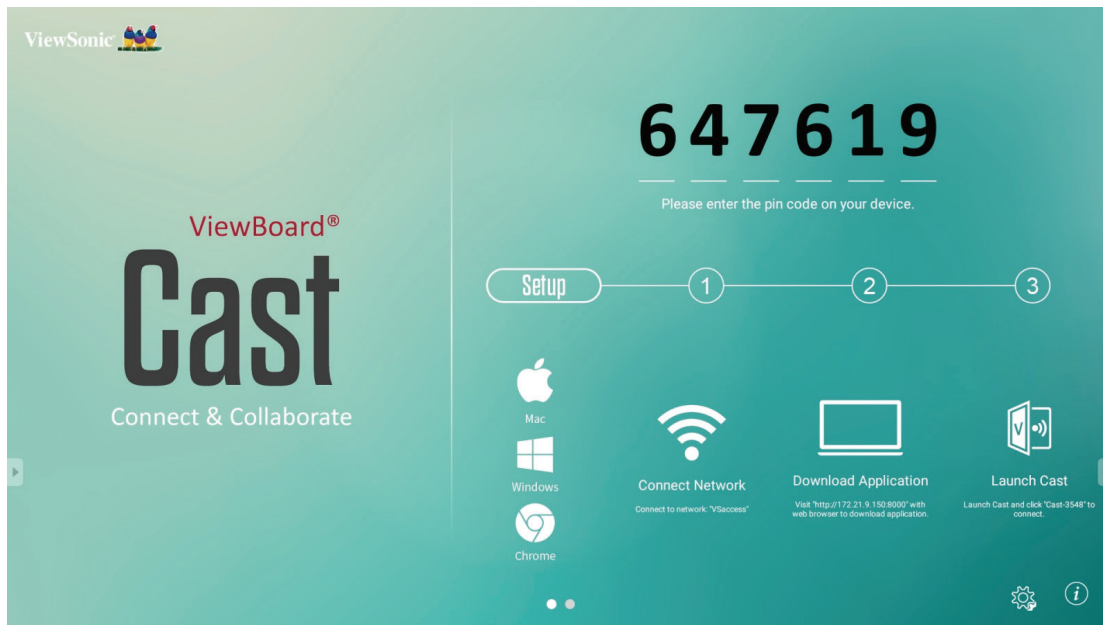

Mac, Windows and Chrome devices

1. Make sure your device is connected to the same network with IFP.
2. Visit the address that shown on IFP to download application.
3. Launch ViewBoard Cast and click the icon number that shown on IFP.

5.2.2 Viewboard Cast sender from mobile devices: iOS-based (iPhone, iPad) and Android OS based phone/tablet



iOS

Step 1: Make sure your device is connected to the same network with IFP.

Step 2: Enter password that shown on IFP.

Step 3: Slide up at the bottom enter the quick set Open AirPlay.

Step 4: Select the device, then the iOS operate interface will appear.

Android

Step 1: Make sure your device is connected to the same network with IFP.







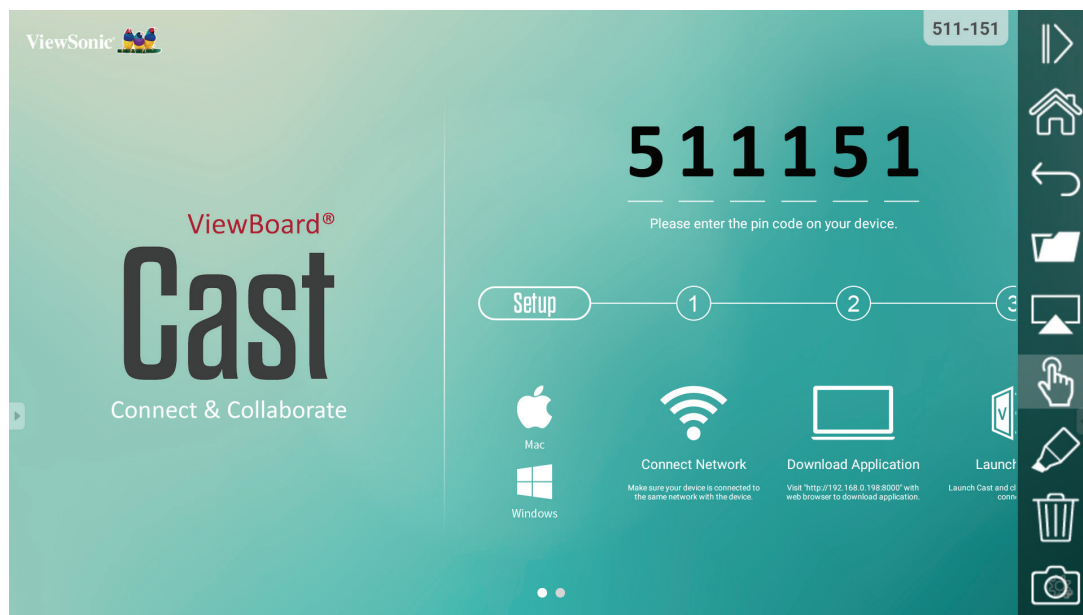

Step 2: Enter password that shown on IFP.

Step 3: Scan the QR code that shown on IFP to download the client.

Step 4: Open the ViewBoard Cast client.

5.2.3 ViewBoard Cast out from mobile device will support annotation function



Item		Description
	Toggle	Click to hide or display tool bar
	Home	Click to return to home interface
	Return	Click to return to previous operation interface
	Folder	Click to view or open mobile device internal file
	Screen sharing	Click to share screen (Android 5.0 above supported)
	Touch	Click to change to touch mode
	Pen	Click to make annotation in the picture Click to change color or thickness
	Clear	Click to clean all the elements
	Camera	Click to use camera then send the image to IFP50

5.3 Air Class

Display quiz questions on ViewBoard® and allow up to 30 mobile users to submit answers remotely. Whether deploying single or multiple choice questions, ViewBoard® will record statistic result for each device being used.

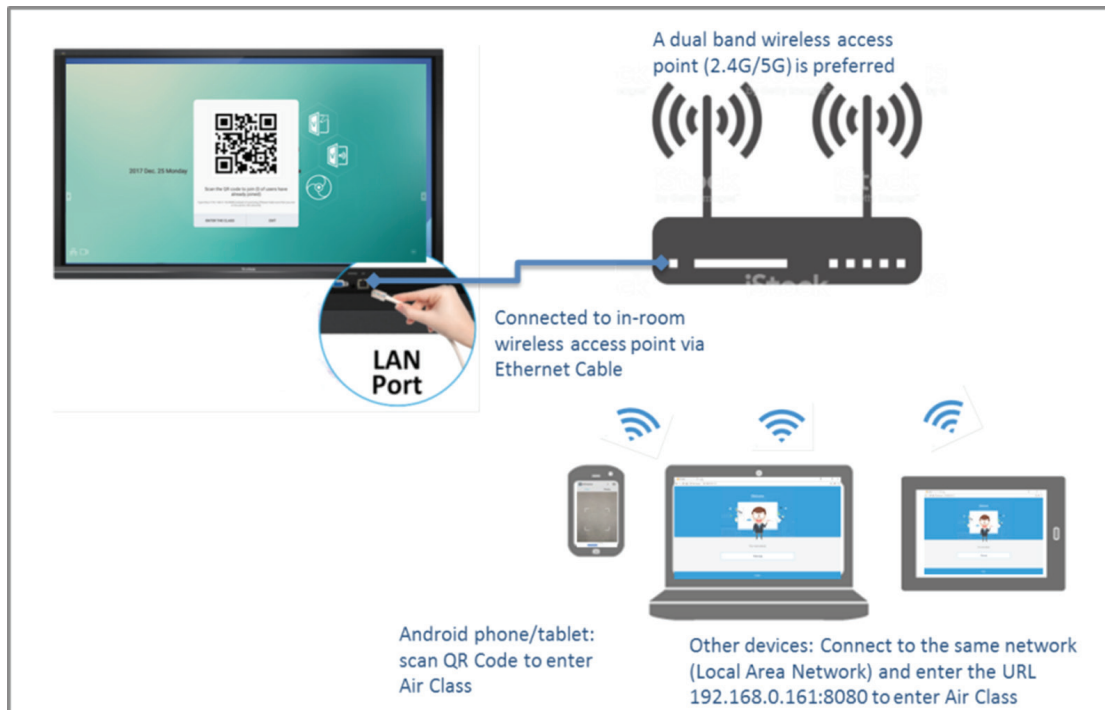

Network information

PC (Window/ Mac/ Chromebook) and tablet/ mobile (iOS/Android) devices, as well as ViewBoard® need to link to the same LAN network subnet.

Ports : TCP 8080

Click “Enter Air Class” on ViewBoard and select one interactive function to open up Air Class interface



Voter

Click  icon to enter Voter interface. Click “Single choice” or “Multiple choice” icon to define answer type.



Click BEGIN icon let participant starts answer.



After participant presses OK icon to done the answer, the IFP will show the participant's name on screen.

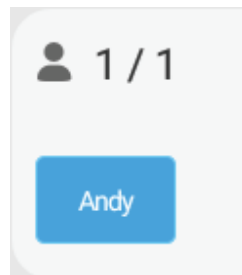

Click Finish icon to done the vote, then Answer statistics will be displayed.



Choose the right answer to show the correct rate.

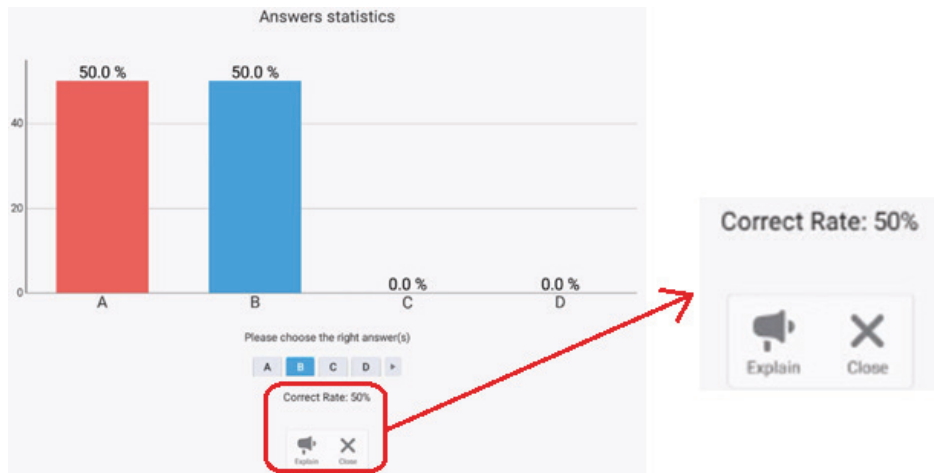

Click  icon to analyze.

$2 \times 3 =$

A. 7 B. 6 C. 9 D. 11

Answers statistics

Option	Percentage
A	50.0%
B	50.0%
C	0.0%
D	0.0%

Responder

Click 🥁 to enter Responder. Participant needs click OK icon to answer.

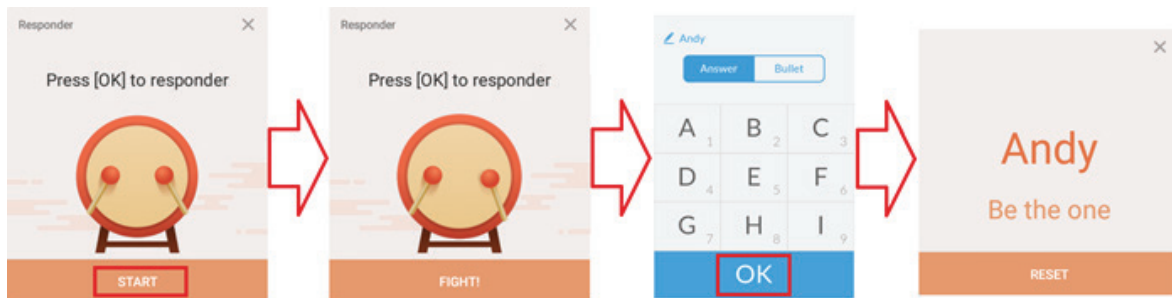

Message

Click 🗨️ to enable/disable message function.

Message operation

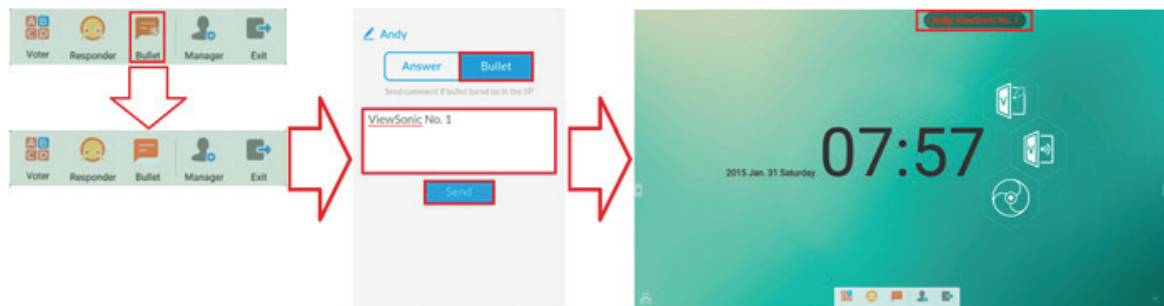

1. Click Message icon to enable the function.
2. Participant clicks Message icon the change to Message interface.
3. Participant key in message then click Send icon.
4. The message will appear on IFP50 upper side.

Manager

Click 👤 to appear QR code to let more participants join the class.

Exit

Click ➡️ to exit class interface.

5.4 Other default apps

Zoom

Click  to run Zoom application.

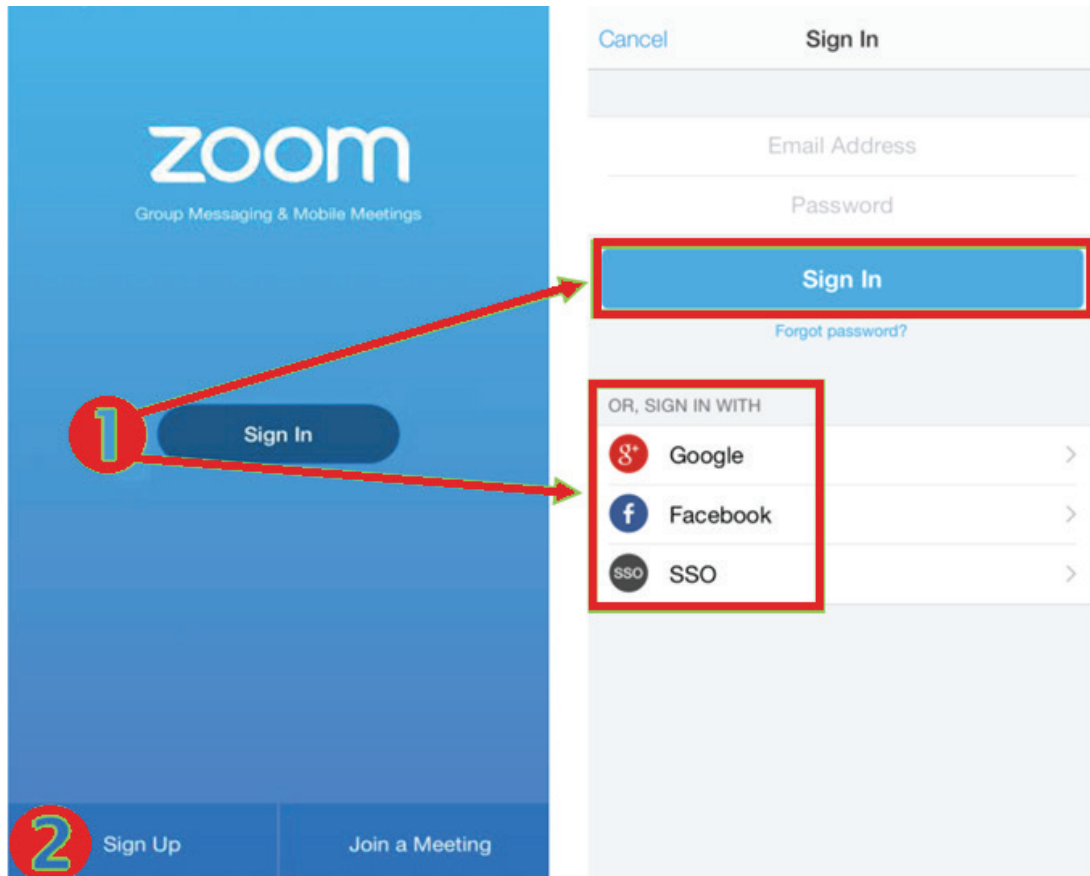

1. Click Sign In. Enter your email and password or sign in with your Google, Facebook or SSO account.
2. If you do not have a Zoom account, you should select Sign Up.

Join a Meeting

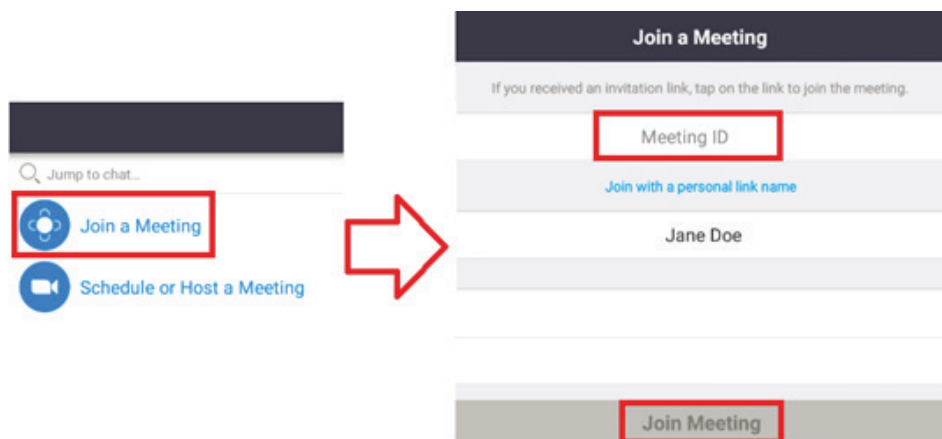

1. Select Join a Meeting.
2. Enter the Meeting ID of the meeting you want to join.
3. Click Join Meeting.

Start an Instant Meeting

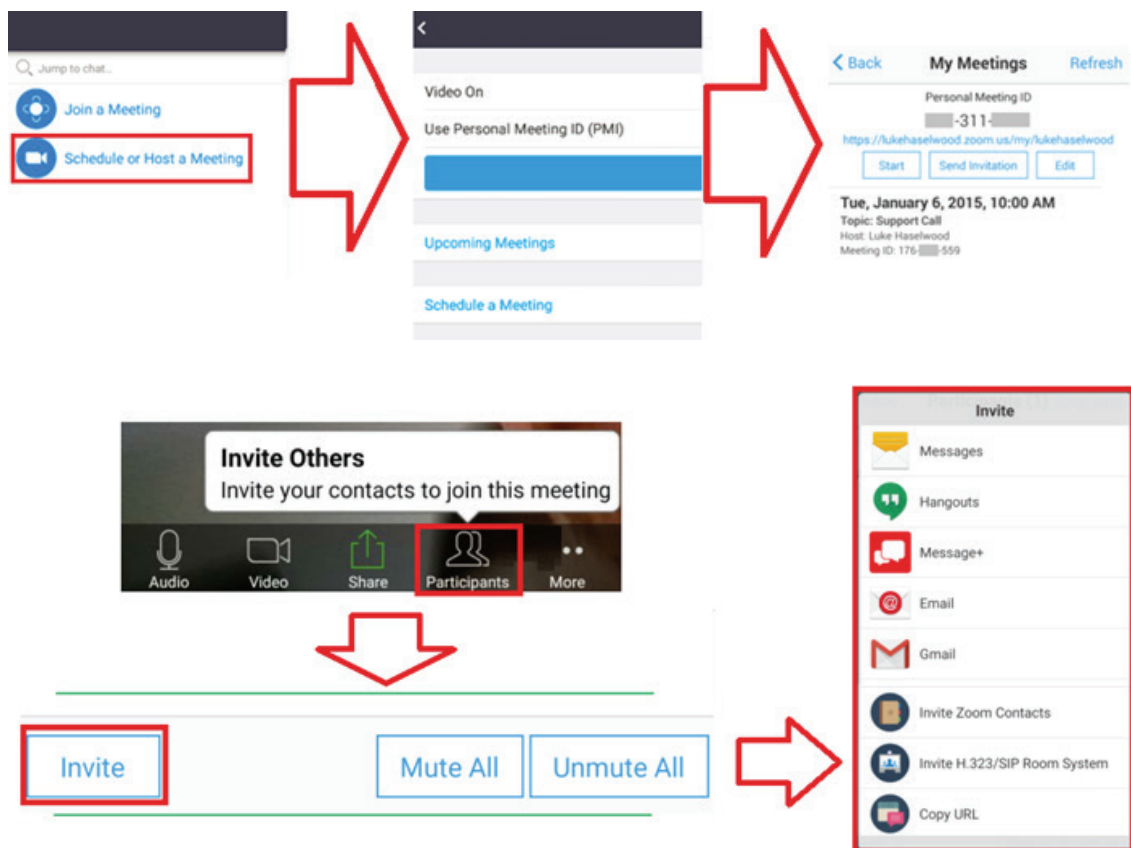





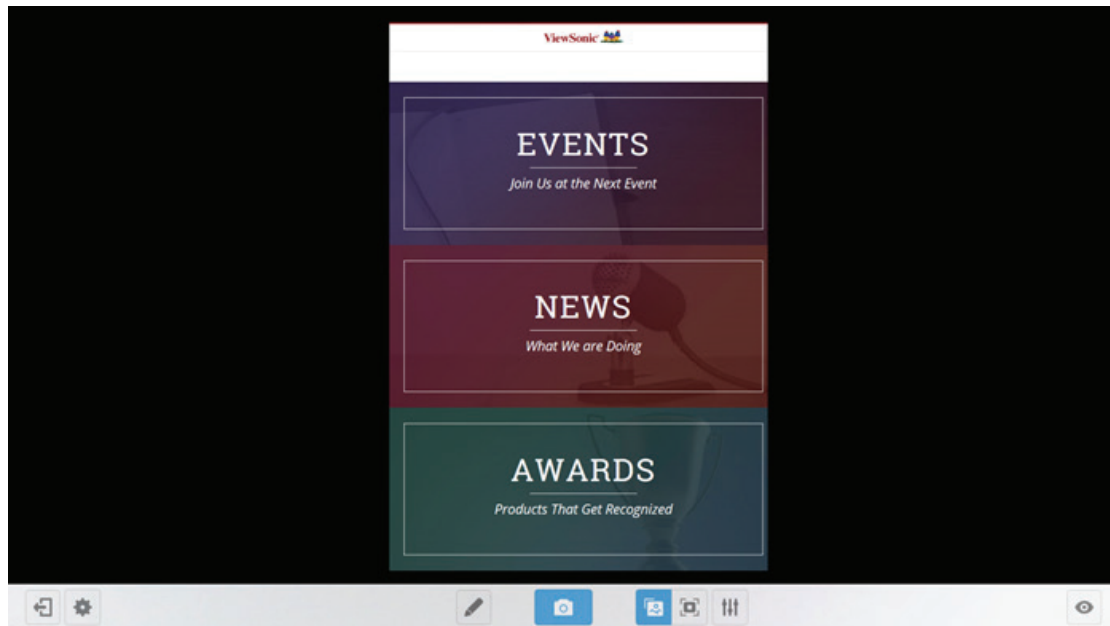

1. Select Schedule or Host a Meeting.
2. Choose the meeting options:
 - Choose to have Video On or off.
 - Choose to Use Personal Meeting ID or a unique meeting ID.
3. Click Start a Meeting.
4. Invite meeting participants by clicking the Participants icon at the bottom of the screen.
5. Click Invite at the bottom of the Participants screen.
6. Select the participants using the contact method you want to use for inviting participants.

Visualizer

Click  to run Visualizer application.





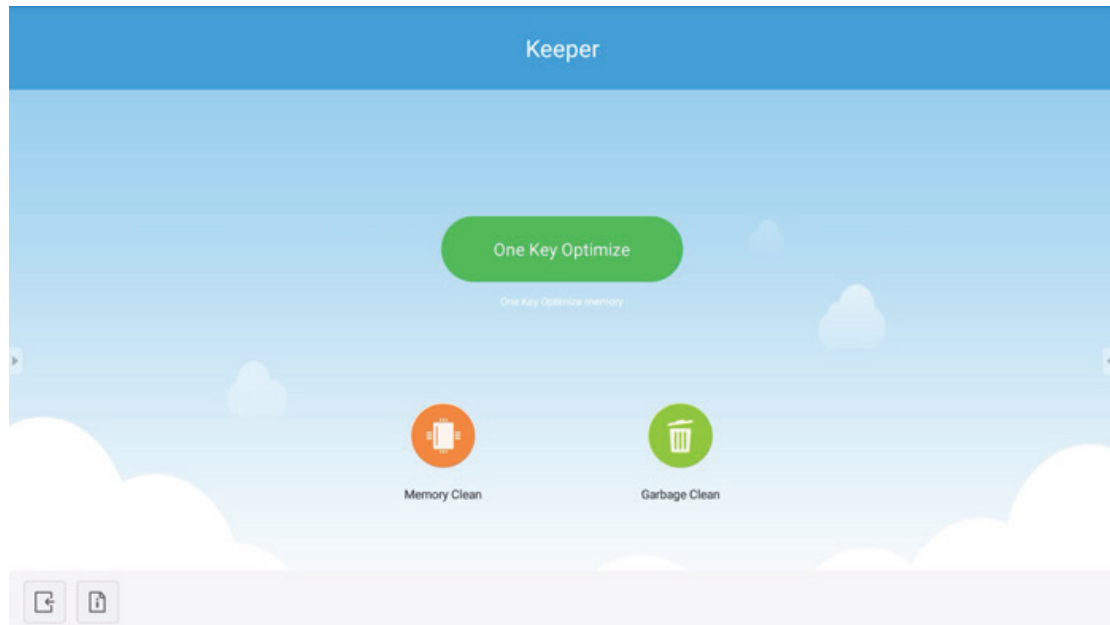

Item	Description
 Exit	Click to exit
 Resolution setting	Click to change camera resolution
 Pen	Click to make annotation in the picture
 Screen shot	Click to screen shot
 Adjustable mode	In this mode, user can use two fingers to zoon in/out and rotate the image
 Full screen	Click to show as full screen

Keeper

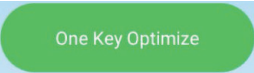
Click  to run Keeper application.



Item		Description
	One Key Optimize	Click to optimize the system, memory clean and garbage clean
	memory clean	Click to memory clean
	Garbage clean	Click to garbage clean
	Information	Click to check the system information
	Exit	Click to exit

Screen Lock

Click  to set screen lock password or enable screen lock.

Note: If user forgets the password, to press remote control INPUT 0214 fast to restore the password to default.

Set password

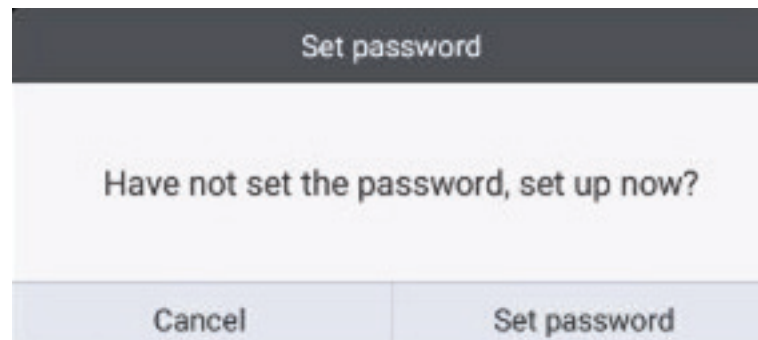

Screen lock enabled



Browser

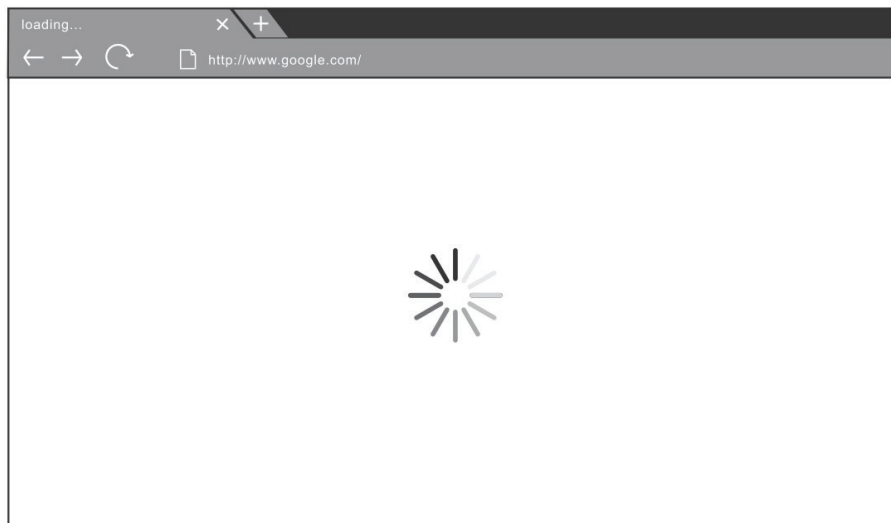



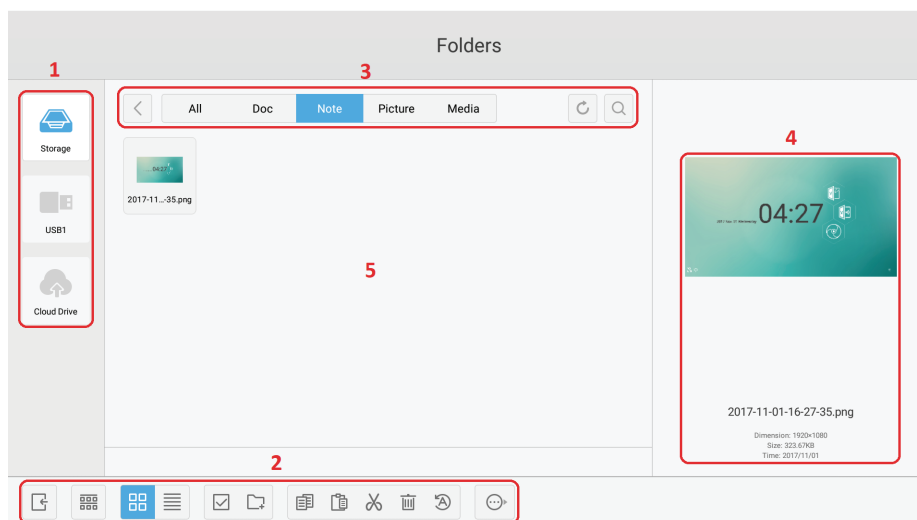

Enter web browser to surfing the internet.









Folders



1. Storage device display: Click with touching pen to enter corresponding storage devices area.

2. Icons:

Item	Description
 Exit	Click to exit.
 Sort	Click to sort file.
 Thumbnail	Click to display file by thumbnail mode.
 List	Click to display file by list mode.

 Select	Click to select file.
 Add folder	Click to add folder.
 Copy	Click to copy file.
 Paste	Click to paste file.
 Cut	Click to cut file.
 Delete	Click to delete file.
 Rename	Click to rename file.
 More	Click to show more functions.

3. File type menu:

All: All types

Doc: OFFICE type files

Note: Image stored by vBoard Lite, Side Tool Bar and remote control Screen capture button.

Picture: Image type files



Media: Audio and video type files

4. **File information:** To preview the image, show the image's name, size, resolution and created date.



5. **Main display area:** Display files of corresponding type.

Cloud Drive

Cloud Drive ✕

Add Account

•

Use the default account

Use the default file name when save

You will be logged out after 30 minutes.

Item	Description
Add Account	Add user account.
Use the default account	The current image will be uploaded to cloud storage without confirm account again after press upload icon.
Use the default file name when save	The current image will be uploaded to cloud storage without editing file name after press upload icon.
You will be logged out after n minutes	System will log out cloud drive automatically.

6. Trouble Shooting

Remote control is out of order	<ol style="list-style-type: none"> 1. Check whether something is obstructing the display's remote control receiver. 2. Check whether the batteries in the remote control are installed correctly. 3. Check whether the batteries need to be replaced.
The unit turns of unexpectedly	<ol style="list-style-type: none"> 1. Check whether Sleep mode is enabled. 2. Check if there is a power outage in your area. 3. Turn on the display and see if the problem is with the signal and control system.

PC mode

No PC signal	<ol style="list-style-type: none"> 1. Check the display settings. 2. Check the display resolution. 3. Adjust the Hs & Vs (synchronization) settings using the OSD menu.
Background streaking	<ol style="list-style-type: none"> 1. Choose auto adjust. 2. Adjust clock and phase.
False color	<ol style="list-style-type: none"> 1. Check the VGA connection. 2. Adjust chroma, brightness and contrast settings.
Unsupported format	<ol style="list-style-type: none"> 1. Choose auto adjust. 2. Adjust clock and phase settings.

Touch Function

Touch function does not work	<ol style="list-style-type: none"> 1. Check that drivers are installed correctly. 2. Reinstall driver. 3. Check setup and align it. 4. Check whether the touch pen is working properly.
------------------------------	---

Video not working properly

No picture / No sound	<ol style="list-style-type: none">1. Check POWER status.2. Check the signal cable.3. Check that the internal PC is installed correctly.
Picture trembling	<ol style="list-style-type: none">1. Check the signal cable.2. Check if other electronics are interrupting the signal.
Poor picture	<ol style="list-style-type: none">1. Adjust chroma, brightness and contrast settings in the menu.2. Check the signal cable.

Audio not working properly

No sound	<ol style="list-style-type: none">1. Press the Mute/ Unmute button.2. Adjust the volume.3. Check the audio cable.
One speaker only	<ol style="list-style-type: none">1. Adjust the sound balance in the menu.2. Check the sound control panel settings of the computer.3. Check the audio cable.

7. Care and Maintenance

Please follow these cleaning guidelines to make sure your smart whiteboard display looks like new for years to come:

- Don't clean the machine if it has been turned on for a long period of time.
- Unplug the unit from the wall outlet before cleaning or polishing it.

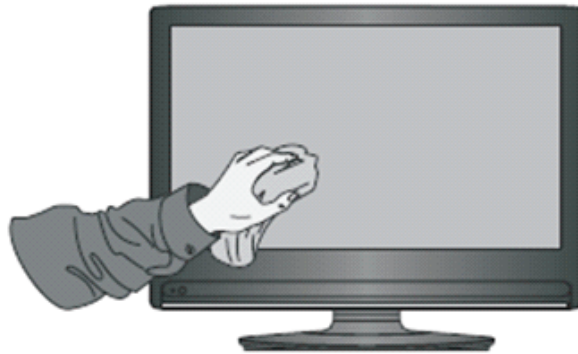

- Don't use liquid cleaners or aerosol cleaners on the screen.
- Only use a slightly dampened cloth when cleaning the exterior of the unit.
- Don't use system continuously for long periods of time.
- Remember to unplug the display when it is not in use.
- Use a power surge protector to prevent system failures and power supply surges.
- Make sure the display remains dry at all times. Be careful when handling liquids near or on the unit.

Note: If condensation appears between the glass and the panel, keep the display turned on until the moisture disappears.

8. Display Modes

8.1 VGA Mode

640x480	@60Hz/72Hz/75Hz
720x400	@70Hz
800x600	@56Hz/60Hz/72Hz/75Hz
832x624	@75Hz
1024x768	@60Hz/70Hz/75Hz
1152x864	@60Hz/75Hz
1152x870	@75Hz
1280x768	@60Hz/75Hz
1280x960	@60Hz
1280x1024	@60Hz/75Hz
1360x768	@60Hz
1366x768	@60Hz
1440x900	@60Hz/75Hz
1400x1050	@60Hz/75Hz
1600x1200	@60Hz
1680x1050	@60Hz
1920x1080	@60Hz
1920x1200	@60Hz

8.2 HDMI Mode

640x480	@60Hz/72Hz
720x400	@70Hz
800x600	@60Hz/72Hz
1024x768	@60Hz/70Hz/75Hz
1280x800	@60Hz
1280x1024	@60Hz
1360x768	@60Hz
1440x900	@60Hz
1680x1050	@60Hz
1920x1080	@60Hz
3840x2160	@30Hz (HDMI 2/3) @60Hz (HDMI 1)
480i	@60Hz
480p	@59Hz/60Hz
576i	@50Hz
720p	@50Hz/60Hz
576p	@50Hz
1080i	@50Hz/60Hz
1080p	@50Hz/60Hz

8.3 DP Mode

640x480	@60Hz/72Hz
720x400	@70Hz
800x600	@60Hz/72Hz
1024x768	@60Hz/70Hz/75Hz
1280x800	@60Hz
1280x1024	@60Hz
1360x768	@60Hz
1440x900	@60Hz
1680x1050	@60Hz
1920x1080	@60Hz
3840x2160	@30Hz
480i	@60Hz
480p	@59Hz/60Hz
576i	@50Hz
720p	@50Hz/60Hz
576p	@50Hz
1080i	@50Hz/60Hz
1080p	@50Hz/60Hz

9. Specifications

Model		IFP5550	IFP6550	IFP7550	IFP8650
Screen Size		54.6"	64.5"	74.5"	85.6"
Input Signal		3 x HDMI 1 x DP 1 x VGA 1 x PC audio 1 x CVBS			
Output Signal		1 x HDMI 1 x Earphone 1 x SPDIF(coaxial)			
Speaker Output		16W x 2			
RS232		RS232 communication			
Power	Voltage	100V-240V AC 50/60HZ			
Operation Conditions	Temperature	32°F to 104°F (0°C to 40°C)			
	Humidity	20% ~ 80% non-condensing			
	Altitude	≤2000M			
Storage Conditions	Temperature	-4°F to 140°F (-20°C to 60°C)			
	Humidity	10% ~ 90% non-condensing			
	Altitude	≤2000M			
Dimensions	Physical (mm)	1302 x 799 x 98	1521 x 922 x 99	1763 x 1042 x 99	1988 x 100 x 1186
		Weight	Physical (kg)	34	47
Power Consumption	On	129W	350W	430W	500W
	Off	<0.5W	<0.5W	<0.5W	<0.5W

Note: Product Specifications are subject to change without notice.

10. RS-232 Protocol

10.1 Introduction

This document describes the hardware interface spec and software protocols of RS232 interface communication between ViewSonic LFD and PC or other control unit with RS232 protocol.

The protocol contains three sections command:

- Set-Function
- Get-Function
- Remote control pass-through mode

※ In the document below, “PC” represents all the control units that can sent or receive the RS232 protocol command.

10.2 Description

10.2.1 Hardware Specification

ViewSonic LFD communication port on the rear side

(1) Connector type: DSUB 9-Pin Male (or 3.5mm barrel connector)

(2) Pin Assignment

(3) Use of crossover (null modem) cable for connection

Male DSUB 9-Pin



Pin #	Signal	Remark
1	NC	
2	RXD	Input to Display
3	TXD	Output from Display
4	NC	
5	GND	
6	NC	
7	NC	
8	NC	
9	NC	
frame	GND	

3.5mm barrel connector
(alternative for limited
space)



Pin #	Signal	Remark
Tip	TXD	Output from Display
Ring	RXD	Input to Display
Sleeve	GND	

10.2.2 LAN Hardware Specification

ViewSonic LFD communication port on the rear side

(1) Connector type: 8P8C RJ45

(2) Pin Assignment

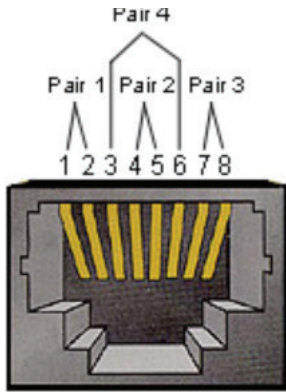

Pin #	Signal	Remark
1	TX+	Output from Display
2	TX-	Output from Display
3	RX+	Input to Display
4	BI_D3+	For 1G case
5	BI_D3-	For 1G case
6	RX-	Input to Display
7	BI_D4+	For 1G case
8	BI_D4-	For 1G case
frame	GND	

10.2.3 RS232 Communication Setting

- Baud Rate Select: 9600bps (fixed)
- Data bits: 8 bits (fixed)
- Parity: None (fixed)
- Stop Bits: 1(fixed)

10.2.4 LAN Communication Setting

- Type: Ethernet
- Protocol: TCP/IP
- Port: 5000 (fixed)
- Cross subnet: No
- Logon Credentials: No

10.2.5 Command Message Reference

PC sends to LFD command packet followed by "CR". Every time PC sends control command to Display, the Display shall respond as follows:

1. If the message is received correctly it will send "+" (02Bh) followed by "CR" (00Dh)
2. If the message is received incorrectly it will send "-" (02Dh) followed by "CR" (00Dh)

10.3 Protocol

10.3.1 Set-Function Listing

The PC can control the Display for specific actions. The Set-Function command allows you to control the Display behavior in a remote site through the RS232 port. The Set-Function packet format consists of 9 bytes.

Set-Function description:

Length:	Total Byte of Message excluding "CR"
LFD ID	Identification for each of Display (01~98; default is 01) ID "99" means to apply the set command for all connected displays. Under such circumstances, only ID#1 display has to reply. The LFD ID can be set via the OSD menu for each Display.
Command Type	Identify command type, "s" (0x73h): Set Command "+" (0x2Bh): Valid command Reply "- " (0x2Dh): Invalid command Reply
Command:	Function command code: One byte ASCII code.
Value[1~3]:	Three bytes ASCII that defines the value.
CR	0x0D

Set-Function format

Send: (Command Type="s")

Name	Length	ID	Command Type	Command	Value1	Value2	Value3	CR
Byte Count	1 Byte	2 Byte	1 Byte	1 Byte	1 Byte	1 Byte	1 Byte	1 Byte
Bytes order	1	2~3	4	5	6	7	8	9

Reply: (Command Type="+" or "-")

Name	Length	ID	Command Type	CR
Byte Count	1 Byte	2 Byte	1 Byte	1 Byte
Bytes order	1	2~3	4	5

NOTE:

1. When PC applies command to all displays (ID=99), only the #1 set needs to reply by the name of ID=1.

Example1: Set Brightness as 76 for Display (#02) and this command is valid

Send (Hex Format)

Name	Length	ID	Command Type	Command	Value1	Value2	Value3	CR
Hex	<u>0x38</u>	<u>0x30</u> <u>0x32</u>	<u>0x73</u>	<u>0x24</u>	<u>0x30</u>	<u>0x37</u>	<u>0x36</u>	<u>0x0D</u>

Reply (Hex Format)

Name	Length	ID	Command Type	CR
Hex	<u>0x34</u>	<u>0x30</u> <u>0x32</u>	<u>0x2B</u>	<u>0x0D</u>

Example2: Set Brightness as 75 for Display (#02) and this command is NOT valid

Name	Length	ID	Command Type	Command	Value1	Value2	Value3	CR
Hex	<u>0x38</u>	<u>0x30</u> <u>0x32</u>	<u>0x73</u>	<u>0x24</u>	<u>0x30</u>	<u>0x37</u>	<u>0x35</u>	<u>0x0D</u>

Reply (Hex Format)

Name	Length	ID	Command Type	CR
Hex	<u>0x34</u>	<u>0x30</u> <u>0x32</u>	<u>0x2D</u>	<u>0x0D</u>

Set-function table

A. Basic function

Set Function	Length	ID	Command Type (ASCII)	Command		Value Range (Three ASCII bytes)	Comments
				Code (ASCII)	Code (Hex)		
Power on/ off (standby)	8		s	!	21	000: STBY 001: ON	The Power-on via LAN control may works only under specific mode. To see display UG for details. *3.1.1
Input Select	8		s	"	22	000: TV 001: AV 002: S-Video 003: YPbPr 004: HDMI1 014: HDMI2 024: HDMI3 034: HDMI4 005: DVI 006: VGA1 016: VGA2 026: VGA3 007: Slot-in PC (OPS/SDM)/HDBT 008: Internal memory 009: DP 00A: Embedded/ Main (Android)	1. No need for USB 2. For the case of two more same sources, the 2nd digital is used to indicate the extension. 3. The HEX of 00A is 30 30 41.
Brightness	8		s	\$	24	000 ~ 100 900: Bright down (-1) 901: Bright up (+1) *3.1.1	
Power lock	8		s	4	34	000: Unlock 001: Lock	*See note in details
Volume	8		s	5	35	000 ~ 100 900: Volume down(-1) 901:Volume up(+1)	
Mute	8		s	6	36	000: OFF 001: ON (mute)	
Button lock	8		s	8	38	000: Unlock 001: Lock	*See note in details
Menu lock		8		s	>	000: Unlock 001: Lock	*See note in details

Number *3.1.1	8		s	@	40	000~009	
Key Pad *3.1.1	8		s	A	41	000: UP 001: DOWN 002: LEFT 003: RIGHT 004: ENTER 005: INPUT 006: MENU/(EXIT) 007: EXIT	
Remote Control	8		s	B	42	000: Disable 001: Enable 002: Pass through	Disable: RCU will be no function Enabled: RCU controls normally Pass through: Display will bypass the RC code to connected device via the RS232 port, but not react itself.
Restore default	8		s	~	7E	000	Recover to factory setting

NOTE:

1. Behavior at lock modes

Lock Mode	Behavior
Button Lock	<ol style="list-style-type: none"> 1. Lock all buttons on the front panel and RCU, except for "Power" 2. All the SET functions should be workable via RS32, even the ones with according hot key in RCU like Mute,...etc.
MENU Lock	<ol style="list-style-type: none"> 1. Lock "MENU" key of front panel and RCU 2. The Factory and Hospitality modes should not be blocked for the model using MENU-combined key to enter these two modes. Alternative approach will be indicated separately if any limitation by model.
POWER Lock	<ol style="list-style-type: none"> 1. Lock "POWER" key on the front and RCU. 2. The SET_POWER on/off should be workable via RS232, but does not mean the POWER lock will be released under this case. 3. Can not be unlocked by reset in OSD setting 4. Will auto AC power-on in power-lock 5. Under power-lock, the set will not enter power saving when no PC signal and neither not turn off when no other video signals after 15min.
Remote control disable	Lock the RCU keys, but keep the front panel buttons workable.

B. Optional function

Set Function	Length	ID	Command Type (ASCII)	Command		Value Range (Three ASCII bytes)	Comments
				Code (ASCII)	Code (Hex)		
Contrast	8		s	#	23	000 ~ 100	
Sharpness	8		s	%	25	000 ~ 100	
Color	8		s	&	26	000 ~ 100	
Tint	8		s	'	27	000 ~ 100	
Color mode	8		s)	29	000: Normal 001: Warm 002: Cold 003: Personal	
Surround sound	8		s	-	2D	000: OFF 001: ON	
Bass	8		s	.	2E	000 ~ 100	
Treble	8		s	/	2F	000 ~ 100	
Balance	8		s	0	30	000 ~ 100	050 is central
Picture Size	8		s	1	31	000: FULL (16:9) 001: NORMAL (4:3) 002: REAL (1:1) *3.1.0	
OSD language	8		s	2	32	000: English 001: French 002: Spanish	Could be extended for more supported languages by model
PIP-Mode	8		s	9	39	000: OFF 001: PIP(POP) 002: PBP	
PIP-Sound select	8		s	:	3A	000: Main 001: Sub	
PIP-Position	8		s	;	3B	000: Up 001: Down 002: Left 003: Right	
PIP-Input	8		s	7	37 *2.9	000: TV 001: AV 002: S-Video 003: YPbPr 004: HDMI1 014: HDMI2 024: HDMI3 034: HDMI4 005: DVI 006: VGA1 016: VGA2 026: VGA3 007: Slot-in PC (OPS/SDM)/HDBT 008: Internal memory 009: DP 00A: Embedded/Main (Android)	Value range is same as SET-Input select

Tiling-Mode	8		s	P	50	000: OFF 001: ON	(for video wall)
Tiling-Compensation	8		s	Q	51	000: OFF 001: ON	(for video wall) Bezel width compensation
Tiling-H by V Monitors	8		s	R	52	01x~09x: H 0x1~0x9: V	(for video wall) 1. 2nd digital for H monitors 2. 3rd digital for V monitors
Tiling-Position	8		s	S	53	001~025	(for Video wall) Copy the screen of Position# to identified display
Date: Year	8		s	V	56	Y17~Y99	Last 2 digits (20)17~(20)99
Date: Month	8		s	V	56	M01~M12	2 digits
Date: Day	8		s	V	56	D01~D31	2 digits
Time: Hour	8		s	W	57	H00~H23	24-hr format. 2 digits.
Time: Min	8		s	W	57	M00~M59	2 digits
Time: Sec	8		s	W	57	S00~S59	2 digits

Note:

1. Tiling definition of H Monitors/ V Monitors/ and Position

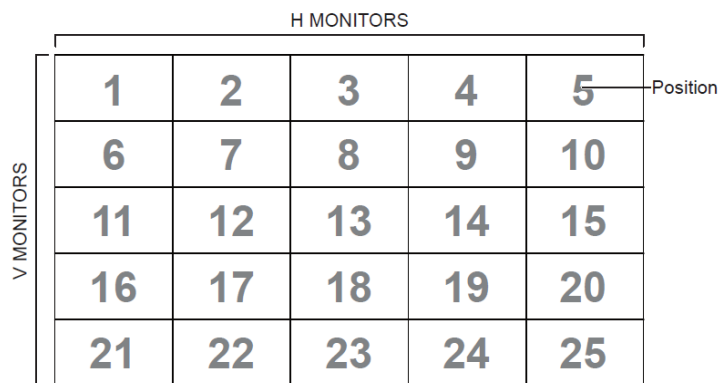

2. Set Date example

Date: 2017-3/15

Send: 0x 38 30 31 73 56 59 31 37 0D ("Y17")

Send: 0x 38 30 31 73 56 4D 30 33 0D ("M03")

Send: 0x 38 30 31 73 56 44 31 35 0D ("D15")

3. Set Time example

Time: 16:27:59

Send: 0x 38 30 31 73 57 48 31 36 0D (“H16”)

Send: 0x 38 30 31 73 57 4D 32 37 0D (“M27”)

Send: 0x 38 30 31 73 57 53 35 39 0D (“S59”)

10.3.2 Get-Function Listing

The PC can interrogate the LFD for specific information. The Get-Function packet format consists of 9 bytes which is similar to the Set-Function packet structure. Note that the “Value” byte is always = 000

Get-Function description:

Length: Total Byte of Message excluding “CR”.

TV/DS ID Identification for each of TV/DS (01~98; default is 01).

Command Type Identify command type,
“g” (0x67h) : Get Command
“r” (0x72h) : Valid command Reply
“-“ (0x2Dh) : Invalid command Reply

Command: Function command code: One byte ASCII code.

Value[1~3]: Three bytes ASCII that defines the value.

CR 0x0D

Get-Function format

Send: (Command Type=“g”)

Name	Length	ID	Command Type	Command	Value1	Value2	Value3	CR
Byte Count	1 Byte	2 Byte	1 Byte	1 Byte	1 Byte	1 Byte	1 Byte	1 Byte
Bytes order	1	2~3	4	5	6	7	8	9

Reply: (Command Type=“r” or “-“)

If the Command is valid, Command Type =“r”

Name	Length	ID	Command Type	Command	Value1	Value2	Value3	CR
Byte Count	1 Byte	2 Byte	1 Byte	1 Byte	1 Byte	1 Byte	1 Byte	1 Byte

Bytes order	1	2~3	4	5	6	7	8	9
-------------	---	-----	---	---	---	---	---	---

If the Command is Not valid, Command Type="-"

Name	Length	ID	Command Type	CR
Byte Count	1 Byte	2 Byte	1 Byte	1 Byte
Bytes order	1	2~3	4	5

**Example1: Get Brightness from TV-05 and this command is valid.
The Brightness value is 67.**

Send (Hex Format)

Name	Length	ID	Command Type	Command	Value1	Value2	Value3	CR
Hex	<u>0x38</u>	<u>0x30</u> <u>0x35</u>	<u>0x67</u>	<u>0x62</u>	<u>0x30</u>	<u>0x30</u>	<u>0x30</u>	<u>0x0D</u>

Reply (Hex Format)

Name	Length	ID	Command Type	Command	Value1	Value2	Value3	CR
Hex	<u>0x38</u>	<u>0x30</u> <u>0x35</u>	<u>0x72</u>	<u>0x62</u>	<u>0x30</u>	<u>0x36</u>	<u>0x37</u>	<u>0x0D</u>

Example2: Get Color from Display (#05) , but the Color command is not supported by this model.

Send (Hex Format)

Name	Length	ID	Command Type	Command	Value1	Value2	Value3	CR
Hex	<u>0x38</u>	<u>0x30</u> <u>0x35</u>	<u>0x67</u>	<u>0x26</u>	<u>0x30</u>	<u>0x30</u>	<u>0x30</u>	<u>0x0D</u>

Reply (Hex Format)

Name	Length	ID	Command Type	CR
Hex	<u>0x34</u>	<u>0x30</u> <u>0x35</u>	<u>0x2D</u>	<u>0x0D</u>

Get-Function table

A. Basic function

Get Function	Length	ID	Command Type (ASCII)	Command		Response Range (Three ASCII bytes)	Comments
				Code (ASCII)	Code (Hex)		
Get-Brightness	8		g	b	62	000 ~ 100	
Get-Volume	8		g	f	66	000 ~ 100	
Get-Mute	8		g	g	67	000: Off 001: On (muted)	
Get-Input select	8		g	j	6A	000~ 100~	1. 1st digit for signal detection: 0 means "no signal"; 1 means "signal detected" 2. 2nd & 3rd digit: See Set-function table
Get-Power status: ON/STBY	8		g	l	6C	001: ON 000: STBY	
Get-Remote control	S		g	n	6E	000: Disable 001: Enable 002: Pass through	Get RCU mode status
Get-Power lock	8		g	o	6F	000: Unlock 001: Lock	
Get-Button lock	8		g	p	70	000: Unlock 001: Lock	
Get-Menu lock	8		g	l	6C	000: Unlock 001: Lock	
Get-ACK	8		g	z	7A	000	This command is used to test the communication link
Get-Thermal	8		g	0	30	000~100: 0~+100 deg C -01~-99: -1~-99 deg C	
Get-Operation time*3.1.0	8		g	1	31	000	1. Accumulated hours in 8-digit integer (00,000,001~99,999,999) 2. Could be reset when FW update and Factory initiation 3. Reply in 4 strings
Get-Device name	8		g	4	34	000	Reply in 6 strings (max. 12 characters) *3.1.0
Get-MAC address	8		g	5	35	000	(for the model with LAN) Reply in 6 strings.*3.1.0

NOTE:

1. Get Operation time example

Assumed the accumulated operation time is 00,123,456 hrs

Send: 0x 38 30 31 67 31 30 30 30 0D (Get Operation time)

Reply:

#1 0x 38 30 31 72 31 31 30 30 0D ("00")

#2 0x 38 30 31 72 31 32 31 32 0D ("12")

#3 0x 38 30 31 72 31 33 33 34 0D ("34")

#4 0x 38 30 31 72 31 34 35 36 0D ("56")

2. Get Device Name example

Assumed the device name is CDE-5500

Send: 0x 38 30 31 67 34 30 30 30 0D (Get Device Name)

Reply:

#1 0x 38 30 31 72 34 31 43 44 0D ("C" "D")

#2 0x 38 30 31 72 34 32 45 2D 0D ("E" "-")

#3 0x 38 30 31 72 34 33 35 35 0D ("5" "5")

#4 0x 38 30 31 72 34 34 30 30 0D ("0" "0")

#5 0x 38 30 31 72 34 35 00 00 0D ("(NULL)" "(NULL)")

#6 0x 38 30 31 72 34 36 00 00 0D ("(NULL)" "(NULL)")

Assumed the device name is "NMP-302#1"

Send: 0x 38 30 31 67 34 30 30 30 0D (Get Device Name)

Reply:

#1 0x 38 30 31 72 34 31 4E 4D 0D ("N" "M")

#2 0x 38 30 31 72 34 32 50 2D 0D ("P" "-")

#3 0x 38 30 31 72 34 33 33 30 0D ("3" "0")

#4 0x 38 30 31 72 34 34 32 23 0D ("2" "#")

#5 0x 38 30 31 72 34 35 31 00 0D ("1" "(NULL)")

#6 0x 38 30 31 72 34 36 00 00 0D ("(NULL)" "(NULL)")

3. Get MAC address example

Assumed the MAC address is 00:11:22:aa:bb:cc

Send: 0x 38 30 31 67 35 30 30 30 0D (Get MAC add)

Reply:

#1 0x 38 30 31 72 35 31 30 30 0D ("00")

#2 0x 38 30 31 72 35 32 31 31 0D ("11")

#3 0x 38 30 31 72 35 33 32 32 0D ("22")

#4 0x 38 30 31 72 35 34 61 61 0D ("aa")

#5 0x 38 30 31 72 35 35 62 62 0D (“bb”)
#6 0x 38 30 31 72 35 36 63 63 0D (“cc”)

B. Optional function

Get Function	Length	ID	Command Type (ASCII)	Command		Response Range (Three ASCII bytes)	Comments
				Code (ASCII)	Code (Hex)		
Get-Contrast	8		g	a	61	000 ~ 100	
Get-Sharpness	8		g	c	63	000 ~ 100	
Get-Color	8		g	d	64	000 ~ 100	
Get-Tint	8		g	e	65	000 ~ 100	
Get-PIP mode	8		g	t	74	000: OFF 001: PIP (POP) 002: PBP	
Get-PIP input	8		g	u	75	000 ~	See Set-input select
Get-Tiling Mode	8		g	v	76	000: OFF 001: ON	(for Video wall)
Get-Tiling Compensation	8		g	w	77	000: OFF 001: ON	(for Video wall) Bezel width compensation
Get-Tiling H by V monitors	8		g	x	78	01x~09x: H monitors 0x1~0x9: V monitors	(for Video wall) 1. 2nd digital for H monitors 2. 3rd digital for V monitors
Get-Tiling position	8		g	y	79	000: OFF 001~025	(for Video wall) Copy the screen of Position# to identified display
Get-Date: Year	8		g	2	32	Y00~Y00	Last 2 digits (20)17~(20)99
Get-Date: Month	8		g	2	32	M00~M00	2 digits
Get-Date: Day	8		g	2	32	D00~M00	2 digits
Get-Time: Hour	8		g	3	33	H00~H00	24-hr format. 2 digits
Get-Time: Min	8		g	3	33	M00~M00	2 digits
Get-Time: Sec	8		g	3	33	S00~S00	2 digits
Get-RS232 version	8		g	6	36	001~	Version 0.0.1~9.9.9

NOTE:

1. Get Date example

Assumed the current date of display#01 as below

Date: 2017-3/15

Send: 0x 38 30 31 67 32 59 30 30 0D (Get Date:Year)

Reply: 0x 38 30 31 72 32 59 31 37 0D ("Y17")

Send: 0x 38 30 31 67 32 4D 30 30 0D (Get Date:Month)
Reply: 0x 38 30 31 72 32 4D 30 33 0D ("M03")

Send: 0x 38 30 31 67 32 44 30 30 0D (Get Date:Day)
Reply: 0x 38 30 31 72 32 44 31 35 0D ("D15")

2. Get Time example

Assumed the current time of display#01 as below

Time: 16:27:59

Send: 0x 38 30 31 67 33 48 30 30 0D (Get Time:Hour)
Reply: 0x 38 30 31 72 33 48 31 36 0D ("H16")

Send: 0x 38 30 31 67 33 4D 30 30 0D (Get Time:Min)
Reply: 0x 38 30 31 72 33 4D 32 37 0D ("M27")

Send: 0x 38 30 31 67 33 53 30 30 0D (Get Time:Sec)
Reply: 0x 38 30 31 72 33 53 35 39 0D ("S59")

3. Get MAC address example

Assumed the version is 3.0.1

Send: 0x 38 30 31 67 36 30 30 30 0D (Get RS232 version)
Reply: 0x 38 30 31 72 36 33 30 31 0D ("301")

10.3.3 Remote Control Pass-through Mode

When PC sets the Display to Remote Control Pass through mode, the Display shall send a 7-byte packet (followed by “CR”) in response to RCU button activation. In this mode the RCU shall have no effect on the Display function. For example: “Volume+” will not change the volume in the Display but only sends “Volume+” code to PC over the RS232 port.

IR Pass Through-Function format

Reply: (Command Type=“p”)

Name	Length	ID	Command Type	RCU Code1 (MSB)	RCU Code2 (LSB)	CR
Byte Count	1 Byte	2 Byte	1 Byte	1 Byte	1 Byte	1 Byte
Bytes order	1	2~3	4	5	6	7

Example1: Remote Control pass-through when “VOL+” key is pressed for Display (#5)

Send (Hex Format)

Name	Length	ID	Command Type	RCU Code1 (MSB)	RCU Code2 (LSB)	CR
Hex	<u>0x36</u>	<u>0x30</u> <u>0x35</u>	<u>0x70</u>	<u>0x31</u>	<u>0x30</u>	<u>0x0D</u>

Key	Code (HEX)	Basic *3.1.1	Optional *3.1.1
1	01	V	
2	02	V	
3	03	V	
4	04	V	
5	05	V	
6	06	V	
7	07	V	
8	08	V	
9	09	V	
0	0A	V	
-	0B		V
RECALL (LAST)	0C		V
INFO (DISPLAY)	0D		V
	0E		
ASPECT (ZOOM, SIZE)	0F		V
VOLUME UP (+)	10	V	
VOLUME DOWN (-)	11	V	
MUTE	12	V	
CHANNEL/PAGE UP (+)/ BRIGHTNESS+	13		V

CHANNEL/PAGE DOWN (-)/ BRIGHTNESS-	14		V
POWER	15	V	
SOURCES (INPUTS)	16	V	
	17		
	18		
SLEEP	19		V
MENU	1A	V	
UP	1B	V	
DOWN	1C	V	
LEFT (-)	1D	V	
RIGHT (+)	1E	V	
OK (ENTER, SET)	1F	V	
EXIT	20	V	
	21		
	22		
	23		
	24		
	25		
	26		
	27		
	28		
	29		
	2A		
	2B		
RED■ (F1)	2C		V
GREEN■ (F2)	2D		V
YELLOW■ (F3)	2E		V
BLUE■ (F4)	2F		V
CHANNEL/PAGE DOWN (-)/ BRIGHTNESS-	14		
POWER	15		
SOURCES (INPUTS)	16		
	17		
	18		
SLEEP	19		
MENU	1A		
UP	1B		
DOWN	1C		
LEFT (-)	1D		
RIGHT (+)	1E		
OK (ENTER, SET)	1F		
EXIT	20		
	21		
	22		
	23		
	24		
	25		

	26		
	27		
	28		
	29		
	2A		
	2B		
RED ■ (F1)	2C		
GREEN ■ (F2)	2D		
YELLOW ■ (F3)	2E		
BLUE ■ (F4)	2F		

NOTE:

1. This IR-pass-through code is different from the RCU key code.
2. Special control sequence for POWER key under IR-pass through mode.
 - 2-1. When Display is OFF and receives the IR POWER code: Display will turn itself on, then forward the POWER code to the host via RS232.
 - 2-2. When Display is ON and receives the IR POWER code: Display will forward the POWER code to the host via RS232, then turn off itself.
 - 2-3. When SET-POWER LOCK is enabled, the Display will not respond to POWER key pressing.
3. The VOLUME UP and VOLUME DOWN code will repeatedly output when you press and hold the keys.

Warranty Statement

Limited Warranty

ViewSonic® Smart White Board

What the warranty covers:

ViewSonic warrants its products to be free from defects in material and workmanship, under normal use, during the warranty period. If a product proves to be defective in material or workmanship during the warranty period, ViewSonic will, at its sole option, repair or replace the product with a like product. Replacement product or parts may include remanufactured or refurbished parts or components.

Who the warranty protects:

This warranty is valid only for the first consumer purchaser.

What the warranty does not cover:

1. Any product on which the serial number has been defaced, modified or removed.
2. Damage, deterioration or malfunction resulting from:
 - a. Accident, misuse, neglect, fire, water, lightning, or other acts of nature, unauthorized product modification, or failure to follow instructions supplied with the product.
 - b. Any damage of the product due to shipment.
 - c. Removal or installation of the product.
 - d. Causes external to the product, such as electrical power fluctuations or failure.
 - e. Use of supplies or parts not meeting ViewSonic's specifications.
 - f. Normal wear and tear.
 - g. Any other cause which does not relate to a product defect.
3. Any product exhibiting a condition commonly known as "image burn-in" which results when a static image is displayed on the product for an extended period of time.
4. Removal, installation, one way transportation, insurance, and set-up service charges.

How to get service:

1. For information about receiving service under warranty, contact ViewSonic Customer Support (Please refer to Customer Support page). You will need to provide your product's serial number.
2. To obtain warranty service, you will be required to provide (a) the original dated sales slip, (b) your name, (c) your address, (d) a description of the problem, and (e) the serial number of the product.
3. Take or ship the product freight prepaid in the original container to an authorized ViewSonic service center or ViewSonic.
4. For additional information or the name of the nearest ViewSonic service center, contact ViewSonic.

Limitation of implied warranties:

There are no warranties, express or implied, which extend beyond the description contained herein including the implied warranty of merchantability and fitness for a particular purpose.

Exclusion of damages:

ViewSonic's liability is limited to the cost of repair or replacement of the product. ViewSonic shall not be liable for:

1. Damage to other property caused by any defects in the product, damages based upon inconvenience, loss of use of the product, loss of time, loss of profits, loss of business opportunity, loss of goodwill, interference with business relationships, or other commercial loss, even if advised of the possibility of such damages.
2. Any other damages, whether incidental, consequential or otherwise.
3. Any claim against the customer by any other party.
4. Repair or attempted repair by anyone not authorized by ViewSonic.

Effect of state law:

This warranty gives you specific legal rights, and you may also have other rights which vary from state to state. Some states do not allow limitations on implied warranties and/or do not allow the exclusion of incidental or consequential damages, so the above limitations and exclusions may not apply to you.

Sales outside the U.S.A. and Canada:

For warranty information and service on ViewSonic products sold outside of the U.S.A. and Canada, contact ViewSonic or your local ViewSonic dealer.

The warranty period for this product in mainland China (Hong Kong, Macao and Taiwan Excluded) is subject to the terms and conditions of the Maintenance Guarantee Card.

For users in Europe and Russia, full details of warranty provided can be found in www.viewsoniceurope.com under Support/Warranty Information.

Mexico Limited Warranty

ViewSonic® Smart White Board

What the warranty covers:

ViewSonic warrants its products to be free from defects in material and workmanship, under normal use, during the warranty period. If a product proves to be defective in material or workmanship during the warranty period, ViewSonic will, at its sole option, repair or replace the product with a like product. Replacement product or parts may include remanufactured or refurbished parts or components & accessories.

Who the warranty protects:

This warranty is valid only for the first consumer purchaser.

What the warranty does not cover:

1. Any product on which the serial number has been defaced, modified or removed.
2. Damage, deterioration or malfunction resulting from:
 - a. Accident, misuse, neglect, fire, water, lightning, or other acts of nature, unauthorized product modification, unauthorized attempted repair, or failure to follow instructions supplied with the product.
 - b. Any damage of the product due to shipment.
 - c. Causes external to the product, such as electrical power fluctuations or failure.
 - d. Use of supplies or parts not meeting ViewSonic's specifications.
 - e. Normal wear and tear.
 - f. Any other cause which does not relate to a product defect.
3. Any product exhibiting a condition commonly known as "image burn-in" which results when a static image is displayed on the product for an extended period of time.
4. Removal, installation, insurance, and set-up service charges.

How to get service:

For information about receiving service under warranty, contact ViewSonic Customer Support (Please refer to the attached Customer Support page). You will need to provide your product's serial number, so please record the product information in the space provided below on your purchase for your future use. Please retain your receipt of proof of purchase to support your warranty claim.

For Your Records

Product Name: _____ Model Number: _____
Document Number: _____ Serial Number: _____
Purchase Date: _____ Extended Warranty Purchase? _____ (Y/N)
If so, what date does warranty expire? _____

1. To obtain warranty service, you will be required to provide (a) the original dated sales slip, (b) your name, (c) your address, (d) a description of the problem, and (e) the serial number of the product.
2. Take or ship the product in the original container packaging to an authorized ViewSonic service center.
3. Round trip transportation costs for in-warranty products will be paid by ViewSonic.

Limitation of implied warranties:

There are no warranties, express or implied, which extend beyond the description contained herein including the implied warranty of merchantability and fitness for a particular purpose.

Exclusion of damages:

ViewSonic's liability is limited to the cost of repair or replacement of the product. ViewSonic shall not be liable for:

1. Damage to other property caused by any defects in the product, damages based upon inconvenience, loss of use of the product, loss of time, loss of profits, loss of business opportunity, loss of goodwill, interference with business relationships, or other commercial loss, even if advised of the possibility of such damages.
2. Any other damages, whether incidental, consequential or otherwise.
3. Any claim against the customer by any other party.
4. Repair or attempted repair by anyone not authorized by ViewSonic.

Contact Information for Sales & Authorized Service (Centro Autorizado de Servicio) within Mexico:	
Name, address, of manufacturer and importers: México, Av. de la Palma #8 Piso 2 Despacho 203, Corporativo Interpalmas, Col. San Fernando Huixquilucan, Estado de México Tel: (55) 3605-1099 http://www.viewsonic.com/la/soporte/index.htm	
NÚMERO GRATIS DE ASISTENCIA TÉCNICA PARA TODO MÉXICO: 001.866.823.2004	
Hermosillo: Distribuciones y Servicios Computacionales SA de CV. Calle Juarez 284 local 2 Col. Bugambillas C.P: 83140 Tel: 01-66-22-14-9005 E-Mail: disc2@hmo.megared.net.mx	Villahermosa: Compumantenimientos Garantizados, S.A. de C.V. AV. GREGORIO MENDEZ #1504 COL, FLORIDA C.P. 86040 Tel: 01 (993) 3 52 00 47 / 3522074 / 3 52 20 09 E-Mail: compumantenimientos@prodigy.net.mx
Puebla, Pue. (Matriz): RENTA Y DATOS, S.A. DE C.V. Domicilio: 29 SUR 721 COL. LA PAZ 72160 PUEBLA, PUE. Tel: 01(52).222.891.55.77 CON 10 LINEAS E-Mail: datos@puebla.megared.net.mx	Veracruz, Ver.: CONEXION Y DESARROLLO, S.A DE C.V. Av. Americas # 419 ENTRE PINZÓN Y ALVARADO Fracc. Reforma C.P. 91919 Tel: 01-22-91-00-31-67 E-Mail: gacosta@qplus.com.mx
Chihuahua Soluciones Globales en Computación C. Magisterio # 3321 Col. Magisterial Chihuahua, Chih. Tel: 4136954 E-Mail: Cefeo@soluglobales.com	Cuernavaca Compusupport de Cuernavaca SA de CV Francisco Leyva # 178 Col. Miguel Hidalgo C.P. 62040, Cuernavaca Morelos Tel: 01 777 3180579 / 01 777 3124014 E-Mail: aquevedo@compusupportcva.com
Distrito Federal: QPLUS, S.A. de C.V. Av. Coyoacán 931 Col. Del Valle 03100, México, D.F. Tel: 01(52)55-50-00-27-35 E-Mail: gacosta@qplus.com.mx	Guadalajara, Jal.: SERVICRECE, S.A. de C.V. Av. Niños Héroes # 2281 Col. Arcos Sur, Sector Juárez 44170, Guadalajara, Jalisco Tel: 01(52)33-36-15-15-43 E-Mail: mmiranda@servicrece.com
Guerrero Acapulco GS Computación (Grupo Sesicomp) Progreso #6-A, Colo Centro 39300 Acapulco, Guerrero Tel: 744-48-32627	Monterrey: Global Product Services Mar Caribe # 1987, Esquina con Golfo Pérsico Fracc. Bernardo Reyes, CP 64280 Monterrey N.L. México Tel: 8129-5103 E-Mail: aydeem@gps1.com.mx
MÉRIDA: ELECTROSER Av Reforma No. 403Gx39 y 41 Mérida, Yucatán, México CP97000 Tel: (52) 999-925-1916 E-Mail: rrrb@sureste.com	Oaxaca, Oax.: CENTRO DE DISTRIBUCION Y SERVICIO, S.A. de C.V. Murguía # 708 P.A., Col. Centro, 68000, Oaxaca Tel: 01(52)95-15-15-22-22 Fax: 01(52)95-15-13-67-00 E-Mail: gpotai2001@hotmail.com
Tijuana: STD Av Ferrocarril Sonora #3780 L-C Col 20 de Noviembre Tijuana, Mexico	FOR USA SUPPORT: ViewSonic Corporation 10 Pointe Dr. Suite 200. Brea, CA. 92821, UY.S.A Tel: 800-688-6688 (English); 866-323-8056 (Spanish); E-Mail: http://www.viewsonic.com



ViewSonic®