



# HP Z2 Mini G3 Workstation

## Maintenance and Service Guide

**Copyright Information**

© Copyright 2016 HP Development Company, L.P.

First Edition: December 2016

Part number: 902551-001

**Warranty**

The information contained herein is subject to change without notice. The only warranties for HP products and services are set forth in the express warranty statements accompanying such products and services. Nothing herein should be construed as constituting an additional warranty. HP shall not be liable for technical or editorial errors or omissions contained herein.

Not all features are available in all editions of Windows. This computer may require upgraded and/or separately purchased hardware, drivers, and/or software to take full advantage of Windows functionality. See <http://www.microsoft.com> for details.

**Trademark Credits**

Microsoft and Windows are U.S. registered trademarks of the Microsoft group of companies.

Intel, Intel Xeon, and Intel Core are trademarks of Intel Corporation in the U.S. and other countries.

Bluetooth is a trademark owned by its proprietor and used by HP Company under license.

ENERGY STAR is a registered trademark owned by the U.S. Environmental Protection Agency (EPA).

Red Hat is a registered trademark of Red Hat, Inc. in the United States and other countries.

NVIDIA and the NVIDIA logo are trademarks and/or registered trademarks of NVIDIA Corporation in the U.S. and other countries.

## About this guide

This guide provides service and maintenance information.



**IMPORTANT:** Removal and replacement procedures are now available in videos on the HP website.

Go to the HP Customer Self Repair Services Media Library at <http://www.hp.com/go/sml>.

---

### Guide topics

---

[Hardware overview on page 1](#)

[System management on page 13](#)

[Component replacement information and guidelines on page 45](#)

[Diagnostics and troubleshooting on page 56](#)

[Resetting the password jumper on page 79](#)

[Linux technical notes on page 82](#)

[System board designators on page 84](#)

---



**NOTE:** View the *HP Z2 Mini G3 Workstation User Guide* at [http://www.hp.com/support/workstation\\_manuals](http://www.hp.com/support/workstation_manuals).

---



---

# Table of contents

<b>1 Hardware overview .....</b>	<b>1</b>
Front .....	2
Left .....	3
Rear .....	4
Performance model .....	4
Entry model .....	5
Chassis components .....	6
System board components .....	7
System board architecture .....	9
Computer specifications .....	10
Physical characteristics and technical specifications .....	10
Environmental specifications .....	11
Ensuring proper ventilation .....	12
<b>2 System management .....</b>	<b>13</b>
Adding monitors .....	14
Planning for additional monitors .....	14
Entry model .....	14
Performance model .....	14
Planning process .....	15
Matching graphics card connector to monitor connectors .....	16
Identifying monitor connection requirements .....	16
Connecting and configuring monitors .....	16
Customizing the monitor display (Windows) .....	17
Power management features .....	17
ERP compliance mode .....	17
Hyper-Threading Technology (HTT) .....	18
SATA Power Management .....	18
Intel Turbo Boost Technology .....	18
BIOS ROM .....	18
Computer Setup (F10) Utilities .....	18
Using Computer Setup (F10) Utilities .....	19
Computer Setup—Main .....	20
Computer Setup—Security .....	22
Computer Setup—Advanced .....	23
Desktop management .....	29

Initial computer configuration and deployment .....	30
Installing a remote system .....	30
Copying a setup configuration to another computer .....	30
Updating and managing software .....	31
LANDesk Software .....	31
HP SoftPaq Download Manager .....	31
HP System Software Manager .....	31
ROM Flash .....	32
Remote ROM Flash .....	32
HPBiosUpdRec .....	32
FailSafe Boot Block .....	32
Recovering the computer from Boot Block Recovery mode .....	33
Computer security .....	33
Asset tracking .....	33
SATA hard drive security .....	34
DriveLock applications .....	34
Using DriveLock .....	35
Password security .....	36
Establishing a setup password using Computer Setup (F10) Utility .....	36
Establishing a power-on password using computer setup .....	36
Entering a power-on password .....	37
Entering a setup password .....	37
Changing a power-on or setup password .....	37
Deleting a power-on or setup password .....	38
National keyboard delimiter characters .....	38
Clearing passwords .....	38
Chassis security .....	39
Cable lock (optional) .....	39
Fault notification and recovery .....	39
Thermal sensors .....	39
Dual-state power button .....	39
Changing the power button configuration (Windows only) .....	39
Backing up, restoring, and recovering in Windows 10 .....	40
Creating recovery media and backups .....	40
Creating HP Recovery media (select products only) .....	40
Using Windows tools .....	41
Restore and recovery .....	41
Recovering using HP Recovery Manager .....	42
What you need to know before you get started .....	42
Using the HP Recovery partition (select products only) .....	43
Using HP Recovery media to recover .....	43

Changing the computer boot order .....	43
Removing the HP Recovery partition (select products only) .....	43
<b>3 Component replacement information and guidelines .....</b>	<b>45</b>
Warnings and cautions .....	46
Service considerations .....	47
Tools and software requirements .....	47
Electrostatic discharge (ESD) information .....	47
Product recycling .....	48
Component replacement guidelines .....	49
Battery .....	49
Cable management .....	49
CPU (processor) and CPU heat sink .....	50
Expansion slots .....	51
Hard drives/Z Turbo Drive G2 M.2 modules .....	51
Handling hard drives .....	51
Memory .....	52
Supported SODIMM configurations .....	52
BIOS errors and warnings .....	52
SODIMM installation guidelines .....	52
SODIMM installation order .....	53
Power supply .....	53
Power supply specifications .....	54
Power consumption and heat dissipation .....	54
Resetting the power supply .....	55
<b>4 Diagnostics and troubleshooting .....</b>	<b>56</b>
Calling support .....	57
Locating ID labels .....	57
Locating warranty information .....	58
Diagnosis guidelines .....	58
Diagnosis at startup .....	58
Diagnosis during operation .....	58
Troubleshooting checklist .....	59
HP troubleshooting resources and tools .....	59
Online support .....	59
Troubleshooting a problem .....	60
Customer Advisories, Bulletins, Notices, and Product Change Notifications .....	60
Product Change Notifications .....	60
Helpful hints .....	60
At startup .....	60

During operation .....	60
Customer Self-Repair program .....	61
Troubleshooting scenarios and solutions .....	62
Solving minor problems .....	62
Solving hard drive problems .....	63
Solving internal display problems .....	65
Solving externally connected display problems .....	67
Solving audio problems .....	69
Solving printer problems .....	70
Using HP PC Hardware Diagnostics (UEFI) .....	70
Downloading HP PC Hardware Diagnostics (UEFI) to a USB device .....	71
POST error messages and diagnostic front panel LEDs and audible codes .....	71
POST numeric codes and text messages .....	72
Interpreting system validation diagnostic front panel lights and audible codes .....	77
<b>5 Configuring password security and resetting CMOS .....</b>	<b>79</b>
Preparing to configure passwords .....	79
Resetting the password jumper .....	79
Clearing and resetting the BIOS .....	81
<b>Appendix A Linux technical notes .....</b>	<b>82</b>
System RAM .....	82
Audio .....	82
Network cards .....	82
Hyper-Threading Technology .....	83
NVIDIA Graphics Workstations .....	83
<b>Appendix B System board designators .....</b>	<b>84</b>
<b>Index .....</b>	<b>85</b>



---

# 1 Hardware overview

HP continually improves and changes product parts. For complete and current information on supported parts for your computer, go to <http://partsurfer.hp.com>, select your country or region, and then follow the on-screen instructions.

This chapter presents an overview of hardware components.

---

## Topics

---

[Front on page 2](#)

---

[Left on page 3](#)

---

[Rear on page 4](#)

---

[Chassis components on page 6](#)

---

[System board components on page 7](#)

---

[System board architecture on page 9](#)

---

[Computer specifications on page 10](#)

---



## Front

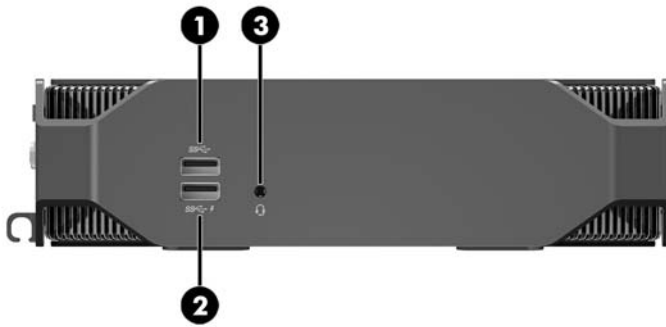

Item	Icon	Component
1		Power button
2		Power on LED

## Left









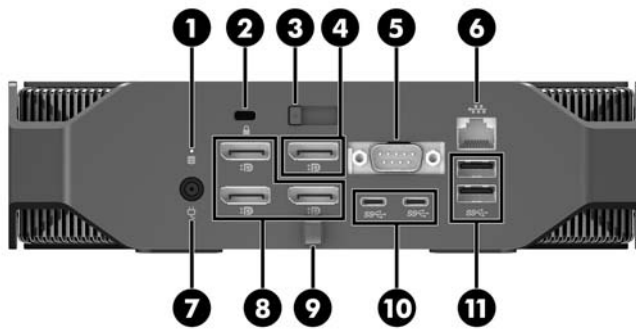

Item	Icon	Component
1		USB 3.0 port
2		USB 3.0 charging port
3		Audio-out (headphone)/Audio-in (microphone) combo jack

# Rear







## Performance model

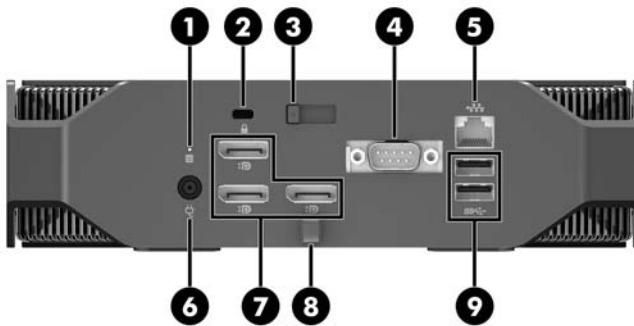

Item	Icon	Component	Item	Icon	Component
1		Hard drive activity light On: The computer is on. Blinking white: The hard drive is being accessed.	7		Power cord connector
2		Cable lock slot	8		DisplayPort 1.2 connectors (3) Driven by NVIDIA GPU
3		Access panel release latch	9		DC-IN cable clip
4		DisplayPort 1.2 connector Driven by NVIDIA® or Intel® GPU. NVIDIA® is the default GPU. Intel® GPU can be selected in the BIOS (F10) menu.	10		USB Type-C ports (2)
5		Serial port (optional)	11		USB 3.0 ports (2)
6		RJ-45 (network) jack			

## Entry model



Item	Icon	Component	Item	Icon	Component
1		Hard drive activity light On: The computer is on. Blinking white: The hard drive is being accessed.	6		Power cord connector
2		Cable lock slot	7		DisplayPort connectors (3)
3		Access panel release latch	8		DC-IN cable clip
4		Serial port (optional)	9		USB 3.0 ports (2)
5		RJ-45 (network) jack			

# Chassis components

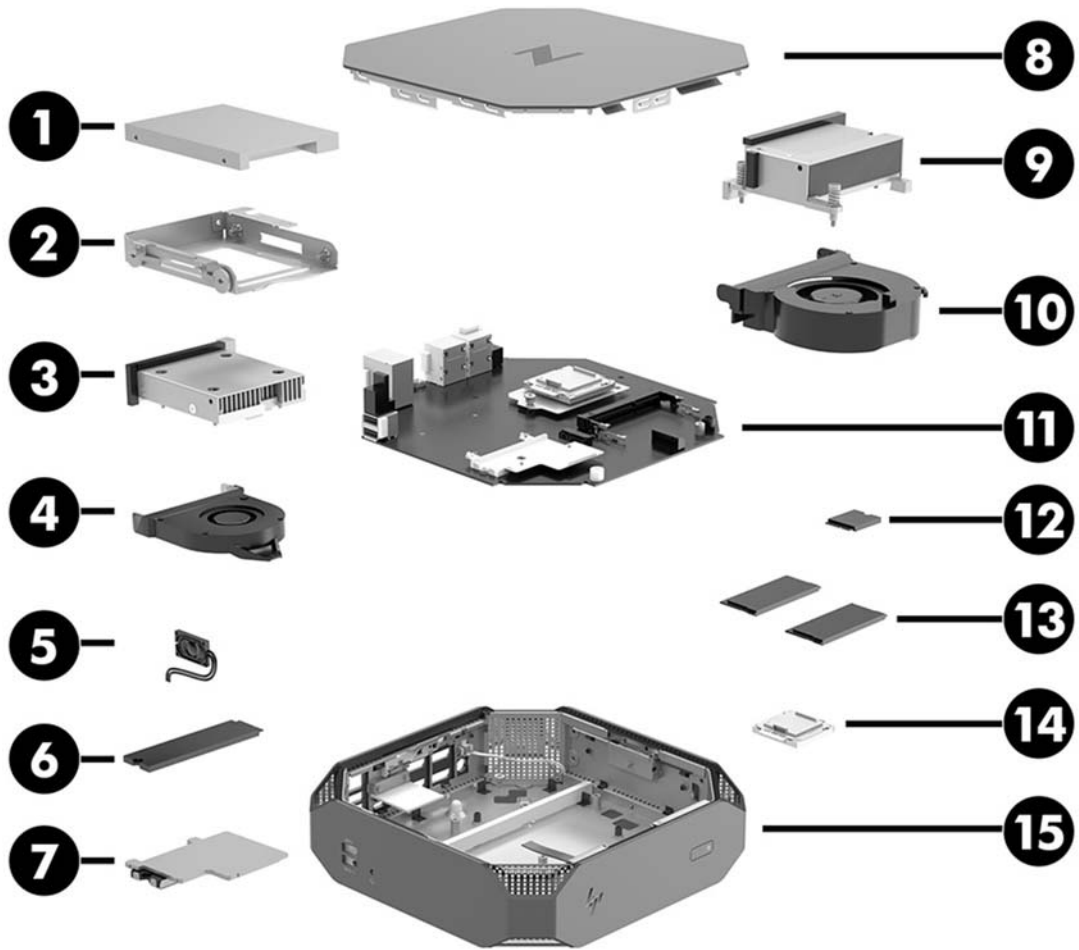

Component	Description	Component	Description
1	Hard drive, 2.5 inch	9	Processor (CPU) heat sink
2	Drive cage	10	Processor fan
3	Graphics heat sink (Performance models only)	11	System board
4	Graphics card fan (Performance models only)	12	WLAN module
5	Speaker	13	Memory modules (SODIMMs)
6	M.2 solid-state drive	14	Processor
7	M.2 heat sink	15	Chassis
8	Top cover		

# System board components

The following figures and tables describe the system board component layout.

## Performance models

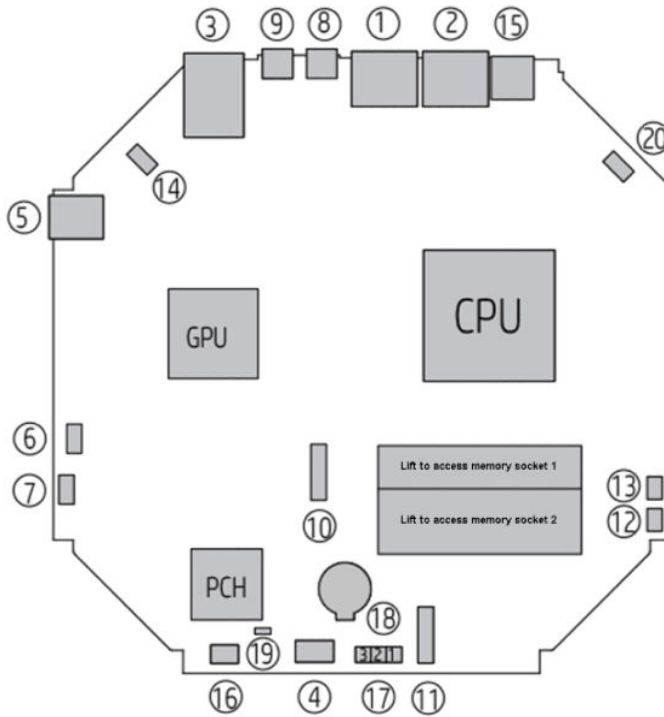

Component	Description	Component	Description
<b>I/O</b>		<b>Cooling</b>	
1	DisplayPorts 3 and 4*	12	CPU fan
2	DisplayPorts 1 and 2*	13	GPU fan
3	Network/rear USB 3.0	14	Thermal sensor
4	Serial (optional)	<b>Power</b>	
5	Side USB 3.0	15	DC in
6	Side audio	16	SATA signal/power
7	Speaker	17	Clear CMOS jumper
8	USB Type-C	18	Battery
9	USB Type-C	<b>Service</b>	
<b>M.2</b>		19	Password jumper
10	M.2 2280 Storage	20	Power button/light (front) and hard drive light (rear)
11	M.2 2230 WLAN		

\* Ports 1–3: Nvidia only  
 \* Port 4: Nvidia or Intel

## Entry models

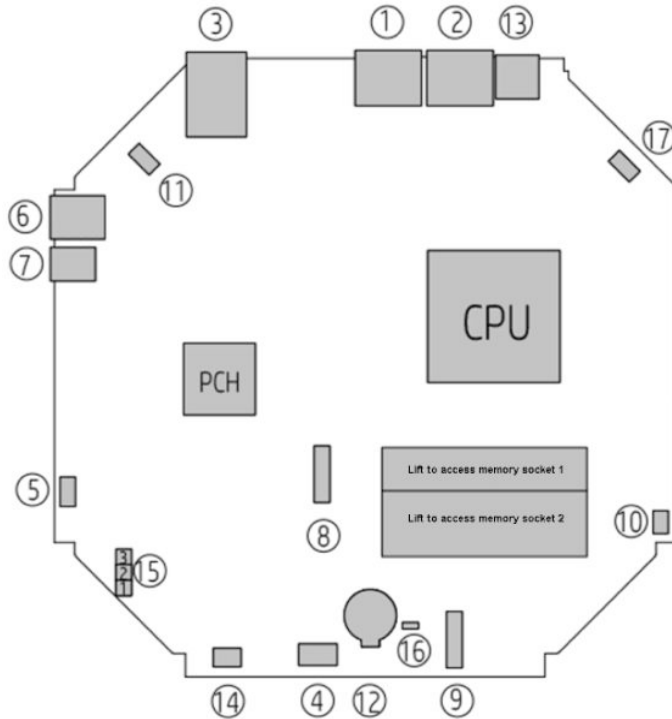

Component	Description	Component	Description
<b>I/O</b>		<b>Cooling</b>	
1	DisplayPort 3	10	CPU fan
2	DisplayPorts 1 and 2	11	Thermal sensor
3	Network/rear USB 3.0	<b>Power</b>	
4	Serial (optional)	12	Battery
5	Speaker	13	DC in
6	Side USB 3.0	14	SATA signal/power
7	Side audio	<b>Service</b>	
<b>M.2</b>		15	Clear CMOS jumper
8	M.2 2280 storage	16	Password jumper
9	M.2 2230 WLAN	17	Power button/light (front) and hard drive light (rear)

## Diagnostic light and audible codes

Provide diagnostic information through the front panel light (blinks) and system speaker (beeps). the codes are in major/minor format – major are red blinks with long, low pitch beeps; minor are white blinks with short, high-pitch beeps.

Major.minor	2.x	3.2	3.3	3.4	3.5	3.6	4.x	5.x
<b>Diagnosis</b>	BIOS	Memory	Graphics	Power supply	CPU	CPU	Thermal	System board



# System board architecture

The following figures show the system board block diagram.

## Performance

### Block Diagram

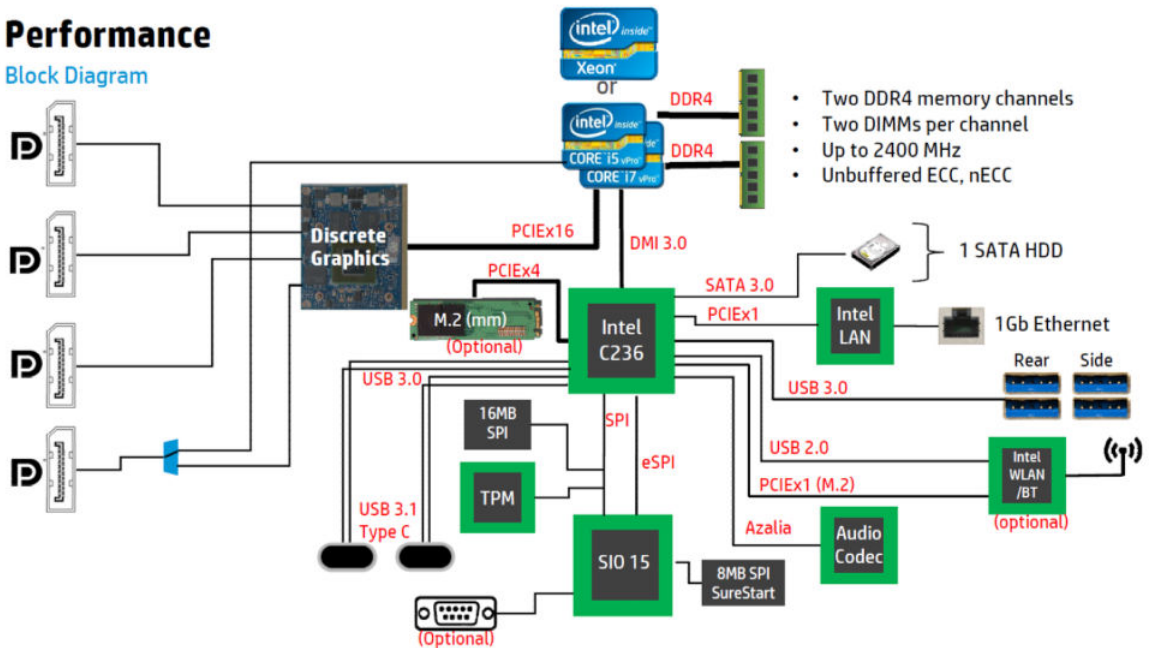

## Entry

### Block Diagram

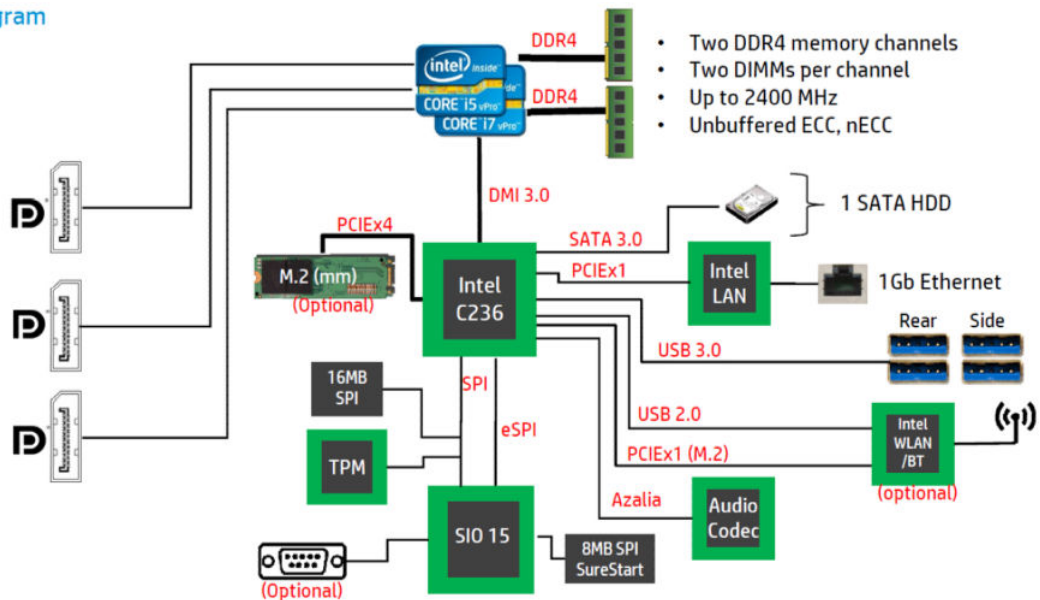

# Computer specifications

## Physical characteristics and technical specifications

HP Z2 Mini G3 Workstation		
<b>Weight</b> (not including external power supply)	Unit only (Performance)	2.08 kg (4.58 lbs)
	Unit only (Entry)	1.87 kg (4.12 lbs)
<b>Dimensions</b>	Unit only	<b>Height:</b> 58 mm (2.3 in)
		<b>Width:</b> 216 mm (8.5 in)
		<b>Depth:</b> 216 mm (8.5 in)
<b>Processor technology</b>	Intel® Series C236 chipset with:	
	<ul style="list-style-type: none"> <li>Support for 5th generation Intel® Xeon® processors (80 W)(Performance and Entry models) or 6th generation Intel Core™ processors (65W) (Entry models)</li> </ul>	
	<ul style="list-style-type: none"> <li>Integrated 2-channel memory controller</li> </ul>	
	<ul style="list-style-type: none"> <li>Integrated graphics (some models)</li> </ul>	
	<ul style="list-style-type: none"> <li>Advanced Vector Extensions (AVX) to increase floating point performance</li> <li>Intel DMI3 interface connecting the processor to the I/O controller</li> </ul>	
<b>Power supply</b>	<ul style="list-style-type: none"> <li>(Performance models) 200 W external or (Entry models) 135 W external, DoE VI efficient, compatible with ENERGY STAR® Version 6.1 requirements</li> <li>Supports European Union ERP Lot 6 tier 2 power limit of less than 0.5 W in off mode</li> </ul>	
	<ul style="list-style-type: none"> <li>Dual inline memory modules (SODIMMs) based on DDR4 2400 MHz technology</li> <li>Supports error checking and correcting (ECC) and non-ECC SODIMMs</li> <li>Two direct-attach memory channels that enable low-latency access and fast data transfer for improved performance</li> </ul>	
<b>Memory technology</b>	<ul style="list-style-type: none"> <li>Up to 32 GB system memory (2 x 16 GB SODIMMs)</li> </ul>	
	<ul style="list-style-type: none"> <li>(Performance models) 2133 MHz, 8 GB, or 16 GB non-ECC unbuffered SODIMM</li> </ul>	
	<ul style="list-style-type: none"> <li>(Entry models) 2133 MHz, 4 GB, 8 GB, or 16 GB ECC unbuffered SODIMM</li> </ul>	
	<p><b>NOTE:</b> The processor may limit the speed of the memory. Some processors may run the memory at less than the rated speed of the SODIMMs. Check your specific processor specifications.</p>	
<b>Graphics</b>	<ul style="list-style-type: none"> <li>NVIDIA Quadro M620, 2 GB (discrete, embedded)(Performance models)</li> </ul>	
	<p><b>NOTE:</b> NVIDIA Quadro M620 graphics can drive up to 4 displays simultaneously.</p>	
	<ul style="list-style-type: none"> <li>Supports Intel HD Graphics 510 or Intel HD Graphics 530 (Core processors) or Intel HD Graphics P530 (Xeon processors)</li> </ul>	
	<p><b>NOTE:</b> In Performance models, Intel HD Graphics is disabled by default.</p> <p><b>NOTE:</b> Intel HD graphics can drive up to 3 displays simultaneously.</p>	
<b>I/O technology</b>	<b>Performance models</b>	
	<ul style="list-style-type: none"> <li>(4) USB 3.0 ports</li> </ul>	
	<ul style="list-style-type: none"> <li>(4) DisplayPort 1.2</li> </ul>	
	<ul style="list-style-type: none"> <li>(2) Type-C USB 3.1 Gen1</li> </ul>	
	<ul style="list-style-type: none"> <li>RJ-45 for LAN</li> </ul>	

---

## HP Z2 Mini G3 Workstation

---

- Headphone/microphone combination jack
- WLAN and Bluetooth module (optional)
- Supports European Union ERP Lot 6 tier2 power limit of less than 0.5W in off mode

### Entry models

- (3) DisplayPort 1.2
- (4) USB 3.0
- RJ-45 for LAN
- Headphone/microphone combination jack
- WLAN and Bluetooth module (optional)

### Storage devices

- (1) 2.5-inch SATA hard drive or solid-state drive, 9.5 mm max height
  - (1) M.2 2280 Z Turbo Drive
  - Up to 2 TB max storage
- 

## Environmental specifications

Item	Value
Temperature	<b>Operating:</b> 5°C to 35°C (40°F to 95°F)
	<b>Nonoperating:</b> -40°C to 60°C (-40°F to 140°F)
	<b>NOTE:</b> The ambient upper limit of 35°C is good up to 1524 m (5000 ft) elevation. Derate by 1°C for every 305 m (1000 ft) above 1524 m (5000 ft). For example, at 3,048 m (10,000 ft), the upper ambient air temperature limit is 30°C.
Humidity	<b>Operating:</b> 8% to 85% relative humidity, non-condensing
	<b>Nonoperating:</b> 8% to 90% relative humidity, non-condensing
Altitude	<b>Operating:</b> 0 to 3,048 m (10,000 ft)
	<b>Nonoperating:</b> 0 to 9,144 m (30,000 ft)
Shock	<b>Operating:</b> ½-sine: 40g, 2–3 ms (~62 cm/sec)
	<b>Nonoperating:</b>
	<ul style="list-style-type: none"> <li>• ½-sine: 160 cm/s, 2–3 ms (~105g)</li> <li>• square: 422 cm/s, 20g</li> </ul>
	<b>NOTE:</b> Values represent individual shock events and do not indicate repetitive shock events.
Vibration	<b>Operating random:</b> 0.5g (rms), 5–300 Hz, up to 0.0025 g <sup>2</sup> /Hz
	<b>Non-operating random:</b> 2.0g (rms), 5–500 Hz, up to 0.0150 g <sup>2</sup> /Hz
	<b>NOTE:</b> Values do not indicate continuous vibration.

---

## Ensuring proper ventilation

Proper ventilation for the system is important for computer operation. To be sure that there is adequate ventilation:

- Operate the computer on a sturdy, level surface.
- Provide at least 15.24 cm (6.00 in) of clearance at the front and back of the computer. (This is the *minimum* distance for all computer models.)



- Be sure that the ambient air temperature surrounding the computer falls within the specified limits (see [Environmental specifications on page 11](#)).
- For cabinet installation, ensure adequate cabinet ventilation and ensure that the ambient temperature within the cabinet does not exceed specified limits.
- Never restrict the incoming or outgoing airflow of the computer by blocking any vents or air intakes.

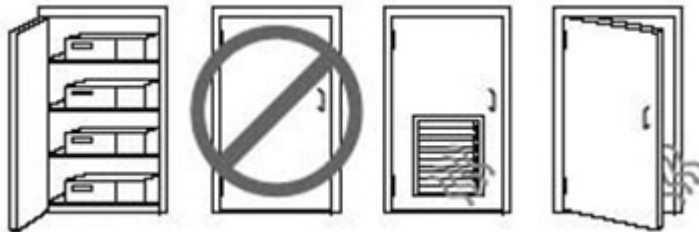

---

## 2 System management

This section describes the tools and utilities that provide system management for the computer.

---

### Topics

---

[Adding monitors on page 14](#)

---

[Power management features on page 17](#)

---

[BIOS ROM on page 18](#)

---

[Computer Setup \(F10\) Utilities on page 18](#)

---

[Desktop management on page 29](#)

---

# Adding monitors

## Planning for additional monitors

### Entry model

The HP Z2 Mini G3 Entry system supports up to three simultaneous displays running on the Intel integrated GPU. Each display is capable of resolutions up to 4096 × 2160 @ 60 Hz.

It is also possible to drive a panel at a resolution of 5120 × 2880 @60 Hz by using two of the DisplayPort 1.2 outputs together. The panel must support this method of achieving this resolution for this to be possible.

### Performance model

The HP Z2 Mini G3 Performance model is capable of operating in two distinct modes: NVIDIA GPU–only mode or NVIDIA GPU + Intel GPU mode. The NVIDIA GPU–only mode offers the best performance, while the NVIDIA GPU + Intel GPU mode allows the system to drive an additional two displays.

NVIDIA GPU–only mode:

- The default configuration.
- Offers the best performance because every DisplayPort 1.2 port is driven directly by the NVIDIA Quadro GPU.
- Capable of driving up to four independent displays at a maximum resolution of 4096×2160 @ 60 Hz or two independent displays at a maximum resolution of 5120×2880 @ 60 Hz by combining DisplayPort outputs. The display must support this method of achieving this resolution.

NVIDIA GPU + Intel GPU mode:

- The NVIDIA GPU can support a maximum of four independent displays. To support an additional two displays, the system can be configured to simultaneously use both the NVIDIA Quadro GPU and the Intel integrated GPU.
- This mode is configured in the system BIOS.
  1. Press the power button on the system, and then repeatedly press the **F10** key until you've reached the system BIOS GUI.
  2. Navigate to the **Advanced** tab.
  3. Select **Built-In Device Options**.
  4. Select **Enable Intel graphics on DisplayPort port #4**.
  5. Press **Enter** to accept the prompt notifying you that the Intel GPU will be output on DisplayPort #4.
  6. Press **F10** to save your changes and exit.
- This mode is capable of driving up to six independent displays.
  - Because the system has only four DisplayPort 1.2 ports, two of the DisplayPort 1.2 ports must each drive two displays in a daisy-chained configuration. This is accomplished by using DisplayPort

1.2 Multi-Stream Transport (MST) and requires displays which support MST or DisplayPort hubs capable of MST.

- To achieve a six-display configuration, one of the daisy chains must be driven by the Intel GPU on DisplayPort #4. Refer to [Performance model on page 4](#) to identify specific DisplayPorts. The other daisy chain can be driven by the NVIDIA Quadro GPU on any of the remaining DisplayPort 1.2 ports.
  - Each DisplayPort 1.2 output on the system is capable of driving a display at a resolution of 4096 × 2160 @ 60 Hz. When two displays are daisy-chained together from a single DisplayPort 1.2 port, each display in the daisy chain is bandwidth-limited to a maximum resolution of 2560 × 1600 @ 60 Hz.
- Performance is dependent upon which GPU is running the application. For the best performance of a particular application, ensure that the application is running on the NVIDIA Quadro GPU.

## Planning process

The process for adding monitors depends on the type and number of monitors you add.

Use the following process to plan for adding more monitors:

1. Assess your monitor needs.
  - a. Determine how many monitors you require.
  - b. Determine the kind of graphics performance you want. For maximum performance, ensure that your display is driven by the NVIDIA Quadro GPU.
  - c. Note the type of graphics connector used by each monitor. HP provides graphics cards with DisplayPort (DP) and DVI interfaces, but you can use adapters and third-party cards for other graphics formats, including DVI-I, HDMI, or VGA.
2. Install drivers and configure resolutions.
  - a. Be sure that you have the correct drivers for the card. See <http://www.hp.com> for HP-qualified drivers.
  - b. Configure each monitor's resolution, orientation, and placement through Windows Display Settings. For details, refer to Windows Help or to <http://www.microsoft.com>.
  - c. For monitor setup in Linux, you can often use the settings tool for the graphics cards (e.g., NVIDIA® nvidia-settings). In some recent Linux releases, the window manager system (e.g., Gnome 3) preferences must also be modified.

---

 **TIP:** To simplify troubleshooting of possible problems, enable the monitors one at a time: enable the first monitor and be sure that it works properly before enabling the next monitor.

---

## Matching graphics card connector to monitor connectors

The following table describes monitor configuration scenarios.

Graphics card interface connector	Monitor connector				
	VGA	DVI	Dual Link DVI	DisplayPort (DP)	HDMI
DISPLAYPORT 	DisplayPort to VGA adapter (sold separately)	DP to DVI adapter	DP to DL DVI adapter	DP cable	DP to HDMI adapter

 **NOTE:** DisplayPort connections have the highest performance; VGA connections have the lowest.

## Identifying monitor connection requirements

**Graphics card with DisplayPort output** —The system has four DisplayPort 1.2 outputs. You can connect a monitor to each connector. Use the proper adapters, if required.

## Connecting and configuring monitors

1. Connect the monitor cable adapters (if required) to the computer, then connect the appropriate monitor cables to the adapters or directly to the graphics card.
2. Connect the other ends of the monitor cables to the monitors.
3. Connect one end of the monitor power cord to the monitor and the other end to an AC outlet.
4. Configure the monitor. For details, refer to Microsoft Help or to <http://www.microsoft.com>.

For monitor setup in Linux, you can often use the settings tool for the graphics cards (e.g., NVIDIA nvidia-settings or AMD Catalyst Control Center). In some recent Linux releases, the window manager system (e.g., Gnome 3) preferences must also be modified.



## Customizing the monitor display (Windows)

You can manually select or change the monitor model, refresh rates, screen resolution, color settings, font sizes, and power management settings.

- To change display settings for Windows 10, type `control panel` in the taskbar search box, and then select **Control Panel**. Select **Appearance and Personalization**, then **Display**.
- To change display settings in Windows 7, right-click a blank area on the desktop, and then click **Screen Resolution**.

For more information about customizing your monitor display, see the following resources:

- Online documentation provided with the graphics controller utility
- Documentation included with your monitor

## Power management features

### ERP compliance mode

This computer provides ERP compliance mode capability.

When this feature is enabled, the computer shuts down to the lowest possible power state.

When this feature is disabled, the computer shuts down conventionally.

Item	Description
<b>Enabling ERP compliance mode</b>	1. Power on or restart the computer and press <b>F10</b> during startup to launch the Computer Setup (F10) utility.
	2. Disable Wake-on LAN.
	3. Using the arrow keys, select <b>Advanced</b> , and then <b>Power Management Options</b> .
	4. Select <b>S5 Maximum Power Savings</b> .
	5. Select <b>Exit</b> , and then select <b>Save Changes and Exit</b> .
	6. If using Windows 10, boot to Windows and search in the Start Menu for the setting <b>Change what the power buttons do</b> . Uncheck <b>Turn on fast startup (recommended)</b> . If the checkbox is not available, select <b>Change settings that are currently unavailable</b> at the top of the window.
<b>Disabling ERP compliance mode</b>	1. Power on or restart the computer and press <b>F10</b> during startup to launch the Computer Setup (F10) utility.
	2. Enable Wake-on LAN.
	3. Using the arrow keys, select <b>Advanced</b> , and then <b>Power Management Options</b> .
	4. Disable <b>S5 Maximum Power Savings</b> .
	5. Select <b>Exit</b> , and then select <b>Save Changes and Exit</b> .
	6. If using Windows 10, boot to Windows and search in the Start Menu for the setting <b>Change what the power buttons do</b> . Check <b>Turn on fast startup (recommended)</b> . If the check box is not available, select <b>Change settings that are currently unavailable</b> at the top of the window.

## Hyper-Threading Technology (HTT)

This computer supports HTT, an Intel-proprietary technology that improves processor performance through parallelization of computations (doing multiple tasks at once).

The operating system treats an HTT-enabled processor as two virtual processors and shares the workload between them when possible. This feature requires that the operating system support multiple processors and be specifically optimized for HTT.

Use the Computer Setup (F10) Utility to enable HTT.

Go to <http://www.hp.com/go/quickspecs> to determine if your CPU supports HTT.

## SATA Power Management

SATA Power Management enables or disables SATA bus and/or device power management.

## Intel Turbo Boost Technology

The HP Z Workstation series supports Intel® Turbo Boost Technology.

This feature enables the CPU to run at frequencies above the normal frequency. When all CPU cores are not necessary for the workload, inactive cores are turned off and power is diverted to the active cores to increase their performance.

Turbo Boost is enabled and disabled with the Computer Setup (F10) Utility.

Go to <http://www.hp.com/go/quickspecs> to determine if your CPU supports Turbo Boost.

## BIOS ROM

The BIOS ROM is a collection of machine language applications stored as firmware in ROM. It includes functions such as Power-On Self-Test (POST), PCI device initialization, Plug and Play support, power management, and Computer Setup (F10) Utility.

Go to <http://www.hp.com/go/quickspecs> to review the latest BIOS ROM specifications.

## Computer Setup (F10) Utilities

Use Computer Setup (F10) Utility to do the following:

- Change settings from the defaults or restore the settings to default values.
- View the system configuration, including settings for processor, graphics, memory, audio, storage, communications, and input devices.
- Modify the boot order of bootable devices such as hard drives, optical drives, or USB flash media devices.
- Establish an Ownership Tag, the text of which is displayed each time the system is turned on or restarted.
- Enter the Asset Tag or property identification number assigned by the company to this computer.
- Enable the power-on password prompt during system restarts (warm boots) as well as during power-on.
- Establish an administrator password that controls access to the Computer Setup (F10) Utility and the settings described in this section.
- Establish minimum requirements for valid passwords, including length and required types of characters.

- Secure integrated I/O functionality, including the serial, USB, or audio, or embedded NIC, so that they cannot be used until they are unsecured.
- Enable or disable different types of boot sources.
- Configure features such as Secure Boot, power management, virtualization support, and language and keyboard type used in Setup and POST.
- Replicate the system setup by saving system configuration information on a USB device and restoring it on one or more computers.
- Enable or disable DriveLock security or securely erase a hard drive (when supported by drive).

## Using Computer Setup (F10) Utilities

Computer Setup can be accessed only by turning the computer on or restarting the system. To access the Computer Setup Utilities menu, complete the following steps:

1. Turn on or restart the computer.
2. Repeatedly press **F10** when the monitor light turns on to access the utility.

You can also press **Esc** to a menu that allows you to access different options available at startup, including the Computer Setup utility.



**NOTE:** If you do not press **F10** at the appropriate time, you must restart the computer and again repeatedly press **F10** when the monitor light turns green to access the utility.

---

3. A choice of four headings appears in the Computer Setup Utilities menu: Main, Security, Advanced, and UEFI Drivers.



**NOTE:** Selecting UEFI Drivers restarts the computer into the 3rd party option ROM management application. You can access this application directly by pressing **F3** during startup.

---

4. Use the arrow (left and right) keys to select the appropriate heading. Use the arrow (up and down) keys to select the option you want, then press **Enter**. To return to the Computer Setup Utilities menu, press **Esc**.

5. To apply and save changes, select **Main > Save Changes and Exit**.

- If you have made changes that you do not want applied, select **Ignore Changes and Exit**.
- To restore settings from the Advanced and Main menus to original values, select **Apply Factory Defaults and Exit**.
- To restore settings from the Advanced and Main menus to those previously saved by **Save Custom Defaults**, select **Apply Custom Defaults and Exit**. If no custom defaults have been saved, then factory defaults are used.



**NOTE:** Settings in the **Security** menu are not modified by **Apply Defaults**. Those values are reset by **Restore Security Settings to Factory Defaults** at the bottom of the **Security** menu.

---



**NOTE:** Not all settings shown in the following sections are available for all models

---

**CAUTION:** Do NOT turn the computer power OFF while the BIOS is saving the Computer Setup (F10) changes because the settings could become corrupted. It is safe to turn off the computer only after exiting the F10 Setup screen.

---

## Computer Setup—Main



**NOTE:** Support for specific Computer Setup options may vary depending on the hardware configuration.

**Table 2-1 Computer Setup—Main**

Option	Description
<b>System Information</b>	<p>Lists all information in following list if <b>Advanced System Information</b> is selected. Lists smaller subset if <b>Basic System Information</b> is selected.</p> <ul style="list-style-type: none"><li>• Product name</li><li>• Memory size</li><li>• Processor type</li><li>• Processor cache size (L1/L2/L3)</li><li>• Processor speed</li><li>• MicroCode Revision</li><li>• Processor Stepping</li><li>• Memory Speed</li><li>• SODIMM size (for each installed module)</li><li>• System BIOS version</li><li>• ME Firmware version</li><li>• Primary Video BIOS version</li><li>• Super I/O Firmware version</li><li>• Serial Number</li><li>• SKU number</li><li>• UUID (Universally Unique Identifier)</li><li>• Asset Tracking Number</li><li>• Feature Byte</li><li>• Build ID</li><li>• Product Family</li><li>• System Board ID</li><li>• System Board CT</li><li>• Integrated MAC Address</li></ul>
<b>System Diagnostics</b>	<p>If the hard drive has the HP Advanced Diagnostics installed, the application will launch. If HP Advanced Diagnostics is not installed, then a basic version built into the BIOS will provide the capability to perform the following functions:</p> <ul style="list-style-type: none"><li>• Memory Test</li><li>• Hard Drive Check</li><li>• Language</li></ul>
<b>Update System BIOS</b>	<p>Lets you update the system BIOS from <a href="http://www.hp.com">www.hp.com</a> or another network server, from a removable USB drive, or from a file located on the hard drive.</p> <ul style="list-style-type: none"><li>• 'Check HP.com for BIOS Updates' or 'Check the Network for BIOS Updates'</li></ul> <p>The string that appears here depends on the setting in 'BIOS Update Preferences'.</p>

**Table 2-1 Computer Setup—Main (continued)**

Option	Description
	<ul style="list-style-type: none"><li>• Lock BIOS Version If this option is checked, the system is locked to the current BIOS version and updates are not allowed.</li><li>• BIOS Update Preferences Allows the administrator to select the source of network updates (www.hp.com or another network server) and allows configuration of a periodic check for updates, including policies for:<ul style="list-style-type: none"><li>■ Check for updates and prompt the user to accept or reject the update at that time</li><li>■ Check for updates and install all new versions</li><li>■ Check for updates and install only new versions marked important</li></ul></li><li>• Network Configuration Settings</li><li>• Update BIOS Using Local Media Lets you access files on either USB storage or the hard drive. The HP BIOS Update and Recovery application included in BIOS Softpaqs at www.hp.com will copy the BIOS file to the correct location on the hard drive or USB device.</li></ul>
<b>System IDs</b>	Lets you set the following values: <ul style="list-style-type: none"><li>• Asset Tracking Number</li><li>• Ownership Tag</li><li>• Change Date &amp; Time</li><li>• Set Machine Unique Data</li></ul>
<b>Replicated Setup</b>	<b>Backup current settings to USB device</b> Saves system configuration to a formatted USB flash media device. <b>Restore current settings from USB device</b> Restores system configuration from a USB flash media device.
<b>Save Custom Defaults</b>	Saves the current system configuration settings as the custom default set.
<b>Apply Custom Defaults and Exit</b>	Applies the custom default settings to the computer after rebooting. Does not apply to options in the <b>Security</b> menu.
<b>Apply Factory Defaults and Exit</b>	Restores the factory system configuration settings to the computer after rebooting. Does not apply to options in the <b>Security</b> menu.
<b>Ignore Changes and Exit</b>	Exits Computer Setup without applying or saving any changes.
<b>Save Changes and Exit</b>	Saves changes to current system configuration, exits Computer Setup, and reboots.

## Computer Setup—Security



**NOTE:** Support for specific Computer Setup options may vary depending on the hardware configuration.

**Table 2-2 Computer Setup—Security**

Option	Description
<b>Set up BIOS Administrator Password</b>	<p>Lets you set and enable a BIOS administrator password, which includes the following privileges:</p> <ul style="list-style-type: none"><li>• Manage other BIOS users</li><li>• Full access to BIOS policy and settings</li><li>• Unlock the computer when other BIOS users fail the preboot authentication.</li></ul> <p><b>NOTE:</b> Creating a BIOS user disables the Fast Boot option.</p> <p><b>NOTE:</b> If the password is set, it is required to change Computer Setup options, update the BIOS, and make changes to certain plug and play settings under Windows.</p>
<b>Change BIOS Administrator Password</b>  (This selection is active only if a BIOS administrator password is set.)	<p>Lets you change the BIOS administrator password.</p> <p>You must know the current password to be able to change it.</p>
<b>Password Policies</b>	<p>Let you set the guidelines for a valid password. Options include:</p> <ul style="list-style-type: none"><li>• Password minimum length</li><li>• Requires at least one symbol</li><li>• Requires at least one number</li><li>• Requires at least one upper case character</li><li>• Requires at least one lower case character</li><li>• Allows spaces</li></ul> <p><b>Clear Password Jumper</b></p> <p>Select 'Honor' to allow or 'Ignore' to not allow the absence of the password jumper to clear the passwords at boot up. Default is 'Honor'.</p> <p><b>Prompt for Admin password on F9 (Boot Menu)</b></p> <p><b>Prompt for Admin password on F11 (System Recovery)</b></p> <p><b>Prompt for Admin password on F12 (Network Boot)</b></p>
<b>Security Configuration</b>	<p><b>TPM Embedded Security</b></p> <ul style="list-style-type: none"><li>• <b>TPM Device</b></li></ul> <p>Lets you set the Trusted Platform Module as available or hidden.</p> <ul style="list-style-type: none"><li>• <b>TPM State</b></li></ul> <p>Select to enable the TPM.</p> <ul style="list-style-type: none"><li>• <b>TPM Clear</b></li></ul> <p>Select to reset the TPM to an unowned state. After the TPM is cleared, it is also turned off. To temporarily suspend TPM operations, turn the TPM off instead of clearing it.</p> <p><b>CAUTION:</b> Clearing the TPM resets it to factory defaults and turns it off. You will lose all created keys and data protected by those keys.</p>

**Table 2-2 Computer Setup—Security (continued)**

Option	Description
	<ul style="list-style-type: none"> <li>• <b>TPM Specification Version</b></li> <li>• <b>TPM Activation Policy</b></li> </ul> <p><b>BIOS Sure Start</b></p> <ul style="list-style-type: none"> <li>• <b>Verify Boot Block on every Boot</b> Select to check validity of boot block region on every boot. If not selected, boot block region will be validated on power cycles.</li> <li>• <b>Data Recovery Policy</b> Select 'Automatic' or 'Manual' to set data recovery policy. 'Manual' lets you select whether or not to execute recovery of a corrupted region if it is detected.</li> </ul> <p><b>Dynamic Runtime Scanning of Boot Block</b> Verifies the integrity of the BIOS boot block region several times each hour while the system is running.</p>
<b>Set Up BIOS Power-On Password</b>	Lets you set and enable a BIOS power-on password. The power-on password prompt appears after a power cycle or reboot. If the user does not enter the correct power-on password, the unit will not boot.
<b>Change BIOS Power-On Password (This selection is active only if a BIOS power-on password is set.)</b>	Lets you change the BIOS power-on password. You must know the current password to be able to change it.
<b>DriveLock</b>	<p>Allows you to assign or modify a master or user password for hard drives. When this feature is enabled, the user is prompted to provide one of the DriveLock passwords during POST. If neither is successfully entered, the hard drive will remain inaccessible until one of the passwords is successfully provided during a subsequent cold-boot sequence.</p> <p><b>NOTE:</b> This selection will only appear when at least one drive that supports the DriveLock feature is attached to the system.</p> <p><b>CAUTION:</b> Be aware that these settings take place immediately. A save is not necessary.</p> <p><b>CAUTION:</b> Be sure to document the DriveLock password. Losing a DriveLock password will render a drive permanently locked.</p> <p>After you select a drive, the following options are available:</p> <p><b>Set DriveLock Master Password.</b> Sets the drive's master password but does not enable DriveLock.</p> <p><b>Enable DriveLock.</b> Sets the drive's user password and enables DriveLock.</p> <p><b>DriveLock Password on restart.</b> Lets you require entry of the DriveLock password when restarting.</p>
<b>Secure Erase</b>	<p>Lets you select a hard drive to completely erase.</p> <p>Once a hard drive has been erased with a program that utilizes Secure Erase firmware commands, no file recovery program, partition recovery program, or other data recovery method will be able to extract data from the drive.</p>
<b>System Management Command</b>	Allows authorized personnel to reset security settings during a service event. Default is enabled.
<b>Restore Security Settings to Default</b>	This action resets security devices, clears BIOS passwords (not including DriveLock), and restores settings in the <b>Security menu</b> to factory defaults.

## Computer Setup—Advanced



**NOTE:** Support for specific Computer Setup options may vary depending on the hardware configuration.

**Table 2-3 Computer Setup—Advanced (for advanced users)**

Option	Description
<b>Display Language</b>	Lets you select the language of the menus in F10 Setup and the keyboard layout.
<b>Scheduled Power-On</b>	This feature wakes the system up from a powered off state at a specified date and time.
<b>Boot Options</b>	<p>Select the devices that the computer can boot from, as well as other options, including:</p> <ul style="list-style-type: none"> <li>• Startup Menu Delay(sec). Enabling this feature will add a user-specified delay to the POST process. One purpose for the delay is to provide additional time to activate hotkeys such as <b>Esc</b> for the Startup Menu or <b>F10</b> for Computer Setup.</li> <li>• Fast Boot. Default is enabled for Windows 10 or later, and disabled for Windows 7 systems.</li> <li>• CD-ROM Boot. Default is enabled.</li> <li>• Network (PXE) Boot. Default is enabled.</li> <li>• Prompt on Memory Size Change. Default is enabled.</li> <li>• Prompt on Fixed Storage Change. Default is disabled.</li> <li>• After Power Loss. Default is Power Off. <ul style="list-style-type: none"> <li>■ Power off—causes the computer to remain powered off when power is restored.</li> <li>■ Power on—causes the computer to power on automatically as soon as power is restored.</li> <li>■ Previous state—causes the computer to power on automatically as soon as power is restored, if it was on when power was lost.</li> </ul> </li> </ul> <p><b>NOTE:</b> If the system is configured to 'Power On from Keyboard Ports' (see Power Management Options), then this setting is forced to 'Power On'.</p> <ul style="list-style-type: none"> <li>• Audio Alerts During Boot. Default is enabled. When disabled, most audible beeps from errors, warnings, and password prompts during boot up are suppressed.</li> <li>• UEFI Boot Order. <p>Default is enabled. Specify the order in which UEFI boot sources (such as a internal hard drive, USB hard drive, USB optical drive, or internal optical drive) are checked for a bootable operating system image.</p> <p>UEFI boot sources always have precedence over legacy boot sources.</p> </li> <li>• Legacy Boot Order <p>Specify the order in which legacy boot sources (such as a network interface card, internal hard drive, USB optical drive, or internal optical drive) are checked for a bootable operating system image.</p> <p>Specify the order of attached hard drives. The first hard drive in the order will have priority in the boot sequence and will be recognized as drive C (if any devices are attached).</p> </li> </ul> <p><b>NOTE:</b> To drag a device to a preferred place, press <b>Enter</b>.</p> <p><b>NOTE:</b> MS-DOS drive lettering assignments may not apply after a non-MS-DOS operating system has started.</p> <p><b>Shortcut to Temporarily Override Boot Order</b></p> <p>To boot <b>one time</b> from a device other than the default device specified in Boot Order, restart the computer and press <b>Esc</b> (to access the Startup menu) and then <b>F9</b> (Boot Menu), or only <b>F9</b> (skipping the Startup menu) when the monitor light turns green. After POST is completed, a list of bootable devices is displayed. Use the arrow keys to select the preferred bootable device and press <b>Enter</b>. The computer then boots from the selected non-default device for this one time.</p>

**Secure Boot Configuration****Configure Legacy Support and Secure Boot**



**Table 2-3 Computer Setup—Advanced (for advanced users) (continued)**

Option	Description
	<p>Legacy Support – Lets you turn off all legacy support on the computer, including booting to DOS, running legacy graphics cards, booting to legacy devices, and so on. Windows 7 for instance requires legacy support, whereas Windows 10 does not.</p>
	<p>Secure Boot – Lets you make sure an operating system is legitimate before booting to it, making Windows resistant to malicious modification from preboot to full OS booting, preventing firmware attacks. UEFI and Windows Secure Boot only allow code signed by pre-approved digital certificates to run during the firmware and OS boot process.</p>
	<p>Default is 'Legacy Support Enable and Secure Boot Disable' for Windows 7 and other non-Windows configurations. Default is 'Legacy Support Disable and Secure Boot Enable' for Windows 10 and later configurations.</p>
	<p><b>Secure Boot Key Management</b> Lets you manage the custom key settings.</p>
	<p><b>Clear Secure Boot Keys</b> Lets you delete any previously loaded custom boot keys. Clearing keys will disable secure boot. Default is disabled.</p>
	<p><b>Reset Secure Boot keys to factory defaults</b> Default is disabled.</p>
	<p><b>Enable MS UEFI CA key</b> Disabling this setting alters the Secure Boot key list to further restrict the allowed software components. Set this option to 'disable' to support Device Guard.</p>
<b>System Options</b>	<p><b>Virtualization Technology (VTx)</b> (Intel only) Controls the virtualization features of the processor. Changing this setting requires turning the computer off and then back on. Default is disabled.</p>
	<p><b>Virtualization Technology for Directed I/O (VTd)</b> (Intel only) Controls virtualization DMA remapping features of the chipset. Changing this setting requires turning the computer off and then back on. Default is disabled.</p>
	<p><b>Power Button Override</b> (disable/4 sec/15 sec) Lets you disable or enable and select the number of seconds you have to hold down the power button for it to force the system to power off. Default is '4 sec'.</p>
	<p><b>Max SATA Speed</b> (6.0 Gbps/3/0 Gbps) Lets you set the maximum SATA speed.</p>
	<p><b>TurboBoost</b> (disable/enable) Allows you to enable and disable the Intel Turbo Mode feature, which allows one core of the system to run at a higher than standard frequency and power if other cores are idle. Default is enabled.</p>
	<p><b>Hyperthreading</b> (disable/enable) Use this option to disable processor hyper-threading. Default is enabled.</p>
	<p><b>Multiprocessor</b> (disable/enable) Use this option to disable multi-processor support under the OS. Default is enabled.</p>
<b>Built-In Device Options</b>	<p><b>Embedded LAN Controller</b> Select to show the device in the operating system. Default is enabled.</p>
	<p><b>Wake On LAN</b></p>

**Table 2-3 Computer Setup—Advanced (for advanced users) (continued)**

Option	Description
	<p>Lets you either disable the Wake On LAN feature, or configure where the computer boots, including the network or hard drive. Default is Boot to Network.</p> <p><b>Video Memory Size</b></p> <p>Use this option to manage graphics memory allocation. The value you choose is allocated permanently to graphics and is unavailable to the operating system.</p> <p><b>Audio Device</b></p> <p>Select to show the device in the operating system. Default is enabled.</p> <p><b>Internal Speakers</b> (does not affect external speakers)</p> <p>Clear to disable the chassis speaker. This function is applicable to normal audio playback in the operating system and does not affect the error or warning beeps during POST. Default is enabled.</p> <p><b>Increase Idle Fan Speed(%)</b></p> <p>Sets idle fan speed percentage. This setting only changes the minimum fan speed. The fan is still automatically controlled.</p>
<b>Port Options</b>	<p>Allows you to hide the following ports from the operating system:</p> <ul style="list-style-type: none"> <li>• SATA0</li> <li>• Rear USB Ports</li> <li>• Left USB Ports</li> <li>• Rear USB Port 1</li> <li>• Rear USB Port 2</li> <li>• Left USB port 1</li> <li>• Left USB Port 2</li> <li>• M.2 SSD1</li> <li>• M.2 WLAN/BT</li> </ul> <p><b>Restrict USB Devices</b></p> <p>Specify the following categories of USB devices to enable:</p> <ul style="list-style-type: none"> <li>• Allow all USB devices</li> <li>• Allow only keyboard and mouse</li> <li>• Allow all but storage devices and hubs.</li> </ul> <p>When some devices are restricted, the system will disable USB ports that do not meet the allowed criteria. This feature is usually combined with similar policies within the operating system since USB devices can be moved to different ports. The ports disabled by the BIOS will remain disabled until the system is restarted.</p>
<b>Option ROM Launch Policy</b>	<p>These policies control whether Legacy Option ROMs or UEFI drivers are loaded. Default is 'All legacy' for Windows 7 and non-Windows configurations. Default is 'All UEFI' for Windows 10 or later.</p> <p><b>Configure Option ROM Launch Policy</b></p> <ul style="list-style-type: none"> <li>• All legacy</li> <li>• All UEFI</li> <li>• All UEFI except video</li> </ul>
<b>Power Management Options</b>	<b>Runtime Power Management</b> (enable/disable)

**Table 2-3 Computer Setup—Advanced (for advanced users) (continued)**

Option	Description
	<p>Allows certain operating systems to reduce processor voltage and frequency when the current software load does not require the full capabilities of the processor. Default is enabled.</p>
	<p><b>Extended Idle Power States</b> (enable/disable)</p>
	<p>Allows certain operating systems to decrease the processors power consumption when the processor is idle. Default is enabled.</p>
	<p><b>S4/S5 Maximum Power Savings</b> (enable/disable)</p>
	<p>Enabling this feature reduces the power of the system as much as possible in the S4 or S5 state. Power is removed from expansion slots. Default is disabled.</p>
	<p><b>SATA Power Management</b> (enable/disable)</p>
	<p>Enables or disables SATA bus and/or device power management. Default is enabled.</p>
	<p><b>Unique Sleep State Blink Rates</b> (enable/disable)</p>
	<p>This feature is designed to provide a visual indication of what sleep state the system is in. Each sleep state has a unique blink pattern. Power button lights will not light in Maximum Power Savings mode when system is not in S3 (Stand By) or S0 (On) states. Default is disabled.</p>
	<p><b>NOTE:</b> A normal shutdown goes to the S4 state for Windows 10 or later.</p>
	<p>S0 (On) = Solid white light.</p>
	<p>S3 (Stand By)= 3 blinks at 1Hz (50% duty cycle) followed by a pause of 2 seconds (white light) — repeated cycles of 3 blinks and a pause.</p>
	<p>S4 (Hibernation)= 4 blinks at 1Hz (50% duty cycle) followed by a pause of 2 seconds (white light) — repeated cycles of 4 blinks and a pause.</p>
	<p>S5 (Soft Off) = light is off.</p>
<b>Remote Management Options</b>	<p><b>Active Management (AMT)</b> (enable/disable). Default is enabled.</p>
	<p>Allows you to discover, repair, and protect networked computing devices.</p>
	<p><b>USB Key Provisioning Support</b> (enable/disable) Default is disabled.</p>
	<p><b>USB Redirection Support</b> (enable/disable). Default is enabled.</p>
	<p>USB redirection allows USB devices plugged into a client computer to be transparently redirected to the guest operating system.</p>
	<p><b>Unconfigure AMT on next boot</b> (Do Not Apply/Apply). Default is 'Do Not Apply'.</p>
	<p><b>SOL Terminal Emulation Mode</b> (ANSI / VT100). Default is ANSI.</p>
	<p>SOL terminal emulation mode is only activated during remote AMT redirection operations. The emulation options allow administrators to select which mode works best with their console.</p>
	<p><b>Show Unconfigure ME Confirmation Prompt</b> (enable/disable). Default is enabled.</p>
	<p><b>Verbose Boot Messages</b> (enable/disable). Default is enabled.</p>
	<p>Verbose boot shows additional logging information during the boot. mainly for debugging if something goes wrong during bootup.</p>
	<p><b>Watchdog Timer</b> (enable/disable). Default is enabled.</p>
	<p>Allows you to set amount of time for an operating system and BIOS watchdog alert to be sent if the timers are not deactivated. BIOS watchdog is deactivated by BIOS and would indicate that a halt occurred during execution if the alert is sent to the management console. An operating system alert is deactivated by the operating system image and would indicate that a hang occurred during its initialization.</p>
	<ul style="list-style-type: none"> <li>OS Watchdog Timer (min.) – (5/10/15/20/25). Default is 5 min.</li> </ul>
	<ul style="list-style-type: none"> <li>BIOS Watchdog Timer (min.) – (5/10/15/20/25). Default is 5 min.</li> </ul>

**Table 2-3 Computer Setup—Advanced (for advanced users) (continued)**

Option	Description
	<b>CIRA Timeout (min.)</b> (1/2/3/4/Never)
	CIRA is Customer Initiated Remote Assistance, an Intel service to help users employing Active Management Technology (AMT).

# Desktop management

This section summarizes capabilities, features, and key components of computer management.

---

## Topics

---

[Initial computer configuration and deployment on page 30](#)

---

[Installing a remote system on page 30](#)

---

[Copying a setup configuration to another computer on page 30](#)

---

[Updating and managing software on page 31](#)

---

[LANDesk Software on page 31](#)

---

[HP SoftPaq Download Manager on page 31](#)

---

[HP System Software Manager on page 31](#)

---

[ROM Flash on page 32](#)

---

[FailSafe Boot Block on page 32](#)

---

[Computer security on page 33](#)

---

[Fault notification and recovery on page 39](#)

---

[Dual-state power button on page 39](#)

---



**NOTE:** Support for specific features described in this guide can vary by model and software version.

---

## Initial computer configuration and deployment

The computer includes a preinstalled system software image. After a brief software unbundling process, the computer is ready to use.

If you prefer to replace the preinstalled software image with a customized set of system and application software, you can deploy a customized software image using either of the following methods:

- Installing additional software applications after unbundling the preinstalled software image
- Using a disk-cloning process to copy the contents from one hard drive to another

The HP Recovery Manager DVDs, ROM-based setup, and Advanced Configuration and Power Interface (ACPI) hardware provide further assistance with recovery of system software, configuration management and troubleshooting, and power management.

Support for specific features described in this guide can vary by model and software version.

The best deployment method depends on the information technology environment and processes.

## Installing a remote system

When the computer has been configured as a remote system, you can start it and set it up by using software and configuration information on a network server. This feature is usually used for system setup and configuration, and can be used to perform the following functions:

- Deploy a software image on new PCs
- Format a hard drive
- Install application software or drivers
- Update the operating system, application software, or drivers

To initiate a remote system installation, press **F12** when **F12=Network Service Boot** appears in the lower right corner of the HP logo screen. Follow the onscreen instructions to continue the installation process. The default boot order can be changed in the BIOS so that the system always attempts to boot from the network.

## Copying a setup configuration to another computer

This section provides information about replicating the computer setup.

---

 **CAUTION:** Setup configuration is model specific. File system corruption can result if source and target computers are not the same model.

---

To copy a setup configuration:

1. Select a computer to use as the source of the setup configuration.
2. Connect a removable storage device to the computer, and then restart the computer.
3. As soon as the computer turns on, press and hold **F10** until you enter Computer Setup (F10) Utility. If necessary, press **Enter** to bypass the title screen.

---

 **NOTE:** If you do not press **F10** at the appropriate time, you must restart the computer, and then press and hold **F10** to access the utility.

---

4. Select **Main**, select **Replicated Setup**, and then select **Backup current setting to USB device**. Follow the instructions on the screen to create the configuration file `Hpsetup.txt` and write it to a USB storage device.

5. Turn off the computer you want to configure (the target computer), and connect the removable storage device that contains the configuration.
6. Turn on the target computer.
7. Press and hold the **F10** key until you enter Computer Setup (F10) Utility. If necessary, press **Enter** to bypass the title screen.
8. Select **Main**, select **Replicated Setup**, and then select **Restore current settings from USB device**. Follow the instructions on the screen.
9. Restart the computer when the configuration is complete.

## Updating and managing software

HP provides several tools for managing and updating software on desktops and computers:

- LANDesk Software
- HP Driver Pack
- HP SoftPaq Download Manager
- System Software Manager

### LANDesk Software

LANDesk and HP have partnered to help HP customers increase control over IT resources, reduce risks associated with owning them, and boost productivity within the IT environment.

Centrally leverage and manage the power of HP Professional Innovation tools with these features:

- Deployment and migration
- Remote assistance
- Mobile user and device management
- Energy conservation and power management
- HP hardware management

Go to <http://www.landesk.com/partners/hp/client-management/> for more information about LANDesk Client Management Solutions for HP.

### HP SoftPaq Download Manager

HP SoftPaq Download Manager is a free, easy-to-use interface for locating and downloading software updates for the HP client PC models in your environment. By specifying your models, operating system, and language, you can quickly locate, sort, and select the SoftPaqs you need, as well as create your own Driver Pack for OS deployment. For more information, go to <http://www8.hp.com/us/en/ads/clientmanagement/drivers-bios.html#softpaq-download-mng>.

### HP System Software Manager

HP System Software Manager (SSM) is a utility that is available on Windows computers. It enables you to update system-level software on multiple systems simultaneously. When executed on a PC client system, SSM detects hardware and software versions and then updates the software from a central repository, known as a *file store*. Driver versions supported by SSM are noted with a special icon in the software, on the driver download website, and on the Support Software CD.

To download the utility or to obtain more information about SSM, go to <http://www8.hp.com/us/en/ads/clientmanagement/drivers-bios.html#system-sw-mng>.

## ROM Flash

BIOS settings are stored on a programmable flash ROM. By establishing a setup password in Computer Setup (F10) Utility, you can protect unauthorized users from modifying the BIOS settings. This function is important to ensure the operating integrity of the computer.

To upgrade the BIOS, download the latest SoftPaq images from [http://www.hp.com/support/workstation\\_swdrivers](http://www.hp.com/support/workstation_swdrivers).

## Remote ROM Flash

Remote ROM Flash allows system administrators to safely upgrade the ROM on remote HP computers from a centralized network management console, resulting in a consistent deployment of, and greater control over, HP PC ROM images over the network.

To use Remote ROM Flash, the computer must be turned on, or turned on using Remote Wakeup.

For more information about Remote ROM Flash and HPQFlash, see the HP Client Manager Software or System Software Manager sections at <http://www.hp.com/go/ssm>.

## HPBiosUpdRec

The HPBiosUpdRec utility is used to locally update or restore the system ROM on PCs using a Windows operating system. For more information about HPBiosUpdRec, go to <http://www.hp.com/go/ssm>, and enter the name of the computer.

## FailSafe Boot Block

FailSafe Boot Block enables BIOS recovery in the unlikely event of a ROM flash failure.

For example, if a power failure occurs during a ROM upgrade, Boot Block uses a flash-protected section of the ROM to verify a valid system ROM flash when power is restored to the computer.

If the system ROM is valid, the computer starts normally. If the system ROM fails the validation check, FailSafe Boot Block provides enough support to start the computer from a BIOS image CD that has been created from a SoftPaq. The BIOS image CD programs the system ROM with a valid image.

When Boot Block detects an invalid system ROM, the computer power light blinks red eight times and the computer beeps eight times; then the computer pauses for two seconds. On some models, a Boot Block recovery mode message appears.

In preparation for system recovery, use the BIOS CD media file in the SoftPaq to create a BIOS image CD or USB flash drive.



## Recovering the computer from Boot Block Recovery mode

To recover the computer after it enters Boot Block recovery mode:

1. Remove any media such as USB flash drives or discs in the optical drives.
2. Insert a BIOS image CD into the DVD drive. You can also use USB media such as an HP DriveKey.
3. Turn the computer off, and then turn it on.

If no BIOS image CD or USB media is found, you are prompted to insert one and restart the computer.

If a setup password has been established, the Caps Lock light turns on and you are prompted for the password.

4. Enter the setup password.

If the computer starts from the boot media and successfully reprograms the ROM, three keyboard lights turn on and a rising-tone series of beeps signals successful recovery.

5. Remove the boot media and turn off the computer.
6. Restart the computer.

## Computer security

This section provides information about providing system security through asset tracking, password security, hard drive locking, and chassis locks.

### Asset tracking

Asset tracking features provide data that can be managed using HP Systems Insight Manager (HP SIM), HP Console Management Controller (CMC), or other systems-management applications.

Seamless, automatic integration between asset tracking features and these products enables you to choose the management tool that is best suited to the environment and to leverage investments in existing tools.

HP also offers several solutions for controlling access to valuable components and information:

- Capability for protecting valuable data assets by disabling parallel, serial, or USB ports, or by disabling removable-media boot capability
- Memory Change alerts, which can be forwarded to system management applications to deliver proactive notification of tampering with a computer's internal components

You can manage security settings as follows:

- Locally, with Computer Setup (F10) Utility
- Remotely, with HP CMS or HP System Software Manager (SSM), which enable the secure, consistent deployment and control of security settings from a simple command line utility

For more information about Computer Setup (F10) Utility, see [Computer Setup \(F10\) Utilities on page 18](#).

The following Computer Setup (F10) Utility features let you manage computer security.

Feature	Purpose
Removable Media Boot Control	Prevents booting from removable media drives
USB Interface Control	Prevents transfer of data through the integrated USB interface

Feature	Purpose
Power-On Password	Prevents use of the computer until the password is entered (applies to initial system startup and restarts)
Setup Password	Prevents reconfiguration of the computer (through Computer Setup (F10) Utility) until the password is entered

## SATA hard drive security

HP computers include the HP DriveLock facility for SATA hard drives to prevent unauthorized access to data.

**⚠ WARNING!** Enabling DriveLock can render a SATA hard drive permanently inaccessible if the master password is lost or forgotten. No method exists to recover the password or access the data.

DriveLock has been implemented as an extension to Computer Setup (F10) Utility functions. It is only available when hard drives that support the ATA security command set are detected.

DriveLock is for HP customers for whom data security is the paramount concern. For such customers, the cost of a hard drive and the loss of the data stored on it is inconsequential when compared to the damage that could result from unauthorized access to its contents.

To balance this level of security with the need to address the issue of a forgotten password, the HP implementation of DriveLock employs a two-password security scheme. One password is intended to be set and used by a system administrator, while the other is typically set and used by the user.

No "back door" can be used to unlock the drive if both passwords are lost. Therefore, DriveLock is most safely used when the data contained on the hard drive is replicated on a corporate information system or is regularly backed up.

If both DriveLock passwords are lost, the hard drive is inaccessible. For users who do not fit the previously defined customer profile, this outcome might not be acceptable. For users who fit this profile, the outcome might be a tolerable risk, given the nature of the data stored on the hard drive.

### DriveLock applications

The most practical use of DriveLock is in a corporate environment. The system administrator would be responsible for configuring the hard drive, which involves setting the DriveLock master password and a temporary user password. If the system administrator forgets the user password or if the equipment is passed on to another employee, the master password can be used to reset the user password and restore access to the hard drive.

HP recommends that corporate system administrators who enable DriveLock also establish a corporate policy for setting and maintaining master passwords. This precaution will prevent loss of information if an employee sets both DriveLock passwords before leaving the company. In such a scenario, the hard drive is inaccessible and must be replaced. Likewise, by not setting a master password, system administrators might find themselves locked out of a hard drive and unable to perform routine checks for unauthorized software, other asset control functions, and support.

For users with less stringent security requirements, HP does not recommend enabling DriveLock. Users in this category include personal users, or users who do not maintain sensitive data on their hard drives as a common practice. For these users, the potential loss of a hard drive resulting from forgetting both passwords is much greater than the value of the data DriveLock protects.

Access to Computer Setup (F10) Utility and DriveLock can be restricted through the setup password. By specifying a setup password and not giving it to users, system administrators can restrict users from enabling DriveLock.

## Using DriveLock

When hard drives that support the ATA security command set are detected, DriveLock appears under the Security menu in the Computer Setup (F10) Utility menu. You are presented with options to set the master password and to enable DriveLock. You must provide a user password to enable DriveLock. Because the initial configuration of DriveLock is typically performed by a system administrator, a master password should be set first.

HP encourages system administrators to set a master password whether they plan to enable DriveLock or not. This gives the administrator the ability to modify DriveLock settings if the drive is locked in the future. After the master password is set, the system administrator can enable DriveLock or leave it disabled.

If a locked hard drive is present, POST requires a password to unlock the device. If a power-on password is set and it matches the device's user password, POST does not prompt the user to re-enter the password. Otherwise, the user is prompted to enter a DriveLock password.

For a cold start, use the master or user password. For a warm start, enter the same password used to unlock the drive during the preceding cold start.

Users have two attempts to enter a correct password. During cold start, if neither attempt succeeds, POST continues but the drive remains inaccessible. During a warm-start or restart from Windows, if neither attempt succeeds, POST halts and the user is instructed to cycle power.

## Enabling DriveLock

To enable and set the DriveLock user password:

1. Turn on or restart the computer.
2. As soon as the computer is turned on, repeatedly press the **F10** key until Computer Setup (F10) Utility starts.

If you do not press **F10** at the appropriate time, you must restart the computer, and then repeatedly press **F10** to access the utility.

3. Select **Security > DriveLock Security**.
4. For each DriveLock-capable drive, select the drive by pressing **Enter**.
5. Under Enable/Disable DriveLock options, select **Enable**, and then press **Enter** to enable DriveLock for that drive.

---

 **NOTE:** To set the DriveLock master password, select **Master**.

 **CAUTION:** If you forget the DriveLock password, the drive is inaccessible.

---

6. Enter a new user password (1 to 32 characters long), and then press **Enter** to accept.
7. Enter the password again in the **Enter New Password Again** field. If you forget this password, the drive is permanently disabled.
8. Select **Main > Save Changes and Exit**. Press **Enter** to accept the changes. After you press **Enter**, the computer performs a cold start before invoking the DriveLock function.

When the computer starts, you are prompted to enter the DriveLock password for each DriveLock-capable drive for which you have set a password. You have two attempts to enter the password correctly. If the password is not entered correctly, the computer attempts to start anyway. However, the boot process most likely fails because data from a locked drive cannot be accessed.

In a single-drive computer, when DriveLock is enabled, the computer might not be able to boot to the operating system, and might try to boot from the network or from another storage device (depending

on the boot ordering options). Regardless of the outcome of the start attempts, the locked drive remains inaccessible without the DriveLock password.

In a two-drive computer that has a boot drive and a data drive, you can apply the DriveLock feature to the data drive only. In this case, the computer can always start, but the data drive is accessible only when the DriveLock password is entered.

Cold starts require that you enter DriveLock passwords. However, DriveLock passwords are also required for warm starts. For example, if you boot to DOS and press **Ctrl+Alt+Del**, you must enter the DriveLock password before the computer completes the next start cycle. This warm-start behavior is consistent with the DriveLock feature.

## Password security

The power-on password prevents unauthorized access to applications or data when the computer is turned on or restarted. The setup password specifically prevents unauthorized access to the Computer Setup (F10) Utility and can also be used as an override to the power-on password. An administrator can enter the setup password at the prompt for the power-on password and gain access to the computer.

You can establish a network-wide setup password to enable the system administrator to log in to all network systems to perform maintenance without needing to know the power-on password.

### Establishing a setup password using Computer Setup (F10) Utility

Establishing a setup password through the Computer Setup (F10) Utility prevents reconfiguration of the computer (through the use of Computer Setup (F10) Utility) until the password is entered.

To establish a setup password using the Computer Setup (F10) Utility menu:

1. Turn on or restart the computer.
2. As soon as the computer is turned on, repeatedly press the **F10** key until you enter Computer Setup (F10) Utility.

If you do not press **F10** at the appropriate time, you must restart the computer, and then repeatedly press **F10** to access the utility.

3. Select **Security > Create BIOS Administrator Password**. Follow the onscreen instructions.
4. Before exiting, select **Main > Save Changes and Exit**.

### Establishing a power-on password using computer setup

Establishing a power-on password through Computer Setup (F10) Utility prevents access to the computer when power is connected, unless you specify the password. When a power-on password is set, Computer Setup (F10) Utility presents Password Options in the Security menu. The password options include Network Server Mode and Password Prompt on Warm Boot.

When Password Prompt on Warm Boot is enabled, you must enter the password. The password must also be entered each time the computer is restarted.

To establish a power-on password through the Computer (F10) menu:

1. Turn on or restart the computer.
2. As soon as the computer is turned on, repeatedly press the **F10** key until you enter Computer Setup (F10) Utility.

If you do not press **F10** at the appropriate time, you must restart the computer, and then repeatedly press **F10** to access the utility.

3. Select **Security > Create POST Power-On Password**, and then follow the on-screen instructions.
4. Before exiting, select **Main > Save Changes and Exit**.

### Entering a power-on password

To enter a power-on password:

1. Restart the computer.
2. When the key icon appears on the monitor, enter the current password, and then press **Enter**.

Type carefully. For security reasons, the characters you enter do not appear on the screen.

If you enter the password incorrectly, try again. After three unsuccessful tries, you will enter the F10 setup screen with read-only permission. (See the Setup Browse Mode option under the Power-On options.)

### Entering a setup password

If a setup password has been established on the computer, you will be prompted to enter it each time you run Computer Setup (F10) Utility.

To enter a setup password:

1. Restart the computer.
2. As soon as the computer is turned on, repeatedly press the **F10** key until you enter Computer Setup (F10) Utility.

If you do not press **F10** at the appropriate time, you must restart the computer, and then repeatedly press **F10** to access the utility.

3. When the key icon appears on the monitor, enter the setup password, and press **Enter**.

Type carefully. For security reasons, the characters you enter do not appear on the screen.

If you enter the password incorrectly, try again. After three unsuccessful tries, you must restart the computer before you can continue.

### Changing a power-on or setup password

To change a power-on or setup password:

1. Restart the computer.
2. To change the power-on password, go to step 4.
3. To change the setup password, as soon as the computer is turned on, repeatedly press the **F10** key until you enter Computer Setup (F10) Utility.

If you do not press **F10** at the appropriate time, you must restart the computer, and then repeatedly press **F10** to access the utility.

4. Go to **Security > Change BIOS Administrator or POST Power-On password**. You will be prompted for the old password and then the new one twice.

For information about the alternative delimiter characters, see [National keyboard delimiter characters on page 38](#).

Type carefully. For security reasons, the characters you enter do not appear on the screen.

5. Press **Enter**.

The new password takes effect the next time you turn on the computer.

The power-on and setup passwords can also be changed using the Security options in Computer Setup (F10) Utility.

### Deleting a power-on or setup password

To delete a power-on or setup password:

1. Turn on or restart the computer.
2. Choose from the following:
  - To delete the power-on password, go to step 4.
  - To delete the setup password, as soon as the computer is turned on, press and hold **F10** until you enter Computer Setup (F10) Utility. Press **Enter** to bypass the title screen, if necessary.  
  
If you do not press F10 at the appropriate time, you must restart the computer and then press and hold F10 again to access the utility.  
  
Use the appropriate operating system shutdown process.
3. Go to **Security > Change BIOS Administrator or POST Power-On password**. You will be prompted for the old password then hit Enter twice to clear out the old password.
4. Press **Enter**.

### National keyboard delimiter characters

Each keyboard meets country-specific requirements. The syntax and keys you use for changing or deleting passwords depend on the keyboard included with the computer.

Language	Delimiter	Language	Delimiter	Language	Delimiter
Arabic	/	Greek	-	Russian	/
Belgian	=	Hebrew	.	Slovakian	-
BHCSY*	-	Hungarian	-	Spanish	-
Brazilian	/	Italian	-	Swedish/Finnish	/
Chinese	/	Japanese	/	Swiss	-
Czech	-	Korean	/	Taiwanese	/
Danish	-	Latin American	-	Thai	/
French	!	Norwegian	-	Turkish	.
French Canadian	é	Polish	-	U.K. English	/
German	-	Portuguese	-	U.S. English	/

\* Bosnia-Herzegovina, Croatia, Slovenia, and Yugoslavia

### Clearing passwords

If you forget the password, you cannot access the computer.

For instructions about clearing passwords, see [Resetting the password jumper on page 79](#).

## Chassis security

### Cable lock (optional)

To prevent theft, you can attach a keyed cable lock to the rear of the chassis, to the left of the stand. This cable lock attaches to the chassis and secures it to the work area.

## Fault notification and recovery

Fault notification and recovery features combine innovative hardware and software technology to prevent the loss of critical data and minimize unplanned downtime.

If the computer is connected to a network that is managed by HP CMS, the computer sends a fault notice to the network management application. With HP CMS, you can also remotely schedule diagnostics to run on managed PCs and create a summary report of failed tests.

## Thermal sensors

Several thermal sensors in the computer regulate computer fans to maintain acceptable, efficient component temperatures.

## Dual-state power button

With ACPI enabled, the power button can function as an on/off switch or as a button. This feature does not completely turn off power, but instead causes the computer to enter a low-power standby state. This enables you to go to standby without closing applications, and to return to the same operational state without any data loss.

## Changing the power button configuration (Windows only)

---

 **CAUTION:** To reduce the risk of data loss, do not use the power button to turn off the computer unless the system is unresponsive.

 **NOTE:** If the computer is unresponsive, press and hold the power button for four seconds to completely turn off power to the computer.

 **NOTE:** Windows 10 offers a fast startup feature that makes the system boot up a faster after the initial boot up. You can change the function of the power button in the Windows operating system to enable this feature. For more information, [ERP compliance mode on page 17](#).

---

### Windows 7 or Windows 10

1. Select **Start > Control Panel > System and Security > Power Options**.
2. In the left pane, click **Choose what the power buttons do**.
3. Select the desired options.

If you choose Sleep or Hibernate, you can press the power button to initiate standby, and then press it again to exit standby and return to your work. To completely turn off the computer, select **Start > Shut Down**.

# Backing up, restoring, and recovering in Windows 10

This section provides information about the following processes. The information in the section is standard procedure for most products.

- Creating recovery media and backups
- Restoring and recovering your system

For additional information, refer to the HP Support Assistant app.

▲ Type `support` in the taskbar search box, and then select the **Help Support Assistant** app.

– or –

Click the question mark icon in the taskbar.

## Creating recovery media and backups

The following methods of creating recovery media and backups are available on select products only. Choose the method according to your computer model.

- Use HP Recovery Manager to create HP Recovery media after you successfully set up the computer. This step creates a backup of the HP Recovery partition on the computer. The backup can be used to reinstall the original operating system in cases where the hard drive is corrupted or has been replaced. For information on creating recovery media, see [Creating HP Recovery media \(select products only\) on page 40](#). For information on the recovery options that are available using the recovery media, see [What you need to know before you get started on page 42](#).
- Use Windows tools to create system restore points and create backups of personal information.

For more information, see [Using Windows tools on page 41](#).



---

**NOTE:** If storage is 32 GB or less, Microsoft System Restore is disabled by default.

---

## Creating HP Recovery media (select products only)

If possible, check for the presence of the Recovery partition and the Windows partition. From the Start menu, select **File Explorer**, and then select **This PC**.

- If your computer does not list the Windows partition and the Recovery partition, you can obtain recovery media for your system from support. See the *Worldwide Telephone Numbers* booklet included with the computer. You can also find contact information on the HP website. Go to <http://www.hp.com/support>, select your country or region, and follow the on-screen instructions.

You can use Windows tools to create system restore points and create backups of personal information, see [Using Windows tools on page 41](#).

- If your computer does list the Recovery partition and the Windows partition, you can use HP Recovery Manager to create recovery media after you successfully set up the computer. HP Recovery media can be used to perform system recovery if the hard drive becomes corrupted. System recovery reinstalls the original operating system and software programs that were installed at the factory and then configures the settings for the programs. HP Recovery media can also be used to customize the system or restore the factory image if you replace the hard drive.
  - Only one set of recovery media can be created. Handle these recovery tools carefully, and keep them in a safe place.
  - HP Recovery Manager examines the computer and determines the required storage capacity for the media that will be required.



- To create recovery discs, your computer must have an optical drive with DVD writer capability, and you must use only high-quality blank DVD-R, DVD+R, DVD-R DL, or DVD+R DL discs. Do not use rewritable discs such as CD±RW, DVD±RW, double-layer DVD±RW, or BD-RE (rewritable Blu-ray) discs; they are not compatible with HP Recovery Manager software. Or, instead, you can use a high-quality blank USB flash drive.
- If your computer does not include an integrated optical drive with DVD writer capability, but you would like to create DVD recovery media, you can use an external optical drive (purchased separately) to create recovery discs. If you use an external optical drive, it must be connected directly to a USB port on the computer; the drive cannot be connected to a USB port on an external device, such as a USB hub. If you cannot create DVD media yourself, you can obtain recovery discs for your computer from HP. See the *Worldwide Telephone Numbers* booklet included with the computer. You can also find contact information on the HP website. Go to <http://www.hp.com/support>, select your country or region, and follow the on-screen instructions.
- Be sure that the computer is connected to AC power before you begin creating the recovery media.
- The creation process can take an hour or more. Do not interrupt the creation process.
- If necessary, you can exit the program before you have finished creating all of the recovery DVDs. HP Recovery Manager will finish burning the current DVD. The next time you start HP Recovery Manager, you will be prompted to continue.

To create HP Recovery media:

1. Type `recovery` in the taskbar search box, and then select **HP Recovery Manager**.
2. Select **Create recovery media**, and then follow the on-screen instructions.

If you ever need to recover the system, see [Recovering using HP Recovery Manager on page 42](#).

## Using Windows tools

You can create recovery media, system restore points, and backups of personal information using Windows tools.

 **NOTE:** If storage is 32 GB or less, Microsoft System Restore is disabled by default.

For more information and steps, see the Get started app.

- ▲ Select the **Start** button, and then select the **Get started** app.

## Restore and recovery

There are several options for recovering your system. Choose the method that best matches your situation and level of expertise:

 **IMPORTANT:** Not all methods are available on all products.

- Windows offers several options for restoring from backup, refreshing the computer, and resetting the computer to its original state. For more information see the Get started app.
  - ▲ Select the **Start** button, and then select the **Get started** app.
- If you need to correct a problem with a preinstalled application or driver, use the Reinstall drivers and/or applications option (select products only) of HP Recovery Manager to reinstall the individual application or driver.
  - ▲ Type `recovery` in the taskbar search box, select **HP Recovery Manager**, select **Reinstall drivers and/or applications**, and then follow the on-screen instructions.

- If you want to recover the Windows partition to original factory content, you can choose the System Recovery option from the HP Recovery partition (select products only) or use the HP Recovery media. For more information, see [Recovering using HP Recovery Manager on page 42](#). If you have not already created recovery media, see [Creating HP Recovery media \(select products only\) on page 40](#).
- On select products, if you want to recover the computer's original factory partition and content, or if you have replaced the hard drive, you can use the Factory Reset option of HP Recovery media. For more information, see [Recovering using HP Recovery Manager on page 42](#).
- On select products, if you want to remove the Recovery partition to reclaim hard drive space, HP Recovery Manager offers the Remove Recovery Partition option.

For more information, see [Removing the HP Recovery partition \(select products only\) on page 43](#).

## Recovering using HP Recovery Manager

HP Recovery Manager software allows you to recover the computer to its original factory state by using the HP Recovery media that you either created or that you obtained from HP, or by using the HP Recovery partition (select products only). If you have not already created recovery media, see [Creating HP Recovery media \(select products only\) on page 40](#).

### What you need to know before you get started

- HP Recovery Manager recovers only software that was installed at the factory. For software not provided with this computer, you must either download the software from the manufacturer's website or reinstall the software from the media provided by the manufacturer.



---

**IMPORTANT:** Recovery through HP Recovery Manager should be used as a final attempt to correct computer issues.

---

- HP Recovery media must be used if the computer hard drive fails. If you have not already created recovery media, see [Creating HP Recovery media \(select products only\) on page 40](#).
- To use the Factory Reset option (select products only), you must use HP Recovery media. If you have not already created recovery media, see [Creating HP Recovery media \(select products only\) on page 40](#).
- If your computer does not allow the creation of HP Recovery media or if the HP Recovery media does not work, you can obtain recovery media for your system from support. See the *Worldwide Telephone Numbers* booklet included with the computer. You can also find contact information from the HP website. Go to <http://www.hp.com/support>, select your country or region, and follow the on-screen instructions.



---

**IMPORTANT:** HP Recovery Manager does not automatically provide backups of your personal data. Before beginning recovery, back up any personal data you want to retain.

---

Using HP Recovery media, you can choose from one of the following recovery options:



---

**NOTE:** Only the options available for your computer display when you start the recovery process.

---

- System Recovery—Reinstalls the original operating system, and then configures the settings for the programs that were installed at the factory.
- Factory Reset—Restores the computer to its original factory state by deleting all information from the hard drive and re-creating the partitions. Then it reinstalls the operating system and the software that was installed at the factory.

The HP Recovery partition (select products only) allows System Recovery only.

### Using the HP Recovery partition (select products only)

The HP Recovery partition allows you to perform a system recovery without the need for recovery discs or a recovery USB flash drive. This type of recovery can be used only if the hard drive is still working.

To start HP Recovery Manager from the HP Recovery partition:

1. Type `recovery` in the taskbar search box, select **Recovery Manager**, and then select **HP Recovery Environment**.  
– or –  
Press **f11** while the computer boots, or press and hold **f11** as you press the power button.
2. Select **Troubleshoot** from the boot options menu.
3. Select **Recovery Manager**, and then follow the on-screen instructions.

### Using HP Recovery media to recover

You can use HP Recovery media to recover the original system. This method can be used if your system does not have an HP Recovery partition or if the hard drive is not working properly.

1. If possible, back up all personal files.
2. Insert the HP Recovery media, and then restart the computer.

---

 **NOTE:** If the computer does not automatically restart in HP Recovery Manager, change the computer boot order. See [Changing the computer boot order on page 43](#).

---

3. Follow the on-screen instructions.

### Changing the computer boot order

If your computer does not restart in HP Recovery Manager, you can change the computer boot order, which is the order of devices listed in BIOS where the computer looks for startup information. You can change the selection to an optical drive or a USB flash drive.

To change the boot order:

1. Insert the HP Recovery media.
2. Access the system **Startup** menu:  
Turn on or restart the computer, quickly press `esc`, and then press `f9` for boot options.
3. Select the optical drive or USB flash drive from which you want to boot.
4. Follow the on-screen instructions.

### Removing the HP Recovery partition (select products only)

HP Recovery Manager software allows you to remove the HP Recovery partition to free up hard drive space.

---

 **IMPORTANT:** After you remove the HP Recovery partition, you will not be able to perform System Recovery or create HP Recovery media from the HP Recovery partition. So before you remove the Recovery partition, create HP Recovery media; see [Creating HP Recovery media \(select products only\) on page 40](#).

---

 **NOTE:** The Remove Recovery Partition option is only available on products that support this function.

---

Follow these steps to remove the HP Recovery partition:

1. Type `recovery` in the taskbar search box, and then select **HP Recovery Manager**.
2. Select **Remove Recovery Partition**, and then follow the on-screen instructions.

---

# 3 Component replacement information and guidelines

This chapter provides warnings, cautions, information, and guidelines for removal and replacement procedures. It does not document the step-by-step procedures.



**IMPORTANT:** Removal and replacement procedures are available in videos on the HP website.

Go to the HP Customer Self Repair Services Media Library at <http://www.hp.com/go/sml>.

---

This chapter includes these topics:

---

## Topics

---

[Warnings and cautions on page 46](#)

---

[Service considerations on page 47](#)

---

[Product recycling on page 48](#)

---

[Component replacement guidelines on page 49](#)

---

- [Battery on page 49](#)
  - [Cable management on page 49](#)
  - [CPU \(processor\) and CPU heat sink on page 50](#)
  - [Expansion slots on page 51](#)
  - [Hard drives/Z Turbo Drive G2 M.2 modules on page 51](#)
  - [Memory on page 52](#)
  - [Power supply on page 53](#)
-

## Warnings and cautions

---

 **WARNING!** These symbols on any surface or area of the equipment indicate the following:

 Presence of a hot surface or hot component. If this surface is contacted, the potential for injury exists. To reduce the risk of injury from a hot component, let the surface cool before touching.

 Presence of an electrical shock hazard. To reduce the risk of injury from electrical shock, do not open any enclosed area marked with this symbol.

 Product must always be lifted by two persons to avoid personal injury due to product weight.

---

 **WARNING!** To reduce the risk of electric shock or damage to your equipment:

- Do not disable the power cord grounding plug. The grounding plug is an important safety feature.
- Plug the power cord in a grounded (earthed) outlet that is easily accessible at all times.
- Disconnect power from the equipment by unplugging the power cord from the electrical outlet.

 **WARNING!** To reduce the risk of serious injury, read the *Safety & Comfort Guide*. It describes proper computer setup, posture, health, and work habits for computer users, and provides important electrical and mechanical safety information. This guide is located at <http://www.hp.com/ergo>.

 **WARNING!** Do not use the front bezel as a handle or lifting point when lifting or moving the computer. Lifting the computer from the front bezel, or lifting it incorrectly, could cause the computer to fall, causing possible injury to you and damage to the computer. To properly and safely lift the computer, lift from the bottom of the computer.

 **CAUTION:** Static electricity can damage the electronic components of the computer. To prevent damage to the computer, observe the following Electrostatic Discharge (ESD) precautions while servicing the computer:

- Discharge static electricity by briefly touching a grounded metal object before you begin.
  - Work on a static-free mat.
  - Wear a static strap to ensure that any accumulated electrostatic charge is discharged from your body to the ground.
  - Create a common ground for the equipment you are working on by connecting the static-free mat, static strap, and peripheral units to that piece of equipment.
- 

 **NOTE:** HP accessories are for use in HP products. They have been extensively tested for reliability and are manufactured to high quality standards.

---

# Service considerations

## Tools and software requirements

You will need the following tools to complete the removal and replacement procedures:

- Torx T-15 driver
- Torx T-8 driver (for M.2 devices)
- Flat-blade and cross-tip screwdrivers
- Diagnostics software

## Electrostatic discharge (ESD) information

Item	Description																											
<b>Generating static</b>	Different activities generate different amounts of static electricity through electrostatic discharge (ESD). Static electricity increases as humidity decreases.  <b>CAUTION:</b> Static electricity in the amount of 700 volts might degrade a product.																											
	<table border="1"><thead><tr><th rowspan="2">Event</th><th colspan="3">Relative humidity</th></tr><tr><th>55%</th><th>40%</th><th>10%</th></tr></thead><tbody><tr><td>Walking across carpet</td><td>7,500V</td><td>15,000V</td><td>35,000V</td></tr><tr><td>Walking across vinyl floor</td><td>3,000V</td><td>5,000V</td><td>12,000V</td></tr><tr><td>Motions of bench worker</td><td>400V</td><td>800V</td><td>6,000V</td></tr><tr><td>Removing bubble pack from PCB</td><td>7,000V</td><td>20,000V</td><td>26,500V</td></tr><tr><td>Packing PCBs in foam-lined box</td><td>5,000V</td><td>11,000V</td><td>21,000V</td></tr></tbody></table>	Event	Relative humidity			55%	40%	10%	Walking across carpet	7,500V	15,000V	35,000V	Walking across vinyl floor	3,000V	5,000V	12,000V	Motions of bench worker	400V	800V	6,000V	Removing bubble pack from PCB	7,000V	20,000V	26,500V	Packing PCBs in foam-lined box	5,000V	11,000V	21,000V
	Event		Relative humidity																									
		55%	40%	10%																								
	Walking across carpet	7,500V	15,000V	35,000V																								
	Walking across vinyl floor	3,000V	5,000V	12,000V																								
	Motions of bench worker	400V	800V	6,000V																								
Removing bubble pack from PCB	7,000V	20,000V	26,500V																									
Packing PCBs in foam-lined box	5,000V	11,000V	21,000V																									
<b>Preventing ESD equipment damage</b>	Many electronic components are sensitive to ESD. Circuitry design and structure determine the degree of sensitivity. To prevent damage to electronic components and accessories, observe the following packaging and grounding precautions: <ul style="list-style-type: none"><li>• Transport products in static-safe containers such as tubes, bags, or boxes, to avoid hand contact.</li><li>• Protect electrostatic parts and assemblies with nonconductive or approved containers or packaging.</li><li>• Keep electrostatic-sensitive parts in their containers until they arrive at static-free stations.</li><li>• Place items on a grounded surface before removing them from containers.</li><li>• Before handling or touching a sensitive component or assembly, ground yourself by touching the chassis.</li><li>• Avoid contact with pins, leads, or circuitry.</li><li>• Place reusable electrostatic-sensitive parts from assemblies in protective packaging or nonconductive foam.</li></ul>																											
	<b>Personal grounding methods and equipment</b>	Use the following items to help prevent ESD damage: <ul style="list-style-type: none"><li>• <b>Wrist straps</b> — These are flexible straps with a maximum of one megohm <math>\pm</math> 10% resistance in the ground cords. To provide a proper ground, wear the strap against bare skin. The ground cord must be connected and fit snugly into the banana plug connector on the grounding mat or computer.</li><li>• <b>Heel straps, toe straps, and boot straps</b> — These can be used at standing computers and are compatible with most types of shoes or boots. On conductive floors or dissipative floor mats, use them on both feet with a maximum of one megohm <math>\pm</math> 10% resistance between the operator and ground.</li></ul>																										

Item	Description								
<b>Static shielding materials</b>	Static shielding materials provide the following levels of protection.								
	<table border="1"> <thead> <tr> <th>Method</th> <th>Voltage</th> </tr> </thead> <tbody> <tr> <td>Antistatic plastic</td> <td>1,500V</td> </tr> <tr> <td>Carbon-loaded plastic</td> <td>7,500V</td> </tr> <tr> <td>Metalized laminate</td> <td>15,000V</td> </tr> </tbody> </table>	Method	Voltage	Antistatic plastic	1,500V	Carbon-loaded plastic	7,500V	Metalized laminate	15,000V
	Method	Voltage							
	Antistatic plastic	1,500V							
Carbon-loaded plastic	7,500V								
Metalized laminate	15,000V								
<b>Grounding the work area to prevent static damage</b>	<ul style="list-style-type: none"> <li>Cover the work surface with approved static-dissipative material. Use a wrist strap connected to the work surface, and properly grounded tools and equipment.</li> <li>Use static-dissipative mats, foot straps, or air ionizers to give added protection.</li> <li>Handle electrostatic-sensitive components, parts, and assemblies by the case or PCB laminate. Handle them only in static-free work areas.</li> </ul>								
	<ul style="list-style-type: none"> <li>Disconnect power and input signals before inserting and removing connectors or test equipment.</li> <li>Use fixtures made of static-safe materials when fixtures must directly contact dissipative surfaces.</li> <li>Keep work area free of nonconductive materials, such as plastic assembly aids and Styrofoam.</li> <li>Use field service tools (such as cutters, screwdrivers, and vacuums) that are conductive.</li> </ul>								
<b>Recommended ESD prevention materials and equipment</b>	<ul style="list-style-type: none"> <li>Antistatic tape</li> <li>Antistatic smocks, aprons, and sleeve protectors</li> <li>Conductive bins and other assembly or soldering aids</li> <li>Conductive foam</li> <li>Conductive tabletop computers with a ground cord of one megohm <math>\pm</math> 10% resistance</li> <li>Static-dissipative table or floor mats with a hard-tie to ground</li> <li>Field service kits</li> </ul>								
	<ul style="list-style-type: none"> <li>Static awareness labels</li> <li>Wrist straps and footwear straps providing one megohm <math>\pm</math> 10% resistance</li> <li>Material-handling packages</li> <li>Conductive plastic bags</li> <li>Conductive plastic tubes</li> <li>Conductive tote boxes</li> <li>Opaque shielding bags</li> <li>Transparent metallized shielding bags</li> <li>Transparent shielding tubes</li> </ul>								

## Product recycling

HP encourages customers to recycle used electronic hardware, HP original print cartridges, and rechargeable batteries.

For information about recycling HP components or products, go to <http://www.hp.com/go/recycle>.



# Component replacement guidelines

This section provides information and guidelines for removal and replacement procedures. It does not document the step-by-step procedures.

 **IMPORTANT:** Removal and replacement procedures are now available in videos on the HP website.

Go to the HP Customer Self Repair Services Media Library at <http://www.hp.com/go/sml>. In Media Selection, choose **Desktops & Workstations** for product category and **Personal Workstations** for the product family, and then choose your platform.

This chapter provides guidelines for removal and replacement procedures.

---

## Topics

[Battery on page 49](#)

[Cable management on page 49](#)

[CPU \(processor\) and CPU heat sink on page 50](#)

[Expansion slots on page 51](#)

[Hard drives/Z Turbo Drive G2 M.2 modules on page 51](#)

[Memory on page 52](#)

[Power supply on page 53](#)

---

## Battery

The battery that comes with the computer provides power to the real-time clock and has a minimum lifetime of about three years. Observe the following warning and caution when replacing the battery.

 **CAUTION:** Before removing the battery, back up the CMOS settings in case they are lost when the battery is removed. To back up the CMOS settings, select the **Save to Removable Storage** option in Computer Setup (F10) Utility.

 **NOTE:** Do not dispose of batteries, battery packs, and accumulators with general household waste.

## Cable management

Proper routing of the internal cables is critical to the operation of the computer. Follow good cable management practices when removing and installing components.

- Handle cables with care to avoid damage.
- Apply only the tension required to seat or unseat cables during insertion or removal from the connector.
- When possible, handle cables by the connector or pull-strap.
- Route cables in such a way that they cannot be caught or snagged by parts being removed or replaced.
- Keep cables away from direct contact with major heat sources, such as the heat sink. (Some air flow guides have a cable guide that lets you route cables safely around the heat sink.)
- Do not jam cables on top of expansion cards or SODIMMs. Circuit cards and SODIMMs are not designed to take excessive pressure.

- Keep cables clear of movable or rotating parts (such as fans, power supply, and drive cage) to prevent them from being cut or crimped when the component is lowered into its normal position and during normal operation.
- When folding a flat ribbon cable, never fold to a sharp crease. Sharp creases may damage the wires.
- In all cases, avoid bending or twisting the cables. Do not bend any cable sharply. A sharp bend can break the internal wires.
- Never bend a SATA data cable tighter than a 30 mm (1.18 in) radius.
- Never crease a SATA data cable.
- Do not rely on components like the drive cage, power supply, or computer cover to push cables down into the chassis. Always position the cables to lay properly by themselves or in the cable guides and chassis areas designed for cable routing.

When removing the power supply power cable from the connector on the system board, always follow these steps:

1. Press down the top of the retaining latch attached to the cable end of the connector.
2. Grasp the cable end of the connector and pull it straight out.

---

 **CAUTION:** Always pull on the connector — NEVER pull on the cable. Pulling on the cable could damage the cable and result in a failed power supply.

---

## CPU (processor) and CPU heat sink

---

 **CAUTION:** Observe the following cautions when removing or replacing the heat sink:

- When removing the heat sink, loosen all screws a little at a time to be sure that the CPU remains level. Do *not* fully loosen one screw, and then move on to the next.
  - Do not overtighten the heat sink screws. Overtightening can strip the threads in the chassis.
- 

 **CAUTION:** Observe the following cautions when removing or replacing the CPU.

- Internal components might be powered even when the computer is off. To prevent damage, disconnect the computer power cord before you remove or install a component.
  - Do not touch the CPU socket contacts or the gold pads underneath the CPU. Use extreme care and handle the CPU only by the edges.
  - The CPU socket contacts are delicate and bend easily. To avoid bending the contacts, use extreme care when installing the CPU in the socket.
  - Installing a processor incorrectly can damage the system board. Contact an authorized service provider to install the processor. If you plan to install the processor yourself, view the entire remove-and-replace video before you begin.
  - Failure to follow the computer preparation instructions can result in an improperly installed processor, causing extensive computer damage.
-

## Expansion slots

The computer has the following expansion slots:

- One M.2, Socket 3, Key M connector that supports PCIe NVMe SSDs. M.2 module sizes 2242-D5-M, 2260-D5-M, 2280-D5-M are supported by moving the M.2 card hold-down to one of 3 locations
- One M.2 PCIe slot for 2210 A/E Key Wireless Card slot

Go to <http://www.hp.com/go/quickspecs> to learn which cards are supported in the computer.

---

 **CAUTION:** To prevent damage, the overall power consumption of the computer (including I/O cards, CPU, and memory) must not exceed the maximum rating of the computer power supply. For power supply information, see [Power supply specifications on page 54](#).

---

## Hard drives/Z Turbo Drive G2 M.2 modules

- To verify the type, size, and capacity of the storage devices installed in the computer, run **Computer Setup (F10) Utility**.
- The computer supports 2.5" SFF SATA hard drives or solid-state drives and M.2 Key M NVMe PCIe solid-state drives
- No cable adapters are required for any hard drives. The cables necessary for all hard drive configurations are included in the base system and automatically "blind mate" or "direct connect" to the drive(s) when installed.

### Removing hard drive cables

To properly remove a hard drive cable, prior to removing the hard drive, pull the SATA connector from the hard drive using the blue pull tab. Try not to pull the cable out of the system board connector.

---

 **NOTE:** There is an identifying mark on the system board that indicates into which side to insert the blue tab on the cable.

 **NOTE:** Make sure the hard drive cable is not twisted.

---

## Handling hard drives

---

 **CAUTION:** Take proper precautions when handling hard drives to prevent loss of work and damage to the computer or drive.

---

- Do not remove hard drives from the shipping package for storage. Keep hard drives in their protective packaging until they are mounted in the computer.
- Always shut down the operating system, turn off the power, and unplug the power cord. Never remove a drive while the computer is on or in standby mode.
- Before handling a drive, be sure that you discharge static electricity. While handling a drive, avoid touching the connector.
- Handle a drive carefully. Do not drop it from any height.
- Do not use excessive force when inserting a drive.
- Avoid exposing a hard drive to liquids, temperature extremes, or products that have magnetic fields such as monitors or speakers.
- If you must mail a drive, use a bubble-pack mailer or other protective packaging and label the package "Fragile: Handle With Care."

## Memory

### Supported SODIMM configurations

The computer has 2 SODIMM slots and supports up to 32 GB ECC or non-ECC unbuffered DDR4 2133 MHz memory.



---

**NOTE:** Mirroring and SODIMM sparing are not supported.

---

- Two SODIMM slots
- Maximum capacity: 32 GB
- Error checking and correcting (ECC) and non-ECC SODIMMs only.

### BIOS errors and warnings

The BIOS generates warnings/errors on invalid memory configurations:

- If the BIOS can find a valid memory configuration by disabling plugged-in memory, it does so and reports a warning during POST. The computer can still be started. The warning will indicate the location of the failed SODIMM on the system board.
- If there is no way for the BIOS to obtain a valid memory configuration by disabling plugged-in memory, the BIOS halts with a diagnostics 2006 code for memory error (three beeps and two blinks).

### SODIMM installation guidelines

- Install only HP-approved DDR4 SODIMMs



---

**CAUTION:** HP ships only SODIMMs that are electrically and thermally compatible with this computer. Because third-party SODIMMs might not be electrically or thermally compatible, they are not supported by HP.

---

- For ECC SODIMMs, use only industry-standard ECC unbuffered SODIMMs. Go to <http://www.hp.com/go/quickspecs> to find which SODIMMs are compatible with the computer.
- Do not intermix non-ECC memory SODIMMs with ECC memory SODIMMs.



---

**CAUTION:** SODIMMs and their sockets are keyed for proper installation. To prevent socket or SODIMM damage, align these guides properly when installing SODIMMs.

---

## SODIMM installation order

Install SODIMMs in this order.

**⚠ CAUTION:** Internal components might be powered even when the computer is off. To prevent damage, disconnect the computer power cord before you remove or install a component.

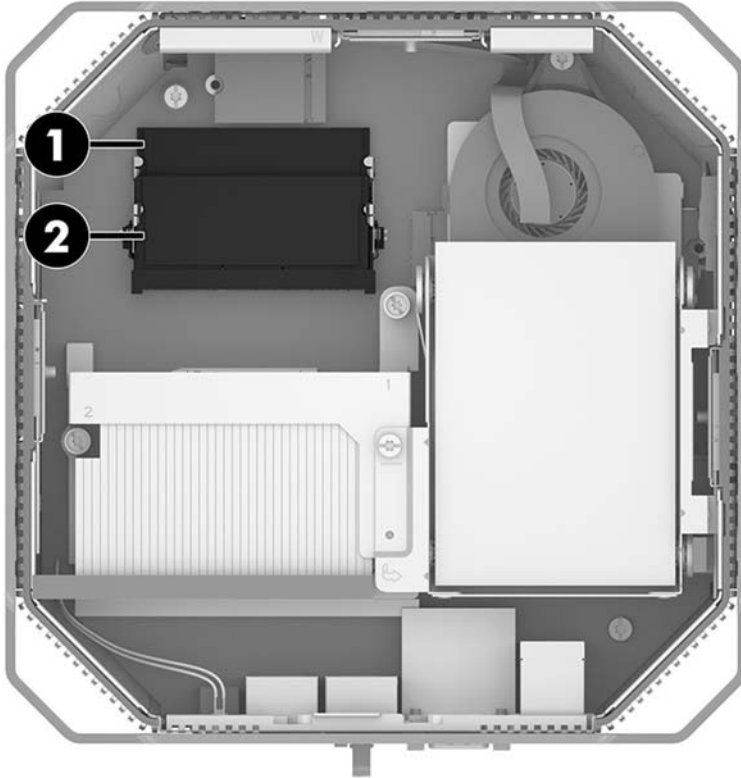

## Power supply

The computer includes the following power supply options:

- Performance models: 200W DoE VI efficiency
- Entry models: 135W DoE VI efficiency

## Power supply specifications

Description	Performance	Entry
Power supply	200 W wide-ranging, DoE VI efficiency	135 W wide-ranging, DoE VI efficiency
Operating voltage range	90–264 VAC	90–264 VAC
Rated voltage range	100–240 VAC	100–240 VAC
Rated line frequency	50–60 Hz	50–60 Hz
Operating line frequency range	47–63 Hz	47–63 Hz
Rated input current	2.9A @ 100–240 VAC	1.9A @ 100–240 VAC
Heat dissipation, typical (configuration and software dependent)	388 btu/hr (98 kg-cal/hr)	340 btu/hr (86 kg-cal/hr)
Heat dissipation, maximum (configuration and software dependent)	543 BTU/hr (137 Kg-cal/hr)	361 BTU/hr (91 Kg-cal/hr)
Power supply fan	none	none
Hard drive activity light = on, the AC is on	yes	yes
Power Consumption in sleep mode (as defined by ENERGY STAR) - Suspend to RAM (S3)	< 3 W	< 3 W
ENERGY STAR® Version 6.1 qualified (Config Dependent)	yes	yes
FEMP Standby Power Compliant	Yes, < 1 W in S5-Power Saving Mode enabled	Yes, < 1 W in S5-Power Saving Mode enabled

## Power consumption and heat dissipation

Power consumption and heat dissipation specifications are available for multiple configurations. To review available specifications, go to <http://www.hp.com/go/quickspecs>.

To reach zero power consumption, unplug the computer from the power outlet or use a power strip with an on/off switch. For additional information about power-saving features, see the operating system installation instructions.

## Resetting the power supply

If an overload triggers the power supply overload protection, power is immediately disconnected.

To reset the power supply:

1. Disconnect the power cord from the computer.
2. Determine what caused the overload, and fix the problem. For troubleshooting information, see [Diagnostics and troubleshooting on page 56](#).
3. Reconnect the power cord, and restart the computer.

When you turn off the computer through the operating system, power consumption falls below what is considered low power consumption but does not reach zero. Power consumption only reaches zero when you unplug the computer from the power outlet.

---

# 4 Diagnostics and troubleshooting

This chapter describes the tools available for diagnosing and troubleshooting system issues.

---

## Topics

---

[Calling support on page 57](#)

---

[Locating ID labels on page 57](#)

---

[Locating warranty information on page 58](#)

---

[Diagnosis guidelines on page 58](#)

---

[Troubleshooting checklist on page 59](#)

---

[HP troubleshooting resources and tools on page 59](#)

---

[Troubleshooting scenarios and solutions on page 62](#)

---

[Using HP PC Hardware Diagnostics \(UEFI\) on page 70](#)

---

[POST error messages and diagnostic front panel LEDs and audible codes on page 71](#)

---

[Interpreting system validation diagnostic front panel lights and audible codes on page 77](#)

---





## Calling support

At times you might encounter an issue that requires support. When you call support:

- Have the computer readily accessible.
- Write down the computer serial numbers, product numbers, model names, and model numbers and have them in front of you.
- Note any applicable error messages.
- Note any add-on options.
- Note the operating system.
- Note any third-party hardware or software.
- Note the details of any blinking LEDs on the front of the computer (tower and desktop configurations) or on the side of the computer (all-in-one configurations).
- Note the applications you were using when you encountered the problem.

---

 **NOTE:** When calling in for service or support, you might be asked for the product number (example: PS988AV) of the computer. If the computer has a product number, it is generally located next to the 10- or 12-digit serial number of the computer.

 **NOTE:** On most models, the serial number and product number labels can be found on the top or side panel and at the rear of the computer (tower and desktop configurations) or on a pull-out card on the side of the display (all-in-one configurations).

---

For a listing of all worldwide support phone numbers, go to <http://www.hp.com/support>, select your region, and click **Connect with HP** in the upper-right corner.

## Locating ID labels

Agency/Environmental labels, an operating system label, and a serial number label are available on each computer.

1. Agency/Environmental and OS labels
2. Serial number (unique for each computer). Have this number available when you contact support.

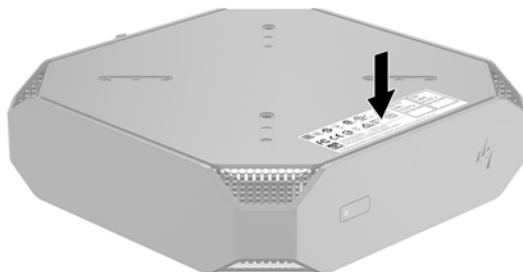

## Locating warranty information

To locate base warranty information, see <http://www.hp.com/support/warranty-lookuptool>.

To locate an existing Care Pack, see <http://www.hp.com/go/lookuptool>.

To extend a standard product warranty, visit <http://www.hp.com/hps/carepack>. HP Care Pack Services offer upgraded service levels to extend and expand a standard product warranty.

## Diagnosis guidelines

If you encounter a problem with the computer or software, consult the following sections. They provide a list of general suggestions that help you isolate and focus on the problem before taking further action.

### Diagnosis at startup

- Verify that the computer and external monitor (if connected) are plugged into a functional AC power outlet.
- Remove all CDs or USB flash drives from your system before turning it on.
- Verify that the computer is turned on and the power light is white (normal operation) and not red (error state).
- If you have installed an operating system other than the factory-installed operating system, go to <http://www.hp.com/go/quickspecs> to verify that it is supported on your system.

### Diagnosis during operation

- Look for power button blinking on the side of the computer. The blinking lights are error codes that will help you diagnose the problem. See [Interpreting system validation diagnostic front panel lights and audible codes on page 77](#) for information on interpreting diagnostic lights and audible codes.
- Verify that all cables are not loosely or incorrectly connected.
- Wake the computer by pressing any key on the keyboard or the power button. If the system remains in suspend mode, shut down the system by pressing and holding the power button for at least four seconds, and then press the power button again to restart the system. If the system does not shut down, unplug the power cord, wait a few seconds, and then plug it in again. If it does not restart, press the power button to start the computer.
- Restart the computer after installing a non-Plug and Play (PnP) expansion board or other option.
- Be sure that all required device drivers have been installed. For example, if you have connected a printer, you must install a printer driver.
- If you are working on a network, plug another computer with a different cable into the network connection. There might be a problem with the network plug or cable.
- If you recently added new hardware, remove it and see if the computer functions properly.
- If you recently installed new software, uninstall it and see if the computer functions properly.
- Upgrade the BIOS. A new release of the BIOS might have been released that supports new features or fixes your problem.
- Press the **Caps Lock** key. If the **Caps Lock** light toggles on or off, the keyboard is operating correctly.

# Troubleshooting checklist

Before running diagnostic utilities, use the following checklist to find possible solutions for computer or software problems.

- Is the computer connected to a functional AC power outlet?
- Is the computer turned on?
- Is the white power light on?
- Is the hard drive activity light on?
- If the internal display is dim, adjust the internal display brightness and contrast controls.
- Press the **Caps Lock** key several times. If the Caps Lock light toggles on and off, the keyboard is operating correctly.
- Verify that all cables are not loosely or incorrectly connected.
- After installing a non-PnP expansion board or other option (such as a diskette drive), restart the computer.
- Are all necessary device drivers installed?
- Have all printer drivers been installed for each application?
- Have you removed CDs and USB flash drives before powering on the computer?
- Are you running the latest version of BIOS, drivers, and software?

## HP troubleshooting resources and tools

This section provides information on the HP Support Center (HPSC), Online support, and Helpful Hints for troubleshooting.

### Online support

Online access and support resources include web-based troubleshooting tools, technical knowledge databases, driver and patch downloads, online communities, and product change notification services.

The following websites are also available to you:

- <http://www.hp.com>—Provides useful product information.
- [http://www.hp.com/support/workstation\\_manuals](http://www.hp.com/support/workstation_manuals)—Provides the latest online documentation.
- <http://www.hp.com/go/workstationsupport>—Provides technical support information for computers.
- <http://www.hp.com/support>—Provides a listing of the worldwide technical support phone numbers. Access the telephone numbers by visiting the website, then select your region, and click **Contact HP** in the upper-left corner.
- [http://www.hp.com/support/workstation\\_swdrivers](http://www.hp.com/support/workstation_swdrivers)—Provides access to software and drivers for computers.

## Troubleshooting a problem

To help you troubleshoot problems with your system, HP provides the HPSC. The HPSC is a portal to an extensive selection of online tools. To access HPSC and troubleshoot a problem with the computer, complete the following:

1. Go to <http://www.hp.com/go/workstationsupport>.
2. Specify your product.
3. Under the **Support Options** menu on the left, select **Troubleshoot a problem** and then select the appropriate category in the resulting menu on the right.

## Customer Advisories, Bulletins, Notices, and Product Change Notifications

To find advisories, bulletins, and notices:

1. Go to <http://www.hp.com/go/workstationsupport>.
2. Select the desired product.
3. Under **Knowledge Base**, select **Advisories, Bulletins & Notices**.

### Product Change Notifications

Product Change Notifications (PCNs) are proactive notifications for product changes occurring within a 30-60 day window of the effective date of the change in the manufacturing process. PCNs give customers advanced notice of changes to their product, such as an updated BIOS version that they may need to qualify prior to the change taking place. The latest PCNs are located at: <http://www.hp.com/go/workstationsupport>.

## Helpful hints

If you encounter a problem with the computer, monitor, or software, the following general suggestions might help you isolate and focus on the problem before taking further action.

### At startup

- Remove all USB drive keys before powering on the computer.
- Verify that the computer is turned on and the power light is on.
- If you have installed an operating system other than the factory-installed operating system, check to be sure that it is supported on your system, go to <http://www.hp.com/go/quickspecs>.

### During operation



**NOTE:** Not all items in the following list apply to all models.

- Look for blinking lights on the computer. The blinking lights are error codes that will help you diagnose the problem. Refer to the *Diagnostic lights and audible (beep) codes* section of this document for information on interpreting diagnostic lights and audible codes.
- Press and hold any key. If the system beeps, then your keyboard is operating correctly.
- Check all cables for loose or incorrect connections.
- Wake the computer by pressing any key on the keyboard or the power button. If the system remains in suspend mode, shut down the system by pressing and holding the power button for at least four seconds, then press the power button again to restart the system. If the system does not shut down, unplug the power cord, wait a few seconds, then plug it in again. If it does not restart, press the power button to start the computer.

- Reconfigure the computer after installing a non–plug and play expansion board or other option. Refer to the *Hardware installation problems* section of this document for instructions.
- Be sure that all required device drivers have been installed. For example, if you have connected a printer, you must install a printer driver.
- If you are working on a network, plug another computer with a different cable into the network connection. There might be a problem with the network plug or cable.
- If you recently added new hardware, remove the hardware and verify if the computer functions properly.
- If you recently installed new software, uninstall the software and verify if the computer functions properly.
- If the monitor connected to a tower, desktop or all-in-one computer is blank:
  - Plug the monitor into a different video port on the computer if one is available. Alternatively, replace the monitor with a monitor that you know is working properly.
  - Verify that the computer *and monitor* are plugged into a working electrical outlet.
  - Verify that the power light is on.
  - Turn up the brightness and contrast controls of the monitor if the monitor is dim.
- If the internal display on an all-in-one computer is blank, open the computer and make sure the graphics card is properly installed.
- Upgrade the BIOS. A new release of the BIOS might have been released that supports new features or fixes your problem.

## Customer Self-Repair program

Under the Customer Self-Repair program, you can order a replacement part and install the part without onsite HP technical assistance. Customer self-repair may be required for some components. See <http://www.hp.com/go/selfrepair> for information on the program.



---

**NOTE:** Some components are not eligible for customer self-repair and must be returned to HP for service. Call HP Support for further instructions before attempting to remove or repair these components.

---

## Troubleshooting scenarios and solutions

This section presents an extensive overview of various troubleshooting scenarios and possible solutions for a Windows-based computer.

### Solving minor problems

Problem	Cause	Possible Solution
Computer appears frozen and does not shut down when the power button is pressed.	Software control of the power switch is not functional.	<ol style="list-style-type: none"> <li>1. Press and hold the power button for at least four seconds until the computer shuts down.</li> <li>2. Disconnect the electrical plug from the outlet.</li> </ol>
Computer seems to be frozen.	Program in use has stopped responding to commands.	<ol style="list-style-type: none"> <li>1. If possible, use the Windows Task Manager to isolate and terminate the offending process.</li> <li>2. Attempt the normal Windows shutdown procedure.</li> <li>3. Restart the computer using the power button.</li> </ol>
Computer date and time display is incorrect.	Real-time clock (RTC) battery might need replacement.	<ol style="list-style-type: none"> <li>1. Reset the date and time in the Control Panel.</li> <li>2. Replace the RTC battery.</li> </ol>
Computer appears to pause periodically.	Network driver is loaded and no network connection is established.	Establish a network connection, or use Computer Setup (F10) Utility or the Windows Device Manager to disable the network controller.
Cursor does not move using the arrow keys on the keypad.	The Num Lock key might be on.	Press Num Lock. The Num Lock key can be disabled or enabled in Computer Setup (F10) Utility.
Poor performance is experienced.	Processor is hot.	<ol style="list-style-type: none"> <li>1. Verify that airflow to the computer is not blocked.</li> <li>2. For models using Intel HD graphics, remove the access panel and verify the air duct is properly installed at the top of the chassis.</li> <li>3. Verify that chassis fans are connected and working properly. Some fans operate only when needed.</li> <li>4. Verify that the processor heat sink is installed properly.</li> </ol>
	Hard drive is full.	Transfer data from the hard drive to create more space on the hard drive.
Computer turned off automatically and the power light flashes red four times with long beeps, followed by two short beeps, while light flashes with short beeps, and pattern repeats.	Processor thermal protection is activated.	<ol style="list-style-type: none"> <li>1. Verify that the computer air vents are not blocked.</li> <li>2. For models using Intel HD graphics, remove the access panel and verify the air duct is properly installed at the top of the chassis.</li> <li>3. Remove the access panel and press the computer power button.</li> <li>4. Verify that the system fan is running.</li> <li>5. Verify that the processor heat sink fan spins. If the fan is not spinning, verify that the heat sink fan cable is plugged into the system board connector and that the heat sink is properly seated.</li> <li>6. Replace the processor heat sink.</li> </ol>
	A fan might be blocked or not turning. OR The processor heat sink is not properly attached to the processor.	
System does not turn on, and the lights on the side of the computer are not flashing.	System cannot turn on.	<p>Press and hold the power button for less than four seconds. If the power light illuminates, then perform the following steps.</p> <ol style="list-style-type: none"> <li>1. To find a faulty device, remove all devices one at a time:</li> </ol>

Problem	Cause	Possible Solution
		<ol style="list-style-type: none"> <li>a. Disconnect AC power to the computer.</li> <li>b. Remove a device.</li> <li>c. Reconnect AC power and turn on the computer.</li> </ol> <ol style="list-style-type: none"> <li>2. Repeat this process until the faulty device is identified. Remove the graphics card last. Replace the faulty device.</li> <li>3. If no faulty device is found, replace the system board.</li> </ol> <p>OR</p> <ol style="list-style-type: none"> <li>1. Press and hold the power button for <i>less than</i> four seconds. If the hard drive light does not turn on, then perform the following tasks: <ol style="list-style-type: none"> <li>a. Verify that the computer is plugged into a working AC outlet.</li> <li>b. Verify that the power button harness is connected to the inline front panel I/O device assembly connector.</li> </ol> </li> <li>2. Verify that the power supply cables are connected to the system board.</li> <li>3. Verify power supply functionality. <p><b>NOTE:</b> There are no fans in the power supply.</p> <ol style="list-style-type: none"> <li>a. Remove VESA mounting bracket by unscrewing four Torx T-15 screws and lift it away.</li> <li>b. Disconnect the main power cable from the system board.</li> <li>c. Connect AC power to the power supply.</li> <li>d. If the hard drive activity light does not illuminate, try replacing the power supply or the system board.</li> <li>e. If the hard drive activity light does illuminate, then something downstream from the power supply may need to be replaced. One possibility is the system board.</li> </ol> </li> </ol>
Computer will not start.	Hard drive is damaged.	Replace the hard drive.

## Solving hard drive problems

Problem	Cause	Solution
Hard drive error occurs.	Hard drive has bad sectors or has failed.	<p>Locate and block the usage of bad sectors. If necessary, reformat the hard drive.</p> <p>You may be able to run Diagnostic Drive Tests if the drives are detectable by the system. Press <b>F2</b> at boot and follow the on-screen prompts to select <b>Drive Tests</b> to test will SSDs and HDDs.</p>
Hard drive transaction problem.	The directory structure is bad, or there is a problem with a file.	<ol style="list-style-type: none"> <li>1. In Windows Explorer, select the drive.</li> <li>2. Enable the context menu and select <b>Properties</b>.</li> <li>3. In the Properties dialog, select the <b>Tools</b> tab and select <b>Check Now</b>.</li> </ol>

Problem	Cause	Solution
Drive not found (identified).	Improper cable connection	On computers with discrete data and power cables, verify that the data and power cables are securely connected to the hard drive. On this computer the drive cables are factory installed. See the <i>Hard drive</i> section of this guide for connection details.
	Improperly seated hard drive	On systems with blind-mate drive connections, verify that there is no connector damage on the drive or in the chassis.  Reseat the hard drive and its carrier in the chassis to be sure that there is a proper connection. (See the <i>Hard drive</i> section of this guide for connection details.)
	The system might not have automatically recognized a newly installed device.	Perform one or both of the following: <ul style="list-style-type: none"> <li>Verify that the drive is listed in the Computer Setup (F10) Utility (<b>Advanced &gt; Boot Options &gt; UEFI Boot Order or Legacy Boot Order</b>). <b>NOTE:</b> Drives only appear in UEFI Boot Order if they contain a folder named EFI at the root of the drive. If it is listed, the probable cause is a driver problem. If it is not listed, the probable cause is a hardware problem.</li> <li>If this drive is newly installed, run the Computer Setup (F10) Utility and increase the <b>Startup Menu Delay</b> in <b>Advanced &gt; Boot Options</b>.</li> </ul>
	Drive responds slowly immediately after power-up.	Run the Computer Setup (F10) Utility, and increase the POST Delay in Power-On Options in the Advanced menu.
Nonsystem disk or NTLDR missing message.	System is trying to start from non-bootable media.	Remove the media device.
	System is trying to start from a damaged hard drive.	▲ Insert bootable media and restart the computer.
	System files missing or not properly installed.	<ol style="list-style-type: none"> <li>1. Insert bootable media and restart the computer.</li> <li>2. Verify that the hard drive is partitioned and formatted.</li> <li>3. Install the system files for the appropriate operating system, if necessary.</li> </ol>
	Hard drive boot disabled in Computer Setup.	Run the Computer Setup (F10) Utility and make sure the box is selected for the port containing the bootable drive in <b>Advanced &gt; Port Options</b> . Typically all boxes should be selected to enable all ports.
	Boot Order Incorrect	Run Computer Setup (F10) Utility and set the correct order in <b>Advanced &gt; Boot Options &gt; UEFI Boot Order and Legacy Boot Order</b> . If drives are removed and the system rebooted, the boot order may be changed by the BIOS and would need to be reset to the desired order. The F9 Boot Order menu can be used to check and choose the right drive for boot.



## Solving internal display problems

Problem	Cause	Solution
Blank screen (no video).	Cable connections are not correct.	<ol style="list-style-type: none"> <li>1. Verify the LCD display cable connection on the system board and to the internal LCD panel connector.</li> <li>2. Verify the LED backlight cable connection to P190 on the system board (see item 19 on <a href="#">System board components on page 7</a>) and to the LED power connector on the internal LCD panel.</li> </ol>
	Screen blanking utility installed or energy saver features enabled.	Press a key or the mouse button and, if set, enter your password.
	System ROM is bad; system is running in FailSafe Boot Block mode (indicated by 8 beeps).	Reflash the ROM using a SoftPaq.
	Computer is in Hibernate mode.	Press the power button to resume from Hibernate mode.
	Backlight circuit on motherboard is damaged.	Replace the motherboard.
The display works properly during the POST but goes blank when the operating system starts.	The display settings in the operating system are incompatible with the internal LCD panel.	<p>For Windows:</p> <ol style="list-style-type: none"> <li>1. Restart your computer in Windows Safe Mode.</li> <li>2. Uninstall the graphics driver for the graphics controller (Intel HD Graphics or NVIDIA Graphics).</li> <li>3. Reboot in normal Windows mode.</li> <li>4. Install the latest graphics driver for the graphics controller you are using (Intel HD Graphics or NVIDIA Graphics).</li> </ol>
Backlight level is turned all the way down in software environment settings		This can happen if a utility has been used to set it to a very low level. Resetting to a usable value requires actions typically using the same utility that was originally used. Some OSes and environments may have other means for resetting.
Power light flashes red three times with long beeps, followed by three short beeps, while light flashes with short beeps, and pattern repeats.	Prevideo graphics error.	<p>Try these solutions in this order:</p> <ul style="list-style-type: none"> <li>• Reseat the processor.</li> <li>• Replace the processor.</li> <li>• Replace the system board.</li> </ul>
	Processor does not support graphics output and no discrete graphics card is installed.	<p>Try either solution:</p> <ul style="list-style-type: none"> <li>• Install a processor with Intel HD Graphics.</li> <li>• Install a supported graphics card.</li> </ul>
Dim characters	Brightness and contrast controls are not set properly.	In Windows, go to <b>Control Panel</b> , select <b>Power Options</b> , and then adjust the internal LCD panel brightness and contrast controls using the <b>Screen Brightness</b> slider bar at the bottom of the window.
	Cables are not properly connected.	<ol style="list-style-type: none"> <li>1. Open the computer.</li> <li>2. Verify that the LCD Display Cable connects on the system board to the internal LCD panel connector.</li> </ol>

Problem	Cause	Solution
		<ol style="list-style-type: none"> <li>3. Verify that the LED Backlight Cable connects P2 on the system board to the LED power connector on the internal LCD panel.</li> </ol>
Blurry video or requested resolution cannot be set.	Correct video drivers were not loaded after graphics controller upgrade.	Install the video drivers included in the upgrade kit, or download and install the latest drivers for your graphics card from <a href="http://welcome.hp.com/country/us/en/support.html">http://welcome.hp.com/country/us/en/support.html</a> .
	The internal LCD panel cannot display requested resolution.	<ol style="list-style-type: none"> <li>1. Change the resolution to 3840 x 2160.</li> <li>2. Update the graphics driver to the latest version available for your graphics controller.</li> </ol>
	The graphics driver is not working properly.	<ol style="list-style-type: none"> <li>1. Boot into the OS and uninstall the graphics driver.</li> <li>2. Restart the computer.</li> <li>3. Install the latest graphics driver for your graphics controller.</li> </ol>
The picture is broken up, rolls, jitters, or flashes.	The internal LCD panel connections to the motherboard might be faulty or the panel might be incorrectly adjusted.	<ol style="list-style-type: none"> <li>1. Open the computer.</li> <li>2. Verify the LCD display cable connects J202 on the system board to the display connector on the internal LCD panel.</li> <li>3. Verify that the LED backlight cable connects P2 on the system board to the LED power connector on the internal LCD panel.</li> </ol>
	The graphics driver is not working properly.	<ol style="list-style-type: none"> <li>1. Boot into the OS and uninstall the graphics driver.</li> <li>2. Reboot.</li> <li>3. Install the latest graphics driver for your graphics controller.</li> </ol>
Some typed symbols do not appear correctly.	The font you are using does not support that symbol.	Use the Character Map to locate and select the appropriate symbol.  (Windows 7) Select <b>Start &gt; All Programs &gt; Accessories &gt; System Tools &gt; Character Map</b> . (Windows 10) Type <code>character</code> in the taskbar search box, and then select <b>Character Map</b> .
	The LCD panel resolution is not properly set.	Use one of the following: <ul style="list-style-type: none"> <li>• Change the panel resolution in the Windows Control Panel by navigating to <b>Appearance and Personalization &gt; Display</b>. Click <b>Change display settings</b> then adjust the resolution.</li> <li>• Use the control panel for the graphics controller (Intel or nVidia).</li> </ul>
	The graphics driver is not working properly or does not support the symbol set with that resolution.	Try either solution: <ul style="list-style-type: none"> <li>• Change the panel resolution using either of the following: 1) Change the panel resolution in the Windows Control Panel by navigating to <b>Appearance and Personalization &gt; Display</b>. Click <b>Change display settings</b> then adjust the resolution. or 2) Use the control panel for the graphics controller (Intel or nVidia).</li> <li>• Install the latest graphics driver: <ol style="list-style-type: none"> <li>1. Boot into the OS and uninstall the graphics driver.</li> <li>2. Restart the computer.</li> <li>3. Install the latest graphics driver for your graphics controller.</li> </ol> </li> </ul>

## Solving externally connected display problems

Problem	Cause	Solution
Blank screen (no video).	The cable connections are not correct.	Verify the cable connections from the monitor to the computer and to a working AC outlet.
	The monitor is off.	Turn the monitor on (LED is on). You might need to refer to the monitor manual for an explanation of LED signals.
	Screen blanking utility installed or energy saver features enabled.	Press a key or the mouse button and, if set, enter your password.
	System ROM is bad; system is running in FailSafe Boot Block mode (indicated by 8 beeps).	Reflash the ROM using a SoftPaq.
	Processor does not support graphics output and no discrete graphics card is installed	Install a processor with graphics support.
	<b>NOTE:</b> Power LED flashes red 6 times (once every second), followed by a 2-second pause, followed by 6 beeps.	
	Computer is in Hibernate mode.	Press the power button to resume from Hibernate mode.
	Multiple displays are not enabled in the graphics control panel.	Go to the graphics control panel and enable multi-display by selecting either clone mode or extended mode.
The graphics driver is not loaded.	Install the latest graphics driver.	
The graphics driver is not working properly.	<ol style="list-style-type: none"> <li>1. When you see <b>Press F8</b> in the bottom-right corner of the screen, restart the computer and press <b>F8</b> during startup.</li> <li>2. In Windows, uninstall the graphics driver.</li> <li>3. Reboot the computer into the normal Windows mode.</li> <li>4. Install the latest graphics driver.</li> </ol>	
The display works properly during the POST but goes blank when the operating system starts.	The display settings in the operating system are incompatible with your graphics card and monitor.	<ol style="list-style-type: none"> <li>1. For Windows, restart your computer in Windows Safe Mode.</li> <li>2. After the operating system starts, change the display settings to match those supported by your graphics card and monitor.</li> <li>3. See your operating system and graphics card documentation for information about changing display settings.</li> </ol>
	Multiple displays are not enabled in the graphics control panel.	Go to the graphics control panel and enable multi-display by selecting either clone mode or extended mode.
	The graphics driver is not loaded.	Install the latest graphics driver.
Dim characters	The brightness and contrast controls are not set properly.	Adjust the monitor brightness and contrast controls.
	Cables are not properly connected.	<ol style="list-style-type: none"> <li>1. Verify that the monitor cable is securely connected to the computer and the monitor.</li> <li>2. Verify that internal Rear IO DP/LAN cable is connected to the system board and the rear I/O board.</li> </ol>

Problem	Cause	Solution
Blurry video or requested resolution cannot be set.	If the graphics controller was upgraded, the correct video drivers might not be loaded.	Install the video drivers included in the upgrade kit, or download and install the latest drivers for your graphics card from <a href="http://welcome.hp.com/country/us/en/support.html">http://welcome.hp.com/country/us/en/support.html</a> .
	Monitor cannot display requested resolution.	Change the resolution.
The picture is broken up, rolls, jitters, or flashes.	The monitor connections might be faulty, or the monitor might be incorrectly adjusted.	<ol style="list-style-type: none"> <li>1. Verify that the monitor cable is securely connected to the computer and the monitor.</li> <li>2. Verify that internal rear IO DP/LAN cable is connected to the system board and the rear I/O board: <ol style="list-style-type: none"> <li>a. Open the computer.</li> <li>b. Verify the rear IO DP/LAN cable is connected to CON6701 on the system board and J16 on the rear I/O board (on the left bottom side).</li> </ol> </li> </ol>
High pitched noise coming from inside a flat-panel monitor.	Brightness and contrast settings are too high.	Lower brightness and contrast settings.
Fuzzy focus; streaking, ghosting, or shadowing effects; horizontal scrolling lines; faint vertical bars; unable to center the picture on the screen (flat-panel monitors using an analog VGA input connection only.)	Flat-panel monitor's internal digital conversion circuits might be unable to correctly interpret the output synchronization of the graphics card.	<ol style="list-style-type: none"> <li>1. Select the monitor's <b>Auto-Adjustment</b> option in the monitor's onscreen display menu.</li> <li>2. Manually synchronize the Clock and Clock Phase onscreen display functions.</li> </ol>
Some typed symbols do not appear correctly.	The font you are using does not support that symbol.	<p>Use the Character Map to locate and select the appropriate symbol.</p> <p>Select <b>Start &gt; All Programs &gt; Accessories &gt; System Tools &gt; Character Map</b>. You can copy the symbol from the Character Map into a document.</p>
	The graphics driver is not working properly or does not support the symbol set with that resolution.	<p>Try either solution:</p> <ul style="list-style-type: none"> <li>• Change the panel resolution in the Windows <b>Control Panel &gt; Screen Resolution</b> menu or through the control panel for the graphics controller (Intel or nVidia).</li> <li>• Install the latest graphics driver:</li> </ul> <ol style="list-style-type: none"> <li>1. Boot into the OS and uninstall the graphics driver.</li> <li>2. Restart the computer.</li> <li>3. Install the latest graphics driver for your graphics controller.</li> </ol>

## Solving audio problems

Problem	Cause	Solution
Sound does not come out of the speaker or headphones.	Software volume control is turned down.	Click the <b>Speaker</b> icon on the taskbar and use the volume slider to adjust the volume, and/or adjust the volume control in the audio player.
	The external speakers are not turned on.	Turn on the external speakers.
	External speakers plugged into the wrong audio jack.	See your sound card documentation for proper speaker connection.
	Headphones or devices connected to the line-out connector have muted the internal speaker.	Turn on and use headphones or external speakers, if connected, or disconnect headphones or external speakers.
	Volume is muted.	Click the <b>Speaker</b> icon on the taskbar and confirm that the mute button below the volume slider is not selected.
	Computer is in Standby mode.	Press the power button to resume from Standby mode.
Sound quality (such as tone, focus, space, equalization, treble or bass) from the internal speakers is not acceptable.	The graphic equalizer (EQ) and/or DTS audio enhancement settings have been changed and are not appropriate for the audio content being played.	<ol style="list-style-type: none"> <li>1. Open the DTS user interface (found either in the Control Panel or the taskbar).</li> <li>2. Go to the Advanced Settings tab.</li> <li>3. Click the Reset button under Default Settings.</li> </ol> <p>This restores the DTS audio enhancement settings, graphic equalizer, and volume to the default settings, which are optimized for most audio content.</p>
	Processor resources are being used by other open applications.	Shut down all open processor-intensive applications.
Sound occurs intermittently.	The hard drive might be full.	<ol style="list-style-type: none"> <li>1. Before recording, be sure there is enough free space on the hard drive.</li> <li>2. Try recording the audio file in a compressed format.</li> </ol>
Audio over DisplayPort is not working.	The wrong device is set as the default audio input.	<ol style="list-style-type: none"> <li>1. Go to <b>Control Panel &gt; Sound</b>.</li> <li>2. On the <b>Recording</b> tab, select the appropriate input.</li> <li>3. Click <b>Set Default</b>.</li> </ol>
Audio input does not work.		

## Solving printer problems

Problem	Cause	Solution
Printer does not print.	Printer is not turned on and online.	Turn the printer on and be sure it is online.
	The correct printer driver for the application is not installed.	<ol style="list-style-type: none"><li>1. Install the correct printer driver for the application.</li><li>2. Try printing using the MS-DOS command: <b>DIR C:\&gt; [printer port]</b> Replace <i>printer port</i> with the address of the printer used. If the printer works, reload the printer driver.</li></ol>
	If you are on a network, you might not have made a connection to the printer.	Make the proper network connection to the printer.
	Printer might have failed.	Run printer self-test.
Printer does not turn on.	The cables might not be connected properly.	

## Using HP PC Hardware Diagnostics (UEFI)

HP PC Hardware Diagnostics is a Unified Extensible Firmware Interface (UEFI) that allows you to run diagnostic tests to determine whether the computer hardware is functioning properly. The tool runs outside the operating system so that it can isolate hardware failures from issues that are caused by the operating system or other software components.

When HP PC Hardware Diagnostics (UEFI) detects a failure that requires hardware replacement, a 24-digit Failure ID code is generated. This ID code can then be provided to support to help determine how to correct the problem.

 **NOTE:** To start diagnostics on a convertible computer, your computer must be in notebook mode and you must use the keyboard attached.

To start HP PC Hardware Diagnostics (UEFI), follow these steps:

1. Turn on or restart the computer, and quickly press **esc**.
2. Press **f2**.

The BIOS searches three places for the diagnostic tools, in the following order:

- a. Connected USB drive

 **NOTE:** To download the HP PC Hardware Diagnostics (UEFI) tool to a USB drive, see [Downloading HP PC Hardware Diagnostics \(UEFI\) to a USB device on page 71](#).

- b. Hard drive
  - c. BIOS
3. When the diagnostic tool opens, select the type of diagnostic test you want to run, and then follow the on-screen instructions.

 **NOTE:** If you need to stop a diagnostic test, press **esc**.

## Downloading HP PC Hardware Diagnostics (UEFI) to a USB device



**NOTE:** The HP PC Hardware Diagnostics (UEFI) download instructions are provided in English only, and you must use a Windows computer to download and create the HP UEFI support environment because only .exe files are offered.

There are two options to download HP PC Hardware Diagnostics to a USB device.

### Download the latest UEFI version

1. Go to <http://www.hp.com/go/techcenter/pcdiags>. The HP PC Diagnostics home page is displayed.
2. In the HP PC Hardware Diagnostics section, select the **Download** link, and then select **Run**.

### Download any version of UEFI for a specific product

1. Go to <http://www.hp.com/support>.
2. Select **Get software and drivers**.
3. Enter the product name or number.  
– or –  
Select **Identify now** to let HP automatically detect your product.
4. Select your computer, and then select your operating system.
5. In the **Diagnostic** section, follow the on-screen instructions to select and download the UEFI version you want.

## POST error messages and diagnostic front panel LEDs and audible codes

This appendix lists the error codes, error messages, and the various indicator light and audible sequences that you may encounter during Power-On Self-Test (POST) or computer restart, the probable source of the problem, and steps you can take to resolve the error condition.

POST Message Disabled suppresses most system messages during POST, such as memory count and non-error text messages. If a POST error occurs, the screen will display the error message. To manually switch to the POST Messages Enabled mode during POST, press any key (except **F10**, **F11**, or **F12**). The default mode is POST Message Disabled.

The speed at which the computer loads the operating system and the extent to which it is tested are determined by the POST mode selection.

Quick Boot is a fast startup process that does not run all of the system level tests, such as the memory test. Full Boot runs all of the ROM-based system tests and takes longer to complete.

Full Boot may also be enabled to run every 1 to 30 days on a regularly scheduled basis. To establish the schedule, reconfigure the computer to the Full Boot Every x Days mode, using Computer Setup.



**NOTE:** For more information on Computer Setup, see [Computer Setup \(F10\) Utilities on page 18](#).

## POST numeric codes and text messages

This section covers those POST errors that have numeric codes associated with them. The section also includes some text messages that may be encountered during POST.



**NOTE:** The computer will beep once after a POST text message is displayed on the screen.

Control panel message	Description	Recommended action
002-Option ROM Checksum Error	System ROM or expansion board option ROM checksum.	<ol style="list-style-type: none"><li>1. Verify the correct ROM.</li><li>2. Flash the ROM if needed.</li><li>3. If an expansion board was recently added, remove it to see if the problem remains.</li><li>4. Clear CMOS. (See <a href="#">Clearing and resetting the BIOS on page 81.</a>)</li><li>5. If the message disappears, there may be a problem with the expansion card.</li><li>6. Replace the system board.</li></ol>
003-System Board Failure	DMA or timers.	<ol style="list-style-type: none"><li>1. Clear CMOS. (See <a href="#">Clearing and resetting the BIOS on page 81.</a>)</li><li>2. Remove expansion boards.</li><li>3. Replace the system board.</li></ol>
005-Real-Time Clock Power Loss	Invalid time or date in configuration memory. RTC (real-time clock) battery may need to be replaced.	Reset the date and time under <b>Control Panel</b> (Computer Setup can also be used). If the problem persists, replace the RTC battery. See the Removal and Replacement section for instructions on installing a new battery.
008-Microcode Patch Error	Processor is not supported by the BIOS.	<ol style="list-style-type: none"><li>1. Upgrade BIOS to proper version.</li><li>2. Change the processor.</li></ol>
009-PMM Allocation Error during MEBx Download	Memory error during POST execution of the Management Engine (ME) BIOS Extensions option ROM.	<ol style="list-style-type: none"><li>1. Reboot the computer.</li><li>2. Unplug the power cord, re-seat the memory modules, and reboot the computer.</li><li>3. If the memory configuration was recently changed, unplug the computer, restore the original memory configuration, and reboot the computer.</li><li>4. If the error persists, replace the system board.</li></ol>
00A-Product Information Not Valid	The product information programmed into the system board is missing or invalid.	Use Computer Setup to update this information.
00B-MEBx Module did not checksum correctly	Memory error during POST execution of the Management Engine (ME) BIOS Extensions option ROM.	<ol style="list-style-type: none"><li>1. Reboot the computer.</li><li>2. Unplug the power cord, re-seat the memory modules, and reboot the computer.</li><li>3. If the memory configuration was recently changed, unplug the power cord, restore the original memory configuration, and reboot the computer.</li></ol>



Control panel message	Description	Recommended action
		<ol style="list-style-type: none"> <li>4. If the error persists, replace the system board.</li> </ol>
00C-PMM Deallocation Error during MEBx Cleanup	Memory error during POST execution of the Management Engine (ME) BIOS Extensions option ROM.	<ol style="list-style-type: none"> <li>1. Reboot the computer.</li> <li>2. Unplug the power cord, re-seat the memory modules, and reboot the computer.</li> <li>3. If the memory configuration was recently changed, unplug the power cord, restore the original memory configuration, and reboot the computer.</li> <li>4. If the error persists, replace the system board.</li> </ol>
00D-Setup Error during MEBx Execution	MEBx selection or exit resulted in a setup failure.	<ol style="list-style-type: none"> <li>1. Reboot the computer.</li> <li>2. Unplug the power cord, re-seat the memory modules, and reboot the computer.</li> <li>3. If the memory configuration was recently changed, unplug the power cord, restore the original memory configuration, and reboot the computer.</li> <li>4. If the error persists, replace the system board.</li> </ol>
00E-Inventory Error during MEBx Execution	BIOS information passed to the MEBx resulted in a failure.	<ol style="list-style-type: none"> <li>1. Reboot the computer.</li> <li>2. If the error persists, update to the latest BIOS version.</li> <li>3. If the error still persists, replace the system board.</li> </ol>
00F-Interface Error during MEBx Execution	MEBx operation experienced a hardware error during communication with the ME.	<ol style="list-style-type: none"> <li>1. Reboot the computer.</li> <li>2. If the error persists, update to the latest BIOS version.</li> <li>3. If the error still persists, replace the system board.</li> </ol>
100-Front Audio Not Connected	Front audio cable has been detached or unseated from system board.	Reconnect or replace front audio cable.
2E1-MemorySize Error	Memory amount has changed since the last boot (memory added or removed).	The system memory size is different from the last startup. The most common reason is the removal of memory from the system board. Press the <b>F1</b> key to save the memory changes. If this message persists, verify that the memory modules are installed correctly.
2E2-Memory Error	Memory module configuration failed during boot up.	<ol style="list-style-type: none"> <li>1. Ensure memory modules are correctly installed.</li> <li>2. Verify proper memory module type.</li> <li>3. Remove and replace the identified faulty memory module(s).</li> <li>4. If the error persists after replacing memory modules, replace the system board.</li> </ol>

Control panel message	Description	Recommended action
2E3-Incompatible Memory Module in Memory Socket(s) X, X, ...	A memory module in memory socket identified in the error message is missing critical SPD information, or is incompatible with the chipset.	<ol style="list-style-type: none"> <li>1. Verify proper memory module type.</li> <li>2. Try another memory socket.</li> <li>3. Replace with a supported module.</li> </ol>
2E4-DIMM Configuration Warning	The current memory configuration is not optimized.	Rearrange the DIMMs so that each channel has the same amount of memory.
2E5-ECC Memory Module Detected on Unsupported Platform	Recently added memory module(s) support ECC memory error correction.	<ol style="list-style-type: none"> <li>1. If additional memory was recently added, remove it to see if the problem remains.</li> <li>2. Check product documentation for memory support information.</li> </ol>
2E6-Memory Not Configured Correctly for Proper MEBx Execution	DIMM1 is not installed.	Make sure there is a memory module in the DIMM1 socket and that it is properly seated.
300-Configuration Change Warning	The storage device configuration will be updated as shown.	Not applicable
301-Hard Disk 1: SMART Hard Drive Detects Imminent Failure	Hard drive is about to fail. (Some hard drives have a hard drive firmware patch that will fix an erroneous error message.)	<ol style="list-style-type: none"> <li>1. Determine if hard drive is giving correct error message. Run the Drive Protection System test under using F2 Diagnostics when booting the computer.</li> <li>2. Apply hard drive firmware patch if applicable. (Available at <a href="http://www.hp.com/support">http://www.hp.com/support</a>.)</li> <li>3. Back up contents and replace hard drive.</li> </ol>
302-Hard Disk 2: SMART Hard Drive Detects Imminent Failure	Hard drive is about to fail. (Some hard drives have a hard drive firmware patch that will fix an erroneous error message.)	<ol style="list-style-type: none"> <li>1. Determine if hard drive is giving correct error message. Run the Drive Protection System test under using F2 Diagnostics when booting the computer.</li> <li>2. Apply hard drive firmware patch if applicable. (Available at <a href="http://www.hp.com/support">http://www.hp.com/support</a>.)</li> <li>3. Back up contents and replace hard drive.</li> </ol>
309 – 30C: Hard Disk 3–6: SMART Hard Drive Detects Imminent Failure	Hard drive is about to fail. (Some hard drives have a hard drive firmware patch that will fix an erroneous error message.)	<ol style="list-style-type: none"> <li>1. Determine if hard drive is giving correct error message. Run the Drive Protection System test under using F2 Diagnostics when booting the computer.</li> <li>2. Apply hard drive firmware patch if applicable. (Available at <a href="http://www.hp.com/support">http://www.hp.com/support</a>.)</li> <li>3. Back up contents and replace hard drive.</li> </ol>
3F0-Boot Device Not Found	Boot device not found.	Insert boot device or load operating system.
3F1-Hard Disk 1 Error	Hard disk 1 error.	<ol style="list-style-type: none"> <li>1. Check and/or replace cables.</li> <li>2. Clear CMOS. (See <a href="#">Clearing and resetting the BIOS on page 81</a>.)</li> <li>3. Replace the hard disk drive.</li> </ol>
3F2-Hard Disk 2 Error	Hard disk 2 error.	<ol style="list-style-type: none"> <li>1. Check and/or replace cables.</li> <li>2. Clear CMOS. (See <a href="#">Clearing and resetting the BIOS on page 81</a>.)</li> </ol>

Control panel message	Description	Recommended action
		3. Replace the hard disk drive.
400-Serial Port A Address Conflict Detected	Both external and internal serial ports are assigned to the same resources.	<ol style="list-style-type: none"> <li>1. Remove any serial port expansion cards.</li> <li>2. Clear CMOS. (See <a href="#">Clearing and resetting the BIOS on page 81.</a>)</li> <li>3. Reconfigure card resources and/or run Computer Setup or Windows utilities.</li> </ol>
401-Serial Port B Address Conflict Detected	Both external and internal serial ports are assigned to the same resources.	<ol style="list-style-type: none"> <li>1. Remove any serial port expansion cards.</li> <li>2. Clear CMOS. (See <a href="#">Clearing and resetting the BIOS on page 81.</a>)</li> <li>3. Reconfigure card resources and/or run Computer Setup or Windows utilities.</li> </ol>
402-Serial Port C Address Conflict Detected	Both external and internal serial ports are assigned to the same resources.	<ol style="list-style-type: none"> <li>1. Remove any serial port expansion cards.</li> <li>2. Clear CMOS. (See <a href="#">Clearing and resetting the BIOS on page 81.</a>)</li> <li>3. Reconfigure card resources and/or run Computer Setup or Windows utilities.</li> </ol>
403-Serial Port D Address Conflict Detected	Both external and internal serial ports are assigned to the same resources.	<ol style="list-style-type: none"> <li>1. Remove any serial port expansion cards.</li> <li>2. Clear CMOS. (See <a href="#">Clearing and resetting the BIOS on page 81.</a>)</li> <li>3. Reconfigure card resources and/or run Computer Setup or Windows utilities.</li> </ol>
43B-More Than One USB type-C Cards Are Installed	More than one USB type-C card is installed.	Remove USB type-C card so only one is installed.
500-BIOS Recovery	A system BIOS recovery has occurred.	Not applicable.
70x-Wireless Mode Not Supported	The system has detected a wireless module installed in the system that is not supported and has been disabled.	Replace with a supported module.
800-Keyboard Error	Keyboard failure.	<ol style="list-style-type: none"> <li>1. Reconnect keyboard with computer turned off.</li> <li>2. Check connector for bent or missing pins.</li> <li>3. Ensure that none of the keys are depressed.</li> <li>4. Replace keyboard.</li> </ol>
801-Keyboard or System Unit Error	Keyboard failure.	<ol style="list-style-type: none"> <li>1. Reconnect the keyboard with computer turned off.</li> <li>2. Ensure that none of the keys are depressed.</li> <li>3. Replace the keyboard.</li> <li>4. Replace the system board.</li> </ol>
900-CPU Fan Not Detected	CPU fan is not connected or may have malfunctioned.	<ol style="list-style-type: none"> <li>1. Reseat CPU fan.</li> <li>2. Reseat fan cable.</li> <li>3. Replace CPU fan.</li> </ol>

Control panel message	Description	Recommended action
901-Chassis, Rear Chassis, or Front Chassis Fan not Detected	Chassis, rear chassis, or front chassis fan is not connected or may have malfunctioned.	<ol style="list-style-type: none"> <li>1. Reseat chassis, rear chassis, or front chassis fan.</li> <li>2. Reseat fan cable.</li> <li>3. Replace chassis, rear chassis, or front chassis fan.</li> </ol>
903-Computer Cover Has Been Removed Since Last System Startup		N/A
904-SATA Cabling Error	One or more SATA devices are improperly attached. For optimal performance, the SATA 0 and SATA 1 ports should be used for hard drives before other ports.	Ensure SATA connectors are used in ascending order. For one device, use SATA 0. For two devices, use SATA 0 and SATA 1. For three devices, use SATA 0, SATA 1, and SATA 2.
90B-Fan Failure	The system has detected that a cooling fan is not operating correctly.	<ol style="list-style-type: none"> <li>1. Reseat fan.</li> <li>2. Reseat fan cable.</li> <li>3. Replace fan.</li> </ol>
90D-System Temperature	Thermal shutdown occurred. The system BIOS has detected your machine was previously shut down to avoid overheating. Overheating may occur if the cooling vents are blocked or the operating temperature exceeds the system specifications. The machine should return to normal operation once the situation is resolved.	Make sure system has proper airflow.

# Interpreting system validation diagnostic front panel lights and audible codes

During the system validation phase that occurs at system startup, the BIOS validates the functionality of the following subsystems and conditions:

- AC adapter
- System board power
- Processor failure
- BIOS corruption
- Memory failure
- Graphics failure
- System board failure
- BIOS authentication failure

If an error is detected, specific patterns of long and short blinks, accompanied by long and short beeps (where applicable) are used to identify the error. These patterns will make up a two part code:

- Major – the category of the error
- Minor – the specific error within the category



**NOTE:** Single beep/blink codes are not used.

Number of long beeps/blinks	Error category
1	Not used
2	BIOS
3	Hardware
4	Thermal
5	System board

Patterns of blink/beep codes are determined by using the following parameters:

- 1 second pause occurs after the last major blink.
- 2 second pause occurs after the last minor blink.
- Beep error code sequences occur for the first 5 iterations of the pattern and then stop.
- Blink error code sequences continue until the computer is unplugged or the power button is pressed.



**NOTE:** Not all diagnostic lights and audible codes are available on all models.

The red light blinks to represent the major error category (long blinks). The white light blinks to represent the minor error category (short blinks). For example, '3.5' indicates 3 long red blinks and 5 short white blinks to communicate the processor is not detected.

Category	Major/minor code	Description
BIOS	2.2	The main area (DXE) of BIOS has become corrupted and there is no recovery binary image available.
	2.3	The embedded controller policy requires the user to enter a key sequence.
	2.4	The embedded controller is checking or recovering the boot block.
Hardware	3.2	The embedded controller has timed out waiting for BIOS to return from memory initialization.
	3.3	The embedded controller has timed out waiting for BIOS to return from graphics initialization.
	3.4	The system board displays a power failure (crowbar).*
	3.5	The processor is not detected.*
	3.6	The processor does not support an enabled feature.
	Thermal	4.2
4.3		An ambient temperature over temperature condition has been detected.
4.4		An over temperature condition has been detected.
System board	5.2	The embedded controller cannot find valid firmware.
	5.3	The embedded controller has timed out waiting for the BIOS.
	5.4	The embedded controller has timed out waiting for BIOS to return from system board initialization.
	5.5	The embedded controller rebooted the system after a possible lockup condition had been detected through the use of a System Health Timer, Automated System Recovery Timer, or other mechanism.

\* Indicates hardware triggered event; all other events are controlled by the BIOS.

---

# 5 Configuring password security and resetting CMOS

This chapter describes how to configure password security and to reset CMOS.

## Preparing to configure passwords

Computer Setup (F10) Utility enables you to create setup and power-on passwords.

There are three possibilities for setting passwords:

- Define an administrator password only. You will need the password to enter Computer Setup (F10) Utility, but you will not need a password to start the computer.
- Define a power-on password only. This password lets you start the computer or enter the setup utility.
- Define both. In this case, the administrator password lets you start the computer and enter the setup utility. The power-on password starts the computer but does not let you enter the setup utility,

After you create both passwords, you can use the administrator password in place of the power-on password as an override to log into the computer (a useful feature for a network administrator).

---

 **NOTE:** You can only clear the passwords with the password jumper. Clearing CMOS does not clear the passwords.

 **CAUTION:** Before pressing the Clear CMOS button, back up your computer CMOS settings.

Pressing the Clear CMOS button resets CMOS values to factory defaults and erases customized information, including asset numbers and special settings.

To back up the CMOS settings, run Computer Setup (F10) Utility and select **Main > Replicated Setup > Backup current settings to USB device**.

---

## Resetting the password jumper

---

 **CAUTION:** Stringent security is a mode where there is no physical bypass of the password function. If enabled, removing the password jumper will be ignored. To enable this mode, change the security setting **Clear Password Jumper** in Password Policies to **Ignore**.

If you lose or forget the password when in stringent security mode, the system can only be reset by System Management Command. This is a way for HP Service and Support to provide a secure method to access the BIOS and command a password reset for a specifically identified unit under the direction of the owner. This scenario may not be covered under warranty.

To prevent needing a customer service event to restore access to the system, record your configured administrator and power-on passwords in a safe place away from your computer.

---

To disable the power-on or administrator password features, or to clear the power-on or administrator passwords, complete the following steps:

1. Shut down the operating system properly, then turn off the computer and any external devices, and disconnect the power cord from the power outlet.
2. With the power cord disconnected, press the power button again to drain the system of any residual power.

---

 **WARNING!** To reduce the risk of personal injury from electrical shock and/or hot surfaces, be sure to disconnect the power cord from the wall outlet, and allow the internal system components to cool before touching.

 **CAUTION:** When the computer is plugged in, the power supply always has voltage applied to the system board even when the unit is turned off. Failure to disconnect the power cord can result in damage to the system.

Static electricity can damage the electronic components of the computer or optional equipment. Before beginning these procedures, ensure that you are discharged of static electricity by briefly touching a grounded metal object. See the *Safety & Regulatory Information* guide for more information.

---

3. Remove the access panel.
4. Locate the header and jumper.

---

 **NOTE:** The password jumper is green so that it can be easily identified.

---

5. Remove the jumper from pins 1 and 2.
6. Place the jumper on either pin 1 or 2, but not both, so that it does not get lost.
7. Replace the access panel and reconnect the external equipment.
8. Plug in the computer and turn on power. Allow the operating system to start. This clears the current passwords and disables the password features.
9. Shut down the computer, unplug the power, and disconnect the external equipment.
10. Remove the access panel.
11. Place the jumper on pins 1 and 2.
12. Replace the access panel.
13. Reconnect the external equipment and plug in the computer.





## Clearing and resetting the BIOS

The CMOS jumper resets BIOS settings to default, but does not clear the passwords or affect any of the other Security settings. On Intel systems with advanced manageability features, clearing CMOS will also partially unprovision AMT.

1. Turn off the computer and any external devices, and disconnect the power cord from the power outlet.
2. Disconnect the keyboard, monitor, and any other external equipment connected to the computer.

---

 **WARNING!** To reduce the risk of personal injury from electrical shock and/or hot surfaces, be sure to disconnect the power cord from the wall outlet, and allow the internal system components to cool before touching.

 **CAUTION:** When the computer is plugged in, the power supply always has voltage applied to the system board even when the unit is turned off. Failure to disconnect the power cord can result in damage to the system.

Static electricity can damage the electronic components of the computer or optional equipment. Before beginning these procedures, ensure that you are discharged of static electricity by briefly touching a grounded metal object. See the *Safety & Regulatory Information* guide for more information.

---

3. Remove the access panel.

 **CAUTION:** Resetting CMOS will reset CMOS values to factory defaults. It is important to back up the computer CMOS settings before resetting them in case they are needed later. Back up is easily done through Computer Setup. See [Computer Setup \(F10\) Utilities on page 18](#) for information on backing up the CMOS settings.

---

4. Locate the CMOS jumper. For information on jumper location, see [System board components on page 7](#).

 **NOTE:** Make sure you have disconnected the AC power cord from the wall outlet. CMOS will not clear if the power cord is connected.

---

5. Remove the jumper from pins 1 and 2.
6. Place the jumper on pins 2 and 3.
7. Wait for a few seconds.
8. Move the jumper back to pins 1 and 2.
9. Replace the access panel.
10. Reconnect the external devices.
11. Plug in the computer.

 **NOTE:** When you plug power cord back in, the computer will power on by itself and perform two or three reboots before returning to normal operation.

 **NOTE:** You will receive POST error messages after clearing CMOS and rebooting advising you that configuration changes have occurred. Use Computer Setup to reset any special system setups along with the date and time.

---

For instructions on Computer Setup, see [Computer Setup \(F10\) Utilities on page 18](#).

---

# A Linux technical notes

HP offers a variety of Linux solutions:

- HP offers an Ubuntu preload on some Z Series Workstations.
- HP certifies and supports Ubuntu on some HP workstations.
- HP certifies and supports Red Hat Enterprise Linux (RHEL) on HP workstations.
- HP certifies SUSE Linux Enterprise Desktop (SLED) on HP workstations.
- HP offers a SLED 11 preload on some older Z Series Workstations.

For Linux setup and restore procedures, see the user guide for your computer at [http://www.hp.com/support/workstation\\_manuals](http://www.hp.com/support/workstation_manuals).

 **NOTE:** After you set up the operating system, make sure that the latest BIOS, drivers, and software updates are installed.

 **CAUTION:** Do not add optional hardware or third-party devices to the computer until the operating system is successfully installed. Adding hardware might cause errors and prevent the operating system from installing correctly.

---

## System RAM

HP supports different amounts of total RAM in various computers, based on the number of hardware DIMM slots and the capabilities of the system. The total memory supported for each configuration is listed in the *Hardware Support Matrix for HP Linux Workstations* at [http://www.hp.com/support/linux\\_hardware\\_matrix](http://www.hp.com/support/linux_hardware_matrix).

## Audio

All HP workstations come with built-in audio hardware. The audio hardware is supported by the *Advanced Linux Sound Architecture (ALSA)* drivers included with all modern Linux distributions.

The audio hardware provides basic playback and recording features. The ability to simultaneously play audio from multiple sources, such as applications and CDs, is provided in the ALSA driver that provides audio mixing. The performance of software audio mixing and playback is greatly improved in ALSA version 1.0.13 and later.

After the driver is installed, the optional NVIDIA and AMD graphics cards that are supported in HP workstations also provide audio functionality over HDMI. The signal can be passed through the DisplayPort connector to a monitor with audio capabilities. The vendor driver must be installed. Such a configuration might present two audio hardware choices. If you do not hear sound through the speakers, one possible reason is that the graphics card (default) is selected for audio output instead of the DisplayPort. Check the audio settings (for example, **Sound** in `gnome-control-center`).

In some systems, embedded Intel HD graphics may present a similar HDMI audio device that you can use through the DisplayPort interface. No proprietary driver is needed for this device, just a recent kernel.

## Network cards

All HP workstations include one or two integrated network interface controllers. Some support optional NICs. Most Linux distributions have drivers for these interfaces.

# Hyper-Threading Technology

The Z Series Workstations support Hyper-Threading Technology (HTT), an Intel technology that improves processor performance by enabling the processor to simultaneously perform multiple tasks. The operating system treats an HTT-enabled processor as two virtual processors and shares the workload between them when possible. This feature can be used only if the operating system support multiple processors and is specifically optimized for HTT.

To enable HTT:

1. During startup, press **F10** to enter Computer Setup (F10) Utility.
2. Select **Advanced > System Options**.
3. Set **Intel Hyperthreading** to **Enable**, and then press **F10** to exit the menu.
4. Select **Main > Save Changes and Exit**.
5. Restart the system to enable HTT.



**NOTE:** On most recent Linux distributions (including RHEL 6, SLED 11, and updates to those streams), the kernel automatically detects that HTT is enabled and works correctly.

# NVIDIA Graphics Workstations

Some workstation configurations come with NVIDIA Quadro graphics hardware. HP recommends the use of NVIDIA drivers for best results on Linux systems.

HP provides recommended versions of the drivers with RPM-compatible installers for RHEL and SLED distributions. These are available from the HP Installer Kit for Linux and from workstation driver repositories on hp.com. When HP installers are used, their contents and documentation links are located in the `/opt/hp/nvidia` folder.

When installing Linux on a workstation that contains an NVIDIA card, administrators should select a VESA-compatible driver to avoid the instability that is experienced with some open-source versions of the Nouveau and DRM drivers.

Open-source versions of Nouveau drivers and NVIDIA drivers cannot coexist in the same runtime environment because they use the same hardware resources. If administrators create their own Linux environments using NVIDIA drivers but choose not to use HP-packaged versions, HP recommends that they manually append the following boot loader parameters to properly suppress the Nouveau driver at runtime (grub example below):

```
kernel /vmlinuz ... rdblacklist=nouveau nouveau.modeset=0
```

This action is applied by HP installers but must be applied/restored under other circumstances.

To customize display characteristics and resolutions when the computer is using an NVIDIA driver, execute the following command:

```
/usr/bin/nvidia-settings
```

To create and manipulate the `/etc/X11/xorg.conf` file, execute:

```
/usr/bin/nvidia-xconfig
```

## B System board designators

This appendix describes the system board designators for this computer.

Designator	Name on board	Component
E49	PSWD	Clear password header/jumper
J9	RJ45+USB	LAN + Dual USB 3.0 Type A connector
J38	SSD1	M.2 Key M connector (black)
J39	WLAN	M.2 Key E WLAN connector (black)
J75	HDSET	Headset jack
J82	USB3	Side Dual-USB 3.0 Type A connector
J220	TYPE-C	Type-C/USB 3.1 connector
J221	TYPE-C	Type-C/USB 3.1 connector
J63	DP O/P	Rear display port connector (black)
J64	DP O/P	Rear display port connector (black)
P1	PWR	Power supply connector (black)
P5	PWR+LED	Power switch + LED front + LED rear connector (black)
P6	SPKR	Internal speaker connector (white)
P8	CPU FAN	CPU fan connector (white)
P11	GPU FAN	CPU fan connector (black)
P60	SATA0	SATA 6.0 Gbps hard drive port (black)
P162	THERM	Temperature sensor connector (black)
SW51	CMOS	Clear CMOS jumper
XBT1	BATTERY	Battery holder
XMM1/XMM3	DIMM1/DIMM2	Memory slots
XU1		CPU socket

# Index

## A

Appendices  
System board designators 84  
audible codes 77

## B

Battery 49  
beep codes 77  
BIOS  
clearing and resetting 81  
booting options  
Full Boot 71  
Quick Boot 71

## C

Cable management 49  
Card configuration restrictions  
Power supplies 51  
CMOS 79  
Components  
chassis 6  
system board 7  
system board architecture 9  
computer components  
front 2  
left side 3  
rear 4  
rear Entry 5  
rear Performance 4  
configuring monitors 16  
connecting monitors 16  
connection requirements, monitors  
16

## D

Desktop management 29  
computer security 33  
Dual-state power button 39  
FailSafe Boot Block ROM 32  
Fault notification and recovery  
39  
HP SoftPaq Download Manager  
31  
HP System Software Manager  
31

HPBiosUpdRec 32

Initial configuration 30

Remote ROM Flash 32

Remote system install 30

ROM Flash 32

Updating software 31

Diagnostics and troubleshooting 56

Diagnosis guidelines 58

Locating warranty info 58

## E

error  
codes 77  
messages 72

## F

flashing lights 77

## G

graphics cards  
matching to monitor  
connectors 16

## H

Hardware overview 1  
HP PC Hardware Diagnostics (UEFI)  
using 70

## I

ID labels 57

## L

links  
HP.com 15

## M

monitors  
adding 14  
configuring 16  
connecting 16  
customizing the display 17  
display setup 17  
identifying connection  
requirements 16

matching graphics cards to  
connectors 16  
planning for additional 14  
planning for entry model 14  
planning for performance  
model 14  
planning process 15  
setup 14

## N

numeric error codes 72

## O

Operating system setup 82

## P

password  
security 36  
Password configuration 79  
Physical characteristics 10  
dimensions 10  
environmental specifications 11  
graphics 10  
I/O technology 10  
memory 10  
power supply 10  
processor technology 10  
storage devices 11  
weight 10  
Power supply 53  
Card configuration restrictions  
51  
Power consumption 54  
Resetting power supply 55  
Specifications 54  
Product features  
ERP compliance mode 17  
Hyper-threading 18  
SATA Power Management 18  
Turbo Boost 18

## R

Replacing components 45  
CPU heat sink 50

Memory 52  
Service considerations 47

## S

setup  
    monitors 14  
    ventilation 12  
SODIMM configurations, supported  
    52  
specifications 10  
System board designators 84  
System management 13

## U

urls  
    HP.com 15

## V

ventilation 12

## W

Windows 10  
    backup and restore 40