

PYLE®

PyleUSA.com

PORTABLE BLUETOOTH KARAOKE SPEAKER SYSTEM



INSTRUCTION MANUAL

Model: PWMA335BT

I. FEATURES

1. Ultra-large magnetic circuit high-sensitivity speaker with high penetrating power, low-frequency shock and perfect medium-/high-frequency representation
2. The latest decoding chips supporting stably playback of MP3 in up to 32GB U disk/SD card.
3. FM radio reception - high-quality digital radio with automatic channel search and storage of up to 60 channels.
4. 3.5mm AUX audio input for each connection to a wide range of sound sources.
5. Built-in high-capacity battery for consecutive playback of up to 2 hours.
6. Connect the microphone, adjustable reverberation, voice and Karaoke function to present outstanding performance.
7. Battery with built-in recharging protection to present a long and stable service life.
8. Built-in low battery and full recharging indication. Human-oriented use.
9. With belt/handle design for best choice of mobile speaker.
10. Outputs to earphone or external sound sources.
11. Record your favorite FM radio station or other AUX sound source to enjoy the music wherever you like.
12. Microphone input recording to act as your personal business assistant.
13. With Bluetooth function.

II. RECORDING

Recording in AUX Mode:

Connect a storage device (USB/SD card) and press Mode key to enter AUX mode. Short press Record key to start recording for a time depending on the storage capacity. During recording, the input signal should be in proper strength as you like.

Recording in FM Receiving Mode:

Connect a storage device (USB/SD card) and press Mode key to enter FM mode. Select your favorite radio station and short press record key to start recording for a time depending on the storage capacity. During recording, keep the device in a proper location where the radio signal will be received best to ensure optimized recording performance.

Recording via External Microphone:

Connect a storage device (USB/SD card) and short press RECORD key to start recording for a time depending on the storage capacity. During recording, turn the "-ECHO+" knob to the minimum. It is noticeable that the microphone should be located a proper distance away from the speaker to prevent any howl-round or noise.

NOTE: This product starts recording from the time as displayed on the LED screen.

III. BLUETOOTH PAIRING OPERATION:

1. ON/OFF: switch the power to ON, press the key "MODE" to enter the Bluetooth mode, the display screen will show "BLUE" indicating Bluetooth mode is active.
2. Make sure the Bluetooth function of the Mobile device is active and begin searching, when the Mobile device shows "PyleUSA", connect to it. Mobile device connections do not need password, however if prompted, input "0000" to go on pairing. After a successful pairing, the speaker will send out a voice of prompt indicating it has successfully been paired with the mobile device.
3. Play the music from your mobile device directly and enjoy.

IV. FUNCTIONAL OPERATIONS AND FEATURES

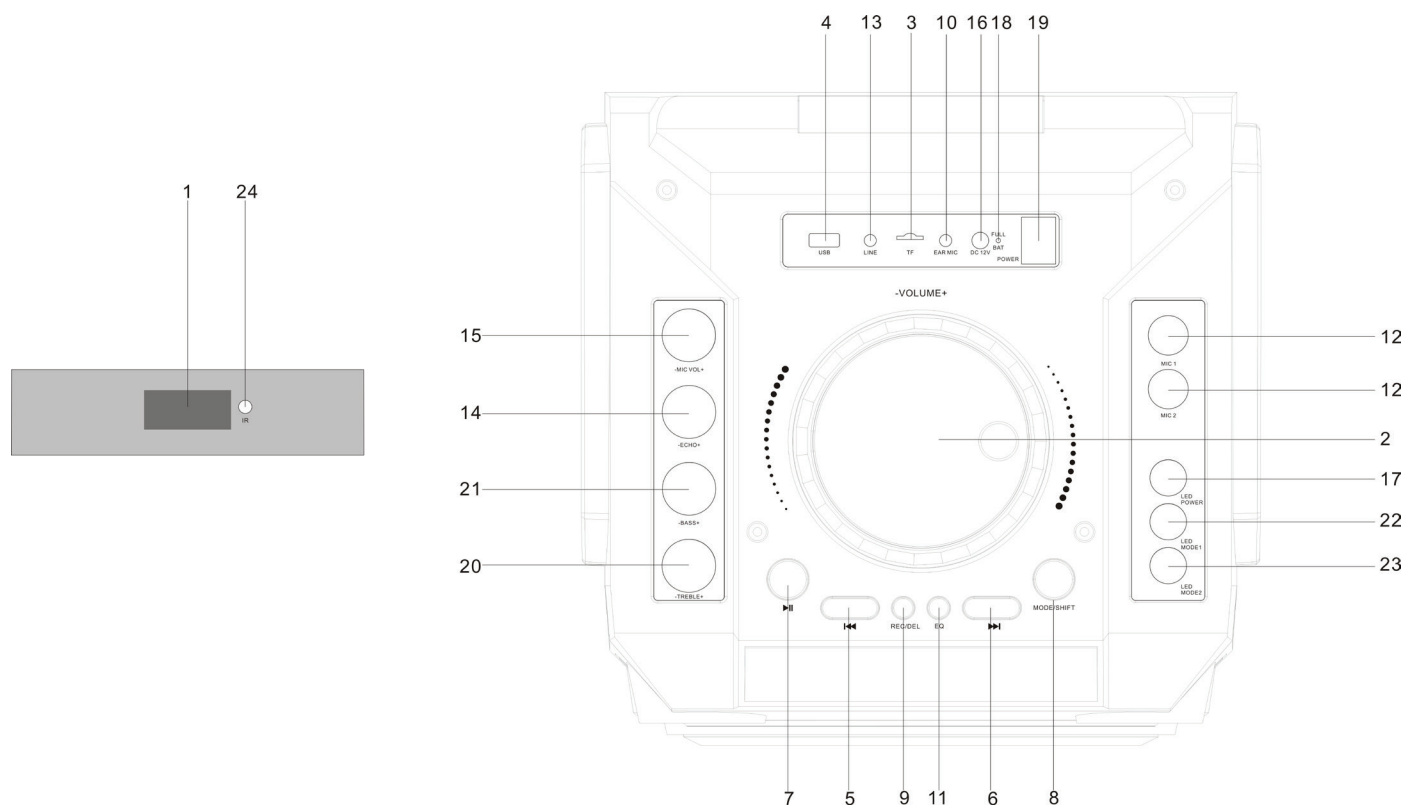

1. LED Screen
2. Master Volume: In MP3/FM/AUX mode, use it to regulate volume output from the speaker.
3. SD Port: Read audio files in MP3 format in SD card in capacity up to 32G (FAT32).
4. USB Port: Read audio files in MP3 format in USB storage device in capacity up to 32G (FAT32).
5. ◀◀ :In USB/TF card reading mode, short press it to go to the previous track,or long press to switch to the previous folder. In FM receiving status, short press it to select the previous channel after a full station search has been executed.
6. ▶▶ :In USB/SD card reading mode, short press it to play/pause, or long press it to select one of four playback sequencing modes (All - play all tracks in sequence; ONE - repeat one track). In FM receiving status, long press it to execute a full search (it is recommended to execute at least one full search before using radio receiving function. All founded stations will be saved even in power-off). In AUX input / FM radio status, short press it to toggle between mute and normal volume.
7. ▶▶ : In USB/SD card reading mode, short press it to go to the previous track. In FM receiving status, short press it to select the next channel after a full station search has been executed.
8. Mode/SHIFT: short press it to toggle between USB/SD and FM receiving modes. Long press it to toggle between recording folder and MP3 folder.
9. Recording/DEL: Short press it to enable recording (USB/SD storage device need be connected first). During recording, reverberation should be tuned to the minimum. Long press it to delete a recording file. Recording in AUX or FM mode is available.
10. EAR MIC: headphone/MIC Port
11. EQ: Environment Switching: In USB/SD reading status, short press it to select an environment mode (from Square, Meeting, Home, Hall and Personal).







12. Microphone input: Microphone input jack
13. LINE IN: External sound source input port (plug-and-play).
14. Reverberation: Microphone reverberation regulating knob.
15. Microphone volume: Microphone volume regulating knob.
16. DC 12V recharging: DC 12V recharging port.
17. LED Power: The ON/OFF button of light
18.  : In MP3 mode, Long press it to toggle between 6 kinds of flash modes/ the flash light switch. In FM/MIC IN mode, Long press to control the flash light switch.
19. Power switch: “—” - ON; “○” - OFF.
20. TREBLE: The control knob of treble.
21. BASS: The control knob of bass
22. LED MODE 1: First lighting mode
23. LED MODE 2: Second Lighting mode
24. IR: Infrared remote receiver module

NOTE:

Please be sure to charge if music becomes distorted.

V. REMOTE INSTRUCTIONS:



1. Power Button: Short press it to enter standby mode; short press it again to resume. If no device is connected, the system goes to “-NO-”.
2. : Functions as “” on the master device.
3. : Functions as “” on the master device.
4. : Functions as “” on the master device.
5. Mode: Functions as “Mode” on the master device.
6. V+/V- Keys: In USB/SDF/FM/AUX mode, press them to volume up/down.
7. Numeric Keys 0~9: In USB/SD card reading status, to play Track 12, just input numbers “1” and “2”, and in 2 seconds the system will go to Track 12 and start playback. Any input of number larger than number of the total available tracks is invalid. In FM status, to listen to channel 107.5MHZ, just input “1075”.
8. Environment Key: In USB/SD card reading status, short press it to toggle among Square, Meeting, Home, Hall and Personal modes.
9. Sequencing Key: In USB/SD card reading status, short press it to toggle among four playback sequencing modes (All - play all tracks in sequence; RAND - play in random; ONE - repeat one track; FOL - repeat all tracks in a folder).
10.  In USB/SD/FM/AUX mode, short press it to mute the device.
11. 100+: Number selection key - in MP3 mode (USB/SD card), short press it to add “100” to current track number.