



HP Notebook PC (Intel)
Models: HP 17-x000 – 17-x099

Maintenance and Service Guide

© Copyright 2016 HP Development Company, L.P.

Bluetooth is a trademark owned by its proprietor and used by HP Inc under license. Intel and Core are U.S. registered trademarks of Intel Corporation. Microsoft and Windows are U.S. registered trademarks of Microsoft Corporation. SD Logo is a trademark of its proprietor.

The following applies to HP systems with Intel Skylake or next-generation silicon chip-based system shipping with Windows 7, Windows 8, Windows 8.1 or Windows 10 Pro systems downgraded to Windows 7 Professional, Windows 8 Pro, or Windows 8.1: This version of Windows running with the processor or chipsets used in this system has limited support from Microsoft. For more information about Microsoft's support, please see Microsoft's Support Lifecycle FAQ at <https://support.microsoft.com/lifecycle>

The information contained herein is subject to change without notice. The only warranties for HP products and services are set forth in the express warranty statements accompanying such products and services. Nothing herein should be construed as constituting an additional warranty. HP shall not be liable for technical or editorial errors or omissions contained herein.

First Edition: April 2016

Document Part Number: 855102-001

Product notice

This guide describes features that are common to most models. Some features may not be available on your computer.

Not all features are available on all editions of Windows. This computer may require upgraded and/or separately purchased hardware, drivers, and/or software to take full advantage of Windows 8.1 functionality. See <http://www.microsoft.com> for details.

Safety warning notice

 **WARNING!** To reduce the possibility of heat-related injuries or of overheating the device, do not place the device directly on your lap or obstruct the device air vents. Use the device only on a hard, flat surface. Do not allow another hard surface, such as an adjoining optional printer, or a soft surface, such as pillows or rugs or clothing, to block airflow. Also, do not allow the AC adapter to contact the skin or a soft surface, such as pillows or rugs or clothing, during operation. The device and the AC adapter comply with the user-accessible surface temperature limits defined by the International Standard for Safety of Information Technology Equipment (IEC 60950).

Table of contents

1 Product description	1
2 External component identification	7
Display	7
Right side	8
Left side	9
Top	10
TouchPad	10
Lights	11
Button	12
Keys	13
Using the action keys	14
Bottom	15
Service tag	16
3 Illustrated parts catalog	17
Computer major components	17
Display assembly subcomponents	21
Miscellaneous parts	23
Mass storage devices	24
Cables	25
4 Removal and replacement procedures preliminary requirements	27
Tools required	27
Service considerations	27
Plastic parts	27
Cables and connectors	27
Drive handling	28
Grounding guidelines	28
Electrostatic discharge damage	28
Packaging and transporting guidelines	29
Workstation guidelines	29
5 Removal and replacement procedures for Customer Self-Repair parts	31
Component replacement procedures	31
Battery	32

Optical drive	33
---------------------	----

6 Removal and replacement procedures for Authorized Service Provider parts 35

Component replacement procedures	35
Display subcomponents (bezel, webcam, panel)	35
Bottom cover	39
Hard drive	41
WLAN module	44
RTC battery	46
Memory module	47
Solid-state drive	49
Solid-state drive holder and board	50
Optical drive connector	52
TouchPad click board	53
USB board	54
Speakers	55
Fan/heat sink assembly	56
System board	64
Display assembly	67
Power button board	76
Power connector	77
Cable locations	78
Top cover/keyboard	79

7 Using Setup Utility (BIOS) in Windows 10 81

Starting Setup Utility (BIOS)	81
Updating Setup Utility (BIOS)	81
Determining the BIOS version	81
Downloading a BIOS update	82

8 Backing up, restoring, and recovering in Windows 10 83

Creating recovery media and backups	83
Creating HP Recovery media (select products only)	83
Using Windows tools	84
Restore and recovery	85
Recovering using HP Recovery Manager	85
What you need to know before you get started	85
Using the HP Recovery partition (select products only)	86
Using HP Recovery media to recover	86
Changing the computer boot order	87

Removing the HP Recovery partition (select products only)	87
9 Using HP PC Hardware Diagnostics (UEFI)	89
Downloading HP PC Hardware Diagnostics (UEFI) to a USB device	89
10 Specifications	91
Computer specifications	91
43.9-cm (17.3-in) display specifications	92
Hard drive specifications	92
DVD±RW SuperMulti DL Drive specifications	93
11 Power cord set requirements	95
Requirements for all countries	95
Requirements for specific countries and regions	96
12 Recycling	99
Index	101

1 Product description

Category	Description	Dis 5th Gen Core	UMA 5th Gen Core	UMA Pent/Cel	Dis Pent/Cel	Dis 6th Gen Core	UMA 6th Gen Core
Product name	HP Notebook PC	√	√	√	√	√	√
Processors	6th generation Intel® Core™ processors					√	√
	Intel Core i7-6500U (2.5-GHz, turbo up to 3.1 GHz, 4-MB L3 cache, 1600-MHz, dual, 15W)						
	Intel Core i5-6200U (2.3-GHz, turbo up to 2.8 GHz, 3-MB L3 cache, 1600-MHz, dual, 15W)					√	√
	Intel Core i3-6100U (2.3-GHz, 3-MB L3 cache, 1600-MHz, dual, 15W)						√
	Intel Core i3-5005U (2.0-GHz, 3-MB L3 cache, 1600-MHz, dual, 15W)	√	√				
	Intel Pentium® N3710 (1.6-GHz, turbo up to 2.56 GHz, 2-MB L3 cache, 1600-MHz, quad, 6W)			√	√		
	Intel Celeron® N3060 (1.6-GHz, turbo up to 2.48 GHz, 2-MB L3 cache, 1600-MHz, quad, 6W)			√			
Chipset	Intel Skylake U 1-chip series					√	√
	Intel Broadwell-U 1-chip BGA	√	√				
	Intel Braswell			√	√		
Graphics	Internal graphics		√				
	Intel HD Graphics 5500 (Intel Broadwell U series)						
	Intel HD Graphics 520 (Intel Skylake U series)						√
	Intel HD Graphics (Intel Braswell series)			√			
	Support HD Decode, DX12, HDMI, and PX7	√	√	√	√	√	√
	Switchable discrete graphics						√
	AMD Radeon™ R7 R16M-M1-70 with up to 4096 MB of dedicated video memory (512Mx16 DDR3 x 4 PCs)						
	AMD Radeon R7 R16M-M1-30 with up to 2048 MB of dedicated video memory (256Mx16 DDR3 x 4 PCs)	√			√		√
	AMD Radeon R5 R16M-M1-30 with up to 2048 MB of dedicated video memory (256Mx16 DDR3 x 4 PCs)					√	
	Support HD Decode, DX12, HDMI, and PX7	√	√	√	√	√	√

Category	Description	Dis 5th Gen Core	UMA 5th Gen Core	UMA Pent/Cel	Dis Pent/Cel	Dis 6th Gen Core	UMA 6th Gen Core
Panel	<p>16:9 Ultra Wide Aspect Ratio, 43.9-cm (17.3-in)</p> <p>HD+, white light-emitting diode (WLED), eDP, SVA, BrightView, (1600×900) flat-flat (4.2 mm); typical brightness: 220 nits (non-touch panel)</p> <p>HD+, WLED, eDP, SVA, BrightView (1600×900) flat-flat (4.2 mm), typical brightness: 220 nits (touch panel)</p> <p>FHD, white light-emitting diode (WLED), eDP, UWVA, antiglare, (1920×1080) flat-flat (4.2 mm); typical brightness: 300 nits (non-touch panel)</p> <p>FHD, WLED, eDP, UWVA, antiglare (1920×1080) flat-flat (4.2 mm), typical brightness: 300 nits (touch panel)</p>	√	√	√	√	√	√
Memory	<p>One SODIMM slot - customer accessible / upgradeable</p> <p>DDR3L-1600-MHz single channel support</p> <ul style="list-style-type: none"> 8192-MB total system memory (8192×1) 4096-MB total system memory (4096×1) 			√	√		
	<p>Two SODIMM slots - customer accessible / upgradeable</p> <p>DDR4-2133-MHz dual channel support, 1.2V</p> <p>DDR3L-1600-MHz dual channel support, 1.35V</p> <p>Supports up to 16 GB of system RAM in the following configurations:</p> <ul style="list-style-type: none"> 16384-MB total system memory (8192×2) 12288-MB total system memory (8192×1) + (4096×1) 8192-MB total system memory (8192×1) or (4096×2) 6144-MB total system memory (4096×1) + (2048×1) 4096-MB total system memory (4096×1) or (2048×2) 	√	√			√	√
Hard drives	<p>Supports 6.35-cm (2.5-in) SATA hard drives in 9.5 mm (.37 in) and 7.0 mm (.28 in) thicknesses</p> <p>7.0mm/9.5 mm share the same bracket</p> <p>Accelerometer/HDD protection support</p> <p>Single HDD configurations</p>	√	√	√	√	√	√

Category	Description	Dis 5th Gen Core	UMA 5th Gen Core	UMA Pent/Cel	Dis Pent/Cel	Dis 6th Gen Core	UMA 6th Gen Core
	<ul style="list-style-type: none"> 2-TB, 5400-rpm, 7.2-mm 1-TB, 5400-rpm, 9.5-mm 500-GB, 5400-rpm, or 7.2-mm <p>Hybrid HDD configurations</p> <ul style="list-style-type: none"> 1-TB, 5400-rpm, 9.5-mm SSHD w/8GB NAND <p>M.2 SATA-3 SSD</p> <ul style="list-style-type: none"> 128-GB 						
Fixed optical drive	Fixed, serial SATA, 9.5-mm tray load DVD+/-RW Double-Layer SuperMulti Supports zero power optical drive	√	√	√	√	√	√
Camera and microphone	<p>HP TrueVision HD</p> <p>HD camera (fixed, no tilt with activity LED, USB 2.0, BSI, 1280×720 by 30 frames per second)</p> <p>Single digital microphone</p> <p>HP Webcam: VGA camera</p> <p>640×480 by 24 frames per second</p> <p>Single digital microphone</p>	√	√	√	√	√	√
Audio	Dual speakers DTS Studio Sound	√	√	√	√	√	√
Ethernet	Integrated 10/100 network interface card (NIC)	√	√	√	√	√	√
Wireless networking	<p>Integrated Wireless options with dual antennas (M.2/PCIe):</p> <ul style="list-style-type: none"> Intel Dual Band Wireless-AC 3165 802.11 ac 1x1 WiFi + BT 4.2 Combo Adapter Intel Dual Band Wireless-AC 3168 802.11 ac 1x1 WiFi + BT 4.2 Combo Adapter <p>Integrated Wireless options with single antenna (M.2/PCIe):</p> <ul style="list-style-type: none"> Realtek RTL8188EE 802.11b/g/n 1x1 Wi-Fi Adapter Broadcom BCM43142 802.11 b/g/n 1x1 Wi-Fi + BT4.0 Combo Adapter <p>Intel WiDi support</p> <p>Compatible with Miracast-certified devices</p>	√	√	√	√	√	√
External media card	<p>HP Multi-Format Digital Media Card Reader</p> <p>Support SD/SDHC/SDXC</p>	√	√	√	√	√	√

Category	Description	Dis 5th Gen Core	UMA 5th Gen Core	UMA Pent/Cel	Dis Pent/Cel	Dis 6th Gen Core	UMA 6th Gen Core
	Push-pull insertion/removal						
Ports	HDMI version 1.4 supporting 1920 ×1200 @ 60Hz	√	√	√	√	√	√
	RJ-45 (Ethernet, includes link and activity lights)						
	USB 3.0 (1)						
	USB 2.0 (2)						
	AC Smart Pin adapter plug						
	Combo audio jack (headphone/microphone)						
Keyboard/ pointing devices	Keyboard	√	√	√	√	√	√
	Full size standard textured island-style keyboard with numeric keypad						
	Full size backlit 2 coat paint island-style keyboard with numeric key pad						
	TouchPad						
	Image sensor						
	Multitouch gestures enabled						
	Taps enabled by default						
	Support Modern Trackpad Gestures						
Power requirements	Battery	√	√	√	√	√	√
	4-cell, 41-Whr, 2.8Ah, li-ion battery						
	3-cell, 31-Whr, 2.8Ah, li-ion battery		√	√			√
	AC adapters:	√			√	√	
	AC Adapter 65-W Smart nPFC, 3 pin, RC 4.5mm connector (models with discrete graphics only)						
	AC Adapter 65-W EM Smart nPFC, 3 pin, RC 4.5mm connector (models with discrete graphics in India/China only)						
	AC Adapter 45-W Smart nPFC, 3 pin, RC 4.5mm connector (models with UMA graphics only)		√	√			√
	1 meter power cord	√	√	√	√	√	√
Security	TPM 2.0	√	√	√	√	√	√
	Kensington Security Lock						
Operating system	Preinstalled	√	√	√	√	√	√
	<ul style="list-style-type: none"> Windows 10 Windows 10 Home ML Windows 10 Home High End ML Windows 10 Home EM/SL 						

Category	Description	Dis 5th Gen Core	UMA 5th Gen Core	UMA Pent/Cel	Dis Pent/Cel	Dis 6th Gen Core	UMA 6th Gen Core
	<ul style="list-style-type: none"> Windows 10 Home High End EM/SL/China CPPP Windows 10 Home China Language Edition FreeDOS 2.0 						
	<ul style="list-style-type: none"> Windows 10 Home Value India Notebook 			√	√		
Serviceability	End-user replaceable parts:	√	√	√	√	√	√
	<ul style="list-style-type: none"> AC adapter Battery Optical drive 						

2 External component identification

Display



Component	Description
(1) WLAN antennas (1 or 2)*	Send and receive wireless signals to communicate with wireless local area networks (WLANs).
(2) Webcam light	On: The webcam is in use.
(3) Webcam – or – 3D camera (select products only)	Records video and captures photographs. Some products allow you to video conference and chat online using streaming video. To use a webcam (integrated camera): ▲ Type camera in the taskbar search box, and then select Camera .
(4) Internal microphone	Records sound.

*The antennas are not visible from the outside of the computer. For optimal transmission, keep the areas immediately around the antennas free from obstructions.





For wireless regulatory notices, see the section of the *Regulatory, Safety, and Environmental Notices* that applies to your country or region.

To access this guide:

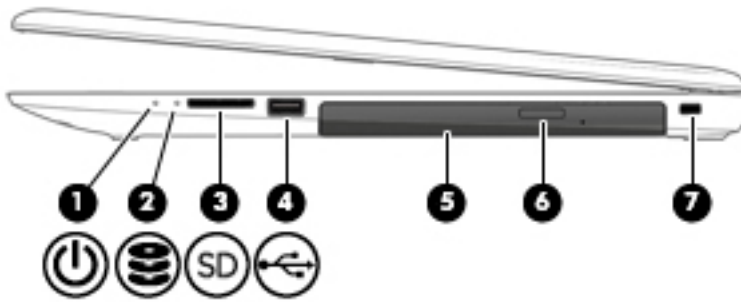
▲ Select the **Start** button, select **All apps**, select **HP Help and Support**, and then select **HP Documentation**.







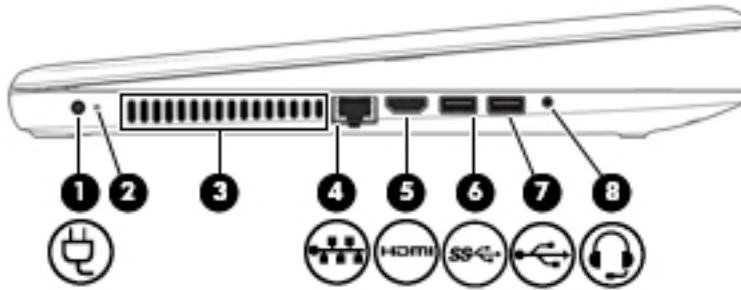

Right side



Component	Description
(1)  Power light	<ul style="list-style-type: none"> • On: The computer is on. • Blinking: The computer is in the Sleep state, a power-saving state. The computer shuts off power to the display and other unneeded components. • Off: The computer is off or in Hibernation. Hibernation is a power-saving state that uses the least amount of power.
(2)  Drive light	<ul style="list-style-type: none"> • Blinking white: The hard drive is being accessed. • Amber: HP 3D DriveGuard has temporarily parked the hard drive.
(3)  Memory card reader	<p>Reads optional memory cards that enable you to store, manage, share, or access information.</p> <p>To insert a card:</p> <ol style="list-style-type: none"> 1. Hold the card label-side up, with connectors facing the computer. 2. Insert the card into the memory card reader, and then press in on the card until it is firmly seated. <p>To remove a card:</p> <ul style="list-style-type: none"> ▲ Press in on the card, and then remove it from the memory card reader.
(4)  USB 2.0 port	Connects an optional USB device, such as a keyboard, mouse, external drive, printer, scanner or USB hub.
(5) Optical drive	<p>Depending on your computer, reads an optical disc or reads and writes to an optical disc.</p> <p>NOTE: For disc compatibility information, type <code>help</code> in the taskbar search box, select Help and Support, and then type <code>disc compatibility</code> in the search box.</p>
(6) Optical drive eject button	Opens the optical drive.
(7) Security cable slot	<p>Attaches an optional security cable to the computer.</p> <p>NOTE: The security cable is designed to act as a deterrent, but it may not prevent the computer from being mishandled or stolen.</p>

Left side



Component	Description
(1) 	Power connector Connects an AC adapter.
(2) 	AC adapter and battery light <ul style="list-style-type: none"> White: The AC adapter is connected and the battery is fully charged. Blinking white: The AC adapter is disconnected and the battery has reached a low battery level. Amber: The AC adapter is connected and the battery is charging. Off: The battery is not charging.
(3) 	Vent Enables air flow to cool internal components. NOTE: The computer fan starts up automatically to cool internal components and prevent overheating. It is normal for the internal fan to cycle on and off during routine operation.
(4) 	RJ-45 (network) jack/status lights Connects a network cable. <ul style="list-style-type: none"> White: The network is connected. Amber: Activity is occurring on the network.
(5) 	HDMI port Connects an optional video or audio device, such as a high-definition television, any compatible digital or audio component, or a high-speed High-Definition Multimedia Interface (HDMI) device.
(6) 	USB 3.0 port Connects an optional USB device, such as a keyboard, mouse, external drive, printer, scanner or USB hub.
(7) 	USB 2.0 port Connects an optional USB device, such as a keyboard, mouse, external drive, printer, scanner or USB hub.
(8) 	Audio-out (headphone)/Audio-in (microphone) combo jack Connects optional powered stereo speakers, headphones, earbuds, a headset, or a television audio cable. Also connects an optional headset microphone. This jack does not support optional standalone microphones.

Component	Description
	<p>WARNING! To reduce the risk of personal injury, adjust the volume before putting on headphones, earbuds, or a headset. For additional safety information, refer to the <i>Regulatory, Safety, and Environmental Notices</i>.</p> <p>To access this guide:</p> <ul style="list-style-type: none"> ▲ Select the Start button, select All apps, select HP Help and Support, and then select HP Documentation. <p>NOTE: When a device is connected to the jack, the computer speakers are disabled.</p>

Top

TouchPad

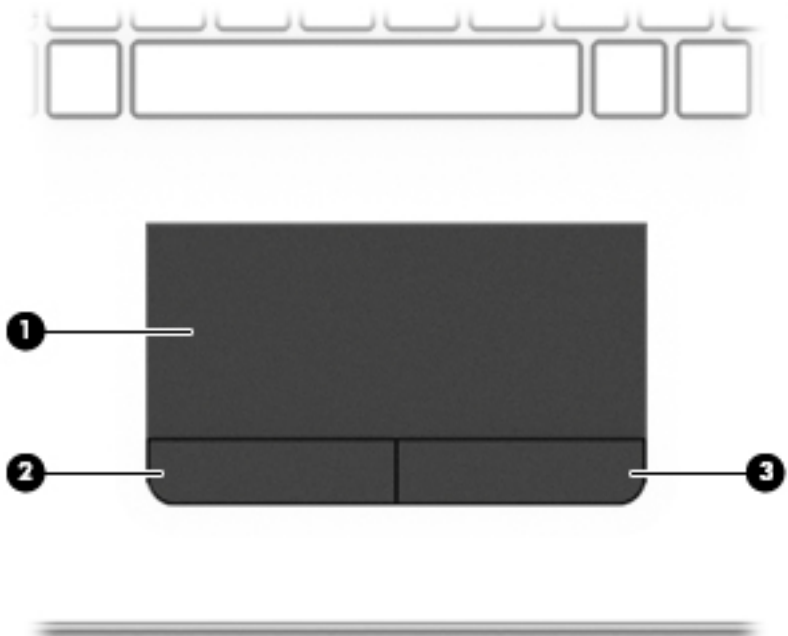

Component	Description
(1) TouchPad zone	Reads your finger gestures to move the pointer or activate items on the screen.
(2) Left TouchPad button	Functions like the left button on an external mouse.
(3) Right TouchPad button	Functions like the right button on an external mouse.

Lights

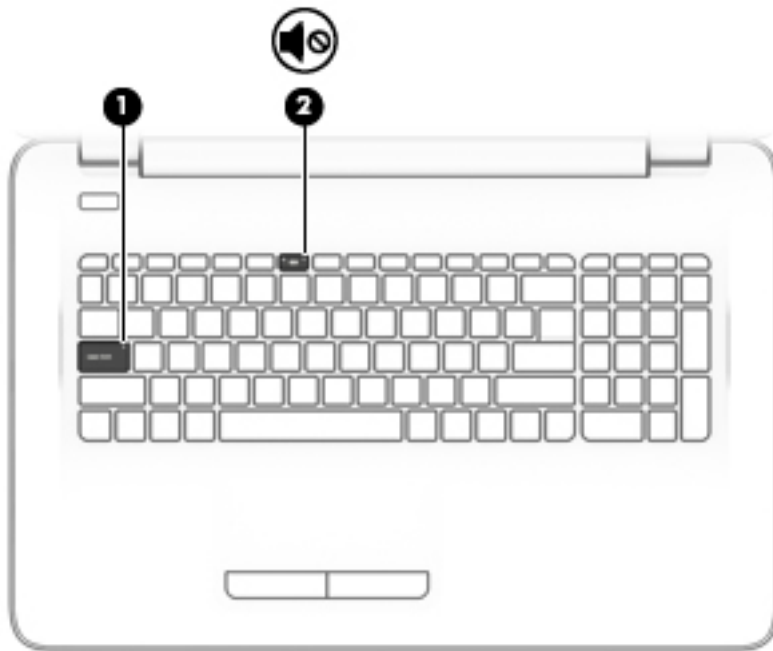

Component	Description
(1) Caps lock light	On: Caps lock is on, which switches the key input to all capital letters.
(2)  Mute light	<ul style="list-style-type: none">• Amber: Computer sound is off.• Off: Computer sound is on.

Button



Component	Description
 Power button	<ul style="list-style-type: none">• When the computer is off, press the button to turn on the computer.• When the computer is on, press the button briefly to initiate Sleep.• When the computer is in the Sleep state, press the button briefly to exit Sleep.• When the computer is in Hibernation, press the button briefly to exit Hibernation. <p>CAUTION: Pressing and holding down the power button results in the loss of unsaved information.</p> <p>If the computer has stopped responding and shutdown procedures are ineffective, press and hold the power button down for at least 5 seconds to turn off the computer.</p> <p>To learn more about your power settings, see your power options.</p> <ul style="list-style-type: none">▲ Type <code>power</code> in the taskbar search box, and then select Power and sleep settings. <p>– or –</p> <p>Right-click the Start button, and then select Power Options.</p>



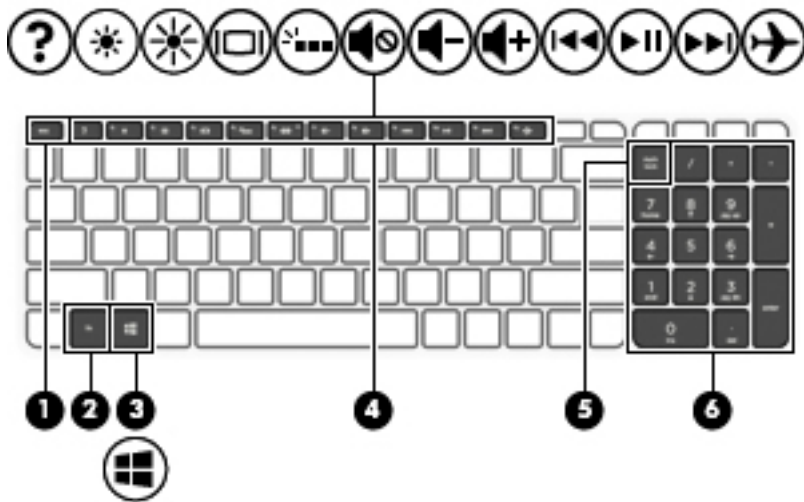









Keys



Component	Description
(1) esc key	Displays system information when pressed in combination with the fn key.
(2) fn key	Executes frequently used system functions when pressed in combination with the esc key, action keys, or the spacebar .
(3)  Windows key	Opens the Start menu. NOTE: Pressing the Windows key again will close the Start menu.
(4) Action keys	Execute frequently used system functions. NOTE: On select products, the f5 action key turns the keyboard feature off or on.
(5) num lock key	Alternates between the navigational and numeric functions on the integrated numeric keypad.
(6) Integrated numeric keypad	When num lock is on, the keypad can be used like an external numeric keypad.



Using the action keys

- An action key performs an assigned function.
- The icon on each action key illustrates the function for that key.
- To use an action key, press and hold the key.

Icon	Description
	Opens Help and Support, which provides tutorials, information about the Windows operating system and your computer, answers to questions, and updates to your computer. Help and Support also provides automated troubleshooting tools and access to support.
	Decreases the screen brightness incrementally as long as you hold down the key.
	Increases the screen brightness incrementally as long as you hold down the key.
	Switches the screen image between display devices connected to the system. For example, if a monitor is connected to the computer, repeatedly pressing this key alternates the screen image from the computer display to the monitor display to a simultaneous display on both the computer and the monitor.
	Turns the keyboard backlight off or on (select products only). NOTE: To conserve battery power, turn off this feature.
	Mutes or restores speaker sound.
	Decreases speaker volume incrementally while you hold down the key.
	Increases speaker volume incrementally while you hold down the key.
	Plays the previous track of an audio CD or the previous section of a DVD or a Blu-ray Disc (BD).
	Starts, pauses, or resumes playback of an audio CD, a DVD, or a BD.
	Plays the next track of an audio CD or the next section of a DVD or a BD.
	Turns the airplane mode and wireless feature on or off. NOTE: The airplane mode key is also referred to as the wireless button. NOTE: A wireless network must be set up before a wireless connection is possible.

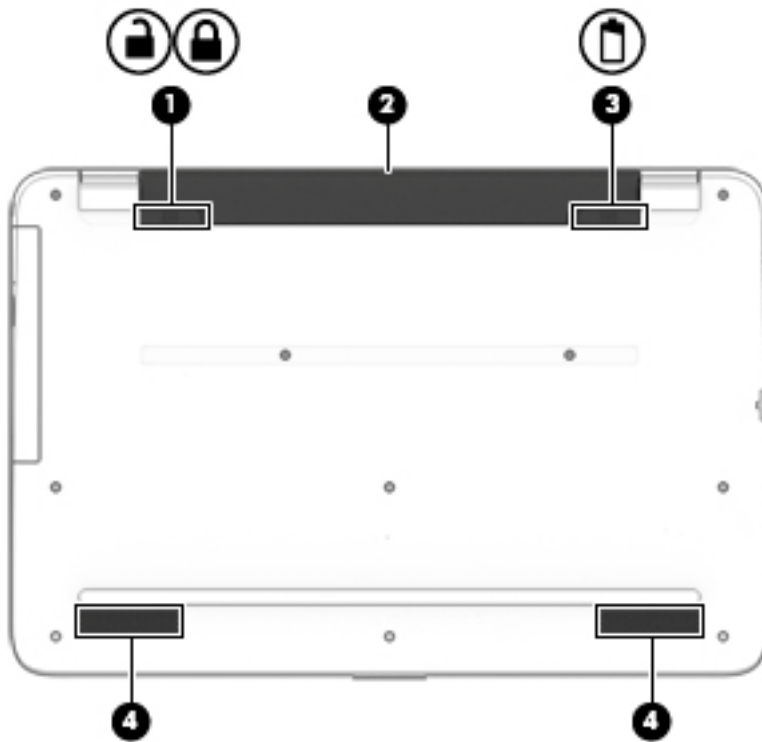
Bottom



Component	Description
(1)  	Battery lock Locks the battery in the battery bay.
(2)	Battery bay Holds the battery.
(3) 	Battery release latch Releases the battery.
(4)	Speakers Produce sound.

Service tag

When ordering parts or requesting information, provide the computer serial number and model number provided on the service tag.

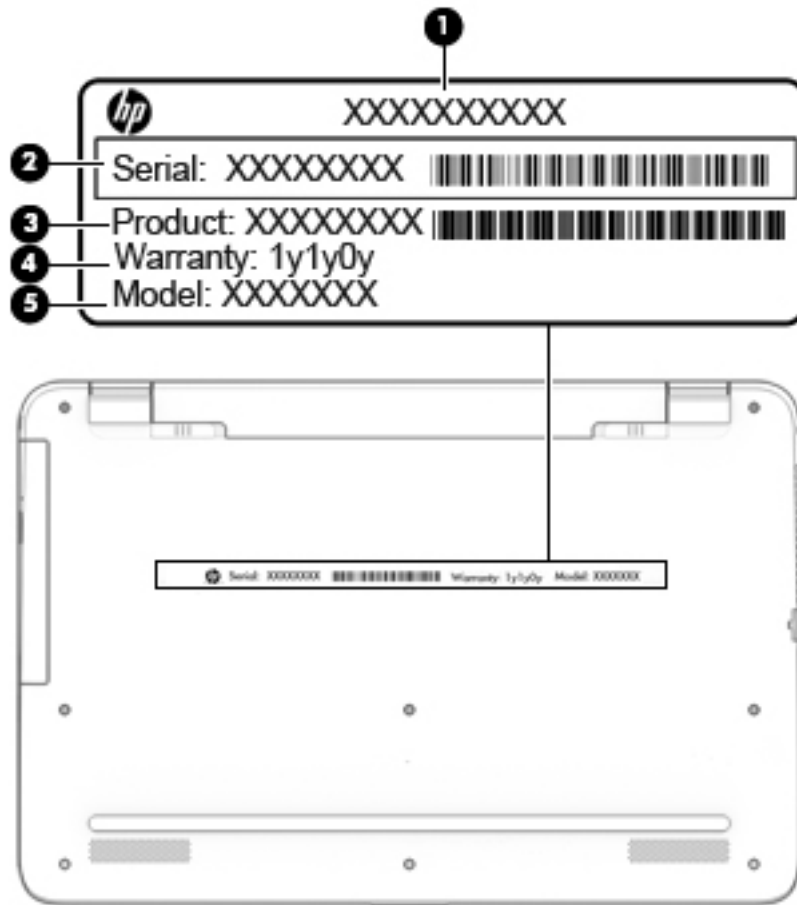

Item	Description	Function
(1)	Product name	This is the product name affixed to the front of the computer.
(2)	Serial number (s/n)	This is an alphanumeric identifier that is unique to each product.
(3)	Part number/Product number (p/n)	This number provides specific information about the product's hardware components. The part number helps a service technician to determine what components and parts are needed.
(4)	Warranty period	This number describes the duration of the warranty period for the computer.
(5)	Model description	This is the alphanumeric identifier used to locate documents, drivers, and support for the computer.

3 Illustrated parts catalog

Computer major components

 **NOTE:** HP continually improves and changes product parts. For complete and current information on supported parts for your computer, go to <http://partsurfer.hp.com>, select your country or region, and then follow the on-screen instructions.

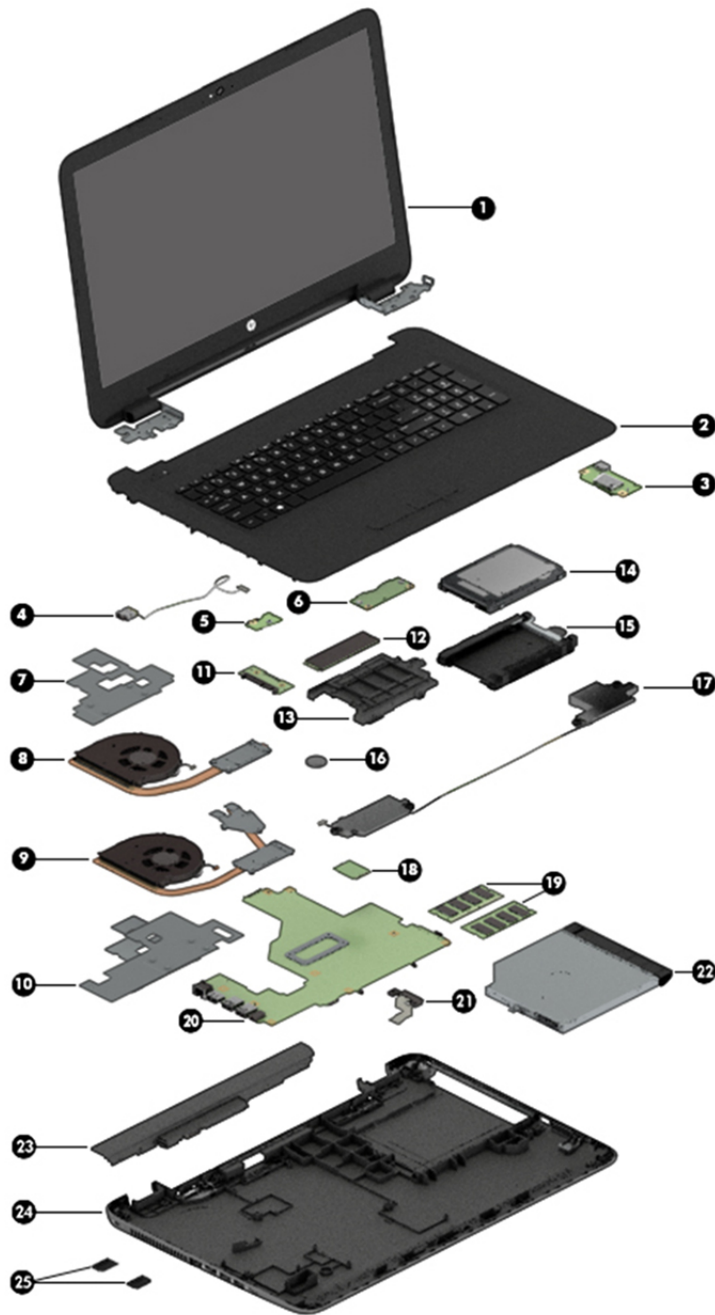

Item	Component	Spare part number
(1)	Display assembly [43.9-cm 17.3-in] NOTE: Displays are only spared at the subcomponent level. NOTE: For display assembly spare part information, see Display assembly subcomponents on page 21 .	
(2)	Top cover/keyboard (ash silver) (includes TouchPad) NOTE: For a detailed list of keyboard country codes, see Top cover/keyboard on page 79 . For use in models without a backlight:	
	• Black	856698-xx1
	• Turbo silver	856699-xx1
	• White silver	856700-xx1
	• Red	856757-xx1
	• Teal	856758-xx1
	• Blue	856759-xx1
	For use in models with a backlight:	
	• Black	856771-xx1
	• Turbo silver	856772-xx1
	• White silver	856773-xx1
	• Red	856775-xx1
	• Teal	856776-xx1
	• Blue	856777-xx1
(3)	USB board	856613-001
(4)	Power connector cable	856680-001
(5)	Power button board	856612-001
(6)	TouchPad board	858259-001
	Heat sink assembly (includes replacement thermal materials):	
(7)	For use in models with Intel Pentium or Celeron processors and UMA graphics	858503-001
(8)	For use in models with Intel Core processors and UMA graphics	856681-001
(9)	For use in models with Intel Core processors and discrete graphics	856682-001
(10)	For use in models with discrete graphics	858504-001
(11)	Solid-state drive board	856614-001
(12)	Solid-state drive	
	256 GB	865902-003
	128 GB	827560-025
(13)	Solid-state drive holder	858260-001
(14)	Hard drive (does not include bracket)	

Item	Component	Spare part number
	2-TB, 5400-rpm, 2.5-inch	801808-005
	1-TB, 5400-rpm, 2.5-inch, hybrid 8 GB SSD	731999-005
	1-TB, 5400-rpm, 2.5-inch	778192-005
	500-GB, 5400-rpm, 2.5 inch	778188-005
(15)	Hard drive cover	856584-001
(16)	RTC battery	858288-001
(17)	Speakers (includes left and right speakers and cable)	856617-001
(18)	WLAN module	
	Realtek RTL8723BE-VB 802.11b/g/n 1x1 Wi-Fi + BT4.0 Combo Adapter	855106-885
	Intel Dual Band Wireless-AC 3165 802.11 ac 1x1 WiFi + BT 4.2 Combo	806723-005
	Realtek RTL8188EE-VJ 802.11b/g/n 1x1 Wi-Fi Adapter	857334-855
	Intel Dual Band Wireless-AC 3168 802.11 ac 1x1 WiFi + BT 4.2 Combo	863934-855
(19)	Memory module (PC3L, 12800, 1600-MHz)	
	PC3L, 12800, 1600-MHz	
	For use in models with 5th generation Intel Core processors, Intel Pentium processors, and Intel Celeron processors	
	<ul style="list-style-type: none"> 8-GB 	693374-005
	<ul style="list-style-type: none"> 4 GB 	691740-005
	<ul style="list-style-type: none"> 2 GB 	691739-005
	PC4, 17000, 2133-MHz	
	For use in models with 6th generation Intel Core processors	
	<ul style="list-style-type: none"> 8-GB 	820570-005
	<ul style="list-style-type: none"> 4 GB 	820569-005
	<ul style="list-style-type: none"> 2 GB 	851379-005
(20)	System board (includes replacement thermal materials)	
	All system boards use the following part numbers:	
	xxxxxx-001: Windows 7 or non-Windows operating system	
	xxxxxx-601: Windows 10	
	For use in models with discrete graphics:	
	<ul style="list-style-type: none"> Intel Core i7-6500U processor and 4 GB of dedicated video memory (R7M1-70) 	856691-xxx
	<ul style="list-style-type: none"> Intel Core i7-6500U processor and 2 GB of dedicated video memory (R5M1-30) 	856689-xxx
	<ul style="list-style-type: none"> Intel Core i5-6200U processor and 2 GB of dedicated video memory (R7M1-70) 	856686-xxx
	<ul style="list-style-type: none"> Intel Core i5-6200U processor and 2 GB of dedicated video memory (R5M1-30) 	856685-xxx
	<ul style="list-style-type: none"> Intel Core i3-5005U processor and 2 GB of dedicated video memory (R5M1-30) 	856693-xxx

Item	Component	Spare part number
	<ul style="list-style-type: none"> Intel Pentium N3710 processor and 2 GB of dedicated video memory (R5M1-30) 	856696-xxx
	For use in models with UMA graphics:	
	<ul style="list-style-type: none"> Intel Core i7-6500U processor 	856688-xxx
	<ul style="list-style-type: none"> Intel Core i5-6200U processor 	856684-xxx
	<ul style="list-style-type: none"> Intel Core i3-6100U processor 	856683-xxx
	<ul style="list-style-type: none"> Intel Core i3-5005U processor 	856692-xxx
	<ul style="list-style-type: none"> Intel Pentium N3710 processor 	856694-xxx
	<ul style="list-style-type: none"> Intel Celeron N3060 processor 	856695-xxx
(21)	Optical Drive Connector Cable Kit	856609-001
(22)	DVD+/-RW Double-Layer SuperMulti Drive	756564-037
	Optical drive bracket (not illustrated)	856610-001
	Optical drive bezel (not illustrated)	856598-001
(23)	Battery	
	4-cell, 41-Whr, 2.8-Ah Li-ion	807957-001
	3-cell, 31-Whr, 2.8-Ah Li-ion	807956-001
(24)	Bottom cover	856601-001
(25)	Rubber Kit	856615-001

Display assembly subcomponents

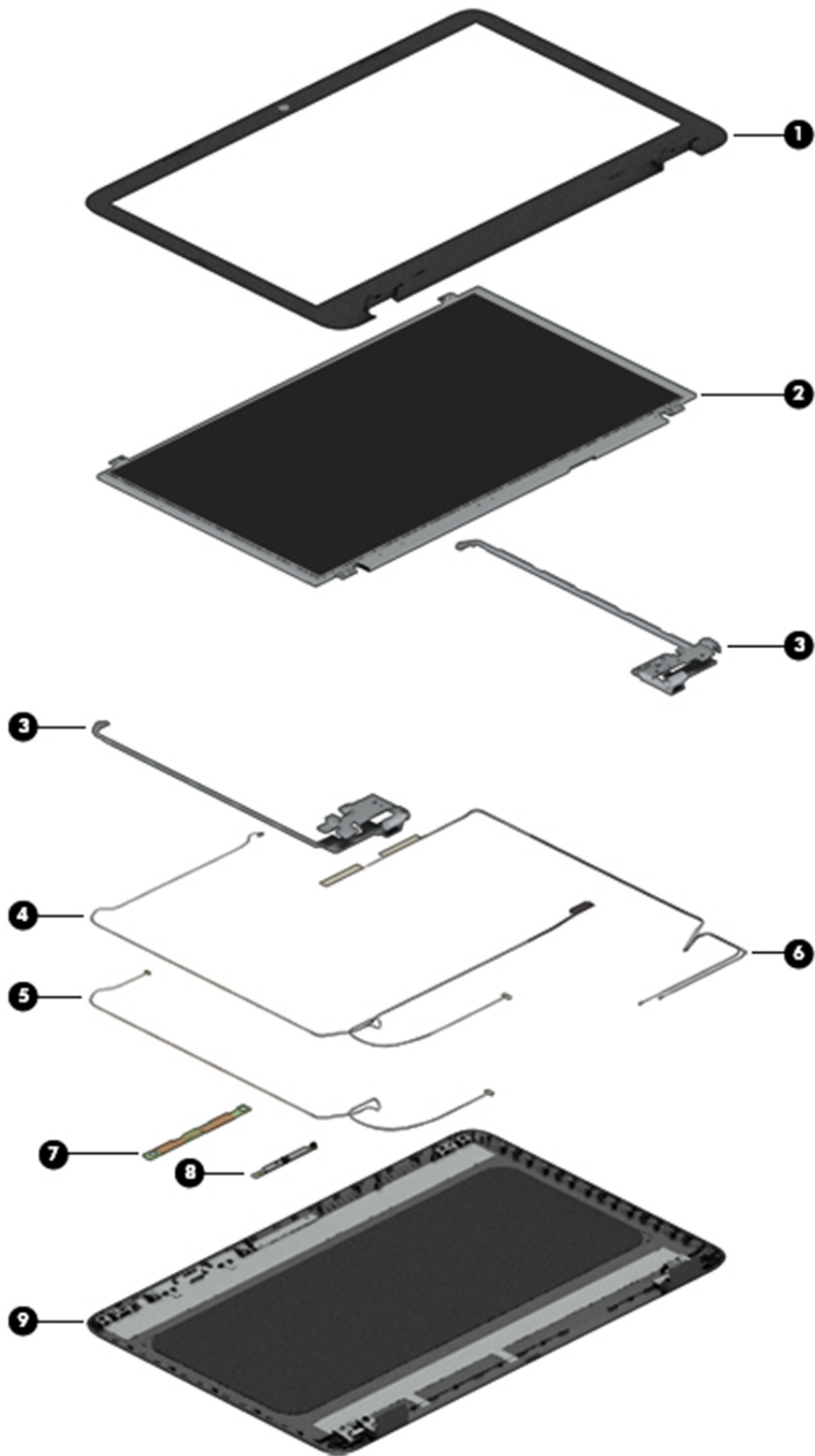

Item	Component	Spare part number
(1)	Display bezel	856597-001
(2)	Raw display panel (16:9 Ultra Wide Aspect Ratio [43.9-cm 17.3-in]; includes screw covers and touch sensor)	
	FHD, anti glare	798926-007
	FHD, Touch On Panel (TOP)	851048-001
	HD, Touch On Panel (TOP)	851049-001
	HD+, BrightView	851051-002
(3)	Hinges touch screen (left and right, includes screw covers)	856599-001
	Display cable	
(4)	Touch displays	856608-001
(5)	Non-touch displays	856607-001
(6)	Antennas	856611-001
(7)	Touch control board	856600-001
(8)	Webcam/microphone module	
	HD	709372-032
	VGA	766523-021
(9)	Display enclosure (non touch models)	
	Red models	856594-001
	White silver models	856593-001
	Blue models	856596-001
	Turbo silver models	856592-001
	Black models	856591-001
	Teal models	856595-001
	Purple models	900660-001
(9)	Display enclosure (touch models)	
	Red models	856588-001
	White silver models	856587-001
	Blue models	856590-001
	Turbo silver models	856586-001
	Black models	856585-001
	Teal models	856589-001
	Purple models	900659-001

Miscellaneous parts

Component	Spare part number
HP Smart AC adapter	
65-W EM	714635-850
65-W	710412-001
45-W	741553-850
Power cord (3-pin, black, 1.0-m) for use in:	
Australia	213356-008
People's Republic of China	286497-008
Denmark	213353-008
Germany, France, Spain, Nordic countries, Portugal, Greece, Arabia, the Netherlands, Belgium, Russia, Bulgaria, Romania, Poland, Hungary, Serbia, Adriatic countries, Czech/Slovakia, African English)	213350-009
India	404827-003
Israel	398063-003
Japan	349756-002
North America	213349-009
South Korea	267836-008
Switzerland	213354-008
The United Kingdom, Arabia, African English, Hong Kong	213351-008
Rubber Kit (includes front and rear feet)	856615-001
Screw Kit	856616-001
HDMI to VGA adapter	701943-001

Mass storage devices

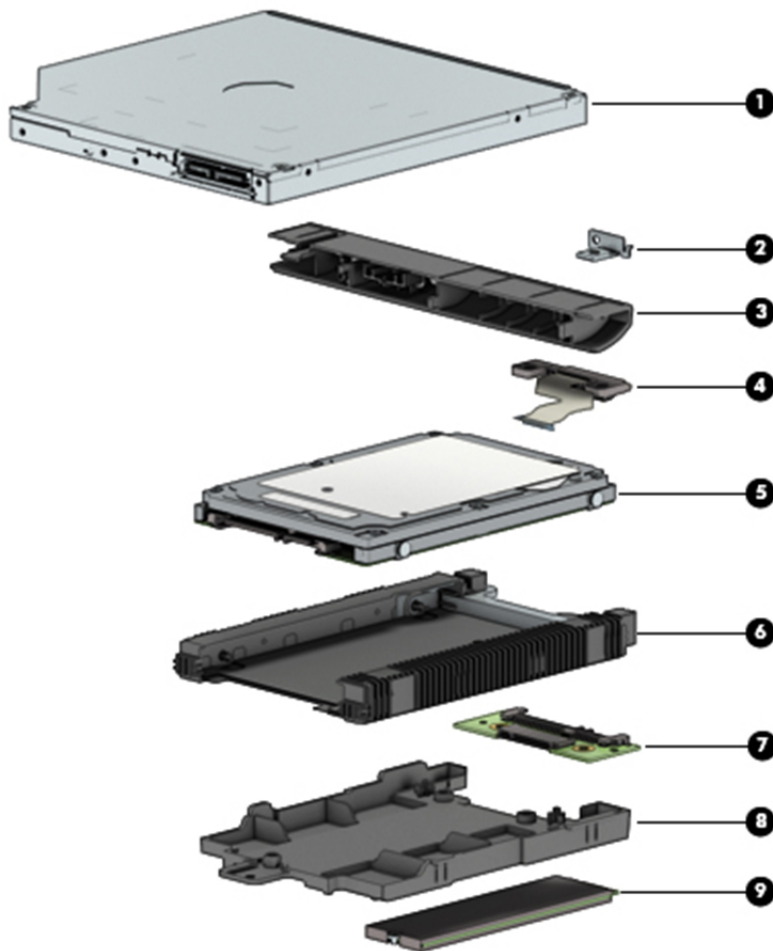

Item	Component	Spare part number
(1)	DVD+/-RW Double-Layer SuperMulti Drive	756564-037
(2)	Optical drive bracket	856610-001
(3)	Optical drive bezel	856598-001
(4)	Optical drive connector	856609-001
(5)	Hard drive (does not include bracket)	
	2-TB, 5400-rpm, 2.5-inch	801808-005
	1-TB, 5400-rpm, 2.5-inch, hybrid 8 GB SSD	731999-005
	1-TB, 5400-rpm, 2.5-in	778192-005
	500-GB, 5400-rpm, 2.5 inch	778188-005
(6)	Hard drive cover	856584-001
(7)	Solid-state drive board	856614-001
(8)	Solid-state drive holder	858260-001
(9)	Solid-state drive	

Item	Component	Spare part number
	256 GB	865902-003
	128 GB	827560-025

Cables

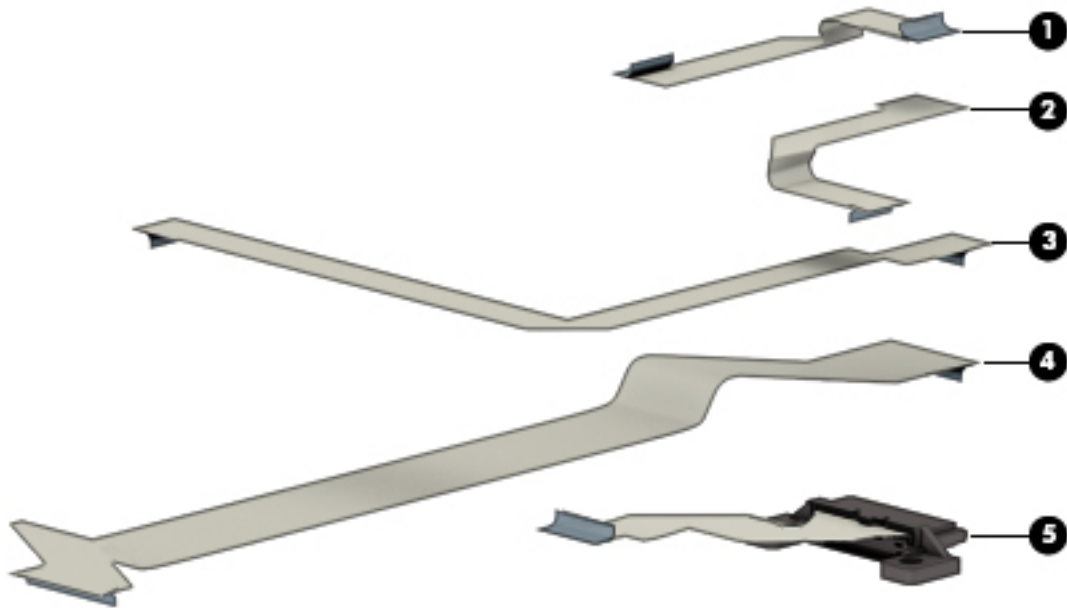

Item	Description	Spare part number
(1)	TouchPad cable	856605-001
(2)	Touch click board cable	856606-001
(3)	Power button board cable	856604-001
(4)	USB board cable	856603-001
(5)	Optical drive connector cable	856609-001

4 Removal and replacement procedures preliminary requirements

Tools required

You will need the following tools to complete the removal and replacement procedures:

- Flat-bladed screwdriver
- Magnetic screwdriver
- Phillips P0 and P1 screwdrivers

Service considerations

The following sections include some of the considerations that you must keep in mind during disassembly and assembly procedures.

 **NOTE:** As you remove each subassembly from the computer, place the subassembly (and all accompanying screws) away from the work area to prevent damage.

Plastic parts

 **CAUTION:** Using excessive force during disassembly and reassembly can damage plastic parts. Use care when handling the plastic parts. Apply pressure only at the points designated in the maintenance instructions.

Cables and connectors

 **CAUTION:** When servicing the computer, be sure that cables are placed in their proper locations during the reassembly process. Improper cable placement can damage the computer.

Cables must be handled with extreme care to avoid damage. Apply only the tension required to unseat or seat the cables during removal and insertion. Handle cables by the connector whenever possible. In all cases, avoid bending, twisting, or tearing cables. Be sure that cables are routed in such a way that they cannot be caught or snagged by parts being removed or replaced. Handle flex cables with extreme care; these cables tear easily.

Drive handling

⚠ CAUTION: Drives are fragile components that must be handled with care. To prevent damage to the computer, damage to a drive, or loss of information, observe these precautions:

Before removing or inserting a hard drive, shut down the computer. If you are unsure whether the computer is off or in Hibernation, turn the computer on, and then shut it down through the operating system.

Before handling a drive, be sure that you are discharged of static electricity. While handling a drive, avoid touching the connector.

Before removing a diskette drive or optical drive, be sure that a diskette or disc is not in the drive and be sure that the optical drive tray is closed.

Handle drives on surfaces covered with at least one inch of shock-proof foam.

Avoid dropping drives from any height onto any surface.

After removing a hard drive, an optical drive, or a diskette drive, place it in a static-proof bag.

Avoid exposing an internal hard drive to products that have magnetic fields, such as monitors or speakers.

Avoid exposing a drive to temperature extremes or liquids.

If a drive must be mailed, place the drive in a bubble pack mailer or other suitable form of protective packaging and label the package "FRAGILE."

Grounding guidelines

Electrostatic discharge damage

Electronic components are sensitive to electrostatic discharge (ESD). Circuitry design and structure determine the degree of sensitivity. Networks built into many integrated circuits provide some protection, but in many cases, ESD contains enough power to alter device parameters or melt silicon junctions.

A discharge of static electricity from a finger or other conductor can destroy static-sensitive devices or microcircuitry. Even if the spark is neither felt nor heard, damage may have occurred.

An electronic device exposed to ESD may not be affected at all and can work perfectly throughout a normal cycle. Or the device may function normally for a while, then degrade in the internal layers, reducing its life expectancy.

⚠ CAUTION: To prevent damage to the computer when you are removing or installing internal components, observe these precautions:

Keep components in their electrostatic-safe containers until you are ready to install them.

Before touching an electronic component, discharge static electricity by using the guidelines described in this section.

Avoid touching pins, leads, and circuitry. Handle electronic components as little as possible.

If you remove a component, place it in an electrostatic-safe container.

The following table shows how humidity affects the electrostatic voltage levels generated by different activities.

⚠ CAUTION: A product can be degraded by as little as 700 V.

Typical electrostatic voltage levels			
Event	Relative humidity		
	10%	40%	55%
Walking across carpet	35,000 V	15,000 V	7,500 V
Walking across vinyl floor	12,000 V	5,000 V	3,000 V
Motions of bench worker	6,000 V	800 V	400 V
Removing DIPs from plastic tube	2,000 V	700 V	400 V
Removing DIPs from vinyl tray	11,500 V	4,000 V	2,000 V
Removing DIPs from Styrofoam	14,500 V	5,000 V	3,500 V
Removing bubble pack from PCB	26,500 V	20,000 V	7,000 V
Packing PCBs in foam-lined box	21,000 V	11,000 V	5,000 V

Packaging and transporting guidelines

Follow these grounding guidelines when packaging and transporting equipment:

- To avoid hand contact, transport products in static-safe tubes, bags, or boxes.
- Protect ESD-sensitive parts and assemblies with conductive or approved containers or packaging.
- Keep ESD-sensitive parts in their containers until the parts arrive at static-free workstations.
- Place items on a grounded surface before removing items from their containers.
- Always be properly grounded when touching a component or assembly.
- Store reusable ESD-sensitive parts from assemblies in protective packaging or non-conductive foam.
- Use transporters and conveyors made of antistatic belts and roller bushings. Be sure that mechanized equipment used for moving materials is wired to ground and that proper materials are selected to avoid static charging. When grounding is not possible, use an ionizer to dissipate electric charges.

Workstation guidelines

Follow these grounding workstation guidelines:

- Cover the workstation with approved static-shielding material.
- Use a wrist strap connected to a properly grounded work surface and use properly grounded tools and equipment.
- Use conductive field service tools, such as cutters, screwdrivers, and vacuums.
- When fixtures must directly contact dissipative surfaces, use fixtures made only of static-safe materials.
- Keep the work area free of nonconductive materials, such as ordinary plastic assembly aids and Styrofoam.
- Handle ESD-sensitive components, parts, and assemblies by the case or PCM laminate. Handle these items only at static-free workstations.
- Avoid contact with pins, leads, or circuitry.
- Turn off power and input signals before inserting or removing connectors or test equipment.

Equipment guidelines

Grounding equipment must include either a wrist strap or a foot strap at a grounded workstation.

- When seated, wear a wrist strap connected to a grounded system. Wrist straps are flexible straps with a minimum of one megohm $\pm 10\%$ resistance in the ground cords. To provide proper ground, wear a strap snugly against the skin at all times. On grounded mats with banana-plug connectors, use alligator clips to connect a wrist strap.
- When standing, use foot straps and a grounded floor mat. Foot straps (heel, toe, or boot straps) can be used at standing workstations and are compatible with most types of shoes or boots. On conductive floors or dissipative floor mats, use foot straps on both feet with a minimum of one megohm resistance between the operator and ground. To be effective, the conductive must be worn in contact with the skin.

The following grounding equipment is recommended to prevent electrostatic damage:

- Antistatic tape
- Antistatic smocks, aprons, and sleeve protectors
- Conductive bins and other assembly or soldering aids
- Nonconductive foam
- Conductive tabletop workstations with ground cords of one megohm resistance
- Static-dissipative tables or floor mats with hard ties to the ground
- Field service kits
- Static awareness labels
- Material-handling packages
- Nonconductive plastic bags, tubes, or boxes
- Metal tote boxes
- Electrostatic voltage levels and protective materials

The following table lists the shielding protection provided by antistatic bags and floor mats.

Material	Use	Voltage protection level
Antistatic plastics	Bags	1,500 V
Carbon-loaded plastic	Floor mats	7,500 V
Metallized laminate	Floor mats	5,000 V

5 Removal and replacement procedures for Customer Self-Repair parts

 **CAUTION:** The Customer Self-Repair program is not available in all locations. Installing a part not supported by the Customer Self-Repair program may void your warranty. Check your warranty to determine if Customer Self-Repair is supported in your location.

 **NOTE:** HP continually improves and changes product parts. For complete and current information on supported parts for your computer, go to <http://partsurfer.hp.com>, select your country or region, and then follow the on-screen instructions.

Component replacement procedures

 **NOTE:** Please read and follow the procedures described here to access and replace Customer Self-Repair parts successfully.

 **NOTE:** Details about your computer, including model, serial number, product key, and length of warranty, are on the service tag at the bottom of your computer.

This chapter provides removal and replacement procedures for Customer Self-Repair parts.

There are as many as 2 screws that must be removed, replaced, or loosened when servicing Customer Self-Repair parts. Make special note of each screw size and location during removal and replacement.

Battery

Description	Spare part number
4-cell, 41-Whr, 2.8-Ah Li-ion battery	807957-001
3-cell, 31-Whr, 2.8-Ah Li-ion battery	807956-001

Before disassembling the computer, follow these steps:

1. Shut down the computer. If you are unsure whether the computer is off or in Hibernation, turn the computer on, and then shut it down through the operating system.
2. Disconnect all external devices connected to the computer.
3. Disconnect the power from the computer by first unplugging the power cord from the AC outlet and then unplugging the AC adapter from the computer.

To remove the battery:

1. Position the computer upside down on a flat surface.
2. Slide the battery lock latch **(1)** to unlock the battery, and then slide the battery release latch **(2)** to release the battery.



NOTE: The battery release latch automatically returns to its original position.

3. Remove the battery **(3)** from the computer.

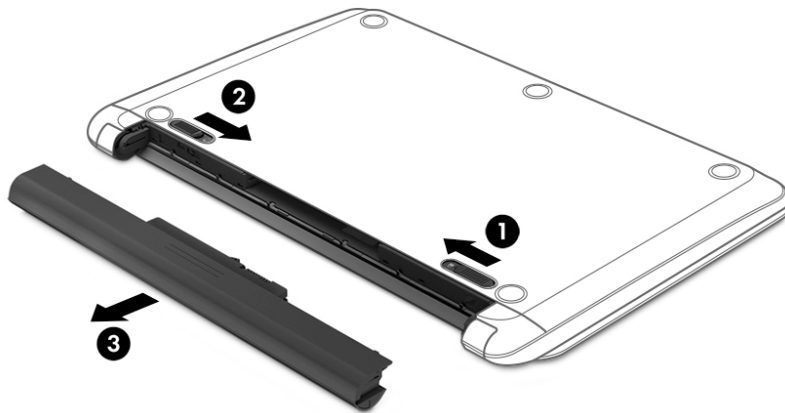

Optical drive

Description	Spare part number
Optical drive (DVD+/-RW Double-Layer SuperMulti)	756564-037
Optical drive bracket	856610-001
Optical drive bezel	856598-001

Before removing the optical drive, follow these steps:

1. Shut down the computer. If you are unsure whether the computer is off or in Hibernation, turn the computer on, and then shut it down through the operating system.
2. Disconnect all external devices connected to the computer.
3. Disconnect the power from the computer by first unplugging the power cord from the AC outlet and then unplugging the AC adapter from the computer.
4. Remove the battery (see [Battery on page 32](#)).

To remove the optical drive:

1. Remove the Phillips PM2.5×8.0 screw **(1)** that secures the optical drive to the computer.
2. Remove the optical drive **(2)** by sliding it out of the optical drive bay.

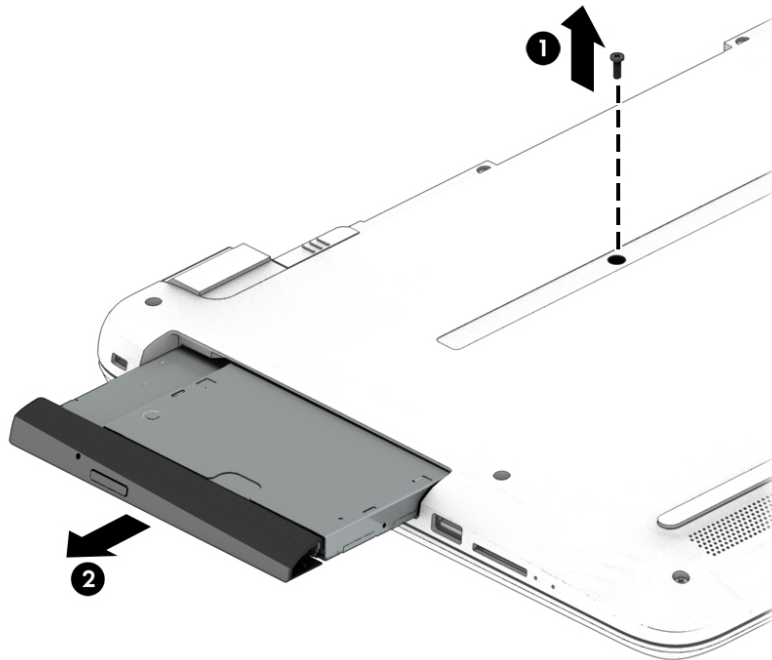

3. If it is necessary to replace the bracket on the rear of the optical drive, remove the Phillips PM2.0×2.5 screw **(1)** that secures the bracket to the drive, and then remove the bracket **(2)**.

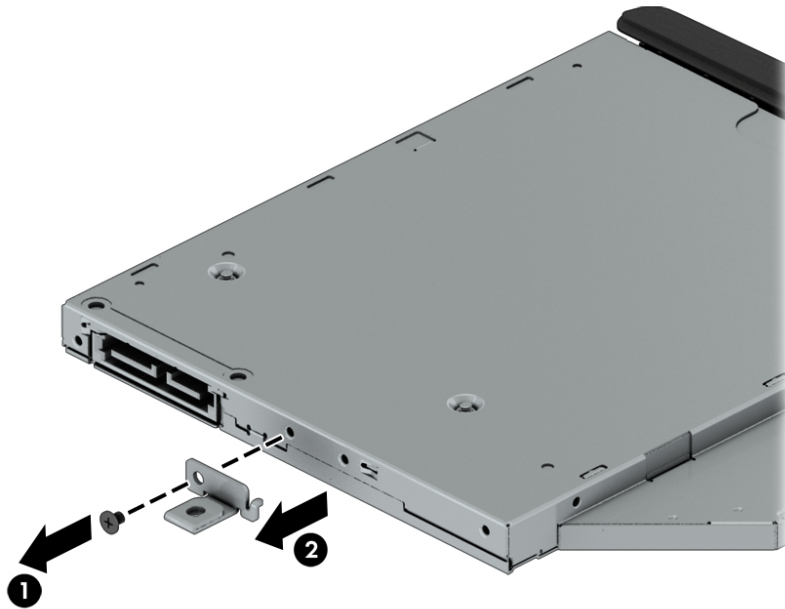

Reverse this procedure to reassemble and install the optical drive.

6 Removal and replacement procedures for Authorized Service Provider parts

 **CAUTION:** Components described in this chapter should only be accessed by an authorized service provider. Accessing these parts can damage the computer or void the warranty.

 **NOTE:** HP continually improves and changes product parts. For complete and current information on supported parts for your computer, go to <http://partsurfer.hp.com>, select your country or region, and then follow the on-screen instructions.

Component replacement procedures

 **NOTE:** Details about your computer, including model, serial number, product key, and length of warranty, are on the service tag at the bottom of your computer.

This chapter provides removal and replacement procedures for Authorized Service Provider only parts.

There are as many as 58 screws that must be removed, replaced, or loosened when servicing Authorized Service Provider only parts. Make special note of each screw size and location during removal and replacement.

Display subcomponents (bezel, webcam, panel)

This section describes removing display subcomponents that do not require that you remove the entire display assembly from the computer. You can remove the display bezel, webcam/microphone module, and display panel while the display assembly is still attached to the computer.

To remove the remaining display subcomponents, you must remove the entire display assembly from the computer. See [Display assembly on page 67](#) for more information about removing the display assembly in its entirety.

Description	Spare part number
Raw display panel	
FHD, anti glare	798926-007
FHD, Touch On Panel (TOP)	851048-001
HD, Touch On Panel (TOP)	851049-001
HD+, BrightView	851051-002
Display bezel	856597-001
Webcam/microphone module	
HD	709372-032
VGA	766523-021

Before removing display subcomponents while the display assembly is still attached to the computer, follow these steps:

1. Shut down the computer. If you are unsure whether the computer is off or in Hibernation, turn the computer on, and then shut it down through the operating system.
2. Disconnect all external devices connected to the computer.
3. Disconnect the power from the computer by first unplugging the power cord from the AC outlet and then unplugging the AC adapter from the computer.
4. Remove the battery (see [Battery on page 32](#)).

To remove the display bezel, webcam/microphone module, and raw display panel:

1. Position the computer upright with the front toward you, and then open it.
2. Flex the inside of the top edge **(1)**, left and right sides **(2)**, and the inside of the bottom edge **(3)** of the display bezel until the bezel disengages from the display enclosure.
3. Remove the display bezel **(4)**.

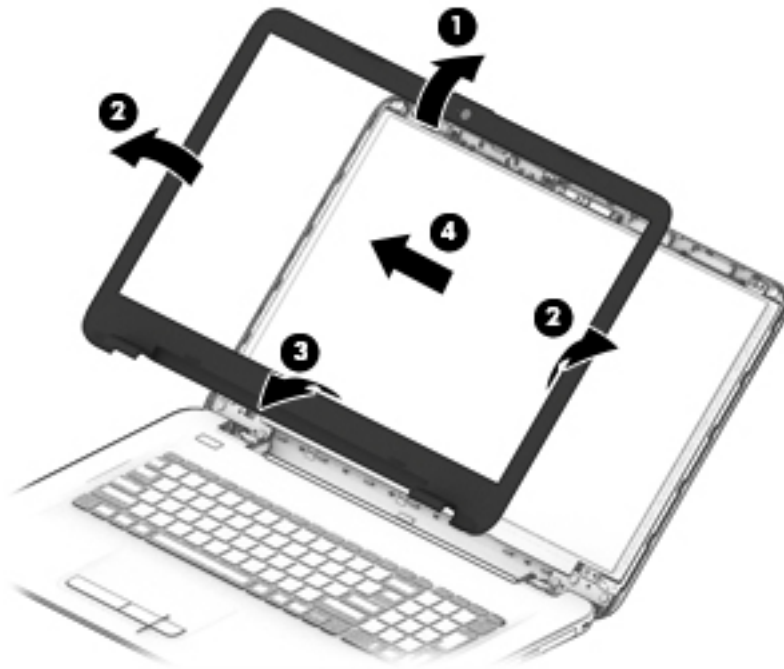

4. To remove the webcam/microphone module:
 - a. Position the display assembly with the top edge toward you.
 - b. Lift to disengage the adhesive that secures the webcam/microphone module to the display **(1)**.
 - c. Disconnect the cable **(2)** from the module.

- d. Remove the module (3).

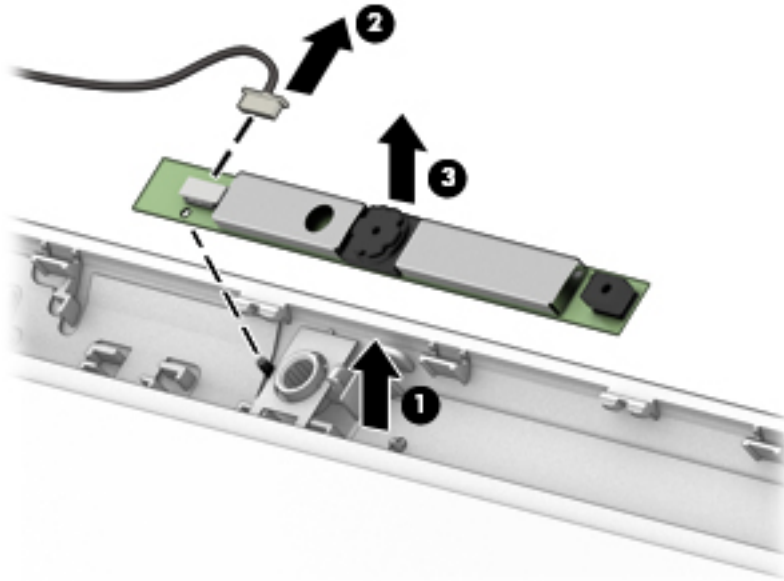

5. To remove the display panel:

- a. Remove the four Phillips PM2.0×3.0 screws (1) that secure the display panel to the enclosure.
- b. Rotate the display panel onto the keyboard (2) to gain access to the display cable connection on the back of the panel.

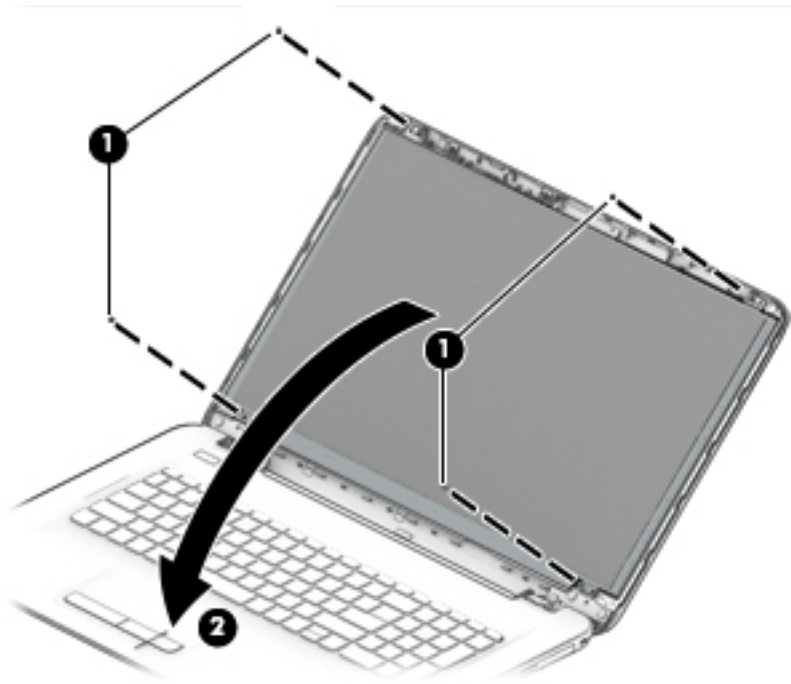

- c. On the back of the display panel, release the adhesive strip that secures the display panel cable to the display panel, and then disconnect the cable (1).

- d. Remove the display panel from the computer **(2)**.

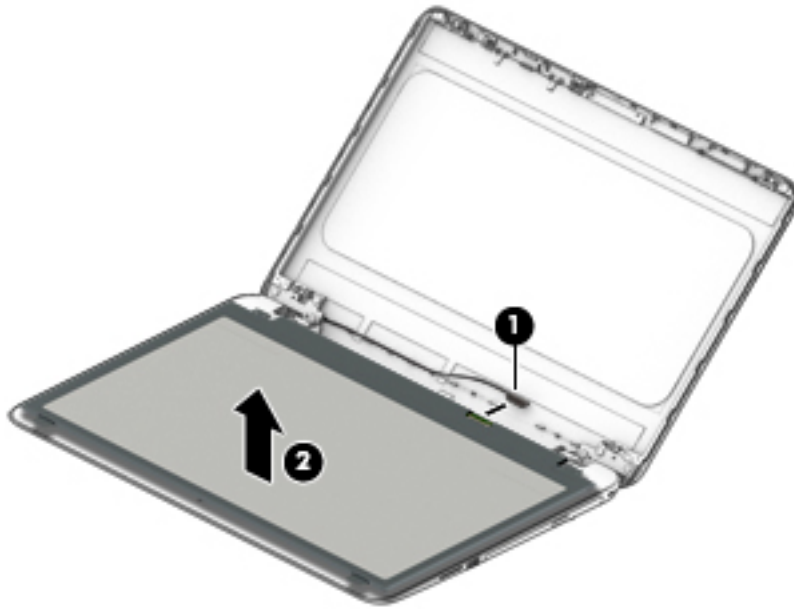

Reverse this procedure to reassemble and install the display bezel, webcam/microphone module, and display panel.

Bottom cover

Description	Spare part number
Bottom cover	856601-001

Before removing the bottom cover, follow these steps:

1. Shut down the computer. If you are unsure whether the computer is off or in Hibernation, turn the computer on, and then shut it down through the operating system.
2. Disconnect all external devices connected to the computer.
3. Disconnect the power from the computer by first unplugging the power cord from the AC outlet and then unplugging the AC adapter from the computer.
4. Remove the battery (see [Battery on page 32](#)).
5. Remove the optical drive (see [Optical drive on page 33](#)).

To remove the bottom cover:

1. Position the computer upside down with the front toward you.
2. Remove the two rubber feet **(1)**.
3. Remove the service label screw cutouts from above the two screws under the label **(2)**.



NOTE: Two screws that are located under the regulatory label are marked with a dashed circle and “+” sign .

Do not remove the regulatory label – only remove or punch holes through the circular cutouts above the screws.

4. Remove the 14 Phillips PM PM2.5×8.0 screws (3) that secure the top cover to the computer.

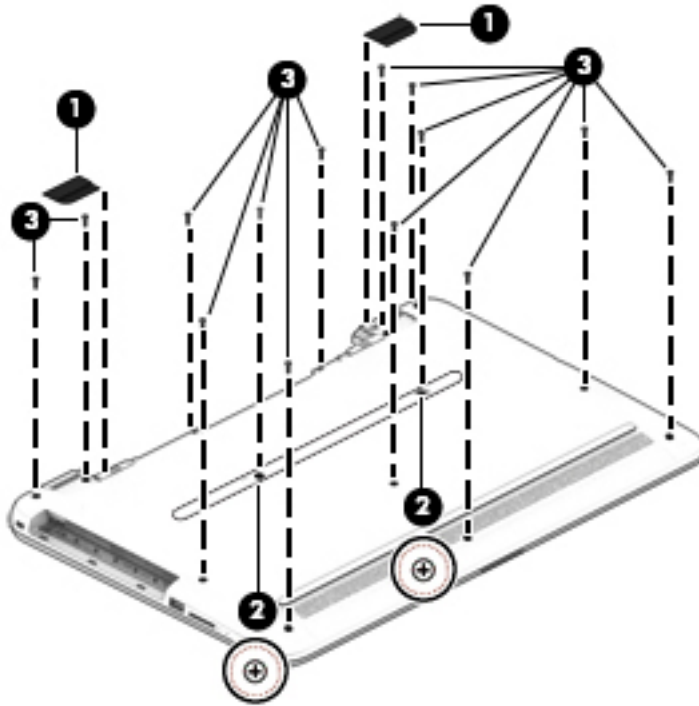

5. Start at the front of the computer and pry to separate the bottom cover from the computer (1). Work your way around prying to disengage the bottom cover from the computer, and then remove the cover (2).

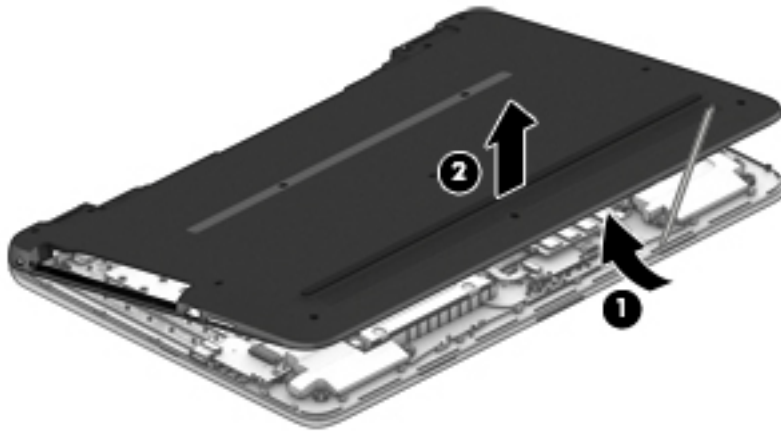

Reverse this procedure to install the bottom cover.

Hard drive



NOTE: The hard drive spare part kit does not include the hard drive cover.

Description	Spare part number
2-TB, 5400-rpm, 2.5-inch	801808-005
1-TB, 5400-rpm, 2.5-inch, hybrid 8 GB SSD	731999-005
1-TB, 5400-rpm, 2.5-in	778192-005
500-GB, 5400-rpm, 2.5 inch	778188-005
Hard drive cover	856584-001

Before removing the hard drive, follow these steps:

1. Shut down the computer. If you are unsure whether the computer is off or in Hibernation, turn the computer on, and then shut it down through the operating system.
2. Disconnect all external devices connected to the computer.
3. Disconnect the power from the computer by first unplugging the power cord from the AC outlet and then unplugging the AC adapter from the computer.
4. Remove the battery (see [Battery on page 32](#)).
5. Remove the optical drive (see [Optical drive on page 33](#)).
6. Remove the bottom cover (see [Bottom cover on page 39](#)).

To remove the hard drive:

1. Remove the USB board cable from atop the hard drive as follows:
 - a. Lift the ZIF connector **(1)**, and then disconnect the cable from the system board **(2)**.
 - b. Lift the ZIF connector **(3)**, and then disconnect the cable from the USB board **(4)**.
 - c. Remove the USB board cable from atop the hard drive **(5)**.

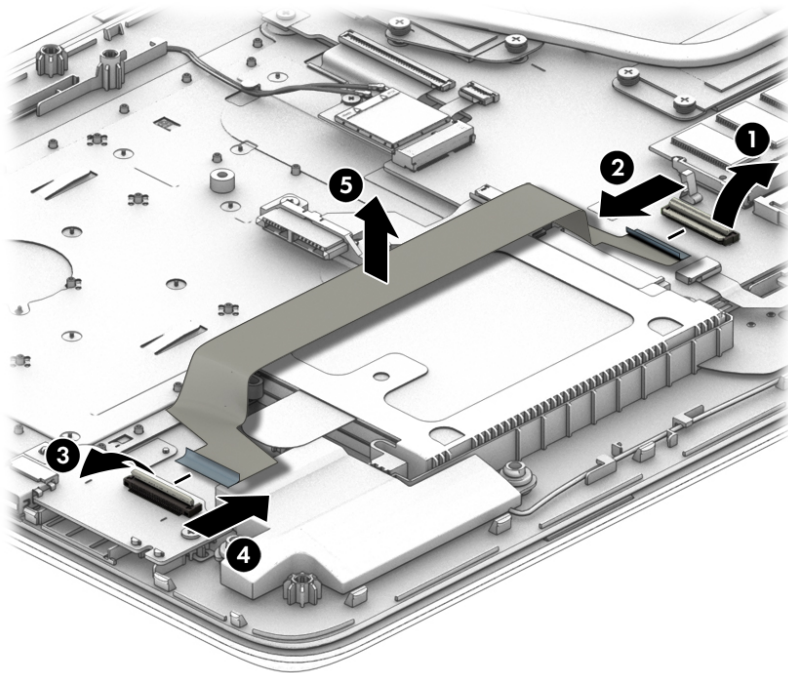

2. Rotate the hard drive upward (1).
3. Pull the drive away from the connector, and then remove it from the computer (2).

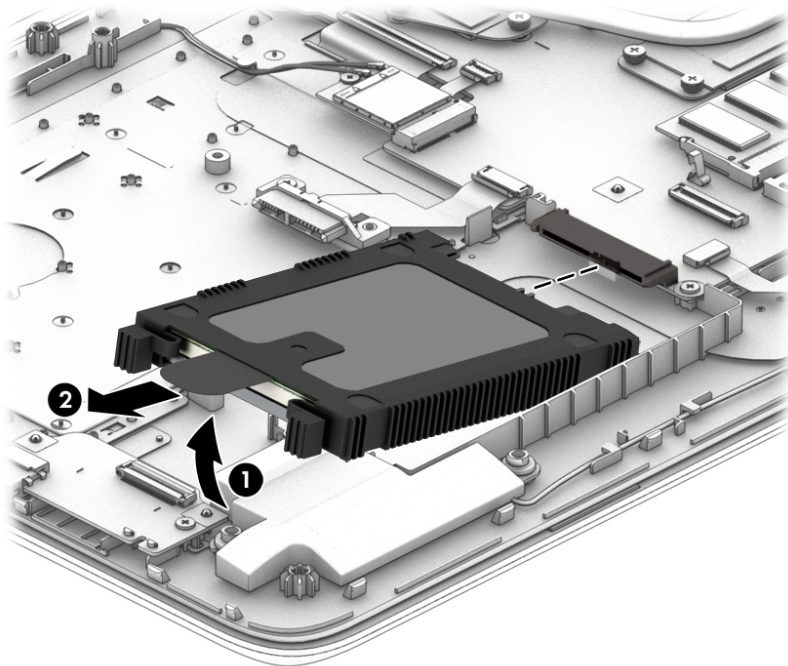

4. To disassemble the hard drive, lift the cover off the hard drive

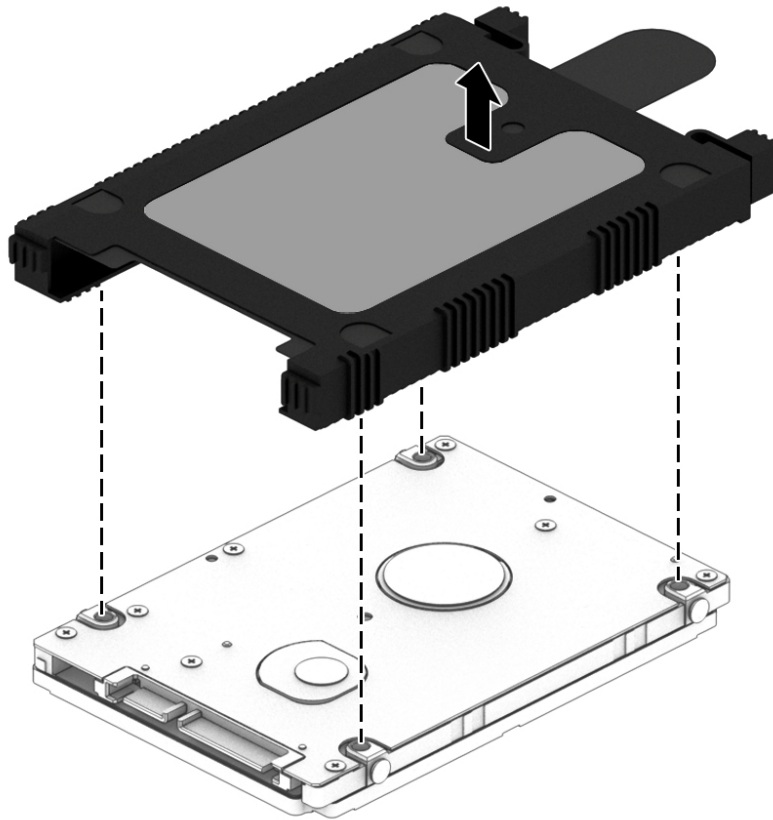

Reverse this procedure to reassemble and install the hard drive.

WLAN module

Description	Spare part number
Realtek RTL8723BE-VB 802.11b/g/n 1x1 Wi-Fi + BT4.0 Combo Adapter	855106-885
Intel Dual Band Wireless-AC 3165 802.11 ac 1x1 WiFi + BT 4.2 Combo	806723-005
Realtek RTL8188EE-VJ 802.11b/g/n 1x1 Wi-Fi Adapter	857334-855
Intel Dual Band Wireless-AC 3168 802.11 ac 1x1 WiFi + BT 4.2 Combo	863934-855

 **CAUTION:** To prevent an unresponsive system, replace the wireless module only with a wireless module authorized for use in the computer by the governmental agency that regulates wireless devices in your country or region. If you replace the module and then receive a warning message, remove the module to restore device functionality, and then contact support.

Before removing the WLAN module, follow these steps:

1. Shut down the computer. If you are unsure whether the computer is off or in Hibernation, turn the computer on, and then shut it down through the operating system.
2. Disconnect all external devices connected to the computer.
3. Disconnect the power from the computer by first unplugging the power cord from the AC outlet and then unplugging the AC adapter from the computer.
4. Remove the battery (see [Battery on page 32](#)).
5. Remove the optical drive (see [Optical drive on page 33](#)).
6. Remove the bottom cover (see [Bottom cover on page 39](#)).

To remove the WLAN module:

1. Disconnect the WLAN antenna cables **(1)** from the terminals on the WLAN module.



NOTE: The #1 WLAN antenna cable is connected to the WLAN module Main terminal. The #2 WLAN antenna cable is connected to the WLAN module Aux terminal.

2. Remove the Phillips PM2.0×3.0 screw **(2)** that secures the WLAN module to the system board. (The WLAN module tilts up.)

3. Remove the WLAN module by pulling the module away from the slot at an angle (3).

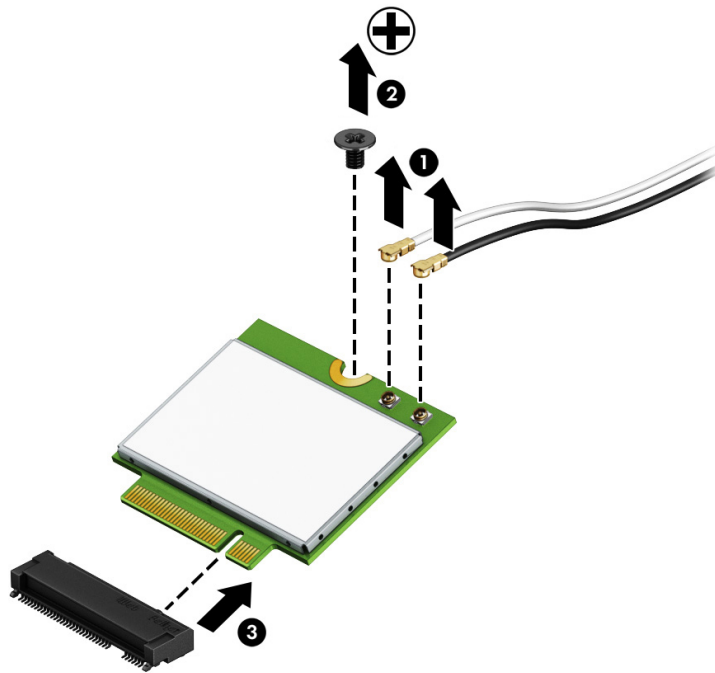

 **NOTE:** If the WLAN antennas are not connected to the terminals on the WLAN module, the protective sleeves must be installed on the antenna connectors, as shown in the following illustration.

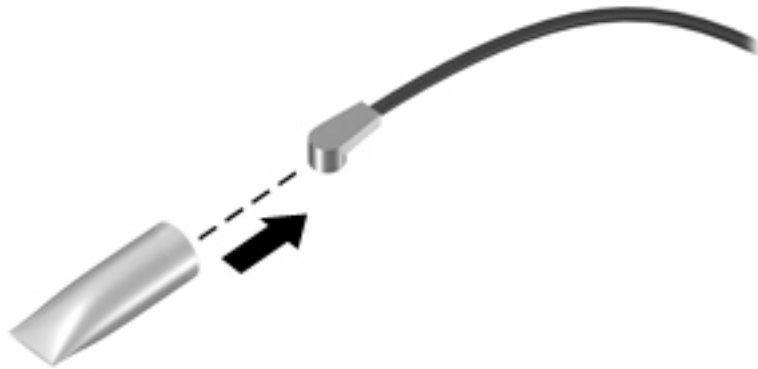

Reverse this procedure to install the WLAN module.

RTC battery

Description	Spare part number
RTC battery	858288-001

Before removing the RTC battery, follow these steps:

1. Shut down the computer. If you are unsure whether the computer is off or in Hibernation, turn the computer on, and then shut it down through the operating system.
2. Disconnect all external devices connected to the computer.
3. Disconnect the power from the computer by first unplugging the power cord from the AC outlet and then unplugging the AC adapter from the computer.
4. Remove the battery (see [Battery on page 32](#)).
5. Remove the optical drive (see [Optical drive on page 33](#)).
6. Remove the bottom cover (see [Bottom cover on page 39](#)).

To remove the RTC battery:

- ▲ Using a thin tool or screwdriver, disengage the battery from the socket **(1)**, and then remove the battery **(2)**.

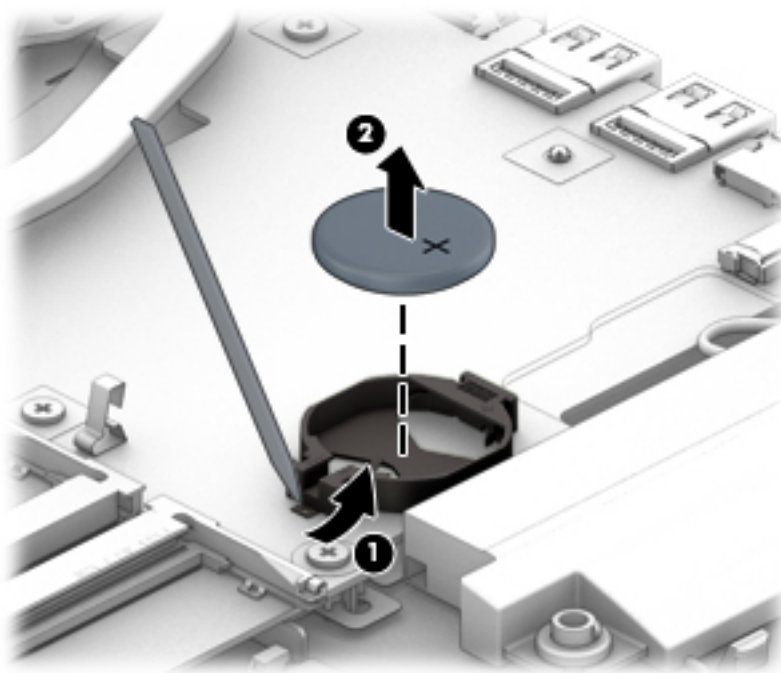

Reverse this procedure to install the RTC battery.

Memory module

Description	Spare part number
Memory module (PC3L, 12800, 1600-MHz) For use in models with 5th generation Intel Core processors, Intel Pentium processors, and Intel Celeron processors	
8-GB	693374-005
4-GB	691740-005
2-GB	691739-005
Memory module (PC4, 17000, 2133-MHz) For use in models with 6th generation Intel Core processors	
8-GB	820570-005
4-GB	820569-005
2-GB	851379-005

Before removing a memory module, follow these steps:

1. Shut down the computer. If you are unsure whether the computer is off or in Hibernation, turn the computer on, and then shut it down through the operating system.
2. Disconnect all external devices connected to the computer.
3. Disconnect the power from the computer by first unplugging the power cord from the AC outlet and then unplugging the AC adapter from the computer.
4. Remove the battery (see [Battery on page 32](#)).
5. Remove the optical drive (see [Optical drive on page 33](#)).
6. Remove the bottom cover (see [Bottom cover on page 39](#)).

To remove a memory module:

1. Spread the retaining tabs **(1)** on each side of the memory module slot to release the memory module. (The memory module tilts up.)

2. Remove the memory module **(2)** by pulling it away from the slot at an angle.

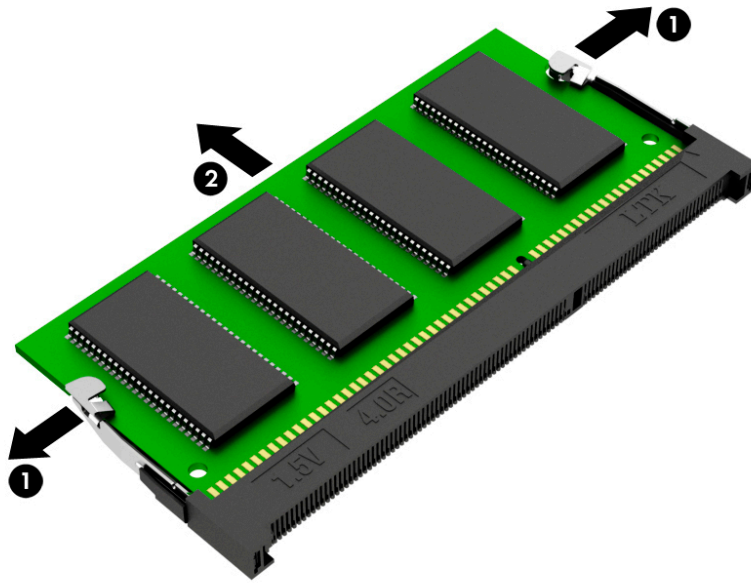

Reverse this procedure to install a memory module.

Solid-state drive

Description	Spare part number
256-GB solid-state drive	865902-003
128-GB solid-state drive	827560-025

Before removing the solid-state drive, follow these steps:

1. Turn off the computer. If you are unsure whether the computer is off or in Hibernation, turn the computer on, and then shut it down through the operating system.
2. Disconnect the power from the computer by unplugging the power cord from the computer.
3. Remove the battery (see [Battery on page 32](#)).
4. Remove the optical drive (see [Optical drive on page 33](#)).
5. Remove the bottom cover (see [Bottom cover on page 39](#)).

Remove the solid-state drive:

1. Remove the Phillips PM2.0×2.0 screw (1) that secures the drive to the system board.
2. Remove the drive (2) by pulling it away from the connector.

 **NOTE:** Solid-state drives are designed with notches to prevent incorrect insertion.

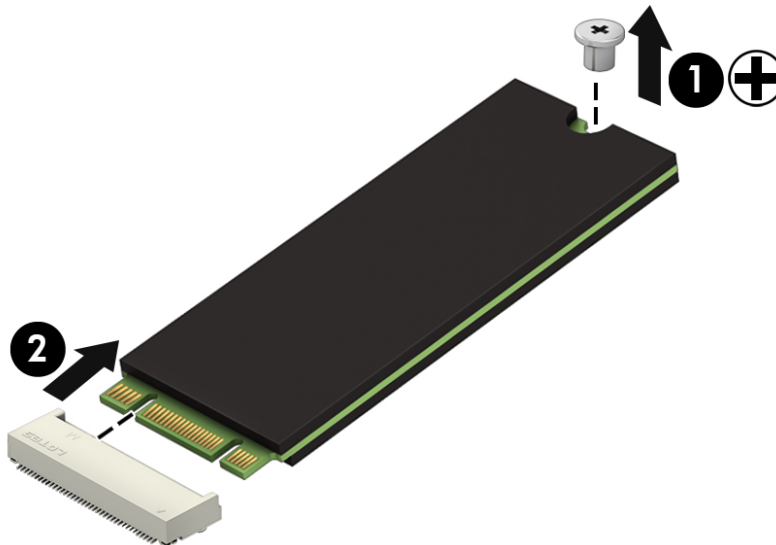

Reverse this procedure to install the solid-state drive.

Solid-state drive holder and board

Description	Spare part number
Solid-state drive holder	858260-001
Solid-state drive board	856614-001

Before removing the solid-state drive holder and board, follow these steps:

1. Shut down the computer. If you are unsure whether the computer is off or in Hibernation, turn the computer on, and then shut it down through the operating system.
2. Disconnect all external devices connected to the computer.
3. Disconnect the power from the computer by first unplugging the power cord from the AC outlet and then unplugging the AC adapter from the computer.
4. Remove the battery (see [Battery on page 32](#)).
5. Remove the optical drive (see [Optical drive on page 33](#)).
6. Remove the bottom cover (see [Bottom cover on page 39](#)).
7. Remove the solid-state drive (see [Solid-state drive on page 49](#)).

To remove the solid-state drive holder and board:

1. Remove the Phillips PM2.0×4.5 screws **(1)** that secures the solid-state drive holder to the computer.
2. Pull the board away from the connector on system board **(2)**, and then remove the solid-state drive holder and board assembly **(3)**.

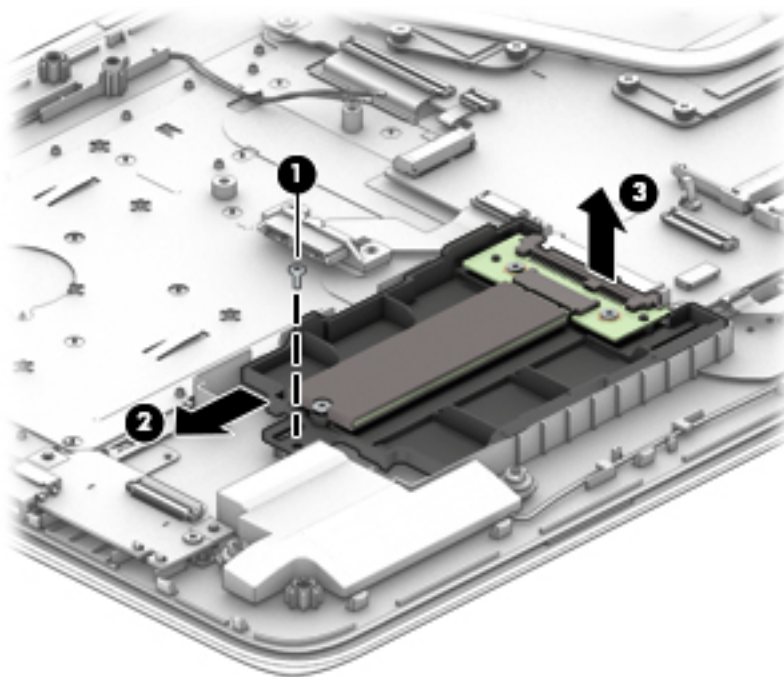

3. To remove the solid-state drive board from the holder, remove the two Phillips PM2.0×4.0 screws **(1)** that secure the board to the holder.

4. Lift the board out of the holder **(2)**.

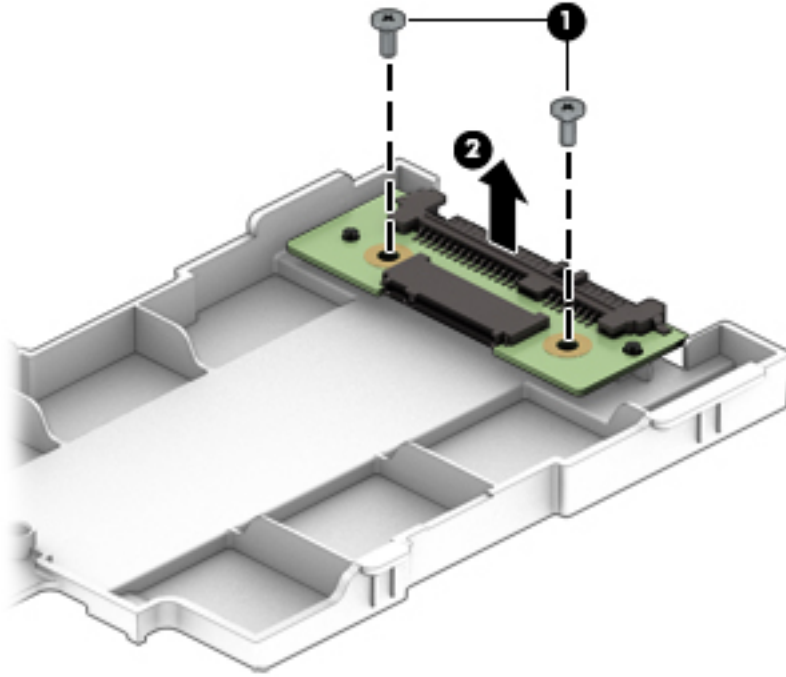

Reverse this procedure to install the solid-state drive holder and board.

Optical drive connector

Description	Spare part number
Optical drive connector	856609-001

Before removing the optical drive connector, follow these steps:

1. Shut down the computer. If you are unsure whether the computer is off or in Hibernation, turn the computer on, and then shut it down through the operating system.
2. Disconnect all external devices connected to the computer.
3. Disconnect the power from the computer by first unplugging the power cord from the AC outlet and then unplugging the AC adapter from the computer.
4. Remove the battery (see [Battery on page 32](#)).
5. Remove the optical drive (see [Optical drive on page 33](#)).
6. Remove the bottom cover (see [Bottom cover on page 39](#)).

To remove the optical drive connector:

1. Disconnect the optical drive connector cable from the system board **(1)**.
2. Remove the Phillips PM2.0×3.0 screw **(2)** that secures the optical drive connector to the computer.
3. Remove the optical drive connector and cable **(3)**.

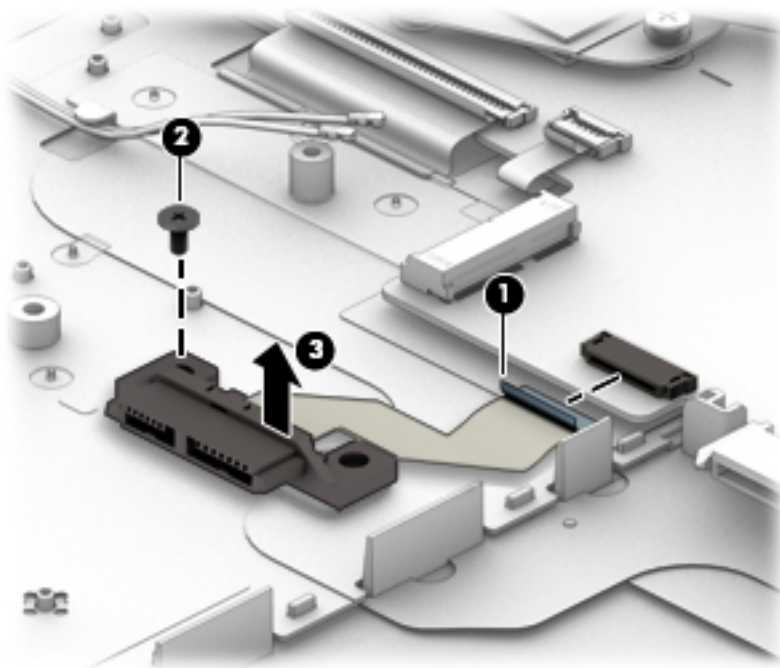

Reverse this procedure to install the optical drive connector.

TouchPad click board

Description	Spare part number
TouchPad click board	858259-001
TouchPad click board cable	856606-001
TouchPad cable	856605-001

Before removing the TouchPad click board, follow these steps:

1. Shut down the computer. If you are unsure whether the computer is off or in Hibernation, turn the computer on, and then shut it down through the operating system.
2. Disconnect all external devices connected to the computer.
3. Disconnect the power from the computer by first unplugging the power cord from the AC outlet and then unplugging the AC adapter from the computer.
4. Remove the battery (see [Battery on page 32](#)).
5. Remove the optical drive (see [Optical drive on page 33](#)).
6. Remove the bottom cover (see [Bottom cover on page 39](#)).

To remove the TouchPad click board:

1. Disconnect the cables from the TouchPad cable **(1)** and the TouchPad click board cable **(2)**.
2. Remove the two Phillips PM2.0×4.0 screws **(3)** that secure the TouchPad to the computer.
3. Remove the board **(4)**.

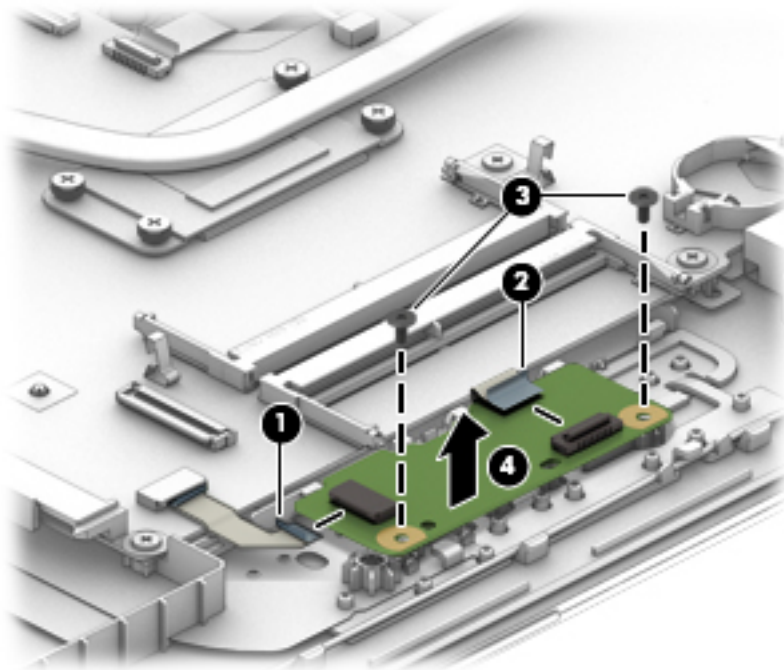

Reverse this procedure to install the TouchPad click board.

USB board

Description	Spare part number
USB board	856613-001

Before removing the USB board, follow these steps:

1. Shut down the computer. If you are unsure whether the computer is off or in Hibernation, turn the computer on, and then shut it down through the operating system.
2. Disconnect all external devices connected to the computer.
3. Disconnect the power from the computer by first unplugging the power cord from the AC outlet and then unplugging the AC adapter from the computer.
4. Remove the battery (see [Battery on page 32](#)).
5. Remove the optical drive (see [Optical drive on page 33](#)).
6. Remove the bottom cover (see [Bottom cover on page 39](#)).

To remove the USB board:

1. Disconnect the cable from the USB board **(1)**
2. Remove the Phillips PM2.0×4.0 screw **(2)** that secures the USB board to the computer.
3. Remove the USB board **(3)**.

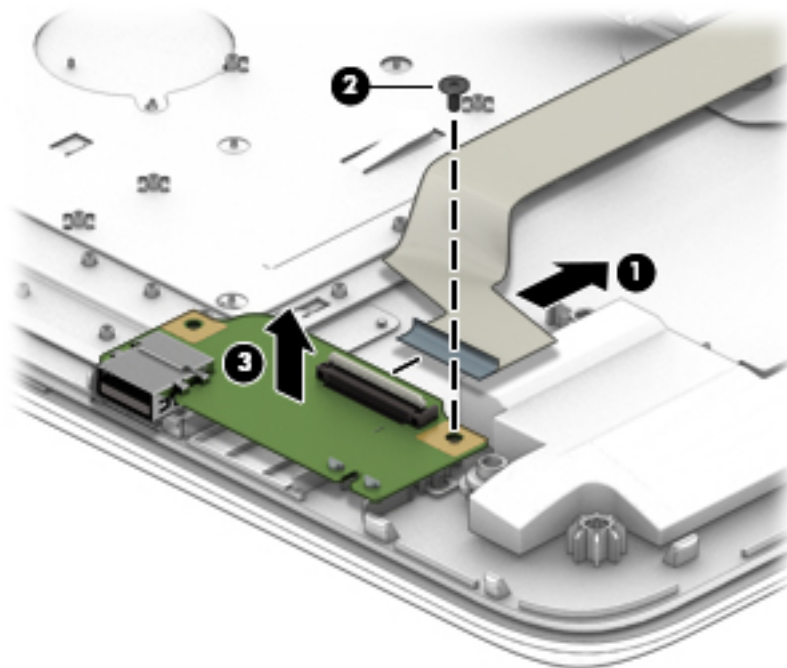

Reverse this procedure to install the USB board.

Speakers

Description	Spare part number
Speakers (includes left and right speakers and cable)	856617-001

Before removing the speakers, follow these steps:

1. Shut down the computer. If you are unsure whether the computer is off or in Hibernation, turn the computer on, and then shut it down through the operating system.
2. Disconnect all external devices connected to the computer.
3. Disconnect the power from the computer by first unplugging the power cord from the AC outlet and then unplugging the AC adapter from the computer.
4. Remove the battery (see [Battery on page 32](#)).
5. Remove the optical drive (see [Optical drive on page 33](#)).
6. Remove the bottom cover (see [Bottom cover on page 39](#)).

To remove the speakers:

1. Disconnect the speaker cable from the system board (1).
2. Remove the cable from the routing path (2).
3. Lift the speakers out of the computer (3).

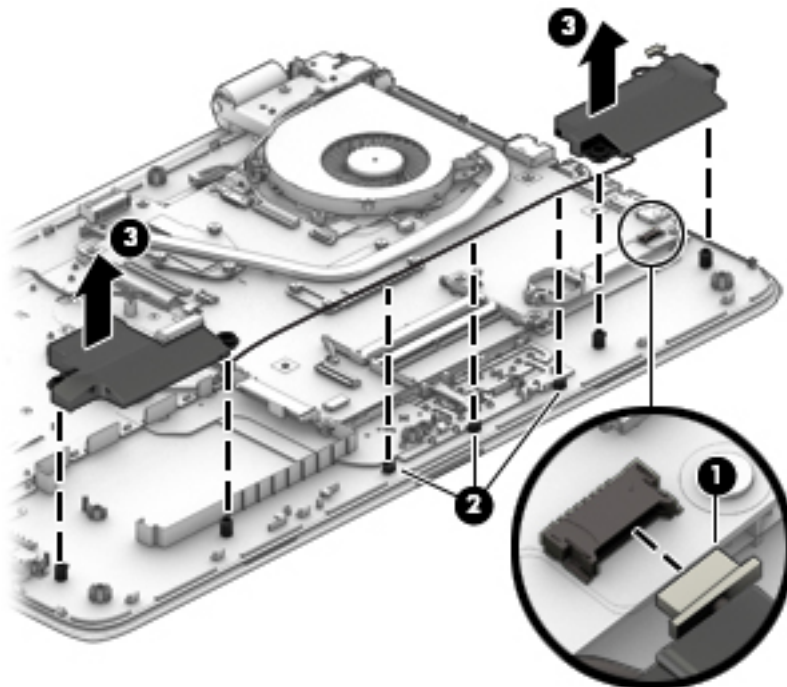

Reverse this procedure to install the speakers.

Fan/heat sink assembly



NOTE: The heat sink assembly spare part kit includes replacement thermal materials.

Description	Spare part number
Fan/heat sink assembly for use in models with discrete graphics	858504-001
Fan/heat sink assembly for use in models with Intel Core processors and UMA graphics	856681-001
Fan/heat sink assembly for use in models with Intel Core processors and discrete graphics	856682-001
Fan/heat sink assembly for use in models with Intel Pentium or Celeron processors and UMA graphics	858503-001



NOTE: To properly ventilate the computer, allow at least **7.6 cm** (3.0 in) of clearance on the left side of the computer. The computer uses an electric fan for ventilation. The fan is controlled by a temperature sensor and is designed to turn on automatically when high temperature conditions exist. These conditions are affected by high external temperatures, system power consumption, power management/battery conservation configurations, battery fast charging, and software requirements. Exhaust air is displaced through the ventilation grill located on the left side of the computer.

Before removing the heat sink assembly, follow these steps:

1. Shut down the computer. If you are unsure whether the computer is off or in Hibernation, turn the computer on, and then shut it down through the operating system.
2. Disconnect all external devices connected to the computer.
3. Disconnect the power from the computer by first unplugging the power cord from the AC outlet and then unplugging the AC adapter from the computer.
4. Remove the battery (see [Battery on page 32](#)).
5. Remove the optical drive (see [Optical drive on page 33](#)).
6. Remove the bottom cover (see [Bottom cover on page 39](#)).

To remove the fan/heat sink assembly:

1. If you have a model with discrete graphics and a fan integrated in the heat sink:
 - a. Disconnect the fan cable from the system board **(1)**.
 - b. In the order indicated, remove the six Phillips PM2.0×3.0 screws **(2)** that secure the heat sink to the system board.

- c. Remove the heat sink **(3)** from the system board.

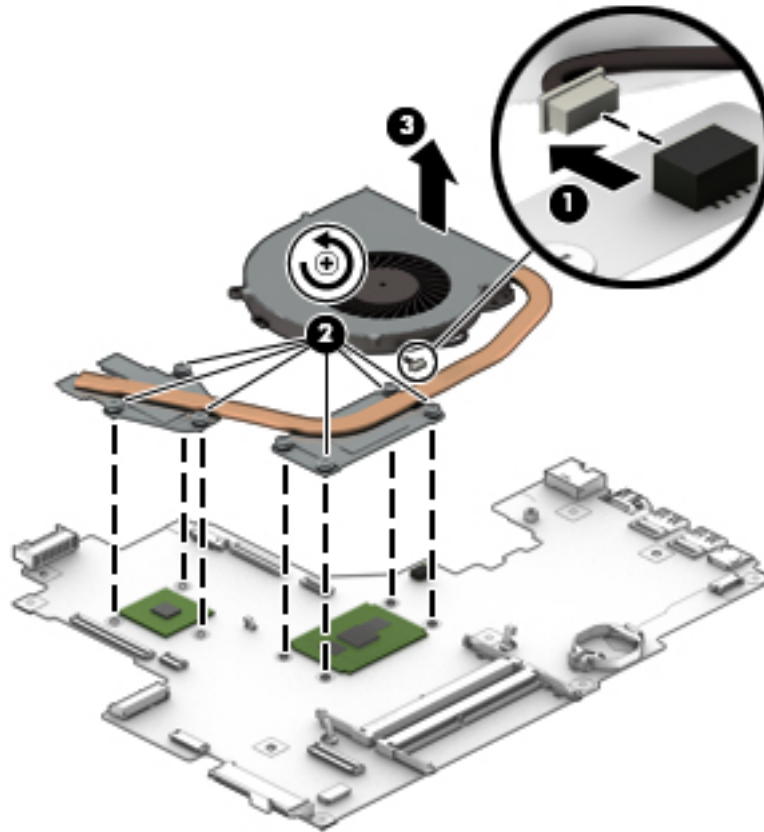

2. If you have a model with discrete graphics and no fan integrated in the heat sink:
- In the order indicated, remove the four Phillips PM2.0×3.0 screws **(1)** that secure the heat sink to the system board.
 - Remove the heat sink **(2)** from the system board.

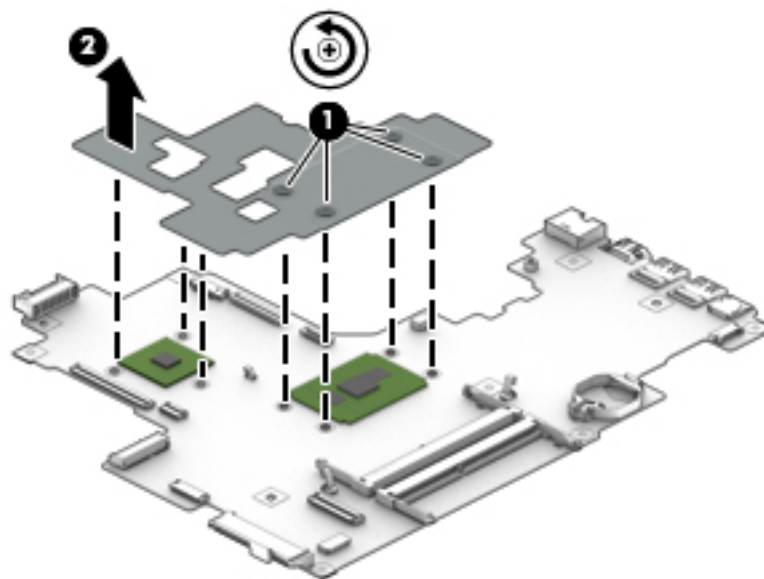

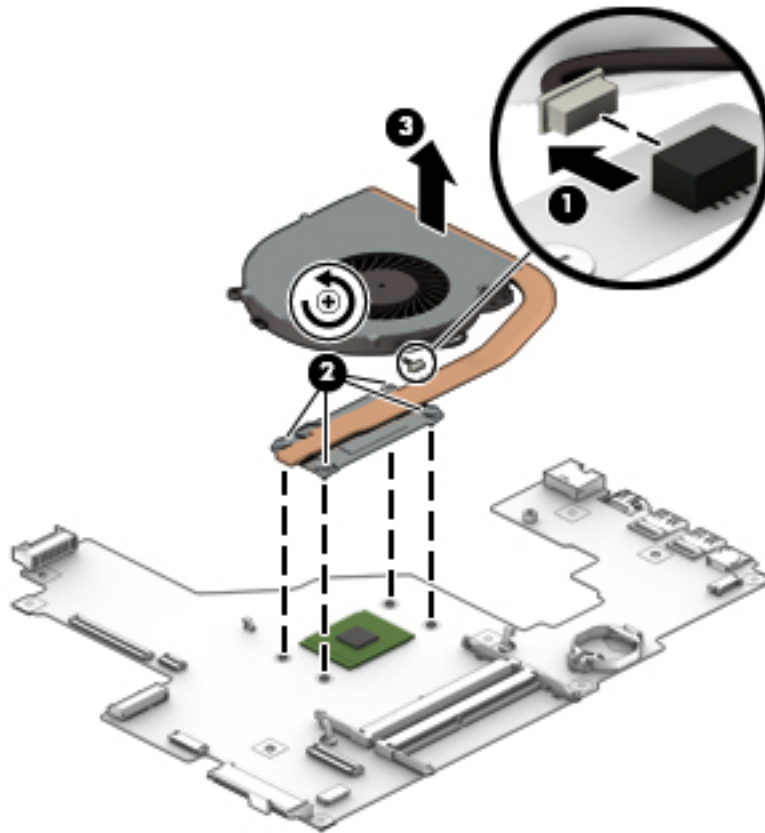

3. If you have a model with UMA graphics and a fan integrated in the heat sink:
 - a. Disconnect the fan cable from the system board **(1)**.
 - b. In the order indicated, remove the four Phillips PM2.0×3.0 screws **(2)** that secure the heat sink to the system board.
 - c. Remove the heat sink **(3)** from the system board.

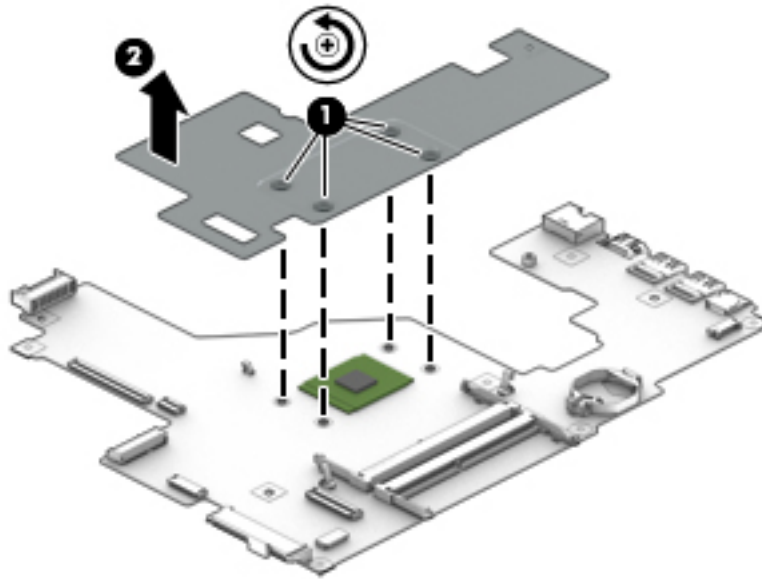

4. If you have a model with UMA graphics and no fan integrated in the heat sink:
 - a. In the order indicated, remove the four Phillips PM2.0×3.0 screws **(1)** that secure the heat sink to the system board.

- b. Remove the heat sink **(2)** from the system board.



 **NOTE:** The thermal material must be thoroughly cleaned from the surfaces of the heat sink and the system board components each time the heat sink is removed. Replacement thermal material is included with the heat sink, processor, and system board spare part kits.

The following illustrations show the replacement thermal material locations.

- **Discrete graphics with fan:** Thermal paste is used on the processor **(1)** and associated heat sink area **(2)**, as well as the graphics chip **(3)** and associated heat sink area **(4)**.

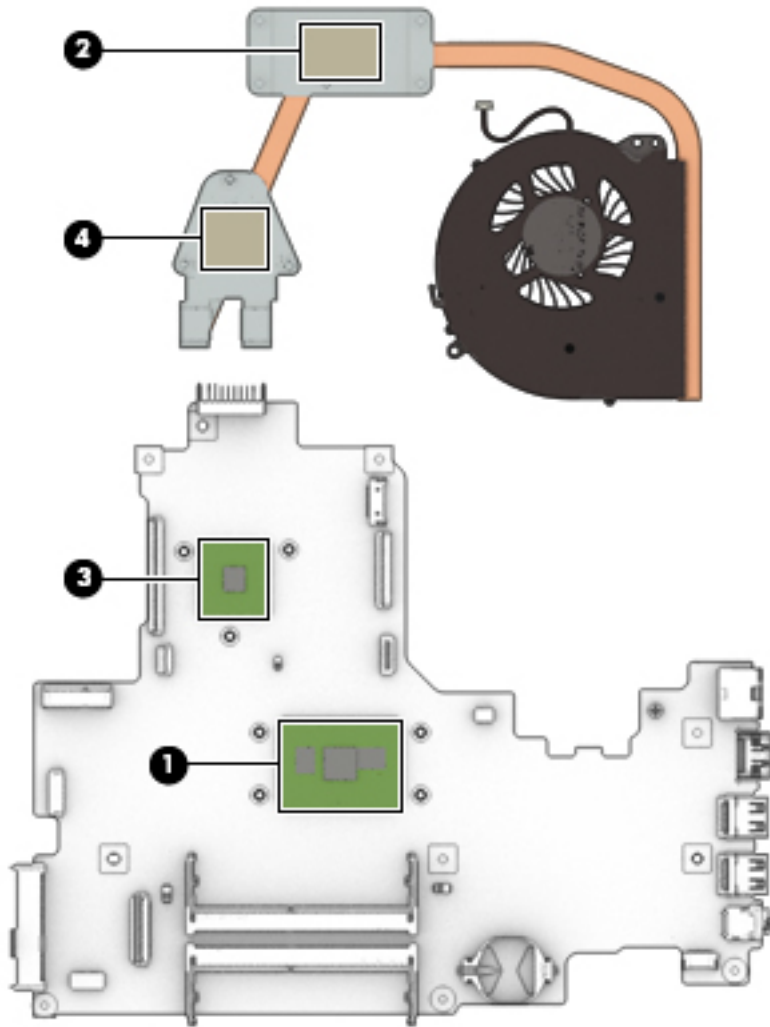

- **Discrete graphics without fan:** Thermal paste is used on the processor (1) and associated heat sink area (2), as well as the graphics chip (3) and associated heat sink area (4).

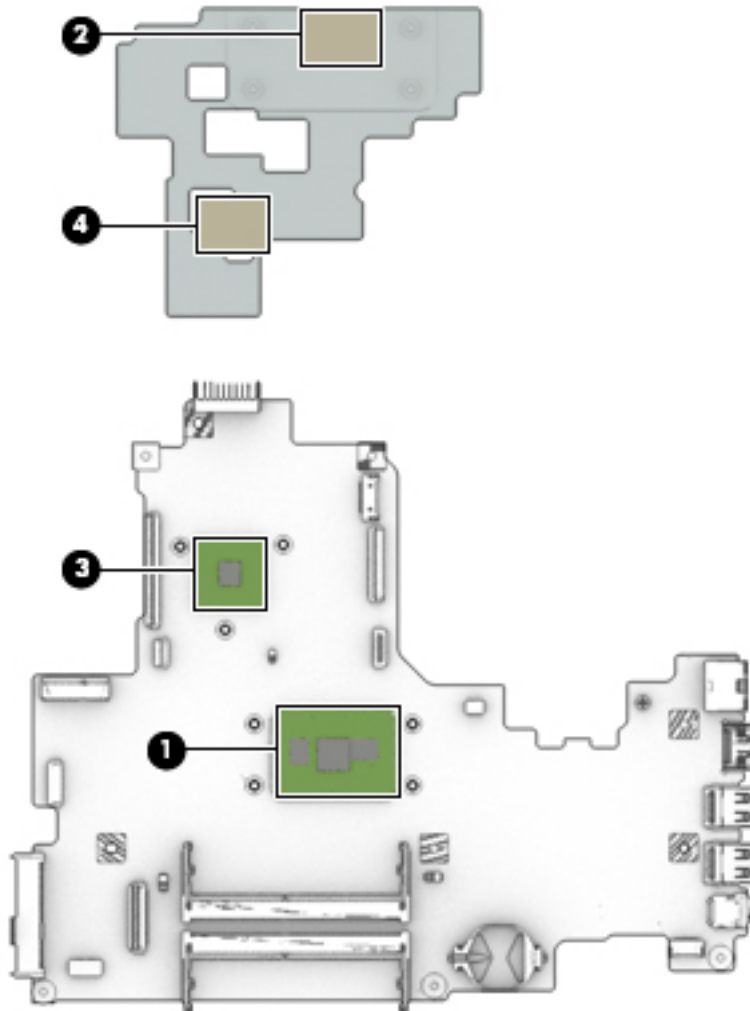

- **UMA graphics with fan:** Thermal paste is used on the processor **(1)** and associated heat sink area **(2)**.

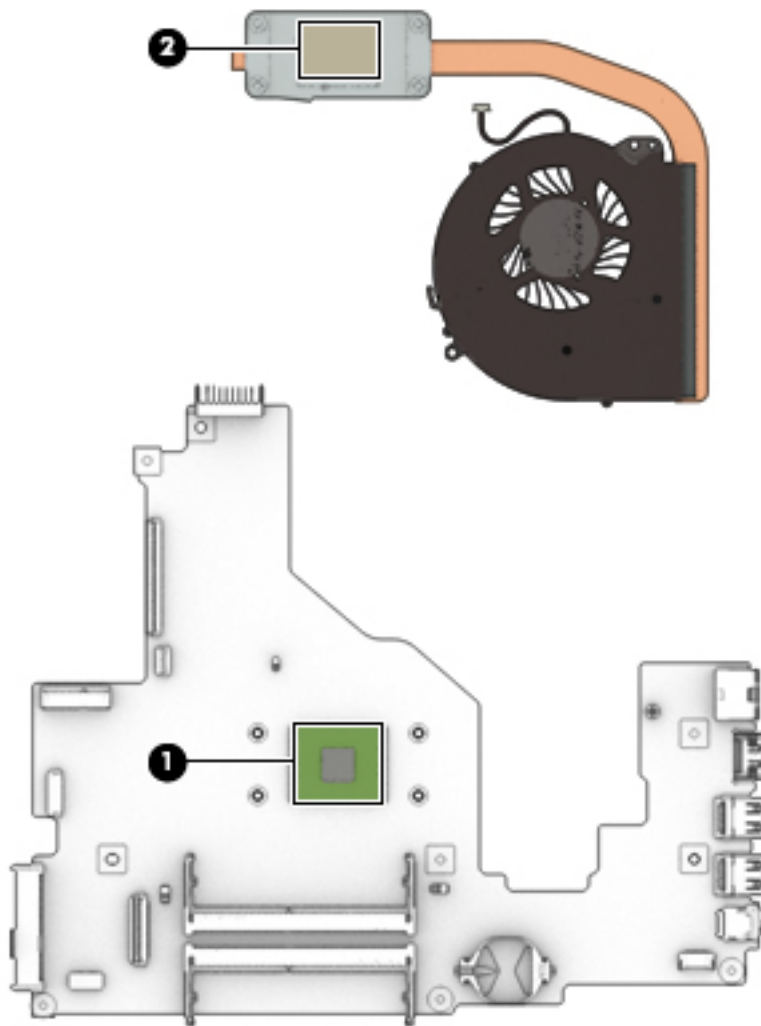

- **UMA graphics without fan:** Thermal paste is used on the processor (1) and associated heat sink area (2).

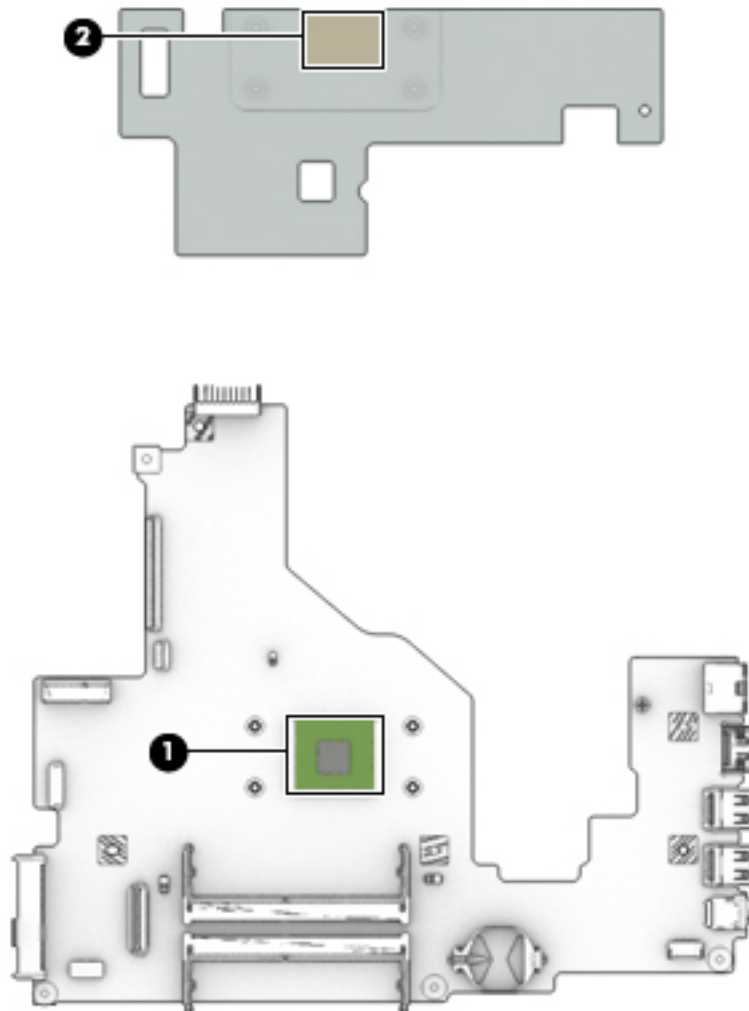

Reverse this procedure to reassemble and install the heat sink assembly.

System board

 **NOTE:** The system board spare part kit includes replacement thermal materials.

Description	Spare part number
System board (includes replacement thermal materials):	
All system boards use the following part numbers:	
xxxxxx-001: Windows 7 or non-Windows operating system	
xxxxxx-601: Windows 10	
For use in models with discrete graphics:	
<ul style="list-style-type: none">Intel Core i7-6500U processor and 4 GB of dedicated video memory (R7M1-70)	856691-xxx
<ul style="list-style-type: none">Intel Core i7-6500U processor and 2 GB of dedicated video memory (R5M1-30)	856689-xxx
<ul style="list-style-type: none">Intel Core i5-6200U processor and 2 GB of dedicated video memory (R7M1-70)	856686-xxx
<ul style="list-style-type: none">Intel Core i5-6200U processor and 2 GB of dedicated video memory (R5M1-30)	856685-xxx
<ul style="list-style-type: none">Intel Core i3-5005U processor and 2 GB of dedicated video memory (R5M1-30)	856693-xxx
<ul style="list-style-type: none">Intel Pentium N3710 processor and 2 GB of dedicated video memory (R5M1-30)	856696-xxx
For use in models with UMA graphics:	
<ul style="list-style-type: none">Intel Core i7-6500U processor	856688-xxx
<ul style="list-style-type: none">Intel Core i5-6200U processor	856684-xxx
<ul style="list-style-type: none">Intel Core i3-6100U processor	856683-xxx
<ul style="list-style-type: none">Intel Core i3-5005U processor	856692-xxx
<ul style="list-style-type: none">Intel Pentium N3710 processor	856694-xxx
<ul style="list-style-type: none">Intel Celeron N3060 processor	856695-xxx

Before removing the system board, follow these steps:

1. Shut down the computer. If you are unsure whether the computer is off or in Hibernation, turn the computer on, and then shut it down through the operating system.
2. Disconnect all external devices connected to the computer.
3. Disconnect the power from the computer by first unplugging the power cord from the AC outlet and then unplugging the AC adapter from the computer.
4. Remove the battery (see [Battery on page 32](#)).
5. Remove the optical drive (see [Optical drive on page 33](#)).
6. Remove the bottom cover (see [Bottom cover on page 39](#)).

 **NOTE:** When replacing the system board, be sure that the following components are removed from the defective system board and installed on the replacement system board:

- Memory modules (see [Memory module on page 47](#))
- WLAN module (see [WLAN module on page 44](#))

- Fan/heat sink assembly (see [Fan/heat sink assembly on page 56](#))
- Solid-state drive (if installed) (see [Solid-state drive on page 49](#))

To remove the system board:

1. Position the computer upright, and then disconnect the following cables from the system board:

(1): Keyboard cable

(2): Keyboard backlight cable

(3): Optical drive connector cable

(4): USB board cable

(5): TouchPad cable

(6): Power connector cable

(7): Display cable

(8): Power button board

(9): Speaker cable

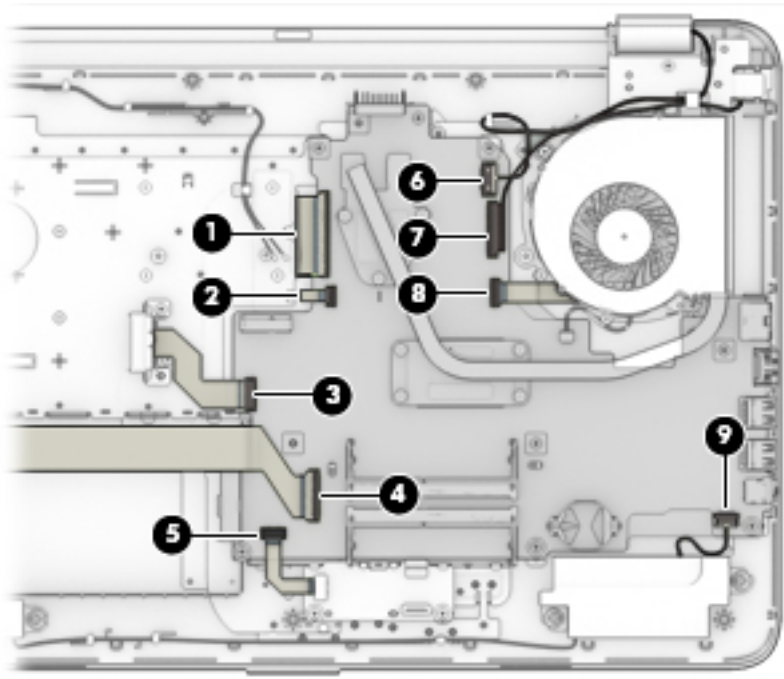

2. Remove the Phillips PM2.0×3.0 screw **(1)** that secures the system board to the computer.
3. Remove the eight Phillips PM2.5×7.0 screws **(2)** that secure the system board to the computer.

4. Lift the system board out of the computer **(3)**.

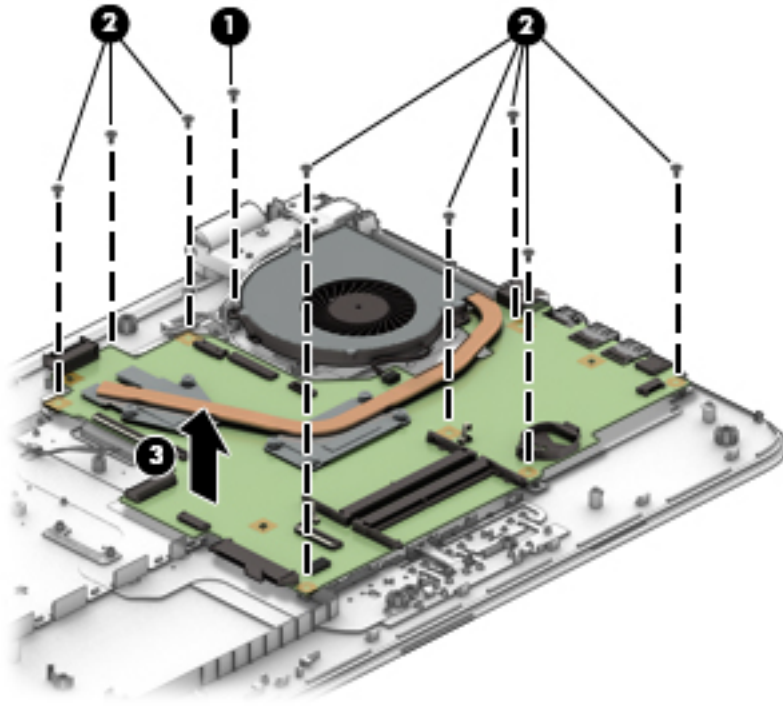

Reverse this procedure to install the system board.

Display assembly

Description	Spare part number
Raw display panel (43.9-cm [17.3-in]; includes screw covers)	
FHD, anti glare	798926-007
FHD, Touch On Panel (TOP)	851048-001
HD, Touch On Panel (TOP)	851049-001
HD+, BrightView	851051-002
Display bezel	856597-001
Display cable	
Non-touch displays	856607-001
Touch displays	856608-001
Display enclosure for use in non-touch models	
Red models	856594-001
White silver models	856593-001
Blue models	856596-001
Turbo silver models	856592-001
Black models	856591-001
Teal models	856595-001
Purple models	900660-001
Display enclosure for use in touch models	
Red models	856588-001
White silver models	856587-001
Blue models	856590-001
Turbo silver models	856586-001
Black models	856585-001
Teal models	856589-001
Purple models	900659-001
Hinges (left and right)	856599-001
Webcam/microphone module	
HD	709372-032
VGA	766523-021
Touch control board	856600-001

Before removing the display assembly, follow these steps:

1. Shut down the computer. If you are unsure whether the computer is off or in Hibernation, turn the computer on, and then shut it down through the operating system.
2. Disconnect all external devices connected to the computer.
3. Disconnect the power from the computer by first unplugging the power cord from the AC outlet and then unplugging the AC adapter from the computer.
4. Remove the battery (see [Battery on page 32](#)).
5. Remove the optical drive (see [Optical drive on page 33](#)).
6. Remove the bottom cover (see [Bottom cover on page 39](#)).
7. Remove the fan/heat sink (see [Fan/heat sink assembly on page 56](#)).

To remove the display assembly:

1. Position the computer with the display open and hanging down off the edge of a table.
2. Disconnect the display cable from the system board **(1)**.
3. Disconnect the wireless antenna cables from the WLAN module **(2)**.
4. Remove the two Phillips PM2.5×7.0 screws **(3)** that secure the display assembly to the computer.
5. Remove the three Phillips broadhead PM2.0×2.0 screws **(4)** that secure the display assembly to the computer.
6. Open the display to rotate the hinges upward to an angle **(5)**.

7. Separate the display assembly from the computer **(6)**.

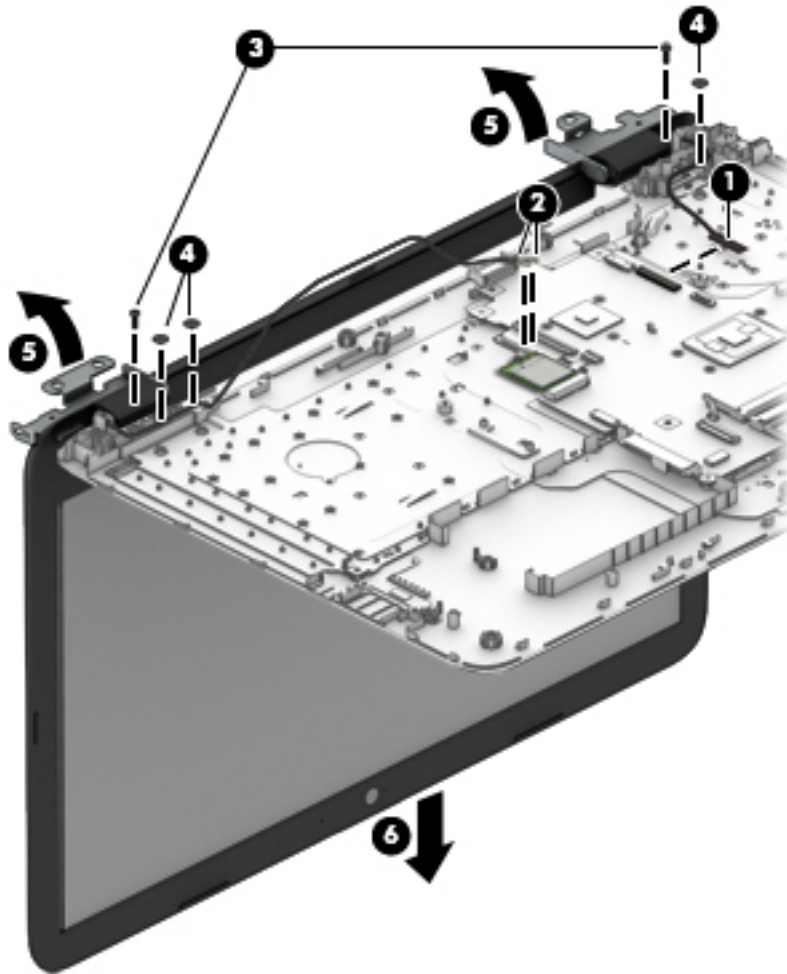

If it is necessary to replace any of the display assembly subcomponents:

1. Flex the inside of the top edge **(1)**, left and right sides **(2)**, and the inside of the bottom edge **(3)** of the display bezel until the bezel disengages from the display enclosure.

2. Remove the display bezel (4).

 **NOTE:** In this procedure the display will not be connected to the computer as shown in the following image.

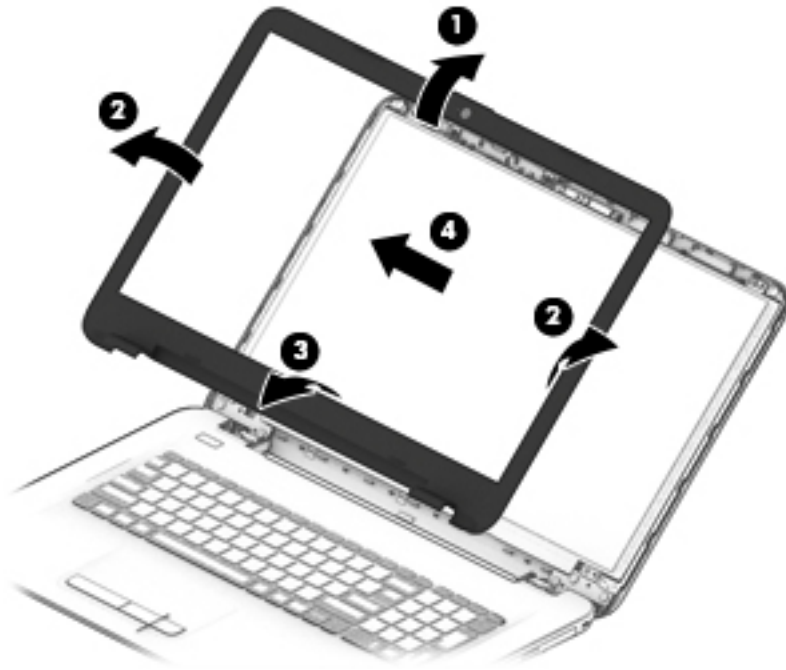

3. To remove the webcam/microphone module:

- a. Position the display assembly with the top edge toward you.
- b. Lift to disengage the adhesive that secures the webcam/microphone module to the display (1).
- c. Disconnect the cable (2) from the module.
- d. Remove the module (3).

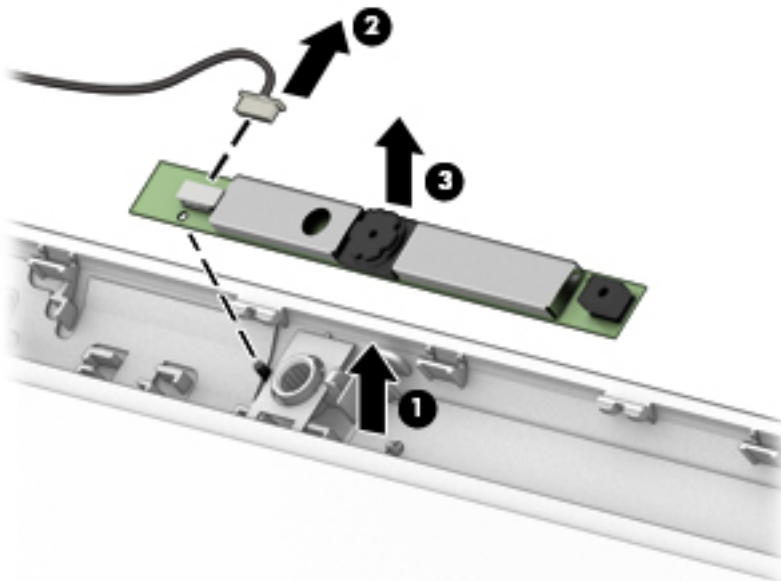

4. To remove the display panel:

- a. Remove the four Phillips PM2.0×3.0 screws **(1)** that secure the display panel to the enclosure.
- b. Rotate the display panel onto the keyboard **(2)** to gain access to the display cable connection on the back of the panel.



NOTE: In this procedure the display will not be connected to the computer as shown in the following image.

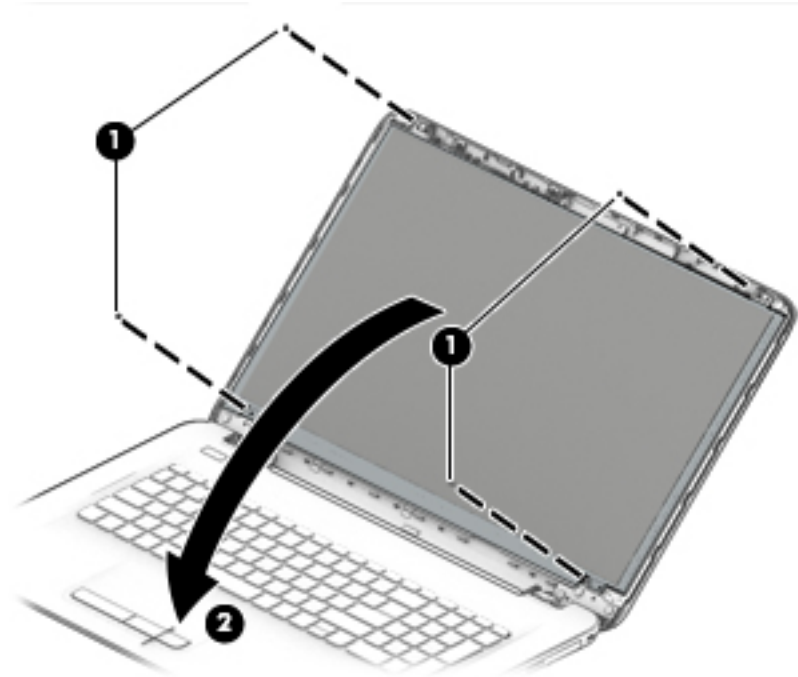

- c. On the back of the display panel, release the adhesive strip that secures the display panel cable to the display panel, and then disconnect the cable **(1)**.

- d. Remove the display panel from the computer **(2)**.

 **NOTE:** In this procedure the display will not be connected to the computer as shown in the following image.

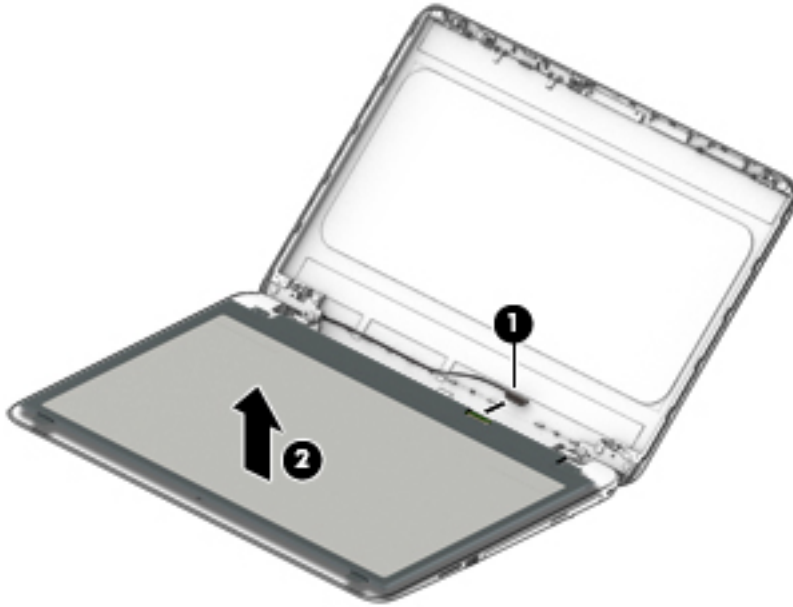

5. To remove the touch control board from the display:
- Remove the two Phillips PM2.0×2.0 screws **(1)** that secure the touch control board to the top of the display assembly.
 - Rotate the board upside down to access the connectors underneath **(2)**.

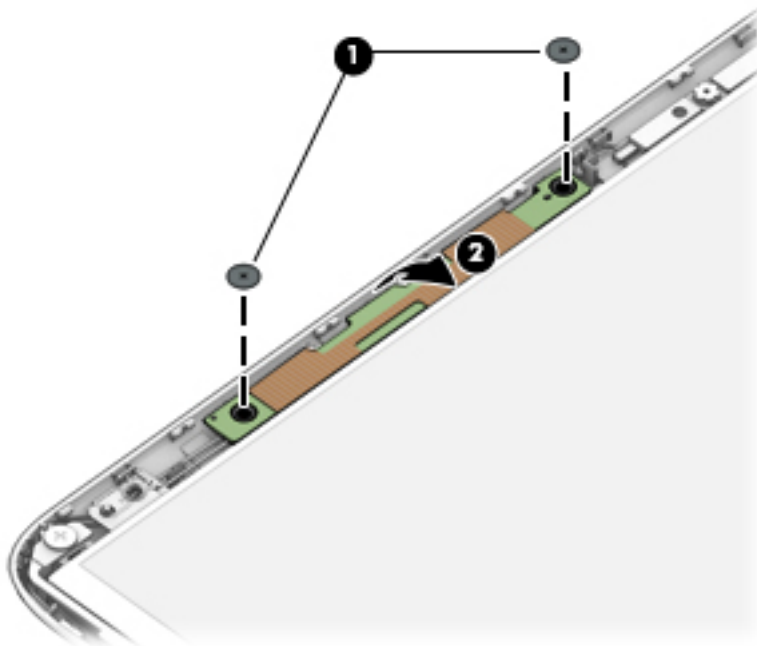

- c. Disconnect the cable from the end of the board **(1)**.

- d. Disconnect the two larger cables from the board **(2)**.
- e. Remove the touch control board from the display assembly **(3)**.

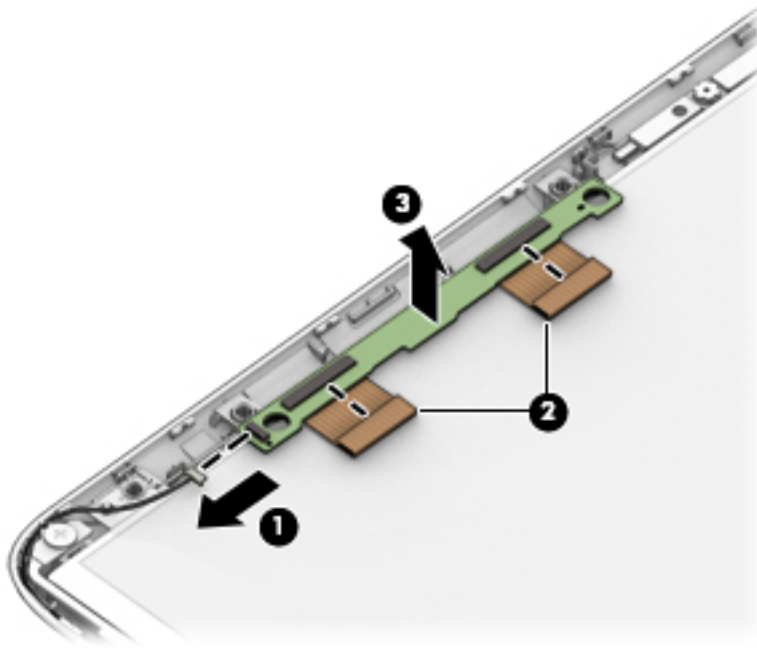

- 6. To remove the display hinges:
 - a. Remove the three Phillips broadhead PM2.5×3.0 screws **(1)** from the bottom of each hinge and the Phillips broadhead PM2.5×3.0 screw **(2)** from the top of each hinge.

- b. Remove the display hinges from the panel (3).

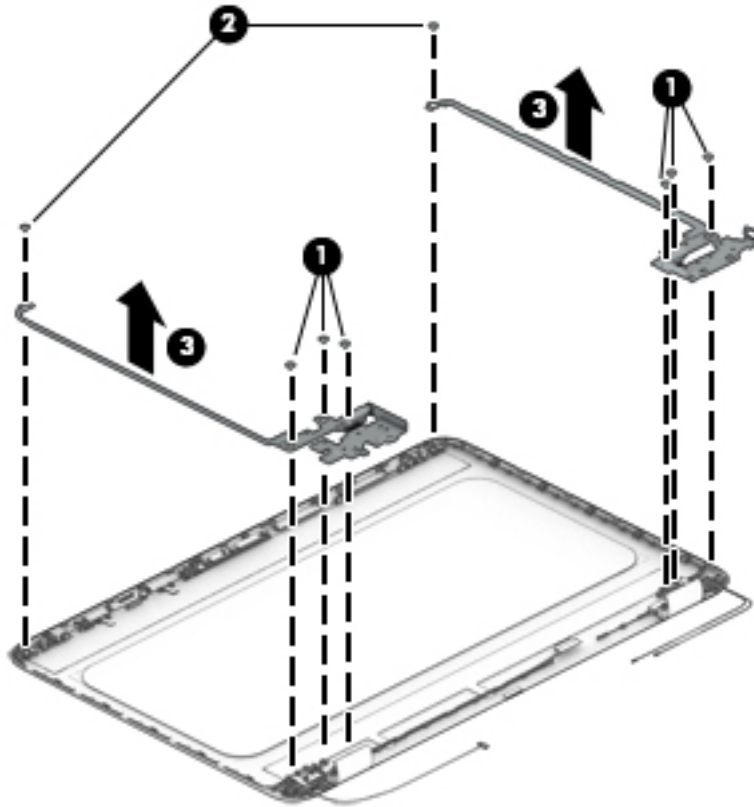

7. To remove the wireless antenna cables and transceivers, release the wireless antenna cables from the clips (1) built into the back of the display, peel off the transceivers (2), and then remove the antenna cables and transceivers (3).

 **NOTE:** Number of antennas and transceivers may vary.

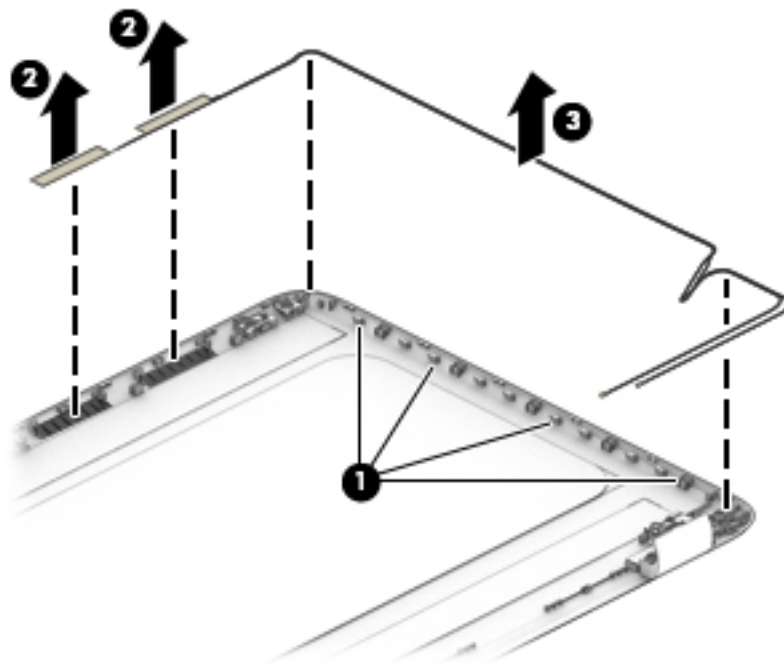

8. To remove the display/webcam cable, remove the cable from the clips built into the display panel **(1)**, and then remove the cable from the display **(2)**.

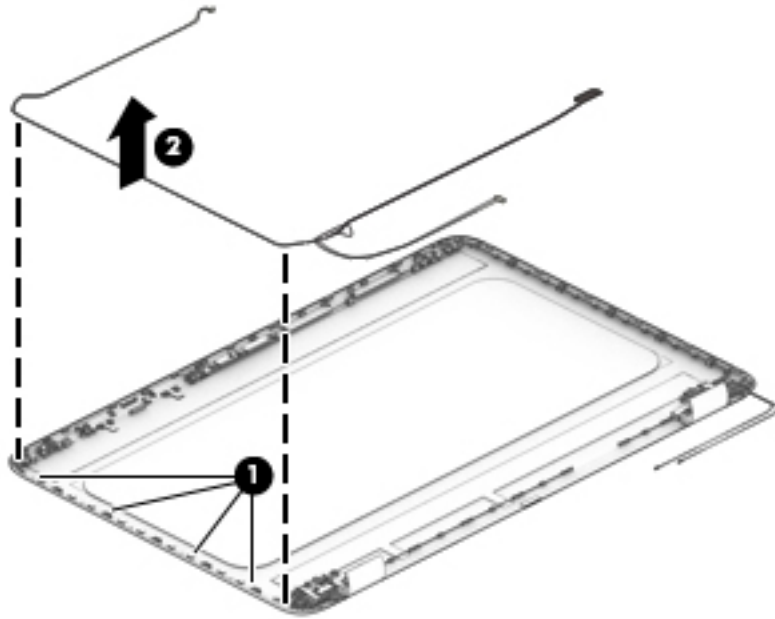

9. If replacing the display enclosure, be sure that the subcomponents (including the webcam/microphone module, the antenna receivers, and all associated cables and hardware) are transferred to the new enclosure.

Reverse this procedure to reassemble and install the display assembly.

When reassembling and reinstalling the display assembly, note the routing of the antenna cable **(1)** and display/webcam cable **(2)** as shown in the following image.

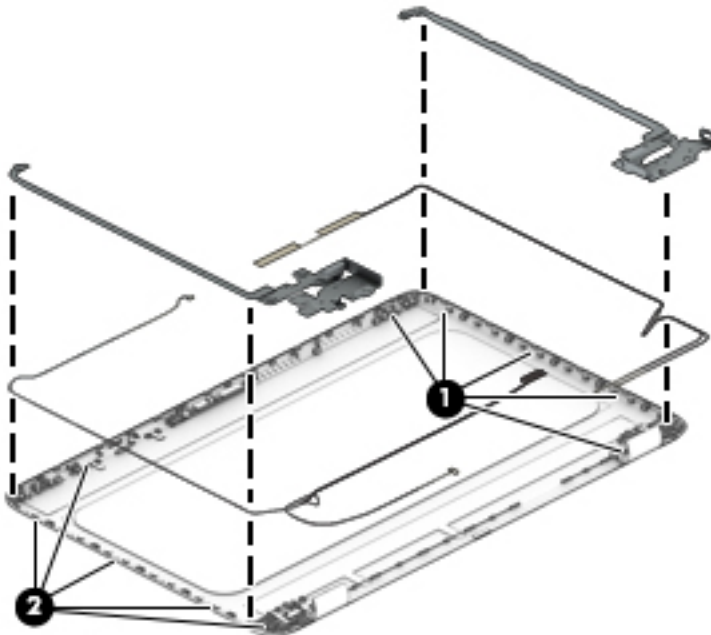

Power button board

Description	Spare part number
Power button board	856612-001
Power button board cable	856604-001

Before removing the power button board, follow these steps:

1. Shut down the computer. If you are unsure whether the computer is off or in Hibernation, turn the computer on, and then shut it down through the operating system.
2. Disconnect all external devices connected to the computer.
3. Disconnect the power from the computer by first unplugging the power cord from the AC outlet and then unplugging the AC adapter from the computer.
4. Remove the battery (see [Battery on page 32](#)).
5. Remove the optical drive (see [Optical drive on page 33](#)).
6. Remove the bottom cover (see [Bottom cover on page 39](#)).
7. Remove the fan/heat sink (see [Fan/heat sink assembly on page 56](#)).
8. Remove the display (see [Display assembly on page 67](#)).

To remove the power button board:

1. Disconnect the cable from the power button board **(1)**.
2. Remove the Phillips PM2.0×4.0 screw **(2)** that secures the power button board to the computer.
3. Remove the power button board from the computer **(3)**.

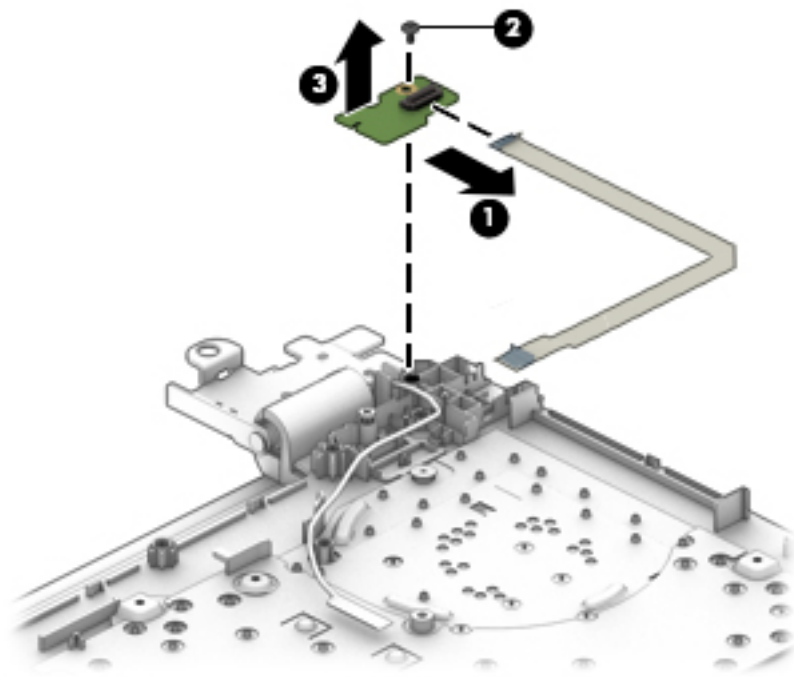

Reverse this procedure to install the power button board.

Power connector

Description	Spare part number
Power connector cable	856680-001

Before removing the power connector cable, follow these steps:

1. Shut down the computer. If you are unsure whether the computer is off or in Hibernation, turn the computer on, and then shut it down through the operating system.
2. Disconnect all external devices connected to the computer.
3. Disconnect the power from the computer by first unplugging the power cord from the AC outlet and then unplugging the AC adapter from the computer.
4. Remove the battery (see [Battery on page 32](#)).
5. Remove the optical drive (see [Optical drive on page 33](#)).
6. Remove the bottom cover (see [Bottom cover on page 39](#)).
7. Remove the fan/heat sink (see [Fan/heat sink assembly on page 56](#)).
8. Remove the display (see [Display assembly on page 67](#)).

To remove the power connector cable:

1. Pull the tabs away from the connector **(1)**.
2. Remove the power connector **(2)** from the computer.

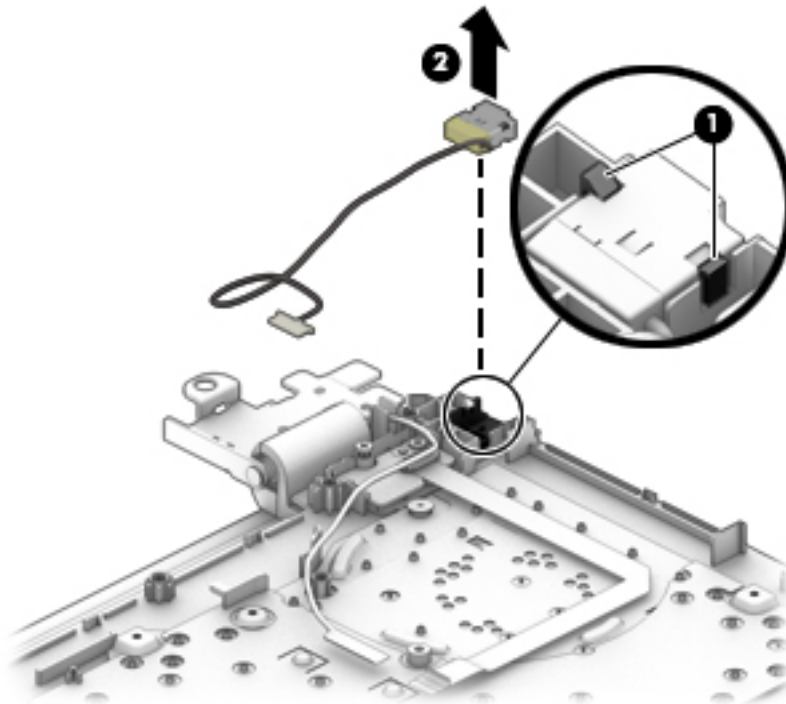

Reverse this procedure to install the power connector cable.

Cable locations

Description	Spare part number
Power button board cable	856604-001
Optical drive cable	856609-001
USB board cable	856603-001
TouchPad cable	856605-001
Touch click board cable	856606-001

Use the following image to determine proper cable routing in the computer.

- (1) Power button board cable
- (2) Optical drive cable
- (3) USB board cable
- (4) TouchPad cable
- (5) TouchPad click board cable

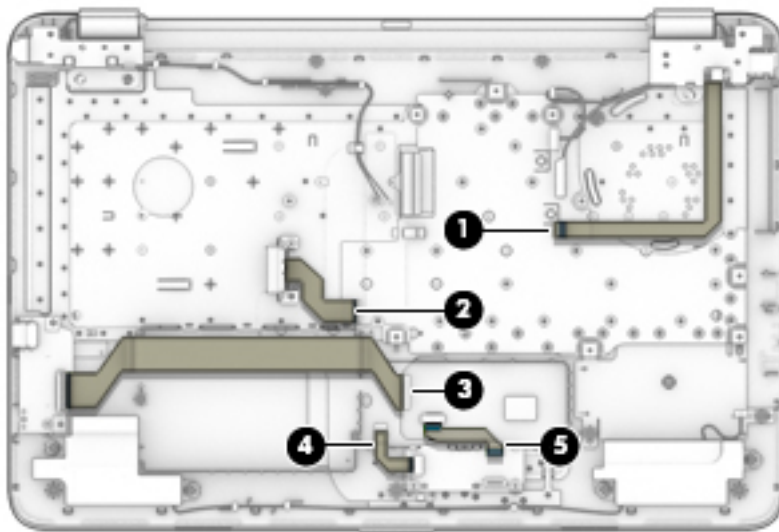

Top cover/keyboard

In this section, the first table provides the main spare part number for the keyboard. The second table provides the country codes.



NOTE: All top cover/keyboard spare part kits include TouchPad.

Description	Spare part number
Models without a backlit keyboard:	
• Black	856698-xx1
• Turbo silver	856699-xx1
• White silver	856700-xx1
• Red	856757-xx1
• Teal	856758-xx1
• Blue	856759-xx1
• Purple	900153-xx1
Models with a backlit keyboard:	
• Black	856771-xx1
• Turbo silver	856772-xx1
• White silver	856773-xx1
• Red	856775-xx1
• Teal	856776-xx1
• Blue	856777-xx1
• Purple	900154-xx1

For use in country or region	Spare part number	For use in country or region	Spare part number	For use in country or region	Spare part number
Belgium	-A41	Greece	-151	Saudi Arabia	-171
Bulgaria	-261	Hungary	-211	Slovenia	-BA1
Canada	-DB1	Israel	-BB1	South Korea	-AD1
Czech Republic and Slovakia	-FL1	The Netherlands	-B31	Spain	-071
Denmark, Finland, and Norway	-DH1	Portugal	-131	Switzerland	-BG1
France	-051	Romania	-271	United Kingdom	-031
Germany	-041	Russia	-251	United States	-001

The top cover/keyboard spare part kit includes the keyboard, keyboard cable and the keyboard backlight cable.

The top cover/keyboard spare part remains after all other spare parts have been removed.

7 Using Setup Utility (BIOS) in Windows 10

Setup Utility, or Basic Input/Output System (BIOS), controls communication between all the input and output devices on the system (such as disk drives, display, keyboard, mouse, and printer). Setup Utility (BIOS) includes settings for the types of devices installed, the startup sequence of the computer, and the amount of system and extended memory.

 **NOTE:** To start Setup Utility on convertible computers, your computer must be in notebook mode and you must use the keyboard attached to your notebook.

Starting Setup Utility (BIOS)

 **CAUTION:** Use extreme care when making changes in Setup Utility (BIOS). Errors can prevent the computer from operating properly.

- ▲ Turn on or restart the computer, quickly press **esc**, and then press **f10**.

Updating Setup Utility (BIOS)

Updated versions of Setup Utility (BIOS) may be available on the HP website.

Most BIOS updates on the HP website are packaged in compressed files called *SoftPaqs*.

Some download packages contain a file named *Readme.txt*, which contains information regarding installing and troubleshooting the file.

Determining the BIOS version

To decide whether you need to update Setup Utility (BIOS), first determine the BIOS version on your computer.

To reveal the BIOS version information (also known as *ROM date* and *System BIOS*), use one of these options.

- HP Support Assistant
 1. Type `support` in the taskbar search box, and then select the **HP Support Assistant** app.
– or –
Click the question mark icon in the taskbar.
 2. Select **My PC**, and then select **Specifications**.
- Setup Utility (BIOS)
 1. Start Setup Utility (BIOS) (see [Starting Setup Utility \(BIOS\) on page 81](#)).
 2. Select **Main**, select **System Information**, and then make note of the BIOS version.
 3. Select **Exit**, select **No**, and then follow the on-screen instructions.

To check for later BIOS versions, see [Downloading a BIOS update on page 82](#).

Downloading a BIOS update

 **CAUTION:** To reduce the risk of damage to the computer or an unsuccessful installation, download and install a BIOS update only when the computer is connected to reliable external power using the AC adapter. Do not download or install a BIOS update while the computer is running on battery power, docked in an optional docking device, or connected to an optional power source. During the download and installation, follow these instructions:

- Do not disconnect power from the computer by unplugging the power cord from the AC outlet.
- Do not shut down the computer or initiate Sleep.
- Do not insert, remove, connect, or disconnect any device, cable, or cord.

 **NOTE:** If your computer is connected to a network, consult the network administrator before installing any software updates, especially system BIOS updates.

1. Type `support` in the taskbar search box, and then select the **HP Support Assistant** app.
– or –
Click the question mark icon in the taskbar.
2. Click **Updates**, and then click **Check for updates and messages**.
3. Follow the on-screen instructions.
4. At the download area, follow these steps:
 - a. Identify the most recent BIOS update and compare it to the BIOS version currently installed on your computer. If the update is more recent than your BIOS version, make a note of the date, name, or other identifier. You may need this information to locate the update later, after it has been downloaded to your hard drive.
 - b. Follow the on-screen instructions to download your selection to the hard drive.

Make a note of the path to the location on your hard drive where the BIOS update is downloaded. You will need to access this path when you are ready to install the update.

BIOS installation procedures vary. Follow any instructions that appear on the screen after the download is complete. If no instructions appear, follow these steps:

1. Type `file` in the taskbar search box, and then select **File Explorer**.
2. Click your hard drive designation. The hard drive designation is typically Local Disk (C:).
3. Using the hard drive path you recorded earlier, open the folder that contains the update.
4. Double-click the file that has an `.exe` extension (for example, `filename.exe`).

The BIOS installation begins.
5. Complete the installation by following the on-screen instructions.

 **NOTE:** After a message on the screen reports a successful installation, you can delete the downloaded file from your hard drive.

8 Backing up, restoring, and recovering in Windows 10

This chapter provides information about the following processes. The information in the chapter is standard procedure for most products.

- Creating recovery media and backups
- Restoring and recovering your system

For additional information, refer to the HP support assistant app.

- ▲ Type `support` in the taskbar search box, and then select the **HP Support Assistant** app.

– or –

Click the question mark icon in the taskbar.

 **IMPORTANT:** If you will be performing recovery procedures on a tablet, the tablet battery must be at least 70% charged before you start the recovery process.

IMPORTANT: For a tablet with a detachable keyboard, connect the keyboard to the keyboard dock before beginning any recovery process.

Creating recovery media and backups

The following methods of creating recovery media and backups are available on select products only. Choose the available method according to your computer model.

- Use HP Recovery Manager to create HP Recovery media after you successfully set up the computer. This step creates a backup of the HP Recovery partition on the computer. The backup can be used to reinstall the original operating system in cases where the hard drive is corrupted or has been replaced. For information on creating recovery media, see [Creating HP Recovery media \(select products only\) on page 83](#). For information on the recovery options that are available using the recovery media, see [Using Windows tools on page 84](#).

- Use Windows tools to create system restore points and create backups of personal information.

For more information, see [Recovering using HP Recovery Manager on page 85](#).

 **NOTE:** If storage is 32 GB or less, Microsoft System Restore is disabled by default.

Creating HP Recovery media (select products only)

If possible, check for the presence of the Recovery partition and the Windows partition. From the **Start** menu, select **File Explorer**, and then select **This PC**.

- If your computer does not list the Windows partition and the Recovery partition, you can obtain recovery media for your system from support. See the *Worldwide Telephone Numbers* booklet included with the computer. You can also find contact information on the HP website. Go to <http://www.hp.com/support>, select your country or region, and follow the on-screen instructions.

You can use Windows tools to create system restore points and create backups of personal information, see [Using Windows tools on page 84](#).

- If your computer does list the Recovery partition and the Windows partition, you can use HP Recovery Manager to create recovery media after you successfully set up the computer. HP Recovery media can be used to perform system recovery if the hard drive becomes corrupted. System recovery reinstalls the original operating system and software programs that were installed at the factory and then configures the settings for the programs. HP Recovery media can also be used to customize the system or restore the factory image if you replace the hard drive.
 - Only one set of recovery media can be created. Handle these recovery tools carefully, and keep them in a safe place.
 - HP Recovery Manager examines the computer and determines the required storage capacity for the media that will be required.
 - To create recovery discs, your computer must have an optical drive with DVD writer capability, and you must use only high-quality blank DVD-R, DVD+R, DVD-R DL, or DVD+R DL discs. Do not use rewritable discs such as CD±RW, DVD±RW, double-layer DVD±RW, or BD-RE (rewritable Blu-ray) discs; they are not compatible with HP Recovery Manager software. Or, instead, you can use a high-quality blank USB flash drive.
 - If your computer does not include an integrated optical drive with DVD writer capability, but you would like to create DVD recovery media, you can use an external optical drive (purchased separately) to create recovery discs. If you use an external optical drive, it must be connected directly to a USB port on the computer; the drive cannot be connected to a USB port on an external device, such as a USB hub. If you cannot create DVD media yourself, you can obtain recovery discs for your computer from HP. See the *Worldwide Telephone Numbers* booklet included with the computer. You can also find contact information on the HP website. Go to <http://www.hp.com/support>, select your country or region, and follow the on-screen instructions.
 - Be sure that the computer is connected to AC power before you begin creating the recovery media.
 - The creation process can take an hour or more. Do not interrupt the creation process.
 - If necessary, you can exit the program before you have finished creating all of the recovery DVDs. HP Recovery Manager will finish burning the current DVD. The next time you start HP Recovery Manager, you will be prompted to continue.

To create HP Recovery media:



IMPORTANT: For a tablet with a detachable keyboard, connect the keyboard to the keyboard dock before beginning these steps.

1. Type `recovery` in the taskbar search box, and then select **HP Recovery Manager**.
2. Select **Create recovery media**, and then follow the on-screen instructions.

If you ever need to recover the system, see [Recovering using HP Recovery Manager on page 85](#).

Using Windows tools

You can create recovery media, system restore points, and backups of personal information using Windows tools.



NOTE: If storage is 32 GB or less, Microsoft System Restore is disabled by default.

For more information and steps, see the Get started app.

- ▲ Select the **Start** button, and then select the **Get started** app.

Restore and recovery

There are several options for recovering your system. Choose the method that best matches your situation and level of expertise:

 **IMPORTANT:** Not all methods are available on all products.

- Windows offers several options for restoring from backup, refreshing the computer, and resetting the computer to its original state. For more information see the Get started app.
 - ▲ Select the **Start** button, and then select the **Get started** app.
- If you need to correct a problem with a preinstalled application or driver, use the Reinstall drivers and/or applications option (select products only) of HP Recovery Manager to reinstall the individual application or driver.
 - ▲ Type `recovery` in the taskbar search box, select **HP Recovery Manager**, select **Reinstall drivers and/or applications**, and then follow the on-screen instructions.
- If you want to recover the Windows partition to original factory content, you can choose the System Recovery option from the HP Recovery partition (select products only) or use the HP Recovery media. For more information, see [Recovering using HP Recovery Manager on page 85](#). If you have not already created recovery media, see [Creating HP Recovery media \(select products only\) on page 83](#).
- On select products, if you want to recover the computer's original factory partition and content, or if you have replaced the hard drive, you can use the Factory Reset option of HP Recovery media. For more information, see [Recovering using HP Recovery Manager on page 85](#).
- On select products, if you want to remove the recovery partition to reclaim hard drive space, HP Recovery Manager offers the Remove Recovery Partition option.

For more information, see [Removing the HP Recovery partition \(select products only\) on page 87](#).

Recovering using HP Recovery Manager

HP Recovery Manager software allows you to recover the computer to its original factory state by using the HP Recovery media that you either created or that you obtained from HP, or by using the HP Recovery partition (select products only). If you have not already created recovery media, see [Creating HP Recovery media \(select products only\) on page 83](#).

What you need to know before you get started

- HP Recovery Manager recovers only software that was installed at the factory. For software not provided with this computer, you must either download the software from the manufacturer's website or reinstall the software from the media provided by the manufacturer.

 **IMPORTANT:** Recovery through HP Recovery Manager should be used as a final attempt to correct computer issues.

- HP Recovery media must be used if the computer hard drive fails. If you have not already created recovery media, see [Creating HP Recovery media \(select products only\) on page 83](#).
- To use the Factory Reset option (select products only), you must use HP Recovery media. If you have not already created recovery media, see [Creating HP Recovery media \(select products only\) on page 83](#).
- If your computer does not allow the creation of HP Recovery media or if the HP Recovery media does not work, you can obtain recovery media for your system from support. See the *Worldwide Telephone Numbers* booklet included with the computer. You can also find contact information from the HP

website. Go to <http://www.hp.com/support>, select your country or region, and follow the on-screen instructions.

 **IMPORTANT:** HP Recovery Manager does not automatically provide backups of your personal data. Before beginning recovery, back up any personal data you want to retain.

Using HP Recovery media, you can choose from one of the following recovery options:

 **NOTE:** Only the options available for your computer display when you start the recovery process.

- System Recovery—Reinstalls the original operating system, and then configures the settings for the programs that were installed at the factory.
- Factory Reset—Restores the computer to its original factory state by deleting all information from the hard drive and re-creating the partitions. Then it reinstalls the operating system and the software that was installed at the factory.

The HP Recovery partition (select products only) allows System Recovery only.

Using the HP Recovery partition (select products only)

The HP Recovery partition allows you to perform a system recovery without the need for recovery discs or a recovery USB flash drive. This type of recovery can be used only if the hard drive is still working.

To start HP Recovery Manager from the HP Recovery partition:

 **IMPORTANT:** For a tablet with a detachable keyboard, connect the keyboard to the keyboard dock before beginning these steps (select products only).

1. Type `recovery` in the taskbar search box, select **Recovery Manager**, and then select **HP Recovery Environment**.

- or -

For computers or tablets with keyboards attached, press **f11** while the computer boots, or press and hold **f11** as you press the power button.

For tablets without keyboards:

Turn on or restart the tablet, and then quickly hold down the volume down button; then select **f11**.

- or -

Turn on or restart the tablet, and then quickly hold down the Windows button; then select **f11**.

2. Select **Troubleshoot** from the boot options menu.
3. Select **Recovery Manager**, and then follow the on-screen instructions.

Using HP Recovery media to recover

You can use HP Recovery media to recover the original system. This method can be used if your system does not have an HP Recovery partition or if the hard drive is not working properly.

1. If possible, back up all personal files.
2. Insert the HP Recovery media, and then restart the computer.

 **NOTE:** If the computer does not automatically restart in HP Recovery Manager, change the computer boot order. See [Changing the computer boot order on page 87](#).

3. Follow the on-screen instructions.

Changing the computer boot order

If your computer does not restart in HP Recovery Manager, you can change the computer boot order, which is the order of devices listed in BIOS where the computer looks for startup information. You can change the selection to an optical drive or a USB flash drive.

To change the boot order:

 **IMPORTANT:** For a tablet with a detachable keyboard, connect the keyboard to the keyboard dock before beginning these steps.

1. Insert the HP Recovery media.
2. Access BIOS:

For computers or tablets with keyboards attached:

- ▲ Turn on or restart the computer or tablet, quickly press **esc**, and then press **f9** for boot options.

For tablets without keyboards:

- ▲ Turn on or restart the tablet, and then quickly hold down the volume down button; then select **f9**.
- or -

Turn on or restart the tablet, and then quickly hold down the Windows button; then select **f9**.

3. Select the optical drive or USB flash drive from which you want to boot.
4. Follow the on-screen instructions.

Removing the HP Recovery partition (select products only)

HP Recovery Manager software allows you to remove the HP Recovery partition to free up hard drive space.

 **IMPORTANT:** After you remove the HP Recovery partition, you will not be able to perform System Recovery or create HP recovery media from the HP Recovery partition. So before you remove the Recovery partition, create HP Recovery media; see [Creating HP Recovery media \(select products only\) on page 83](#).

 **NOTE:** The Remove Recovery Partition option is only available on products that support this function.

Follow these steps to remove the HP Recovery partition:

1. Type `recovery` in the taskbar search box, and then select **HP Recovery Manager**.
2. Select **Remove Recovery Partition**, and then follow the on-screen instructions.

9 Using HP PC Hardware Diagnostics (UEFI)

HP PC Hardware Diagnostics is a Unified Extensible Firmware Interface (UEFI) that allows you to run diagnostic tests to determine whether the computer hardware is functioning properly. The tool runs outside the operating system so that it can isolate hardware failures from issues that are caused by the operating system or other software components.

When HP PC Hardware Diagnostics (UEFI) detects a failure that requires hardware replacement, a 24-digit Failure ID code is generated. This ID code can then be provided to support to help determine how to correct the problem.

 **NOTE:** To start diagnostics on a convertible computer, your computer must be in notebook mode and you must use the keyboard attached.

To start HP PC Hardware Diagnostics (UEFI), follow these steps:

1. Turn on or restart the computer, and quickly press **esc**.
2. Press **f2**.

The BIOS searches three places for the diagnostic tools, in the following order:

- a. Connected USB drive

 **NOTE:** To download the HP PC Hardware Diagnostics (UEFI) tool to a USB drive, see [Downloading HP PC Hardware Diagnostics \(UEFI\) to a USB device on page 89](#).

- b. Hard drive
 - c. BIOS
3. When the diagnostic tool opens, select the type of diagnostic test you want to run, and then follow the on-screen instructions.

 **NOTE:** If you need to stop a diagnostic test, press **esc**.

Downloading HP PC Hardware Diagnostics (UEFI) to a USB device

 **NOTE:** The HP PC Hardware Diagnostics (UEFI) download instructions are provided in English only, and you must use a Windows computer to download and create the HP UEFI support environment because only .exe files are offered.

There are two options to download HP PC Hardware Diagnostics to a USB device.

Download the latest UEFI version

1. Go to <http://www.hp.com/go/techcenter/pcdiags>. The HP PC Diagnostics home page is displayed.
2. In the HP PC Hardware Diagnostics section, select the **Download** link, and then select **Run**.

Download any version of UEFI for a specific product

1. Go to <http://www.hp.com/support>.
2. Select **Get software and drivers**.

3. Enter the product name or number.

– or –

Select **Identify now** to let HP automatically detect your product.

4. Select your computer, and then select your operating system.
5. In the **Diagnostic** section, follow the on-screen instructions to select and download the UEFI version you want.

10 Specifications

Computer specifications

	Metric	U.S.
Dimensions (touch models)		
Depth	261.1 mm	10.28 in
Width	384.5 mm	15.14 in
Height (rear)	25.15 mm	0.99 in
Weight		
Touch	2.499 kg	5.51 lb
Non-touch	2.299 kg	5.07 lb
Input power		
Operating voltage and current	19.5 V dc @ 2.31 A – 45 W 18.5 V dc @ 3.5 A or 19.5 V dc @ 3.33 A – 65 W	
Temperature		
Operating	5°C to 35°C	41°F to 95°F
Nonoperating	-20°C to 60°C	-4°F to 140°F
Relative humidity (noncondensing)		
Operating	10% to 90%	
Nonoperating	5% to 95%	
Maximum altitude (unpressurized)		
Operating	-15 m to 3,048 m	-50 ft to 10,000 ft
Nonoperating	-15 m to 12,192 m	-50 ft to 40,000 ft
NOTE: Applicable product safety standards specify thermal limits for plastic surfaces. The device operates well within this range of temperatures.		

43.9-cm (17.3-in) display specifications

	Metric	U.S.
Active diagonal size	43.9-cm	17.3-in
Thickness	6.0 mm or 4.0 mm	0.157 inch or 0.236 inch
Resolution	1920x1080 (FHD) 1920x1080 (HD)	
Surface treatment	AntiGlare or BrightView	
Contrast ratio	300:1 (typical)	
Brightness	220 nits (typical)	
Viewing angle	SVA	
Backlight	WLED	
Companion standard	eDP	

Hard drive specifications

	2-TB*	1-TB*	500-GB*
Dimensions			
Height	9.5 mm	9.5 mm	7.0 mm or 9.5 mm
Length	100.4 mm	100.4 mm	100.6 mm
Width	69.9 mm	69.9 mm	70.1 mm
Weight	115.0 g	115.0 g	92.0 g
Interface type	SATA	SATA	SATA
Transfer rate			
Synchronous (maximum)	300 MB/sec	300 MB/sec	300 MB/sec
Security	ATA security	ATA security	ATA security
Seek times (typical read, including setting)			
Single track	1.4 ms	1.4 ms	3 ms
Average (read/write)	10 ms	10 ms	13 ms
Maximum	12 ms	12 ms	24 ms
Logical blocks	3,877,842,922	1,938,921,461	1,048,576,000
Disk rotational speed	5400 rpm	5400 rpm	5400 rpm
Operating temperature	0°C to 60°C (32°F to 140°F)		
*1 GB = 1 billion bytes when referring to hard drive storage capacity. Actual accessible capacity is less.			
NOTE: Certain restrictions and exclusions apply. Contact technical support for details.			

DVD±RW SuperMulti DL Drive specifications

Component	Value	
Applicable disc	Read: CD-DA, CD+(E)G, CD-MIDI, CD-TEXT, CD-ROM, CD-ROM XA, MIXED MODE CD, CD-I, CD-I Bridge (Photo-CD, Video CD), Multisession CD (Photo-CD, CD-EXTRA, Portfolio, CD-R, CD-RW), CD-R, CD-RW, DVD-ROM (DVD-5, DVD-9, DVD-10, DVD-18), DVD-R, DVD-RW, DVD+R, DVD+RW, DVD-RAM	Write: CD-R and CD-RW DVD+R, DVD+RW, DVD-R, DVD-RW, DVD-RAM
Center hole diameter	1.5 cm (0.59 in)	
Disc diameter		
Standard disc	12 cm (4.72 in)	
Mini disc	8 cm (3.15 in)	
Disc thickness	1.2 mm (0.047 in)	
Track pitch	0.74 μm	
Access time	CD	DVD
Random	< 175 ms	< 230 ms
Full stroke	< 285 ms	< 335 ms
Audio output level	Line-out, 0.7 Vrms	
Cache buffer	2 MB	
Data transfer rate		
24X CD-ROM	3,600 KB/sec	
8X DVD-ROM	10,800 KB/sec	
24X CD-R	3,600 KB/sec	
16X CD-RW	2,400 KB/sec	
8X DVD+R	10,800 KB/sec	
4X DVD+RW	5,400 KB/sec	
8X DVD-R	10,800 KB/sec	
4X DVD-RW	5,400 KB/sec	
2.4X DVD+R(9)	2,700 KB/sec	
5X DVD-RAM	6,750 KB/sec	
Transfer mode	Multiword DMA Mode	
Startup time	< 15 seconds	
Stop time	< 6 seconds	

11 Power cord set requirements

The wide-range input feature of the computer permits it to operate from any line voltage from 100 to 120 volts ac, or from 220 to 240 volts ac.

The 3-conductor power cord set included with the computer meets the requirements for use in the country or region where the equipment is purchased.

Power cord sets for use in other countries and regions must meet the requirements of the country or region where the computer is used.

Requirements for all countries

The following requirements are applicable to all countries and regions:

- The length of the power cord set must be at least **1.5 m** (5.0 ft) and no more than **2.0 m** (6.5 ft).
- All power cord sets must be approved by an acceptable accredited agency responsible for evaluation in the country or region where the power cord set will be used.
- The power cord sets must have a minimum current capacity of 10 A and a nominal voltage rating of 125 or 250 V ac, as required by the power system of each country or region.
- The appliance coupler must meet the mechanical configuration of an EN 60 320/IEC 320 Standard Sheet C13 connector for mating with the appliance inlet on the back of the computer.

Requirements for specific countries and regions

Country/region	Accredited agency	Applicable note number
Argentina	IRAM	1
Australia	SAA	1
Austria	OVE	1
Belgium	CEBEC	1
Brazil	ABNT	1
Canada	CSA	2
Chile	IMQ	1
Denmark	DEMKO	1
Finland	FIMKO	1
France	UTE	1
Germany	VDE	1
India	ISI	1
Israel	SII	1
Italy	IMQ	1
Japan	JIS	3
The Netherlands	KEMA	1
New Zealand	SANZ	1
Norway	NEMKO	1
The People's Republic of China	CCC	4
Saudi Arabia	SASO	7
Singapore	PSB	1
South Africa	SABS	1
South Korea	KTL	5
Sweden	SEMKO	1
Switzerland	SEV	1
Taiwan	BSMI	6
Thailand	TISI	1
The United Kingdom	ASTA	1
The United States	UL	2

1. The flexible cord must be Type H05VV-F, 3-conductor, 0.75mm² conductor size. Power cord set fittings (appliance coupler and wall plug) must bear the certification mark of the agency responsible for evaluation in the country or region where it will be used.
2. The flexible cord must be Type SVT/SJT or equivalent, No. 18 AWG, 3-conductor. The wall plug must be a two-pole grounding type with a NEMA 5-15P (15 A, 125 V ac) or NEMA 6-15P (15 A, 250 V ac) configuration. CSA or C-UL mark. UL file number must be on each element.

Country/region	Accredited agency	Applicable note number
		3. The appliance coupler, flexible cord, and wall plug must bear a “T” mark and registration number in accordance with the Japanese Dentori Law. The flexible cord must be Type VCTF, 3-conductor, 0.75mm ² or 1.25mm ² conductor size. The wall plug must be a two-pole grounding type with a Japanese Industrial Standard C8303 (7 A, 125 V ac) configuration.
		4. The flexible cord must be Type RVV, 3-conductor, 0.75mm ² conductor size. Power cord set fittings (appliance coupler and wall plug) must bear the CCC certification mark.
		5. The flexible cord must be Type H05VV-F 3X0.75mm ² conductor size. KTL logo and individual approval number must be on each element. Corset approval number and logo must be printed on a flag label.
		6. The flexible cord must be Type HVCTF 3X1.25mm ² conductor size. Power cord set fittings (appliance coupler, cable, and wall plug) must bear the BSMI certification mark.
		7. For 127 V ac, the flexible cord must be Type SVT or SJT 3 x 18 AWG, with plug NEMA 5-15P (15 A, 125 V ac), with UL and CSA or C-UL marks. For 240 V ac, the flexible cord must be Type H05VV-F 3X0.75/1.00mm ² conductor size, with plug BS 1363/A with BSI or ASTA marks.

12 Recycling

When a non-rechargeable or rechargeable battery has reached the end of its useful life, do not dispose of the battery in general household waste. Follow the local laws and regulations in your area for battery disposal.

HP encourages customers to recycle used electronic hardware, HP original print cartridges, and rechargeable batteries. For more information about recycling programs, see the HP Web site at <http://www.hp.com/recycle>.

Index

Symbols/Numerics

3D camera, identifying 7

A

AC adapter and battery 9

action keys 13, 14

airplane mode key 14

antennas

illustrated 22

removing 74

audio, product description 3

audio-out (headphone)/audio-in
(microphone) jack, identifying 9

B

backups 83

battery

illustrated 20

removing 32

battery cover, identifying 15

battery lock, identifying 15

battery release latch 15

BIOS

determining version 81

downloading an update 82

starting the Setup Utility 81

updating 81

boot order

changing 87

bottom cover

illustrated 20

removing 39

buttons

left TouchPad 10

optical drive eject 8

power 12

right TouchPad 10

C

cable locations

removing 78

cables

illustrated 25

cables, service considerations 27

caps lock light, identifying 11

chipset, product description 1

components

bottom 15

display 7

left side 9

right side 8

top 10

computer major components,

illustrated 17

computer specifications 91

connector, power 9

connectors, service considerations
27

D

display assembly

illustrated 18

removing 35, 67

spare part numbers 18

display assembly subcomponents

illustrated 21

removing 35, 67

display bezel

illustrated 22

removing 36, 69

display cable

illustrated 22

removing 75

display enclosure

illustrated 22

removing 75

display panel

illustrated 22, 67

product description 2

removing 37, 71

display specifications 92

drive light 8

DVD±RW SuperMulti DL Drive

specifications 93

E

electrostatic discharge 28

equipment guidelines 30

esc key, identifying 13

Ethernet, product description 3

external media cards 3

F

fan/heat sink assembly

removing 56

fn key, identifying 13

G

graphics, product description 1

grounding guidelines 28

guidelines

equipment 30

grounding 28

packaging 29

transporting 29

workstation 29

H

hard drive

illustrated 18, 24

precautions 28

product description 2

removing 41

specifications 92

hard drive cover

illustrated 19, 24

removing 43

HDMI port

identifying 9

heat sink assembly

illustrated 18

removing 18

hinges

illustrated 22

removing 37, 71, 73

HP PC Hardware Diagnostics (UEFI)

using 89

HP Recovery Manager

correcting boot problems 87

starting 86

HP Recovery media

creating 83

recovery 86

- HP Recovery partition
 - recovery 86
 - removing 87
- I**
- integrated numeric keypad, identifying 13
- internal microphone, identifying 7
- J**
- jacks
 - audio-out (headphone)/audio-in (microphone) 9
 - network 9
 - RJ-45 (network) 9
- K**
- keyboard
 - illustrated 18
 - product description 4
- keys
 - action 13
 - airplane mode 14
 - esc 13
 - fn 13
 - Windows 13
- L**
- latch, battery release 15
- lights
 - AC adapter and battery light 9
 - caps lock 11
 - drive 8
 - mute 11
 - power 8
 - RJ-45 (network) status 9
- M**
- mass storage devices
 - illustrated 24
 - precautions 28
- memory card reader, identifying 8
- memory card, identifying 8
- memory module
 - illustrated 19
 - product description 2
 - removing 47
- microphone
 - illustrated 22
 - product description 3
- minimized image recovery 86
- minimized image, creating 85
- model name 1
- mute light, identifying 11
- N**
- network jack, identifying 9
- O**
- operating system 4
- optical drive
 - illustrated 20, 24
 - precautions 28
 - product description 3
 - removing 33
 - specifications 93
- optical drive cable
 - illustrated 20
- optical drive connector
 - illustrated 24
 - removing 52
 - spare part number 52
- optical drive eject button 8
- optical drive rear bracket
 - removing 34
- optical drive, identifying 8
- original system recovery 85
- P**
- packaging guidelines 29
- plastic parts, service considerations 27
- pointing device 4
- ports
 - HDMI 9
 - product description 4
 - USB 2.0 8, 9
 - USB 3.0 9
- power button board
 - illustrated 18
 - removing 76
- power button, identifying 12
- power connector cable
 - illustrated 18
 - removing 77
- power connector, identifying 9
- power cord
 - requirements for all countries 95
 - requirements for specific countries and regions 96
 - set requirements 95
- power lights, identifying 8
- power requirements 4
- processor
 - product description 1
- product description
 - audio 3
 - chipset 1
 - display panel 2
 - Ethernet 3
 - external media cards 3
 - graphics 1
 - hard drive 2
 - keyboard 4
 - memory module 2
 - microphone 3
 - operating system 4
 - optical drive 3
 - pointing device 4
 - ports 4
 - power requirements 4
 - processor 1
 - product name 1
 - security 4
 - serviceability 5
 - video 3
 - wireless 3
- product name 1
- R**
- recover
 - options 85
- recovery
 - discs 84, 86
 - HP Recovery Manager 85
 - media 86
 - starting 86
 - supported discs 84
 - system 85
 - USB flash drive 86
 - using HP Recovery media 84
- recovery media
 - creating 83
 - creating using HP Recovery Manager 84
- recovery partition
 - removing 87
- removal/replacement
 - preliminaries 27
 - procedures 31, 35
- RJ-45 (network) jack, identifying 9

- RJ-45 (network) status lights, identifying 9
- RTC battery
 - illustrated 19
 - removing 46
- Rubber Kit
 - illustrated 20
- S**
- security cable slot, identifying 8
- security, product description 4
- service considerations
 - cables 27
 - connectors 27
 - plastic parts 27
- service tag 16
- serviceability, product description 5
- slots
 - memory card reader 8
 - security cable 8
- solid-state drive
 - illustrated 18
 - removal 49
 - spare part numbers 49
- solid-state drive board
 - illustrated 18, 24
 - removing 50
 - spare part number 50
- solid-state drive holder
 - illustrated 18, 24
 - removing 50
 - spare part number 50
- speakers
 - illustrated 19
 - removing 55
- speakers, identifying 15
- specifications
 - computer 91
 - display 92
 - DVD±RW SuperMulti DL Drive 93
 - hard drive 92
 - optical drive 93
- supported discs, recovery 84
- system board
 - removing 64
 - spare part number 19, 64
- system recovery 85
- system restore point
 - creating 84
- system restore point, creating 83

- T**
- tools required 27
- top cover
 - illustrated 18
- top cover/keyboard 79
- touch control board
 - illustrated 22
 - removing 72
 - spare part number 67
- TouchPad
 - buttons 10
- TouchPad board
 - illustrated 18
- TouchPad click board
 - removing 53
 - spare part number 53
- TouchPad zone, identifying 10
- transporting guidelines 29
- U**
- USB 2.0 port, identifying 8, 9
- USB 3.0 port, identifying 9
- USB board
 - removing 54
 - spare part number 18
- V**
- vents, identifying 9
- video, product description 3
- W**
- webcam
 - identifying 7
 - illustrated 22
- webcam cable
 - removing 75
- webcam light, identifying 7
- webcam/microphone cable
 - removing 37, 71
- webcam/microphone module
 - removing 36, 70
- Windows
 - system restore point 83, 84
- Windows key, identifying 13
- Windows tools
 - using 84
- wireless antennas
 - illustrated 22
 - removing 74
- wireless, product description 3
- WLAN antennas, identifying 7

- WLAN module
 - illustrated 19
 - removing 44
- workstation guidelines 29

