

# User Guide

© Copyright 2015 HP Development Company, L.P.

AMD is a trademark of Advanced Micro Devices, Inc. Bluetooth is a trademark owned by its proprietor and used by HP Inc. under license. Intel is a trademark of Intel Corporation in the U.S. and other countries. Java is a U.S. trademark of Sun Microsystems, Inc. Microsoft and Windows are trademarks of the Microsoft group of companies. SD Logo is a trademark of its proprietor.

The information contained herein is subject to change without notice. The only warranties for HP products and services are set forth in the express warranty statements accompanying such products and services. Nothing herein should be construed as constituting an additional warranty. HP shall not be liable for technical or editorial errors or omissions contained herein.

First Edition: October 2015

Document Part Number: 839471-001

### Product notice

This user guide describes features that are common to most models. Some features may not be available on your computer.

This computer may require upgraded and/or separately purchased hardware and/or a DVD drive to install the Windows 7 software and take full advantage of Windows 7 functionality. Go to <http://windows.microsoft.com/en-us/windows7/get-know-windows-7> for details.

To access the latest user guide, go to <http://www.hp.com/support>, and select your country. Select **Drivers & Downloads**, and then follow the on-screen instructions.

### Software terms

By installing, copying, downloading, or otherwise using any software product preinstalled on this computer, you agree to be bound by the terms of the HP End User License Agreement (EULA). If you do not accept these license terms, your sole remedy is to return the entire unused product (hardware and software) within 14 days for a full refund subject to the refund policy of your seller.

For any further information or to request a full refund of the price of the computer, please contact your seller.

## Safety warning notice

---

 **WARNING!** To reduce the possibility of heat-related injuries or of overheating the computer, do not place the computer directly on your lap or obstruct the computer air vents. Use the computer only on a hard, flat surface. Do not allow another hard surface, such as an adjoining optional printer, or a soft surface, such as pillows or rugs or clothing, to block airflow. Also, do not allow the AC adapter to come into contact with the skin or a soft surface, such as pillows or rugs or clothing, during operation. The computer and the AC adapter comply with the user-accessible surface temperature limits defined by the International Standard for Safety of Information Technology Equipment (IEC 60950-1).

---



---

# Table of contents

<b>1 Welcome .....</b>	<b>1</b>
Finding information .....	2
<b>2 Getting to know your computer .....</b>	<b>3</b>
Right .....	3
Left .....	5
Display .....	7
Top .....	8
TouchPad .....	8
Lights .....	9
Buttons, speakers, and fingerprint reader .....	10
Keys .....	12
Bottom .....	14
Front .....	15
Rear .....	16
<b>3 Connecting to a network .....</b>	<b>17</b>
Connecting to a wireless network .....	17
Using the wireless controls .....	17
Turning wireless devices on or off .....	17
Using HP Connection Manager (select products only) .....	18
Using the wireless button .....	18
Using operating system controls .....	18
Using a WLAN .....	18
Using an Internet service provider .....	19
Setting up a WLAN .....	19
Configuring a wireless router .....	19
Protecting your WLAN .....	20
Connecting to a WLAN .....	20
Using HP Mobile Broadband (select products only) .....	20
Inserting and removing a SIM card .....	21
Using HP Mobile Connect (select products only) .....	22
Using GPS (select products only) .....	22
Using Bluetooth wireless devices .....	22
Connecting to a wired network .....	23
Connecting to a local area network (LAN) .....	23

<b>4 Navigating using the keyboard, touch gestures and pointing devices .....</b>	<b>24</b>
Using pointing devices .....	24
Setting pointing device preferences .....	24
Using the pointing stick .....	24
Using the TouchPad and gestures .....	24
Tapping .....	25
Scrolling .....	25
2-finger pinch zoom .....	26
2-finger click .....	26
Rotating (select products only) .....	27
Flicking (select products only) .....	27
Using the keyboard .....	27
Identifying the hot keys .....	28
Using keypads .....	28
Using the embedded numeric keypad (select products only) .....	29
Turning the embedded numeric keypad on and off .....	30
Switching key functions on the embedded numeric keypad .....	30
Using the integrated numeric keypad (select products only) .....	30
Using an optional external numeric keypad .....	31
<b>5 Multimedia .....</b>	<b>32</b>
Audio .....	32
Connecting speakers .....	32
Adjusting the volume .....	32
Connecting headphones .....	32
Connecting a microphone .....	33
Connecting headphones and microphones .....	33
Checking audio functions on the computer .....	33
Webcam (select products only) .....	33
Video .....	34
VGA .....	34
Dual-Mode DisplayPort .....	35
Intel Wireless Display (select products only) .....	35
Discovering and connecting wired displays using MultiStream Transport .....	36
Connect displays to computers with AMD graphics (with an optional hub) .....	36
Connect displays to computers with Intel graphics (with an optional hub) .....	36
Connect displays to computers with Intel graphics (with a built-in hub) .....	36
<b>6 Power management .....</b>	<b>38</b>
Shutting down (turning off) the computer .....	38

Setting power options .....	38
Using power-saving states .....	38
Initiating and exiting Sleep .....	39
Initiating and exiting Hibernation .....	39
Using the power meter and power settings .....	39
Setting password protection on wakeup .....	40
Using battery power .....	40
Using HP Battery Check .....	40
Displaying the remaining battery charge .....	41
Maximizing battery discharge time .....	41
Managing low battery levels .....	41
Identifying low battery levels .....	41
Resolving a low battery level .....	41
Removing the battery .....	42
Conserving battery power .....	43
Disposing of a user-replaceable battery .....	43
Replacing a battery .....	43
Using external AC power .....	43
Testing an AC adapter .....	44
<b>7 External cards and devices .....</b>	<b>45</b>
Using memory card readers (select products only) .....	45
Inserting a memory card .....	45
Removing a memory card .....	45
Using smart cards (select products only) .....	46
Inserting a smart card .....	47
Removing a smart card .....	48
Using a USB device .....	48
Removing a USB device .....	49
Using a serial device (select products only) .....	50
Using optional external devices .....	50
Using optional external drives .....	50
<b>8 Drives .....</b>	<b>52</b>
Using hard drives .....	52
Improving hard drive performance .....	52
Using Disk Defragmenter .....	52
Using Disk Cleanup .....	52
Using HP 3D DriveGuard (select products only) .....	53
Identifying HP 3D DriveGuard status .....	53

<b>9 Security .....</b>	<b>54</b>
Protecting the computer .....	54
Using passwords .....	55
Setting passwords in Windows .....	55
Setting passwords in Computer Setup .....	56
Managing a BIOS administrator password .....	56
Entering a BIOS administrator password .....	57
Managing a Computer Setup DriveLock password (select products only) .....	58
Setting a DriveLock password .....	58
Enabling DriveLock (select products only) .....	59
Disabling DriveLock (select products only) .....	59
Entering a DriveLock password (select products only) .....	60
Changing a DriveLock password (select products only) .....	60
Using antivirus software .....	60
Using firewall software .....	60
Installing critical security updates .....	61
Using HP Client Security (select products only) .....	61
Using HP Touchpoint Manager (select products only) .....	61
Installing an optional security cable (select products only) .....	62
Using a fingerprint reader (select products only) .....	62
Locating the fingerprint reader .....	62
<b>10 Maintenance .....</b>	<b>63</b>
Cleaning your computer .....	63
Cleaning procedures .....	63
Cleaning the display (All-in-Ones or Notebooks) .....	63
Cleaning the sides or cover .....	63
Cleaning the TouchPad, keyboard, or mouse .....	64
Updating programs and drivers .....	64
Using SoftPaq Download Manager .....	64
<b>11 Backup and recovery .....</b>	<b>65</b>
Creating recovery media and backups .....	65
Guidelines .....	65
Creating recovery media with HP Recovery Disc Creator .....	65
Creating recovery media .....	66
Backing up your information .....	66
Performing a system recovery .....	67
Using the Windows recovery tools .....	67
Using f11 recovery tools (select products only) .....	68



Using Windows 7 operating system media .....	68
<b>12 Computer Setup (BIOS), TPM, and HP Sure Start .....</b>	<b>70</b>
Using Computer Setup .....	70
Starting Computer Setup .....	70
Navigating and selecting in Computer Setup .....	70
Restoring factory settings in Computer Setup .....	71
Updating the BIOS .....	72
Determining the BIOS version .....	72
Downloading a BIOS update .....	72
Changing the boot order using the f9 prompt .....	73
TPM BIOS settings (select products only) .....	73
Using HP Sure Start (select products only) .....	74
<b>13 Using HP PC Hardware Diagnostics (UEFI) .....</b>	<b>75</b>
Downloading HP PC Hardware Diagnostics (UEFI) to a USB device .....	75
<b>14 Support .....</b>	<b>77</b>
Contacting support .....	77
Labels .....	77
<b>15 Specifications .....</b>	<b>79</b>
Input power .....	79
Operating environment .....	79
<b>16 Accessibility .....</b>	<b>80</b>
Supported assistive technologies .....	80
Contacting support .....	80
<b>Appendix A Traveling with or shipping your computer .....</b>	<b>81</b>
<b>Appendix B Troubleshooting .....</b>	<b>82</b>
Troubleshooting resources .....	82
Resolving issues .....	82
The computer is unable to start up .....	82
The computer screen is blank .....	82
Software is functioning abnormally .....	83
The computer is on but not responding .....	83
The computer is unusually warm .....	83
An external device is not working .....	83

The wireless network connection is not working .....	83
A disc does not play .....	84
A movie is not visible on an external display .....	84
The process of burning a disc does not begin, or it stops before completion .....	85

<b>Appendix C Electrostatic discharge .....</b>	<b>86</b>
---	-----------

<b>Index .....</b>	<b>87</b>
--------------------	-----------

---

# 1 Welcome

After you set up and register the computer, we recommend the following steps to get the most out of your smart investment:

- **Connect to the Internet**—Set up your wired or wireless network so that you can connect to the Internet. For more information, see [Connecting to a network on page 17](#).
- **Update your antivirus software**—Protect your computer from damage caused by viruses. The software is preinstalled on the computer. For more information, see [Using antivirus software on page 60](#).
- **Get to know your computer**—Learn about your computer features. See [Getting to know your computer on page 3](#) and [Navigating using the keyboard, touch gestures and pointing devices on page 24](#) for additional information.
- **Find installed software**—Access a list of the software preinstalled on the computer:  
Select **Start > All Programs**. For details about using the software included with the computer, see the software manufacturer's instructions, which may be provided with the software or on the manufacturer's website.
- Back up your hard drive by creating recovery discs or a recovery flash drive. See [Backup and recovery on page 65](#).

## Finding information

You have already used *Setup Instructions* to turn on the computer and locate this guide. To locate resources that provide product details, how-to information, and more, use this table.





Resources	For information about
<i>Setup Instructions</i> poster	<ul style="list-style-type: none"><li>• How to set up the computer</li><li>• Help to identify computer components</li></ul>
Help and Support To access Help and Support, select <b>Start &gt; All Programs &gt; HP Help and Support</b> . To access the latest user guide, go to <a href="http://www.hp.com/support">http://www.hp.com/support</a> , and select your country. Select <b>Drivers &amp; Downloads</b> , and then follow the on-screen instructions.	<ul style="list-style-type: none"><li>• Operating system information</li><li>• Software, driver, and BIOS updates</li><li>• Troubleshooting tools</li><li>• How to access support</li></ul>
Worldwide support To get support in your language, go to <a href="http://www.hp.com/support">http://www.hp.com/support</a> , and select your country.	<ul style="list-style-type: none"><li>• Online chat with an HP technician</li><li>• Support telephone numbers</li><li>• HP service center locations</li></ul>
HP website To access the latest user guide, go to <a href="http://www.hp.com/support">http://www.hp.com/support</a> , and select your country. Select <b>Drivers &amp; Downloads</b> , and then follow the on-screen instructions.	<ul style="list-style-type: none"><li>• Support information</li><li>• Ordering parts and finding additional help</li><li>• Accessories available for the device</li></ul>
<i>Safety &amp; Comfort Guide</i> To access the user guide, select <b>Start &gt; All Programs &gt; HP Help and Support &gt; HP Documentation</b> . – or – Go to <a href="http://www.hp.com/ergo">http://www.hp.com/ergo</a> .	<ul style="list-style-type: none"><li>• Proper workstation setup, posture, health, and work habits</li><li>• Electrical and mechanical safety information</li></ul>
<i>Regulatory, Safety, and Environmental Notices</i> To access the user guide, select <b>Start &gt; All Programs &gt; HP Help and Support &gt; HP Documentation</b> .	<ul style="list-style-type: none"><li>• Regulatory and safety information</li><li>• Battery disposal information</li></ul>
<i>Limited Warranty*</i> To access the Limited Warranty, select <b>Start &gt; All Programs &gt; HP Help and Support &gt; HP Documentation &gt; View Warranty Information</b> . – or – Go to <a href="http://www.hp.com/go/orderdocuments">http://www.hp.com/go/orderdocuments</a> .	Warranty information



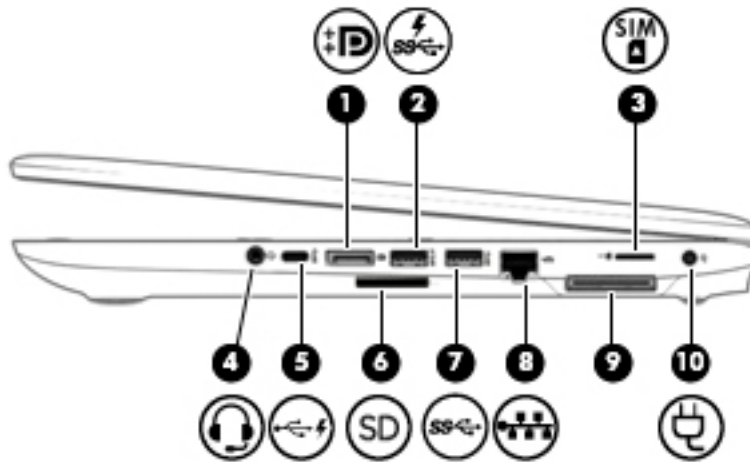

\*You can find your HP Limited Warranty located with the user guides on your product and/or on the CD or DVD provided in the box. In some countries or regions, HP may provide a printed warranty in the box. For countries or regions where the warranty is not provided in printed format, you can request a copy from <http://www.hp.com/go/orderdocuments>. For products purchased in Asia Pacific, you can write to HP at Hewlett Packard, POD, P.O. Box 200, Alexandra Post Office, Singapore 911507. Include your product name, and your name, phone number, and postal address.

## 2 Getting to know your computer

### Right



Component	Description
(1) 	<p>Dual-Mode DisplayPort</p> <p>Connects an optional digital display device, such as a high-performance monitor or projector.</p>
(2) 	<p>USB 3.0 charging (powered) port</p> <p>Connects an optional USB device, such as a keyboard, mouse, external drive, printer, scanner or USB hub. Standard USB ports will not charge all USB devices or will charge using a low current. Some USB devices require power and require you to use a powered port.</p> <p><b>NOTE:</b> USB charging ports can also charge select models of cell phones and MP3 players, even when the computer is off.</p>
(3) 	<p>SIM card slot (select products only)</p> <p>Supports a wireless subscriber identity module (SIM) card.</p>
(4) 	<p>Audio-out (headphone)/Audio-in (microphone) combo jack</p> <p>Connects optional powered stereo speakers, headphones, earbuds, a headset, or a television audio cable. Also connects an optional headset microphone. This jack does not support optional microphone-only devices.</p> <p><b>WARNING!</b> To reduce the risk of personal injury, adjust the volume before putting on headphones, earbuds, or a headset. For additional safety information, refer to the <i>Regulatory, Safety, and Environmental Notices</i>.</p> <p>To access this guide, select <b>Start &gt; All Programs &gt; HP Help and Support &gt; HP Documentation</b>.</p> <p><b>NOTE:</b> When a device is connected to the jack, the computer speakers are disabled.</p>
(5) 	<p>USB Type-C (charging) port</p> <p>Connects any USB device with a Type-C connector.</p>

Component	Description
	<p><b>NOTE:</b> USB Type-C ports charge products such as cell phones, laptops, tablets, and MP3 players, even when the computer is off.</p> <p><b>NOTE:</b> Adapters (purchased separately) may be required.</p>
<p>(6) Memory card reader</p>	<p>Reads optional memory cards that store, manage, share, or access information.</p>
<p>(7)  USB 3.0 port</p>	<p>Connects an optional USB device, such as a keyboard, mouse, external drive, printer, scanner or USB hub.</p>
<p>(8)  RJ-45 (network) jack/status lights</p>	<p>Connects a network cable.</p> <ul style="list-style-type: none"> <li>• Green (right): The network is connected.</li> <li>• Amber (left): Activity is occurring on the network.</li> </ul>
<p>(9)  Docking port</p>	<p>Connects an optional docking device.</p>
<p>(10)  Power connector</p>	<p>Connects an AC adapter.</p>

## Left



**NOTE:** Refer to the illustration that most closely matches your computer.

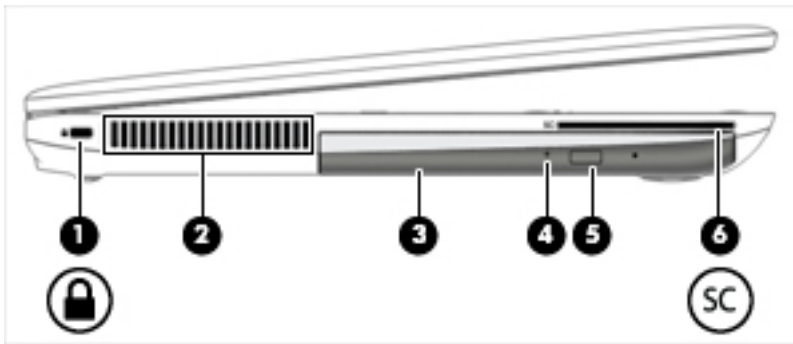

Component	Description
(1)  Security cable slot	Attaches an optional security cable to the computer.  <b>NOTE:</b> The security cable is designed to act as a deterrent, but it may not prevent the computer from being mishandled or stolen.
(2) Vent	Enables airflow to cool internal components.  <b>NOTE:</b> The computer fan starts up automatically to cool internal components and prevent overheating. It is normal for the internal fan to cycle on and off during routine operation.
(3) Optical drive (select products only)	Depending on your computer model, reads an optical disc or reads and writes to an optical disc.
(4) Optical drive light	Green: The optical drive is in use. Off: The optical drive is off.
(5) Optical drive eject button	Releases the optical drive disc tray.
(6) Smart card reader	Supports optional smart cards.

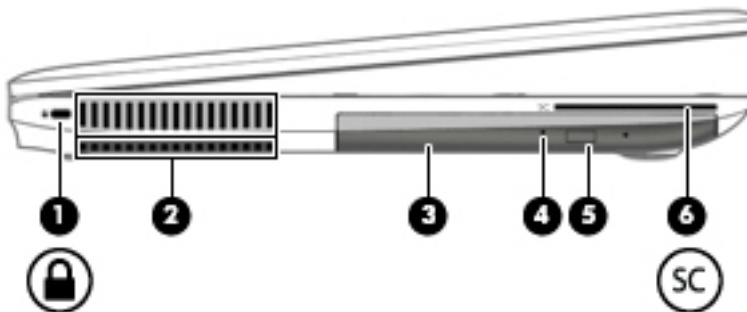

Component	Description
(1)  Security cable slot	Attaches an optional security cable to the computer.  <b>NOTE:</b> The security cable is designed to act as a deterrent, but it may not prevent the computer from being mishandled or stolen.

Component	Description
(2) Vent	Enables airflow to cool internal components. <b>NOTE:</b> The computer fan starts up automatically to cool internal components and prevent overheating. It is normal for the internal fan to cycle on and off during routine operation.
(3) Optical drive (select products only)	Depending on your computer model, reads an optical disc or reads and writes to an optical disc.
(4) Optical drive light	Green: The optical drive is in use. Off: The optical drive is off.
(5) Optical drive eject button	Releases the optical drive disc tray.
(6) Smart card reader	Supports optional smart cards.



# Display

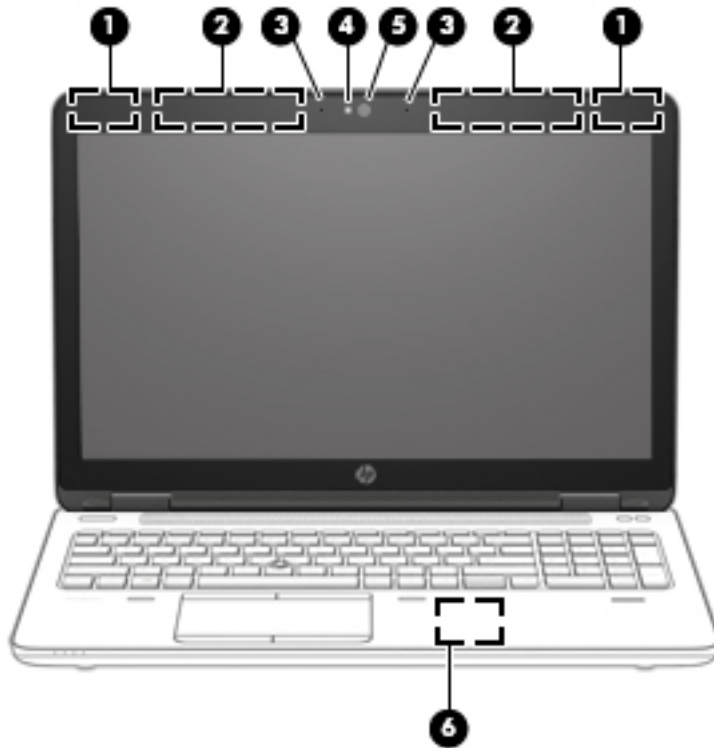

Component	Description
(1) WLAN antennas*	Send and receive wireless signals to communicate with wireless local area networks (WLANs).
(2) WWAN antennas*	Send and receive wireless signals to communicate with wireless wide area networks (WWANs).
(3) Internal microphones	Record sound.
(4) Webcam light (select products only)	On: The webcam is in use.
(5) Webcam (select products only)	Records video and captures photographs. Some models allow you to video conference and chat online using streaming video.  For information on using the webcam, select <b>Start &gt; All Programs &gt; Communication and Chat &gt; HP WebCam</b> .
(6) Near Field Communication (NFC) tapping area* (select products only)	Tap another NFC-enabled device to the NFC tapping area to transfer files.

\*The antennas are not visible from the outside of the computer. For optimal transmission, keep the areas immediately around the antennas free from obstructions.

For wireless regulatory notices, see the section of the *Regulatory, Safety, and Environmental Notices* that applies to your country or region. To access this guide, select **Start > All Programs > HP Help and Support > HP Documentation**.

# Top



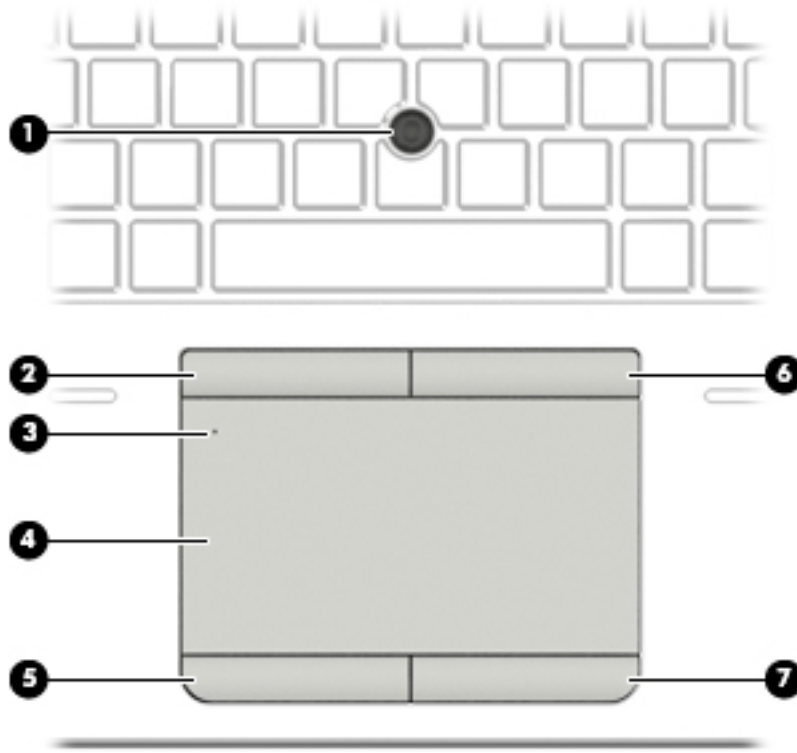

## TouchPad

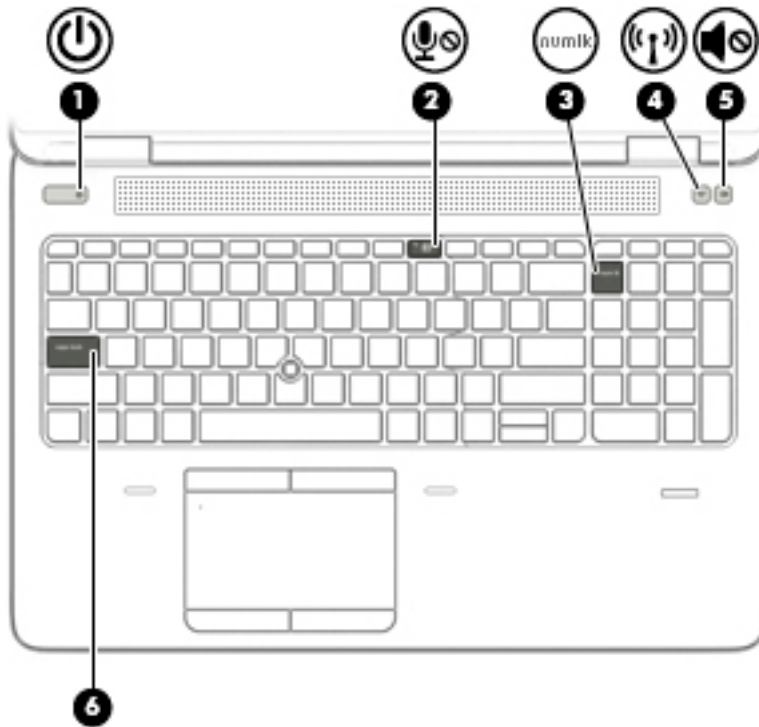

Component	Description
(1) Pointing stick (select products only)	Moves the pointer and selects or activates items on the screen.
(2) Left pointing stick button (select products only)	Functions like the left button on an external mouse.
(3) TouchPad light	<ul style="list-style-type: none"><li>• On: The TouchPad is off.</li><li>• Off: The TouchPad is on.</li></ul>
(4) TouchPad zone	Reads your finger gestures to move the pointer or activate items on the screen.
(5) Left TouchPad button	Functions like the left button on an external mouse.
(6) Right pointing stick button (select products only)	Functions like the right button on an external mouse.
(7) Right TouchPad button	Functions like the right button on an external mouse.



## Lights

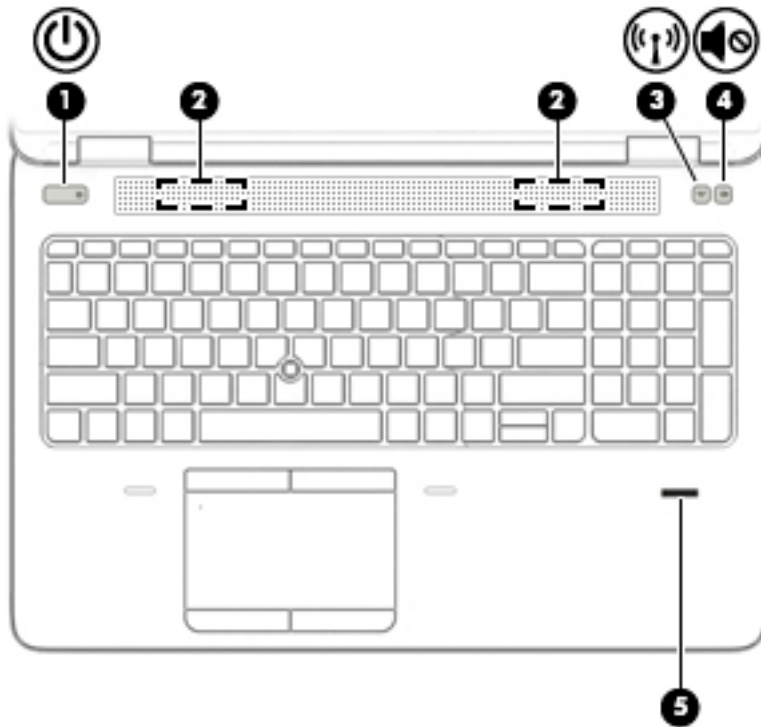

Component	Description
(1)  Power light	<ul style="list-style-type: none"> <li>On: The computer is on.</li> <li>Blinking: The computer is in the Sleep state, a power-saving state. The computer shuts off power to the display and other unneeded components.</li> <li>Off: The computer is off or in Hibernation. Hibernation is a power-saving state that uses the least amount of power.</li> </ul>
(2)  Microphone mute light	<ul style="list-style-type: none"> <li>Amber: microphone sound is off.</li> <li>Off: microphone sound is on.</li> </ul>
(3) Num lock light	On: Num lock is on.
(4)  Wireless light	<p>On: An integrated wireless device, such as a wireless local area network (WLAN) device and/or a Bluetooth® device, is on.</p> <p><b>NOTE:</b> On some models, the wireless light is amber when all wireless devices are off.</p>
(5)  Mute light	<ul style="list-style-type: none"> <li>Amber: Computer sound is off.</li> <li>White: Computer sound is on.</li> </ul>
(6) Caps lock light	On: Caps lock is on, which switches the key input to all capital letters.

## Buttons, speakers, and fingerprint reader





Component	Description
<b>(1)</b>  Power button	<ul style="list-style-type: none"> <li>• When the computer is off, press the button to turn on the computer.</li> <li>• When the computer is on, press the button briefly to initiate Sleep.</li> <li>• When the computer is in the Sleep state, press the button briefly to exit Sleep.</li> <li>• When the computer is in Hibernation, press the button briefly to exit Hibernation.</li> </ul> <p><b>CAUTION:</b> Pressing and holding down the power button results in the loss of unsaved information.</p> <p>If the computer has stopped responding and shutdown procedures are ineffective, press and hold the power button for at least 5 seconds to turn off the computer.</p> <p>To learn more about your power settings, see your power options: Select <b>Start &gt; Control Panel &gt; System and Security &gt; Power Options</b>.</p>
<b>(2)</b> Speakers	Produce sound.
<b>(3)</b>  Wireless button	<p>Turns the wireless feature on or off but does not establish a wireless connection.</p> <p>A wireless network must be set up before a wireless connection is possible.</p>

Component	Description
(4)  Volume mute button	Mutes and restores speaker sound.
(5) Fingerprint reader (select products only)	Allows a fingerprint logon to Windows, instead of a password logon.

## Keys

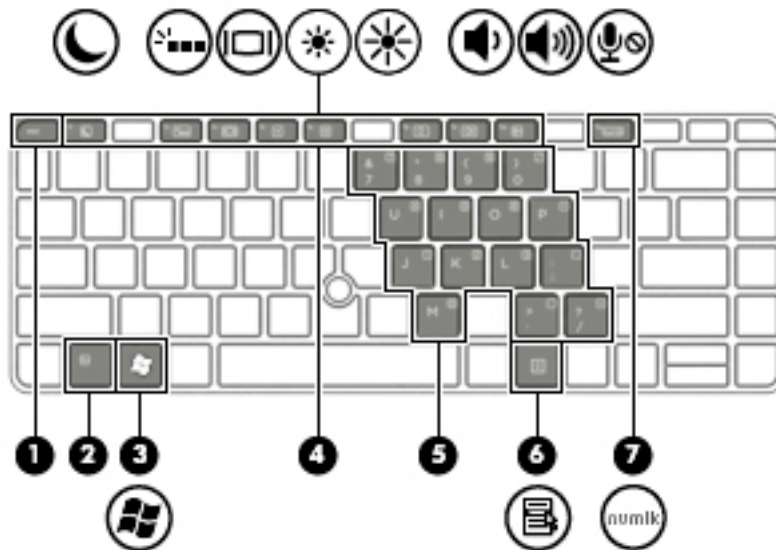
 **NOTE:** Refer to the illustration that most closely matches your computer.



Component	Description
(1) <code>esc</code> key	Displays system information when pressed in combination with the <code>fn</code> key.
(2) <code>fn</code> key	Executes frequently used system functions when pressed in combination with a function key, the <code>num lk</code> key, the <code>esc</code> key, or the <code>b</code> key.
(3)  Windows button	Displays the Windows Start menu.
(4) Function keys	Execute frequently used system functions when pressed in combination with the <code>fn</code> key.
(5) Embedded numeric keypad	When the keypad is turned on, it can be used like an external numeric keypad.
(6)  Windows applications key	Displays a shortcut menu for items beneath the cursor.
(7) <code>num lk</code> key	Turns the embedded numeric keypad on and off when pressed in combination with the <code>fn</code> key.  Alternates between the navigational and numeric functions on the integrated numeric keypad.

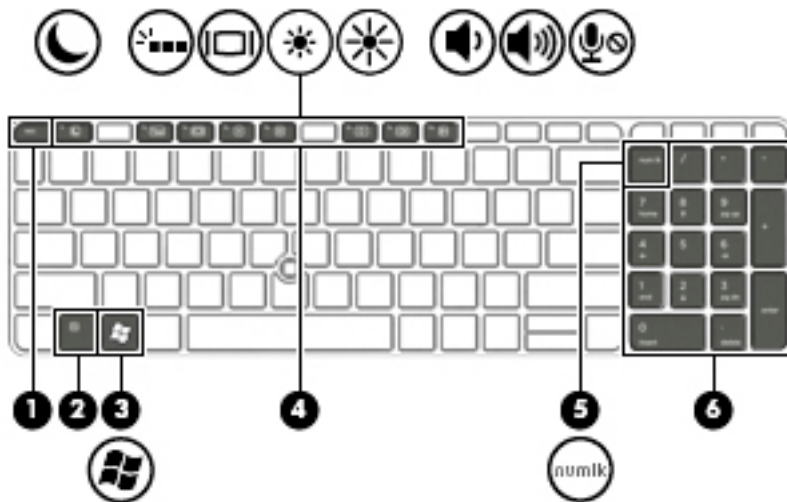

Component	Description
(1) <code>esc</code> key	Displays system information when pressed in combination with the <code>fn</code> key.
(2) <code>fn</code> key	Executes frequently used system functions when pressed in combination with a function key, the <code>num lk</code> key, the <code>esc</code> key, or the <code>b</code> key.
(3)  Windows button	Displays the Windows Start menu.
(4) Function keys	Execute frequently used system functions when pressed in combination with the <code>fn</code> key.
(5) <code>num lk</code> key	Turns the embedded numeric keypad on and off when pressed in combination with the <code>fn</code> key. Alternates between the navigational and numeric functions on the integrated numeric keypad.
(6) Integrated numeric keypad	When <code>num lk</code> has been enabled, it can be used like an external numeric keypad.

## Bottom

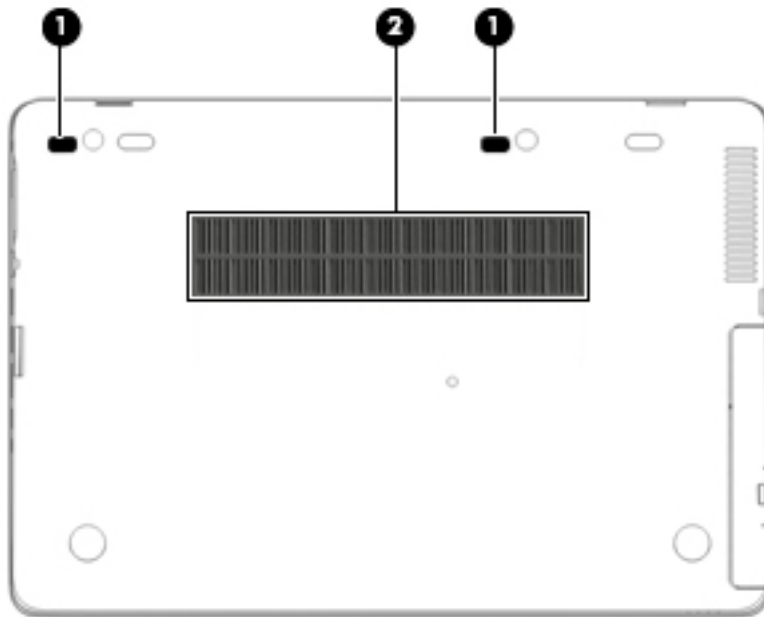





Component		Description
(1)	Docking station support holes	Support an optional docking station.
(2)	Vent	Enables airflow to cool internal components. <b>NOTE:</b> The computer fan starts up automatically to cool internal components and prevent overheating. It is normal for the internal fan to cycle on and off during routine operation.





# Front



Component	Description
(1)  Wireless light	<p>On: An integrated wireless device, such as a wireless local area network (WLAN) device and/or a Bluetooth device and/or a WWAN device, is on.</p> <p><b>NOTE:</b> On some models, the wireless light is amber when all wireless devices are off.</p>
(2)  Power light	<ul style="list-style-type: none"> <li>On: The computer is on.</li> <li>Blinking: The computer is in the Sleep state, a power-saving state. The computer shuts off power to the display and other unneeded components.</li> <li>Off: The computer is off or in Hibernation. Hibernation is a power-saving state that uses the least amount of power.</li> </ul>
(3)  Battery light	<p>When AC power is connected:</p> <ul style="list-style-type: none"> <li>White: The battery charge is greater than 90 percent.</li> <li>Amber: The battery charge is from 0 to 90 percent.</li> <li>Off: The battery is not charging.</li> </ul> <p>When AC power is disconnected (battery not charging):</p> <ul style="list-style-type: none"> <li>Blinking amber: The battery has reached a low battery level. When the battery has reached a critical battery level, the battery light begins blinking rapidly.</li> <li>Off: The battery is not charging.</li> </ul>
(4)  Drive light	<ul style="list-style-type: none"> <li>Blinking white: The hard drive is being accessed.</li> <li>Amber: HP 3D DriveGuard has temporarily parked the hard drive.</li> </ul> <p><b>NOTE:</b> For more information about HP 3D DriveGuard, see <a href="#">Using HP 3D DriveGuard (select products only)</a> on page 53.</p>

## Rear



Component	Description
(1)  External monitor port	Connects an external VGA monitor or projector.
(2)  Serial port (select products only)	Connects an optional device such as a serial modem, mouse, or printer.

---

## 3 Connecting to a network

Your computer can travel with you wherever you go. But even at home, you can explore the globe and access information from millions of websites using your computer and a wired or wireless network connection. This chapter will help you get connected to that world.

### Connecting to a wireless network

Wireless technology transfers data across radio waves instead of wires. Your computer may be equipped with one or more of the following wireless devices:

- **Wireless local area network (WLAN) device**—Connects the computer to wireless local area networks (commonly referred to as Wi-Fi networks, wireless LANs, or WLANs) in corporate offices, your home, and public places such as airports, restaurants, coffee shops, hotels, and universities. In a WLAN, the mobile wireless device in your computer communicates with a wireless router or a wireless access point.
- **HP Mobile Broadband Module (select products only)**—A wireless wide area network (WWAN) device that gives you wireless connectivity over a much larger area. Mobile network operators install base stations (similar to cell phone towers) throughout large geographic areas, effectively providing coverage across entire states, regions, or even countries.
- **Bluetooth device**—Creates a personal area network (PAN) to connect to other Bluetooth-enabled devices such as computers, phones, printers, headsets, speakers, and cameras. In a PAN, each device communicates directly with other devices, and devices must be relatively close together—typically within 10 meters (approximately 33 feet) of each other.

For more information about wireless technology, see the information and website links provided in Help and Support. To access Help and Support, select **Start > Help and Support**.

### Using the wireless controls

You can control the wireless devices in your computer using these features:

- Wireless button, wireless switch, or wireless key (referred to in this chapter as the wireless button)
- Operating system controls

### Turning wireless devices on or off

You can use the wireless button or HP Connection Manager (select products only) to turn on and turn off wireless devices.



**NOTE:** A computer may have a wireless button, a wireless switch, or a wireless key on the keyboard. The term wireless button is used throughout this guide to refer to all types of wireless controls.

---

To turn off wireless devices using HP Connection Manager:

- ▲ Right-click the **HP Connection Manager** icon in the notification area, at the far right of the taskbar, and then click the power button next to the desired device.

-or-

Select **Start > All Programs > Productivity and Tools > HP Connection Manager**, and then click the power button next to the desired device.

## Using HP Connection Manager (select products only)

HP Connection Manager provides a central location for managing your wireless devices, an interface for connecting to the Internet using HP Mobile Broadband, and an interface for sending and receiving SMS (text) messages. HP Connection Manager allows you to manage the following devices:

- Wireless local area network (WLAN)/Wi-Fi
- Wireless wide area network (WWAN)/HP Mobile Broadband
- Bluetooth

HP Connection Manager provides information and notifications on connection status, power status, SIM card details, and SMS messages. Status information and notifications are provided in the notification area, at the far right of the taskbar.

To open HP Connection Manager:

- ▲ Click the **HP Connection Manager** icon in the taskbar.

-or-

Select **Start > All Programs > Productivity and Tools > HP Connection Manager**.

For more information, see the HP Connection Manager software Help.

## Using the wireless button

The computer has a wireless button, one or more wireless devices, and one or two wireless lights, depending on the model. All of the wireless devices on your computer are enabled at the factory, so the wireless light is on (white) when you turn on the computer.

The wireless light indicates the overall power state of your wireless devices, not the status of individual devices. If the wireless light is white, at least one wireless device is on. If the wireless light is off, all wireless devices are off.



---

**NOTE:** On some models, the wireless light is amber when all wireless devices are off.

---

Because the wireless devices are enabled at the factory, you can use the wireless button to turn on or turn off the wireless devices simultaneously.

## Using operating system controls

The Network and Sharing Center allows you to set up a connection or network, connect to a network, manage wireless networks, and diagnose and repair network problems.

To use operating system controls:

- ▲ Select **Start > Control Panel > Network and Internet > Network and Sharing Center**.

For more information, access Help and Support by selecting **Start > Help and Support**.

## Using a WLAN

With a WLAN device, you can access a wireless local area network (WLAN), which is composed of other computers and accessories that are linked by a wireless router or a wireless access point.



---

**NOTE:** The terms *wireless router* and *wireless access point* are often used interchangeably.

---

- A large-scale WLAN, such as a corporate or public WLAN, typically uses wireless access points that can accommodate a large number of computers and accessories and can separate critical network functions.
- A home or small office WLAN typically uses a wireless router, which allows several wireless and wired computers to share an Internet connection, a printer, and files without requiring additional pieces of hardware or software.

To use the WLAN device in your computer, you must connect to a WLAN infrastructure (provided through a service provider or a public or corporate network).

## Using an Internet service provider

When you are setting up Internet access in your home, you must establish an account with an Internet service provider (ISP). To purchase Internet service and a modem, contact a local ISP. The ISP will help set up the modem, install a network cable to connect your wireless computer to the modem, and test the Internet service.

---

 **NOTE:** Your ISP will give you a user ID and a password to use for Internet access. Record this information and store it in a safe place.

---

## Setting up a WLAN

To set up a WLAN and connect to the Internet, you need the following equipment:

- A broadband modem (either DSL or cable) **(1)** and high-speed Internet service purchased from an Internet service provider
- A wireless router **(2)** (purchased separately)
- A wireless computer **(3)**

---

 **NOTE:** Some modems have a built-in wireless router. Check with your ISP to determine what type of modem you have.

---

The illustration below shows an example of a wireless network installation that is connected to the Internet.



As your network grows, additional wireless and wired computers can be connected to the network to access the Internet.

For help in setting up your WLAN, see the information provided by your router manufacturer or your ISP.

## Configuring a wireless router

For help in configuring a wireless router, see the information provided by your router manufacturer or your ISP.

---

 **NOTE:** It is recommended that you initially connect your new wireless computer to the router by using the network cable provided with the router. When the computer successfully connects to the Internet, disconnect the cable, and access the Internet through your wireless network.

---

## Protecting your WLAN

When you set up a WLAN or access an existing WLAN, always enable security features to protect your network from unauthorized access. WLANs in public areas (hotspots) like coffee shops and airports may not provide any security. If you are concerned about the security of your computer in a hotspot, limit your network activities to email that is not confidential and basic Internet surfing.

Wireless radio signals travel outside the network, so other WLAN devices can pick up unprotected signals. Take the following precautions to protect your WLAN:

- Use a firewall.  
A firewall checks both data and requests for data that are sent to your network, and discards any suspicious items. Firewalls are available in both software and hardware. Some networks use a combination of both types.
- Use wireless encryption.  
Wireless encryption uses security settings to encrypt and decrypt data that is transmitted over the network. For more information, access Help and Support by selecting **Start > Help and Support**.

## Connecting to a WLAN

To connect to the WLAN, follow these steps:

1. Be sure that the WLAN device is on. If the device is on, the wireless light is on. If the wireless light is off, press the wireless button.



---

**NOTE:** On some models, the wireless light is amber when all wireless devices are off.

---

2. Click the network status icon in the notification area, at the far right of the taskbar.
3. Select a WLAN to connect to.
4. Click **Connect**.

If the WLAN is a security-enabled WLAN, you are prompted to enter a security code. Type the code, and then click **OK** to complete the connection.



---

**NOTE:** If no WLANs are listed, you may be out of range of a wireless router or access point.

---



---

**NOTE:** If you do not see the WLAN you want to connect to, click **Open Network and Sharing Center**, and then click **Set up a new connection or network**. A list of options is displayed, allowing you to manually search for and connect to a network or to create a new network connection.

---

5. Follow the on-screen instructions to complete the connection.

After the connection is made, place the mouse pointer over the network status icon in the notification area, at the far right of the taskbar, to verify the name and status of the connection.



---

**NOTE:** The functional range (how far your wireless signals travel) depends on WLAN implementation, router manufacturer, and interference from other electronic devices or structural barriers such as walls and floors.

---

## Using HP Mobile Broadband (select products only)

Your HP Mobile Broadband computer has built-in support for mobile broadband service. Your new computer, when used with a mobile operator's network, gives you the freedom to connect to the Internet, send e-mail, or connect to your corporate network without the need for Wi-Fi hotspots.



---

**NOTE:** If your computer includes HP Mobile Connect, these instructions do not apply. See [Using HP Mobile Connect \(select products only\) on page 22](#).

---

You may need the HP Mobile Broadband Module serial number to activate mobile broadband service. The serial number is printed on a label inside the battery bay, under the removable service door, or on the back of the display.

Some mobile network operators require the use of a SIM card. A SIM card contains basic information about you, such as a personal identification number (PIN), as well as network information. Some computers include a SIM card that is preinstalled. If the SIM card is not preinstalled, it may be provided in the HP Mobile Broadband information provided with your computer or the mobile network operator may provide it separately from the computer.

Before you can use the mobile broadband capability of your computer, you must complete the following steps:

1. Activate mobile broadband data service. To do this, use a compatible activated SIM card from your service provider.
2. With the computer off, insert the activated SIM card into the SIM slot of the computer. See [Inserting and removing a SIM card on page 21](#).
3. Turn on your computer and wait for Windows to load completely.
4. Set up a mobile broadband connection using the HP Connection Manager software or the built-in Windows connection management software.

To learn more about the benefits of your HP Mobile Broadband computer, see the HP website at <http://www.hp.com/go/mobilebroadband>.

## Inserting and removing a SIM card

---

 **CAUTION:** To prevent damage to the connectors, use minimal force when inserting a SIM card.

---

To insert a SIM card, follow these steps:

1. Shut down the computer.
2. Close the display.
3. Disconnect all external devices connected to the computer.
4. Unplug the power cord from the AC outlet.

5. Insert the SIM card into the SIM slot, and gently push the SIM card into the slot until it is firmly seated.

 **NOTE:** See the image on the computer to determine which way the SIM card should be inserted into your computer.

 **NOTE:** The SIM card in your computer may look slightly different from the illustration in this section.

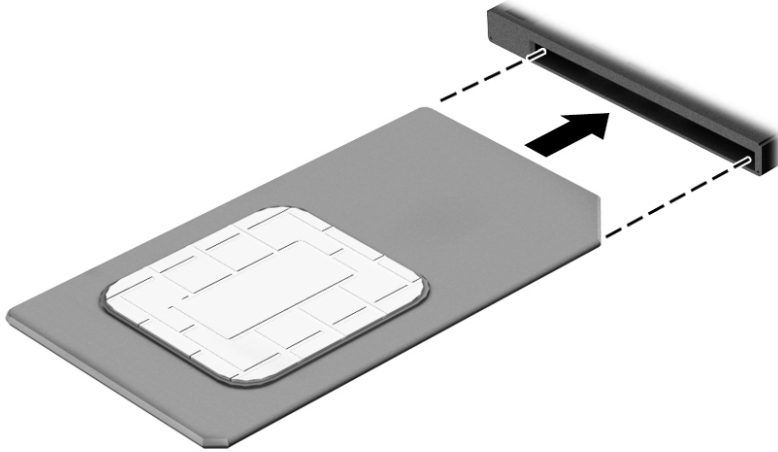

6. Reconnect external power.
7. Reconnect external devices.
8. Turn on the computer.

To remove a SIM card, press in on the SIM card, and then remove it from the slot.

## Using HP Mobile Connect (select products only)

HP Mobile Connect is a prepaid, mobile broadband service that provides a cost-effective, secure, simple, and flexible mobile broadband connection for your computer. To use HP Mobile Connect, your computer must have a SIM and the **HP Mobile Connect** app. For more information about HP Mobile Connect and where it is available, go to <http://www.hp.com/go/mobileconnect>.

## Using GPS (select products only)

Your computer may be equipped with a Global Positioning System (GPS) device. GPS satellites deliver location, speed, and direction information to GPS-equipped systems.

For more information, see the HP GPS and Location software Help.

## Using Bluetooth wireless devices

A Bluetooth device provides short-range wireless communications that replace the physical cable connections that traditionally link electronic devices such as the following:

- Computers (desktop, notebook, PDA)
- Phones (cellular, cordless, smart phone)
- Imaging devices (printer, camera)
- Audio devices (headset, speakers)
- Mouse



Bluetooth devices provide peer-to-peer capability that allows you to set up a personal area network (PAN) of Bluetooth devices. For information about configuring and using Bluetooth devices, see the Bluetooth software Help.

## Connecting to a wired network

There are 2 kinds of wired connections: local area network (LAN) and modem connection. A LAN connection uses a network cable and is much faster than a modem, which uses a telephone cable. Both cables are sold separately.

---

**⚠ WARNING!** To reduce the risk of electric shock, fire, or damage to the equipment, do not plug a modem cable or telephone cable into an RJ-45 (network) jack.

---

### Connecting to a local area network (LAN)

Use a LAN connection if you want to connect the computer directly to a router in your home (instead of working wirelessly), or if you want to connect to an existing network at your office.

Connecting to a LAN requires an 8-pin, RJ-45 network cable.

To connect the network cable, follow these steps:

1. Plug the network cable into the network jack **(1)** on the computer.
2. Plug the other end of the network cable into a network wall jack **(2)** or router.

---

**📝 NOTE:** If the network cable contains noise suppression circuitry **(3)**, which prevents interference from TV and radio reception, orient the circuitry end of the cable toward the computer.

---

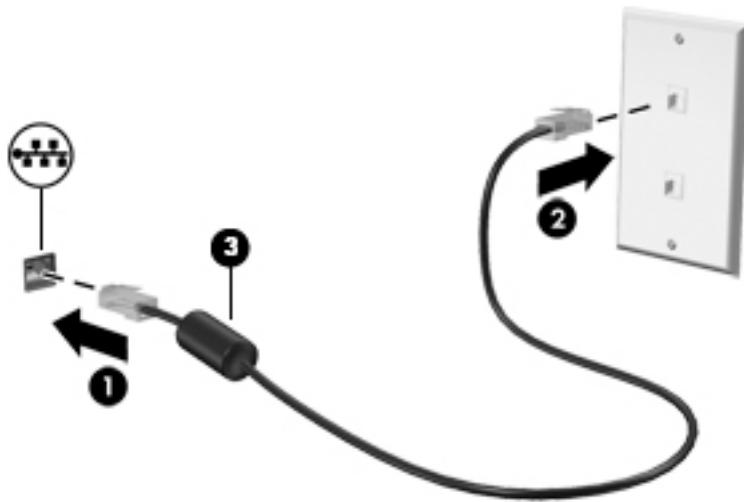

---

## 4 Navigating using the keyboard, touch gestures and pointing devices

Your computer allows navigation using touch gestures (select products only) in addition to the keyboard and mouse. Touch gestures can be used on your computer TouchPad or on a touch screen (select products only).

Select computer models have special action key or hot key functions on the keyboard to perform routine tasks.

### Using pointing devices

---

 **NOTE:** In addition to the pointing devices included with your computer, you can use an external USB mouse (purchased separately) by connecting it to one of the USB ports on the computer.

---

### Setting pointing device preferences

Use Mouse Properties in Windows to customize settings for pointing devices, such as button configuration, click speed, and pointer options. You can also view demonstrations of TouchPad gestures.

To access Mouse Properties:

- Select **Start > Devices and Printers**. Then right-click the device representing your computer, and select **Mouse settings**.

### Using the pointing stick

Press the pointing stick in the direction you want to move the pointer on the screen. Use the left and right pointing stick buttons as you would the left and right buttons on an external mouse.

### Using the TouchPad and gestures

The TouchPad allows you to navigate the computer screen and control the pointer by using simple finger movements.

---

 **TIP:** Use the left and right buttons on the TouchPad as you would use the corresponding buttons on an external mouse.

 **NOTE:** TouchPad gestures are not supported in all apps.

---

## Tapping

To make an on-screen selection, use the Tap function on the TouchPad.

- Tap one finger on the TouchPad zone to make a selection. Double-tap an item to open it.



## Scrolling

Scrolling is useful for moving up, down, or sideways on a page or image.

- Place two fingers slightly apart on the TouchPad zone and then drag them up, down, left, or right.

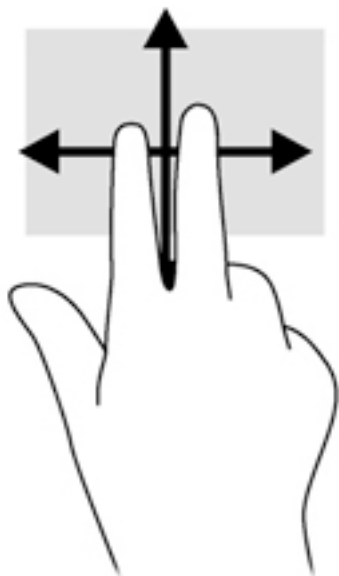

## 2-finger pinch zoom

2-finger pinch zoom allows you to zoom out or in on images or text.

- Zoom in by placing two fingers together on the TouchPad zone and then moving your fingers apart.
- Zoom out by placing two fingers apart on the TouchPad zone and then moving your fingers together.

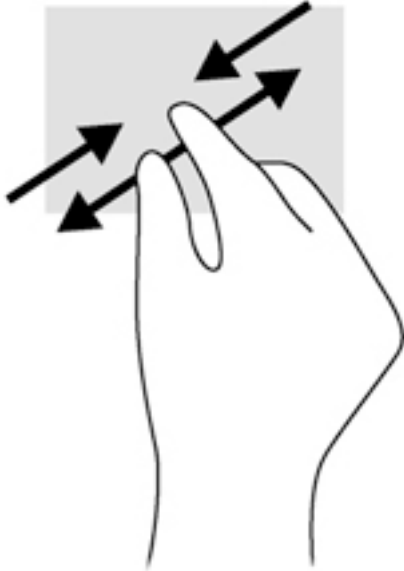

## 2-finger click

2-finger click allows you to make menu selections for an object on the screen.

---

 **NOTE:** Using 2-finger click is the same action as using right-click with the mouse.

---

- Place two fingers on the TouchPad zone and press to open the options menu for the selected object.

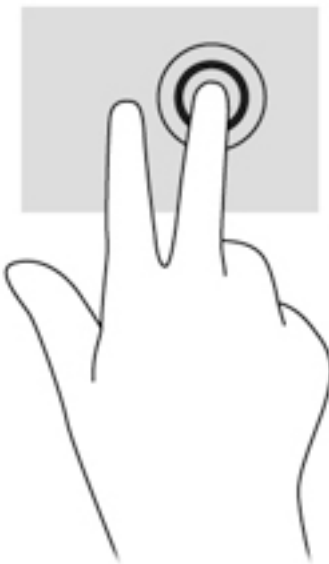

## Rotating (select products only)

Rotating allows you to turn items such as photos.

- Anchor the forefinger of your left hand in the TouchPad zone. Using your right hand, slide your forefinger in a sweeping motion from 12 o'clock to 3 o'clock. To reverse the rotation, move your forefinger from 3 o'clock to 12 o'clock.

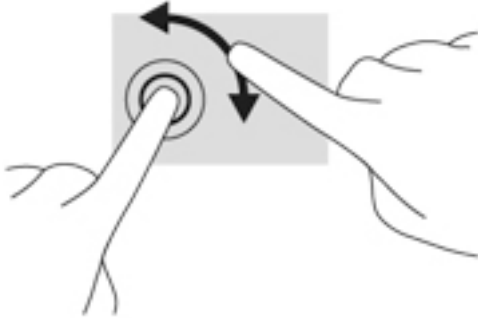

## Flicking (select products only)

Flicking allows you to navigate through screens or quickly scroll through documents.

- Place three fingers on the TouchPad zone and flick your fingers in a light, quick motion up, down, left or right.

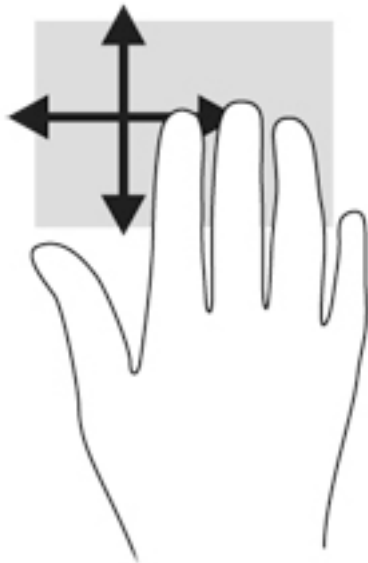

## Using the keyboard





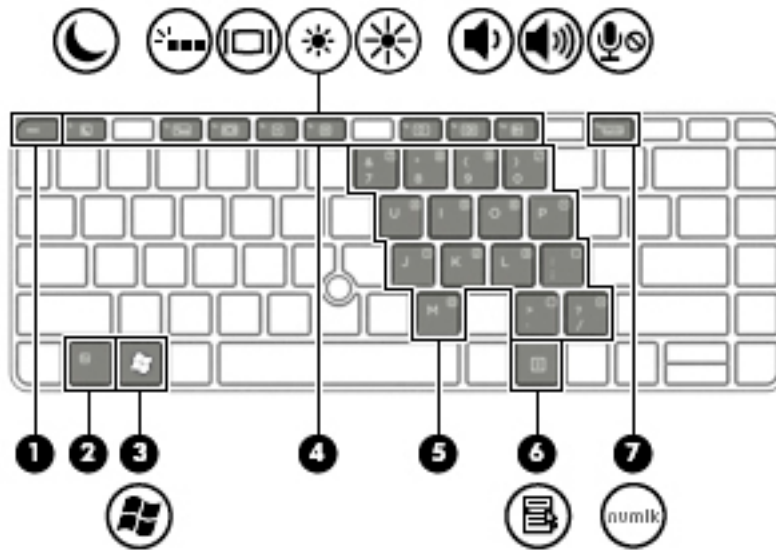

The keyboard and mouse allow you to type select items, scroll and to perform the same functions as using touch gestures. The keyboard also allows you to use action keys and hot keys to perform specific functions.

 **NOTE:** Depending on the country or region, your keyboard may have different keys and keyboard functions than those discussed in this section.

## Identifying the hot keys



- ▲ Briefly press the **fn** key, and then briefly press the second key of the hot key combination.

Press <b>fn</b> +function key	Description
	Initiates Sleep, which saves your information in system memory. The display and other system components turn off and power is conserved. To exit Sleep, briefly press the power button. <b>CAUTION:</b> To reduce the risk of information loss, save your work before initiating Sleep.
	Turns the keyboard backlight off or on. <b>NOTE:</b> To conserve battery power, turn off this feature.
	Decreases the screen brightness incrementally as long as you hold down the key.
	Increases the screen brightness incrementally as long as you hold down the key.
	Decreases speaker volume incrementally while you hold down the key.
	Increases speaker volume incrementally while you hold down the key.
	Mutes the microphone.

## Using keypads

The computer includes an embedded numeric keypad or an integrated numeric keypad, and it also supports an optional external numeric keypad, or an optional external keyboard that includes a numeric keypad.

## Using the embedded numeric keypad (select products only)

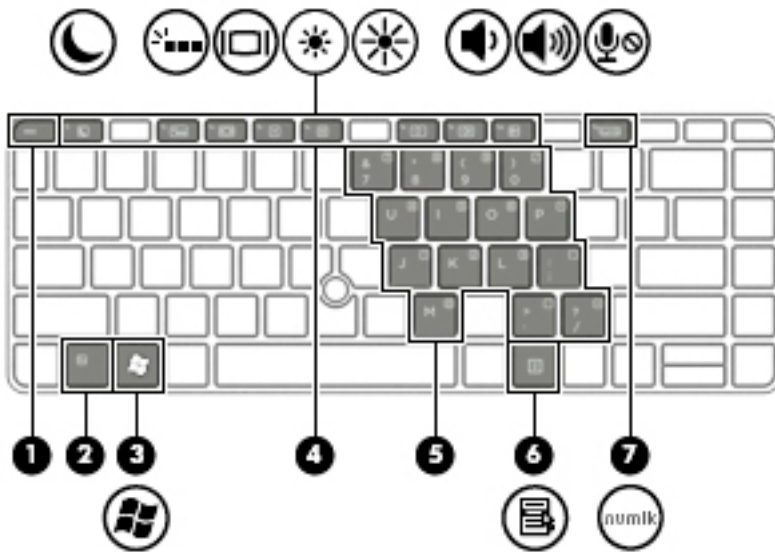

Component	Description
<p>(2) <b>fn</b> key</p>	<p>Turns the embedded numeric keypad on and off when pressed in combination with the <b>num lk</b> key.</p> <p><b>NOTE:</b> The embedded numeric keypad will not function while an external keyboard or numeric keypad is connected to the computer.</p>
<p>(5) Embedded numeric keypad</p>	<p>When the keypad is turned on, it can be used like an external numeric keypad.</p> <p>Each key on the keypad performs the function indicated by the icon in the upper-right corner of the key.</p>
<p>(7) <b>num lk</b> key</p>	<p>Turns the embedded numeric keypad on and off when pressed in combination with the <b>fn</b> key.</p> <p><b>NOTE:</b> The keypad function that is active when the computer is turned off is reinstated when the computer is turned back on.</p>

## Turning the embedded numeric keypad on and off

Press **fn+num lk** to turn on the embedded numeric keypad. Press **fn+num lk** again to turn off the keypad.

 **NOTE:** The embedded numeric keypad is turned off while an external keyboard or numeric keypad is connected to the computer.

## Switching key functions on the embedded numeric keypad

You can temporarily alternate the functions of keys on the embedded numeric keypad between their standard keyboard functions and their keypad functions:

- To use the navigational function of a keypad key while the keypad is off, press and hold the **fn** key while pressing the keypad key.
- To use the standard function of a keypad key while the keypad is on:
  - Press and hold the **fn** key to type in lowercase.
  - Press and hold **fn+shift** to type in uppercase.

## Using the integrated numeric keypad (select products only)

The computer includes an integrated numeric keypad, and it also supports an optional external numeric keypad or an optional external keyboard that includes a numeric keypad. For more details about the integrated numeric keypad, see [Keys on page 12](#).

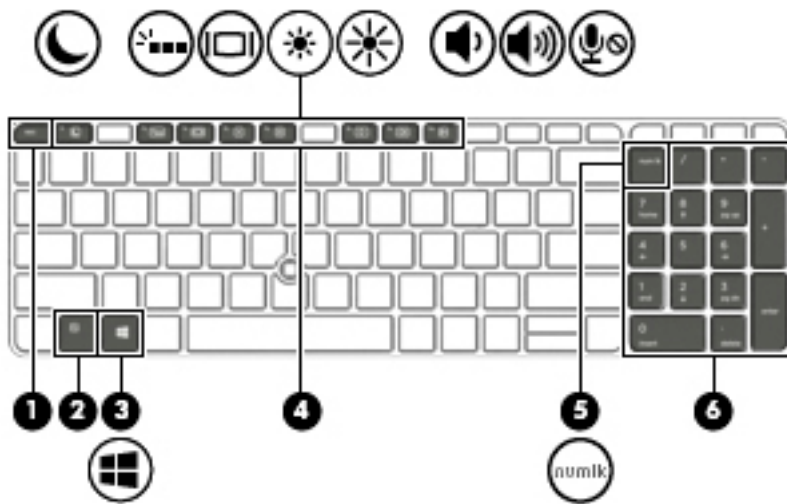

Component	Description
(5) num lk key	Alternates between the navigational and numeric functions on the integrated numeric keypad. <b>NOTE:</b> The keypad function that is active when the computer is turned off is reinstated when the computer is turned back on.
(6) Integrated numeric keypad	When num lk has been enabled, it can be used like an external numeric keypad.



## Using an optional external numeric keypad

Keys on most external numeric keypads function differently according to whether num lock is on or off. (Num lock is turned off at the factory.) For example:

- When num lock is on, most keypad keys type numbers.
- When num lock is off, most keypad keys function like the arrow, page up, or page down keys.

When num lock on an external keypad is turned on, the num lock light on the computer is turned on. When num lock on an external keypad is turned off, the num lock light on the computer is turned off.

To turn num lock on or off on an external keypad as you work:

- ▲ Press the **num lk** key on the external keypad, not on the computer.

---

## 5 Multimedia

Your computer may include the following:

- Integrated speaker(s)
- Integrated microphone(s)
- Integrated webcam (select products only)
- Preinstalled multimedia software

### Audio

On your HP computer, you can play music CDs, download and listen to music, stream audio content from the web (including radio), record audio, or mix audio and video to create multimedia. To enhance your listening enjoyment, attach external audio devices such as speakers or headphones.

### Connecting speakers

You can attach wired speakers to your computer by connecting them to a USB port (or the audio-out jack) on your computer or on a docking station.

To connect wireless speakers to your computer, follow the device manufacturer's instructions. Before connecting audio devices, be sure to adjust the volume.

### Adjusting the volume

Depending on your computer model, you can adjust the volume using the following:

- Volume buttons
- Volume hot keys (specific keys pressed in combination with the **fn** key)
- Volume keys

---

 **WARNING!** To reduce the risk of personal injury, adjust the volume before putting on headphones, earbuds, or a headset. For additional safety information, see the *Regulatory, Safety and Environmental Notices*. To access the user guides, select **Start > All Programs > HP Help and Support > HP Documentation**.

 **NOTE:** Volume can also be controlled through the operating system and some programs.

 **NOTE:** See [Getting to know your computer on page 3](#) for information on what type of volume controls your computer has.

---

### Connecting headphones

You can connect wired headphones to the headphone jack on your computer.

To connect wireless headphones to your computer, follow the device manufacturer's instructions.

---

 **WARNING!** To reduce the risk of personal injury, lower the volume setting before putting on headphones, earbuds, or a headset. For additional safety information, see the *Regulatory, Safety and Environmental Notices*.

---

## Connecting a microphone

To record audio, connect a microphone to the microphone jack on the computer. For best results when recording, speak directly into the microphone and record sound in a setting free of background noise.

## Connecting headphones and microphones

You can connect wired headphones or headsets to the audio-out (headphone)/audio-in (microphone) jack on your computer. Many headsets with integrated microphones are commercially available.

To connect *wireless* headphones or headsets to your computer, follow the device manufacturer's instructions.

 **WARNING!** To reduce the risk of personal injury, lower the volume setting before putting on headphones, earbuds, or a headset. For additional safety information, see the *Regulatory, Safety and Environmental Notices*. To access this guide, select **Start > All Programs > HP Help and Support > HP Documentation**.

## Checking audio functions on the computer

 **NOTE:** For best results when recording, speak directly into the microphone and record sound in a setting free of background noise.

To check the audio functions on your computer, follow these steps:

1. Select **Start > Control Panel > Hardware and Sound > Sound**.
2. When the Sound window opens, click the **Sounds** tab. Under **Program Events**, select any sound event, such as a beep or alarm, and click the **Test** button.

You should hear sound through the speakers or through connected headphones.

To check the recording functions on your computer, follow these steps:

1. Select **Start > All Programs > Accessories > Sound Recorder**.
2. Click **Start Recording** and speak into the microphone.
3. Save the file to your desktop.
4. Open a multimedia program and play back the sound.

To confirm or change the audio settings on your computer:

- ▲ Select **Start > Control Panel > Audio**.

## Webcam (select products only)

Some computers include an integrated webcam. With the preinstalled software, you can use the webcam to take a photo or record a video. You can preview and save the photo or video recording.

The webcam software enables you to experiment with the following features:

- Capturing and sharing video
- Streaming video with instant message software
- Taking still photos

## Video

Your HP computer is a powerful video device that enables you to watch streaming video from your favorite websites and download video and movies to watch on your computer without needing to connect to a network.

To enhance your viewing enjoyment, use one of the video ports on the computer to connect an external monitor, projector, or TV. Your computer may have an high-definition multimedia interface (HDMI) port, which allows you to connect a high-definition monitor or TV.

Your computer may have one or more of the following external video ports:

- VGA
- Dual-Mode DisplayPort

---

 **IMPORTANT:** Be sure that the external device is connected to the correct port on the computer, using the correct cable. Check the device manufacturer's instructions if you have questions.

 **NOTE:** See [Getting to know your computer on page 3](#) for information about your computer's video ports.

---

## VGA

The external monitor port, or VGA port, is an analog display interface that connects an external VGA display device such as an external VGA monitor or a VGA projector to the computer.

1. To connect a VGA display device, connect the device cable to the external monitor port.

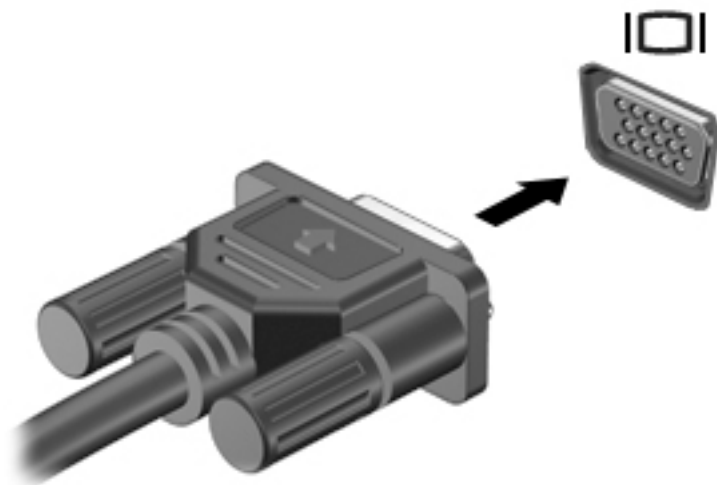

2. Press **fn+f4** to alternate the screen image between 4 display states:

- **PC Screen only:** View the screen image on the computer only.
- **Duplicate:** View the screen image simultaneously on *both* the computer and the external device.
- **Extend:** View the screen image extended across *both* the computer and the external device.
- **Second screen only:** View the screen image on the external device only.

Each time you press **fn+f4**, the display state changes.

---

 **NOTE:** For best results, especially if you choose the "Extend" option, adjust the screen resolution of the external device, as follows. Select **Start > Control Panel > Appearance and Personalization**. Under **Display**, select **Adjust screen resolution**.

---

## Dual-Mode DisplayPort

The Dual-Mode DisplayPort connects the computer to an optional video or audio device, such as a high-definition television, or to any compatible digital or audio component. The Dual-Mode DisplayPort delivers higher performance than the VGA external monitor port and improves digital connectivity.

---

 **NOTE:** To transmit video and/or audio signals through the Dual-Mode DisplayPort, you need a Dual-Mode DisplayPort cable (purchased separately).

 **NOTE:** One Dual-Mode DisplayPort device can be connected to the Dual-Mode DisplayPort port on the computer. The information displayed on the computer screen can be simultaneously displayed on the Dual-Mode DisplayPort device.

---

To connect a video or audio device to the Dual-Mode DisplayPort:

1. Connect one end of the Dual-Mode DisplayPort cable to the Dual-Mode DisplayPort port on the computer.

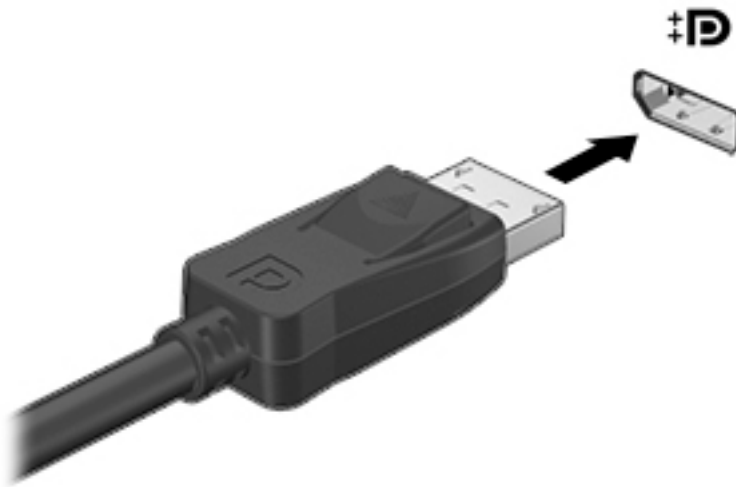

2. Connect the other end of the cable to the digital display device.
3. Press **fn+f4** to alternate the computer screen image between 4 display states:
  - **PC screen only:** View the screen image on the computer only.
  - **Duplicate:** View the screen image simultaneously on *both* the computer and the external device.
  - **Extend:** View the screen image extended across *both* the computer and the external device.
  - **Second screen only:** View the screen image on the external device only.

Each time you press **fn+f4**, the display state changes.

---

 **NOTE:** For best results, especially if you choose the "Extend" option, adjust the screen resolution of the external device, as follows. Select **Start > Control Panel > Appearance and Personalization**. Under **Display**, select **Adjust screen resolution**.

---

 **NOTE:** To remove the device cable, press down on the connector release button to disconnect it on the computer.

---

## Intel Wireless Display (select products only)

Intel® Wireless Display allows you to share your computer content wirelessly on your TV. To experience wireless display, a wireless TV adapter (purchased separately) is required. DVDs that have output protection

may not play on Intel Wireless Display. (However, DVDs that do not have output protect will play.) Blu-ray discs, which have output protection, will not play on Intel Wireless Display. For details about using the wireless TV adapter, see the manufacturer's instructions.

---

 **NOTE:** Be sure that wireless is enabled on your computer before using the wireless display.

---

## Discovering and connecting wired displays using MultiStream Transport

MultiStream Transport (MST) allows you to connect multiple wired display devices to your computer by connecting to the VGA or DisplayPorts on your computer and also to the VGA or DisplayPorts on an external hub or docking station. You can connect in several ways, depending on the type of graphics controller installed on your computer and whether or not your computer includes a built-in hub. Go to Device Manager to find out what hardware is installed on your computer.

1. Select **Start > Control Panel**.
2. Select **System and Security**, select **System**, and then click **Device Manager** in the left column.

### Connect displays to computers with AMD graphics (with an optional hub)

---

 **NOTE:** With an AMD graphics controller and optional hub, you can connect up to 3 external display devices.

 **NOTE:** With an Nvidia graphics controller and optional hub, you can connect up to 3 external display devices.

---

To set up multiple displays, follow these steps:

1. Connect an external hub (purchased separately) to the DisplayPort on your computer, using a DP-to-DP cable (purchased separately). Be sure that the hub power adapter is connected to AC power.
2. Connect your external display devices to the VGA ports or DisplayPorts on the hub.
3. For details on how to set up multiple displays, press **fn+f4**. If you don't see one of your connected displays, be sure that each device is connected to the correct port on the hub.

---

 **NOTE:** Multiple display choices include **Duplicate**, which mirrors your computer screen on all enabled displays, or **Extend**, which spans your computer screen across all enabled displays.

---

### Connect displays to computers with Intel graphics (with an optional hub)

---

 **NOTE:** With an Intel graphics controller and optional hub, you can connect up to 3 display devices.

---

To set up multiple display devices, follow these steps:

1. Connect an external hub (purchased separately) to the DisplayPort on your computer, using a DP-to-DP cable (purchased separately). Be sure that the hub power adapter is connected to AC power.
2. Connect your external display devices to the VGA ports or DisplayPorts on the hub.
3. When Windows detects a monitor connected to the DP hub, the **DisplayPort Topology Notification** dialog box is displayed. Click the appropriate options to configure your displays. Multiple display choices include **Duplicate**, which mirrors your computer screen on all enabled display devices, or **Extend**, which extends the screen image across all enabled display devices.

---

 **NOTE:** If this dialog box does not appear, be sure that each external display device is connected to the correct port on the hub. For more information, press **fn+f4** and then follow the on-screen instructions.

---

### Connect displays to computers with Intel graphics (with a built-in hub)

With your internal hub and Intel graphics controller, you can connect up to 3 display devices in the following configurations:

- Two 1920 x 1200 DP monitors connected to the computer + one 1920 x 1200 VGA monitor connected to an optional docking station
- One 2560 x 1600 DP monitor connected to the computer + one 1920 x 1200 VGA monitor connected to an optional docking station

To set up multiple display devices, follow these steps:

1. Connect your external display devices to the VGA ports or DisplayPorts (DP) on the computer base or the docking station.
2. When Windows detects a monitor connected to the DP hub, the **DisplayPort Topology Notification** dialog box is displayed. Click the appropriate options to configure your displays. Multiple display choices include **Duplicate**, which mirrors your computer screen on all enabled display devices, or **Extend**, which extends the screen image across all enabled display devices.



**NOTE:** If this dialog box does not appear, be sure that each external display device is connected to the correct port on the hub. For more information, press [fn+f4](#) and then follow the on-screen instructions.

---

---

## 6 Power management

 **NOTE:** A computer may have a power button or a power switch. The term *power button* is used throughout this guide to mean both types of power controls.

---

### Shutting down (turning off) the computer

 **CAUTION:** Unsaved information is lost when the computer shuts down.

---

The shutdown command closes all open programs, including the operating system, and then turns off the display and computer.

Shut down the computer under any of the following conditions:

- When you need to replace the battery or access components inside the computer
- When you are connecting an external hardware device that does not connect to a Universal Serial Bus (USB) port
- When the computer will be unused and disconnected from external power for an extended period

Although you can turn off the computer with the power button, the recommended procedure is to use the Windows shutdown command:

 **NOTE:** If the computer is in the Sleep state or in Hibernation, you must first exit Sleep or Hibernation before shutdown is possible by briefly pressing the power button.

---

1. Save your work and close all open programs.
2. Select **Start > Shut Down**.

If the computer is unresponsive and you are unable to use the preceding shutdown procedure, try the following emergency procedures in the sequence provided:

- Press **ctrl+alt+delete**. Select the **Power** icon, and then select **Shut Down**.
- Press and hold the power button for at least 5 seconds.
- Disconnect the computer from external power.
- Remove the battery.

### Setting power options

 **CAUTION:** Several well-known vulnerabilities exist when a computer is in the Sleep state. To prevent an unauthorized user from accessing data on your computer, even encrypted data, HP recommends that you always initiate Hibernation instead of Sleep anytime the computer will be out of your physical possession. This practice is particularly important when you travel with your computer.

---

### Using power-saving states

Sleep is enabled at the factory. When Sleep is initiated, the power lights blink and the screen clears. Your work is saved to memory.



---

 **CAUTION:** To reduce the risk of possible audio and video degradation, loss of audio or video playback functionality, or loss of information, do not initiate Sleep while reading from or writing to a disc or an external memory card.

 **NOTE:** You cannot initiate any type of networking connection or perform any computer functions while the computer is in the Sleep state.

---

## Initiating and exiting Sleep

With the computer on, you can initiate Sleep in any of the following ways:

- Briefly press the power button.
- Close the display.
- Select **Start**, select the arrow next to the Shut down button, and then select **Sleep**.

To exit Sleep:

- Briefly press the power button.
- If the display is closed, open the display.
- Press a key on the keyboard.
- Tap or swipe the TouchPad

When the computer exits Sleep, the power lights turn on and the computer returns to the screen where you stopped working.

---

 **NOTE:** If you have set a password to be required on wakeup, you must enter your Windows password before the computer will return to the screen.

---

## Initiating and exiting Hibernation

The system is set at the factory to initiate Hibernation after a period of inactivity when running on battery power or on external power, or when the battery reaches a critical battery level.

Power settings and timeouts can be changed in Windows Control Panel.

To initiate Hibernation:

- ▲ Select **Start**, select the arrow next to the Shut down button, and then select **Hibernate**.

To exit Hibernation:

- ▲ Briefly press the power button.

The power lights turn on and your work returns to the screen where you stopped working.

---

 **NOTE:** If you have set a password to be required on wakeup, you must enter your Windows password before your work will return to the screen.

---

## Using the power meter and power settings

The power meter is located in the notification area, at the far right of the taskbar. The power meter allows you to quickly access power settings and view the remaining battery charge.

- To reveal the percentage of remaining battery charge and the current power plan, point over the power meter icon.
- To use Power Options, or to change the power plan, select the power meter icon and select an item from the list.

Different power meter icons indicate whether the computer is running on battery or external power. The icon also reveals a message if the battery has reached a low or critical battery level.

## Setting password protection on wakeup

To set the computer to prompt for a password when the computer exits Sleep or Hibernation, follow these steps:

1. Select **Start > Control Panel > System and Security > Power Options**.
2. In the left pane, select **Require a password on wakeup**.
3. Select **Change Settings that are currently unavailable**.
4. Select **Require a password (recommended)**.

---

 **NOTE:** If you need to create a user account password or change your current user account password, select **Create or change your user account password**, and then follow the on-screen instructions. If you do not need to create or change a user account password, go to step 5.

---

5. Select **Save changes**.

## Using battery power

---

 **WARNING!** To reduce potential safety issues, use only the battery provided with the computer, a replacement battery provided by HP, or a compatible battery purchased from HP.

---

The computer runs on battery power whenever it is not plugged into external AC power. Computer battery life varies, depending on power management settings, running programs, display brightness, external devices connected to the computer, and other factors. Keeping the battery in the computer whenever the computer is plugged into AC power charges the battery and also protects your work in case of a power outage. If the computer contains a charged battery and is running on external AC power, the computer automatically switches to battery power if the AC adapter is disconnected on the computer or an AC power loss occurs.

---

 **NOTE:** When you disconnect AC power, the display brightness is automatically decreased to save battery life. Select computer products can switch between graphic modes to increase battery life.

---

## Using HP Battery Check

To monitor the status of your battery, or if the battery is no longer holding a charge, run HP Battery Check in HP Support Assistant. If HP Battery Check indicates that your battery should be replaced, contact support.

To run HP Battery Check:

1. Connect the AC adapter to the computer.

---

 **NOTE:** The computer must be connected to external power for HP Battery Check to work properly.

---

2. Select **Start > All Programs > HP Help and Support > HP Support Assistant**.

– or –

Select the question mark icon in the taskbar.

3. Select **My PC**, select the **Diagnostics and Tools** tab, and then select **HP Battery Check**.

HP Battery Check examines the battery and its cells to see if they are functioning properly, and then reports the results of the examination.

## Displaying the remaining battery charge

- ▲ Move the pointer over the power meter icon on the Windows desktop in the notification area, at the far right of the taskbar.

## Maximizing battery discharge time

Battery discharge time varies depending on features you use while on battery power. Maximum discharge time gradually decreases as the battery storage capacity naturally degrades.

Tips for maximizing battery discharge time:

- Lower the brightness on the display.
- Select the **Power saver** setting in Power Options.
- Remove a user-replaceable battery when the computer is not being used for longer than 2 weeks.
- Store a user-replaceable battery in a cool, dry location.

## Managing low battery levels

The information in this section describes the alerts and system responses set at the factory. Some low-battery alerts and system responses can be changed using Power Options. Preferences set using Power Options do not affect lights.

### Identifying low battery levels

When a battery that is the sole power source for the computer reaches a low or critical battery level, the following behavior occurs:

- The battery light (select products only) indicates a low or critical battery level.

– or –

- The power meter icon in the notification area shows a low or critical battery notification.

If the computer is on or in the Sleep state, the computer remains briefly in the Sleep state, and then shuts down and loses any unsaved information.

### Resolving a low battery level

#### Resolving a low battery level when external power is available

- ▲ Connect one of the following devices:
  - AC adapter
  - Optional docking or expansion device
  - Optional power adapter purchased as an accessory from HP

#### Resolving a low battery level when no power source is available

To resolve a low battery level when no power source is available, save your work and shut down the computer.

## Removing the battery

To remove the battery:

**⚠ CAUTION:** Removing a battery that is the sole power source for the computer can cause loss of information. To prevent loss of information, save your work and shut down the computer through Windows before removing the battery.

1. Turn the computer upside down on a flat surface.
2. Remove 8 Phillips screws **(1)**, and then lift the back cover **(2)** to remove it.

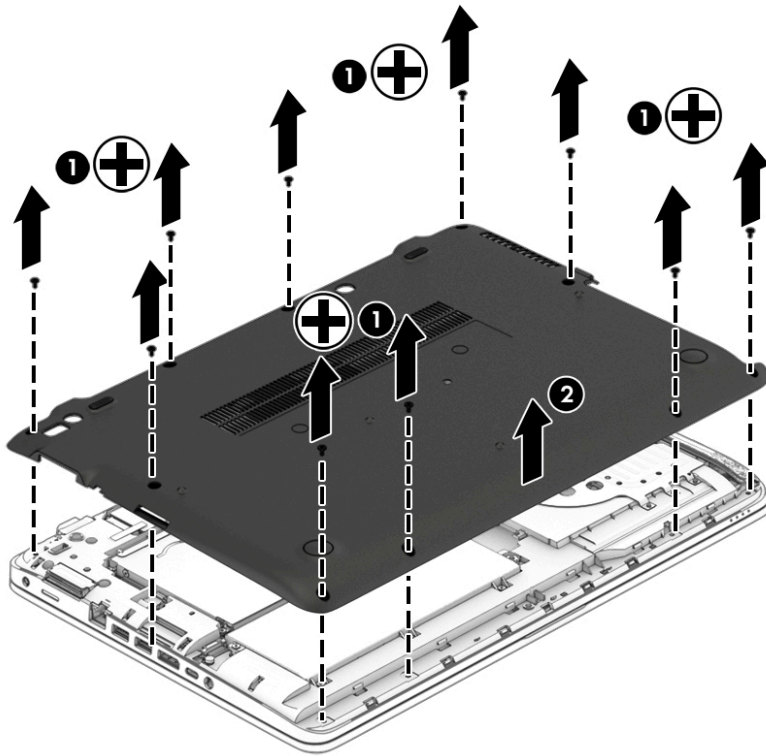

3. Loosen 6 captive screws (1), and then lift the battery (2) to remove it.

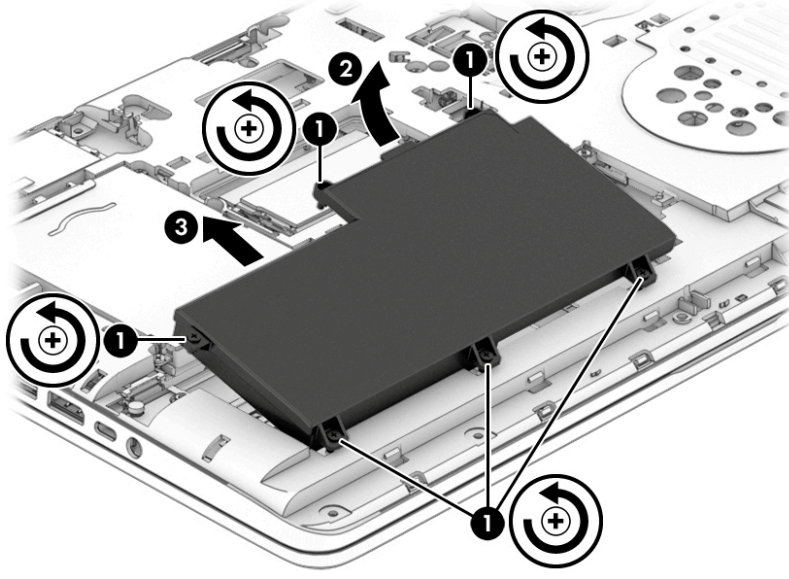

To replace the battery, reverse these steps.

### Conserving battery power

- Select low power-use settings through Power Options in Windows Control Panel.
- Turn off wireless and LAN connections and exit modem applications when you are not using them.
- Disconnect unused external devices that are not plugged into an external power source.
- Stop, disable, or remove any external memory cards that you are not using.
- Decrease screen brightness.
- Before you leave your work, initiate Sleep, or shut down the computer.

### Disposing of a user-replaceable battery

**⚠ WARNING!** To reduce the risk of fire or burns, do not disassemble, crush, or puncture; do not short external contacts; do not dispose of in fire or water.

See the *Regulatory, Safety and Environmental Notices* for proper battery disposal. To access the user guides, select the **Start > All Programs > HP Help and Support > HP Documentation**.

### Replacing a battery

HP Battery Check notifies you to replace the battery when an internal cell is not charging properly or when the battery storage capacity has reached a weak condition. If the battery is possibly covered by an HP warranty, instructions include a warranty ID. A message refers you to the HP website for more information about ordering a replacement battery.

### Using external AC power

**⚠ WARNING!** Do not charge the computer battery while you are onboard aircraft.

**⚠ WARNING!** To reduce potential safety issues, use only the AC adapter provided with the computer, a replacement AC adapter provided by HP, or a compatible AC adapter purchased from HP.

 **NOTE:** For information on connecting to AC power, see the *Setup Instructions* poster provided in the computer box.

---

External AC power is supplied through an approved AC adapter or an optional docking or expansion device.

Connect the computer to external AC power under any of the following conditions:

- When charging or calibrating a battery
- When installing or modifying system software
- When writing information to a CD, a DVD, or a BD (select products only)
- When running Disk Defragmenter
- When performing a backup or recovery

When you connect the computer to external AC power, the following events occur:

- The battery begins to charge.
- If the computer is turned on, the power meter icon in the notification area changes appearance.

When you disconnect external AC power, the following events occur:

- The computer switches to battery power.
- The display brightness is automatically decreased to save battery life.

## Testing an AC adapter

Test the AC adapter if the computer exhibits any of the following symptoms when it is connected to AC power:

- The computer does not turn on.
- The display does not turn on.
- The power lights are off.

To test the AC adapter:

 **NOTE:** The following instructions apply to computers with user-replaceable batteries.

---

1. Shut down the computer.
2. Remove the battery on the computer.
3. Connect the AC adapter to the computer, and then plug it into an AC outlet.
4. Turn on the computer.
  - If the power lights turn *on*, the AC adapter is working properly.
  - If the power lights remain *off*, the AC adapter is not functioning and should be replaced.

Contact support for information on obtaining a replacement AC power adapter.

---

# 7 External cards and devices

## Using memory card readers (select products only)

Optional memory cards provide secure data storage and convenient data sharing. These cards are often used with digital media–equipped cameras and PDAs as well as with other computers.

To determine the memory card formats that are supported on your computer, see [Getting to know your computer on page 3](#).

### Inserting a memory card

---

**⚠ CAUTION:** To reduce the risk of damage to the memory card connectors, use minimal force to insert a memory card.

---

1. Hold the card label-side up, with the connectors facing the computer.
2. Insert the card into the memory card reader, and then press in on the card until it is firmly seated.

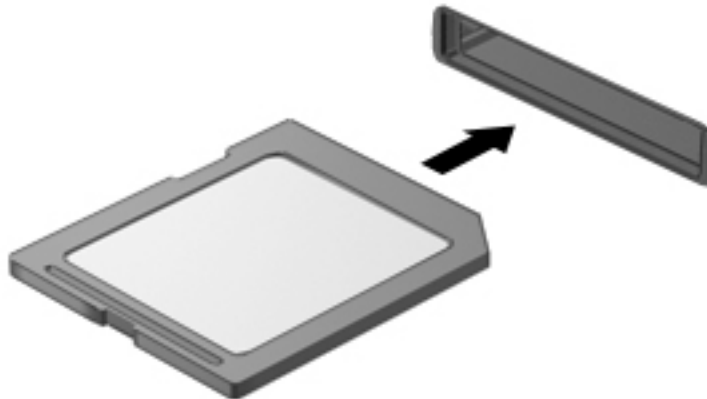

You will hear a sound when the device has been detected, and a menu of options may be displayed.

### Removing a memory card

---

**⚠ CAUTION:** To reduce the risk of loss of data or an unresponsive system, use the following procedure to safely remove the memory card.

---

1. Save your information and close all programs associated with the memory card.
2. Click the remove hardware icon on the Windows desktop in the notification area, at the far right of the taskbar. Then follow the on-screen instructions.

3. Press in on the card **(1)**, and then remove it from the slot **(2)**.

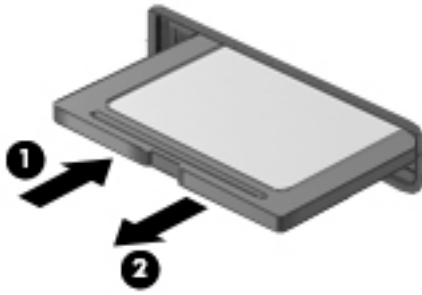

---

 **NOTE:** If the card does not eject, pull the card out of the slot.

---

## Using smart cards (select products only)

 **NOTE:** The term *smart card* is used throughout this chapter to mean both smart cards and Java™ Cards.

A smart card is a credit card-sized accessory that carries a microchip containing memory and a microprocessor. Like personal computers, smart cards have an operating system to manage input and output, and they include security features to protect against tampering. Industry-standard smart cards are used with the smart card reader (select products only).

A PIN is needed to gain access to the contents of the microchip. For more information about smart card security features, access Help and Support by selecting **Start > Help and Support**.



## Inserting a smart card

1. Hold the card label-side up, and gently slide the card into the smart card reader until the card is seated.

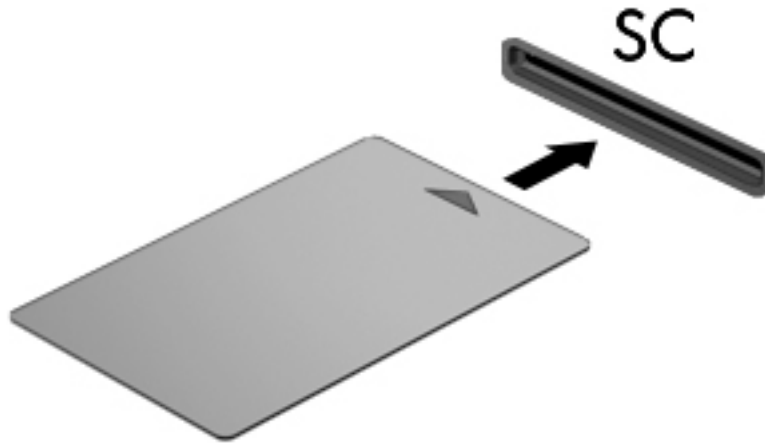

2. Follow the on-screen instructions for logging on to the computer using the smart card PIN.

## Removing a smart card

- ▲ Grasp the edge of the smart card, and then pull it out of the smart card reader.



## Using a USB device

Universal Serial Bus (USB) is a hardware interface that can be used to connect an optional external device, such as a USB keyboard, mouse, drive, printer, scanner, or hub.

Some USB devices may require additional support software, which is usually included with the device. For more information about device-specific software, see the manufacturer's instructions. These instructions may be provided with the software, on disc, or on the manufacturer's website.

The computer has at least 1 USB port that supports USB 1.0, 1.1, 2.0, or 3.0 devices. Your computer may also have a USB charging port that provides power to an external device. An optional docking device or USB hub provides additional USB ports that can be used with the computer.

## Connecting a USB device

---

**CAUTION:** To reduce the risk of damage to a USB connector, use minimal force to connect the device.

---

▲ Connect the USB cable for the device to the USB port.

 **NOTE:** The following illustration may look slightly different than your computer.

---

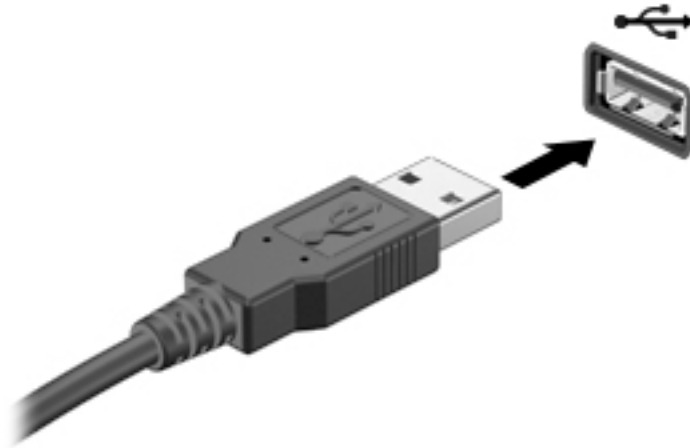

You will hear a sound when the device has been detected.

---

 **NOTE:** The first time you connect a USB device, a message in the notification area lets you know that the device is recognized by the computer.

---

## Removing a USB device

---

**CAUTION:** To reduce the risk of damage to a USB connector, do not pull on the cable to remove the USB device.

**CAUTION:** To reduce the risk of loss of information or an unresponsive system, use the following procedure to safely remove the USB device.

---

1. To remove a USB device, save your information and close all programs associated with the device.
2. Click the remove hardware icon on the Windows desktop in the notification area, at the far right of the taskbar, and then follow the on-screen instructions.
3. Remove the device.

## Using a serial device (select products only)

Select computer models include a serial port that connects optional devices such as a serial modem, mouse, or printer.

Some serial devices may require additional support software, which is usually included with the device. For more information about device-specific software, see the manufacturer's instructions.

To connect a serial device:

1. Turn off the computer.
2. Connect the device cable to the serial port to the computer.

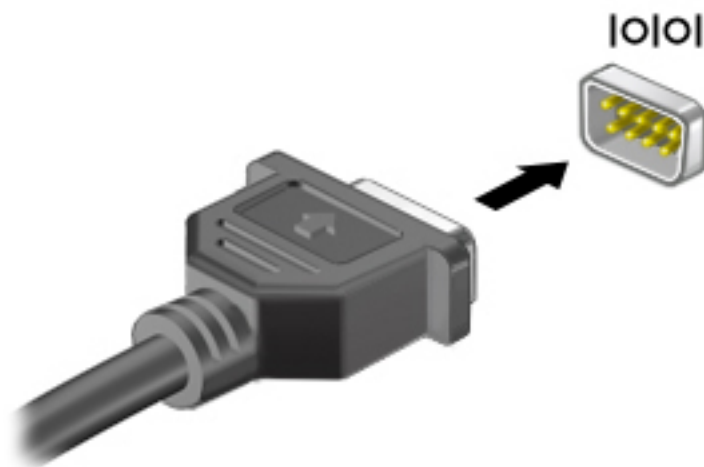

3. Turn on the computer.

## Using optional external devices

 **NOTE:** For more information about required software and drivers, or to learn which computer port to use, see the manufacturer's instructions.

To connect an external device to the computer:

 **CAUTION:** To reduce the risk of damage to the equipment when connecting a powered device, be sure that the device is turned off and the AC power cord is unplugged.

1. Connect the device to the computer.
2. If you are connecting a powered device, plug the device power cord into a grounded AC outlet.
3. Turn on the device.

To disconnect an unpowered external device, turn off the device, and then disconnect it from the computer. To disconnect a powered external device, turn off the device, disconnect it from the computer, and then unplug the AC power cord.

## Using optional external drives

Removable external drives expand your options for storing and accessing information. A USB drive can be added by connecting the drive to a USB port to the computer.



---

**NOTE:** HP external USB optical drives should be connected to the powered USB port to the computer.

---

USB drives include the following types:

- 1.44-megabyte diskette drive
- Hard drive module
- External optical drive (CD, DVD, and Blu-ray)
- MultiBay device

---

# 8 Drives

## Using hard drives

---

 **CAUTION:** To prevent information loss or an unresponsive system:

Save your work and shut down the computer before adding or replacing a memory module or hard drive.

If you are not sure whether the computer is off, turn the computer on by pressing the power button. Then shut down the computer through the operating system.

## Improving hard drive performance

### Using Disk Defragmenter

As you use your computer over time, the files on the hard drive become fragmented. A fragmented drive means data on your drive is not contiguous (sequential) and, because of this, the hard drive works harder to locate files, thus slowing down the computer. Disk Defragmenter consolidates (or physically reorganizes) the fragmented files and folders on the hard drive so that the system can run more efficiently.

---

 **NOTE:** It is not necessary to run Disk Defragmenter on solid-state drives.

After you start Disk Defragmenter, it works without supervision. However, depending on the size of your hard drive and the number of fragmented files, Disk Defragmenter may take more than an hour to complete.

HP recommends defragmenting your hard drive at least once a month. You may set Disk Defragmenter to run on a monthly schedule, but you can defragment your computer manually at any time.

To run Disk Defragmenter:

1. Connect the computer to AC power.
2. Select **Start > All Programs > Accessories > System Tools > Disk Defragmenter**.
3. Click **Defragment disk**.

---

 **NOTE:** Windows includes the User Account Control feature to improve the security of your computer. You may be prompted for your permission or password for tasks such as installing software, running utilities, or changing Windows settings. Refer to Help and Support. To access Help and Support, select **Start > Help and Support**.

For additional information, access the Disk Defragmenter software Help.

### Using Disk Cleanup

Disk Cleanup searches the hard drive for unnecessary files that you can safely delete to free up disk space and help the computer to run more efficiently.

To run Disk Cleanup:

1. Click **Start > All Programs > Accessories > System Tools > Disk Cleanup**.
2. Follow the on-screen instructions.

## Using HP 3D DriveGuard (select products only)

HP 3D DriveGuard protects a hard drive by parking the drive and halting data requests under either of the following conditions:

- You drop the computer.
- You move the computer with the display closed while the computer is running on battery power.

A short time after the end of one of these events, HP 3D DriveGuard returns the hard drive to normal operation.



**NOTE:** Because solid state drives (SSDs) lack moving parts, they do not require HP 3D DriveGuard protection.



**NOTE:** A hard drive in a primary hard drive bay or a secondary hard drive bay is protected by HP 3D DriveGuard. A hard drive installed in an optional docking device or connected to a USB port is not protected by HP 3D DriveGuard.

---

For more information, see the HP 3D DriveGuard software Help.





## Identifying HP 3D DriveGuard status

The hard drive light on the computer changes color to show that the primary hard drive is parked. To determine whether a drive is currently protected or whether it is parked, view the icon on the Windows desktop in the notification area, at the far right of the taskbar, or in the Mobility Center.

# 9 Security

## Protecting the computer

Standard security features provided by the Windows operating system and the non-Windows Computer Setup utility (BIOS) can protect your personal settings and data from a variety of risks.

-  **NOTE:** Security solutions are designed to act as deterrents. These deterrents may not prevent a product from being mishandled or stolen.
-  **NOTE:** Before you send your computer for service, back up and delete confidential files, and remove all password settings.
-  **NOTE:** Some features listed in this chapter may not be available on your computer.
-  **NOTE:** Your computer supports Computrace, which is an online security-based tracking and recovery service available in select regions. If the computer is stolen, Computrace can track the computer if the unauthorized user accesses the Internet. You must purchase the software and subscribe to the service in order to use Computrace. For information about ordering the Computrace software, go to <http://www.hp.com>.

Computer risk	Security feature
Unauthorized use of the computer	HP Client Security, in combination with a password, smart card, contactless card, registered fingerprints, or other authentication credential
Unauthorized access to Computer Setup (BIOS)	BIOS Administrator password in Computer Setup*
Unauthorized access to the contents of a hard drive	DriveLock password (select products only) in Computer Setup*
Unauthorized startup from an optional external optical drive (select products only), optional external hard drive (select products only), or internal network adapter	Boot options feature in Computer Setup*
Unauthorized access to a Windows user account	Windows user password
Unauthorized access to data	<ul style="list-style-type: none"><li>• HP Drive Encryption software (select products only)</li><li>• Windows Defender</li></ul>
Unauthorized access to Computer Setup settings and other system identification information	BIOS Administrator password in Computer Setup*
Unauthorized removal of the computer	Security cable slot (used with an optional security cable on select products only)

\*Computer Setup is a preinstalled, ROM-based utility that can be used even when the operating system is not working or will not load. You can use a pointing device (TouchPad, pointing stick, or USB mouse) or the keyboard to navigate and make selections in Computer Setup.

**NOTE:** On tablets without keyboards, you can use the touchscreen.



# Using passwords

A password is a group of characters that you choose to secure your computer information. Several types of passwords can be set, depending on how you want to control access to your information. Passwords can be set in Windows or in Computer Setup, which is preinstalled on the computer.

- BIOS Administrator and DriveLock passwords are set in Computer Setup and are managed by the system BIOS.
- Windows passwords are set only in the Windows operating system.
- If you forget both the DriveLock user password and the DriveLock master password set in Computer Setup, the hard drive that is protected by the passwords is permanently locked and can no longer be used.

You can use the same password for a Computer Setup feature and for a Windows security feature. You can also use the same password for more than one Computer Setup feature.

Use the following tips for creating and saving passwords:

- When creating passwords, follow requirements set by the program.
- Do not use the same password for multiple applications or websites, and do not reuse your Windows password for any other application or website.
- Use the Password Manager feature of HP Client Security to store your user names and passwords for your websites and applications. You can securely read them in the future if they cannot be remembered.
- Do not store passwords in a file on the computer.

The following tables list commonly used Windows and BIOS Administrator passwords and describe their functions.

## Setting passwords in Windows

Password	Function
Administrator password*	Protects access to a Windows administrator-level account. <b>NOTE:</b> Setting the Windows administrator password does not set the BIOS Administrator password.
User password*	Protects access to a Windows user account.

\*For information about setting a Windows administrator password or a Windows user password, select **Start > All Programs > HP Help and Support > HP Support Assistant**.

## Setting passwords in Computer Setup

Password	Function
BIOS administrator password*	Protects access to Computer Setup. <b>NOTE:</b> If features have been enabled to prevent removing the BIOS administrator password, you may not be able to remove it until those features have been disabled.
DriveLock master password*	Protects access to the internal hard drive that is protected by DriveLock. It is also used to remove DriveLock protection. <b>NOTE:</b> For select products, a BIOS administrator password must be set before you can set a DriveLock password.
DriveLock user password*	Protects access to the internal hard drive that is protected by DriveLock, and is set under DriveLock Passwords during the enable process. <b>NOTE:</b> For select products, a BIOS administrator password must be set before you can set a DriveLock password.

\*For details about each of these passwords, see the following topics.

## Managing a BIOS administrator password

To set, change, or delete this password, follow these steps:

### Setting a new BIOS administrator password

1. Start Computer Setup.
  - Computers or tablets with keyboards:
    - ▲ Turn on or restart the computer, and when the HP logo appears, press **f10** to enter Computer Setup.
  - Tablets without keyboards:
    - ▲ Turn off the tablet. Press the power button in combination with the volume down button until the Startup menu is displayed, and then tap **F10** to enter Computer Setup.
2. Select **Security**, select **Create BIOS Administrator password**, and then press **enter**.
3. When prompted, type a password.
4. When prompted, type the new password again to confirm.
5. To save your changes and exit Computer Setup, select the **Save** icon and then follow the on-screen instructions.

– or –

Select **Main**, select **Save Changes and Exit**, and then press **enter**.

Your changes go into effect when the computer restarts.

### Changing a BIOS administrator password

1. Start Computer Setup.
  - Computers or tablets with keyboards:

- ▲ Turn on or restart the computer, and when the HP logo appears, press **f10** to enter Computer Setup.
- Tablets without keyboards:
  - ▲ Turn off the tablet. Press the power button in combination with the volume down button until the Startup menu is displayed, and then tap **F10** to enter Computer Setup.
- 2. Select **Security**, select **Change BIOS Administrator Password**, and then press **enter**.
- 3. When prompted, type your current password.
- 4. When prompted, type your new password.
- 5. When prompted, type your new password again to confirm.
- 6. To save your changes and exit Computer Setup, select the **Save** icon, and then follow the on-screen instructions.

– or –

Select **Main**, select **Save Changes and Exit**, and then press **enter**.

Your changes go into effect when the computer restarts.

### Deleting a BIOS administrator password

1. Start Computer Setup.
  - Computers or tablets with keyboards:
    - ▲ Turn on or restart the computer, and when the HP logo appears, press **f10** to enter Computer Setup.
  - Tablets without keyboards:
    - ▲ Turn off the tablet. Press the power button in combination with the volume down button until the Startup menu is displayed, and then tap **F10** to enter Computer Setup.
2. Select **Security**, select **Change BIOS Administrator Password**, and then press **enter**.
3. When prompted, type your current password.
4. When prompted for the new password, leave the field empty, and then press **enter**.
5. When prompted to type your new password again, leave the field empty, and then press **enter**.
6. To save your changes and exit Computer Setup, select the **Save** icon, and then follow the on-screen instructions.

– or –

Select **Main**, select **Save Changes and Exit**, and then press **enter**.

Your changes go into effect when the computer restarts.

### Entering a BIOS administrator password

At the **BIOS Administrator password** prompt, type your password (using the same kind of keys you used to set the password), and then press **enter**. After two unsuccessful attempts to enter the BIOS administrator password, you must restart the computer and try again.

## Managing a Computer Setup DriveLock password (select products only)

 **CAUTION:** To prevent a DriveLock-protected hard drive from becoming permanently unusable, record the DriveLock user password and the DriveLock master password in a safe place away from your computer. If you forget both DriveLock passwords, the hard drive will be permanently locked and can no longer be used.

DriveLock protection prevents unauthorized access to the contents of a hard drive. DriveLock can be applied only to the internal hard drive(s) of the computer. After DriveLock protection is applied to a drive, a password must be entered to access the drive. The drive must be inserted into the computer or an advanced port replicator in order for it to be accessed by the DriveLock passwords.

To apply DriveLock protection to an internal hard drive, a user password and a master password must be set in Computer Setup. Note the following considerations about using DriveLock protection:

- After DriveLock protection is applied to a hard drive, the hard drive can be accessed only by entering either the user password or the master password.
- The owner of the user password should be the day-to-day user of the protected hard drive. The owner of the master password may be either a system administrator or the day-to-day user.
- The user password and the master password can be identical.
- You can delete a user password or master password only by removing DriveLock protection from the drive.



**NOTE:** For select products, a BIOS administrator password must be set before you can access the DriveLock features.

### Setting a DriveLock password

To set a DriveLock password in Computer Setup, follow these steps:

1. Start Computer Setup.
  - Computers or tablets with keyboards:
    1. Turn off the computer.
    2. Press the power button, and when the HP logo appears, press **f10** to enter Computer Setup.
  - Tablets without keyboards:
    1. Turn off the tablet.
    2. Press the power button in combination with the volume down button until the Startup menu is displayed, and then tap **F10** to enter Computer Setup.

2. Select **Security**, make the selection for **Hard Drive Utilities**, select **DriveLock**, and then press **enter**.



**NOTE:** For select products, you may be required to set a DriveLock password and enter the BIOS administrator password.

3. Select the hard drive you want to protect, and then press **enter**.
4. Select **Set DriveLock Master Password** or **Set DriveLock Password** (select products only), and then press **enter**.
5. Carefully read the warning.
6. Follow the on-screen instructions to set a DriveLock password.
7. To exit Computer Setup, select **Main**, select **Save Changes and Exit**, and then select **Yes**.

## Enabling DriveLock (select products only)

For select products, you may need to follow these instructions to enable DriveLock.

1. Start Computer Setup.
  - Computers or tablets with keyboards:
    1. Turn off the computer.
    2. Press the power button, and when the HP logo appears, press **f10** to enter Computer Setup.
  - Tablets without keyboards:
    1. Turn off the tablet.
    2. Press the power button in combination with the volume down button until the Startup menu is displayed, and then tap **F10** to enter Computer Setup.
2. Select **Security**, select **Hard Drive Utilities**, select **DriveLock**, and then press **enter**.

---

 **NOTE:** For select products, you may be required to enter the BIOS Administrator password and select **Set DriveLock Password**.

---

3. Select the hard drive you want to protect, and then press **enter**.
4. Follow the on-screen instructions to make the selections to enable DriveLock and to enter passwords when prompted.

---

 **NOTE:** For select products, you may be prompted to type `DriveLock`. The field is case sensitive.

---

5. To exit Computer Setup, select **Main**, select **Save Changes and Exit**, and then select **Yes**.

## Disabling DriveLock (select products only)

1. Start Computer Setup.
  - Computers or tablets with keyboards:
    1. Turn off the computer.
    2. Press the power button, and when the HP logo appears, press **f10** to enter Computer Setup.
  - Tablets without keyboards:
    1. Turn off the tablet.
    2. Press the power button in combination with the volume down button until the Startup menu is displayed, and then tap **F10** to enter Computer Setup.
2. Select **Security**, select **Hard Drive Utilities**, select **DriveLock**, and then press **enter**.

---

 **NOTE:** For select products, you may be required to enter the BIOS Administrator password and select **Set DriveLock Password**.

---

3. Select the hard drive you want to manage, and then press **enter**.
4. Follow the on-screen instructions to disable DriveLock.
5. To exit Computer Setup, select **Main**, select **Save Changes and Exit**, and then select **Yes**.

## Entering a DriveLock password (select products only)

Be sure that the hard drive is inserted into the computer (not into an optional docking device or external MultiBay).

At the **DriveLock Password** prompt, type your user or master password (using the same kind of keys you used to set the password), and then press [enter](#).

After three incorrect attempts to enter the password, you must shut down the computer and try again.

## Changing a DriveLock password (select products only)

To change a DriveLock password in Computer Setup, follow these steps:

1. Turn off the computer.
2. Press the power button.
3. At the **DriveLock Password** prompt, type the current DriveLock user password or master password that you are changing, press [enter](#), and then press or tap **F10** to enter Computer Setup.
4. Select **Security**, select **Hard Drive Utilities**, select **DriveLock**, and then press [enter](#).



---

**NOTE:** For select products, you may be required to enter the BIOS Administrator password and select **Set DriveLock Password**.

---

5. Select the hard drive you want to manage, and then press [enter](#).
6. Make the selection to change the password, and then follow the on-screen prompts to enter passwords.



---

**NOTE:** The **Change DriveLock Master Password** option is visible only if the master password was provided at the DriveLock Password prompt in step 3.

---

7. To exit Computer Setup, select **Main**, select **Save Changes and Exit**, and then follow the on-screen instructions.

## Using antivirus software

When you use the computer to access e-mail, a network, or the Internet, you potentially expose it to computer viruses. Computer viruses can disable the operating system, programs, or utilities, or cause them to function abnormally.

Antivirus software can detect most viruses, destroy them, and, in most cases, repair any damage they have caused. To provide ongoing protection against newly discovered viruses, antivirus software must be kept up to date.

Windows Defender is preinstalled on your computer. It is strongly recommended that you continue to use an antivirus program in order to fully protect your computer.

For more information about computer viruses, access the HP Support Assistant.

## Using firewall software

Firewalls are designed to prevent unauthorized access to a system or network. A firewall can be a software program you install on your computer and/or network, or it can be a solution made up of both hardware and software.

There are two types of firewalls to consider:

- Host-based firewalls—Software that protects only the computer it is installed on.
- Network-based firewalls—Installed between your DSL or cable modem and your home network to protect all the computers on the network.

When a firewall is installed on a system, all data sent to and from the system is monitored and compared with a set of user-defined security criteria. Any data that does not meet those criteria is blocked.

Your computer or networking equipment may already have a firewall installed. If not, firewall software solutions are available.

---

 **NOTE:** Under some circumstances a firewall can block access to Internet games, interfere with printer or file sharing on a network, or block authorized e-mail attachments. To temporarily resolve the problem, disable the firewall, perform the task that you want to perform, and then reenable the firewall. To permanently resolve the problem, reconfigure the firewall.

---

## Installing critical security updates

---

 **CAUTION:** Microsoft® sends out alerts regarding critical updates. To protect the computer from security breaches and computer viruses, install all critical updates from Microsoft as soon as you receive an alert.

---

You can choose whether updates are installed automatically. To change the settings, select **Start > Control Panel > System and Security > Windows Update > Change settings**, and then follow the on-screen instructions.

## Using HP Client Security (select products only)

HP Client Security software is preinstalled on your computer. This software can be accessed through the HP Client Security icon at the far right of the taskbar or Windows Control Panel. It provides security features that help protect against unauthorized access to the computer, networks, and critical data. For more information, see the HP Client Security software Help.

## Using HP Touchpoint Manager (select products only)

HP Touchpoint Manager is a cloud-based IT solution that enables businesses to effectively manage and secure their company assets. HP Touchpoint Manager helps protect devices against malware and other attacks, monitors device health, and enables customers to reduce time spent solving end-user device and security issues. Customers can quickly download and install the software, which is highly cost effective relative to traditional in-house solutions. For more information, see <http://www.hptouchpointmanager.com>.

## Installing an optional security cable (select products only)

 **NOTE:** A security cable is designed to act as a deterrent, but it may not prevent the computer from being mishandled or stolen.

 **NOTE:** The security cable slot on your computer may look slightly different from the illustration in this section.

1. Loop the security cable around a secured object.
2. Insert the key **(1)** into the cable lock **(2)**.
3. Insert the cable lock into the security cable slot on the computer **(3)**, and then lock the cable lock with the key.

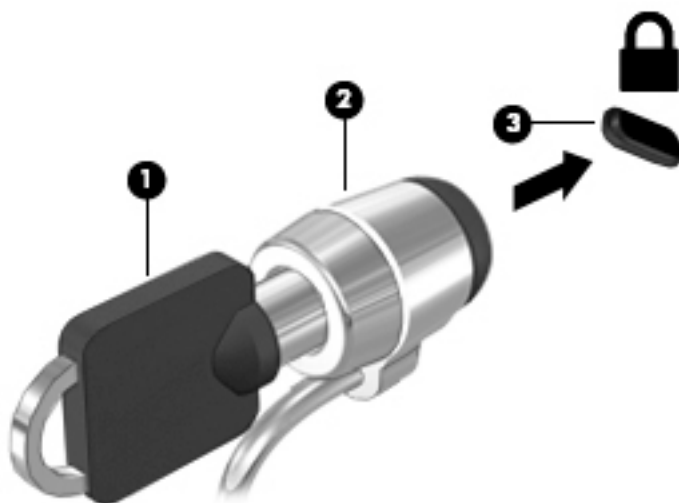

## Using a fingerprint reader (select products only)

Integrated fingerprint readers are available on select products. In order to use the fingerprint reader, you must enroll your fingerprints in HP Client Security's Credential Manager. Refer to the HP Client Security software Help.

After you enroll your fingerprints in Credential Manager, you can use HP Client Security's Password Manager to store and fill in your user names and passwords in supported websites and applications.

### Locating the fingerprint reader

The fingerprint reader is a small metallic sensor that is located in one of the following areas of your computer:

- Near the bottom of the TouchPad
- On the right side of the keyboard
- On the upper-right side of the display
- On the left side of the display

Depending on your product, the reader may be oriented horizontally or vertically. Both orientations require that you swipe your finger perpendicular to the metallic sensor.



---

# 10 Maintenance

## Cleaning your computer

Use the following products to safely clean your computer:

- Dimethyl benzyl ammonium chloride 0.3 percent maximum concentration (for example, disposable wipes, which come in a variety of brands).
- Alcohol-free glass-cleaning fluid
- Water with mild soap solution
- Dry microfiber cleaning cloth or a chamois (static-free cloth without oil)
- Static-free cloth wipes

---

 **CAUTION:** Avoid strong cleaning solvents that can permanently damage your computer. If you are not sure that a cleaning product is safe for your computer, check the product contents to make sure that ingredients such as alcohol, acetone, ammonium chloride, methylene chloride, and hydrocarbons are not included in the product.

---

Fibrous materials, such as paper towels, can scratch the computer. Over time, dirt particles and cleaning agents can get trapped in the scratches.

## Cleaning procedures

Follow the procedures in this section to safely clean your computer.

---

 **WARNING!** To prevent electric shock or damage to components, do not attempt to clean your computer while it is turned on.

- Turn off the computer.
- Disconnect AC power.
- Disconnect all powered external devices.

 **CAUTION:** To prevent damage to internal components, do not spray cleaning agents or liquids directly on any computer surface. Liquids dripped on the surface can permanently damage internal components.

---

## Cleaning the display (All-in-Ones or Notebooks)

Gently wipe the display using a soft, lint-free cloth moistened with an alcohol-free glass cleaner. Be sure that the display is dry before closing the display.

## Cleaning the sides or cover

To clean the sides or cover, use a soft microfiber cloth or chamois moistened with one of the cleaning solutions listed previously or use an acceptable disposable wipe.

---

 **NOTE:** When cleaning the cover of the computer, use a circular motion to aid in removing dirt and debris.

---

## Cleaning the TouchPad, keyboard, or mouse

---

 **WARNING!** To reduce the risk of electric shock or damage to internal components, do not use a vacuum cleaner attachment to clean the keyboard. A vacuum cleaner can deposit household debris on the keyboard surface.

 **CAUTION:** To prevent damage to internal components, do not allow liquids to drip between the keys.

---

- To clean the TouchPad, keyboard, or mouse, use a soft microfiber cloth or a chamois moistened with one of the cleaning solutions listed previously or use an acceptable disposable wipe.
- To prevent keys from sticking and to remove dust, lint, and particles from the keyboard, use a can of compressed air with a straw extension.

## Updating programs and drivers

HP recommends that you update your programs and drivers on a regular basis to the latest versions. Updates can resolve issues and bring new features and options to your computer. Technology is always changing, and updating programs and drivers allows your computer to run the latest technology available. For example, older graphics components might not work well with the most recent gaming software. Without the latest driver, you would not be getting the most out of your equipment.

Go to <http://www.hp.com/support> to download the latest versions of HP programs and drivers. In addition, register to receive automatic update notifications when they become available.

## Using SoftPaq Download Manager

HP SoftPaq Download Manager (SDM) is a tool that provides quick access to SoftPaq information for HP business computers without requiring the SoftPaq number. Using this tool, you can easily search for SoftPaqs, and then download and unpack them.

SoftPaq Download Manager works by reading and downloading, from the HP FTP site, a published database file containing computer model and SoftPaq information. SoftPaq Download Manager allows you to specify one or more computer models to determine which SoftPaqs are available for download.

SoftPaq Download Manager checks the HP FTP site for updates to the database and software. If updates are found, they are downloaded and applied automatically.

SoftPaq Download Manager is available on the HP website. To use SoftPaq Download Manager to download SoftPaqs, you must first download and install the program. Go to <http://www.hp.com/go/sdm>, and follow the instructions to download and install SoftPaq Download Manager.

To download SoftPaqs:

- ▲ Select **Start > All Programs > HP > HP SoftPaq Download Manager**.

---

 **NOTE:** If prompted by User Account Control, click **Yes**.

---

---

# 11 Backup and recovery

Your computer includes HP and Windows tools to help you safeguard your information and retrieve it if you ever need to. These tools will help you return your computer to a proper working state, all with simple steps. This section provides information about the following processes:

- Creating recovery media and backups
- Restoring and recovering your system

## Creating recovery media and backups

Recovery after a system failure is only as good as your most recent backup.

1. After you successfully set up the computer, create HP Recovery media. This step creates a Windows 7 operating system DVD and a *Driver Recovery* DVD. The Windows DVD can be used to reinstall the original operating system in cases where the hard drive is corrupted or has been replaced. The *Driver Recovery* DVD installs specific drivers and applications. See [Creating recovery media with HP Recovery Disc Creator on page 65](#).
2. Use Windows Backup and Recovery tools to perform the following:
  - Back up individual files and folders
  - Back up your entire hard drive (select products only)
  - Create system repair discs (select products only) with the installed optical drive (select products only) or an optional external optical drive
  - Create system restore points

---

 **NOTE:** This guide describes an overview of backing up, restoring, and recovering options. For more details about the tools provided, see Help and Support. To access Help and Support, select **Start > Help and Support**.

 **NOTE:** HP recommends that you print the recovery procedures and save them for later use, in case of system instability.

---

In case of system failure, you can use the backup files to restore the contents of your computer. See [Backing up your information on page 66](#).

## Guidelines

- When creating recovery media or backing up to discs, use any of the following types of discs (purchased separately): DVD+R, DVD+R DL, DVD-R, DVD-R DL, or DVD±RW. The discs you use will depend on the type of optical drive you are using.
- Be sure that the computer is connected to AC power before you start the recovery media creation process or the backup process.

## Creating recovery media with HP Recovery Disc Creator

HP Recovery Disc Creator is a software program that offers an alternative way to create recovery media. After you successfully set up the computer, you can create recovery media using HP Recovery Disc Creator. This recovery media allows you to reinstall your original operating system as well as select drivers and

applications if the hard drive becomes corrupted. HP Recovery Disc Creator can create two kinds of recovery DVDs:

- Windows 7 operating system DVD—Installs the operating system without additional drivers or applications.
- *Driver Recovery* DVD—Installs specific drivers and applications only, in the same way that the HP Software Setup utility installs drivers and applications.

## Creating recovery media

---

 **NOTE:** The Windows 7 operating system DVD can be created only once. Thereafter, the option to create that media will not be available after you create a Windows DVD.

---

To create the Windows DVD:

1. Select **Start > All Programs > Productivity and Tools > HP Recovery Disc Creator**.
2. Select **Windows disk**.
3. From the drop-down menu, select the drive for burning the recovery media.
4. Click the **Create** button to start the burning process.

After the Windows 7 operating system DVD has been created, create the *Driver Recovery* DVD:

1. Select **Start > All Programs > Productivity and Tools > HP Recovery Disc Creator**.
2. Select **Driver disk**.
3. From the drop-down menu, select the drive for burning the recovery media.
4. Click the **Create** button to start the burning process.

## Backing up your information

You should create system repair media and your initial backup immediately after initial system setup. As you add new software and data files, you should continue to back up your system on a regular basis to maintain a reasonably current backup. You should also create Windows system repair media (select products only) which can be used to start up (boot) the computer and repair the operating system in case of system instability or failure. Your initial and subsequent backups allow you to restore your data and settings if a failure occurs.

You can back up your information to an optional external hard drive, a network drive, or discs.

Note the following when backing up:

- Store personal files in the Documents library, and back it up regularly.
- Back up templates that are stored in their associated directories.
- Save customized settings that appear in a window, toolbar, or menu bar by taking a screen shot of your settings. The screen shot can be a time-saver if you have to reset your preferences.
- When backing up to discs, number each disc after removing it from the drive.

---

 **NOTE:** For detailed instructions on various backup and restore options, perform a search for these topics in Help and Support. To access Help and Support, select **Start > Help and Support**.

 **NOTE:** Windows includes the User Account Control feature to improve the security of your computer. You may be prompted for your permission or password for tasks such as installing software, running utilities, or changing Windows settings. Refer to Help and Support. To access Help and Support, select **Start > Help and Support**.

---

To create a backup using Windows Backup and Restore:

---

 **NOTE:** The backup process may take over an hour, depending on file size and the speed of the computer.

---

1. Select **Start > All Programs > Maintenance > Backup and Restore**.
2. Follow the on-screen instructions to set up your backup, create a system image (select products only), or create system repair media (select products only).

## Performing a system recovery

In case of system failure or instability, the computer provides the following tools to recover your files:

- Windows recovery tools: You can use Windows Backup and Restore to recover information you have previously backed up. You can also use Windows Startup Repair to fix problems that might prevent Windows from starting correctly.
- f11 recovery tools (select products only): You can use the f11 recovery tools to recover your original hard drive image. The image includes the Windows operating system and software programs installed at the factory.

---

 **NOTE:** If you are unable to boot (start up) your computer and you cannot use the system repair media you previously created (select products only), you must purchase Windows 7 operating system media to reboot the computer and repair the operating system. For additional information, see [Using Windows 7 operating system media on page 68](#).

---

## Using the Windows recovery tools

Using the Windows recovery tools, you can:

- Recover individual files
- Restore the computer to a previous system restore point
- Recover information using recovery tools

---

 **NOTE:** For detailed instructions on various recovery and restore options, perform a search for these topics in Help and Support. To access Help and Support, select **Start > Help and Support**.

 **NOTE:** Windows includes the User Account Control feature to improve the security of your computer. You may be prompted for your permission or password for tasks such as installing software, running utilities, or changing Windows settings. Refer to Help and Support. To access Help and Support, select **Start > Help and Support**.

---

To recover information you previously backed up:

1. Select **Start > All Programs > Maintenance > Backup and Restore**.
2. Follow the on-screen instructions to recover your system settings, your computer (select products only), or your files.

To recover your information using Startup Repair, follow these steps:

---

 **CAUTION:** Some Startup Repair options will completely erase and reformat the hard drive. All files you have created and any software installed on the computer are permanently removed. When reformatting is complete, the recovery process restores the operating system, as well as the drivers, software, and utilities from the backup used for recovery.

---

1. If possible, back up all personal files.
2. If possible, check for the presence of the Windows partition.  
To check for the Windows partition, select **Start > Computer**.



**NOTE:** If the Windows partition is not listed, you must recover your operating system and programs using the Windows 7 operating system DVD and the *Driver Recovery* media. For additional information, see [Using Windows 7 operating system media on page 68](#).

3. If the Windows partition is listed, restart the computer, and then press **f8** before the Windows operating system loads.
4. Select **Startup Repair**.
5. Follow the on-screen instructions.



**NOTE:** For additional information on recovering information using the Windows tools, select **Start > Help and Support**.

## Using f11 recovery tools (select products only)



**CAUTION:** Using **f11** completely erases hard drive contents and reformats the hard drive. All files that you have created and any software that you have installed on the computer are permanently removed. The **f11** recovery tool reinstalls the operating system and HP programs and drivers that were installed at the factory. Software not installed at the factory must be reinstalled.

To recover the original hard drive image using **f11**:

1. If possible, back up all personal files.
2. If possible, check for the presence of the HP Recovery partition: click **Start**, right-click **Computer**, click **Manage**, and then click **Disk Management**.



**NOTE:** If the HP Recovery partition is not listed, you must recover your operating system and programs using the Windows 7 operating system media and the *Driver Recovery* media. For additional information, see [Using Windows 7 operating system media on page 68](#).

3. If the HP Recovery partition is listed, restart the computer, and then press **esc** while the “Press the ESC key for Startup Menu” message is displayed at the bottom of the screen.
4. Press **f11** while the “Press <F11> for recovery” message is displayed on the screen.
5. Follow the on-screen instructions.

## Using Windows 7 operating system media

If you cannot use the recovery media you previously created using the HP Recovery Disc Creator (select products only), you must purchase a Windows 7 operating system DVD to reboot the computer and repair the operating system.

To order a Windows 7 operating system DVD, go to the HP website. For support, go to <http://www.hp.com/support>. You can also order the DVD by calling support. For contact information, see the *Worldwide Telephone Numbers* booklet included with the computer.



**CAUTION:** Using a Windows 7 operating system DVD completely erases hard drive contents and reformats the hard drive. All files that you have created and any software that you have installed on the computer are permanently removed. When reformatting is complete, the recovery process helps you restore the operating system, as well as drivers, software, and utilities.

To initiate recovery using a Windows 7 operating system DVD:



---

**NOTE:** This process takes several minutes.

---

1. If possible, back up all personal files.
2. Restart the computer, and then insert the Windows 7 operating system DVD into the optical drive before the Windows operating system loads.
3. When prompted, press any keyboard key.
4. Follow the on-screen instructions.
5. Click **Next**.
6. Select **Repair your computer**.
7. Follow the on-screen instructions.

After the repair is completed:

1. Eject the Windows 7 operating system DVD and then insert the *Driver Recovery* DVD.
2. Install the Hardware Enabling Drivers first, and then install Recommended Applications.

---

# 12 Computer Setup (BIOS), TPM, and HP Sure Start

## Using Computer Setup

Computer Setup, or Basic Input/Output System (BIOS), controls communication between all the input and output devices on the system (such as disk drives, display, keyboard, mouse, and printer). Computer Setup includes settings for the types of devices installed, the startup sequence of the computer, and the amount of system and extended memory.

---

 **NOTE:** Use extreme care when making changes in Computer Setup. Errors can prevent the computer from operating properly.

---

## Starting Computer Setup

---

 **NOTE:** An external keyboard or mouse connected to a USB port can be used with Computer Setup only if USB legacy support is enabled.

---

To start Computer Setup, follow these steps:

- ▲ Start Computer Setup.
  - Computers or tablets with keyboards:
    - ▲ Turn on or restart the computer, and when the HP logo appears, press **f10** to enter Computer Setup.
  - Tablets without keyboards:
    - ▲ Turn off the tablet. Press the power button in combination with the volume down button until the Startup menu is displayed, and then tap **F10** to enter Computer Setup.

## Navigating and selecting in Computer Setup

- To select a menu or a menu item, use the **tab** key and the keyboard arrow keys and then press **enter**, or use a pointing device to select the item.

---

 **NOTE:** On tablets without keyboards, you can use your finger to make selections.

---

- To scroll up and down, select the up arrow or the down arrow in the upper-right corner of the screen, or use the up arrow key or the down arrow key on the keyboard.
- To close open dialog boxes and return to the main Computer Setup screen, press **esc**, and then follow the on-screen instructions.



To exit Computer Setup menus, choose one of the following methods:

- To exit Computer Setup menus without saving your changes:  
Select the **Exit** icon in the lower-right corner of the screen, and then follow the on-screen instructions.  
– or –  
Select **Main**, select **Ignore Changes and Exit**, and then press [enter](#).
- To save your changes and exit Computer Setup menus:  
Select the **Save** icon in the lower-right corner of the screen, and then follow the on-screen instructions.  
– or –  
Select **Main**, select **Save Changes and Exit**, and then press [enter](#).

Your changes go into effect when the computer restarts.

## Restoring factory settings in Computer Setup

---

 **NOTE:** Restoring defaults will not change the hard drive mode.

---

To return all settings in Computer Setup to the values that were set at the factory, follow these steps:

1. Start Computer Setup. See [Starting Computer Setup on page 70](#).
2. Select **Main**, and then select **Apply Factory Defaults and Exit**.

---

 **NOTE:** On select products, the selections may display **Restore Defaults** instead of **Apply Factory Defaults and Exit**.

---

3. Follow the on-screen instructions.
4. To save your changes and exit, select the **Save** icon in the lower-right corner of the screen, and then follow the on-screen instructions.  
– or –  
Select **Main**, select **Save Changes and Exit**, and then press [enter](#).

Your changes go into effect when the computer restarts.

---

 **NOTE:** Your password settings and security settings are not changed when you restore the factory settings.

---

## Updating the BIOS

Updated versions of the BIOS may be available on the HP website.

Most BIOS updates on the HP website are packaged in compressed files called *SoftPaqs*.

Some download packages contain a file named *Readme.txt*, which contains information regarding installing and troubleshooting the file.

### Determining the BIOS version

To decide whether you need to update Computer Setup (BIOS), first determine the BIOS version on your computer.

BIOS version information (also known as *ROM date* and *System BIOS*) can be accessed by pressing **fn+esc** (if you are already in Windows) or by using Computer Setup.

1. Start Computer Setup. See [Starting Computer Setup on page 70](#).
2. Select **Main**, and then select **System Information**.
3. To exit Computer Setup without saving your changes, select the **Exit** icon in the lower-right corner of the screen, and then follow the on-screen instructions.

– or –

Select **Main**, select **Ignore Changes and Exit**, and then press **enter**.

To check for later BIOS versions, see [Downloading a BIOS update on page 72](#).

### Downloading a BIOS update

---

 **CAUTION:** To reduce the risk of damage to the computer or an unsuccessful installation, download and install a BIOS update only when the computer is connected to reliable external power using the AC adapter. Do not download or install a BIOS update while the computer is running on battery power, docked in an optional docking device, or connected to an optional power source. During the download and installation, follow these instructions:

Do not disconnect power on the computer by unplugging the power cord from the AC outlet.

Do not shut down the computer or initiate Sleep.

Do not insert, remove, connect, or disconnect any device, cable, or cord.

---

1. Access Help and Support by selecting **Start > All Programs > HP Help and Support > HP Support Assistant**.
2. Make the selection for updates.
3. Follow the on-screen instructions.
4. At the download area, follow these steps:
  - a. Identify the most recent BIOS update and compare it to the BIOS version currently installed on your computer. Make a note of the date, name, or other identifier. You may need this information to locate the update later, after it has been downloaded to your hard drive.
  - b. Follow the on-screen instructions to download your selection to the hard drive.

Make a note of the path to the location on your hard drive where the BIOS update is downloaded. You will need to access this path when you are ready to install the update.

---

 **NOTE:** If you connect your computer to a network, consult the network administrator before installing any software updates, especially system BIOS updates.

---

BIOS installation procedures vary. Follow any instructions that are revealed on the screen after the download is complete. If no instructions are revealed, follow these steps:

1. Select **Start > Computer**.
2. Select your hard drive designation. The hard drive designation is typically Local Disk (C:).
3. Using the hard drive path you recorded earlier, open the folder that contains the update.
4. Double-click the file that has an .exe extension (for example, *filename.exe*).  
The BIOS installation begins.
5. Complete the installation by following the on-screen instructions.

---

 **NOTE:** After a message on the screen reports a successful installation, you can delete the downloaded file from your hard drive.

---

## Changing the boot order using the f9 prompt

To dynamically choose a boot device for the current startup sequence, follow these steps:

1. Access the Boot Device Options menu:
  - Computers or tablets with keyboards:
    - ▲ Turn on or restart the computer, and when the HP logo appears, press **f9** to enter the Boot Device Options menu.
  - Tablets without keyboards:
    - ▲ Turn off the tablet. Press the power button in combination with the volume down button until the Startup menu is displayed, and then tap **F9** to enter the Boot Device Options menu.
2. Select a boot device, then press [enter](#).

## TPM BIOS settings (select products only)

---

 **IMPORTANT:** Before enabling Trusted Platform Module (TPM) functionality on this system, you must ensure that your intended use of TPM complies with relevant local laws, regulations and policies, and approvals or licenses must be obtained if applicable. For any compliance issues arising from your operation/usage of TPM which violates the above mentioned requirement, you shall bear all the liabilities wholly and solely. HP will not be responsible for any related liabilities.

---

TPM provides additional security for your computer. You can modify the TPM settings in Computer Setup (BIOS).

---

 **NOTE:** If you change the TPM setting to Hidden, TPM is not visible in the operating system.

---

To access TPM settings in Computer Setup:

1. Start Computer Setup. See [Starting Computer Setup on page 70](#).
2. Select **Security**, select **TPM Embedded Security**, and then follow the on-screen instructions.

## Using HP Sure Start (select products only)

Select computer models are configured with HP Sure Start, a technology that continuously monitors the computer's BIOS for attacks or corruption. If the BIOS becomes corrupted or is attacked, HP Sure Start automatically restores the BIOS to its previously safe state, without user intervention.

HP Sure Start is configured and already enabled so that most users can use the HP Sure Start default configuration. The default configuration can be customized by advanced users.

To access the latest documentation on HP Sure Start, go to <http://www.hp.com/support>, and select your country. Select **Drivers & Downloads**, and then follow the on-screen instructions.

---

# 13 Using HP PC Hardware Diagnostics (UEFI)

HP PC Hardware Diagnostics is a Unified Extensible Firmware Interface (UEFI) that allows you to run diagnostic tests to determine whether the computer hardware is functioning properly. The tool runs outside the operating system so that it can isolate hardware failures from issues that are caused by the operating system or other software components.

When HP PC Hardware Diagnostics (UEFI) detects a failure that requires hardware replacement, a 24-digit Failure ID code is generated. This ID code can then be provided to support to help determine how to correct the problem.

---

 **NOTE:** To start diagnostics on a convertible computer, your computer must be in notebook mode and you must use the keyboard attached.

---

To start HP PC Hardware Diagnostics (UEFI), follow these steps:

1. Turn on or restart the computer, and quickly press **esc**.
2. Press **f2**.

The BIOS searches three places for the diagnostic tools, in the following order:

- a. Connected USB drive

---

 **NOTE:** To download the HP PC Hardware Diagnostics (UEFI) tool to a USB drive, see [Downloading HP PC Hardware Diagnostics \(UEFI\) to a USB device on page 75](#).

---

- b. Hard drive
  - c. BIOS
3. When the diagnostic tool opens, select the type of diagnostic test you want to run, and then follow the on-screen instructions.

---

 **NOTE:** If you need to stop a diagnostic test, press **esc**.

---

## Downloading HP PC Hardware Diagnostics (UEFI) to a USB device

---

 **NOTE:** The HP PC Hardware Diagnostics (UEFI) download instructions are provided in English only, and you must use a Windows computer to download and create the HP UEFI support environment because only .exe files are offered.

---

There are two options to download HP PC Hardware Diagnostics to a USB device.

### Download the latest UEFI version

1. Go to <http://www.hp.com/go/techcenter/pcdiags>. The HP PC Diagnostics home page is displayed.
2. In the HP PC Hardware Diagnostics section, click the **Download** link, and then select **Run**.

### Download any version of UEFI for a specific product

1. Go to <http://www.hp.com/support>, and then select your country. The HP Support page is displayed.
2. Click **Drivers & Downloads**.

3. Use the categories listed to find your product.

– or –

Click **Find Now** to let HP automatically detect your product.

4. Select your computer, and then select your operating system.
5. In the **Diagnostic** section, follow the on-screen instructions to select and download the UEFI version you want.

# 14 Support

## Contacting support

If the information provided in this user guide or Help and Support does not address your questions, you can contact support. For support, go to <http://www.hp.com/support>, and select your country.

Here you can:

- Chat online with an HP technician.



**NOTE:** When support chat is not available in a particular language, it is available in English.

- Find support telephone numbers.
- Locate an HP service center.

## Labels

The labels affixed to the computer provide information you may need when you troubleshoot system problems or travel internationally with the computer.



**IMPORTANT:** All labels described in this section will be located in one of 3 places depending on your computer model: affixed to the bottom of the computer, located in the battery bay, or under the service door.

- Service label—Provides important information to identify your computer. When contacting support, you will probably be asked for the serial number, and possibly for the product number or the model number. Locate these numbers before you contact support.



Component	
(1)	Serial number
(2)	Product number
(3)	Warranty period

- Microsoft Certificate of Authenticity label (select products only prior to Windows 8)—Contains the Windows Product Key. You may need the Product Key to update or troubleshoot the operating system. HP platforms preinstalled with Windows 8 or Windows 8.1 do not have the physical label, but have a Digital Product Key electronically installed.



---

**NOTE:** This Digital Product Key is automatically recognized and activated by Microsoft Operating Systems on a reinstall of the Windows 8 or Windows 8.1 operating system with HP-approved recovery methods.

---

- Regulatory label(s)—Provide(s) regulatory information about the computer.
- Wireless certification label(s)—Provide(s) information about optional wireless devices and the approval markings of some of the countries or regions in which the devices have been approved for use.



# 15 Specifications

## Input power

The power information in this section may be helpful if you plan to travel internationally with the computer.

The computer operates on DC power, which can be supplied by an AC or a DC power source. The AC power source must be rated at 100–240 V, 50–60 Hz. Although the computer can be powered from a standalone DC power source, it should be powered only with an AC adapter or a DC power source supplied and approved by HP for use with this computer.

The computer can operate on DC power within the following specifications.

Input Power	Rating
Operating voltage and current	19.5 V dc @ 2.3 A – 45 W
	19.5 V dc @ 3.33 A – 65 W
	19.5 V dc @ 4.6 A – 90 W (only for products with an Intel quad-core processor)

 **NOTE:** This product is designed for IT power systems in Norway with phase-to-phase voltage not exceeding 240 V rms.

 **NOTE:** The computer operating voltage and current can be found on the system regulatory label.

## Operating environment

Factor	Metric	U.S.
<b>Temperature</b>		
Operating (writing to optical disc)	<b>5°C to 35°C</b>	41°F to 95°F
Nonoperating	<b>-20°C to 60°C</b>	-4°F to 140°F
<b>Relative humidity</b> (noncondensing)		
Operating	<b>10% to 90%</b>	10% to 90%
Nonoperating	<b>5% to 95%</b>	5% to 95%
<b>Maximum altitude</b> (unpressurized)		
Operating	<b>-15 m to 3,048 m</b>	-50 ft to 10,000 ft
Nonoperating	<b>-15 m to 12,192 m</b>	-50 ft to 40,000 ft

---

# 16 Accessibility

HP designs, produces, and markets products and services that can be used by everyone, including people with disabilities, either on a stand-alone basis or with appropriate assistive devices.

## Supported assistive technologies

HP products support a wide variety of operating system assistive technologies and can be configured to work with additional assistive technologies. Use the Search feature on your device to locate more information about assistive features.



---

**NOTE:** For additional information about a particular assistive technology product, contact customer support for that product.

---

## Contacting support

We are constantly refining the accessibility of our products and services and welcome feedback from users. If you have an issue with a product or would like to tell us about accessibility features that have helped you, please contact us at +1 (888) 259-5707, Monday through Friday, 6 a.m. to 9 p.m. North American Mountain Time. If you are deaf or hard-of-hearing and use TRS/VRS/WebCapTel, contact us if you require technical support or have accessibility questions by calling +1 (877) 656-7058, Monday through Friday, 6 a.m. to 9 p.m. North American Mountain Time.



---

**NOTE:** Support is in English only.

---

---

# A Traveling with or shipping your computer

If you have to travel with or ship your computer, here are some tips to keep in mind to keep your equipment safe.

- Prepare the computer for traveling or shipping:
  - Back up your information to an external drive.
  - Remove all discs and all external media cards, such as memory cards, from the computer.
  - Turn off and then disconnect all external devices.
  - Shut down the computer.
- Take along a backup of your information. Keep the backup separate on the computer.
- When traveling by air, carry the computer as hand luggage; do not check it in with the rest of your bags.

---

**⚠ CAUTION:** Avoid exposing a drive to magnetic fields. Security devices with magnetic fields include airport walk-through devices and security wands. Airport conveyer belts and similar security devices that check carry-on baggage use X-rays instead of magnetism and do not damage drives.

---

- If you plan to use the computer during a flight, listen for the in-flight announcement that tells you when you are allowed to use your computer. In-flight computer use is at the discretion of the airline.
- If you are shipping the computer or a drive, use suitable protective packaging and label the package “FRAGILE.”

If the computer has a wireless device installed, the use of these devices may be restricted in some environments. Such restrictions may apply aboard aircraft, in hospitals, near explosives, and in hazardous locations. If you are uncertain of the policy that applies to the use of a particular device, ask for authorization to use your computer before you turn it on.

- If you are traveling internationally, follow these suggestions:
  - Check the computer-related customs regulations for each country or region on your itinerary.
  - Check the power cord and adapter requirements for each location in which you plan to use the computer. Voltage, frequency, and plug configurations vary.

---

**⚠ WARNING!** To reduce the risk of electric shock, fire, or damage to the equipment, do not attempt to power the computer with a voltage converter kit sold for appliances.

---

---

# B Troubleshooting

## Troubleshooting resources

- Access website links and additional information about the computer through Help and Support. To access Help and Support, select **Start > Help and Support**.



**NOTE:** Some checkup and repair tools require an Internet connection. HP also provides additional tools that do not require an Internet connection.

- Contact HP support. For support, go to <http://www.hp.com/support>.

Choose from the following types of support:

- Chat online with an HP technician.



**NOTE:** When chat is not available in a particular language, it is available in English.

- Find HP support worldwide telephone numbers.
- Locate an HP service center.

## Resolving issues

The following sections describe several common issues and solutions.

### The computer is unable to start up

If the computer does not turn on when you press the power button, the following suggestions may help you determine why the computer does not start up:

- If the computer is plugged into an AC outlet, plug another electrical device into the outlet to be sure that the outlet is providing adequate power.



**NOTE:** Use only the AC adapter provided with the computer or one approved by HP for this computer.

- If the computer is plugged into an external power source other than an AC outlet, plug the computer into an AC outlet using the AC adapter. Be sure that the power cord and AC adapter connections are secure.

### The computer screen is blank

If the screen is blank but you have not turned off the computer, one or more of these settings may be the cause:

- The computer may be in the Sleep state. To exit Sleep, briefly press the power button. Sleep is an energy-saving feature that turns off the display. Sleep can be initiated by the system while the computer is on but is not in use, or when the computer has reached a low battery level. To change these and other power settings, right-click the **Battery** icon on the Windows desktop in the notification area, at the far right of the taskbar, and then click **Preferences**.
- The computer may not be set to display the image on the computer screen. To transfer the image to the computer screen, press **fn+f4**. On most models, when an optional external display, such as a monitor, is connected to the computer, the image can be displayed on the computer screen or the external display,

or on both devices simultaneously. When you press **fn+f4** repeatedly, the image alternates among the computer display, one or more external displays, and simultaneous display on all devices.

## Software is functioning abnormally

If the software is unresponsive or responds abnormally, restart the computer. Click **Start**, click the arrow next to **Shut down**, and then select **Restart**. If you cannot restart the computer using this procedure, see the next section, [The computer is on but not responding on page 83](#).

## The computer is on but not responding

If the computer is turned on but is not responding to software or keyboard commands, try the following emergency shutdown procedures, in the sequence provided, until shutdown occurs:

---

 **CAUTION:** Emergency shutdown procedures result in the loss of unsaved information.

---

- Press and hold the power button for at least 5 seconds.
- Disconnect the computer from external power and remove the battery.

## The computer is unusually warm

It is normal for the computer to feel warm to the touch while it is in use. But if the computer feels *unusually* warm, it may be overheating because a vent is blocked.

If you suspect that the computer is overheating, allow the computer to cool to room temperature. Be sure to keep all vents free from obstructions while you are using the computer.

---

 **WARNING!** To reduce the possibility of heat-related injuries or of overheating the computer, do not place the computer directly on your lap or obstruct the computer air vents. Use the computer only on a hard, flat surface. Do not allow another hard surface, such as an adjoining optional printer, or a soft surface, such as pillows or rugs or clothing, to block airflow. Also, do not allow the AC adapter to contact the skin or a soft surface, such as pillows or rugs or clothing, during operation. The computer and the AC adapter comply with the user-accessible surface temperature limits defined by the International Standard for Safety of Information Technology Equipment (IEC 60950).

 **NOTE:** The fan in the computer starts up automatically to cool internal components and prevent overheating. It is normal for the internal fan to cycle on and off during operation.

---

## An external device is not working

Follow these suggestions if an external device does not function as expected:

- Turn on the device according to the manufacturer's instructions.
- Be sure that all device connections are secure.
- Be sure that the device is receiving electrical power.
- Be sure that the device, especially if it is older, is compatible with the operating system.
- Be sure that the correct drivers are installed and updated.

## The wireless network connection is not working

If a wireless network connection is not working as expected, follow these suggestions:

- To enable or disable a wireless or wired network device, click the **Network Connection** icon on the Windows desktop in the notification area, at the far right of the taskbar. To enable a device, click on the

device name, and then click **Connect**. To disable the device, click on the device name, and then click **Disconnect**.

- Be sure that the wireless device is turned on.
- Be sure that the computer wireless antennas are free from obstructions.
- Be sure that the cable or DSL modem and its power cord are properly connected and that the lights are on.
- Be sure that the wireless router or access point is properly connected to its power adapter and to the cable or DSL modem, and that the lights are on.
- Disconnect and then reconnect all cables, and turn the power off and then back on.

## A disc does not play

- Save your work and close all open programs before playing a CD or a DVD.
- Log off the Internet before playing a CD or a DVD.
- Be sure that you insert the disc properly.
- Be sure that the disc is clean. If necessary, clean the disc with filtered water and a lint-free cloth. Wipe from the center of the disc to the outer edge.
- Check the disc for scratches. If you find scratches, treat the disc with an optical disc repair kit available at many electronics stores.
- Disable Sleep mode before playing the disc.

Do not initiate Sleep while playing a disc. Otherwise, you may see a warning message asking if you want to continue. If this message is displayed, click **No**. After you click No, the computer may behave in either of the following ways:

- Playback may resume.

– or –

- The playback window in the multimedia program may close. To return to playing the disc, click the **Play** button in your multimedia program to restart the disc. In rare cases, you may need to exit the program and then restart it.

## A movie is not visible on an external display

1. If both the computer display and an external display are turned on, press **fn+f4** one or more times to switch between the 2 displays.
2. Configure the monitor settings to make the external display primary:
  - a. From the Windows desktop, right-click on a blank area of the computer desktop, and select **Screen resolution**.
  - b. Specify a primary display and a secondary display.



---

**NOTE:** When using both displays, the DVD image will not appear on any display designated as the secondary display.

---

## The process of burning a disc does not begin, or it stops before completion

- Be sure that all other programs are closed.
- Turn off Sleep mode.
- Be sure that you are using the right kind of disc for your drive.
- Be sure that the disc is inserted properly.
- Select a slower write speed and try again.
- If you are copying a disc, save the information on the source disc to your hard drive before trying to burn the contents to a new disc, and then burn from your hard drive.

---

## C Electrostatic discharge

Electrostatic discharge is the release of static electricity when two objects come into contact—for example, the shock you receive when you walk across the carpet and touch a metal door knob.

A discharge of static electricity from fingers or other electrostatic conductors may damage electronic components. To prevent damage to the computer, damage to a drive, or loss of information, observe these precautions:

- If removal or installation instructions direct you to unplug the computer, unplug it after being properly grounded and before removing a cover.
- Keep components in their electrostatic-safe containers until you are ready to install them.
- Avoid touching pins, leads, and circuitry. Handle electronic components as little as possible.
- Use nonmagnetic tools.
- Before handling components, discharge static electricity by touching an unpainted metal surface of the component.
- If you remove a component, place it in an electrostatic-safe container.

If you need more information about static electricity or assistance with component removal or installation, contact HP support.



# Index

## Symbols/Numerics

- 2-finger click TouchPad gestures 26
- 2-finger pinch zoom TouchPad gesture 26

## A

- AC adapter, testing 44
- accessibility 80
- administrator password 55
- antivirus software 60
- audio functions, checking 33
- audio-out (headphone)/audio-in (microphone) combo jack, identifying 3

## B

- Backup and Restore 67
- backup tools 65
- backups
  - creating 66
  - recovering 67
- battery
  - conserving power 43
  - discharging 41
  - displaying remaining charge 41
  - disposing 43
  - low battery levels 41
  - removing 42
  - replacing 43
- battery light 15
- battery power 40
- BIOS
  - determining version 72
  - downloading an update 72
  - updating 72
- Bluetooth device 17, 22
- Bluetooth label 78
- buttons
  - left pointing stick 8
  - left TouchPad 8
  - optical drive eject 5, 6
  - power 10, 38
  - right pointing stick 8
  - right TouchPad 8

- volume 32
- Windows button 12, 13

## C

- cables
  - USB 49
- caps lock light, identifying 9
- caring for your computer 63
- checking audio functions 33
- cleaning your computer 63
- components
  - bottom 14
  - display 7
  - front 15
  - left side 5
  - rear 16
  - right side 3
  - top 8
- Computer Setup
  - BIOS administrator password 56
  - DriveLock password 58
  - navigating and selecting 70
  - restoring factory settings 71
- computer, traveling 81
- connecting to a WLAN 20
- connector, power 4
- conservation, power 43
- corporate WLAN connection 20
- critical battery level 38
- critical updates, software 61

## D

- Disk Cleanup software 52
- Disk Defragmenter software 52
- docking port, identifying 4
- docking station support holes, identifying 14
- drive light 15
- drive media 39
- DriveLock
  - disabling 59
  - enabling 59
- DriveLock master password changing 60

- DriveLock password
  - changing 60
  - description 58
  - entering 60
  - setting 58
- Driver Recovery DVD, creating 65
  - using for restore 68
- drives
  - external 50
  - hard 50
  - optical 51
  - using 52
- Dual-Mode DisplayPort, connecting 35
- Dual-Mode DisplayPort, identifying 3

## E

- electrostatic discharge 86
- embedded numeric keypad, identifying 12, 29
- esc key, identifying 12, 13
- external AC power, using 43
- external devices 50
- external drive 50
- external monitor port 16, 34

## F

- f11 recovery 68
- fingerprint reader 62
- fingerprint reader, identifying 11
- firewall software 60
- fn key, identifying 12, 13
- function keys, identifying 12, 13

## G

- GPS 22

## H

- hard drive
  - external 50
  - HP 3D DriveGuard 53
- hard drive light 53
- hard drive recovery 68

- headphones and microphones, connecting 33
- Hibernation
  - exiting 39
  - initiating 39
- high-definition devices, connecting 35
- hot keys
  - microphone mute 28
- HP 3D DriveGuard 53
- HP Battery Check 40
- HP Client Security 61
- HP Mobile Broadband, disabled 21
- HP Mobile Connect 22
- HP PC Hardware Diagnostics (UEFI) using 75
- HP Recovery Disc Creator, using 65
- HP Recovery partition
  - checking for presence 68
  - using for recovery 68
- HP Touchpoint Manager 61
- hubs 48

- I**
- input power 79
- integrated numeric keypad, identifying 13, 30
- integrated webcam light, identifying 7
- Intel Wireless Display 35
- internal microphones, identifying 7
- Internet connection setup 19
- issues, resolving 82

- J**
- jacks
  - audio-out (headphone)/audio-in (microphone) combo 3
  - network 4
  - RJ-45 (network) 4
- Java Card
  - defined 46
  - inserting 47
  - removing 48

- K**
- keypad
  - embedded numeric 12
  - identifying 29
  - integrated numeric 13

- keypad, external
  - num lock 31
  - using 31
- keypads, identifying 30
- keys
  - esc 12, 13
  - fn 12, 13
  - function 12, 13
  - volume 32
  - Windows applications 12

- L**
- labels
  - Bluetooth 78
  - Microsoft Certificate of Authenticity 77
  - regulatory 78
  - serial number 77
  - wireless certification 78
  - WLAN 78
- legacy support, USB 70
- lights
  - battery 15
  - caps lock 9
  - drive 15
  - microphone mute 9
  - num lock 9
  - power 9, 15
  - RJ-45 (network) 4
  - webcam 7
  - wireless 9, 15
- lights, hard drive 53
- low battery level 41

- M**
- maintenance
  - Disk Cleanup 52
  - Disk Defragmenter 52
- memory card 39
  - inserting 45
  - removing 45
  - supported formats 45
- memory card reader, identifying 4
- microphone mute key, identifying 28
- microphone mute light, identifying 9
- Microsoft Certificate of Authenticity label 77

- mouse, external
  - setting preferences 24
- MultiStream Transport 36

- N**
- network jack, identifying 4
- NFC antenna, identifying 7
- num lk key, identifying 29, 30
- num lock light 9
- num lock, external keypad 31

- O**
- operating environment 79
- optical drive 51
- optical drive eject button, identifying 5, 6
- optical drive light, identifying 5
- optical drive, identifying 5, 6
- optional external devices, using 50

- P**
- passwords
  - administrator 55
  - BIOS administrator 56
  - DriveLock 58
  - user 55
- pointing devices, setting preferences 24
- pointing stick 8
- ports
  - DisplayPort 35
  - Dual-Mode DisplayPort 3
  - external monitor 16, 34
  - Intel Wireless Display 35
  - serial 16
  - USB 3.0 charging (powered) 3
  - USB Type-C (charging) 3
  - VGA 34
- power
  - battery 40
  - conserving 43
  - options 38
- power button 38
- power button, identifying 10
- power connector, identifying 4
- power lights 9, 15
- power switch 38
- power-saving states 38
- product name and number, computer 77
- public WLAN connection 20

## R

- readable media 39
- recovery media, creating 65
- recovery media, using for restore 68
- recovery partition 68
- recovery tools 65
- recovery tools, Windows 67
- recovery, system 67
- regulatory information
  - regulatory label 78
  - wireless certification labels 78
- restoring the hard drive 68
- RJ-45 (network) jack, identifying 4
- RJ-45 (network) lights, identifying 4
- rotating TouchPad gesture 27

## S

- scrolling TouchPad gesture 25
- security cable slot, identifying 5
- security, wireless 20
- serial number 77
- serial number, computer 77
- serial port, identifying 16
- setting password protection on wakeup 40
- setting power options 38
- setup of WLAN 19
- setup utility
  - navigating and selecting 70
  - restoring factory settings 71
- shutdown 38
- SIM card
  - inserting 21
- SIM card slot, identifying 3
- Sleep
  - exiting 39
  - initiating 39
- slots
  - security cable 5
  - smart card 5, 6
- smart card
  - defined 46
  - inserting 47
  - removing 48
- smart card slot 5, 6
- SoftPaqs, downloading 64
- software
  - antivirus 60

- critical updates 61
- Disk Cleanup 52
- Disk Defragmenter 52
- firewall 60
- speakers, identifying 10
- Startup Repair, using 67
- Sure Start
  - using 74
- switch, power 38

## T

- testing an AC adapter 44
- TouchPad
  - buttons 8
  - using 24
- TouchPad gestures
  - 2-finger click 26
  - 2-finger pinch zoom 26
  - rotating 27
  - scrolling 25
  - using 24
- TouchPad light, identifying 8
- TouchPad zone
  - identifying 8
- TPM settings 73
- traveling with the computer 78, 81
- troubleshooting
  - disc burning 85
  - disc play 84
- troubleshooting, external display 84
- turning off the computer 38

## U

- unresponsive system 38
- USB 3.0 charging (powered), identifying 3
- USB 3.0 port 4
- USB cable, connecting 49
- USB devices
  - connecting 49
  - description 48
  - removing 49
- USB hubs 48
- USB legacy support 70
- USB ports, identifying 4
- USB Type-C (charging) port, identifying 3
- user password 55

using

- external AC power 43
- power-saving states 38

## V

- vents, identifying 5, 6, 14
- VGA port, connecting 34
- video 34
- volume
  - adjusting 32
  - buttons 32
  - keys 32

## W

- webcam 33
- webcam (select products only) 7
- webcam light, identifying 7
- webcam, identifying 7
- Windows 7 operating system DVD
  - creating 65
  - using for restore 68
- Windows 7 operating system media
  - creating 65
  - using for restore 68
- Windows applications key, identifying 12
- Windows button, identifying 12, 13
- Windows Startup Repair, using 67
- wired displays, discovering and connecting 36
- wireless antennas, identifying 7
- wireless button 17
- wireless certification label 78
- wireless controls
  - button 17
  - operating system 17
- wireless light 9, 15, 17
- wireless network (WLAN)
  - connecting 20
  - corporate WLAN connection 20
  - equipment needed 19
  - functional range 20
  - public WLAN connection 20
  - security 20
  - using 18
- WLAN antennas, identifying 7
- WLAN device 18, 78
- WLAN label 78
- writable media 39
- WWAN antennas, identifying 7

WWAN device 17, 20