

ClearOne®

UNITE® 200 CAMERA

USER GUIDE

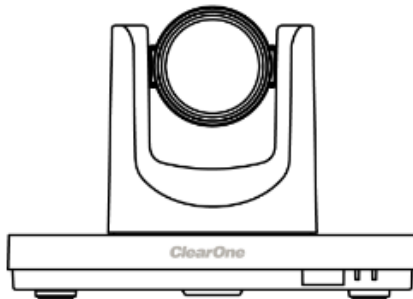

NOTE: For the UNITE 200 camera's control, use the COLLABORATE Codec Appliance's remote control. The remote control that comes with this camera is only for advanced configurations, if required.

COPYRIGHT NOTICE

ClearOne
5225WileyPostWay
Suite500
SaltLakeCity,UT84116

Telephone	1.800.283.5936
TechSales	1.800.705.2103
FAX	1.801.974.3669
E-mail	collaborate.support@clearone.com
On the Web	www.clearone.com

Unite 200 USER GUIDE

CLEARONE DOCUMENT

DOC-0263-001 REV 1.1 – Mar. 2016

© 2016 ClearOne Inc. - All rights reserved. No part of this document may be reproduced in any form or by any means without written permission from ClearOne. Printed in the United States of America. ClearOne reserves specific privileges. Information in this document is subject to change without notice.

NOTICE: This Class A device complies with Part 15 of the FCC rules and Canadian ICES-003. Operation is subject to the following two conditions: (1) this device may not cause harmful interference, and (2) this device must accept any interference received, including interference that may cause undesired operation.

CONTENTS

PREFACE	5
PRECAUTIONS	5
SUPPLIED ACCESSORIES.....	6
QUICK START.....	7
FEATURES	9
PRODUCT SPECIFICATION.....	10
MAIN UNIT.....	12
SIZE	13
IR REMOTE CONTROL	14
SERIAL COMMUNICATION CONTROL.....	17
MENU SETTING.....	19
IP FUNCTION.....	24
USB 3.0.....	32
MAINTENANCEAND TROUBLESHOOTING.....	32

PREFACE

This manual introduces the function, installation, and operation of the UNITE 200 camera. Prior to installation and usage, please read the manual thoroughly.

PRECAUTIONS

This product can be used only under the specified conditions in order to avoid any damage to the camera:

- Don't subject the camera to rain or moisture.
- Don't remove the cover; otherwise, you may get an electric shock. In case of abnormal operation, contact ClearOne Technical Support.
- Never operate outside the specified temperature, humidity, and power supply recommendations.
- Use a soft dry cloth to clean the camera. If the camera is very dirty, clean it with diluted neutral detergent; do not use any type of solvents, which may damage the surface.

Caution to transport

Avoid stress, vibration, and moisture in transport, storage and installation.

During installation, take the following precautions:

- Do not grasp the camera by the head when carrying the camera.
- Don't turn camera head manually. Doing so may result in mechanical damage.
- Don't apply corrosive liquid, gas or solid, to avoid damaging the cover which is made up of plastic material.
- Make sure there are no obstacles within the camera's rotation range.
- Never power on before installation has been completed.

Don't dismantle the camera

ClearOne is not responsible for any unauthorized modification or dismantling.

SUPPLIED ACCESSORIES

When you unpack, check that all the supplied accessories are included:

- Camera
- AC power adapter
- Power cord
- RS232 cable
- Remote controller
- User manual
- USB3.0 Cable

QUICK START

Step 1. Please ensure connections are correct before starting

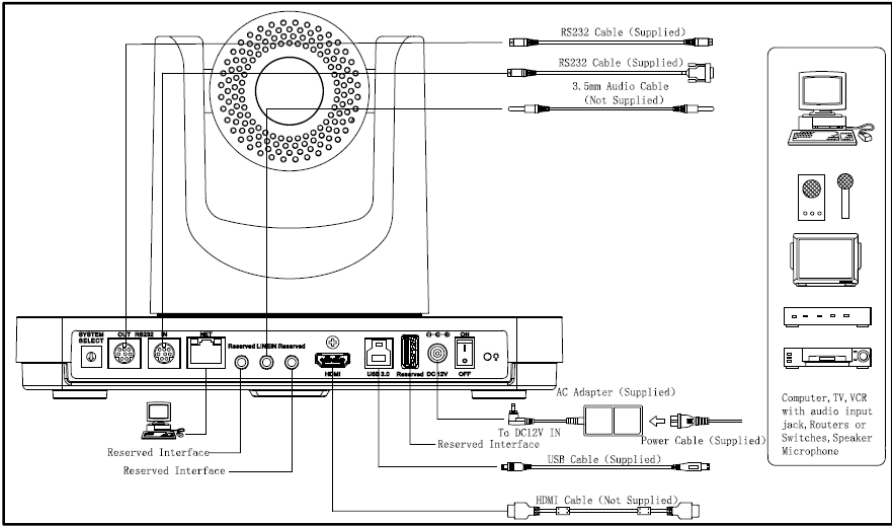

Step 2. Setting of the bottom switches

Set both of the switch1 and switch2 to 'OFF'. That is 'Normal Working Mode'.

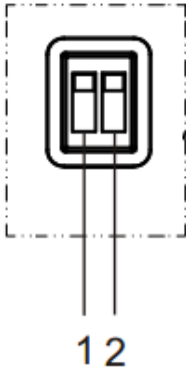

	SW-1	SW-2	Mode
1	OFF	OFF	Normal Working Mode
2	ON	OFF	-
3	OFF	ON	-
4	ON	ON	-

Step 3. Set the Video System Switch to the desired setting

Video format options:

VIDEO SYSTEM			
0	1080p60	8	720p30
1	1080p50	9	720p25
2	1080i60	A	-
3	1080i50	B	-
4	720p60	C	-
5	720p50	D	-
6	1080p30	E	-
7	1080p25	F	-

NOTE: After changing the switch, you need to restart the camera to take effect.

Step 4. Press the ON/OFF button to turn on the camera.

Step 5. When the camera starts, Pan-Tilt rotates to the maximum position of top right, then it returns to the center position. The initialization process is finished.

NOTE: If the position preset 0 has been stored, the position preset 0 will be called up after initialization. See IR Remote Control later in this manual for information about setting presets.

Step 6. (Optional) If you want to restore the factory default settings, Press the Menu button to display the On-screen Display (OSD) menu. Select the item Menu >Restore Default > Restore. Set the value Yes, and then press the HOME button to restore the factory default settings.

FEATURES

- **72.5° Wide-angle Lens**

72.5° wide-angle, high-quality lens; supports 12x optical zoom.

- **USB 3.0**

USB3.0 ultra-high speed interface; can transfer uncompressed original video, and downward compatible with USB2.0. The USB, HDMI, and Network interfaces can output at the same time.

- **AAC Audio Encoding**

Supports audio line input. Supports AAC audio encoding, for better sound quality and lower bandwidth.

- **H.265 Support**

Supports H.265 encoding, enabling full HD 1080p/60fps video stream at ultra-low bandwidth.

- **1080P Full HD**

A 1/2.7 inch, 2.07 million effective pixels high quality HD CMOS sensor, can reach maximum 1920 x 1080 resolutions, achieving a high quality image.

- **Ultra-high Frame Rate**

Output frame rate up to 60fps in 1080p.

- **Low-light**

High SNR of CMOS sensor, combined with 2D and 3D noise reduction algorithm, effectively reduces the noise, even under low illumination conditions, to ensure that the picture can still remain clean and clear.

- **Serial Interface Control**

All the parameters of the camera can be remotely controlled using the RS232/485 interface.

PRODUCT SPECIFICATION

Details	
Model	UNITE™ 200
Name	UNITE™ Full-HD Video Conference Camera
Camera	
Video System	HD: 1080p/60, 1080p/50, 1080i/60, 1080i/50, 1080p/30, 1080p/25, 720p/60, 720p/50, 720p/30, 720p/25
Sensor	1/2.7 inch, CMOS, Effective Pixel: 2.07M
Scanning Mode	Progressive
Lens	12x, f3.5mm - 42.3mm, F1.8 - F2.8
Minimal Illumination	0.05 Lux @ (F1.8, AGC ON)
Shutter	1/30s - 1/10000s
White Balance	Auto, Indoor, Outdoor, One Push, Manual
Backlight Compensation	Support
Digital Noise Reduction	2D&3D Digital Noise Reduction
Video S/N	≥55dB
Horizontal Angle of View	72.5° - 6.9°
Vertical Angle of View	44.8° - 3.9°
Horizontal Rotation Range	±170°
Vertical Rotation Range	-30° - +90°
Pan Speed Range	1.7° - 100°/s
Tilt Speed Range	1.7° - 69.9°/s
H & V Flip	Support
Image Freezing	Support
Number of Presets	255
Preset Accuracy	0.1°
USB Features	
Operating System	Windows 7, Windows 8, Windows 8.1, Windows 10, Mac OS X, Linux
Color System	YUV 4:2:2

Video Format	USB3.0 : 1080p/30, 1080p/25, 720p/30, 720p/25
USB Video Communication Protocol	UVC1.0
UVC PTZ	Support
Network Features	
Video Compression	H.265/H.264/MJPEG
Video Stream	Main Stream, Sub Stream
Main Stream Resolution	1920x1080, 1280x720, 1024x576
Sub Stream Resolution	720x576, 720x480, 320x240
Video Bit Rate	128Kbps - 8192Kbps
Bit Rate Type	Variable Rate, Fixed Rate
Frame Rate	50Hz: 1fps - 50fps, 60Hz: 1fps - 60fps
Audio Bit Rate	96Kbps, 128Kbps, 256Kbps
Support Protocols	TCP/IP, HTTP, RTSP, RTMP, DHCP, Multicast, etc.
Input/ Output Interface	
HD Output	1xHDMI: Version 1.3
Network Interface	1xRJ45: 10M/100M Adaptive Ethernet port
Audio Interface	1-ch: 3.5mm Audio Interface, Line In
USB	1xUSB3.0: Type B female jack
	1xUSB2.0: Type A female jack(Reserved Interface)
Communication Interface	1xRS-232 IN: 8pin Min DIN, Max Distance: 30m, Protocol: VISCA/Pelco-D/Pelco-P
	1xRS-232 OUT: 8pin Min DIN, Max Distance: 30m, Protocol: VISCA network use only
	1xRS485: Share with RS232 Out, Max Distance: 1200m, Protocol: VISCA/Pelco-D/Pelco-P
Power Jack	JEITA type (DC IN 12V)
Generic Specification	
Input Voltage	DC 12V
Current Consumption	1.5A (Max)
Operating Temperature	-10°C - 40°C
Storage Temperature	-40°C - 60°C

Power Consumption	12W (Max)
Dimensions	240mm x 144mm x 160mm
Weight	1.65Kg (3.6lb)

MAIN UNIT

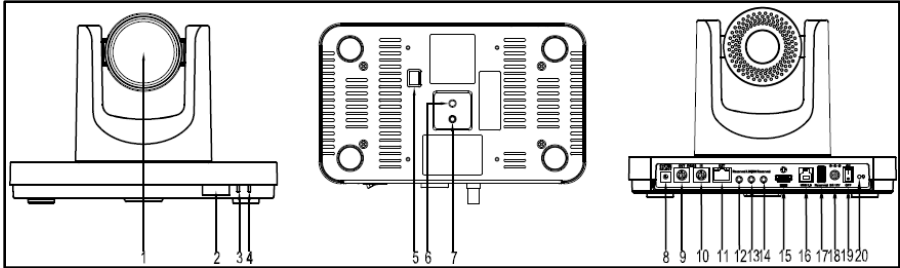

- | | |
|----------------------------------|-------------------------|
| 1. Lens | 11. RJ45 Interface |
| 2. Sensor for the Remote Control | 12. Reserved Interface |
| 3. Power Lamp | 13. Line In Interface |
| 4. Standby Lamp | 14. Reserved Interface |
| 5. Bottom Switches | 15. HDMI Interface |
| 6. Tripod Screw Hole | 16. USB 3.0 |
| 7. Fixing Screw Hole | 17. Reserved Interface |
| 8. System Select Switch | 18. DC IN 12V Interface |
| 9. RS232 OUT Interface | 19. POWER Switch |
| 10. RS232 IN Interface | |

SIZE

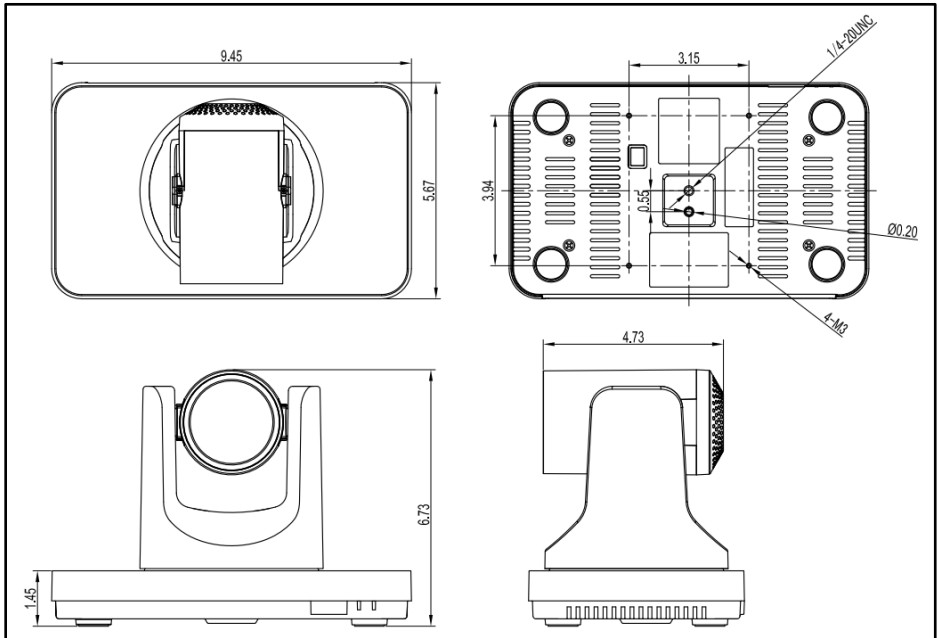

Unit: inch

IR REMOTE CONTROL

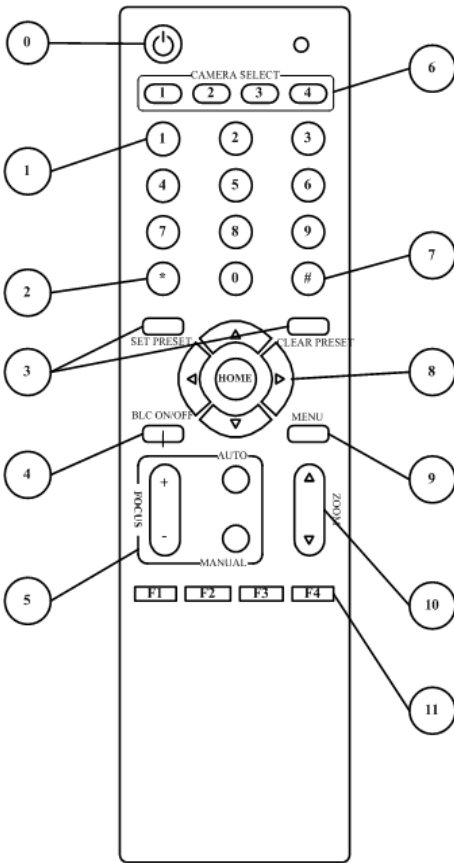

0. Standby Button

Press this button to enter standby mode. Press it again to enter normal mode.

NOTE: Power consumption in standby mode is approximately half of the normal mode.

1. Position Buttons

To set preset or call preset

2. * Button

3. Set/Clear Preset Buttons

Set preset: Store a preset position

[SET PRESET] + Numeric button (0-9):
Setting a corresponding numeric key preset position

NOTE: Preset 0-9 via remote control and the rest from web, keyboard and the serial port.

Clear preset: Erase a preset position
[CLEAR PRESET] + Numeric button

(0-9), Or: [*] + [#] + [CLEAR PRESET]: Erase all presets

4. BLC (Backlight Compensation)

Button BLC ON/OFF: Press this button to enable the backlight compensation. Press it again to disable the backlight compensation.

NOTE: Effective only in auto exposure mode.

NOTE: If there is a light behind the subject, the subject will appear dark. In this case, press the backlight ON / OFF button. To cancel this function, press the backlight ON / OFF button.

5. Focus Buttons

Used for focus adjustment.

Press [AUTO] to adjust the focus on the center of the object automatically. To adjust the focus manually, press the [MANUAL] button, and adjust it with [Focus+] (focus on far object) and [Focus-] (focus on near object).

6. Camera Select Buttons

Press the button corresponding to the camera you want to operate with the remote control.

7. # Button

8. Pan/Tilt Control Buttons

Press the arrow buttons to perform panning and tilting. Press the [HOME] button to face the camera back to front.

9. Menu Setting

Menu button: Press this button to enter or exit the OSD menu.

10. Zoom Buttons

Zoom▲: Zoom In

Zoom▼: Zoom Out

11. Multiple Function Buttons

Function 1. Set camera IR address

Press 3 keys contiguously can set camera IR address as follow:

[*] + [#] + [F1]: Address1

[*] + [#] + [F2]: Address2

[*] + [#] + [F3]: Address3

[*] + [#] + [F4]: Address4

Function 2. Image freezing function

Press [F4] to start the freeze function. The word "Freeze" displays on the upper left corner. After five seconds, the display disappears automatically (though the freeze feature continues). To cancel the freeze, press the [F4] key the word "Unfreeze" displays on the upper left corner. After five seconds, the display

disappears automatically.

Shortcut Set Function

[*] + [#] + [1]: Display OSD menu in English

[*] + [#] + [3]: Display OSD menu in Chinese

[*] + [#] + [4]: Show IP address

[*] + [#] + [6]: Quickly restore the default settings

[*] + [#] + [8]: Show the camera version

[*] + [#] + [9]: Quickly set mount mode (flip / normal)

SERIAL COMMUNICATION CONTROL

In default working mode, the camera can be controlled via RS232 or RS485 (half-duplex mode). The parameters are as follows:

Baud rate: 2400/4800/9600 bit/s.

Start bit: 1 bit.

Data bit: 8 bits.

Stop bit: 1bit.

Parity bit: none.

When the camera initializes, Pan-Tilt rotates to the maximum position of top right, then it returns to the center, and the process of initialization is finished.

(Note: If the position preset 0 has been stored, the position preset 0 is called up after initialization.) Then the users can control the camera with commands in the command list.

Control interface definition

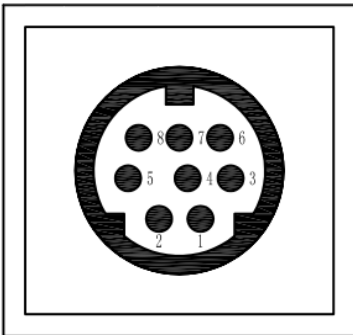

No.	Function
1	DTR
2	DSR
3	TXD
4	GND
5	RXD
6	RS485-
7	IR OUT
8	RS485+

CameraWindows DB-9

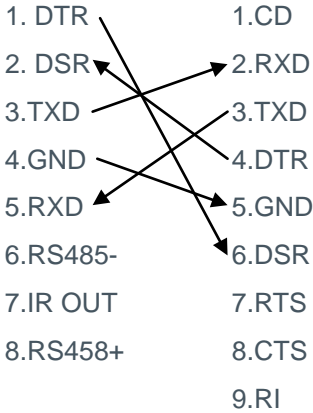

Camera In Camera Out

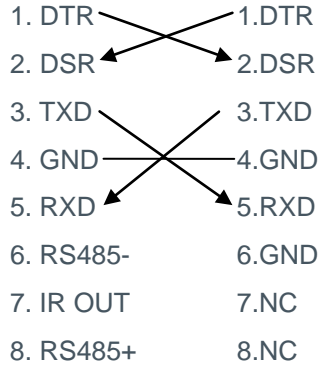

Network configuration

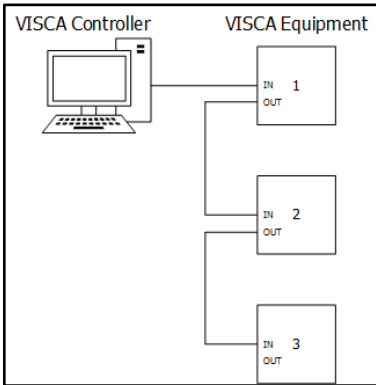

Under VISCA

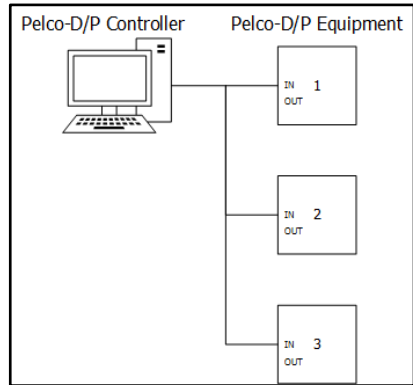

Under Pelco-D/P

Commandlist

The camera uses the VISCA/Pelco-D/Pelco-P serial standard. If you need VISCA/Pelco-D/Pelco-P protocol command list in detail, please contact ClearOne Technical Support.

MENU SETTING

1. MENU

Press the [MENU] button to display the main menu. Use the arrow buttons to select the item to be set. Press the [HOME] button to enter a sub-menu.

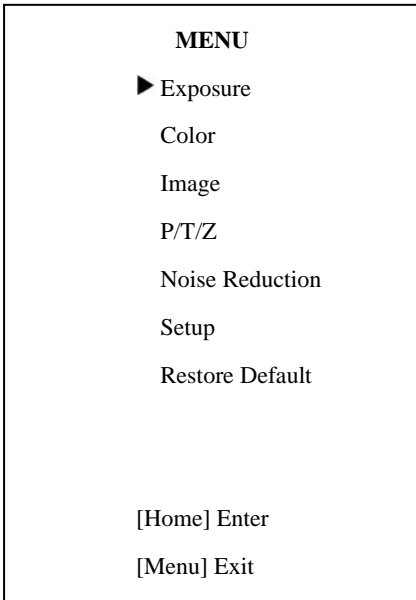

2. EXPOSURE

Select Exposure from the main menu and press the [HOME] button. The EXPOSURE menu appears, as shown in the following figure:

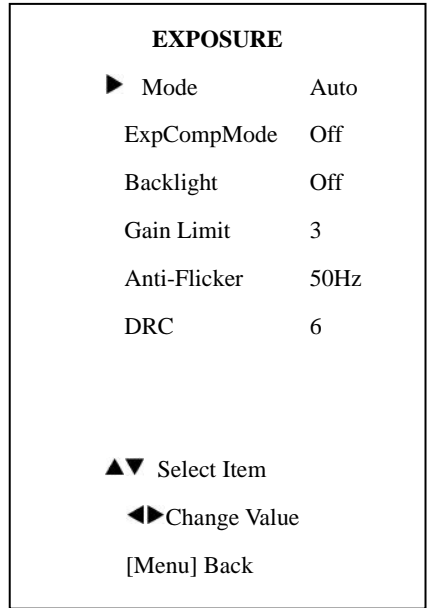

Mode: Exposure mode. Options: Auto, Manual, SAE, AAE, Bright.

ExpCompMode (Effective only when exposure mode is Auto): Exposure compensation mode. Options: On, Off.

ExpComp (Effective only when ExpCompMode is On): Exposure compensation value. Options: -7 - +7.

Gain Limit (Effective only when exposure mode is Auto/AAE/Bright): Maximum gain limit. Options: 0 - 15.

Backlight (Effective only when exposure mode is Auto): Set the backlight compensation. Options:

On, Off.

DRC: Dynamic range control strength. Options: 0 - 8.

Bright (Effective only when exposure mode is Bright): Exposure bright level, Options: 0 - 17.

Anti-Flicker (Effective only when exposure mode is Auto/Bright): Options: Off, 50Hz, 60Hz.

Iris (Effective only when exposure mode is Manual / AAE): Aperture value. Options: F1.8, F2.0, F2.4, F2.8, F3.4, F4.0, F4.8, F5.6, F6.8, F8.0, F9.6, F11.0, Close.

Shutter (Effective only when exposure mode is Manual /SAE): Shutter value. Options: 1/30,1/60, 1/90,1/100,1/125,1/180,1/250,1/350, 1/500,1/725,1/1000,1/1500,1/2000,1 /3000,1/4000,1/6000,1/10000.

3. COLOR

Select Color in the main menu and press the [HOME] button. The COLOR menu appears, as shown in the following figure:

COLOR	
▶ WB Mode	Auto
RG Tuning	0
BG Tuning	0
Saturation	90%
Hue	7
AWB sens	Low
▲▼ Select Item	
◀▶ Change Value	
[Menu] Back	

WB-Mode: White balance mode. Options: Auto, Indoor, Outdoor, One Push, Manual.

RG (Effective only when WB-Mode is Manual): Red gain. Options: 0 - 255.

BG (Effective only when WB-Mode is Manual): Blue gain. Options: 0 - 255.

RG Tuning (Effective only when AWB sens is Low): Red gain fine-tuning. Options: -10 - +10

BG Tuning (Effective only when AWB sens is Low):Blue gain fine-tuning. Options: -10 - +10

Sat.: Saturation. Options: 60% -

200%.

Hue: Chroma adjustment. Options: 0 - 14

AWB sens: White balance sensitivity. Options: Normal, High, Low.

4. IMAGE

Select Image in the main menu and press the [HOME] button. The IMAGE menu appears, as shown in the following figure:

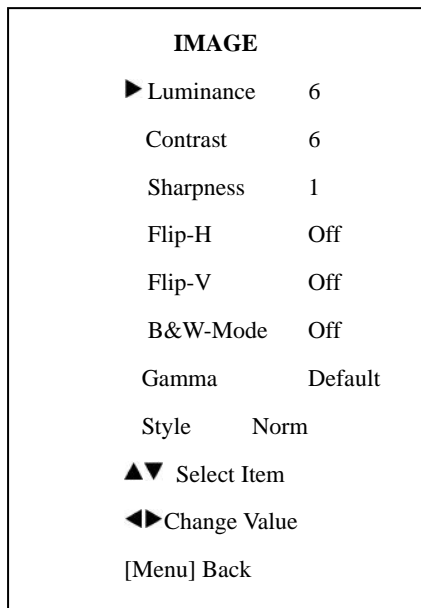

Luminance: Brightness adjustment. Options: 0 - 14

Contrast: Contrast adjustment. Options: 0 - 14

Sharpness: Sharpness adjustment.

Options: Auto, 0 - 15

Flip-H: Image flipped horizontally. Options: On, Off.

Flip-V: Image flipped vertically. Options: On, Off

B&W-Mode: Image color. Options: On, Off

Gamma: Options Default, 0.45, 0.5, 0.56, 0.63

Style: Options: Norm, Clarity, Bright, Soft.

5. P/T/Z

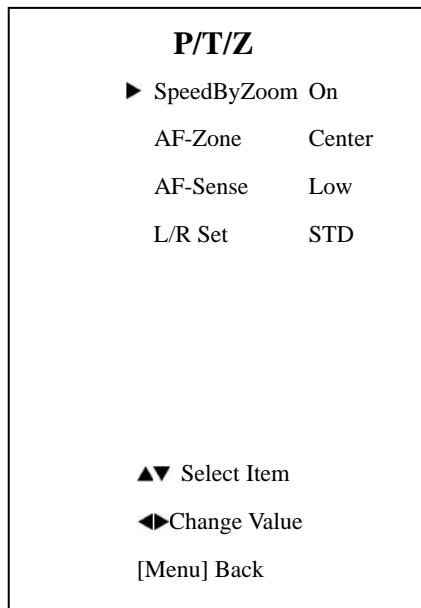

SpeedByZoom: The depth of field scale switch. Options: On, Off

AF-Zone: Interested in focusing area.

Options: Top, Center, Bottom

AF-Sense: Automatic focusing sensitivity. Options: Low, Normal, High

L/R Set: Options: STD, REV

6. NOISE REDUCTION

Select Noise Reduction in the main menu and press the [HOME] button. The NOISE REDUCTION menu appears, as shown in the following figure:

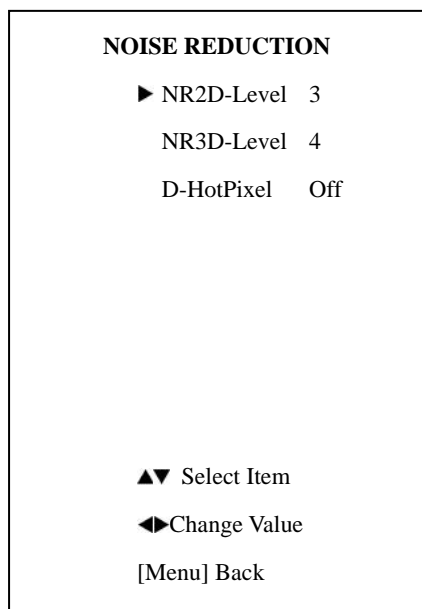

NR2D-Level: 2D noise reduction. Options: Off, Auto, 1 - 5

NR3D-Level: 3D noise reduction. Options: Off, 1 - 8

D-HotPixel: Dynamic bad points.

Options: Off, 1 – 5

7. SETUP

Select Setup in the main menu and press the [HOME] button. The SETUP menu appears, as shown in the following figure:

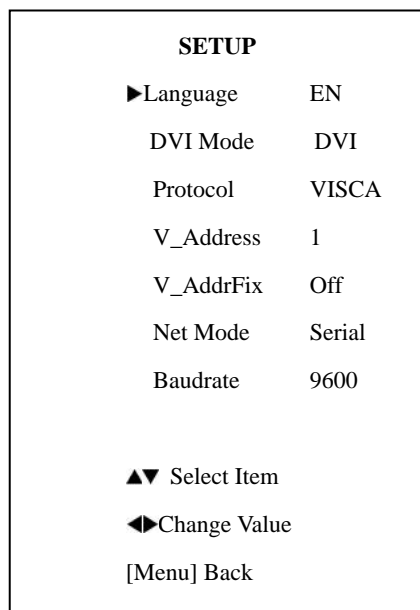

Language: Menu language. Options: EN, Chinese, and Russian

DVI Mode: Options: DVI, HDMI.

Protocol: Control protocol type. Options: AUTO, VISCA, PELCO-D, PELCO-P

V_Address: Protocol address. To be decided according to the

agreement,AUTO, VISCA protocol

Options: 1 - 7

P_D_Address: PELCO-D protocol.

Options: 0-254

P_P_Address: PELCO-P protocol.

Options: 0-31

V_AddrFix: The switch you can change camera uart address.

Options: On, Off (When set to On, the 88 30 01 FF command is invalid.)

Net Mode: Set the serial port control networking. Options: Serial, Paral

Baudrate: Serial port baud rate.

Options: 2400, 4800, 9600

8. RESTORE DEFAULT

Select Restore Default in the main menu and press the [HOME] button.

The RESTORE DEFAULT menu appears, as shown in the following figure:

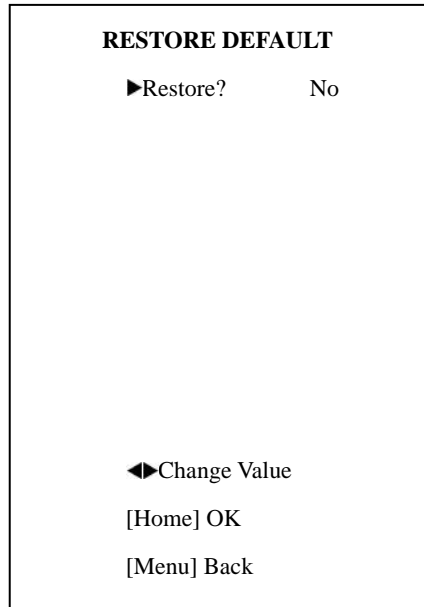

Restore: Confirm restore factory settings. Options: Yes, No

NOTE: Press the [HOME] button to confirm.

IP FUNCTION

1. Operating Environment

Operating System: Windows
7/8/8.1/10

Note: Using the included utility programs requires Windows, but using the Web interface does not require any particular operating system.

Network Protocol: TCP/IP

2. Equipment Installation

1) Connect the camera to your network or to your PC directly via an Ethernet cable.

Note: To connect the camera directly, use an Ethernet crossover cable.

2) Turn on the camera.

3) If the orange light of internet port is on and the green light is flashing, then the camera is connected to the network or to your computer.

3. Internet Connection

Ways to connect the camera and a computer are shown in the figures below:

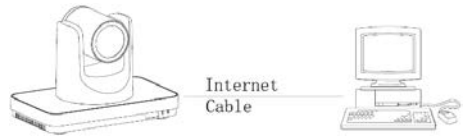

Connect directly by Ethernet crossover cable

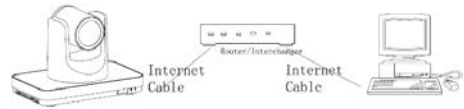

Connect via router/switch

4. Access the camera though LAN.

4.1. Setup IP address

The camera's default IP address is 192.168.100.88. If you forget the camera's IP address, use one of the methods to find the IP address as below:

Method 1: press * and # and 4 on the remote control to display the camera IP address on-screen.

Method 2: Connect the camera to a PC with an Ethernet cable, and run "upgrade_En.exe"(contact ClearOne technical support to get this tool) to find the camera's IP address.

To change the camera's IP address, use one of the methods as below:

Method 1:

- Open the camera's Web interface (see Access Camera's Web Interface later in this Manual for detailed instructions).
- On Web interface page, find "Network"--->Change IP. Enter a new IP address, then Click "Apply".
- Restart camera.

The screenshot shows the 'Lan Settings' page of a camera's web interface. The page is divided into several sections: 'Lan Settings', 'Port Settings', 'Control Protocol Settings', 'RTMP Settings', 'RTSP Settings', 'ONVIF Setting', and 'Multicast Settings'. Under 'Lan Settings', the 'IP Configuration Type' is set to 'Fixed IP Address'. The 'IP Address' is 192.168.100.88, 'Subnet Mask' is 255.255.255.0, 'Gateway' is 192.168.100.1, 'DNS Address' is 192.168.100.1, and 'MAC Address' is D4: E0: 8E: D8: 18: 06. Under 'Port Settings', 'HTTP Port number' is 80, 'RTSP Port' is 554, and 'PTZ Port' is 5678. Under 'Control Protocol Settings', 'Visca Address' is 1, 'Pelco-D Address' is 0, and 'Pelco-P Address' is 0. Under 'RTMP Settings', 'First stream' and 'Second stream' are both set to 'On' with 'Video' and 'Audio' options. Under 'RTSP Settings', 'RTSP Auth' is set to 'On'. Under 'ONVIF Setting', 'ONVIF' and 'ONVIF Auth' are both set to 'On'. Under 'Multicast Settings', 'Multicast' is set to 'On' with 'Address' 224.1.2.3 and 'Port' 6598. 'Apply' and 'Cancel' buttons are at the bottom.

Method 2: Run "upgrade_En.exe", change the IP address, and then click "Set". The camera will restart.

The screenshot shows the 'UPGRADE v1.9' utility window. It has tabs for 'Search', 'Upgrade', 'Config', and 'Backup'. The 'Config' tab is active, showing network settings. 'Mode' is set to 'Manual'. 'IP Address' is 192.168.100.88, 'Mask' is 255.255.255.0, 'Gateway' is 192.168.100.1, and 'First DNS' is 192.168.100.1. 'MAC Address' is D4: E0: 8E: D8: 18: 06. There are 'Set' and 'Reset' buttons. A 'Language' dropdown is set to 'English'.

4.2. Access camera's web

Input <http://192.168.100.88> into a browser (Internet Explorer and Firefox work best).

Note: If you have changed the camera's IP address, enter the new address.

Note: To access the camera using an IP address, you must be on the same network as the camera.

A login window appears. Input the user name: (default is "admin" and password (default is "admin", as shown below (the login window may not look exactly like this, depending on your operating system and browser) :



After login, the Web interface appears, as shown below:



NOTE: If this is the first time using the web interface, you must install the VLC player software.

5. Access the camera though WAN.

5.1. Dynamic DNS setup for accessing the camera

Once you have set a domain name to camera, and forwarded the traffic to the traffic to the correct address and port number, then you can use a domain name to access camera. Access link: <http://hostname:port>

number.

For example, set up host computer name as: *youdomain.f3322.org*, camera port number: 554. Access link would be: <http://youdomain.f3322.org:554>.

5.2. VLC stream media player monitoring

VLC media server procedure
Open VLC media player, click "Media"->"Open Network Steam", or type "Ctrl+N".

Input stream address:

`rtsp://ipaddress:port number/1` (Main stream).

Example: `rtsp://192.168.100.88:554/1`

`rtsp://ipaddress:port number/2` (Sub stream).

Example: `rtsp://192.168.100.88:554/2`

NOTE:The default RTSP port number is 554.

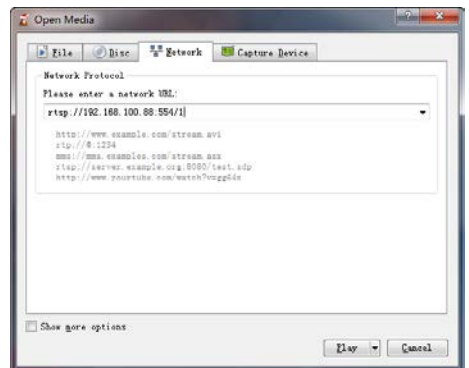

6. IP Camera parameter setup

6.1. Homepage introduction

Menu

All pages include two menu bars:

Real time monitoring: displaying video image

Parameter setup: with function buttons

Video viewing window

Video viewing window must be same as video resolution; the bigger the resolution, the bigger the playing area. Double-click the viewing window to show full-screen; double-click again to return to initialized size.

PTZ Setup

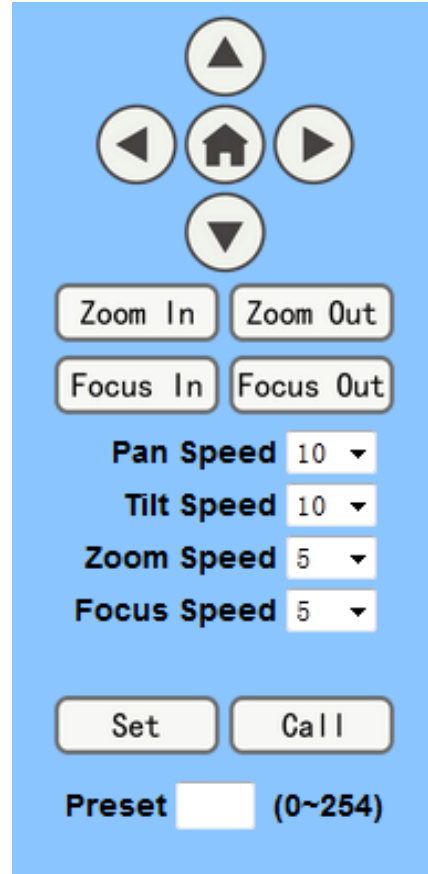

- 1) Pan-Tilt control: Up, Down, Left, Right, Home button as shown above.
- 2) Rate: Vertical speed can be chosen as 1 - 24, horizontal direction at the rate of 1 - 20. Select corresponding speed and click direction button to realize PTZ speed increase or decrease.
- 3) Zoom In/ Zoom out: for zooming

in or zooming out. Focus In/ Focus Out: Focusing on distant objects or Focusing on close objects.

4) Set/Call: When PTZ has been set to a desired position, you can save that configuration as a preset for later use. Click the “Set” button to save a preset. At any point later, you can click the “Call” button to call this preset.

6.2. Media

For Video Setup, Select "Video".

Video Settings

Video Format:

Encode Protocol:

Encode Level:

First stream

Resolution:

Bit Rate: (32~8192) kbps

Frame Rate: fps

I Key Frame Interval: (2~150)

Bit Rate Control: CBR VBR

Fluctuate Level:

Second stream

Resolution:

Bit Rate: (32~6144) kbps

Frame Rate: fps

I Key Frame Interval: (2~150)

Bit Rate Control: CBR VBR

Fluctuate Level:

1) Video format

Supports 50HZ (PAL) and 60HZ

(NTSC), and Dial priority.

2) Encode Protocol

Supports H.264 and H.265.

3) Encode Level

Supports baseline, main profile, and high profile.

4) Resolution

Main bit rate supports 1920x1080, 1280x720 and 1024x576. Minor bit rate supports 720x480, 720x576 and 320x240. The higher the resolution, the clearer the image will be, but more network bandwidth will be used.

5) Bit Rate

User can assign bit rate/stream. Generally speaking, the higher bit rate is, and the clearer the image will be. The bit allocation must combine with network bandwidth. If the network bandwidth is too low and the allocated bit rate is too high, the video quality will suffer.

6) Frame rate

You can specify the size of the frame rate. Generally speaking, the greater the frame rate, the smoother the image; the smaller the frame rate, the chopier the image.

7) 1 key frame interval:

Set interval between 2 1 frame. The bigger the interval, lower the response will be from viewing window.

8) Bit Rate control

Options:

Constant bit rate: video coder will be coding according to preset speed

Variable bit rate: video coder will adjust the speed based on preset speed to gain the best image quality

9) Fluctuate level

Restrain the fluctuation magnitude of variable rate. Options: 1 - 6

6.3. Image Setup, Click “Image.”



1) Brightness

Image brightness, 0 -14, slider control, on the right shows the corresponding numerical value. The default value is 6.

2) Saturation

Saturation 0 - 14, slider control, on the right shows the corresponding numerical value. The default value is 3.

3) Contrast

Contrast 0 - 14, slider control, on the right shows the corresponding numerical value. The default value is 6.

4) Sharpness

Sharpness 0 - 15, slider control, on the right shows the corresponding numerical value. The default value is 1.

5) Hue

Hue 0 - 14, slider control, on the right shows the corresponding numerical value. The default value is 7.

6) Flip & Mirror

Select Flip to turn the image upside down; select Mirror to flip the image horizontally. The default value for both is not selected.

7) Button

After adjusting any parameters, click “Apply” to save the settings or click “Cancel” to cancel the adjustment of the parameters. Click “Default” to revert to the default value.

6.4. Audio Setup, Click “Audio.”

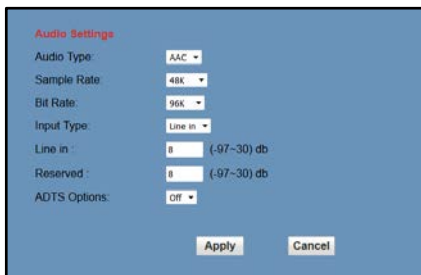

1) Audio Type

Option: AAC.

2) Sample rate

Options: 44.1K and 48K.

3) Bit rate

Options: 96K, 128K, 256K.

4) Input Type

Option: line in only

5) Line in:

The gain of the Line in.

6) Reserved

7) Apply Button

Click "Apply" to save changes, or click "Cancel" to discard the changes.

6.5. System setting, please click

“System”

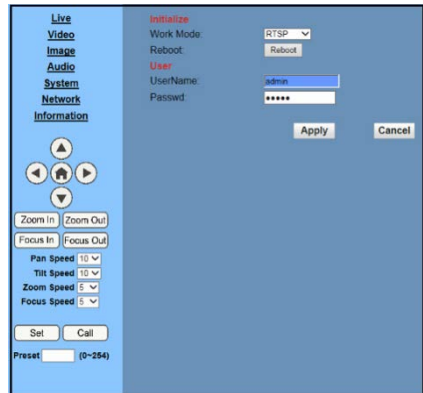

1) Work Mode

Work Mode RTSP

2) Reboot

Click the "Reboot" button to restart the system.

3) User and password

You can modify the password (letters and numbers only)

4) Apply / Cancel

Modify password and click "Apply" to change the password, or click "Cancel" to cancel password change.

6.6. Network Setting, Click “Network.”

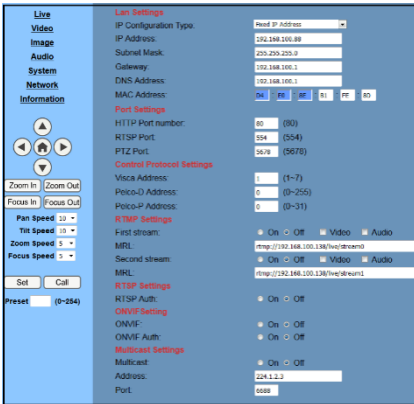

1) LAN Settings

The default IP address is 192.168.100.88. The MAC address can be modified.

2) Port Settings

HTTP Port, Default port number: 80
 RTSP Port, Supports the RTSP protocol. Default port number: 554.
 PTZ Port, Supports PTZ protocol. Default port number: 5678.

3) Control Protocol Setting

Camera control communication protocols include Visca address, Pelco-D address, and Pelco-P address.

4) RTMP Setting

When configuring the camera stream, can set up two streams, in the two stream selection control code stream of "On", "Off", "Video",

"Audio", etc.

5) RTSP Setting

Setting network camera RTSP protocol of "On", "Off".

6) Multicast Setting

Multicast switch, multicast address (default address 224.1.2.3) and port (default port number: 6688) can be set.

7) Apply / Cancel

Modify network parameters then click "Apply" to save the changes, or click "Cancel" to discard the changes.

6.7. Device Information

Click "Information", the current device information as shown below.

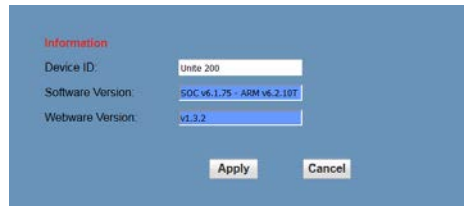

USB 3.0

Camera supports UVC protocol, compatible with USB 2.0 & USB 3.0.

USB 3.0 supports 1920x1080p/30 max output.

Support OS: Windows 7/8/8.1/10, Linux, Mac OS, etc.

General software as follows:

Windows: AMCAP, VLC, Debut Video Capture, etc.

Linux: V412 software driver and VLC media player, etc.

Mac OS: FaceTime, iChat, Photo Booth and Debut Video Capture, etc.

NOTE: We recommend using AMCAP version 8.0 in Windows, as its software performance is more stable. When using the high version of AMCAP in a low configuration system, it will slow the stream rendering.

NOTE: The first time the camera is accessed by USB cable, you must install a plug-in.

MAINTENANCE AND TROUBLESHOOTING

Camera Maintenance

- If camera will not be used for a long time, turn off the power switch and disconnect.
- AC power cord of AC adapter to the outlet.
- Use a soft cloth to clean the camera cover.
- Use the soft dry cloth to clean the lens. If the camera is very dirty, clean it with diluted neutral detergent. Do not use any type of solvents, which may damage the surface.

Unqualified Application

- Do not shoot extremely bright objects for a long period of time, such as sunlight, strong light sources, etc.
- Do not operate in unstable lighting conditions, otherwise image may flicker.

Troubleshooting

Problem	Solution
No image	<ol style="list-style-type: none"> 1. Check whether the power cord is connected, voltage is OK, POWER lamp is lit. 2. Check whether the camera can self-test after start up. 3. Check the BOTTOM switch and make sure the two switches are both set OFF. 4. Check the video cable to make sure it is connected correctly.
Abnormal display of image	Check the video cable to make sure it is connected correctly.
Image dithering even at widest zoom position	<ol style="list-style-type: none"> 1. Check whether the camera is fixed correctly. 2. Make sure there is nothing nearby causing vibrations.
IE browser not showing video image	When the camera is accessed the first time by Internet Explorer (or another web browser), you must install the plug-in. The first time you use this camera by internet (only for new user), you must install the player software (VLC). Please go to VLC website http://www.videolan.org/vlc/download and Install VLC (player software). After installation, log in again. You should see the video stream on the home page of the Web interface.
Unable to access IP Camera by browser	<ol style="list-style-type: none"> 1. Make sure your computer is connected to the network, to rule out cable failure or network failure caused by a virus. Make sure you can ping the computer from another machine and that the computer you're using can ping other machines on the local network or the gateway. 2. Disconnect the camera from the network, ensure that the camera and PC are connected (either directly, using a crossover cable, or via a router or switch), and then follow the directions earlier in this guide for resetting the IP address.

	<ol style="list-style-type: none"> 3. Check the server's IP address and subnet mask and gateway address. 4. Check for MAC address conflicts. 5. Make sure the HTTP port isn't occupied by other devices, or that routing rules aren't sending the traffic to a different address or port.
IP address modified incorrectly or forgot Web interface password	<p>You can recover access to the camera using the IR remote control. Press "[*] + [#] + [Manual]" to restore the default values (default IP: 192.168.100.88, default username: admin, default password: admin).</p>
The IR remote control cannot control the camera	<ol style="list-style-type: none"> 1. Change the remote control battery. 2. Check the camera working mode. 3. Check that the IR address of the Remote Commander is set correctly.
Serial communication cannot control the camera	<ol style="list-style-type: none"> 1. Check the camera working mode. 2. Check that the control cable is connected correctly.