

Inspiron M731R

Owner's Manual

Computer model: Inspiron 5735

Regulatory model: P17E

Regulatory type: P17E003



Notes, Cautions, and Warnings



NOTE: A NOTE indicates important information that helps you make better use of your computer.



CAUTION: A CAUTION indicates potential damage to hardware or loss of data if instructions are not followed.



WARNING: A WARNING indicates a potential for property damage, personal injury, or death.

© 2013 Dell Inc.

Trademarks used in this text: Dell™, the DELL logo, and Inspiron™ are trademarks of Dell Inc.; Microsoft®, Windows®, and the Windows start button logo are either trademarks or registered trademarks of Microsoft Corporation in the United States and/or other countries; Bluetooth® is a registered trademark owned by Bluetooth SIG, Inc. and is used by Dell under license.

Contents

Before Working Inside Your Computer	9
Before You Begin	9
Recommended Tools	9
Safety Instructions	10
After Working Inside Your Computer	11
Removing the Battery	12
Procedure	12
Replacing the Battery	13
Procedure	13
Removing the Optical Drive	14
Prerequisites	14
Procedure	14
Replacing the Optical Drive	16
Procedure	16
Postrequisites	16
Removing the Keyboard	17
Prerequisites	17
Procedure	17
Replacing the Keyboard	19
Procedure	19
Postrequisites	19
Removing the Base Cover	20
Prerequisites	20
Procedure	20
Replacing the Base Cover	21
Procedure	21
Postrequisites	21

Removing the Memory Module(s)	22
Prerequisites	22
Procedure	22
Replacing the Memory Module(s)	23
Procedure	23
Postrequisites	23
Removing the Hard Drive	24
Prerequisites	24
Procedure	24
Replacing the Hard Drive	26
Procedure	26
Postrequisites	26
Removing the Coin-Cell Battery	27
Prerequisites	27
Procedure	27
Replacing the Coin-Cell Battery	28
Procedure	28
Postrequisites	28
Removing the Palm Rest	29
Prerequisites	29
Procedure	29
Replacing the Palm Rest	32
Procedure	32
Postrequisites	32
Removing the Wireless Card	33
Prerequisites	33
Procedure	33
Replacing the Wireless Card	35
Procedure	35
Postrequisites	35

Removing the I/O Board	36
Prerequisites	36
Procedure	36
Replacing the I/O Board	37
Procedure	37
Postrequisites	37
Removing the System Board	38
Prerequisites	38
Procedure	39
Replacing the System Board	42
Procedure	42
Postrequisites	43
Removing the Fan	44
Prerequisites	44
Procedure	44
Replacing the Fan	45
Procedure	45
Postrequisites	45
Removing the Heat Sink	46
Prerequisites	46
Procedure	46
Replacing the Heat Sink	47
Procedure	47
Postrequisites	47
Removing the Hard-Drive Interposer Board	48
Prerequisites	48
Procedure	48
Replacing the Hard-Drive Interposer Board	49
Procedure	49
Postrequisites	49

Removing the Speakers	50
Prerequisites	50
Procedure	51
Replacing the Speakers	52
Procedure	52
Postrequisites	52
Removing the Display Assembly	53
Prerequisites	53
Procedure	54
Replacing the Display Assembly	55
Procedure	55
Postrequisites	55
Removing the Display Bezel	56
Prerequisites	56
Procedure	57
Replacing the Display Bezel	58
Procedure	58
Postrequisites	58
Removing the Display Hinges	59
Prerequisites	59
Procedure	60
Replacing the Display Hinges	61
Procedure	61
Postrequisites	61
Removing the Display Panel	62
Prerequisites	62
Procedure	63
Replacing the Display Panel	64
Procedure	64
Postrequisites	64

Removing the Camera Module	65
Prerequisites	65
Procedure	66
Replacing the Camera Module	67
Procedure	67
Postrequisites	67
Removing the Power-Adapter Port	68
Prerequisites	68
Procedure	69
Replacing the Power-Adapter Port	70
Procedure	70
Postrequisites	70
Flashing the BIOS	71

Before Working Inside Your Computer

Before You Begin



CAUTION: To avoid losing data, save and close all open files and exit all open programs before you turn off your computer.

- 1 Save and close all open files, exit all open programs, and turn off your computer.
 - *Windows 8:* Point to the lower or upper-right corner of the screen to open the Charms sidebar and click **Settings**→ **Power**→ **Shut down**.
 - *Windows 7:* Click **Start**  → **Shut down**.



NOTE: If you are using a different operating system, see the documentation of your operating system for shut-down instructions.

- 2 After the computer shuts down, disconnect it from the electrical outlet.
- 3 Disconnect all cables — such as power and USB cables — from your computer.
- 4 Disconnect all peripherals from your computer.









Recommended Tools

The procedures in this document may require the following tools:

- Phillips screwdriver
- Plastic scribe

Safety Instructions

Use the following safety guidelines to protect your computer from potential damage and make sure your personal safety.

-  **WARNING:** Before working inside your computer, read the safety information that shipped with your computer. For additional safety best practices information, see the Regulatory Compliance Homepage at dell.com/regulatory_compliance.
-  **WARNING:** Disconnect all power sources before opening the computer cover or panels. After you finish working inside the computer, replace all covers, panels, and screws before connecting to the power source.
-  **CAUTION:** Only a certified service technician is authorized to remove the computer cover and access any of the components inside the computer.
-  **CAUTION:** To avoid damaging the computer, make sure that the work surface is flat and clean.
-  **CAUTION:** To disconnect a network cable, first unplug the cable from your computer and then unplug the cable from the network device.
-  **CAUTION:** When you disconnect a cable, pull on its connector or on its pull-tab, not on the cable itself. Some cables have connectors with locking tabs or thumb-screws that you must disengage before disconnecting the cable. When disconnecting cables, keep them evenly aligned to avoid bending any connector pins. When connecting cables, make sure that the connectors and ports are correctly oriented and aligned.
-  **CAUTION:** Before touching anything inside your computer, ground yourself by touching an unpainted metal surface, such as the metal at the back of the computer. While you work, periodically touch an unpainted metal surface to dissipate static electricity, which could harm internal components.
-  **CAUTION:** To avoid damaging the components and cards, handle them by their edges and avoid touching pins and contacts.

After Working Inside Your Computer



CAUTION: Leaving stray or loose screws inside your computer may severely damage your computer.

- 1** Replace all screws and make sure that no stray screws remain inside your computer.
- 2** Connect any cables, peripherals, and any other part(s) you removed before working on your computer.
- 3** Connect your computer to the electrical outlet.
- 4** Turn on your computer.

Removing the Battery

⚠ WARNING: Before working inside your computer, read the safety information that shipped with your computer and follow the steps in "Before Working Inside Your Computer" on page 9. After working inside your computer, follow the instructions in "After Working Inside Your Computer" on page 11. For additional safety best practices information, see the Regulatory Compliance Homepage at dell.com/regulatory_compliance.

Procedure

- 1 Close the display and turn the computer over.
- 2 Slide the battery latches outward to unlock the battery. You hear a click when the battery is unlocked.
- 3 Lift and remove the battery off the computer base.



1 battery

2 battery latches (2)

- 4 Turn the computer over and open the display as far as possible.
- 5 Press and hold the power button for 5 seconds, after the computer is unplugged, to ground the system board.

Replacing the Battery



WARNING: Before working inside your computer, read the safety information that shipped with your computer and follow the steps in "Before Working Inside Your Computer" on page 9. After working inside your computer, follow the instructions in "After Working Inside Your Computer" on page 11. For additional safety best practices information, see the Regulatory Compliance Homepage at dell.com/regulatory_compliance.

Procedure

Align the tabs on the battery with the slots on the battery bay and snap the battery into place.

Removing the Optical Drive

⚠ WARNING: Before working inside your computer, read the safety information that shipped with your computer and follow the steps in "Before Working Inside Your Computer" on page 9. After working inside your computer, follow the instructions in "After Working Inside Your Computer" on page 11. For additional safety best practices information, see the Regulatory Compliance Homepage at dell.com/regulatory_compliance.

Prerequisites

Remove the battery. See "Removing the Battery" on page 12.

Procedure

- 1 Remove the screw that secures the optical-drive assembly to the computer base.
- 2 Using your fingertips, slide the optical-drive assembly out of the optical-drive bay.



1 screw

2 optical-drive assembly

- 3 Remove the screw that secures the optical-drive bracket to the optical-drive assembly and remove the optical-drive bracket.
- 4 Carefully pull the optical-drive bezel and remove it from the optical drive.



1	optical-drive bezel	2	optical drive
3	screw	4	optical-drive bracket

Replacing the Optical Drive



WARNING: Before working inside your computer, read the safety information that shipped with your computer and follow the steps in "Before Working Inside Your Computer" on page 9. After working inside your computer, follow the instructions in "After Working Inside Your Computer" on page 11. For additional safety best practices information, see the Regulatory Compliance Homepage at dell.com/regulatory_compliance.

Procedure

- 1 Align the tabs on the optical-drive bezel with the slots on the optical drive and snap the optical-drive bezel into place.
- 2 Align the screw hole on the optical-drive bracket with the screw hole on the optical-drive assembly and replace the screw that secures the optical-drive bracket to the optical-drive assembly.
- 3 Slide the optical-drive assembly into the optical-drive bay and align the screw hole on the optical-drive bracket with the screw hole on the computer base.
- 4 Replace the screw that secures the optical-drive assembly to the computer base.

Postrequisites

Replace the battery. See "Replacing the Battery" on page 13.

Removing the Keyboard

⚠ WARNING: Before working inside your computer, read the safety information that shipped with your computer and follow the steps in "Before Working Inside Your Computer" on page 9. After working inside your computer, follow the instructions in "After Working Inside Your Computer" on page 11. For additional safety best practices information, see the Regulatory Compliance Homepage at dell.com/regulatory_compliance.

Prerequisites

Remove the battery. See "Removing the Battery" on page 12.

Procedure

- 1 Open the display as far as possible.
- 2 Using a plastic scribe, pry the keyboard from the tabs on the palm rest.

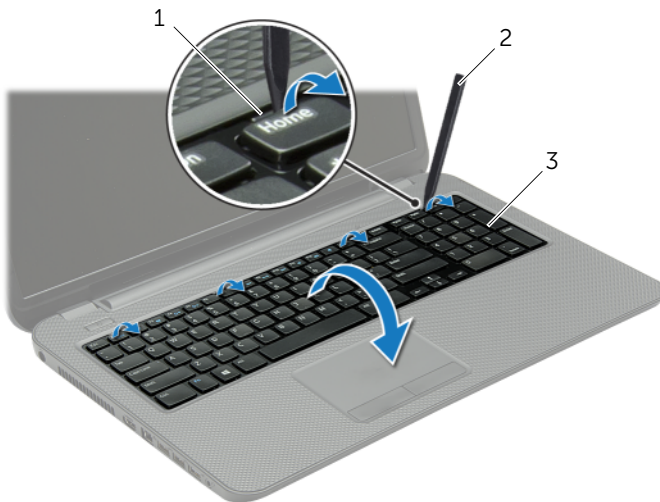

1 tabs (4)

2 plastic scribe

3 keyboard

- 3 Turn the keyboard over and place it on the palm rest.
- 4 Lift the connector latch and disconnect the keyboard cable from the keyboard-cable connector.
- 5 Lift the keyboard off the palm rest.

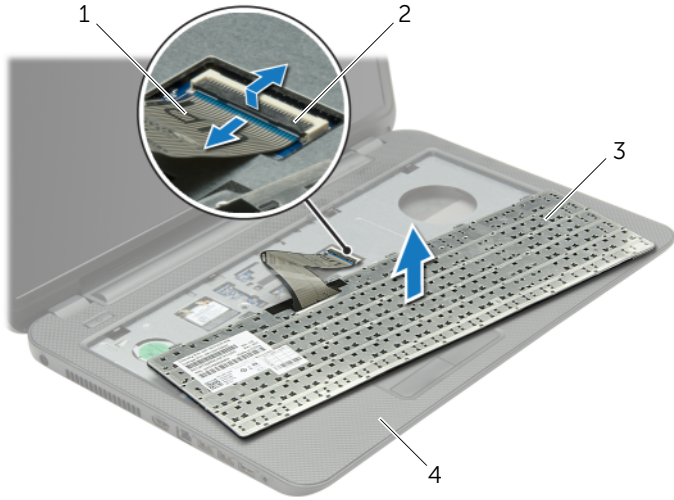

1	keyboard cable	2	connector latch
3	keyboard	4	palm rest

Replacing the Keyboard



WARNING: Before working inside your computer, read the safety information that shipped with your computer and follow the steps in "Before Working Inside Your Computer" on page 9. After working inside your computer, follow the instructions in "After Working Inside Your Computer" on page 11. For additional safety best practices information, see the Regulatory Compliance Homepage at dell.com/regulatory_compliance.

Procedure

- 1 Slide the keyboard cable into the keyboard-cable connector and press down on the connector latch to secure the cable.
- 2 Slide the tabs at the bottom of the keyboard into the slots on the palm-rest and place the keyboard on the palm rest.
- 3 Gently press around the edges of the keyboard to secure the keyboard under the tabs on the palm rest.
- 4 Replace the screws that secure the keyboard to the computer base.

Postrequisites

Replace the battery. See "Replacing the Battery" on page 13.

Removing the Base Cover

⚠ WARNING: Before working inside your computer, read the safety information that shipped with your computer and follow the steps in "Before Working Inside Your Computer" on page 9. After working inside your computer, follow the instructions in "After Working Inside Your Computer" on page 11. For additional safety best practices information, see the Regulatory Compliance Homepage at dell.com/regulatory_compliance.

Prerequisites

Remove the battery. See "Removing the Battery" on page 12.

Procedure

- 1 Loosen the captive screws that secure the base cover to the computer base.
- 2 Using your fingertips, lift the base cover out of the slots on the computer base.



1 captive screws (2)

2 base cover

Replacing the Base Cover



WARNING: Before working inside your computer, read the safety information that shipped with your computer and follow the steps in "Before Working Inside Your Computer" on page 9. After working inside your computer, follow the instructions in "After Working Inside Your Computer" on page 11. For additional safety best practices information, see the Regulatory Compliance Homepage at dell.com/regulatory_compliance.

Procedure

- 1 Slide the tabs on the base cover into the slots on the computer base and snap the base cover into place.
- 2 Tighten the captive screws that secure the base cover to the computer base.

Postrequisites

Replace the battery. See "Replacing the Battery" on page 13.

Removing the Memory Module(s)

⚠ WARNING: Before working inside your computer, read the safety information that shipped with your computer and follow the steps in "Before Working Inside Your Computer" on page 9. After working inside your computer, follow the instructions in "After Working Inside Your Computer" on page 11. For additional safety best practices information, see the Regulatory Compliance Homepage at dell.com/regulatory_compliance.

Prerequisites

- 1 Remove the battery. See "Removing the Battery" on page 12.
- 2 Remove the base cover. See "Removing the Base Cover" on page 20.

Procedure

- 1 Use your fingertips to carefully spread apart the securing-clips on each end of the memory-module connector until the memory module pops up.
- 2 Slide and remove the memory module from the memory-module connector.

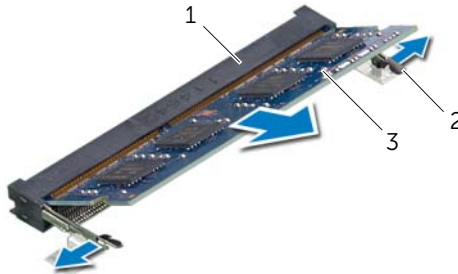

1	memory-module connector	2	securing-clips (2)
3	memory module		

Replacing the Memory Module(s)



WARNING: Before working inside your computer, read the safety information that shipped with your computer and follow the steps in "Before Working Inside Your Computer" on page 9. After working inside your computer, follow the instructions in "After Working Inside Your Computer" on page 11. For additional safety best practices information, see the Regulatory Compliance Homepage at dell.com/regulatory_compliance.

Procedure

- 1 Align the notch on the memory module with the tab on the memory-module connector.
- 2 Slide the memory module firmly, at an angle, into the connector and press the memory module down until it clicks into place.



NOTE: If you do not hear the click, remove the memory module and reinstall it.

Postrequisites

- 1 Replace the base cover. See "Replacing the Base Cover" on page 21.
- 2 Replace the battery. See "Replacing the Battery" on page 13.

Removing the Hard Drive

⚠ WARNING: Before working inside your computer, read the safety information that shipped with your computer and follow the steps in "Before Working Inside Your Computer" on page 9. After working inside your computer, follow the instructions in "After Working Inside Your Computer" on page 11. For additional safety best practices information, see the Regulatory Compliance Homepage at dell.com/regulatory_compliance.

⚠ CAUTION: To avoid data loss, do not remove the hard drive while the computer is in Sleep or On state.

⚠ CAUTION: Hard drives are extremely fragile. Exercise care when handling the hard drive.

Prerequisites

- 1 Remove the battery. See "Removing the Battery" on page 12.
- 2 Remove the base cover. See "Removing the Base Cover" on page 20.

Procedure

- 1 Remove the screws that secure the hard-drive assembly to the computer base.
- 2 Using the pull tab, slide the hard-drive assembly to disconnect it from the system board.
- 3 Using the pull tab, lift the hard-drive assembly off the computer base.

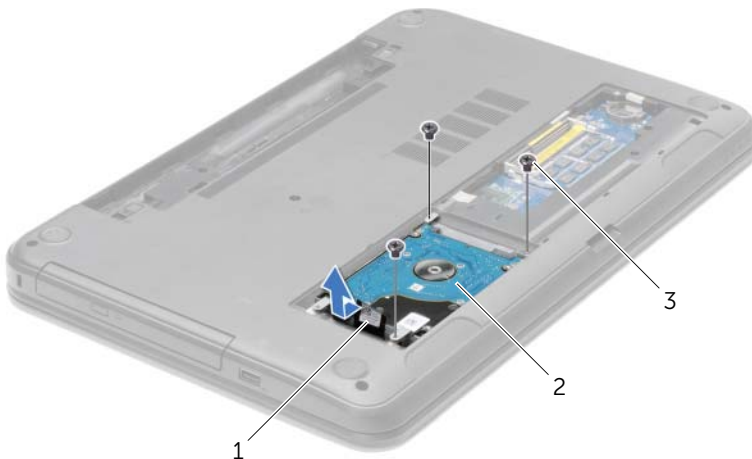

1 pull-tab

2 hard-drive assembly

3 screws (3)

- 4 Remove the screws that secure the hard-drive bracket to the hard drive.
- 5 Using the pull-tab, lift the hard-drive bracket off the hard drive.



1	hard drive	2	screws (4)
3	hard-drive bracket		

Replacing the Hard Drive

 **WARNING:** Before working inside your computer, read the safety information that shipped with your computer and follow the steps in "Before Working Inside Your Computer" on page 9. After working inside your computer, follow the instructions in "After Working Inside Your Computer" on page 11. For additional safety best practices information, see the Regulatory Compliance Homepage at dell.com/regulatory_compliance.

 **CAUTION:** Hard drives are extremely fragile. Exercise care when handling the hard drive.

Procedure

- 1 Align the screw holes on the hard-drive bracket with the screw holes on the hard drive.
- 2 Replace the screws that secure the hard-drive bracket to the hard drive.
- 3 Place the hard-drive assembly in the hard-drive bay.
- 4 Using the pull tab, slide the hard-drive assembly towards the connector to connect the hard-drive assembly to the system board.
- 5 Replace the screws that secure the hard-drive assembly to the computer base.

Postrequisites

- 1 Replace the base cover. See "Replacing the Base Cover" on page 21.
- 2 Replace the battery. See "Replacing the Battery" on page 13.

Removing the Coin-Cell Battery

! **WARNING:** Before working inside your computer, read the safety information that shipped with your computer and follow the steps in "Before Working Inside Your Computer" on page 9. After working inside your computer, follow the instructions in "After Working Inside Your Computer" on page 11. For additional safety best practices information, see the Regulatory Compliance Homepage at dell.com/regulatory_compliance.

△ **CAUTION:** Removing the coin-cell battery resets the BIOS settings to default. It is recommended that you note the BIOS settings before removing the coin-cell battery.

Prerequisites

- 1 Remove the battery. See "Removing the Battery" on page 12.
- 2 Remove the base cover. See "Removing the Base Cover" on page 20.

Procedure

Using a plastic scribe, gently pry out the coin-cell battery out of the battery socket on the system board.

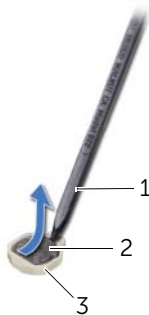

1	plastic scribe	2	coin-cell battery
3	battery socket		

Replacing the Coin-Cell Battery

 **WARNING:** Before working inside your computer, read the safety information that shipped with your computer and follow the steps in "Before Working Inside Your Computer" on page 9. After working inside your computer, follow the instructions in "After Working Inside Your Computer" on page 11. For additional safety best practices information, see the Regulatory Compliance Homepage at dell.com/regulatory_compliance.

 **WARNING:** The battery may explode if installed incorrectly. Replace the battery only with the same or equivalent type. Discard used batteries according to the manufacturer's instructions.

Procedure

With the positive-side facing up, snap the coin-cell battery into the battery socket on the system board.

Postrequisites

- 1 Replace the base cover. See "Replacing the Base Cover" on page 21.
- 2 Replace the battery. See "Replacing the Battery" on page 13.

Removing the Palm Rest

⚠ WARNING: Before working inside your computer, read the safety information that shipped with your computer and follow the steps in "Before Working Inside Your Computer" on page 9. After working inside your computer, follow the instructions in "After Working Inside Your Computer" on page 11. For additional safety best practices information, see the Regulatory Compliance Homepage at dell.com/regulatory_compliance.

Prerequisites

- 1 Remove the battery. See "Removing the Battery" on page 12.
- 2 Remove the base cover. See "Removing the Base Cover" on page 20.
- 3 Remove the keyboard. See "Removing the Keyboard" on page 17.

Procedure

- 1 Remove the screws that secure the palm rest to the computer base.



1 screws (12)

- 2 Turn the computer over and open the display as far as possible.
- 3 Lift the connector latches and, using the pull-tabs, disconnect the power-button cable and touchpad cable from the system board.

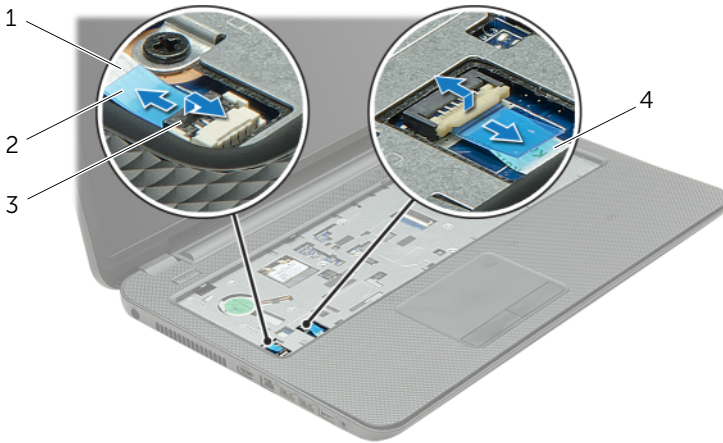

1	power-button cable	2	pull-tabs (2)
3	connector latches (2)	4	touchpad cable

- 4 Remove the screws that secure the palm rest to the computer base.
- 5 Using a plastic scribe, gently lift and release the tabs on the palm rest from the slots on the computer base.

CAUTION: Separate the palm rest from the display assembly carefully to avoid damage to the display assembly.

- 6 Lift the palm rest off the computer base.

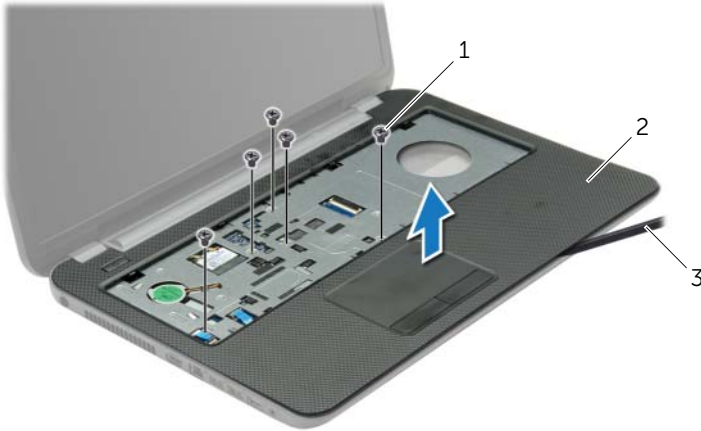

1 screws (5)

2 palm rest

3 plastic scribe

Replacing the Palm Rest



WARNING: Before working inside your computer, read the safety information that shipped with your computer and follow the steps in "Before Working Inside Your Computer" on page 9. After working inside your computer, follow the instructions in "After Working Inside Your Computer" on page 11. For additional safety best practices information, see the Regulatory Compliance Homepage at dell.com/regulatory_compliance.

Procedure

- 1 Align the palm rest to the computer base.
- 2 Press down on the edges of the palm rest to snap it into place.
- 3 Replace the screws that secure the palm rest to the computer base.
- 4 Slide the touchpad cable and the power-button cable into the system-board connectors and press down on the connector latches to secure the cables.
- 5 Close the display and turn the computer over.
- 6 Replace the screws that secure the palm rest to the computer base.

Postrequisites

- 1 Replace the keyboard. See "Replacing the Keyboard" on page 19.
- 2 Replace the base cover. See "Replacing the Base Cover" on page 21.
- 3 Replace the battery. See "Replacing the Battery" on page 13.

Removing the Wireless Card

⚠ WARNING: Before working inside your computer, read the safety information that shipped with your computer and follow the steps in "Before Working Inside Your Computer" on page 9. After working inside your computer, follow the instructions in "After Working Inside Your Computer" on page 11. For additional safety best practices information, see the Regulatory Compliance Homepage at dell.com/regulatory_compliance.

Prerequisites

- 1 Remove the battery. See "Removing the Battery" on page 12.
- 2 Remove the base cover. See "Removing the Base Cover" on page 20.
- 3 Remove the keyboard. See "Removing the Keyboard" on page 17.
- 4 Remove the palm rest. See "Removing the Palm Rest" on page 29.

Procedure

- 1 Disconnect the antenna cables from the wireless card.
- 2 Remove the screw that secures the wireless card to the system board.

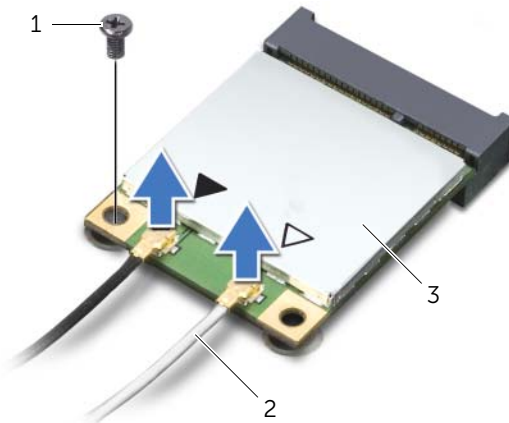

1	screw	2	antenna cables (2)
3	wireless card		

3 Slide and remove the wireless card out of the wireless-card connector.

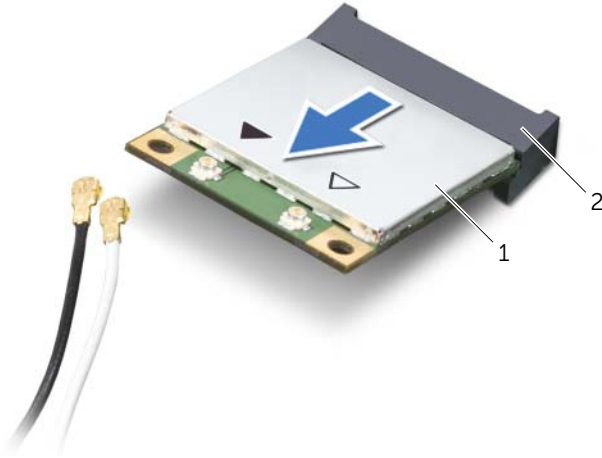

1 wireless card

2 wireless-card connector

Replacing the Wireless Card

 **WARNING:** Before working inside your computer, read the safety information that shipped with your computer and follow the steps in "Before Working Inside Your Computer" on page 9. After working inside your computer, follow the instructions in "After Working Inside Your Computer" on page 11. For additional safety best practices information, see the Regulatory Compliance Homepage at dell.com/regulatory_compliance.

Procedure

 **CAUTION:** To avoid damage to the wireless card, make sure that no cables are placed under the wireless card.

- 1 Align the notch on the wireless card with the tab on the wireless-card connector.
- 2 Insert the wireless card at an angle into the wireless-card connector.
- 3 Press the other end of the wireless card down and replace the screw that secures the wireless card to the system board.
- 4 Connect the antenna cables to the wireless card.

The following table provides the antenna cable color schemes for the wireless card supported by your computer.

Connectors on the wireless card	Antenna cable color schemes
WLAN + Bluetooth (2 cables)	
Main WLAN + Bluetooth (white triangle)	white
Auxiliary WLAN + Bluetooth (black triangle)	black

Postrequisites

- 1 Replace the palm rest. See "Replacing the Palm Rest" on page 32.
- 2 Replace the keyboard. See "Replacing the Keyboard" on page 19.
- 3 Replace the base cover. See "Replacing the Base Cover" on page 21.
- 4 Replace the battery. See "Replacing the Battery" on page 13.

Removing the I/O Board

WARNING: Before working inside your computer, read the safety information that shipped with your computer and follow the steps in "Before Working Inside Your Computer" on page 9. After working inside your computer, follow the instructions in "After Working Inside Your Computer" on page 11. For additional safety best practices information, see the Regulatory Compliance Homepage at dell.com/regulatory_compliance.

Prerequisites

- 1 Remove the battery. See "Removing the Battery" on page 12.
- 2 Remove the base cover. See "Removing the Base Cover" on page 20.
- 3 Remove the keyboard. See "Removing the Keyboard" on page 17.
- 4 Remove the palm rest. See "Removing the Palm Rest" on page 29.

Procedure

- 1 Remove the screw that secures the I/O board to the computer base.
- 2 Lift the connector latch and using the pull-tab, disconnect the I/O-board cable from the system board.
- 3 Peel off the I/O-board cable from the computer base.
- 4 Lift the I/O board along with its cable off the computer base.

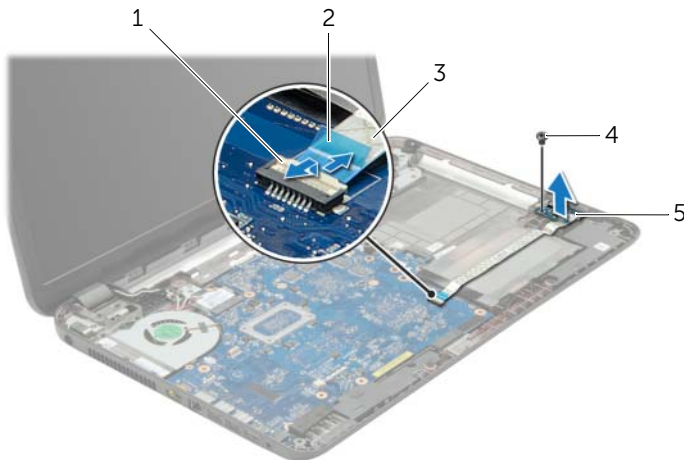

1	connector latch	2	pull-tab
3	I/O-board cable	4	screw
5	I/O board		

Replacing the I/O Board



WARNING: Before working inside your computer, read the safety information that shipped with your computer and follow the steps in "Before Working Inside Your Computer" on page 9. After working inside your computer, follow the instructions in "After Working Inside Your Computer" on page 11. For additional safety best practices information, see the Regulatory Compliance Homepage at dell.com/regulatory_compliance.

Procedure

- 1 Use the alignment posts on the computer base to place the I/O board in position.
- 2 Replace the screw that secures the I/O board to the computer base.
- 3 Adhere the I/O-board cable to the computer base.
- 4 Slide the I/O-board cable into the I/O-board-cable connector and press down on the connector latch to secure the cable.

Postrequisites

- 1 Replace the palm rest. See "Replacing the Palm Rest" on page 32.
- 2 Replace the keyboard. See "Replacing the Keyboard" on page 19.
- 3 Replace the base cover. See "Replacing the Base Cover" on page 21.
- 4 Replace the battery. See "Replacing the Battery" on page 13.

Removing the System Board

 **WARNING:** Before working inside your computer, read the safety information that shipped with your computer and follow the steps in "Before Working Inside Your Computer" on page 9. After working inside your computer, follow the instructions in "After Working Inside Your Computer" on page 11. For additional safety best practices information, see the Regulatory Compliance Homepage at dell.com/regulatory_compliance.

 **NOTE:** Your computer's Service Tag is stored in the system board. You must enter the Service Tag in system setup after you replace the system board.

 **NOTE:** Before disconnecting the cables from the system board, note the location of the connectors so that you can reconnect them correctly after you replace the system board.

Prerequisites

- 1 Remove the battery. See "Removing the Battery" on page 12.
- 2 Follow the instructions from step 1 to step 2 in "Removing the Optical Drive" on page 14.
- 3 Remove the base cover. See "Removing the Base Cover" on page 20.
- 4 Remove the memory module(s). See "Removing the Memory Module(s)" on page 22.
- 5 Remove the coin-cell battery. See "Removing the Coin-Cell Battery" on page 27.
- 6 Follow the instructions from step 1 to step 3 in "Removing the Hard Drive" on page 24.
- 7 Remove the keyboard. See "Removing the Keyboard" on page 17.
- 8 Remove the palm rest. See "Removing the Palm Rest" on page 29.
- 9 Remove the wireless card. See "Removing the Wireless Card" on page 33.

Procedure

- 1 Disconnect the power-adaptor-port cable and the speaker cable from the system board.
- 2 Peel off the Mylar sleeve from the system board.



1	power-adaptor-port cable	2	Mylar sleeve
3	speaker cable		

- 3 Peel off the tape that secures the display cable to the system board and disconnect the display cable from the system board.
- 4 Lift the connector latch and, using the pull-tab, disconnect the I/O-board cable from the system board.

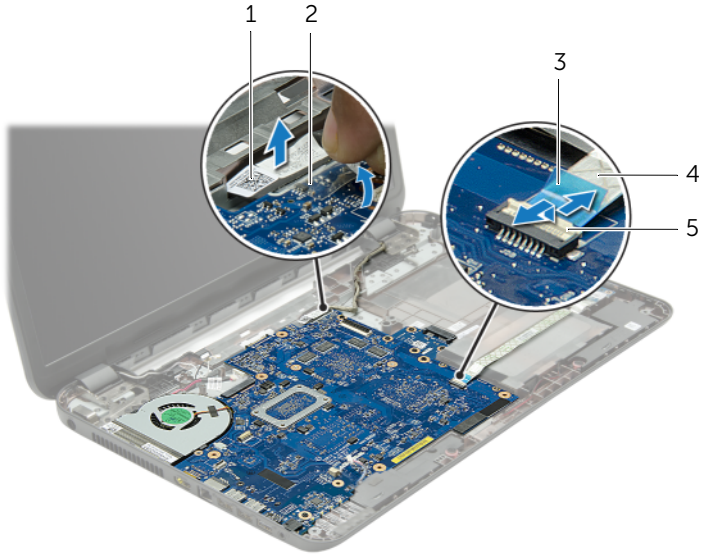

1	display cable	2	tape
3	pull-tab	4	I/O-board cable
5	connector latch		

- 5 Remove the screws that secure the system board to the computer base.
- 6 Lift the system-board assembly at an angle and release the system-board ports from the slots on the computer base.
- 7 Lift the system-board assembly off the computer base.

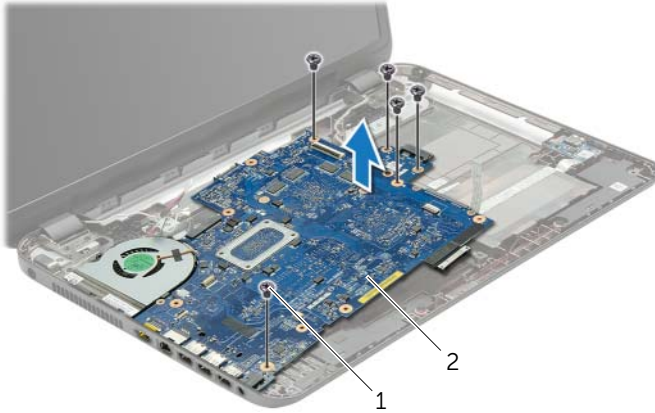

1 screws (5)

2 system-board assembly

- 8 Turn the system-board assembly over.
- 9 Remove the screws that secure the hard-drive interposer board to the system-board assembly.
- 10 Disconnect the hard-drive interposer board from the system-board assembly.

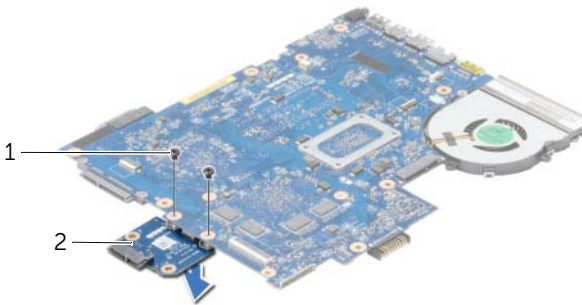



1 screws (2)

2 hard-drive interposer board

- 11 Remove the fan. See "Removing the Fan" on page 44.
- 12 Remove the heat sink. See "Removing the Heat Sink" on page 46.

Replacing the System Board

 **WARNING:** Before working inside your computer, read the safety information that shipped with your computer and follow the steps in "Before Working Inside Your Computer" on page 9. After working inside your computer, follow the instructions in "After Working Inside Your Computer" on page 11. For additional safety best practices information, see the Regulatory Compliance Homepage at dell.com/regulatory_compliance.

 **NOTE:** Your computer's Service Tag is stored in the system board. You must enter the Service Tag in the system setup after you replace the system board.

Procedure

- 1 Replace the heat sink. See "Replacing the Heat Sink" on page 47.
- 2 Replace the fan. See "Replacing the Fan" on page 45.
- 3 Connect the hard-drive interposer board to the system board.
- 4 Replace screws that secure the hard-drive interposer board to the system board.
- 5 Turn the system-board assembly over.
- 6 Insert the system-board ports into the slots on the computer base and align the screw holes on the system board with the screw holes on the computer base.
- 7 Replace the screws that secure the system board to the computer base.
- 8 Adhere the Mylar sleeve to the system board.
- 9 Connect the display cable to the system board and adhere the tape that secures the display cable.
- 10 Slide the I/O-board cable into the I/O-board cable connector and press down on the connector latch to secure the cable.
- 11 Connect the power-adaptor-port cable and the speaker cable to the system board.

Postrequisites

- 1 Replace the wireless card. See "Replacing the Wireless Card" on page 35.
- 2 Replace the palm rest. See "Replacing the Palm Rest" on page 32.
- 3 Replace the keyboard. See "Replacing the Keyboard" on page 19.
- 4 Follow step 3 to step 5 in "Replacing the Hard Drive" on page 26.
- 5 Replace the coin-cell battery. See "Replacing the Coin-Cell Battery" on page 28.
- 6 Replace the memory module(s). See "Replacing the Memory Module(s)" on page 23.
- 7 Replace the base cover. See "Replacing the Base Cover" on page 21.
- 8 Follow step 3 to step 4 in "Replacing the Optical Drive" on page 16.
- 9 Replace the battery. See "Replacing the Battery" on page 13.

Removing the Fan

WARNING: Before working inside your computer, read the safety information that shipped with your computer and follow the steps in "Before Working Inside Your Computer" on page 9. After working inside your computer, follow the instructions in "After Working Inside Your Computer" on page 11. For additional safety best practices information, see the Regulatory Compliance Homepage at dell.com/regulatory_compliance.

Prerequisites

- 1 Remove the battery. See "Removing the Battery" on page 12.
- 2 Follow step 1 to step 2 in "Removing the Optical Drive" on page 14.
- 3 Follow step 1 to step 3 in "Removing the Hard Drive" on page 24.
- 4 Remove the base cover. See "Removing the Base Cover" on page 20.
- 5 Remove the keyboard. See "Removing the Keyboard" on page 17.
- 6 Remove the palm rest. See "Removing the Palm Rest" on page 29.
- 7 Remove the wireless card. See "Removing the Wireless Card" on page 33.
- 8 Follow step 1 to step 8 in "Removing the System Board" on page 38.

Procedure

- 1 Disconnect the fan cable from the system board.
- 2 Remove the screw that secures the fan to the system board.
- 3 Lift the fan, along with its cable, off the system board.

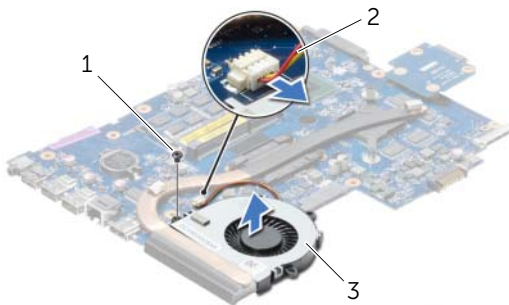

1 screw

2 fan cable

3 fan

Replacing the Fan



WARNING: Before working inside your computer, read the safety information that shipped with your computer and follow the steps in "Before Working Inside Your Computer" on page 9. After working inside your computer, follow the instructions in "After Working Inside Your Computer" on page 11. For additional safety best practices information, see the Regulatory Compliance Homepage at dell.com/regulatory_compliance.

Procedure

- 1 Place the fan on the system board and replace the screw that secures the fan to the system board.
- 2 Connect the fan cable to the system board.

Postrequisites

- 1 Follow step 5 to step 11 in "Replacing the System Board" on page 42.
- 2 Replace the wireless card. See "Replacing the Wireless Card" on page 35.
- 3 Replace the palm rest. See "Replacing the Palm Rest" on page 32.
- 4 Replace the keyboard. See "Replacing the Keyboard" on page 19.
- 5 Replace the base cover. See "Replacing the Base Cover" on page 21.
- 6 Follow step 3 to step 4 in "Replacing the Optical Drive" on page 16.
- 7 Follow step 3 to step 5 in "Replacing the Hard Drive" on page 26.
- 8 Replace the battery. See "Replacing the Battery" on page 13.

Removing the Heat Sink

⚠ WARNING: Before working inside your computer, read the safety information that shipped with your computer and follow the steps in "Before Working Inside Your Computer" on page 9. After working inside your computer, follow the instructions in "After Working Inside Your Computer" on page 11. For additional safety best practices information, see the Regulatory Compliance Homepage at dell.com/regulatory_compliance.

Prerequisites

- 1 Remove the battery. See "Removing the Battery" on page 12.
- 2 Follow step 1 to step 2 in "Removing the Optical Drive" on page 14.
- 3 Follow step 1 to step 3 in "Removing the Hard Drive" on page 24.
- 4 Remove the base cover. See "Removing the Base Cover" on page 20.
- 5 Remove the keyboard. See "Removing the Keyboard" on page 17.
- 6 Remove the palm rest. See "Removing the Palm Rest" on page 29.
- 7 Remove the wireless card. See "Removing the Wireless Card" on page 33.
- 8 Follow step 1 to step 8 in "Removing the System Board" on page 38.

Procedure

- 1 In sequential order (indicated on the heat-sink), remove the screws that secure the heat sink to the system board.
- 2 Lift the heat sink off the system board.

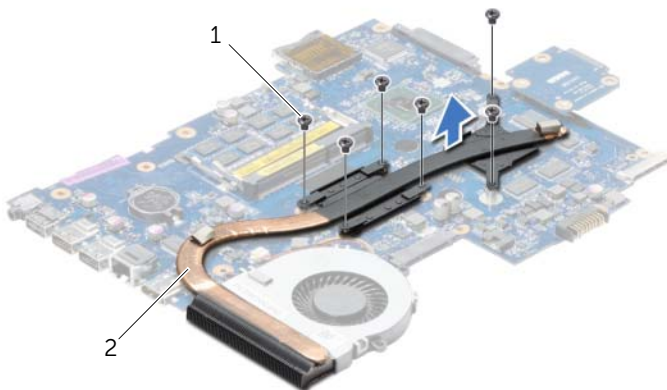

1 screws (6)

2 heat sink

Replacing the Heat Sink



WARNING: Before working inside your computer, read the safety information that shipped with your computer and follow the steps in "Before Working Inside Your Computer" on page 9. After working inside your computer, follow the instructions in "After Working Inside Your Computer" on page 11. For additional safety best practices information, see the Regulatory Compliance Homepage at dell.com/regulatory_compliance.

Procedure

- 1 Clean the thermal grease from the bottom of the heat sink and reapply it.
- 2 Align the screw holes on the heat sink with the screw holes on the system board.
- 3 In sequential order (indicated on the heat-sink), replace the screws that secure the heat sink to the system board.

Postrequisites

- 1 Follow step 5 to step 11 in "Replacing the System Board" on page 42.
- 2 Replace the wireless card. See "Replacing the Wireless Card" on page 35.
- 3 Replace the palm rest. See "Replacing the Palm Rest" on page 32.
- 4 Replace the keyboard. See "Replacing the Keyboard" on page 19.
- 5 Replace the base cover. See "Replacing the Base Cover" on page 21.
- 6 Follow step 3 to step 4 in "Replacing the Optical Drive" on page 16.
- 7 Follow step 3 to step 5 in "Replacing the Hard Drive" on page 26.
- 8 Replace the battery. See "Replacing the Battery" on page 13.

Removing the Hard-Drive Interposer Board

⚠ WARNING: Before working inside your computer, read the safety information that shipped with your computer and follow the steps in "Before Working Inside Your Computer" on page 9. After working inside your computer, follow the instructions in "After Working Inside Your Computer" on page 11. For additional safety best practices information, see the Regulatory Compliance Homepage at dell.com/regulatory_compliance.

Prerequisites

- 1 Remove the battery. See "Removing the Battery" on page 12.
- 2 Follow step 1 to step 2 in "Removing the Optical Drive" on page 14.
- 3 Follow step 1 to step 3 in "Removing the Hard Drive" on page 24.
- 4 Remove the base cover. See "Removing the Base Cover" on page 20.
- 5 Remove the keyboard. See "Removing the Keyboard" on page 17.
- 6 Remove the palm rest. See "Removing the Palm Rest" on page 29.
- 7 Remove the wireless card. See "Removing the Wireless Card" on page 33.
- 8 Follow step 1 to step 8 in "Removing the System Board" on page 38.

Procedure

- 1 Remove the screws that secure the hard-drive interposer board to the system board.
- 2 Disconnect the hard-drive interposer board from the system board.



1 screws (2)

2 hard-drive interposer board

Replacing the Hard-Drive Interposer Board



WARNING: Before working inside your computer, read the safety information that shipped with your computer and follow the steps in "Before Working Inside Your Computer" on page 9. After working inside your computer, follow the instructions in "After Working Inside Your Computer" on page 11. For additional safety best practices information, see the Regulatory Compliance Homepage at dell.com/regulatory_compliance.

Procedure

- 1 Connect the hard-drive interposer board to the system board.
- 2 Replace screws that secure the hard-drive interposer board to the system board.

Postrequisites

- 1 Follow step 5 to step 11 in "Replacing the System Board" on page 42.
- 2 Replace the wireless card. See "Replacing the Wireless Card" on page 35.
- 3 Replace the palm rest. See "Replacing the Palm Rest" on page 32.
- 4 Replace the keyboard. See "Replacing the Keyboard" on page 19.
- 5 Replace the base cover. See "Replacing the Base Cover" on page 21.
- 6 Follow step 3 to step 4 in "Replacing the Optical Drive" on page 16.
- 7 Follow step 3 to step 5 in "Replacing the Hard Drive" on page 26.
- 8 Replace the battery. See "Replacing the Battery" on page 13.

Removing the Speakers



WARNING: Before working inside your computer, read the safety information that shipped with your computer and follow the steps in "Before Working Inside Your Computer" on page 9. After working inside your computer, follow the instructions in "After Working Inside Your Computer" on page 11. For additional safety best practices information, see the Regulatory Compliance Homepage at dell.com/regulatory_compliance.

Prerequisites

- 1 Remove the battery. See "Removing the Battery" on page 12.
- 2 Follow step 1 to step 2 in "Removing the Optical Drive" on page 14.
- 3 Follow step 1 to step 3 in "Removing the Hard Drive" on page 24.
- 4 Remove the base cover. See "Removing the Base Cover" on page 20.
- 5 Remove the keyboard. See "Removing the Keyboard" on page 17.
- 6 Remove the palm rest. See "Removing the Palm Rest" on page 29.
- 7 Remove the wireless card. See "Removing the Wireless Card" on page 33.
- 8 Follow step 1 to step 7 in "Removing the System Board" on page 38.

Procedure

- 1 Remove the screws that secure the speakers to the computer base.
- 2 Note the speaker-cable routing and remove the cable from its routing guides.
- 3 Lift the speakers, along with the speaker cable, off the computer base.



1	screws (4)	2	speakers (2)
3	speaker cable		

Replacing the Speakers



WARNING: Before working inside your computer, read the safety information that shipped with your computer and follow the steps in "Before Working Inside Your Computer" on page 9. After working inside your computer, follow the instructions in "After Working Inside Your Computer" on page 11. For additional safety best practices information, see the Regulatory Compliance Homepage at dell.com/regulatory_compliance.

Procedure

- 1 Using the alignment posts on the computer base, place the speakers in position.
- 2 Route the speaker cable through the routing guides on the computer base.
- 3 Replace the screws that secure the speakers to the computer base.

Postrequisites

- 1 Follow step 5 to step 11 in "Replacing the System Board" on page 42.
- 2 Replace the wireless card. See "Replacing the Wireless Card" on page 35.
- 3 Replace the palm rest. See "Replacing the Palm Rest" on page 32.
- 4 Replace the keyboard. See "Replacing the Keyboard" on page 19.
- 5 Replace the base cover. See "Replacing the Base Cover" on page 21.
- 6 Follow step 3 to step 4 in "Replacing the Optical Drive" on page 16.
- 7 Follow step 3 to step 5 in "Replacing the Hard Drive" on page 26.
- 8 Replace the battery. See "Replacing the Battery" on page 13.

Removing the Display Assembly



WARNING: Before working inside your computer, read the safety information that shipped with your computer and follow the steps in "Before Working Inside Your Computer" on page 9. After working inside your computer, follow the instructions in "After Working Inside Your Computer" on page 11. For additional safety best practices information, see the Regulatory Compliance Homepage at dell.com/regulatory_compliance.

Prerequisites

- 1 Remove the battery. See "Removing the Battery" on page 12.
- 2 Follow step 1 to step 2 in "Removing the Optical Drive" on page 14.
- 3 Follow step 1 to step 3 in "Removing the Hard Drive" on page 24.
- 4 Remove the base cover. See "Removing the Base Cover" on page 20.
- 5 Remove the keyboard. See "Removing the Keyboard" on page 17.
- 6 Remove the palm rest. See "Removing the Palm Rest" on page 29.
- 7 Remove the wireless card. See "Removing the Wireless Card" on page 33.
- 8 Follow step 1 to step 7 in "Removing the System Board" on page 38.

Procedure

- 1 Note the antenna-cable routing and remove the cable from its routing guides.
- 2 Remove the screws that secure the display assembly to the computer base.
- 3 Lift the display assembly off the computer base.

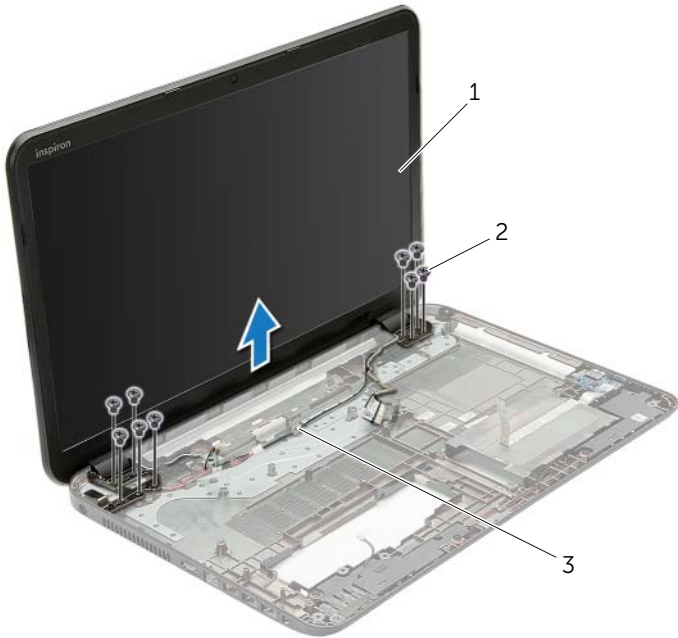

1 display assembly

2 screws (9)

3 routing guides

Replacing the Display Assembly



WARNING: Before working inside your computer, read the safety information that shipped with your computer and follow the steps in "Before Working Inside Your Computer" on page 9. After working inside your computer, follow the instructions in "After Working Inside Your Computer" on page 11. For additional safety best practices information, see the Regulatory Compliance Homepage at dell.com/regulatory_compliance.

Procedure

- 1 Place the display assembly on the computer base and align the screw holes on the display assembly with the screw holes on the computer base.
- 2 Replace the screws that secure the display assembly to the computer base.
- 3 Route the antenna cable through the routing guides on the computer base.

Postrequisites

- 1 Follow step 5 to step 11 in "Replacing the System Board" on page 42.
- 2 Replace the wireless card. See "Replacing the Wireless Card" on page 35.
- 3 Replace the palm rest. See "Replacing the Palm Rest" on page 32.
- 4 Replace the keyboard. See "Replacing the Keyboard" on page 19.
- 5 Replace the base cover. See "Replacing the Base Cover" on page 21.
- 6 Follow step 3 to step 4 in "Replacing the Optical Drive" on page 16.
- 7 Follow step 3 to step 5 in "Replacing the Hard Drive" on page 26.
- 8 Replace the battery. See "Replacing the Battery" on page 13.

Removing the Display Bezel



WARNING: Before working inside your computer, read the safety information that shipped with your computer and follow the steps in "Before Working Inside Your Computer" on page 9. After working inside your computer, follow the instructions in "After Working Inside Your Computer" on page 11. For additional safety best practices information, see the Regulatory Compliance Homepage at dell.com/regulatory_compliance.

Prerequisites

- 1 Remove the battery. See "Removing the Battery" on page 12.
- 2 Follow step 1 to step 2 in "Removing the Optical Drive" on page 14.
- 3 Follow step 1 to step 3 in "Removing the Hard Drive" on page 24.
- 4 Remove the base cover. See "Removing the Base Cover" on page 20.
- 5 Remove the keyboard. See "Removing the Keyboard" on page 17.
- 6 Remove the palm rest. See "Removing the Palm Rest" on page 29.
- 7 Remove the wireless card. See "Removing the Wireless Card" on page 33.
- 8 Follow step 1 to step 7 in "Removing the System Board" on page 38.
- 9 Remove the display assembly. See "Removing the Display Assembly" on page 53.

Procedure

- 1 Using your fingertips, carefully pry up the inside edge of the display bezel.
- 2 Remove the display bezel off the display back-cover.



1 display bezel

Replacing the Display Bezel



WARNING: Before working inside your computer, read the safety information that shipped with your computer and follow the steps in "Before Working Inside Your Computer" on page 9. After working inside your computer, follow the instructions in "After Working Inside Your Computer" on page 11. For additional safety best practices information, see the Regulatory Compliance Homepage at dell.com/regulatory_compliance.

Procedure

Align the display bezel with the display back-cover, and gently snap the display bezel into place.

Postrequisites

- 1 Replace the display assembly. See "Replacing the Display Assembly" on page 55.
- 2 Follow step 5 to step 11 in "Replacing the System Board" on page 42.
- 3 Replace the wireless card. See "Replacing the Wireless Card" on page 35.
- 4 Replace the palm rest. See "Replacing the Palm Rest" on page 32.
- 5 Replace the keyboard. See "Replacing the Keyboard" on page 19.
- 6 Replace the base cover. See "Replacing the Base Cover" on page 21.
- 7 Follow step 3 to step 4 in "Replacing the Optical Drive" on page 16.
- 8 Follow step 3 to step 5 in "Replacing the Hard Drive" on page 26.
- 9 Replace the battery. See "Replacing the Battery" on page 13.

Removing the Display Hinges



WARNING: Before working inside your computer, read the safety information that shipped with your computer and follow the steps in "Before Working Inside Your Computer" on page 9. After working inside your computer, follow the instructions in "After Working Inside Your Computer" on page 11. For additional safety best practices information, see the Regulatory Compliance Homepage at dell.com/regulatory_compliance.

Prerequisites

- 1 Remove the battery. See "Removing the Battery" on page 12.
- 2 Follow step 1 to step 2 in "Removing the Optical Drive" on page 14.
- 3 Follow step 1 to step 3 in "Removing the Hard Drive" on page 24.
- 4 Remove the base cover. See "Removing the Base Cover" on page 20.
- 5 Remove the keyboard. See "Removing the Keyboard" on page 17.
- 6 Remove the palm rest. See "Removing the Palm Rest" on page 29.
- 7 Remove the wireless card. See "Removing the Wireless Card" on page 33.
- 8 Follow step 1 to step 7 in "Removing the System Board" on page 38.
- 9 Remove the display assembly. See "Removing the Display Assembly" on page 53.
- 10 Remove the display bezel. See "Removing the Display Bezel" on page 56.

Procedure

- 1 Remove the screws that secure the display hinges to the display back-cover.
- 2 Lift the display hinges off the display back-cover.

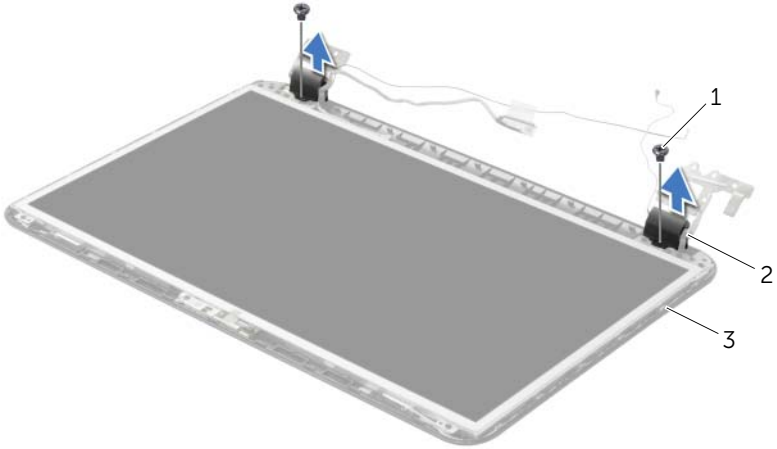

1	screws (2)	2	display hinges (2)
3	display back-cover		

Replacing the Display Hinges



WARNING: Before working inside your computer, read the safety information that shipped with your computer and follow the steps in "Before Working Inside Your Computer" on page 9. After working inside your computer, follow the instructions in "After Working Inside Your Computer" on page 11. For additional safety best practices information, see the Regulatory Compliance Homepage at dell.com/regulatory_compliance.

Procedure

- 1 Align the screw holes on the display hinges with the screw holes on the display back-cover.
- 2 Replace the screws that secure the display hinges to the display back-cover.

Postrequisites

- 1 Replace the display bezel. See "Replacing the Display Bezel" on page 58.
- 2 Replace the display assembly. See "Replacing the Display Assembly" on page 55.
- 3 Follow step 5 to step 11 in "Replacing the System Board" on page 42.
- 4 Replace the wireless card. See "Replacing the Wireless Card" on page 35.
- 5 Replace the palm rest. See "Replacing the Palm Rest" on page 32.
- 6 Replace the keyboard. See "Replacing the Keyboard" on page 19.
- 7 Replace the base cover. See "Replacing the Base Cover" on page 21.
- 8 Follow step 3 to step 4 in "Replacing the Optical Drive" on page 16.
- 9 Follow step 1 to step 3 in "Replacing the Hard Drive" on page 26.
- 10 Replace the battery. See "Replacing the Battery" on page 13.

Removing the Display Panel



WARNING: Before working inside your computer, read the safety information that shipped with your computer and follow the steps in "Before Working Inside Your Computer" on page 9. After working inside your computer, follow the instructions in "After Working Inside Your Computer" on page 11. For additional safety best practices information, see the Regulatory Compliance Homepage at dell.com/regulatory_compliance.

Prerequisites

- 1 Remove the battery. See "Removing the Battery" on page 12.
- 2 Follow step 1 to step 2 in "Removing the Optical Drive" on page 14.
- 3 Follow step 1 to step 3 in "Removing the Hard Drive" on page 24.
- 4 Remove the base cover. See "Removing the Base Cover" on page 20.
- 5 Remove the memory module(s). See "Removing the Memory Module(s)" on page 22.
- 6 Remove the keyboard. See "Removing the Keyboard" on page 17.
- 7 Remove the palm rest. See "Removing the Palm Rest" on page 29.
- 8 Remove the wireless card. See "Removing the Wireless Card" on page 33.
- 9 Follow step 1 to step 7 in "Removing the System Board" on page 38.
- 10 Remove the display assembly. See "Removing the Display Assembly" on page 53.
- 11 Remove the display bezel. See "Removing the Display Bezel" on page 56.
- 12 Remove the display hinges. See "Removing the Display Hinges" on page 59.

Procedure

- 1 Remove the screws that secure the display panel to the display back-cover.
- 2 Gently lift the display panel and turn it over.

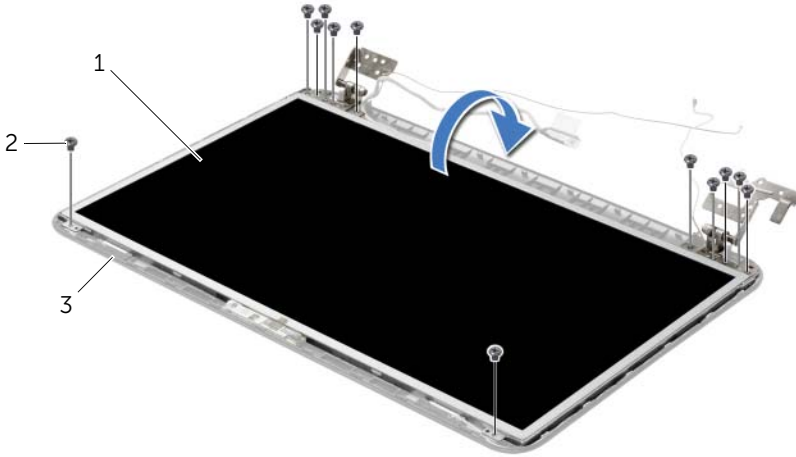

1	display panel	2	screws (12)
3	display back-cover		

- 3 Peel off the tape adhered over the display cable.
- 4 Disconnect the display cable from the display panel.

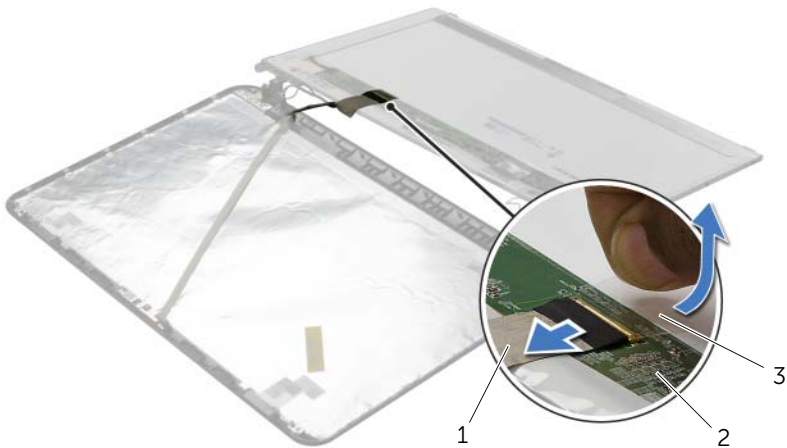

1	display cable	2	display panel
3	tape		

Replacing the Display Panel



WARNING: Before working inside your computer, read the safety information that shipped with your computer and follow the steps in "Before Working Inside Your Computer" on page 9. After working inside your computer, follow the instructions in "After Working Inside Your Computer" on page 11. For additional safety best practices information, see the Regulatory Compliance Homepage at dell.com/regulatory_compliance.

Procedure

- 1 Connect the display cable to the display panel and adhere the tape that secures the display cable.
- 2 Gently place the display panel on the display back-cover and align the screw holes on the display panel with the screw holes on the display back-cover.
- 3 Replace the screws that secure the display panel to the display back-cover.

Postrequisites

- 1 Replace the display hinges. See "Replacing the Display Hinges" on page 61.
- 2 Replace the display bezel. See "Replacing the Display Bezel" on page 58.
- 3 Replace the display assembly. See "Replacing the Display Assembly" on page 55.
- 4 Follow step 5 to step 11 in "Replacing the System Board" on page 42.
- 5 Replace the wireless card. See "Replacing the Wireless Card" on page 35.
- 6 Replace the palm rest. See "Replacing the Palm Rest" on page 32.
- 7 Replace the keyboard. See "Replacing the Keyboard" on page 19.
- 8 Replace the memory module(s). See "Replacing the Memory Module(s)" on page 23.
- 9 Replace the base cover. See "Replacing the Base Cover" on page 21.
- 10 Follow step 3 to step 4 in "Replacing the Optical Drive" on page 16.
- 11 Follow step 3 to step 5 in "Replacing the Hard Drive" on page 26.
- 12 Replace the battery. See "Replacing the Battery" on page 13.

Removing the Camera Module



WARNING: Before working inside your computer, read the safety information that shipped with your computer and follow the steps in "Before Working Inside Your Computer" on page 9. After working inside your computer, follow the instructions in "After Working Inside Your Computer" on page 11. For additional safety best practices information, see the Regulatory Compliance Homepage at dell.com/regulatory_compliance.

Prerequisites

- 1 Remove the battery. See "Removing the Battery" on page 12.
- 2 Follow step 1 to step 2 in "Removing the Optical Drive" on page 14.
- 3 Follow step 1 to step 3 in "Removing the Hard Drive" on page 24.
- 4 Remove the base cover. See "Removing the Base Cover" on page 20.
- 5 Remove the memory module(s). See "Removing the Memory Module(s)" on page 22.
- 6 Remove the keyboard. See "Removing the Keyboard" on page 17.
- 7 Remove the palm rest. See "Removing the Palm Rest" on page 29.
- 8 Remove the wireless card. See "Removing the Wireless Card" on page 33.
- 9 Follow step 1 to step 7 in "Removing the System Board" on page 38.
- 10 Remove the display assembly. See "Removing the Display Assembly" on page 53.
- 11 Remove the display bezel. See "Removing the Display Bezel" on page 56.
- 12 Remove the display panel. See "Removing the Display Panel" on page 62.

Procedure

- 1 Disconnect the camera cable from the camera module.
- 2 Remove the screw that secures the camera module to the display back-cover.
- 3 Lift the camera module off the display back-cover.

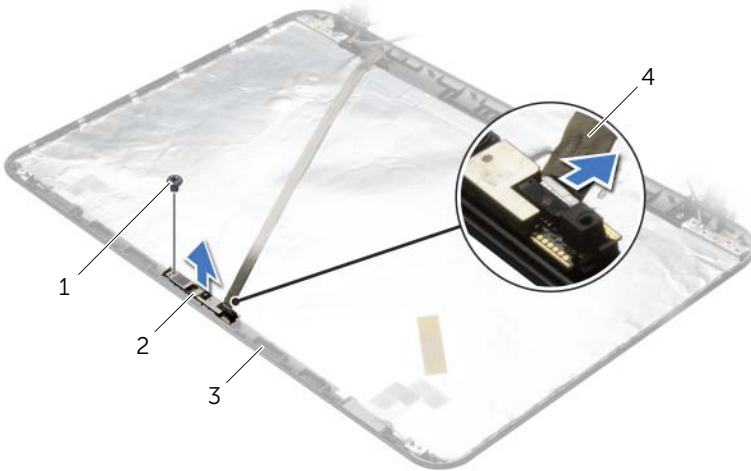

1	screw	2	camera module
3	display back-cover	4	camera cable

Replacing the Camera Module



WARNING: Before working inside your computer, read the safety information that shipped with your computer and follow the steps in "Before Working Inside Your Computer" on page 9. After working inside your computer, follow the instructions in "After Working Inside Your Computer" on page 11. For additional safety best practices information, see the Regulatory Compliance Homepage at dell.com/regulatory_compliance.

Procedure

- 1 Using the alignment posts on the display back-cover, place the camera module in position.
- 2 Replace the screw that secures the camera module to the display back-cover.
- 3 Connect the camera cable to the camera module.

Postrequisites

- 1 Replace the display bezel. See "Replacing the Display Bezel" on page 58.
- 2 Replace the display assembly. See "Replacing the Display Assembly" on page 55.
- 3 Follow step 5 to step 11 in "Replacing the System Board" on page 42.
- 4 Replace the wireless card. See "Replacing the Wireless Card" on page 35.
- 5 Replace the palm rest. See "Replacing the Palm Rest" on page 32.
- 6 Replace the keyboard. See "Replacing the Keyboard" on page 19.
- 7 Replace the memory module(s). See "Replacing the Memory Module(s)" on page 23.
- 8 Replace the base cover. See "Replacing the Base Cover" on page 21.
- 9 Follow step 3 to step 4 in "Replacing the Optical Drive" on page 16.
- 10 Follow step 3 to step 5 in "Replacing the Hard Drive" on page 26.
- 11 Replace the battery. See "Replacing the Battery" on page 13.

Removing the Power-Adapter Port



WARNING: Before working inside your computer, read the safety information that shipped with your computer and follow the steps in "Before Working Inside Your Computer" on page 9. After working inside your computer, follow the instructions in "After Working Inside Your Computer" on page 11. For additional safety best practices information, see the Regulatory Compliance Homepage at dell.com/regulatory_compliance.

Prerequisites

- 1 Remove the battery. See "Removing the Battery" on page 12.
- 2 Follow step 1 to step 2 in "Removing the Optical Drive" on page 14.
- 3 Follow step 1 to step 3 in "Removing the Hard Drive" on page 24.
- 4 Remove the base cover. See "Removing the Base Cover" on page 20.
- 5 Remove the memory module(s). See "Removing the Memory Module(s)" on page 22.
- 6 Remove the keyboard. See "Removing the Keyboard" on page 17.
- 7 Remove the palm rest. See "Removing the Palm Rest" on page 29.
- 8 Remove the wireless card. See "Removing the Wireless Card" on page 33.
- 9 Follow step 1 to step 7 in "Removing the System Board" on page 38.
- 10 Remove the display assembly. See "Removing the Display Assembly" on page 53.

Procedure

- 1 Note the routing of the power-adapter port cable and remove it from the routing guides on the computer base.
- 2 Lift the power-adapter port, along with its cable, off the computer base.

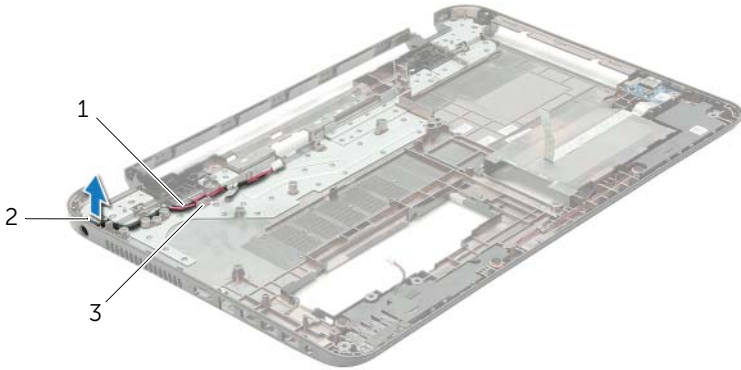

1	power-adapter port cable	2	power-adapter port
3	routing guides		

Replacing the Power-Adapter Port



WARNING: Before working inside your computer, read the safety information that shipped with your computer and follow the steps in "Before Working Inside Your Computer" on page 9. After working inside your computer, follow the instructions in "After Working Inside Your Computer" on page 11. For additional safety best practices information, see the Regulatory Compliance Homepage at dell.com/regulatory_compliance.

Procedure

- 1 Slide the power-adapter port into position.
- 2 Route the power-adapter-port cable through the routing guides on the computer base.

Postrequisites

- 1 Replace the display assembly. See "Replacing the Display Assembly" on page 55.
- 2 Follow step 5 to step 11 in "Replacing the System Board" on page 42.
- 3 Replace the wireless card. See "Replacing the Wireless Card" on page 35.
- 4 Replace the palm rest. See "Replacing the Palm Rest" on page 32.
- 5 Replace the keyboard. See "Replacing the Keyboard" on page 19.
- 6 Replace the base cover. See "Replacing the Base Cover" on page 21.
- 7 Follow step 3 to step 4 in "Replacing the Optical Drive" on page 16.
- 8 Follow step 3 to step 5 in "Replacing the Hard Drive" on page 26.
- 9 Replace the battery. See "Replacing the Battery" on page 13.

Flashing the BIOS

You may need to flash (update) the BIOS when an update is available or when you replace the system board. To flash the BIOS:

- 1 Turn on the computer.
- 2 Go to **dell.com/support**.
- 3 If you have your computer's Service Tag, type your computer's Service Tag and click **Submit**.

If you do not have your computer's service tag, click **Detect Service Tag** to allow automatic detection of your computer's service tag.



NOTE: If the Service Tag cannot be detected automatically, select your product under the product categories.

- 4 Click **Drivers and Downloads**.
- 5 In the **Operating System** drop-down, select the operating system installed on your computer.
- 6 Click **BIOS**.
- 7 Click **Download File** to download the latest version of the BIOS for your computer.
- 8 On the next page, select **Single-file download** and click **Continue**.
- 9 Save the file and once the download is complete, navigate to the folder where you saved the BIOS update file.
- 10 Double-click the BIOS update file icon and follow the instructions on the screen.