



HP ZBook Studio G3 Mobile Workstation
Model numbers: 15-ap000 – 15ap099

Maintenance and Service Guide

© Copyright 2015 HP Development Company, L.P.

AMD is a trademark of Advanced Micro Devices, Inc. Bluetooth is a trademark owned by its proprietor and used by HP Inc. under license. Intel and Xeon are trademarks of Intel Corporation in the U.S. and other countries. Windows is either a registered trademark or trademark of Microsoft Corporation in the United States and/or other countries. NVIDIA and Quadro are trademarks and/or registered trademarks of NVIDIA Corporation in the U.S. and other countries. Red Hat Enterprise Linux is a registered trademark of Red Hat, Inc. in the United States and other countries.

The information contained herein is subject to change without notice. The only warranties for HP products and services are set forth in the express warranty statements accompanying such products and services. Nothing herein should be construed as constituting an additional warranty. HP shall not be liable for technical or editorial errors or omissions contained herein.

For DTS patents, see <http://patents.dts.com>. Manufactured under license from DTS Licensing Limited. DTS, the Symbol, & DTS and the Symbol together are registered trademarks, and DTS Studio Sound is a trademark of DTS, Inc. © DTS, Inc. All Rights

Reserved  .

First Edition: December 2015

Document Part number: 839280-001

Product notice

This user guide describes features that are common to most models. Some features may not be available on your computer.

Not all features are available in all editions of Windows. This computer may require upgraded and/or separately purchased hardware, drivers and/or software to take full advantage of Windows functionality. Go to <http://www.microsoft.com> for details.

Software terms

By installing, copying, downloading, or otherwise using any software product preinstalled on this computer, you agree to be bound by the terms of the HP End User License Agreement (EULA). If you do not accept these license terms, your sole remedy is to return the entire unused product (hardware and software) within 14 days for a full refund subject to the refund policy of your seller.

For any further information or to request a full refund of the price of the computer, please contact your seller.

This computer may require upgraded and/ or separately purchased hardware and/or a DVD drive to install the Windows 7 software and take full advantage of Windows 7 functionality. See <http://windows.microsoft.com/en-us/windows7/get-know-windows-7> for details.

Important Notice about Customer Self-Repair Parts

 **CAUTION:** Your computer includes Customer Self-Repair parts and parts that should only be accessed by an authorized service provider. See Chapter 5, "Removal and replacement procedures for Customer Self-Repair parts," for details. Accessing parts described in Chapter 6, "Removal and replacement procedures for Authorized Service Provider parts," can damage the computer or void your warranty.

Safety warning notice

 **WARNING!** To reduce the possibility of heat-related injuries or of overheating the computer, do not place the computer directly on your lap or obstruct the computer air vents. Use the computer only on a hard, flat surface. Do not allow another hard surface, such as an adjoining optional printer, or a soft surface, such as pillows or rugs or clothing, to block airflow. Also, do not allow the AC adapter to contact the skin or a soft surface, such as pillows or rugs or clothing, during operation. The computer and the AC adapter comply with the user-accessible surface temperature limits defined by the International Standard for Safety of Information Technology Equipment (IEC 60950-1).

Table of contents

| | |
|--|-----------|
| 1 Product description | 1 |
| 2 External component identification | 5 |
| Display | 5 |
| Top | 6 |
| TouchPad | 6 |
| Lights | 7 |
| Buttons, speakers, and fingerprint reader | 8 |
| Left | 9 |
| Right | 10 |
| Front | 11 |
| Bottom | 12 |
| Labels | 13 |
| 3 Illustrated parts catalog | 14 |
| Computer major components | 14 |
| Display assembly subcomponents | 18 |
| Bracket Kit | 19 |
| Plastics Kit | 20 |
| Miscellaneous parts | 21 |
| 4 Removal and replacement procedures preliminary requirements | 22 |
| Tools required | 22 |
| Service considerations | 22 |
| Plastic parts | 22 |
| Cables and connectors | 23 |
| Drive handling | 23 |
| Grounding guidelines | 23 |
| Electrostatic discharge damage | 23 |
| Packaging and transporting guidelines | 25 |
| Workstation guidelines | 25 |
| 5 Removal and replacement procedures for Customer Self-Repair parts | 27 |
| Component replacement procedures | 27 |
| Service door | 28 |
| Bottom cover | 29 |

| | |
|-------------------------------|----|
| Battery | 30 |
| Solid-state drive (M.2) | 31 |
| Hard drive | 32 |
| WLAN module | 34 |
| Memory module | 36 |
| RTC battery | 38 |

6 Removal and replacement procedures for authorized service provider parts 39

| | |
|--|----|
| Component replacement procedures | 39 |
| Thermal module | 39 |
| Fingerprint reader board | 42 |
| LED board | 43 |
| TouchPad | 44 |
| Display cable | 45 |
| System board | 46 |
| I/O support bracket | 49 |
| Speakers | 50 |
| Keyboard | 51 |
| Display assembly | 53 |
| Top cover | 60 |

7 Troubleshooting guide 61

| | |
|--|----|
| Resources | 62 |
| General troubleshooting steps | 62 |
| Identify the issue | 63 |
| 1. Understand the issue | 63 |
| Boot up sequence | 63 |
| Failure classification | 63 |
| 2. Examine the environment | 65 |
| 3. Perform a visual inspection of hardware | 66 |
| 4. Update BIOS and drivers | 66 |
| Manually updating BIOS and drivers | 66 |
| Remotely deploying BIOS and drivers | 66 |
| Analyze the issue | 66 |
| 5. Remove or uninstall recently added hardware, software | 66 |
| 6. HP Hardware Diagnostics and Tools | 67 |
| HP PC Hardware Diagnostics (UEFI) | 67 |
| HP Support Assistant (HPSA) | 69 |
| HP BIOS Configuration Utility (BCU) | 70 |
| HP Image Diagnostic Tool | 70 |
| HP Thermal Monitor | 70 |

| | |
|---|----|
| Non HP diagnostics tools | 70 |
| 7. Status lights, blinking light codes, troubleshooting lights, and POST error messages | 71 |
| Status lights | 71 |
| Blinking light codes | 72 |
| POST error messages | 72 |
| Power Good (Troubleshooting) lights | 73 |
| Resolve the issue | 74 |
| 8. Hard reset | 74 |
| 9. Soft reset (Default Settings) | 75 |
| 10. Reseat cables and connections | 75 |
| 11. Test with minimum configuration | 76 |
| Essential hardware configuration | 76 |
| Safe mode | 77 |
| 12. Test with verified working configuration (hardware and/or operating system) | 77 |
| 13. Replace the system board | 77 |
| Verify solution | 78 |
| Helpful Hints | 78 |
| At startup | 78 |
| During operation | 79 |
| Consulting with HP Service | 79 |
| Common issues and possible solutions | 80 |
| Power-on issues | 80 |
| No Power | 80 |
| Intermittent power-on, shutdown, reboot | 82 |
| AC adapter issue | 83 |
| Battery not recognized, not charging | 83 |
| Battery discharges too fast | 85 |
| Burnt smell | 86 |
| POST | 86 |
| No video (with power) | 86 |
| Blinking lights | 87 |
| Diagnostics error messages | 88 |
| BIOS password | 89 |
| Performance (OS) | 89 |
| Intermittent shutdown | 90 |
| Blue screen | 91 |
| Freeze at Windows Logo (hang/lockup) | 93 |
| Electromagnetic Interference (EMI) | 94 |
| No wake up | 95 |
| Unresponsive | 96 |

| | |
|---|-----|
| Slow performance | 96 |
| HP Smart Adapter warning message | 97 |
| Incorrect time and date | 97 |
| Display | 98 |
| Display anomalies | 98 |
| Symptom | 98 |
| Quick check | 99 |
| HP PC Hardware Diagnostics (UEFI) for video test | 99 |
| Display assembly diagram | 100 |
| Dead pixel | 100 |
| No video (internal) | 100 |
| No video (external) | 101 |
| DisplayPort/VGA | 101 |
| HDMI | 101 |
| No or bad external video via docking | 102 |
| Incorrect or missing color/distorted image | 102 |
| Touch screen | 103 |
| I/O devices | 104 |
| Keyboard | 104 |
| Keyboard point stick | 105 |
| Keyboard backlight | 105 |
| TouchPad | 106 |
| Network Connectivity Ethernet (RJ-45 jack) | 106 |
| Network connectivity wireless (WLAN) | 107 |
| WWAN | 108 |
| USB | 109 |
| Smart card reader | 110 |
| Speaker, headphone - audio issues | 111 |
| Thunderbolt (TB) | 112 |
| Storage | 113 |
| Hard drive/solid-state drive not recognized | 114 |
| No boot to operating system (no read/write error) | 114 |
| Read-write error | 115 |
| Slow performance | 115 |
| Blue screen (BSOD) error | 115 |
| Noisy hard drive | 116 |
| Mechanical | 117 |
| Fan error message - 90B | 117 |
| Noise (sound) | 118 |
| Fan runs constantly | 119 |
| Thermal shutdown (hot) | 120 |

| | |
|--|------------|
| Stuck power button | 120 |
| Additional information | 121 |
| Acronyms | 121 |
| Blinking lights and boot error codes | 122 |
| Processor not executing code | 122 |
| BIOS recovery code unable to find valid BIOS recovery image | 122 |
| Memory module error | 122 |
| Graphics Controller Error (No Controller) | 123 |
| Failure - System Board Error | 123 |
| Intel Trusted Execution Technology (TXT) Error | 123 |
| Sure Start unable to find valid BIOS Boot Block image | 123 |
| Sure Start has identified a problem (Manual Recovery Policy Set) | 124 |
| POST Error Messages and User Actions | 124 |
| Routine Maintenance for Performance Improvement | 126 |
| Common Blue Screen Error Messages | 126 |
| Error message list | 126 |
| Bug check symbolic names | 126 |
| Microsoft general troubleshooting of Windows bug check codes | 127 |
| Use Windows Debugging Tool | 127 |
| Windows Software Development Kit (SDK) | 128 |
| Display Issue: Pixel Anomalies | 132 |
| Cable management | 133 |
| Connector types | 134 |
| 8 Computer Setup (BIOS), TPM, and HP Sure Start in Windows 7 | 136 |
| Using Computer Setup | 136 |
| Starting Computer Setup | 136 |
| Navigating and selecting in Computer Setup | 136 |
| Restoring factory settings in Computer Setup | 137 |
| Updating the BIOS | 138 |
| Determining the BIOS version | 138 |
| Downloading a BIOS update | 138 |
| Changing the boot order using the f9 prompt | 139 |
| TPM BIOS settings (select products only) | 139 |
| Using HP Sure Start (select products only) | 140 |
| 9 Computer Setup (BIOS), TPM, and HP Sure Start in Windows 10 | 141 |
| Using Computer Setup | 141 |
| Starting Computer Setup | 141 |
| Navigating and selecting in Computer Setup | 141 |
| Restoring factory settings in Computer Setup | 142 |

| | |
|---|------------|
| Updating the BIOS | 143 |
| Determining the BIOS version | 143 |
| Downloading a BIOS update | 143 |
| Changing the boot order using the f9 prompt | 144 |
| TPM BIOS settings (select products only) | 144 |
| Using HP Sure Start (select products only) | 145 |
| 10 Using HP PC Hardware Diagnostics (UEFI) | 146 |
| Downloading HP PC Hardware Diagnostics (UEFI) to a USB device | 146 |
| 11 Backup and recovery in Windows 7 | 148 |
| Creating recovery media and backups | 148 |
| Guidelines | 148 |
| Creating recovery media with HP Recovery Disc Creator | 148 |
| Creating recovery media | 149 |
| Backing up your information | 149 |
| Performing a system recovery | 150 |
| Using the Windows recovery tools | 150 |
| Using f11 recovery tools (select models only) | 151 |
| Using Windows 7 operating system media | 151 |
| 12 Backing up, restoring, and recovering in Windows 10 | 153 |
| Creating recovery media and backups | 153 |
| Creating HP Recovery media (select products only) | 153 |
| Using Windows tools | 154 |
| Restore and recovery | 155 |
| Recovering using HP Recovery Manager | 155 |
| What you need to know before you get started | 155 |
| Using the HP Recovery partition (select products only) | 156 |
| Using HP Recovery media to recover | 156 |
| Changing the computer boot order | 157 |
| Removing the HP Recovery partition (select products only) | 157 |
| 13 Specifications | 158 |
| Computer specifications | 158 |
| 14 Statement of memory volatility | 159 |
| Nonvolatile memory usage | 163 |
| Questions and answers | 165 |
| Using HP Sure Start (select models only) | 166 |

| | |
|---------------------------|------------|
| 15 Recycling | 167 |
| Index | 168 |

1 Product description

| Category | Description |
|---------------------|--|
| Product Name | HP ZBook Studio G3 Mobile Workstation Model numbers: 15-ap000 – 15ap099 |
| Processors | 6th Generation Intel® Core™ i7 Processor, Skylake, quad-core, BGA: <ul style="list-style-type: none">Intel Core i7-6820HQ 2.70-GHz (up to 3.60-GHz) processor (2133-MHz front-side bus (FSB), 8.0-MB L3 cache, 45 W)Intel Core i7-6700HQ 2.60-GHz (up to 3.50-GHz) processor (2133-MHz front-side bus (FSB), 8.0-MB L3 cache, 45 W) 6th Generation Intel Xeon® Processor, Sky Lake, quad-core, BGA: <ul style="list-style-type: none">Xeon E3-1505M, 2.80-GHz (up to 3.70-GHz) processor (2133-MHz front-side bus (FSB), 8.0-MB L3 cache, 45 W) |
| Chipset | Mobile Intel CM236 chipset |
| Graphics | Intel UMA Graphics - with shared video memory Switchable graphics Core processors: Intel HD graphics 530 Xeon processors: Intel HD graphics P530 <ul style="list-style-type: none">NVIDIA® Quadro® M1000M NVIDIA N16P-Q1 with 2-GB GDDR5 graphics subsystem memory (128-MB×16, 1.35-V, 1400-MHz, qty 8, 128-bit, FBW) Support for hybrid (switchable) graphics Support for open GL Support for DisplayPort 1.2 Support for NVIDIA Mosaic Technology |
| Panel | 15.6-in, light-emitting diode (LED) backlight <ul style="list-style-type: none">Full-high definition (FHD), AntiGlare (AG), UWVA (1920×1080 resolution, 300 nits), with or without camera or touch screen with cameraUltra-high definition (UHD), AntiGlare (AG), UWVA (3840×2160 resolution, 340 nits), with or without cameraUltra-high definition (UHD), AntiGlare (AG), UWVA (3840×2160 resolution, 340 nits), Dream Color, with or without camera All panels are 16:9 aspect ratio |
| Memory | Two customer-accessible/upgradable memory module slots Support for DDR4 2133-MHz PC4-17000 dual channel memory Support for 32-GB of system RAM in the following configurations: DDR4-2133: (for models with Core processors) <ul style="list-style-type: none">32-GB total system memory (16-GB×2)16-GB total system memory (16-GB×1 or 8-GB×2) |

| Category | Description |
|------------------------------|--|
| | <ul style="list-style-type: none"> 8-GB total system memory (8192-GB×1, 4096-GB×2) <p>ECC DDR4-2133: (for models with Xeon processors)</p> <ul style="list-style-type: none"> 32-GB total system memory (16-GB×2) 16-GB total system memory (16-GB×1 or 8-GB×2) 8-GB total system memory (8192-GB) |
| Primary M.2 storage | <p>M.2 (NGFF) SS/DS Solid State Drive (2280)</p> <p>SATA:</p> <p>512-GB SATA-3 self-encrypting drive (Opal 2)</p> <p>256-GB SATA-3 self-encrypting drive (Opal 2)</p> <p>128-GB SATA-3, TLC</p> <p>PCIe:</p> <p>1 TB (NVMe)</p> <p>512 GB (NVMe)</p> <p>256 GB (NVMe)</p> |
| Secondary M.2 storage | <p>M.2 (NGFF) SS/DS Solid State Drive (2280)</p> <p>SATA:</p> <p>512-GB SATA-3 self-encrypting drive (Opal 2)</p> <p>256-GB SATA-3 self-encrypting drive (Opal 2)</p> <p>128-GB SATA-3, TLC</p> <p>PCIe:</p> <p>1 TB (NVMe)</p> <p>512 GB (NVMe)</p> <p>256 GB (NVMe)</p> |
| Audio and video | <p>Stereo speakers</p> <p>Dual array microphone</p> <p>Intel SST Audio</p> <p>Conexant Smart Amplifier & Ambient Noise Suppression with DTS Studio Sound</p> <p>Integrated HD 720p webcam</p> <p>Support for no webcam option</p> |
| Ethernet | <p>Intel I219-LM 10/100/1000 Ethernet, with Intel I217-LM Gigabit Network Connection</p> <p>S3/S4/S5 wake on LAN</p> |
| Wireless | <p>WLAN</p> <p>Integrated wireless local area network (WLAN) options by way of wireless module</p> <p>Two WLAN antennas built into display assembly</p> <p>Support for the following WLAN formats:</p> <ul style="list-style-type: none"> Intel Dual Band Wireless-AC 7260 802.11 AC 2x2 WiFi + BT 4.0 Combo Adapter Intel Dual Band Wireless-N 7260AN 802.11 a/b/g/n (2x2) WiFi + BT 4.0 combo |

| Category | Description |
|----------------------------------|---|
| | <p>WPAN</p> <p>Bluetooth® 4.1 only supported via combo card</p> |
| External media cards | <p>Integrated SD UHS-II flash media slot</p> <p>Supports next generation SD, SDHC, SDXC</p> |
| Ports | <ul style="list-style-type: none"> • Multi-Pin AC Port • Combination mic-in/stereo headphone jack • RJ-45 (Ethernet) • USB Type-C Thunderbolt • USB 3.0 (2) • USB 3.0 charging (1) • HDMI |
| Docking | <p>Docking support for HP Advanced Docking Station</p> |
| Keyboard/pointing devices | <p>Keyboard</p> <p>Backlit</p> <p>DuraKeys</p> <p>TouchPad</p> <ul style="list-style-type: none"> • On/off button • Glass with chemical etched surface • Taps enabled by default • Gestures enabled by default: <ul style="list-style-type: none"> ◦ 2-finger scrolling ◦ 2-finger zoom (pinch) • Image sensor TouchPad |
| Power requirements | <p>AC adapter</p> <ul style="list-style-type: none"> • 150-W, HP Smart Adapter, slim <p>Battery</p> <ul style="list-style-type: none"> • 4-cell, 64-WHr, 4.21-AHr, Li-ion battery <p>Power cord (localized)</p> <p>3-wire plug, 1.8 m (with ground pin)</p> |
| Security | <p>Support security lock</p> <p>Trusted platform module (TPM) 9760 1.2/2.0 (Infineon; soldered down)</p> <p>Fingerprint reader</p> <p>BIOS Preboot power on - BIOS option (Password, Fingerprint)</p> <p>Drive Encryption preboot option (fingerprint, password, smart card)</p> |
| Operating system | <p>Preinstalled:</p> <ul style="list-style-type: none"> • Windows 10 Home 64 |

| Category | Description |
|-----------------------|--|
| | <ul style="list-style-type: none"> Windows 10 Home Single Language 64 Windows 10 Pro 64 Windows 10 Pro 64 Downgrade Windows 7 Windows 7 Professional FreeDOS 2.0 |
| | <p>Restore media-DRDVD:</p> <ul style="list-style-type: none"> DRDVD Windows 10 (available with any Windows 10 operating system and required with any Windows 10 Downgrade operating system) DRDVD Windows 7 Service Pack 1 (available with any Windows 7 or Windows 10 Downgrade operating system) |
| | <p>Restore media-OSDVD:</p> <ul style="list-style-type: none"> Windows 10 (only available and required with Windows 10 Downgrade operating system; not available in People's Republic of China or Asia) Windows 7 Service Pack 1 (available with any Windows 7 Professional or Windows 10 Downgrade operating system; not available in the People's Republic of China or Asia) |
| | <p>Certified:</p> <ul style="list-style-type: none"> Microsoft WHQL |
| | <p>Supported:</p> <ul style="list-style-type: none"> Red Hat® Enterprise Linux (RHEL) 6.x 64bit Red Hat® Enterprise Linux (RHEL) 7.x 64bit |
| | <p>Web-only support:</p> <ul style="list-style-type: none"> Windows 10 Enterprise Windows 7 Enterprise 64-bit, Service Pack 1 |
| Serviceability | <p>End user replaceable parts:</p> <ul style="list-style-type: none"> AC adapter Battery (system) Memory modules Solid-state drive WLAN module |

2 External component identification

Display



| Component | Description |
|---|--|
| (1) WLAN antennas* (select products only) | Send and receive wireless signals to communicate with wireless local area networks (WLANs). |
| (2) Internal microphones (2) (select products only) | Record sound. |
| (3) Webcam light (select products only) | On: The webcam is in use. |
| (4) Webcam (select products only) | Records video and captures photographs. Some models allow you to video conference and chat online using streaming video. To use the webcam in Windows 10: <ul style="list-style-type: none">▲ Type <code>camera</code> in the taskbar search box, and then select Camera. For information on using the webcam in Windows 7, select Start > All Programs > Communication and Chat > HP WebCam . |

*The antennas are not visible from the outside of the computer. For optimal transmission, keep the areas immediately around the antennas free from obstructions.

For wireless regulatory notices, see the section of the *Regulatory, Safety, and Environmental Notices* that applies to your country or region.

To access this guide in Windows 10:

1. Type `support` in the taskbar search box, and then select the **HP Support Assistant** app.

– or –

| Component | Description |
|-----------|--|
| | Click the question mark icon in the taskbar. |
| 2. | Select My PC , select the Specifications tab, and then select User Guides . |
| | To access the user guides in Windows 7, select Start > All Programs > HP Help and Support > HP Documentation . |

Top



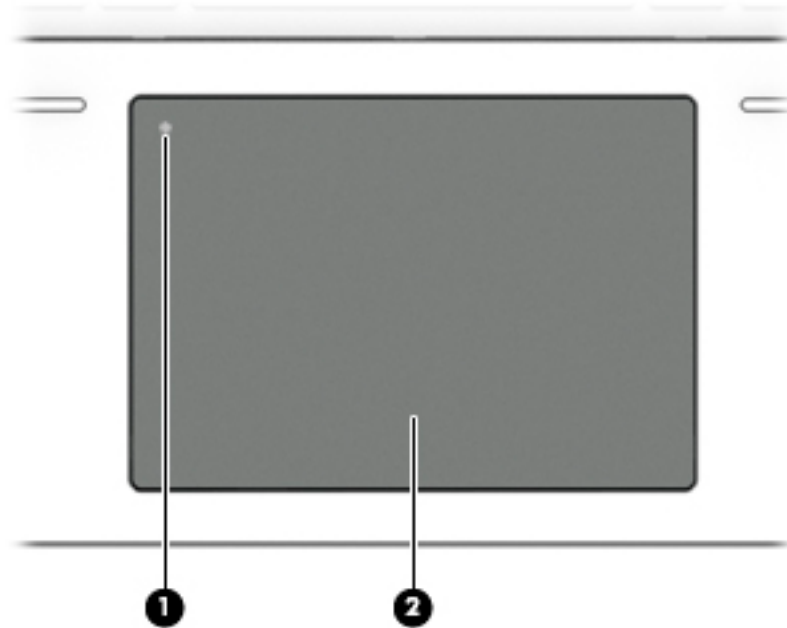

TouchPad

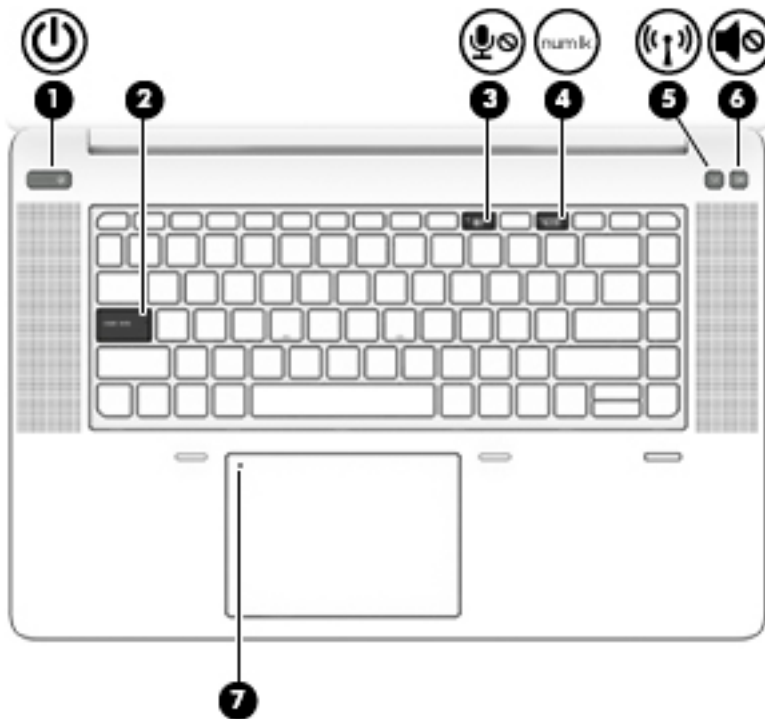

| Component | Description | |
|-----------|------------------------|---|
| (1) | TouchPad on/off button | Turns the TouchPad on and off. |
| (2) | TouchPad zone | Reads your finger gestures to move the pointer or activate items on the screen. |



Lights

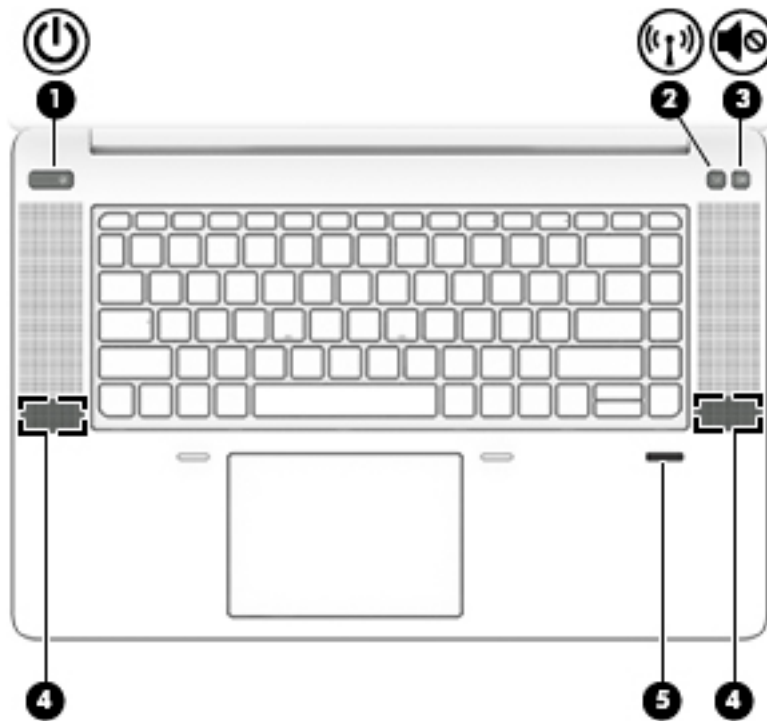

| Component | Description |
|---|---|
| (1)  Power light | <ul style="list-style-type: none"> On: The computer is on. Blinking: The computer is in the Sleep state, a power-saving state. The computer shuts off power to the display and other unneeded components. Off: The computer is off or in Hibernation. Hibernation is a power-saving state that uses the least amount of power. |
| (2) Caps lock light | On: Caps lock is on, which switches the key input to all capital letters. |
| (3)  Microphone mute light | <ul style="list-style-type: none"> Amber: Microphone sound is off. Off: Microphone sound is on. |
| (4)  Num lock light | On: Num lock is on. |
| (5)  Wireless light | <p>On: An integrated wireless device, such as a wireless local area network (WLAN) device and/or a Bluetooth® device, is on.</p> <p>NOTE: On some models, the wireless light is amber when all wireless devices are off.</p> |
| (6)  Mute light | <ul style="list-style-type: none"> Amber: Computer sound is off. Off: Computer sound is on. |
| (7) TouchPad light | <ul style="list-style-type: none"> On: The TouchPad is off. Off: The TouchPad is on. |

Buttons, speakers, and fingerprint reader





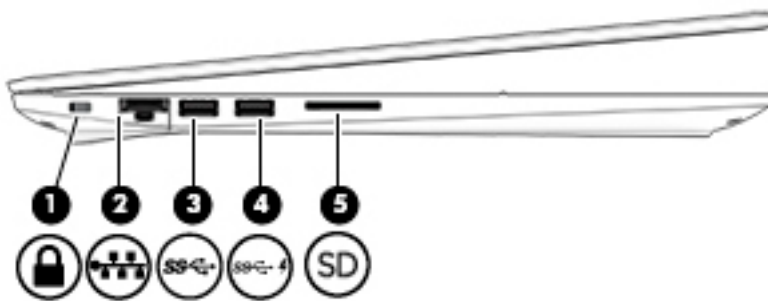

| Component | Description |
|---|---|
| (1)  Power button | <ul style="list-style-type: none"> • When the computer is off, press the button to turn on the computer. • When the computer is on, press the button briefly to initiate Sleep. • When the computer is in the Sleep state, press the button briefly to exit Sleep. • When the computer is in Hibernation, press the button briefly to exit Hibernation. <p>CAUTION: Pressing and holding down the power button results in the loss of unsaved information.</p> <p>If the computer has stopped responding and shutdown procedures are ineffective, press and hold the power button for at least 5 seconds to turn off the computer.</p> <p>To learn more about your power settings in Windows 10, see your power options.</p> <p>▲ Type <code>power</code> in the taskbar search box, and then select Power and sleep settings.</p> <p>– or –</p> <p>Right-click the Start button, and then select Power Options.</p> <p>To learn more about your power settings in Windows 7: Select Start > Control Panel > System and Security > Power Options.</p> |
| (2)  Wireless button | Turns the wireless feature on or off but does not establish a wireless connection. |

| Component | Description |
|---|--|
| | A wireless network must be set up before a wireless connection is possible. |
| (3)  | Volume mute button Mutes and restores speaker sound. |
| (4) | Speakers (2) Produce sound. |
| (5) | Fingerprint reader (select products only) Allows a fingerprint logon to Windows, instead of a password logon. |





Left

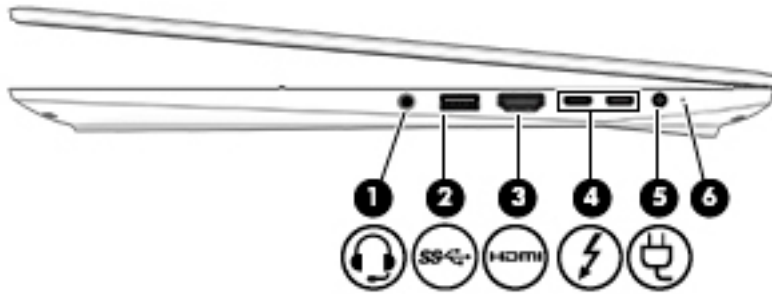

| Component | Description |
|---|---|
| (1)  | Security cable slot Attaches an optional security cable to the computer. NOTE: The security cable is designed to act as a deterrent, but it may not prevent the computer from being mishandled or stolen. |
| (2)  | RJ-45 (network) jack/status lights Connects a network cable. <ul style="list-style-type: none"> Green (left): The network is connected. Amber (right): Activity is occurring on the network. |
| (3)  | USB 3.0 port Connects an optional USB device, such as a keyboard, mouse, external drive, printer, scanner, or USB hub. |
| (4)  | USB 3.0 charging (powered) port Connects an optional USB device, such as a keyboard, mouse, external drive, printer, scanner, or USB hub. Standard USB ports will not charge all USB devices or will charge using a low current. Some USB devices require power and require you to use a powered port. NOTE: USB charging ports can also charge select models of cell phones and MP3 players, even when the computer is off. |
| (5)  | Memory card reader Reads optional memory cards that store, manage, share, or access information. |

Right







| Component | Description |
|---|--|
| (1)  Audio-out (headphone)/Audio-in (microphone) combo jack | <p>Connects optional powered stereo speakers, headphones, earbuds, a headset, or a television audio cable. Also connects an optional headset microphone. This jack does not support optional microphone-only devices.</p> <p>WARNING! To reduce the risk of personal injury, adjust the volume before putting on headphones, earbuds, or a headset. For additional safety information, refer to the <i>Regulatory, Safety, and Environmental Notices</i>.</p> <p>To access this guide in Windows 10:</p> <ol style="list-style-type: none"> 1. Type support in the taskbar search box, and then select the HP Support Assistant app. – or – Click the question mark icon in the taskbar. 2. Select My PC, select the Specifications tab, and then select User Guides. <p>To access the user guides in Windows 7, select Start > All Programs > HP Help and Support > HP Documentation.</p> <p>NOTE: When a device is connected to the jack, the computer speakers are disabled.</p> |
| (2)  USB 3.0 port | <p>Connects an optional USB device, such as a keyboard, mouse, external drive, printer, scanner, or USB hub.</p> |
| (3)  HDMI port | <p>Connects an optional video or audio device, such as a high-definition television, any compatible digital or audio component, or a high-speed High Definition Multimedia Interface (HDMI) device.</p> |
| (4)  USB Type-C (charging) ports (2) | <p>Connect any USB device with a Type-C connector.</p> <p>NOTE: USB Type-C ports charge products such as cell phones, laptops, tablets, and MP3 players, even when the computer is off. Also, some USB Type-C ports connect DisplayPort, VGA, HDMI and other video devices to provide video output.</p> <p>NOTE: Adapters (purchased separately) may be required.</p> |
| (5)  Power connector | <p>Connects an AC adapter.</p> |
| (6) AC adapter and battery light | <ul style="list-style-type: none"> • White: The AC adapter is connected. |

| Component | Description |
|-----------|---|
| | <ul style="list-style-type: none"> Off: The AC adapter is not connected. |

Front



| Component | Description |
|---|---|
| (1)  Wireless light | <p>On: An integrated wireless device, such as a wireless local area network (WLAN) device and/or a Bluetooth® device, is on.</p> <p>NOTE: On some models, the wireless light is amber when all wireless devices are off.</p> |
| (2)  Power light | <ul style="list-style-type: none"> On: The computer is on. Blinking: The computer is in the Sleep state, a power-saving state. The computer shuts off power to the display and other unneeded components. Off: The computer is off or in Hibernation. Hibernation is a power-saving state that uses the least amount of power. |
| (3)  Battery light | <p>When AC power is connected:</p> <ul style="list-style-type: none"> White: The battery charge is greater than 90 percent. Amber: The battery charge is from 0 to 90 percent. Off: The battery is not charging. <p>When AC power is disconnected:</p> <ul style="list-style-type: none"> Blinking amber: The battery has reached a low battery level. When the battery has reached a critical battery level, the battery light begins blinking rapidly. Off: The battery is not charging. |
| (4)  Drive light | <ul style="list-style-type: none"> Blinking white: The hard drive is being accessed. Amber: HP 3D DriveGuard has temporarily parked the hard drive. |

Bottom

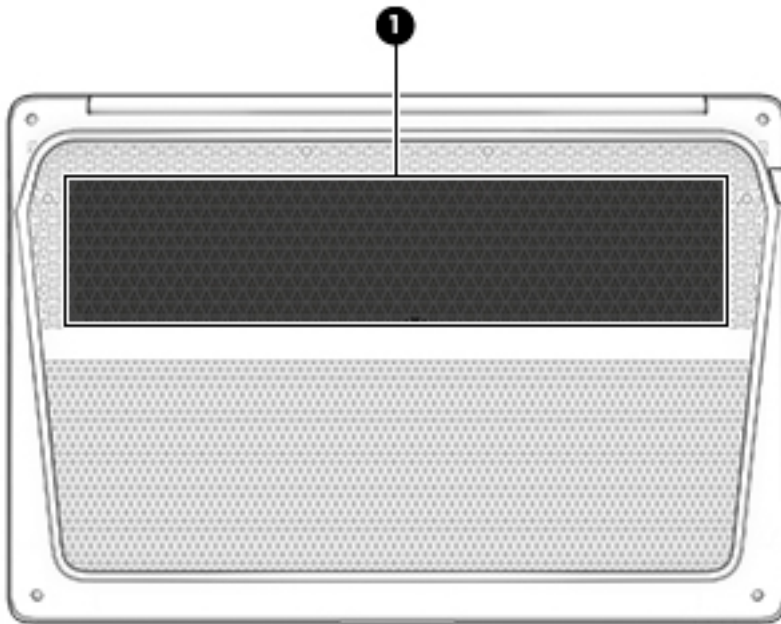

| Component | | Description |
|-----------|--|-------------|
|-----------|--|-------------|

(1)

Vent

Enables airflow to cool internal components.

NOTE: The computer fan starts up automatically to cool internal components and prevent overheating. It is normal for the internal fan to cycle on and off during routine operation.

Labels

The labels affixed to the computer provide information you may need when you troubleshoot system problems or travel internationally with the computer.

 **IMPORTANT:** Check the following locations for the labels described in this section: the bottom of the computer, inside the battery bay, under the service door, or on the back of the display.

- Service label—Provides important information to identify your computer. When contacting support, you will probably be asked for the serial number, and possibly for the product number or the model number. Locate these numbers before you contact support.

Your service label will resemble one of the examples shown below. Refer to the illustration that most closely matches the service label on your computer.



Component

- (1) Serial number
 - (2) Product number
 - (3) Warranty period
 - (4) Model number (select products only)
-

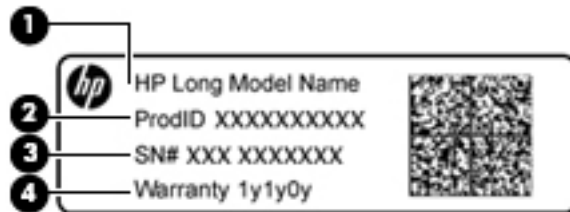

Component

- (1) Model name (select products only)
 - (2) Product number
 - (3) Serial number
 - (4) Warranty period
-

- Regulatory label(s)—Provide(s) regulatory information about the computer.
- Wireless certification label(s)—Provide(s) information about optional wireless devices and the approval markings for the countries or regions in which the devices have been approved for use.

3 Illustrated parts catalog

Computer major components

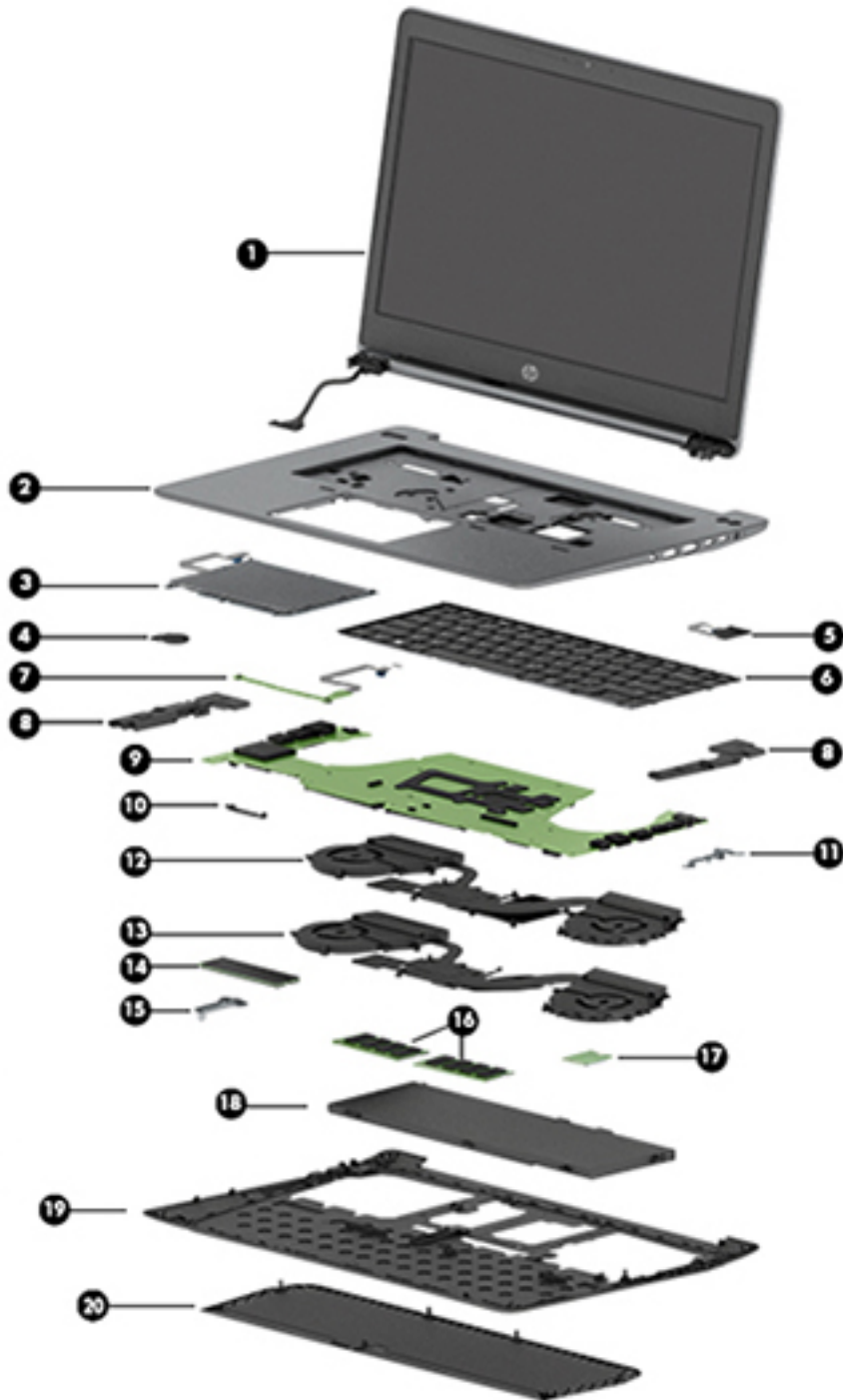

| Item | Component | Spare part number |
|------------|---|-------------------|
| (1) | Display assembly: The DreamVision display assembly is spared as a whole unit assembly only. The LED display assembly is spared at the subcomponent level only. For more LED display assembly spare part information, see Display assembly subcomponents on page 18 . | |
| | 15.6-in, UHD, UWVA, DreamVision display assembly not equipped with a webcam | 840945-001 |
| | 15.6-in, UHD, UWVA, DreamVision display assembly equipped with a webcam | 840946-001 |
| | 15.6-in, FHD, UWVA display assembly with a touch screen | 840947-001 |
| (2) | Top cover | 840636-001 |
| (3) | TouchPad (includes cable) | 840962-001 |
| (4) | RTC battery (includes cable and double-sided adhesive) | 840953-001 |
| (5) | Fingerprint reader board (includes bracket) | 840952-001 |
| (6) | Keyboard (includes keyboard cable): | |
| | For use in Belgium | 841681-A41 |
| | For use in Brazil | 841681-201 |
| | For use in Bulgaria | 841681-261 |
| | For use in Canada | 841681-DB1 |
| | For use in the Czech Republic and Slovakia | 841681-FL1 |
| | For use in Denmark | 841681-081 |
| | For use in France | 841681-051 |
| | For use in Germany | 841681-041 |
| | For use in Greece | 841681-151 |
| | For use in Hungary | 841681-211 |
| | For use in Iceland | 841681-DD1 |
| | For use in India | 841681-D61 |
| | For use in Israel | 841681-BB1 |
| | For use in Italy | 841681-061 |
| | For use in Japan | 841681-291 |
| | For use in Latin America | 841681-161 |
| | For use in the Netherlands | 841681-B31 |
| | For use in Northwest Africa | 841681-FP1 |
| | For use in Norway | 841681-091 |
| | For use in Portugal | 841681-131 |
| | For use in Romania | 841681-271 |
| | For use in Russia | 841681-251 |
| | For use in Saudi Arabia | 841681-171 |
| | For use in Slovenia | 841681-BA1 |

| Item | Component | Spare part number |
|-------------|--|--------------------------|
| | For use in South Korea | 841681-AD1 |
| | For use in Spain | 841681-071 |
| | For use in Sweden and Finland | 841681-B71 |
| | For use in Switzerland | 841681-BG1 |
| | For use in Taiwan | 841681-AB1 |
| | For use in Thailand | 841681-281 |
| | For use in Turkey | 841681-141 |
| | For use in the United Kingdom and Singapore | 841681-031 |
| | For use in the United States | 841681-001 |
| (7) | LED board | 840957-001 |
| (8) | Speakers (include cable) | 840958-001 |
| (9) | System board (includes processor and replacement thermal material): All system boards use the following part numbers: xxxxxx-001: Windows 7 or non-Windows operating systems xxxxxx-601: Windows 10 operating system | |
| | Intel Xeon E3-1505M processor | 840933-xxx |
| | Intel Core i7-6820HQ processor and discrete graphics memory | 840932-xxx |
| | Intel Core i7-6820HQ processor and UMA graphics memory | 840930-xxx |
| | Intel Core i7-6700HQ processor and discrete graphics memory | 840931-xxx |
| | Intel Core i7-6700HQ processor and UMA graphics memory | 840929-xxx |
| (10) | Display cable (eDP) bracket (included in Bracket Kit, spare part number 840966-001) | 840966-001 (Bracket Kit) |
| (11) | I/O support bracket (included in Bracket Kit, spare part number 840966-001) | 840966-001 (Bracket Kit) |
| | Fan/heat sink assembly (includes replacement thermal material): | |
| (12) | For use only with models with discrete graphics memory | 840960-001 |
| (13) | For use only with models with UMA graphics memory | 840961-001 |
| (14) | Solid-state drive (SSD): | |
| | 1-TB, Z Turbo drive PCIe | 840951-001 |
| | 512-GB, Z Turbo Drive, PCIe | 840950-001 |
| | 256-GB, Z Turbo Drive, PCIe | 840949-001 |
| | 256-GB, SATA-3, self-encrypting drive (SED), OPAL 2 | 840948-001 |
| | 128-GB, TLC | 846386-001 |
| (15) | Solid-state drive bracket (included in Bracket Kit, spare part number 840966-001) | 840966-001 (Bracket Kit) |
| (16) | Memory module (PC4, 17000, 2133-MHz): For use with Core processors: | |

| Item | Component | Spare part number |
|-------------|--|--------------------------|
| | <ul style="list-style-type: none"> • 16 GB | 820571-001 |
| | <ul style="list-style-type: none"> • 8 GB | 820570-001 |
| | <ul style="list-style-type: none"> • 4 GB | 820569-001 |
| | For use with Xeon processors: | |
| | <ul style="list-style-type: none"> • 16 GB, ECC | 835886-001 |
| | <ul style="list-style-type: none"> • 8 GB, ECC | 835887-001 |
| (17) | WLAN module: | |
| | Intel Dual Band Wireless-AC 8260 3rd Gen Intel 802.11ac, Dual Band, 2x2 Wi-Fi + Bluetooth 4.2 | 806721-001 |
| | Intel Dual Band Wireless-AC 8260 3rd Gen Intel 802.11ac, Dual Band, 2x2 Wi-Fi + Bluetooth 4.2 (non-vPro) | 806722-001 |
| (18) | Battery , 4-cell, 64-WHr, 4.21-AHr, Li-ion battery | 808450-001 |
| (19) | Bottom cover | 840954-001 |
| (20) | Service door | 840959-001 |

Display assembly subcomponents

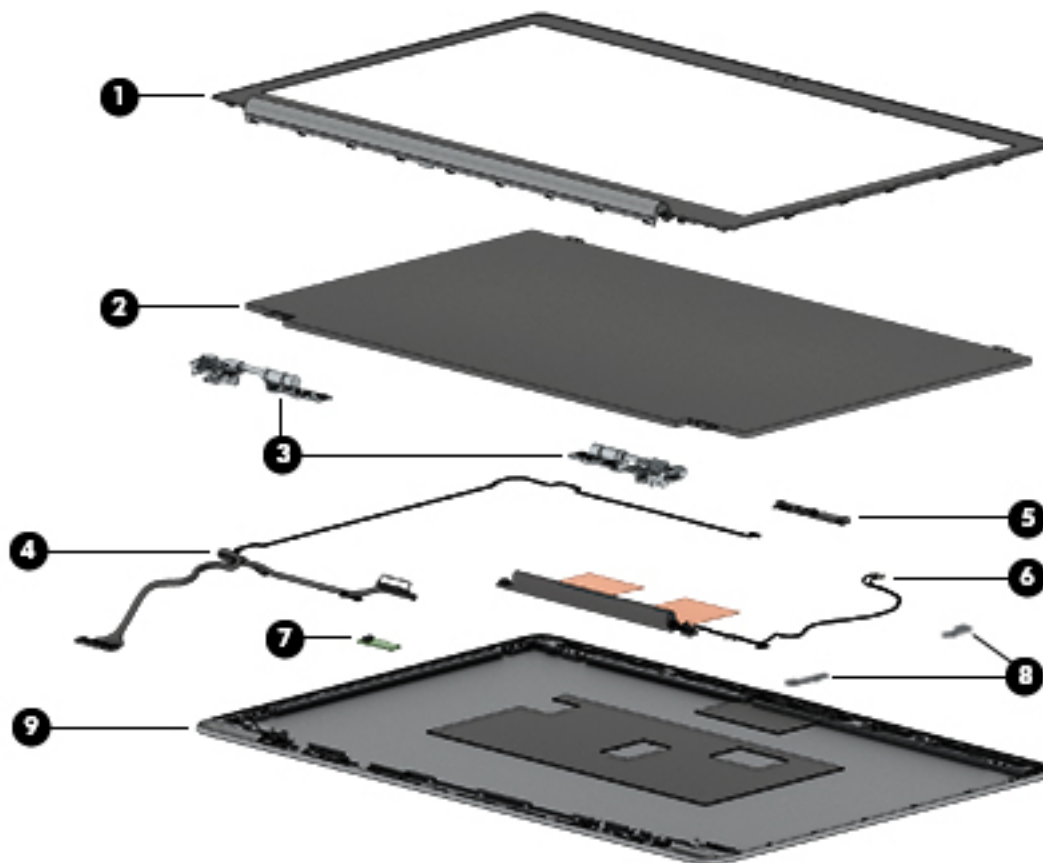

| Item | Component | Spare part number |
|------|---|--------------------------|
| (1) | Display bezel | |
| | For use only on computer models equipped with a webcam | 840935-001 |
| | For use only on computer models not equipped with a webcam | 840936-001 |
| (2) | Display panel | |
| | 15.6-in, FHD, UWVA, LED display panel | 840941-001 |
| | 15.6-in, UHD, UWVA, B LED display panel | 840943-001 |
| (3) | Display hinges (includes left and right hinges) | 840937-001 |
| (4) | Display Cable Kit | 840938-001 |
| (5) | Webcam module (includes double-sided adhesive) | 840965-001 |
| (6) | Antenna (left and right) | 840940-001 |
| (7) | Thermal board | 840956-001 |
| (8) | Display panel bracket (only spared with UHD displays; included in Bracket Kit, spare part number 840966-001) | 840966-001 (Bracket Kit) |
| (9) | Display enclosure | 844836-001 |

Bracket Kit

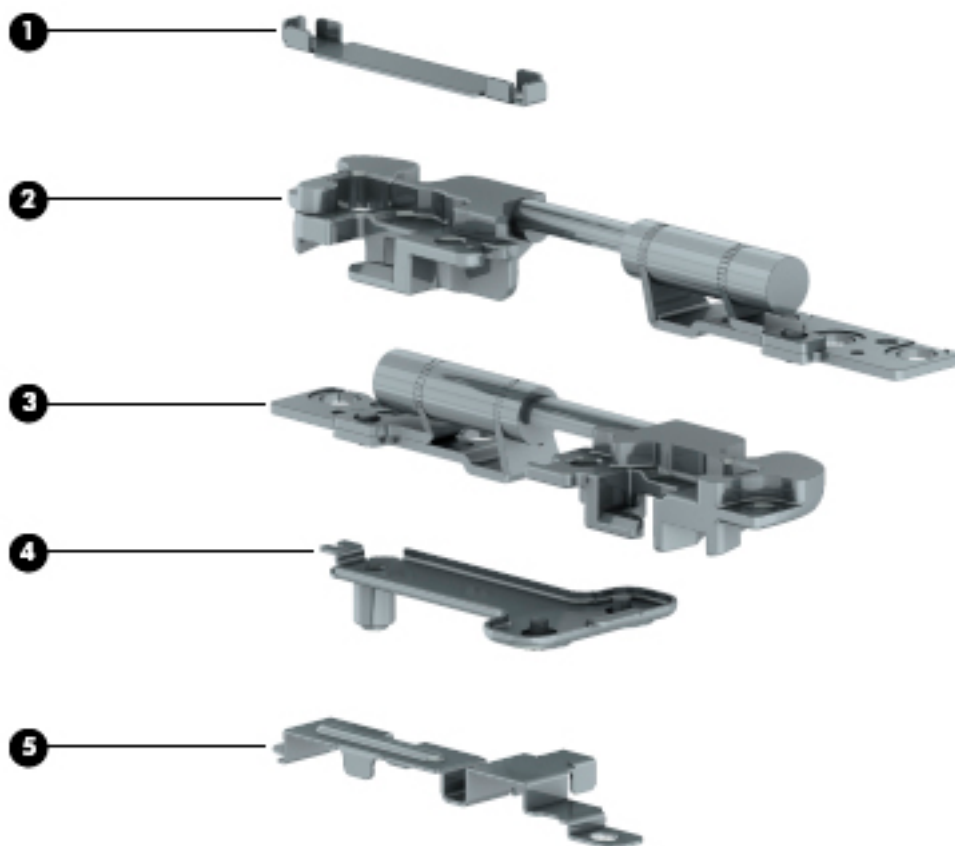

| Item | Component | Spare part number |
|------|------------------------------|-------------------|
| | Bracket Kit | 840966-001 |
| (1) | EDP bracket | |
| (2) | Display panel bracket, left | |
| (3) | Display panel bracket, right | |
| (4) | 2nd SSD bracket | |
| (5) | I/O support bracket | |

Plastics Kit



| Item | Component | Spare part number |
|------|---------------------------|-------------------|
| | Plastics Kit | 840964-001 |
| (1) | Fingerprint reader insert | |
| (2) | Card reader insert | |

Miscellaneous parts

| Component | Spare part number |
|--|--------------------------|
| AC adapter | |
| 150-W HP Smart adapter (PFC, 4.5-mm) | 776620-001 |
| Power cord (3-pin, black, 1.83-m): | |
| For use in Argentina | 490371-D01 |
| For use in Australia | 490371-011 |
| For use in Brazil | 490371-202 |
| For use in Denmark | 490371-081 |
| For use in Europe | 490371-021 |
| For use in India | 490371-D61 |
| For use in Israel | 490371-BB1 |
| For use in Italy | 490371-061 |
| For use in Japan | 490371-291 |
| For use in North America | 490371-001 |
| For use in the People's Republic of China | 490371-AA1 |
| For use in South Africa | 490371-AR1 |
| For use in South Korea | 490371-AD1 |
| For use in Switzerland | 490371-111 |
| For use in Taiwan | 490371-AB1 |
| For use in Thailand | 490371-201 |
| For use in the United Kingdom and Singapore | 490371-031 |
| HP USB External DVD+RW Drive | 747080-001 |
| HP Professional Slim Top Load Case | 703888-001 |
| HP Business Top Load Case | 718550-001 |
| Fingerprint reader insert (for use in models without a fingerprint reader; included in Plastic Kit, spare part number 840964-001) | 840964-001 (Plastic Kit) |
| Card reader insert (included in Plastic Kit, spare part number 840964-001) | 840964-001 (Plastic Kit) |
| HP Ultralim Keyed Cable Lock | 703372-001 |
| HP USB-C to USB 3.0 adapter | 814618-001 |
| Screw Kit | 840939-001 |
| Mouse | |
| HP USB laser | 674318-001 |
| HP Wireless | 691922-001 |
| HP Ultrathin Bluetooth Mouse | 811730-001 |

4 Removal and replacement procedures preliminary requirements

Tools required

You will need the following tools to complete the removal and replacement procedures:

- Flat-bladed screw driver
- Magnetic screw driver
- Phillips P0 and P1 screw drivers
- Torx screwdriver

Service considerations

The following sections include some of the considerations that you must keep in mind during disassembly and assembly procedures.



NOTE: As you remove each subassembly from the computer, place the subassembly (and all accompanying screws) away from the work area to prevent damage.

Plastic parts



CAUTION: Using excessive force during disassembly and reassembly can damage plastic parts. Use care when handling the plastic parts. Apply pressure only at the points designated in the maintenance instructions.

Cables and connectors

⚠ CAUTION: When servicing the computer, be sure that cables are placed in their proper locations during the reassembly process. Improper cable placement can damage the computer.

Cables must be handled with extreme care to avoid damage. Apply only the tension required to unseat or seat the cables during removal and insertion. Handle cables by the connector whenever possible. In all cases, avoid bending, twisting, or tearing cables. Be sure that cables are routed in such a way that they cannot be caught or snagged by parts being removed or replaced. Handle flex cables with extreme care; these cables tear easily.

Drive handling

⚠ CAUTION: Drives are fragile components that must be handled with care. To prevent damage to the computer, damage to a drive, or loss of information, observe these precautions:

Before removing or inserting a hard drive, shut down the computer. If you are unsure whether the computer is off or in Hibernation, turn the computer on, and then shut it down through the operating system.

Before handling a drive, be sure that you are discharged of static electricity. While handling a drive, avoid touching the connector.

Before removing an optical drive, be sure that a disc is not in the drive and be sure that the optical drive tray is closed.

Handle drives on surfaces covered with at least one inch of shock-proof foam.

Avoid dropping drives from any height onto any surface.

After removing a hard drive or an optical drive, place it in a static-proof bag.

Avoid exposing an internal hard drive to products that have magnetic fields, such as monitors or speakers.

Avoid exposing a drive to temperature extremes or liquids.

If a drive must be mailed, place the drive in a bubble pack mailer or other suitable form of protective packaging and label the package "FRAGILE."

Grounding guidelines

Electrostatic discharge damage

Electronic components are sensitive to electrostatic discharge (ESD). Circuitry design and structure determine the degree of sensitivity. Networks built into many integrated circuits provide some protection, but in many cases, ESD contains enough power to alter device parameters or melt silicon junctions.

A discharge of static electricity from a finger or other conductor can destroy static-sensitive devices or microcircuitry. Even if the spark is neither felt nor heard, damage may have occurred.

An electronic device exposed to ESD may not be affected at all and can work perfectly throughout a normal cycle. Or the device may function normally for a while, then degrade in the internal layers, reducing its life expectancy.

⚠ CAUTION: To prevent damage to the computer when you are removing or installing internal components, observe these precautions:

Keep components in their electrostatic-safe containers until you are ready to install them.

Before touching an electronic component, discharge static electricity by using the guidelines described in this section.

Avoid touching pins, leads, and circuitry. Handle electronic components as little as possible.

If you remove a component, place it in an electrostatic-safe container.

The following table shows how humidity affects the electrostatic voltage levels generated by different activities.

⚠ CAUTION: A product can be degraded by as little as 700 V.

| Typical electrostatic voltage levels | | | |
|--------------------------------------|-------------------|----------|---------|
| Event | Relative humidity | | |
| | 10% | 40% | 55% |
| Walking across carpet | 35,000 V | 15,000 V | 7,500 V |
| Walking across vinyl floor | 12,000 V | 5,000 V | 3,000 V |
| Motions of bench worker | 6,000 V | 800 V | 400 V |
| Removing DIPS from plastic tube | 2,000 V | 700 V | 400 V |
| Removing DIPS from vinyl tray | 11,500 V | 4,000 V | 2,000 V |
| Removing DIPS from styrene foam | 14,500 V | 5,000 V | 3,500 V |
| Removing bubble pack from PCB | 26,500 V | 20,000 V | 7,000 V |
| Packing PCBs in foam-lined box | 21,000 V | 11,000 V | 5,000 V |

Packaging and transporting guidelines

Follow these grounding guidelines when packaging and transporting equipment:

- To avoid hand contact, transport products in static-safe tubes, bags, or boxes.
- Protect ESD-sensitive parts and assemblies with conductive or approved containers or packaging.
- Keep ESD-sensitive parts in their containers until the parts arrive at static-free workstations.
- Place items on a grounded surface before removing items from their containers.
- Always be properly grounded when touching a component or assembly.
- Store reusable ESD-sensitive parts from assemblies in protective packaging or nonconductive foam.
- Use transporters and conveyors made of antistatic belts and roller bushings. Be sure that mechanized equipment used for moving materials is wired to ground and that proper materials are selected to avoid static charging. When grounding is not possible, use an ionizer to dissipate electric charges.

Workstation guidelines

Follow these grounding workstation guidelines:

- Cover the workstation with approved static-shielding material.
- Use a wrist strap connected to a properly grounded work surface and use properly grounded tools and equipment.
- Use conductive field service tools, such as cutters, screw drivers, and vacuums.
- When fixtures must directly contact dissipative surfaces, use fixtures made only of static-safe materials.
- Keep the work area free of nonconductive materials, such as ordinary plastic assembly aids and styrene foam.
- Handle ESD-sensitive components, parts, and assemblies by the case or PCM laminate. Handle these items only at static-free workstations.
- Avoid contact with pins, leads, or circuitry.
- Turn off power and input signals before inserting or removing connectors or test equipment.

Equipment guidelines

Grounding equipment must include either a wrist strap or a foot strap at a grounded workstation.

- When seated, wear a wrist strap connected to a grounded system. Wrist straps are flexible straps with a minimum of one megohm $\pm 10\%$ resistance in the ground cords. To provide proper ground, wear a strap snugly against the skin at all times. On grounded mats with banana-plug connectors, use alligator clips to connect a wrist strap.
- When standing, use foot straps and a grounded floor mat. Foot straps (heel, toe, or boot straps) can be used at standing workstations and are compatible with most types of shoes or boots. On conductive floors or dissipative floor mats, use foot straps on both feet with a minimum of one megohm resistance between the operator and ground. To be effective, the conductive equipment must be worn in contact with the skin.

The following grounding equipment is recommended to prevent electrostatic damage:

- Antistatic tape
- Antistatic smocks, aprons, and sleeve protectors
- Conductive bins and other assembly or soldering aids
- Nonconductive foam
- Conductive tabletop workstations with ground cords of one megohm resistance
- Static-dissipative tables or floor mats with hard ties to the ground
- Field service kits
- Static awareness labels
- Material-handling packages
- Nonconductive plastic bags, tubes, or boxes
- Metal tote boxes
- Electrostatic voltage levels and protective materials

The following table lists the shielding protection provided by antistatic bags and floor mats.

| Material | Use | Voltage protection level |
|-----------------------|------------|--------------------------|
| Antistatic plastics | Bags | 1,500 V |
| Carbon-loaded plastic | Floor mats | 7,500 V |
| Metallized laminate | Floor mats | 5,000 V |

5 Removal and replacement procedures for Customer Self-Repair parts

 **NOTE:** The Customer Self-Repair program is not available in all locations. Installing a part not supported by the Customer Self-Repair program may void your warranty. Check your warranty to determine if Customer Self-Repair is supported in your location.

Component replacement procedures

 **NOTE:** Please read and follow the procedures described here to access and replace Customer Self-Repair parts successfully.

 **NOTE:** Details about your computer, including model, serial number, product key, and length of warranty, are on the service tag on the bottom of your computer. See [Labels on page 13](#) for details.

This chapter provides removal and replacement procedures for Customer Self-Repair parts.

There are as many as 16 screws that must be removed, replaced, and/or loosened when servicing Customer Self-Repair parts. Make special note of each screw size and location during removal and replacement.

Service door

| Description | Spare part number |
|--------------|-------------------|
| Service door | 840959-001 |

Before removing the service door, follow these steps:

1. Turn off the computer. If you are unsure whether the computer is off or in Hibernation, turn the computer on, and then shut it down through the operating system.
2. Disconnect the power from the computer by unplugging the power cord from the computer.
3. Disconnect all external devices from the computer.

Remove the service door:

1. Position the computer upside down.
2. Loosen the four captive Torx screws (1) that secure the door to the computer.
3. Lift the door off the computer (2).

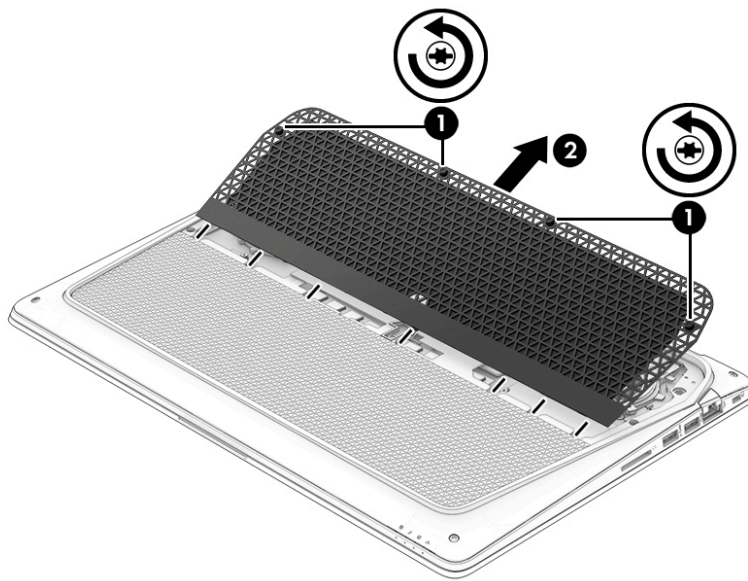

Reverse this procedure to install the service door.

Bottom cover

| Description | Spare part number |
|--------------|-------------------|
| Bottom cover | 840959-001 |

Before removing the bottom cover, follow these steps:

1. Turn off the computer. If you are unsure whether the computer is off or in Hibernation, turn the computer on, and then shut it down through the operating system.
2. Disconnect the power from the computer by unplugging the power cord from the computer.
3. Disconnect all external devices from the computer.
4. Remove the service door (see [Service door on page 28](#)).

Remove the bottom cover:

1. Loosen the seven captive Torx screws (1) that secure the bottom cover to the computer.
2. Lift the bottom cover off the computer (2).

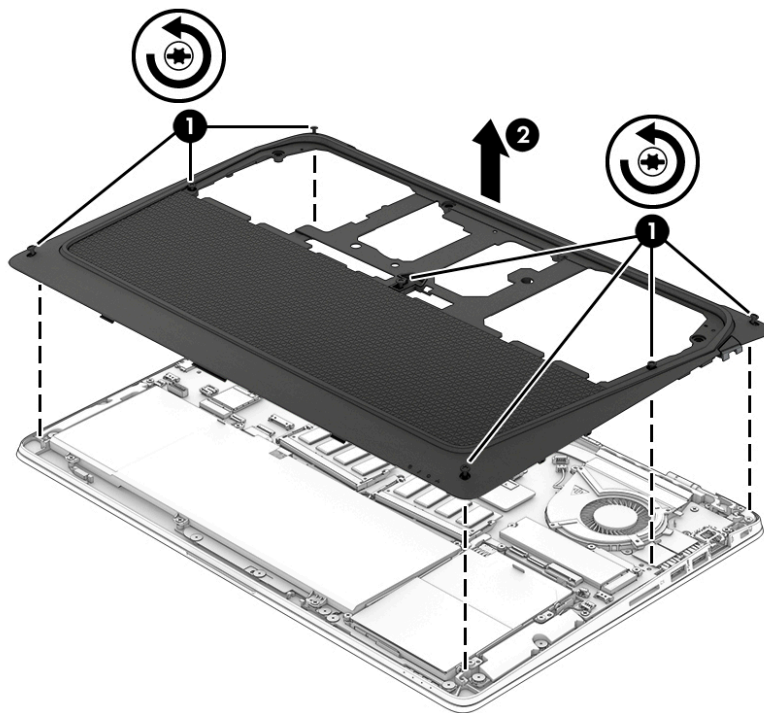

Reverse this procedure to install the bottom cover.

Battery

| Description | Spare part number |
|--|-------------------|
| 4-cell, 64-WHr, 4.21-AHr, Li-ion battery | 808450-001 |

Before removing the battery, follow these steps:

1. Turn off the computer. If you are unsure whether the computer is off or in Hibernation, turn the computer on, and then shut it down through the operating system.
2. Disconnect the power from the computer by unplugging the power cord from the computer.
3. Disconnect all external devices from the computer.
4. Remove the service door (see [Service door on page 28](#)).
5. Remove the bottom cover (see [Bottom cover on page 29](#)).

Remove the battery:

⚠ WARNING! To reduce potential safety issues, use only the user-replaceable battery provided with the computer, a replacement battery provided by HP, or a compatible battery purchased from HP.

⚠ CAUTION: Removing a user-replaceable battery that is the sole power source for the computer can cause loss of information. To prevent loss of information, save your work or shut down the computer through Windows before removing the battery.

1. Disconnect the battery cable from the system board (1).
2. Remove the six Phillips PM2.5×4.0 screws (2) that secure the battery to the computer.
3. Remove the battery from the computer (3).

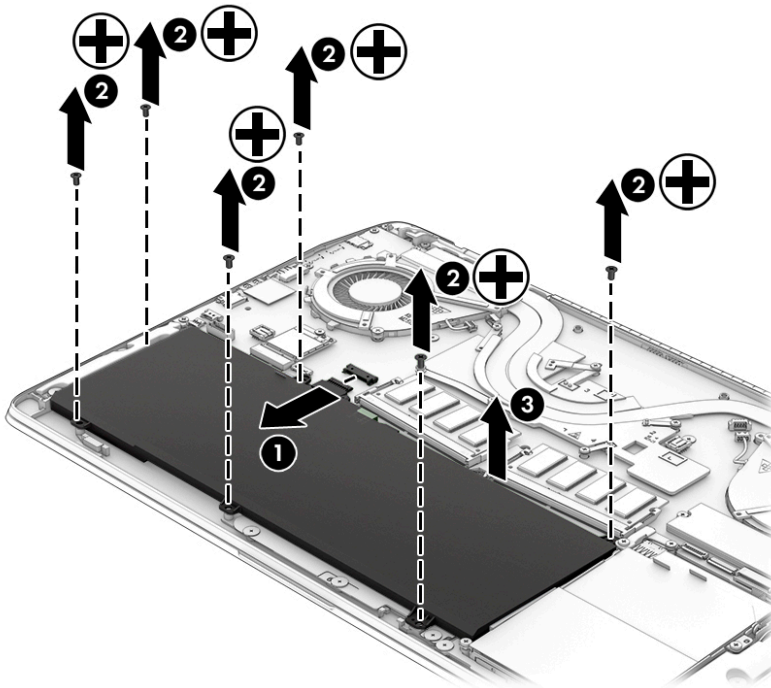

Reverse this procedure to install the battery.

Solid-state drive (M.2)

| Description | Spare part number |
|---|--------------------------|
| 1-TB, Z Turbo drive PCIe | 840951-001 |
| 512-GB, Z Turbo Drive, PCIe | 840950-001 |
| 256-GB, Z Turbo Drive, PCIe | 840949-001 |
| 256-GB, SATA-3, self-encrypting drive (SED), OPAL 2 | 840948-001 |
| 128-GB, TLC | 846386-001 |
| Solid-state drive bracket (included in Bracket Kit, spare part number 840966-001) | 840966-001 (Bracket Kit) |

Before removing the solid-state drive, follow these steps:

1. Turn off the computer. If you are unsure whether the computer is off or in Hibernation, turn the computer on, and then shut it down through the operating system.
2. Disconnect the power from the computer by unplugging the power cord from the computer.
3. Disconnect all external devices from the computer.
4. Remove the service door (see [Service door on page 28](#)).
5. Remove the bottom cover (see [Bottom cover on page 29](#)).
6. Remove the battery (see [Battery on page 30](#)).

Remove the solid-state drive:

1. Remove the Phillips PM2.0×3.5 screw **(1)** that secures the solid-state drive to the system board.



NOTE: If the module springs up when the screw is removed, be sure to remove the module at the angle dictated by the spring mechanism.

When installing the module, be sure to insert the module at the angle that it sits after the screw is removed and the module springs up.

2. Remove the solid-state drive **(2)** by pulling the drive away from the slot at an angle.

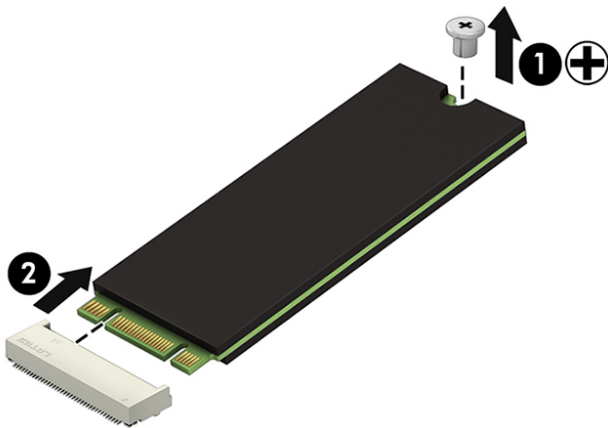

Reverse this procedure to install the solid-state drive.

Hard drive

Before removing the hard drive, follow these steps:

1. Turn off the computer. If you are unsure whether the computer is off or in Hibernation, turn the computer on, and then shut it down through the operating system.
2. Disconnect the power from the computer by unplugging the power cord from the computer.
3. Disconnect all external devices from the computer.
4. Remove the service door (see [Service door on page 28](#)).
5. Remove the bottom cover (see [Bottom cover on page 29](#)).
6. Remove the battery (see [Battery on page 30](#)).

Remove the hard drive:

1. Loosen the six captive Phillips screws **(1)** that secure the hard drive to the computer.
2. Lift the hard drive enough to access connector under the top left bracket, and then disconnect the hard drive cable from the system board **(2)**.
3. Lift the hard drive out of the computer **(3)**.

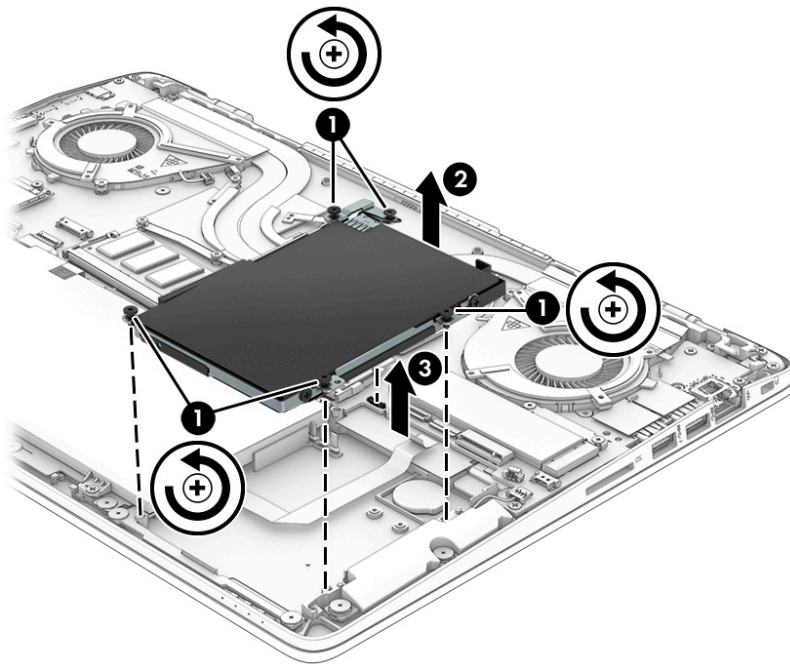

4. To remove the hard drive from the bracket, remove the four Phillips PM3.0×3.0 screws **(1)** that secure the bracket to the hard drive.

5. Slide the drive out of the bracket **(2)**, and then disconnect the connector from the hard drive **(3)**.

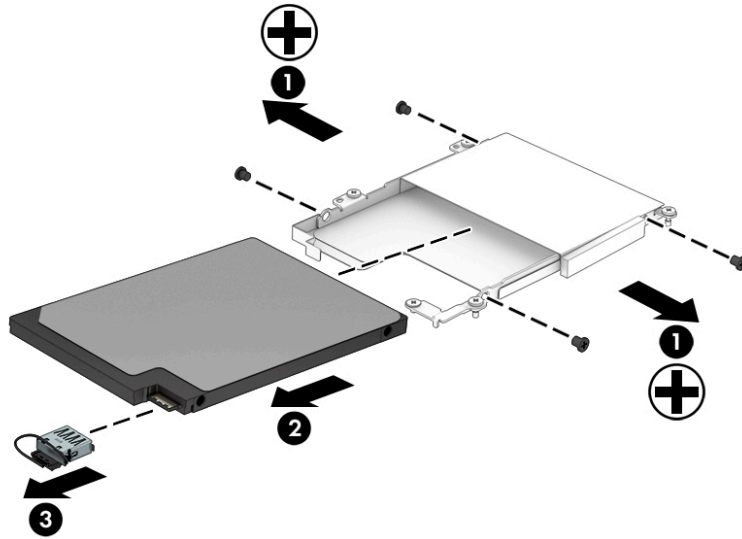

Reverse this procedure to install the solid-state drive.

WLAN module

| Description | Spare part number |
|--|-------------------|
| Intel Dual Band Wireless-AC 8260 3rd Gen Intel 802.11ac, Dual Band, 2x2 Wi-Fi + Bluetooth 4.2 | 806721-001 |
| Intel Dual Band Wireless-AC 8260 3rd Gen Intel 802.11ac, Dual Band, 2x2 Wi-Fi + Bluetooth 4.2 (non-vPro) | 806722-001 |

 **CAUTION:** To prevent an unresponsive system, replace the wireless module only with a wireless module authorized for use in the computer by the governmental agency that regulates wireless devices in your country or region. If you replace the module and then receive a warning message, remove the module to restore device functionality, and then contact technical support.

Before removing the WLAN module, follow these steps:

1. Turn off the computer. If you are unsure whether the computer is off or in Hibernation, turn the computer on, and then shut it down through the operating system.
2. Disconnect the power from the computer by unplugging the power cord from the computer.
3. Disconnect all external devices from the computer.
4. Remove the service door (see [Service door on page 28](#)).
5. Remove the bottom cover (see [Bottom cover on page 29](#)).
6. Disconnect the battery (see [Battery on page 30](#)).

Remove the WLAN module:

1. Disconnect the WLAN antenna cables **(1)** from the terminals on the WLAN module.



NOTE: The WLAN antenna cable labeled “1” connects to the WLAN module “Main” terminal labeled “1”. The WLAN antenna cable labeled “2” connects to the WLAN module “Aux” terminal labeled “2”.

2. Remove the Phillips PM2.0×3.0 screw **(2)** that secures the WLAN module to the system board. (The WLAN module tilts up.)

3. Remove the WLAN module (3) by pulling the module away from the slot at an angle.

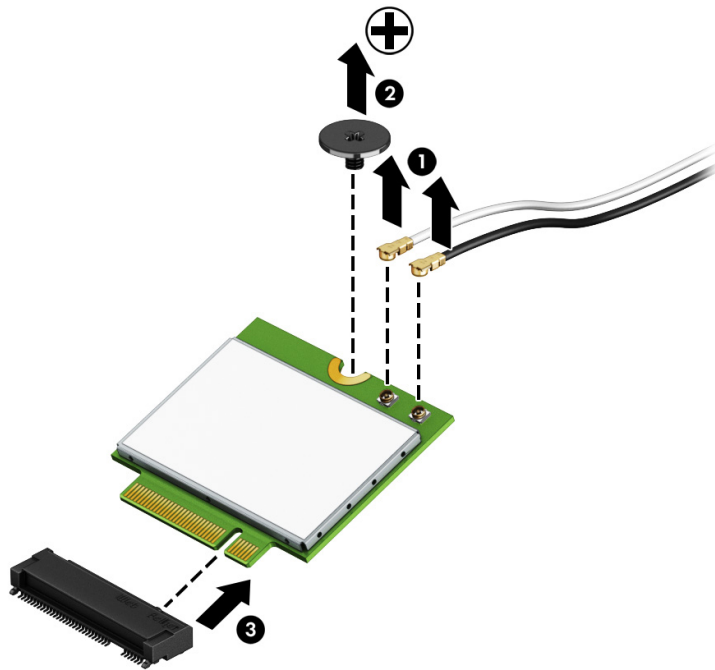

 **NOTE:** If the WLAN antenna cables are not connected to the terminals on the WLAN module, protective sleeves should be installed on the antenna connectors, as shown in the following illustration.

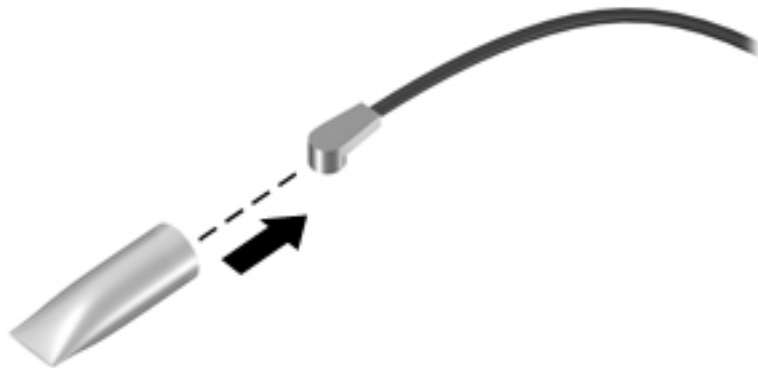

Reverse this procedure to install the WLAN module.

Memory module

| Description | Spare part number |
|--------------------------------------|-------------------|
| For use with Core processors: | |
| 16 GB | 820571-001 |
| 8 GB | 820570-001 |
| 4 GB | 820569-001 |
| For use with Xeon processors: | |
| 16 GB, ECC | 835886-001 |
| 8 GB, ECC | 835887-001 |

Update BIOS before adding memory modules

Before adding new memory, make sure you update the computer to the latest BIOS.

 **CAUTION:** Failure to update the computer to the latest BIOS prior to installing new memory may result in various system problems.

To update BIOS:

1. Navigate to www.hp.com.
2. Click **Support & Drivers > Drivers & Software**.
3. In the **Enter a product name/number box**, type the computer model information, and then click **Search**.
4. Click the link for the computer model.
5. Select the operating system, and then click **Next**.
6. Under **Step 2: Select a Download**, click the **BIOS** link.
7. Click the link for the most recent BIOS.
8. Click the **Download** button, and then follow the on-screen instructions.

Before removing a memory module, follow these steps:

1. Turn off the computer. If you are unsure whether the computer is off or in Hibernation, turn the computer on, and then shut it down through the operating system.
2. Disconnect the power from the computer by unplugging the power cord from the computer.
3. Disconnect all external devices from the computer.
4. Remove the service door (see [Service door on page 28](#)).
5. Remove the bottom cover (see [Bottom cover on page 29](#)).
6. Disconnect the battery (see [Battery on page 30](#)).

Remove the memory module:

1. Spread the retaining tabs **(1)** on each side of the memory module slot to release the memory module. (The memory module tilts up.)

2. Remove the memory module (2) by pulling the module away from the slot at an angle.

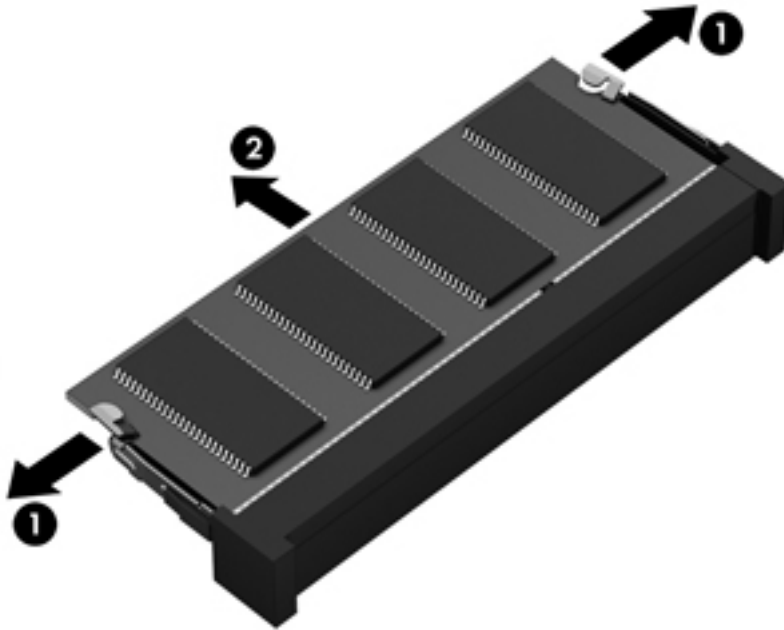

Reverse this procedure to install a memory module.

RTC battery

| Description | Spare part number |
|--|-------------------|
| RTC battery (includes cable and double-sided adhesive) | 840953-001 |

Before removing the RTC battery, follow these steps:

1. Turn off the computer. If you are unsure whether the computer is off or in Hibernation, turn the computer on, and then shut it down through the operating system.
2. Disconnect the power from the computer by unplugging the power cord from the computer.
3. Disconnect all external devices from the computer.
4. Remove the service door (see [Service door on page 28](#)).
5. Remove the bottom cover (see [Bottom cover on page 29](#)).
6. Disconnect the battery (see [Battery on page 30](#)).
7. If installed, remove the hard drive (see [Hard drive on page 32](#)).

Remove the RTC battery:

1. Disconnect the RTC battery cable **(1)** from the system board.
2. Detach the RTC battery **(2)** from the base enclosure. (The RTC battery is attached to the base enclosure with double-sided adhesive.)

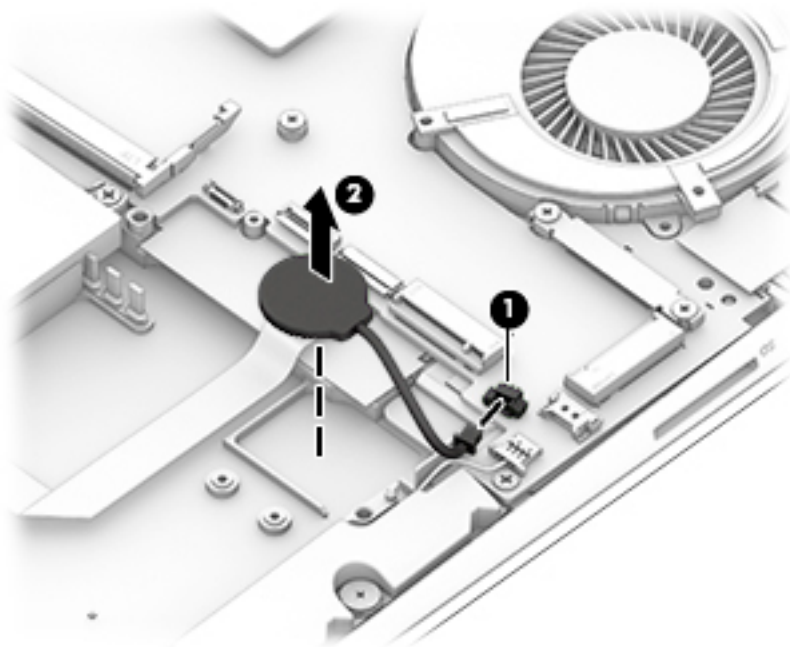

3. Remove the RTC battery and cable.

Reverse this procedure to install the RTC battery.

6 Removal and replacement procedures for authorized service provider parts

 **CAUTION:** Components described in this chapter should be accessed only by an authorized service provider. Users who access these parts can damage the computer or void the warranty.

Component replacement procedures

There are as many as 74 screws that must be removed, replaced, and/or loosened when servicing the parts described in this chapter. Make special note of each screw size and location during removal and replacement.

Thermal module

 **NOTE:** The thermal module spare part kit includes replacement thermal material.

| Description | Spare part number |
|---|-------------------|
| Thermal module for use only with models with discrete graphics memory | 840960-001 |
| Thermal module for use only with models with UMA graphics memory | 840961-001 |

Before removing the thermal module, follow these steps:

1. Turn off the computer. If you are unsure whether the computer is off or in Hibernation, turn the computer on, and then shut it down through the operating system.
2. Disconnect the power from the computer by unplugging the power cord from the computer.
3. Disconnect all external devices from the computer.
4. Remove the service door (see [Service door on page 28](#)).
5. Remove the bottom cover (see [Bottom cover on page 29](#)).
6. Disconnect the battery (see [Battery on page 30](#)).

Remove the thermal module:

1. Disconnect the cable for each fan from the system board **(1)**.
2. Loosen the six captive screws (discrete models) or three captive screws (UMA models) in the middle of the heat sink (between the fans) in the order indicated on the heat sink **(2)** and the two captive screws from each fan **(3)**.
3. Remove the antennas from the routing path atop the left fan **(4)** and the display connector from the routing path atop the right fan **(4)**.

4. Remove the fan/heat sink assembly (5).

CAUTION: When lifting the heat sink out of the computer, be careful not to bend the arm that connects the fans.

Discrete models:

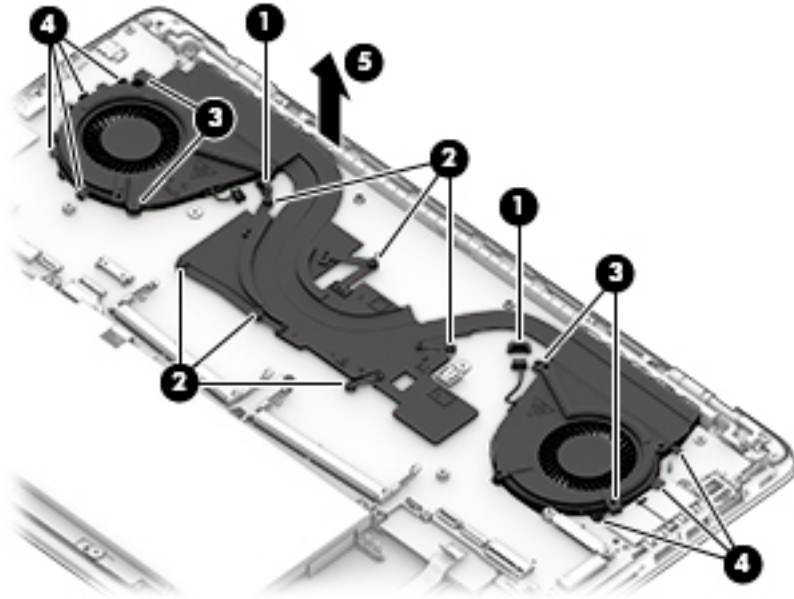

UMA models:

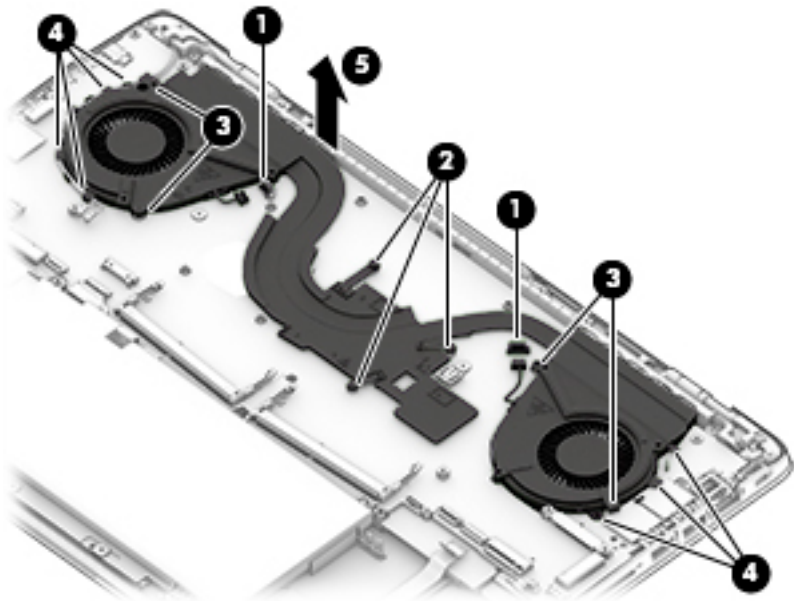

NOTE: The thermal material must be thoroughly cleaned from the surfaces of the fan/heat sink assembly and the system board components each time the fan/heat sink assembly is removed. Replacement thermal material is included with the thermal module, processor, and system board spare part kits.

Discrete graphics models:

- Various thermal pads are used on the system board components and the heat sink sections and that service them. See the following image for thermal pad locations.

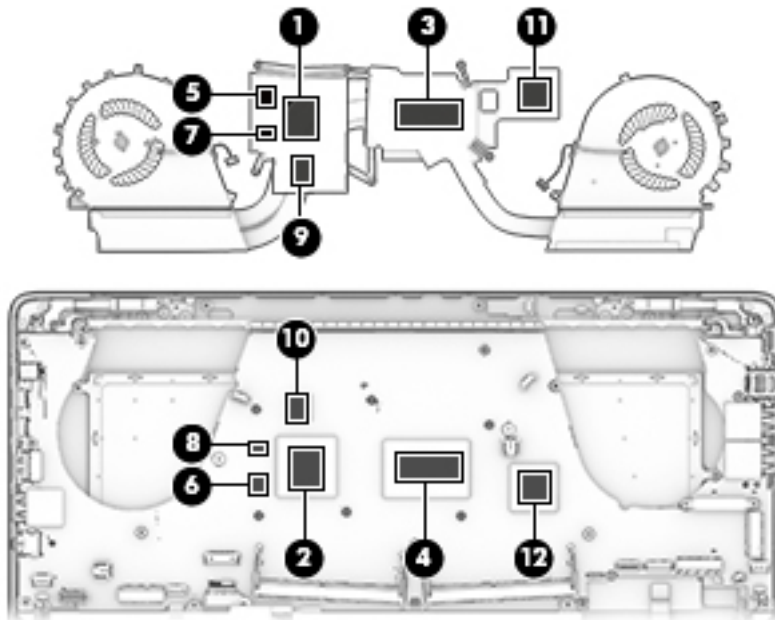

UMA graphics models:

- Various thermal pads are used on the system board components and the heat sink sections and that service them. See the following image for thermal pad locations.

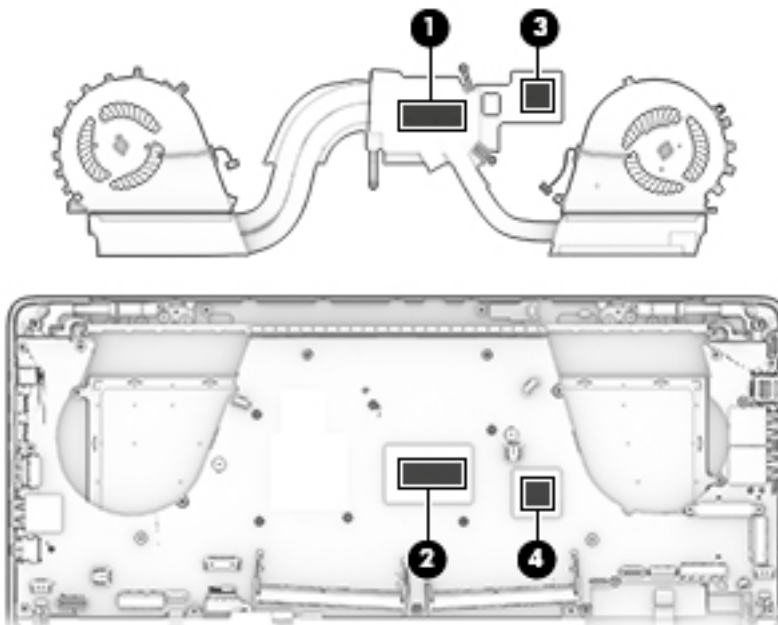

Reverse this procedure to install the thermal module.

Fingerprint reader board

| Description | Spare part number |
|---|-------------------|
| Fingerprint reader board (includes bracket) | 840952-001 |

Before removing the fingerprint reader board, follow these steps:

1. Turn off the computer. If you are unsure whether the computer is off or in Hibernation, turn the computer on, and then shut it down through the operating system.
2. Disconnect the power from the computer by unplugging the power cord from the computer.
3. Disconnect all external devices from the computer.
4. Remove the service door (see [Service door on page 28](#)).
5. Remove the bottom cover (see [Bottom cover on page 29](#)).
6. Remove the battery (see [Battery on page 30](#)).

Remove the fingerprint reader board:

1. Disconnect the cable from the system board **(1)**.
2. Lift the tape from atop the fingerprint reader **(2)**.
3. Remove the Phillips PM2.0×3.0 screw that secures the bracket to the computer **(3)**.
4. Slide the bracket downward to disengage it, and then lift the bracket off the fingerprint reader **(4)**.
5. Remove the fingerprint reader from the computer **(5)**.

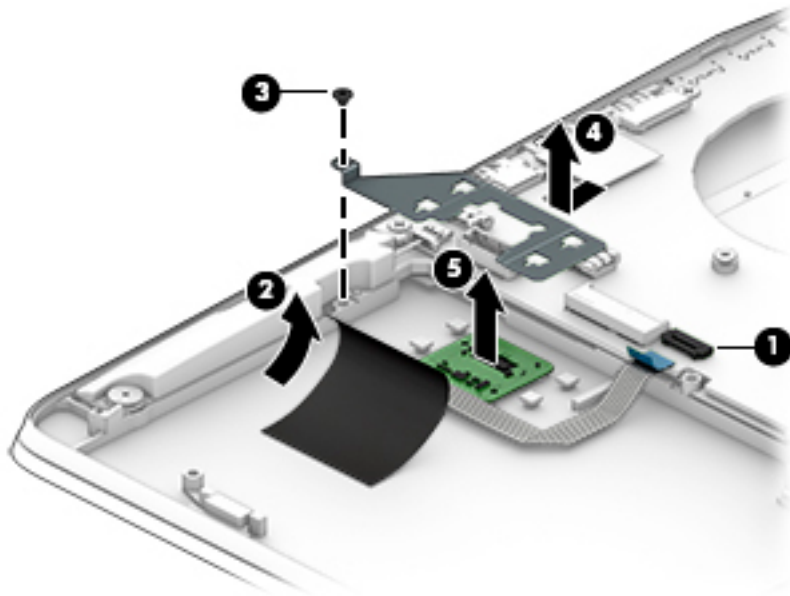

Reverse this procedure to install the fingerprint reader board.

LED board

| Description | Spare part number |
|-------------|-------------------|
| LED board | 840957-001 |

Before removing the LED board, follow these steps:

1. Turn off the computer. If you are unsure whether the computer is off or in Hibernation, turn the computer on, and then shut it down through the operating system.
2. Disconnect the power from the computer by unplugging the power cord from the computer.
3. Disconnect all external devices from the computer.
4. Remove the service door (see [Service door on page 28](#)).
5. Remove the bottom cover (see [Bottom cover on page 29](#)).
6. Remove the battery (see [Battery on page 30](#)).

Remove the LED board:

1. Remove the tape from atop the cable **(1)**.
2. Disconnect the cable from the system board **(2)**.
3. Remove the two Phillips PM2.0×2.0 broadhead screws **(3)** that secure the LED board to the computer.
4. Remove the LED board **(4)**.

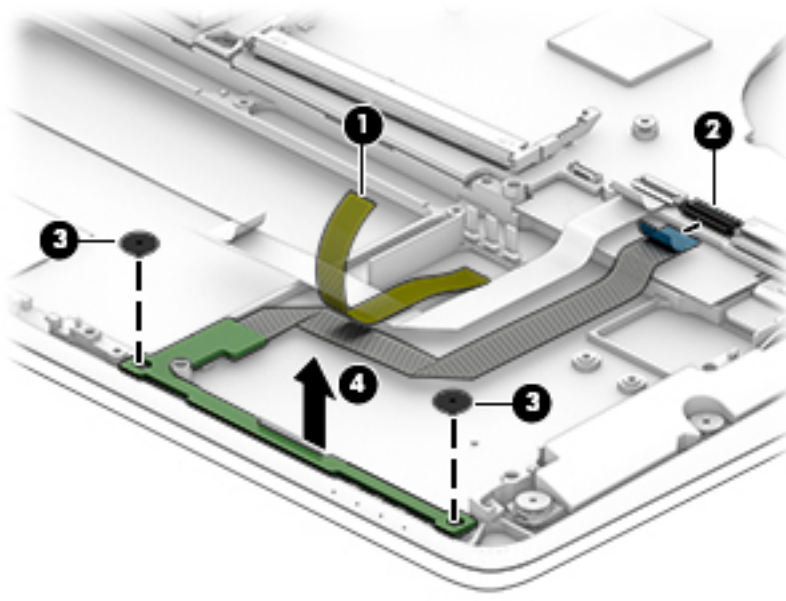

Reverse this procedure to install the LED board.

TouchPad

| Description | Spare part number |
|-------------|-------------------|
| TouchPad | 840962-001 |

Before removing the TouchPad, follow these steps:

1. Turn off the computer. If you are unsure whether the computer is off or in Hibernation, turn the computer on, and then shut it down through the operating system.
2. Disconnect the power from the computer by unplugging the power cord from the computer.
3. Disconnect all external devices from the computer.
4. Remove the service door (see [Service door on page 28](#)).
5. Remove the bottom cover (see [Bottom cover on page 29](#)).
6. Remove the battery (see [Battery on page 30](#)).

Remove the TouchPad:

1. Disconnect the cable from the system board **(1)**.
2. Remove the six Phillips PM2.0×2.0 screws **(2)** that secure the TouchPad to the top cover.
3. Lift the TouchPad out of the computer **(3)**.

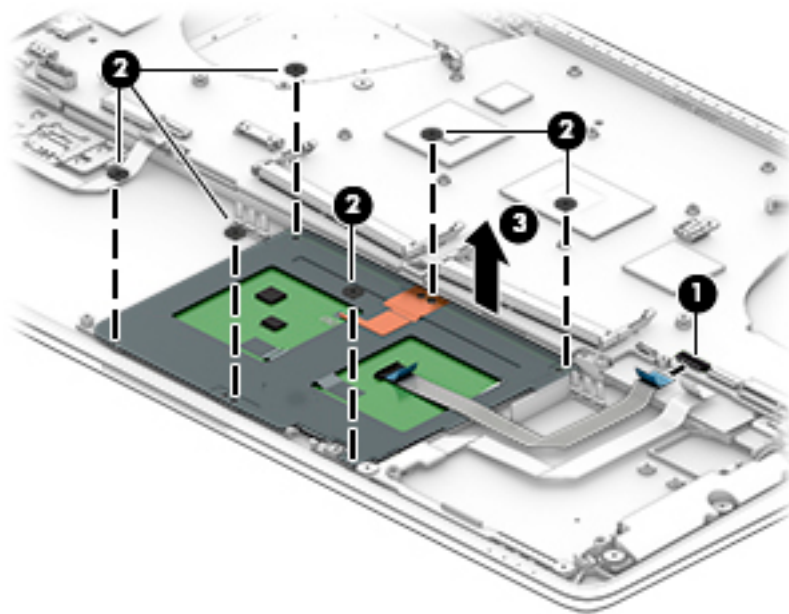

Reverse this procedure to install the TouchPad.

Display cable

| Description | Spare part number |
|---|--------------------------|
| Display cable | 840938-001 |
| eDP bracket (included in Bracket Kit, spare part number 840966-001) | 840966-001 (Bracket Kit) |

Before removing the display cable, follow these steps:

1. Turn off the computer. If you are unsure whether the computer is off or in Hibernation, turn the computer on, and then shut it down through the operating system.
2. Disconnect the power from the computer by unplugging the power cord from the computer.
3. Disconnect all external devices from the computer.
4. Remove the service door (see [Service door on page 28](#)).
5. Remove the bottom cover (see [Bottom cover on page 29](#)).
6. Disconnect the battery (see [Battery on page 30](#)).

Remove the display cable:

1. Remove the two Phillips PM2.0×3.0 screws **(1)** that secure the display cable to the computer.
2. Lift the eDP bracket from atop the connector **(2)**.
3. Disconnect the cable from the system board **(3)**.
4. Remove the cable from the clips along its routing path **(4)**.

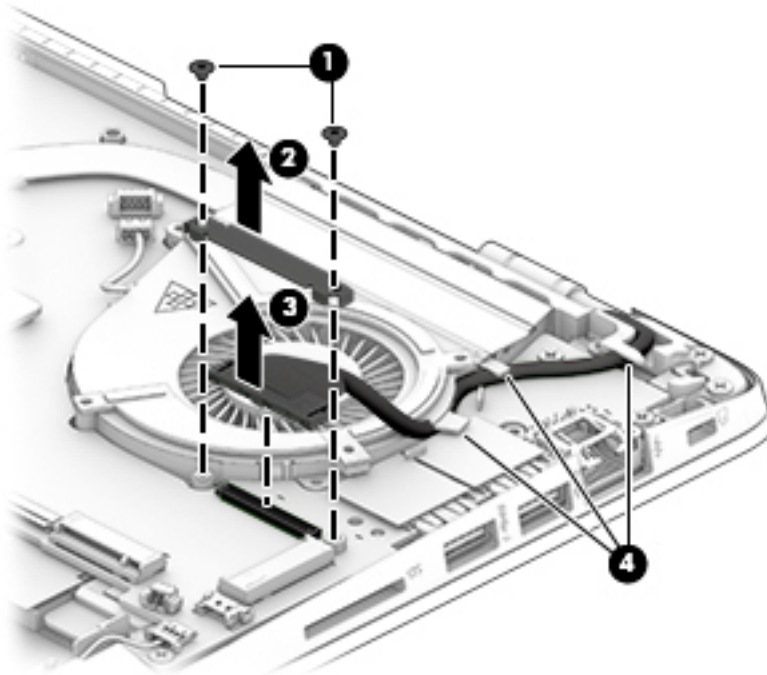

Reverse this procedure to install the display cable.

System board



NOTE: The system board spare part kit includes battery connector bracket and replacement thermal material.

All system boards use the following part numbers:

xxxxxx-001: Windows 7 or non-Windows operating systems

xxxxxx-601: Windows 10 operating system

| Description | Spare part number |
|---|-------------------|
| Intel Xeon E3-1505M processor | 840933-xxx |
| Intel Core i7-6820HQ processor and discrete graphics memory | 840932-xxx |
| Intel Core i7-6820HQ processor and UMA graphics memory | 840930-xxx |
| Intel Core i7-6700HQ processor and discrete graphics memory | 840931-xxx |
| Intel Core i7-6700HQ processor and UMA graphics memory | 840929-xxx |

Before removing the system board, follow these steps:

1. Turn off the computer. If you are unsure whether the computer is off or in Hibernation, turn the computer on, and then shut it down through the operating system.
2. Disconnect the power from the computer by unplugging the power cord from the computer.
3. Disconnect all external devices from the computer.
4. Remove the service door (see [Service door on page 28](#)).
5. Remove the bottom cover (see [Bottom cover on page 29](#)).
6. Remove the battery (see [Battery on page 30](#)).
7. Remove the thermal module (see [Thermal module on page 39](#)).
8. Remove the display cable (see [Display cable on page 45](#)).



NOTE: When replacing the system board, be sure that the following components are removed from the defective system board and installed on the replacement system board:

- Solid-state drive (see [Solid-state drive \(M.2\) on page 31](#))
- WLAN module (see [WLAN module on page 34](#))
- Memory module (see [Memory module on page 36](#))

Remove the system board:

1. Disconnect the following cables from the system board:
 - (1) Right speaker cable
 - (2) Fingerprint reader cable
 - (3) TouchPad cable
 - (4) LED board cable
 - (5) RTC battery cable

(6) Left speaker cable

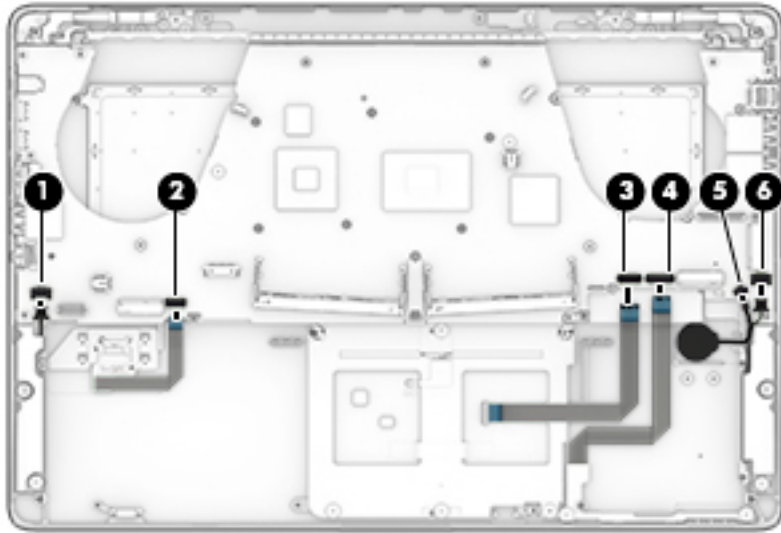

2. Remove the seven Phillips PM2.5×4.0 screws **(1)**.
3. Remove the two Phillips PM2.5×4.0 shoulder screws **(2)**.

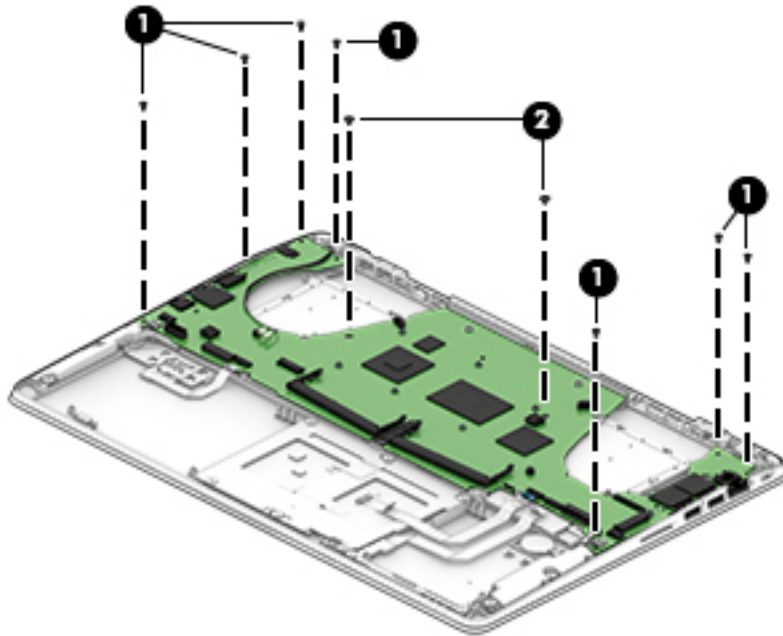

4. Lift in the middle of the board until the connectors disengage from the left side of the computer **(1)**.
5. Disconnect the keyboard cable from the bottom of the system board **(2)**.

6. Remove the system board from the computer (3).

CAUTION: When you lift the system board from the computer, be careful not to damage or break the narrow sections of the board.

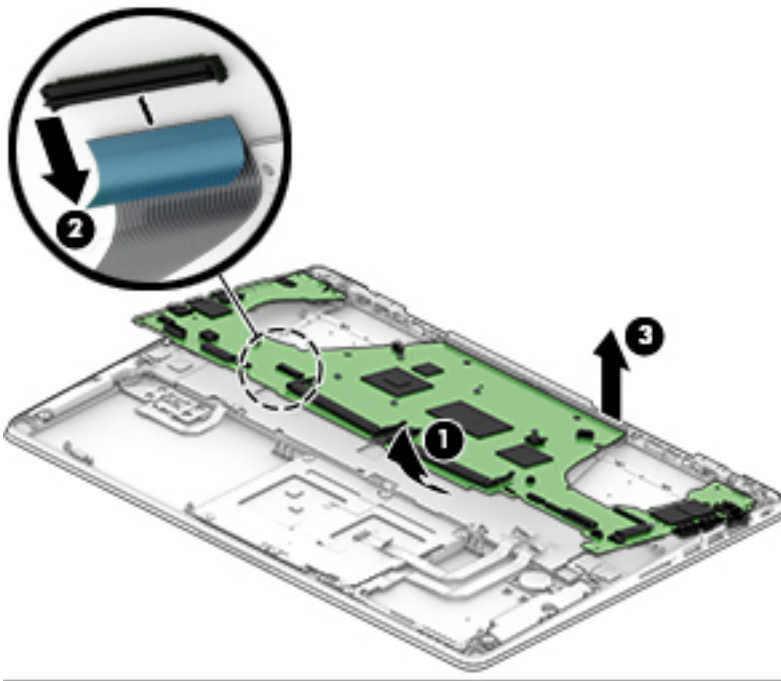

Reverse this procedure to install the system board.

I/O support bracket

| Description | Spare part number |
|---|--------------------------|
| I/O support bracket (included in Bracket Kit, spare part number 840966-001) | 840966-001 (Bracket Kit) |

Before removing the I/O support bracket, follow these steps:

1. Turn off the computer. If you are unsure whether the computer is off or in Hibernation, turn the computer on, and then shut it down through the operating system.
2. Disconnect the power from the computer by unplugging the power cord from the computer.
3. Disconnect all external devices from the computer.
4. Remove the service door (see [Service door on page 28](#)).
5. Remove the bottom cover (see [Bottom cover on page 29](#)).
6. Remove the battery (see [Battery on page 30](#)).
7. Remove the thermal module (see [Thermal module on page 39](#)).
8. Remove the display cable (see [Display cable on page 45](#)).
9. Remove the solid-state drive (see [Solid-state drive \(M.2\) on page 31](#)).
10. Remove the WLAN module (see [WLAN module on page 34](#)).
11. Remove the system board (see [System board on page 46](#)).

Remove the I/O support bracket:

- ▲ Lift the I/O support bracket straight up and off the system board.

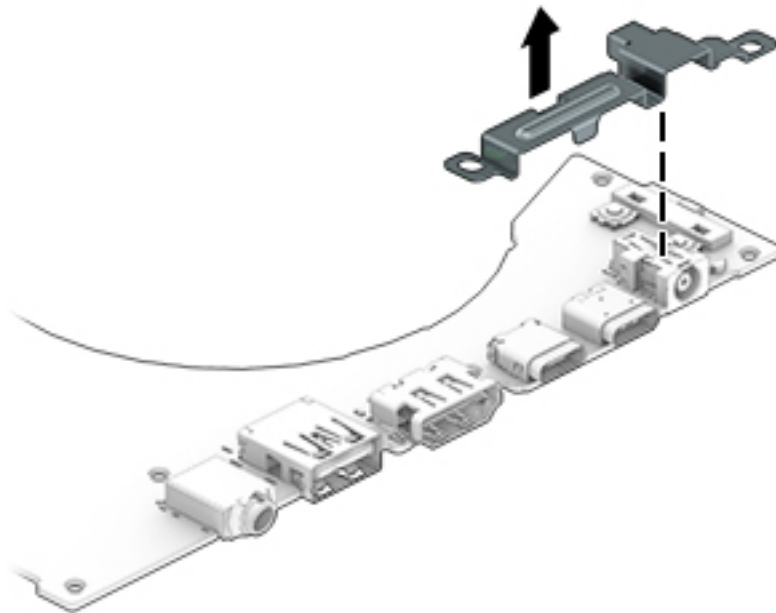

Reverse this procedure to install the I/O support bracket.

Speakers

| Description | Spare part number |
|---------------------------|-------------------|
| Speakers (includes cable) | 840958-001 |

Before removing the speakers, follow these steps:

1. Turn off the computer. If you are unsure whether the computer is off or in Hibernation, turn the computer on, and then shut it down through the operating system.
2. Disconnect the power from the computer by unplugging the power cord from the computer.
3. Disconnect all external devices from the computer.
4. Remove the service door (see [Service door on page 28](#)).
5. Remove the bottom cover (see [Bottom cover on page 29](#)).
6. Remove the battery (see [Battery on page 30](#)).
7. Remove the thermal module (see [Thermal module on page 39](#)).
8. Remove the display cable (see [Display cable on page 45](#)).
9. Remove the solid-state drive (see [Solid-state drive \(M.2\) on page 31](#)).
10. Remove the WLAN module (see [WLAN module on page 34](#)).
11. Remove the system board (see [System board on page 46](#)).

Remove the speakers:

1. Remove the four Phillips PM2.0×3.0 broadhead screws (1) that secure the speakers to the computer.
2. Remove the speakers (2).

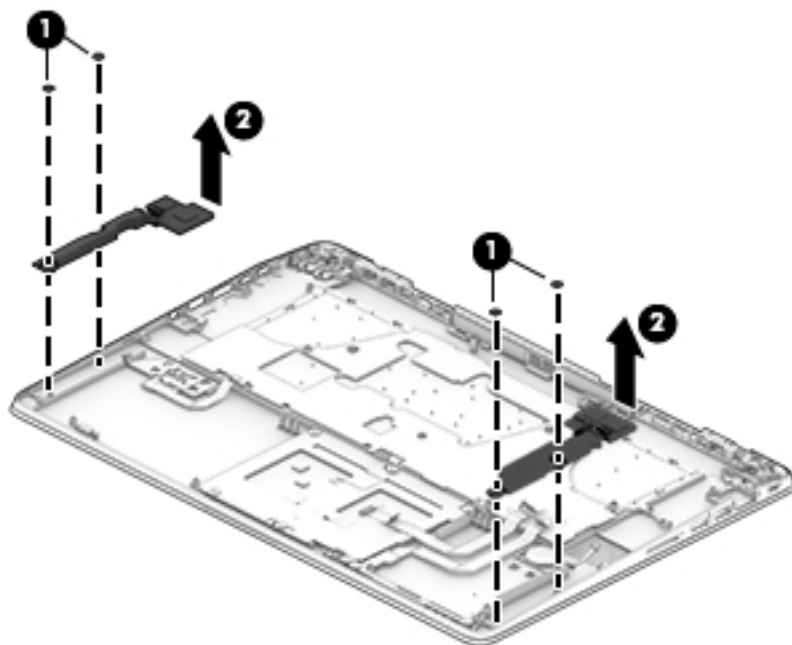

Reverse this procedure to install the speakers.



NOTE: When installing the speakers, make sure the rubber grommets around the screws are correctly installed.

Keyboard

| For use in country or region | Spare part number | For use in country or region | Spare part number |
|--|-------------------|-------------------------------|-------------------|
| Keyboard with backlight: | | | |
| For use in Belgium | 841681-A41 | For use in Northwest Africa | 841681-FP1 |
| For use in Brazil | 841681-201 | For use in Norway | 841681-091 |
| For use in Bulgaria | 841681-261 | For use in Portugal | 841681-131 |
| For use in Canada | 841681-DB1 | For use in Romania | 841681-271 |
| For use in the Czech Republic and Slovakia | 841681-FL1 | For use in Russia | 841681-251 |
| For use in Denmark | 841681-081 | For use in Saudi Arabia | 841681-171 |
| For use in France | 841681-051 | For use in Slovenia | 841681-BA1 |
| For use in Germany | 841681-041 | For use in South Korea | 841681-AD1 |
| For use in Greece | 841681-151 | For use in Spain | 841681-071 |
| For use in Hungary | 841681-211 | For use in Sweden and Finland | 841681-B71 |

Before removing the keyboard, follow these steps:

1. Turn off the computer. If you are unsure whether the computer is off or in Hibernation, turn the computer on, and then shut it down through the operating system.
2. Disconnect the power from the computer by unplugging the power cord from the computer.
3. Disconnect all external devices from the computer.
4. Remove the service door (see [Service door on page 28](#)).
5. Remove the bottom cover (see [Bottom cover on page 29](#)).
6. Remove the battery (see [Battery on page 30](#)).
7. Remove the thermal module (see [Thermal module on page 39](#)).
8. Remove the display cable (see [Display cable on page 45](#)).
9. Remove the solid-state drive (see [Solid-state drive \(M.2\) on page 31](#)).
10. Remove the WLAN module (see [WLAN module on page 34](#)).
11. Remove the system board (see [System board on page 46](#)).

Remove the keyboard:

1. Partially open the computer.
2. Rest and secure the computer on its left side.
3. Insert a thin tool into the keyboard release hole, and then press on the back of the keyboard until the keyboard disengages from the computer **(1)**.

4. Remove the keyboard (2).

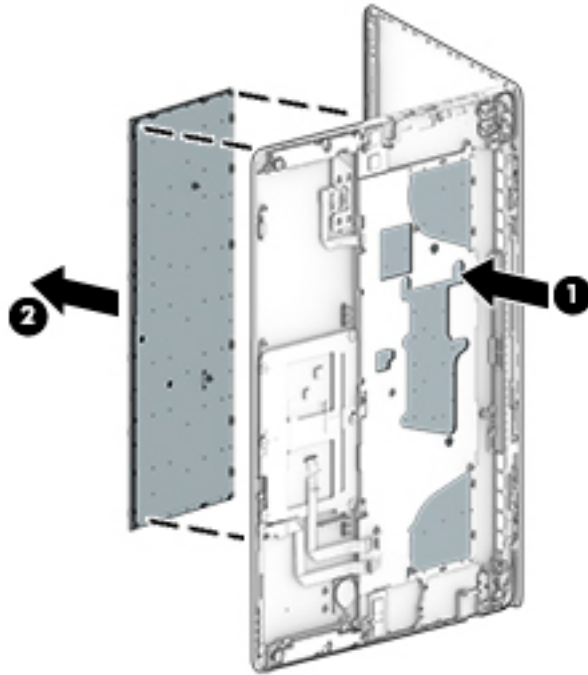

Reverse this procedure to install the keyboard.

Display assembly



NOTE: The DreamVision display assembly is spared as a whole unit assembly only. The LED display assembly is spared at the subcomponent level only. For more LED display assembly spare part information, see the individual removal subsections.

| Description | Spare part number |
|---|-------------------|
| 15.6-in, UHD, UWVA, DreamVision display assembly not equipped with a webcam | 840945-001 |
| 15.6-in, UHD, UWVA, DreamVision display assembly equipped with a webcam | 840946-001 |
| 15.6-in, FHD, UWVA display assembly with a touch screen | 840947-001 |

To remove the display assembly and access the LED display assembly subcomponents, follow these steps:

1. Turn off the computer. If you are unsure whether the computer is off or in Hibernation, turn the computer on, and then shut it down through the operating system.
2. Disconnect the power from the computer by unplugging the power cord from the computer.
3. Disconnect all external devices from the computer.
4. Remove the service door (see [Service door on page 28](#)).
5. Remove the bottom cover (see [Bottom cover on page 29](#)).
6. Remove the battery (see [Battery on page 30](#)).
7. Remove the thermal module (see [Thermal module on page 39](#)).
8. Remove the display cable (see [Display cable on page 45](#)).
9. Remove the solid-state drive (see [Solid-state drive \(M.2\) on page 31](#)).
10. Remove the WLAN module (see [WLAN module on page 34](#)).
11. Remove the system board (see [System board on page 46](#)).

Remove the display assembly:

1. Remove the three Phillips PM2.5×4.0 screws **(1)** that secure each hinge to the computer.
2. Open the computer as far as possible.

3. Separate the display from the computer **(2)**.

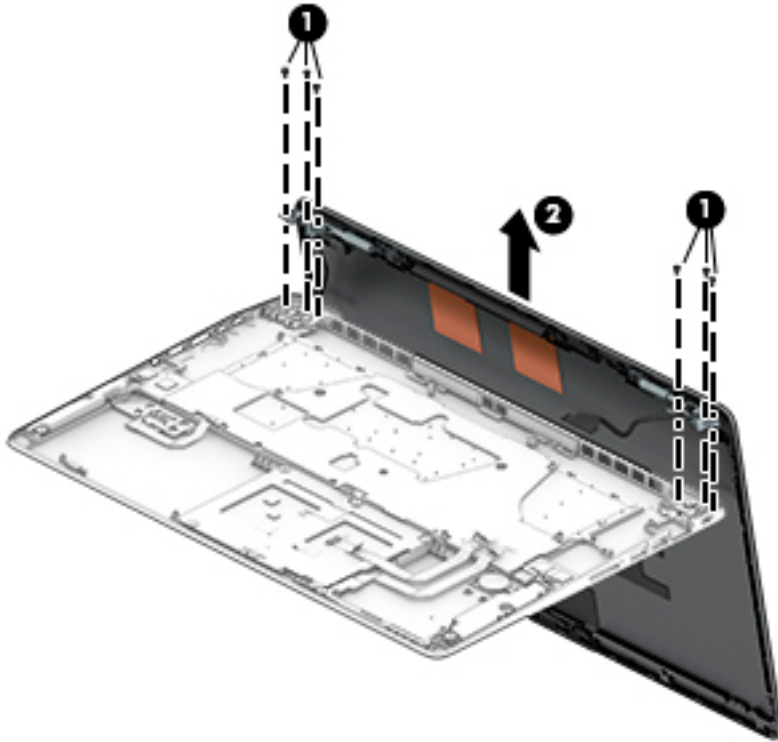

4. If it is necessary to replace the display bezel or any of the LED display assembly subcomponents:
 - a. Use a plastic tool to disengage the bezel starting at the top **(1)**, left and right sides **(2)**, and bottom **(3)**.

- b.** Remove the display bezel **(4)**.

The display bezel is available using the following spare part numbers:

840935-001: Models with a webcam

840936-001: Models without a webcam

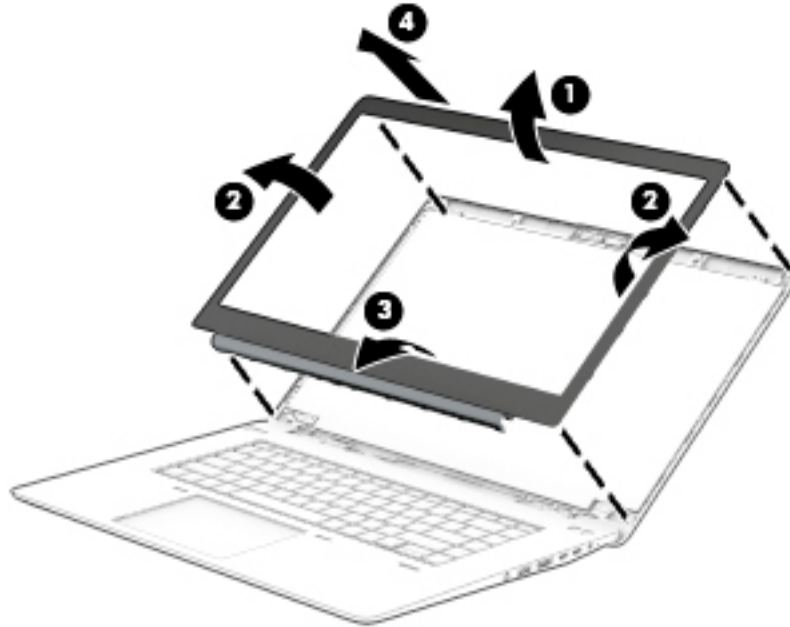

- 5.** If it is necessary to replace the display panel:

- a.** Remove the four Phillips PM2.0×2.0 screws that secure the display panel to the display enclosure.

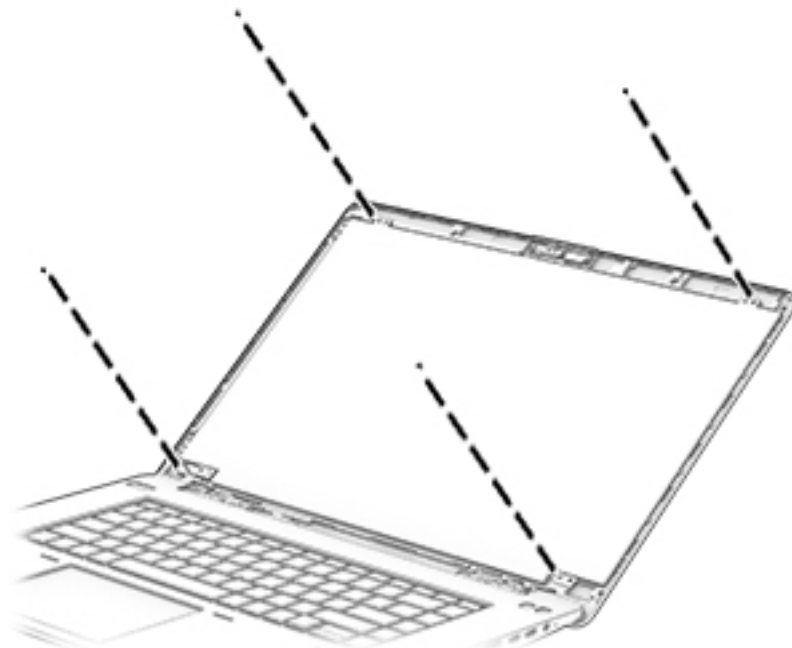

⚠ CAUTION: Before turning the display panel upside down, make sure the work surface is clear of tools, screws, and any other foreign objects. Failure to follow this caution can result in damage to the display panel.

- b. Lift the top edge of the display panel **(1)** and swing it up and forward until it rests upside down in front of the display enclosure.
- c. Remove the display cable from the clip **(2)**.
- d. Lift the tape **(3)**, and then disconnect the display panel cable **(4)** from the display panel.

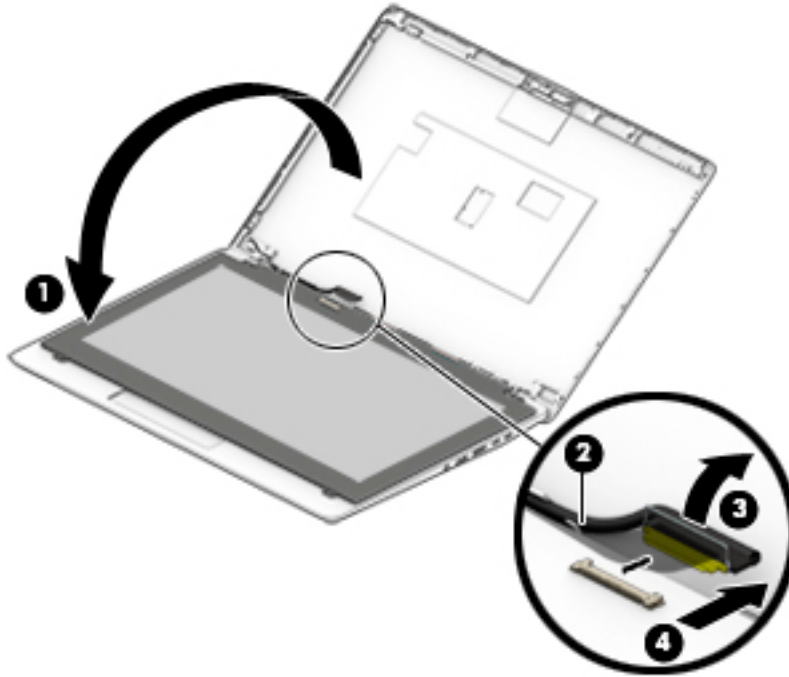

- e. Remove the display panel.

The display panel is available using spare part numbers 840941-001 (15.6-in, FHD, UWVA, LED display panel) and 840943-001 (15.6-in, UHD, UWVA, LED B display panel).

6. If it is necessary to replace the webcam module or microphone module:

📝 NOTE: The webcam module and microphone module are similar in appearance and installed in the same location. The removal procedures are the same for both modules.

⚠ CAUTION: Handle the module with caution. This module has a thin profile and is susceptible to damage when not handled carefully.

- a. Detach the webcam or microphone module **(1)** from the display enclosure. (The module is attached to the display enclosure with double-sided adhesive.)

- b. Disconnect the module cable (2) from the module.

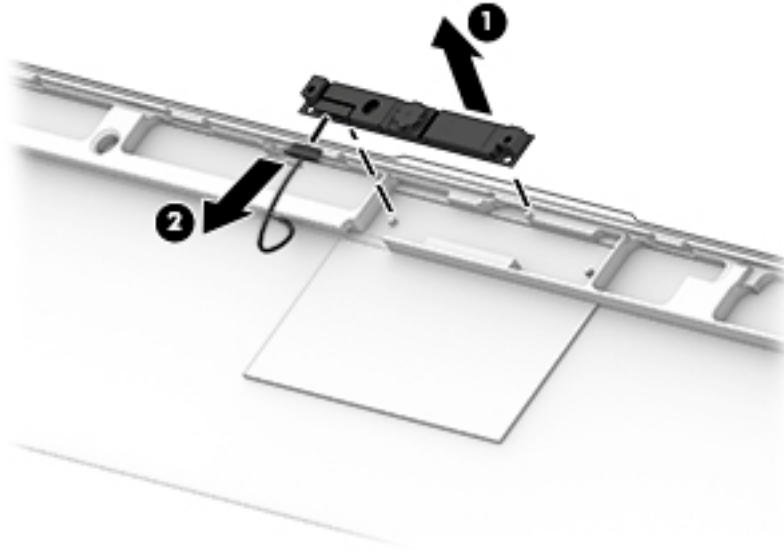

- c. Remove the module.
The webcam module is available using spare part number 840965-001.
The microphone module is available using spare part number 840955-001.

7. If it is necessary to replace the thermal board:

- a. Disconnect the thermal board cable (1) from the board.
- b. Using a flat tool, pry the board loose (2), and then remove the board (3) from the display enclosure. (The thermal board is attached to the display enclosure with double-sided adhesive.)

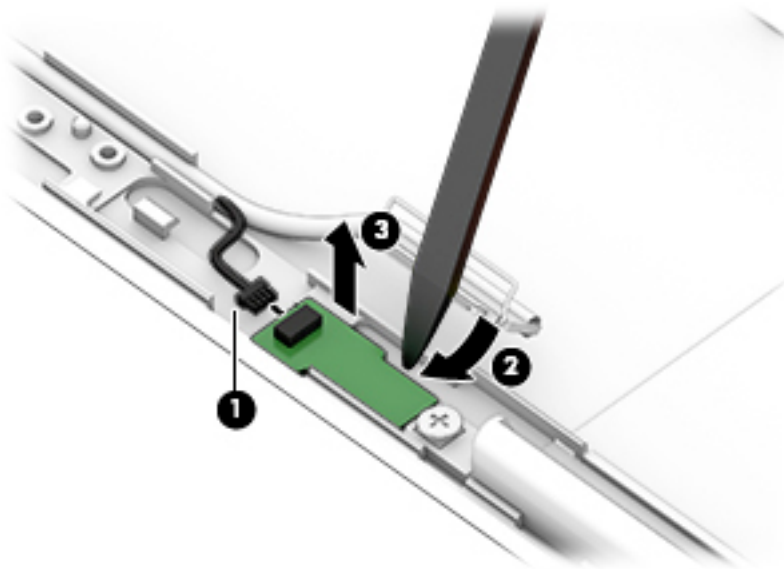

- c. Remove the thermal board.
The thermal board is available using spare part number 840956-001.

8. If it is necessary to replace the display hinges:

- a. Remove the three Torx T8M2.5×4.0 screws (1) that secure each display hinge to the display panel.

- b. Remove the display hinges (2).

The display hinges are available using spare part number 840937-001 and include the left and right hinges.

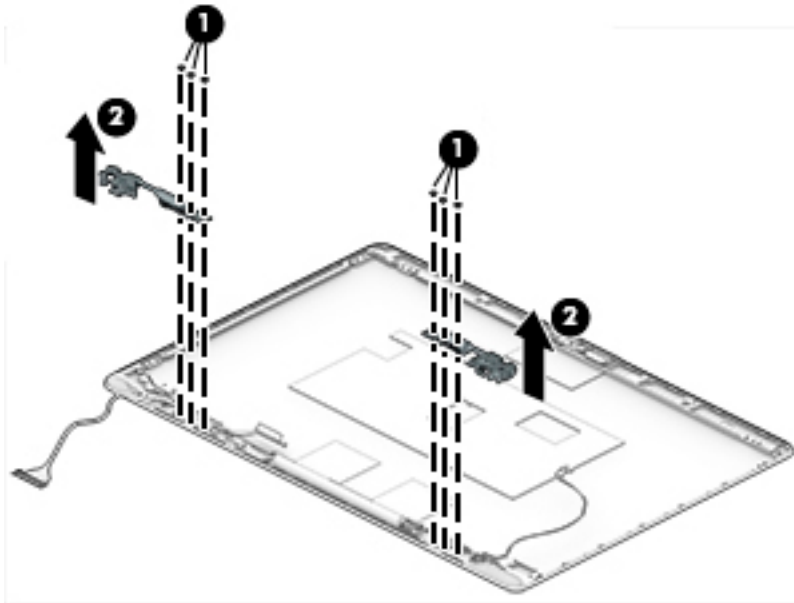

9. (UHD models only) If it is necessary to replace the display brackets:

- ▲ Lift the bottom bracket (1) and top bracket (2) out of the display enclosure.

Display panel brackets are available in the Bracket Kit using spare part number 840966-001.

 **NOTE:** The display brackets can only be removed from UHD panels.

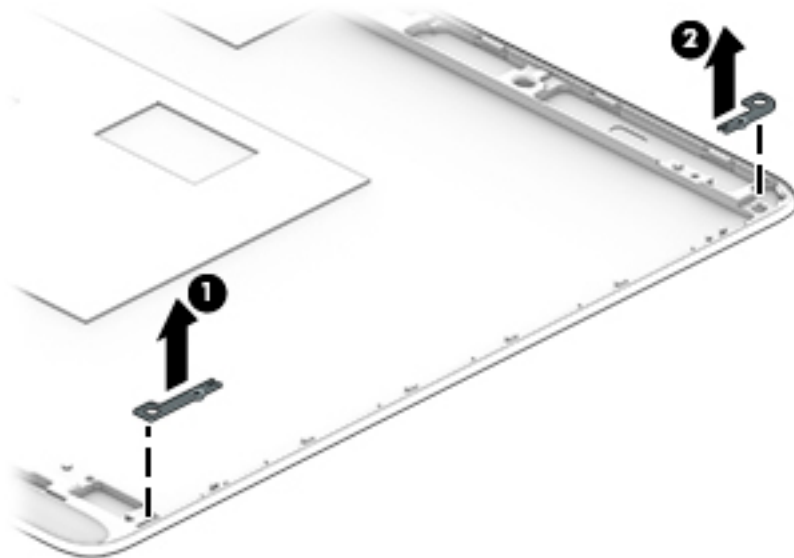

10. If it is necessary to replace the wireless antennas:

- a. Remove the cables from the routing path on the bottom-right corner of the display (1).
- b. Remove the two Phillips PM2.0×2.0 screws (2) that secure the plastic holder to the bottom of the display.

- c. Peel the antennas off the display **(3)**.

The antennas are available using spare part number 840940-001.

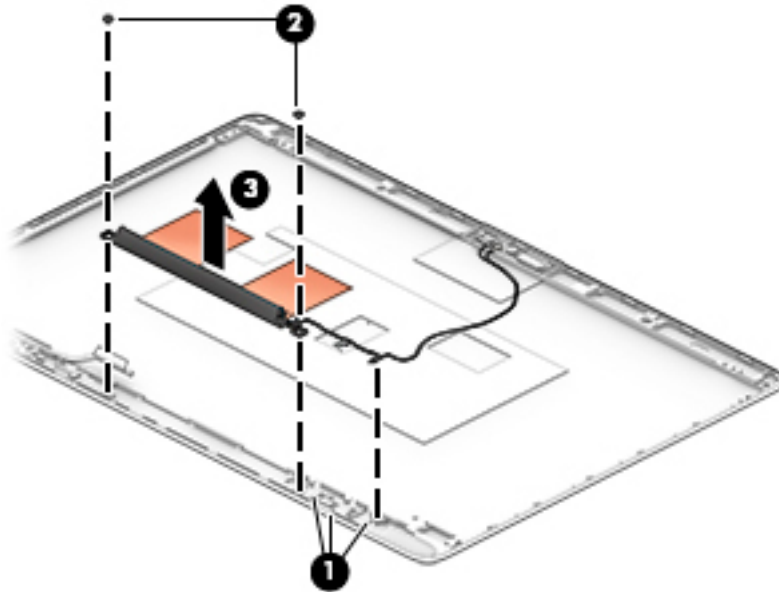

- 11. If it is necessary to replace the display cable:

- a. Remove the display cable and webcam cable from the routing path along the bottom and left side of the display enclosure **(1)**.
- b. Remove the display cable from the display enclosure **(2)**.

The antennas are available using spare part number 840938-001.

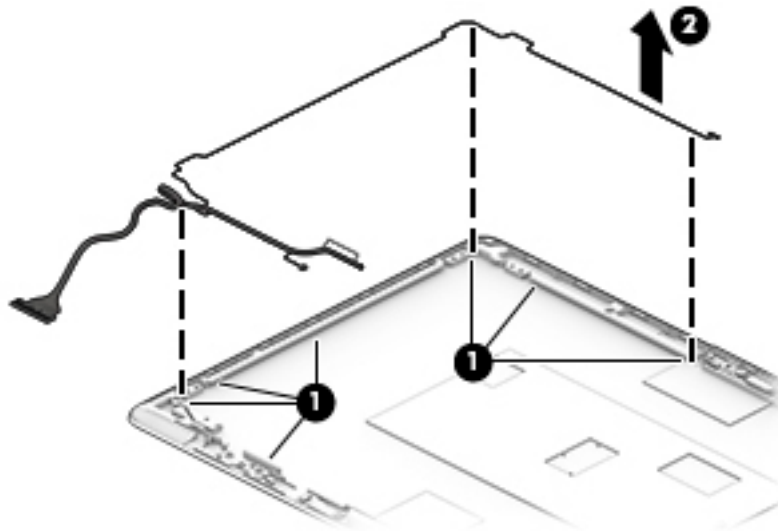

Reverse this procedure to reassemble and install the display assembly.

Top cover

| Description | Spare part number |
|-------------|-------------------|
| Top cover | 840636-001 |

The top cover spare remains after removing all other spare parts.

7 Troubleshooting guide

This chapter is primarily focused on troubleshooting HP Mobile Workstations and HP Notebooks. The information is provided so that you can solve problems yourself or at least narrow down what may be causing the problem. Based on some of the most common symptoms, this chapter helps to identify logical steps and available resources or tools for resolving an issue. HP recommends that you follow the instructions carefully, observe safety precautions, and note any observations or results. Capturing this information may help identify and resolve the problem faster.

 **WARNING!** To reduce the risk of electric shock or damage to the equipment:

- Do not disable the power cord grounding plug. The grounding plug is an important safety feature.
- Plug the power cord into a grounded (earthed) outlet that is easily accessible at all times.
- Disconnect power from the equipment by unplugging the power cord from the AC outlet.
- Before disassembling notebooks, always disconnect power and remove the battery.

 **CAUTION:** Static electricity can damage the electronic components of the computer. To prevent damage to the computer, carefully observe the electrostatic discharge precautions.

- Discharge static electricity by briefly touching a grounded metal object before you begin.
- Work on a static-free mat.
- Wear a static strap to ensure that any accumulated electrostatic charge is discharged from your body to the ground.
- Create a common ground for the equipment you are working on by connecting the static-free mat, static strap, and peripheral units to that piece of equipment.
- Refer to the Electrostatic Discharge Section of the Maintenance & Service Guide for more information.

CAUTION: The computer includes customer self-repair parts and parts that should only be accessed by an authorized service provider. See the chapter titled "Removal and replacement procedures for Customer Self-Repair parts," for details. Accessing parts described in the chapter titled "Removal and replacement procedures for authorized service provider only parts" can damage the computer or void the computer warranty.

Resources

| HP Resource Tool | Description | Link |
|---|--|--|
| HP Elite Support | Provides live HP Premium support (available 24/7) to Elite computers. | http://www8.hp.com/us/en/ads/elite-products/overview.html |
| HP Support Center | Provides important support, such as warranty, support cases, drivers, Customer Advisories, Customer and Security Bulletins, and Product Change Notices. | http://h20565.www2.hp.com/portal/site/hpsc |
| HP Troubleshooting Support page | Provides troubleshooting information for your specific HP computer. | http://www8.hp.com/us/en/troubleshooting.html |
| Subscribers Choice | Allows you to sign up for HP product updates. | http://www8.hp.com/us/en/subscribe/ |
| HP Support Forums | Provide discussions about HP products and issues. | http://h30434.www3.hp.com/psg/ |
| Service Access Workbench (SAW) (Available for technicians and Business Partners only) | Provides navigable content intended for use by internal and outsourced call center staff and can be a resource for support and product division professionals. | http://sawpro.atlanta.hp.com |
| Vendors' web sites | Provide additional information for associated components such as Intel (processor, WLAN), Microsoft (Windows 7/8/10), AMD/NVidia (GPU), and so on. | http://www.intel.com http://www.microsoft.com http://www.amd.com http://www.nvidia.com |

General troubleshooting steps

A basic logic should be used when troubleshooting computer issues. This section will help you become familiar with troubleshooting methodology and efficiently resolve problems. Proceed through the steps in the following table until the issue is resolved, and then move on to the next step that is relevant to the issue. For example, if you resolve a memory issue using the HP PC Diagnostics (UEFI) tool in step 6, you can then move on to step 10 to reseat the memory into its memory slot.



NOTE: General troubleshooting steps do not have to be followed in a specific order if an issue does not apply.

Table 7-1 Troubleshooting methodology and general troubleshooting steps

| Identify issue | Analyze issue | Resolve issue | Verify solution |
|---|--|--|--|
| 1. Understand the issue on page 63 | 5. Remove or uninstall recently added hardware, software on page 66 | 8. Hard reset on page 74 | Verify solution on page 78 |
| 2. Examine the environment on page 65 | 6. HP Hardware Diagnostics and Tools on page 67 | 9. Soft reset (Default Settings) on page 75 | |
| 3. Perform a visual inspection of hardware on page 66 | 7. Status lights, blinking light codes, troubleshooting lights, and POST error messages on page 71 | 10. Reseat cables and connections on page 75 | |
| 4. Update BIOS and drivers on page 66 | | 11. Test with minimum configuration on page 76 | |
| | | 12. Test with verified working configuration (hardware and/or operating system) on page 77 | |
| | | 13. Replace the system board on page 77 | |

Identify the issue

1. Understand the issue

It is important to understand the issue that occurred, including related symptoms. It helps to understand the basic computer boot-up sequence as well as the failure itself. The boot-up sequence and associated failures are described below.

Boot up sequence

The computer performs several steps after you press the power button or restart the computer.

It is important to understand where in the boot-up sequence the symptoms occur. The following table lists the phases of the boot-up sequence and explains the symptoms that may occur in each phase. For example, a blue screen error (BSOD) often occurs during the performance phase.

Table 7-2 Boot-up sequence

| | |
|---------------------------------------|---|
| Power-on | After power button is pressed, the computer boots after all internal power rails (i.e., 5V, 3.3V) are stable. Confirm that power lights are on fan is spinning. Next step: If the computer experiences a power-on issue, see “Verify Power Good (Troubleshooting) lights” in No Power on page 80 . Common issues: all lights are off; troubleshooting lights are on; does not boot; video is absent. |
| POST (UEFI/BIOS) | Power-On Self-Test (POST) verifies that hardware components (processor, hard drive, memory, etc.) are functional. When POST is complete, the HP logo displays briefly and then disappears. If there are errors, the computer may exhibit blinking lights and POST error messages Common issues: lights blink, error message appears, hangs. |
| Performance (operating system) | System boots to operating system, and Windows logo screen appears.. Common issues: hangs (lock up/freezes), blue screen, video distorted, driver conflict, slow performance, display issue (dead pixel), I/O issue (no speaker sound), wireless/audio unavailable, noise. See Analyze the issue on page 66 table below for detailed troubleshooting information). |

Failure classification

Failure classification is a breakdown of different types of failures and symptoms that could occur during the boot-up sequence. Table 3 and table 4 represent the failure classification for common notebook failures.

Table 3 categorizes failures by the boot-up sequence.

1. Power-on: Common issues are No Power, Recycle/Reboot, etc.
2. POST: Common issues are No Boot (have power), Light Flash or Diagnostics Error.
3. Performance: Common issues are Intermittent Loss of Power, Blue Screen, Hang, etc. In many cases, issues may be identified and associated with a particular hardware (i.e., display, storage).

Table 4 categorizes failures by hardware.

4. Display
5. I/O devices (Input/Output)
6. Storage
7. Mechanical

A single symptom can be listed under different groups. For example, No Video can belong to (1) Power-on or (4) Display; but Flickering when powered should be listed in (4) Display. Or, in another example, a blue screen can be caused by a driver conflict in Performance (4), but it can also be caused by a defective hard drive under (6) Storage. Therefore, failures that share similar symptoms are noted..

If possible, make a record of the failure symptom, the phase of the boot-up sequence where the failure occurs, and the most likely location in the failure tree ([Table 7-3 Failure classification by boot-up sequence on page 64](#) and [Table 7-4 Failure classification by hardware devices and mechanical on page 65](#)). This will help isolate the issue and indicate the next steps. For example, when the computer is running the operating system, it may experience an issue with (4) Display, (5) I/O devices (keyboard, wireless, and so on), (6) Storage, or (7) Mechanical components (stuck buttons, thermal shutdown, and so on).



NOTE: “Uncategorized” is used if an issue found is not listed. For example, Bluetooth is offered on certain hardware configurations; therefore, a Bluetooth issue can be classified under “I/O Device” if needed.

Failure classification by boot-up sequence

Table 7-3 Failure classification by boot-up sequence

| 1. Power-on | 2. POST | 3. Performance |
|---|--|---|
| 1. No Power on page 80 | 1. No video (with power) on page 86 | 1. Intermittent shutdown on page 90^a |
| 2. Intermittent power-on, shutdown, reboot on page 82^a | 2. Blinking lights on page 87 | 2. Blue screen (BSOD) error on page 115^b |
| 3. AC adapter issue on page 83 | 3. Diagnostics error messages on page 88 | 3. Freeze at Windows Logo (hang/lockup) on page 93 |
| 4. Battery not recognized, not charging on page 83 | 4. BIOS password on page 89 | 4. Electromagnetic Interference (EMI) on page 94 |
| 5. Battery discharges too fast on page 85 | | 5. No wake up on page 95 |
| 6. Burnt smell on page 86 | | 6. Unresponsive on page 96 |
| | | 7. Slow performance on page 96^c |
| | | 8. HP Smart Adapter warning message on page 97 |
| | | 9. Incorrect time and date on page 97 |

^{a,b,c} similar symptoms

Failure classification by hardware devices and mechanical

Table 7-4 Failure classification by hardware devices and mechanical

| 4. Display | 5. I/O devices | 6. Storage | 7. Mechanical |
|---|---|--|--|
| 1. Display anomalies on page 98 | 1. Keyboard on page 104 | 1. Hard drive/solid-state drive not recognized on page 114 | 1. Fan error message - 90B on page 117 |
| 2. Dead pixel on page 100 | 2. Keyboard point stick on page 105 | 2. No boot to operating system (no read/write error) on page 114 | 2. Noise (sound) on page 118 |
| 3. No video (internal) on page 100^d | 3. Keyboard backlight on page 105 | 3. Read-write error on page 115 | 3. Fan runs constantly on page 119 |
| 4. No video (external) on page 101^d | 4. TouchPad on page 106 | 4. Slow performance on page 96^c | 4. HP Thermal Monitor on page 70 |
| 5. DisplayPort/VGA on page 101 | 5. Network Connectivity Ethernet (RJ-45 jack) on page 106 | 5. Blue screen (BSOD) error on page 115^b | 5. Stuck power button on page 120 |
| 6. HDMI on page 101 | 6. Network connectivity wireless (WLAN) on page 107 | 6. Noisy hard drive on page 116 | |
| 7. No or bad external video via docking on page 102 | 7. WWAN on page 108 | | |
| 8. Incorrect or missing color/distorted image on page 102 | 8. USB on page 109 | | |
| 9. Touch screen on page 103 | 9. Smart card reader on page 110 | | |
| | 10. Speaker, headphone - audio issues on page 111 | | |
| | 11. Thunderbolt (TB) on page 112 | | |

^{b,c,d} similar symptoms

2. Examine the environment

It is important to examine the computer's environment. If you can quickly identify the cause of the issue, fewer resolution steps may be needed. Perform the following environment inspections:

- Check all cables and connections to be sure that there are no loose connections.
- Confirm that power sources are good, such as wall power type/adaptor (110V/220V ac), power strip. Test with a verified working AC outlet.
- Check for compatibility issues between the computer and third-party devices, peripherals, noncertified devices, incompatible hardware (i.e., Mac OS device). Incompatibility can result in blue screen errors, improper operation, and so on.
- Isolate the computer from sources of electromagnetic interference (EMI), such as cell phones, 2-way radios, floor mats, fans (and other electronic motors). EMI may contribute to a display freeze issue or lock-up.

3. Perform a visual inspection of hardware

It is important to do a visual inspection of the hardware itself. Perform physical inspection of the computer:

- Look for abnormalities such as a cracked display, dented battery, broken latches for battery bay, keyboard key caps popped out, dust over connectors, liquid spill over keyboard, etc.
- Look for signs of drop, movement, or vibration that may cause internal and external loose connections.

4. Update BIOS and drivers

 **IMPORTANT:** Whenever possible, update to the latest BIOS, firmware, and drivers before troubleshooting.

Note that some customer company policies prohibit updates. Check your company policy before taking action.

The updates may include fixes for your computer issues, and they may also enhance system performance. HP continually improves the update process to make it easier. The BIOS update can be done locally through a manual process, through an automatic installation, or through a remote installation on multiple units.

Manually updating BIOS and drivers

- See the Computer Setup chapters to manually update BIOS and drivers.
- Refer to specific BIOS update installation instructions that accompany the download.

Remotely deploying BIOS and drivers

Instead of manually searching for and downloading each SoftPaq, users and IT personnel can use two tools to identify and download all appropriate SoftPaqs for the selected HP models.

- HP SoftPaq Download Manager (SDM) is a software tool designed to streamline the download, extraction, and installation process of SoftPaqs, including BIOS and drivers.
- HP System Software Manager (SSM) is a software tool designed to simplify the deployment of SoftPaqs to HP computers.

Analyze the issue

5. Remove or uninstall recently added hardware, software

HP has designed this computer and validated it using a full-range hardware and software qualification matrix. If an issue appears to have started recently, it may be related to the recent addition of hardware or software. A good method to determine the root cause is to remove recently added components or uninstall applications one at a time and restart the computer when necessary.

 **IMPORTANT:** After you have completed the process of uninstalling hardware or software and are ready to reinstall, when installing a new device be sure that it is seated properly and all cables are correctly connected. After installing the device, restart the computer and make sure the new device is powered on. In addition, if the new device is a root cause of a problem, it could cause a conflict in drivers or incompatibility issues with other programs installed. For any new hardware you have added, be sure to install the latest drivers available from the device vendor website.

6. HP Hardware Diagnostics and Tools

HP offers different diagnostics and tools to diagnose hardware failure. This section describes how to use some of these tools. Make sure to check for the latest versions before use.

HP PC Hardware Diagnostics (UEFI)

HP PC Hardware Diagnostics is a Unified Extensible Firmware Interface (UEFI) that allows you to run diagnostic tests to determine whether the computer hardware is functioning properly. The HP PC Hardware Diagnostics (UEFI) tool is built within BIOS (basic memory and hard drive diagnostics only), or within new hard drives themselves. These drives contain more advanced versions of the diagnostic tool than the BIOS-based version.

In addition, for HP authorized service partners and IT professionals who need to support a mixed environment of older and newer HP/Compaq PCs, the [HP PC Diagnostics 3-in-1 USB Key](#) is a diagnostic tool that supports a wide range of HP Desktop and Notebook computers.

The tool runs outside the operating system so that it can isolate hardware failures from issues that are caused by the operating system or other software components. In reality, many problems can be determined using this tool if the issue is a defective part or a loose connection (i.e., reseating keyboard cable after the tool reports a keyboard error).

The tool has three major functions:

- **System Tests** - Check the computer's hardware to assure everything is functioning properly. If your system won't boot into Windows, try the Quick System Test. For more comprehensive testing, use the Extensive System Test option. If the System Test did not detect a hardware problem, continue with the Component Tests.
- **Component Tests** – Focus on selected hardware components in your computer.
- **Firmware Management** – Update your computer's BIOS to the latest version (available separately) or roll back to a previous version.

To start HP PC Hardware Diagnostics (UEFI):

1. Turn on or restart the computer, quickly press the **esc** button on the computer, and then press **F2**. The BIOS searches three places for the diagnostic tools, in the following order:
 - a. Connected USB drive
 - b. Hard drive
 - c. BIOS

2. When the diagnostic tool opens, use the keyboard arrow keys to select the type of diagnostic test you want to run, and then follow the on-screen instructions.

Screen shot appearance may vary.

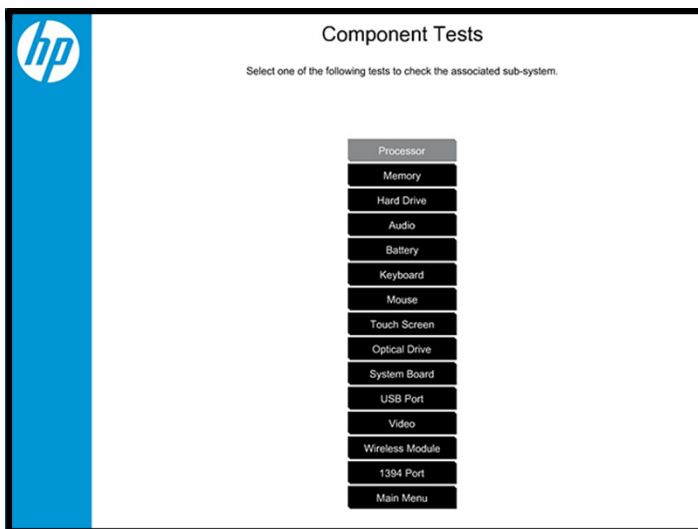
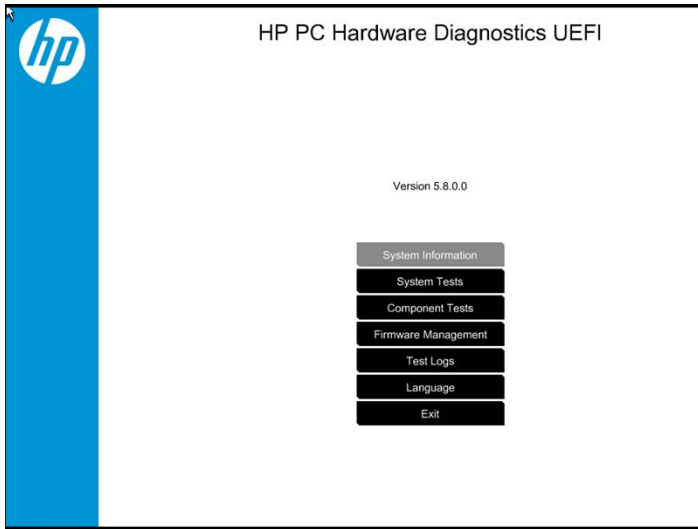

 **NOTE:** Users should utilize this tool, especially when the computer cannot boot to Windows.

 **NOTE:** If a component fails a test, write down the information so it is available when contacting support. The information is also available in **Test Logs** on the Main Menu.

For more information, see the chapter titled “Using HP PC Hardware Diagnostics (UEFI).”

HP Support Assistant (HPSA)

HP Support Assistant (HPSA) helps you maintain peak performance and resolve problems through automatic updates, built-in diagnostics, and a variety of assistance options. HPSA is preinstalled on every new HP PC with Windows 7, Windows 8, or Windows 10. HP is continually improving this tool. Please verify the latest version is installed to receive the most benefit. For more information, see [HP Support Assistant](#).

 **NOTE:** HPSA can be used only if the computer boots into Windows. If the computer does not boot into Windows, use HP PC Hardware Diagnostics (UEFI) instead.

HPSA also integrates diagnostics and tools that help resolve issues. See example screen shots as follows.

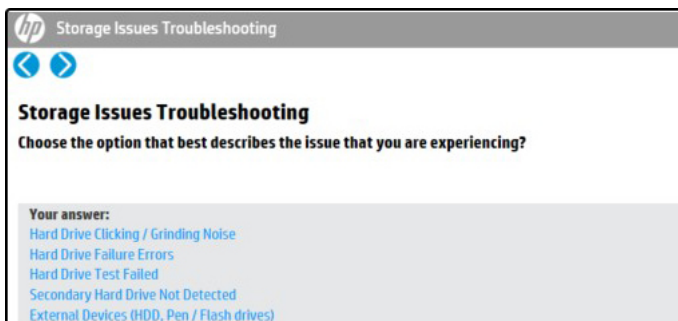
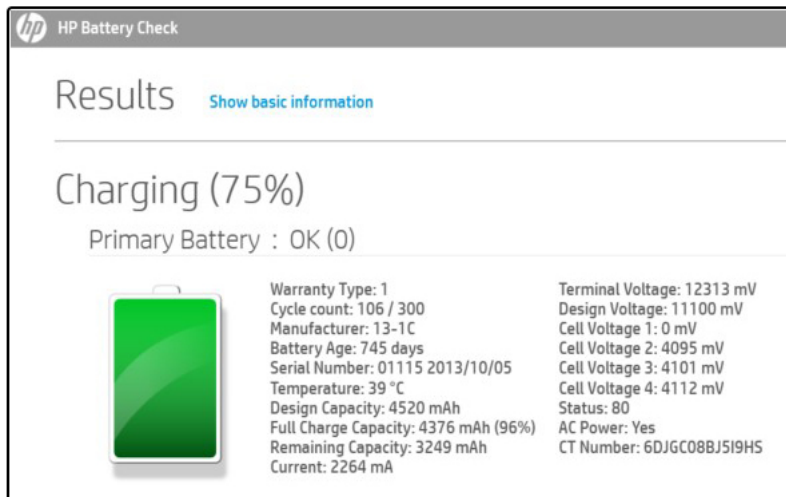
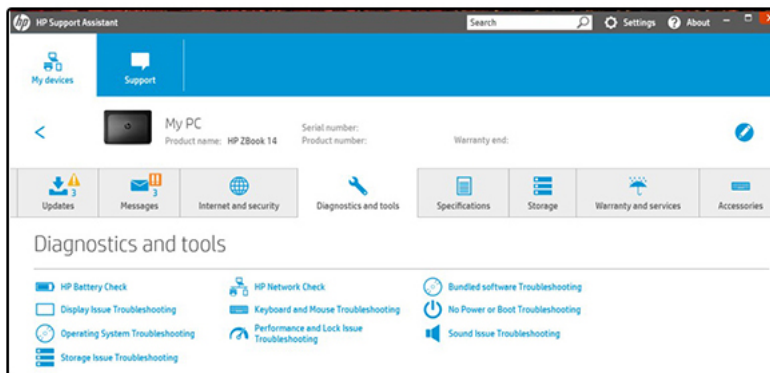

HP BIOS Configuration Utility (BCU)

HP BCU is a free utility that captures the BIOS settings and their values. This tool provides a text file of the computer's BIOS configuration. This can help identify any settings that may be contributing to an issue.

In some cases, it may help to compare this BIOS text file to the default settings of the computer.

For more information, see the [HP BIOS Configuration Utility \(BCU\) User guide](#).



NOTE: HP recommends that you reset BIOS before trying BCU. Resetting the BIOS is always available and relatively quick to try, whereas BCU takes extra time and effort.

HP Image Diagnostic Tool

Available to HP Authorized Support Partners (ASPs) and users from the [HP public ftp site](#), this tool collects information about the current state of the computer, including product serial number, platform and BIOS information, and information about user-installed software and hardware components. HP encourages you to review the report before sending it to support. The report may assist you with diagnostics and solutions to problems you encounter.

HP Thermal Monitor



NOTE: Available only to authorized service providers/technicians.

Available only for HP internal use, HP Thermal Monitor can be used to stress the processor and GPU and monitor the temperature values of various components in the system. The components that are currently monitored include the processor, GPU, ACPI thermal zones, hard drive, and battery. The tool reads the temperatures of the components, logs the data, and helps to determine whether the computer would overheat in the event of thermal shutdown, fan spinning loud, etc.

Non HP diagnostics tools

Windows-to-Go USB

Windows-To-Go USB is a Microsoft-based tool for Enterprise editions of Windows that can help in troubleshooting. You can find a process online about how to create a live Windows USB drive. For more information, see [Windows To Go: Feature Overview](#).

Intel Processor Diagnostic Tool

Determine what processor is in your computer and verify the processor operating frequency. The tool also tests specific processor features and performs a stress test on the processor. For more information, see http://www.intel.com/support/processors/sb/CS-031726.htm?iid=subhdr+tools_procdiaqtool.

7. Status lights, blinking light codes, troubleshooting lights, and POST error messages

Carefully observe any behavior the computer may be exhibiting: status lights, blinking lights, and POST error messages during boot. It is important to understand what these indicators mean.

Status lights

See the chapter titled “External Component Identification” for light locations. The following table describes basic lights on the computer.

| Component | Description |
|------------------------------------|---|
| Power button | <p>When the computer is off, press the button to turn on the computer.</p> <p>When the computer is on, press the button briefly to initiate Sleep (Windows) or Suspend (Linux).</p> <p>When the computer is in the Sleep state, press the button briefly to exit Sleep (Windows) or Suspend (Linux).</p> <p>When the computer is in Hibernation, press the button briefly to exit Hibernation.</p> <p>CAUTION: Pressing and holding down the power button results in the loss of unsaved information.</p> <p>If the computer has stopped responding and operating system shutdown procedures are ineffective, press and hold the power button.</p> |
| Front power light | <p>On: The computer is on.</p> <p>Blinking: The computer is in the Sleep state.</p> <p>Off: The computer is off.</p> |
| Front AC adapter and battery light | <p>White: The computer is connected to external power and the battery is charged from 90 to 99 percent.</p> <p>Amber: The computer is connected to external power and the battery is charged from 0 to 90 percent.</p> <p>Blinking amber: A battery that is the only available power source has reached a low battery level. When the battery reaches a critical battery level, the battery light begins blinking rapidly. By default, the critical battery level is defined in Power Options as 5%.</p> <p>Off: The battery is fully charged.</p> |
| Front hard drive light | <p>Blinking white: The hard drive is being accessed.</p> <p>Amber: HP 3D DriveGuard has temporarily parked the hard drive.</p> |
| Rear AC adapter light | <p>White: The computer is connected to external power.</p> <p>Off: The computer is not connected to external power.</p> |

Blinking light codes

During startup, the computer may not boot properly. If this occurs, blinking light codes that will help identify what is causing the issue. The computer uses the blinking lights below to identify a hardware component that reports an error during startup. For more information, see [Blinking lights and boot error codes on page 122](#).

Table 7-5 Boot-error codes

| Blink codes | Error |
|---|--|
| Amber battery light: blinks 1 Hz continuously | Embedded controller unable to load firmware |
| Caps/num lock lights = 1 blink | Processor not executing code |
| Caps/num lock lights = 2 blinks | BIOS recovery code unable to find valid BIOS recovery image |
| Caps/num lock lights = 3 blinks | Memory module error |
| Caps/num lock lights = 4 blinks | Graphics controller error |
| Caps/num lock lights = 5 blinks | System board error |
| Caps/num lock lights = 6 blinks | Intel Trusted Execution Technology (TXT) Error |
| Caps/num lock lights = 7 blinks | Sure Start unable to find valid BIOS Boot Block image |
| Caps/num lock lights = 8 blinks | Sure Start has identified a problem (Manual Recovery Policy Set) |

POST error messages

The Power-On Self-Test (POST) is a series of diagnostic tests that runs automatically when the computer is powered on. If the POST encounters a problem, visual error messages are displayed before the operating system starts. POST checks the following items to ensure that the computer system is functioning properly:

- Memory
- Processors
- BIOS
- Mass storage devices
- Fans

The following table describes errors encountered during HP PC Hardware Diagnostics (UEFI).

Table 7-6 System diagnostics failure codes and user actions

| Test description | Failure description | Error code | Suggested user actions |
|---------------------|------------------------|------------|--|
| Startup Test | Memory module | 200 | Attempt to reseat the memory module and then repeat the test. See the support document titled Overview of How to Troubleshoot Problems When a Computer Does Not Start Up or Boot Properly for details on troubleshooting issues related to the memory module. |
| Startup Test | Hard Disk 1 SMART | 301 | Attempt to reseat the hard drive and repeat the test. The hard drive may have failed. |
| Boot Device Manager | Boot device not found | 3F0 | Reset BIOS. Then reseat the hard drive and repeat the test. |
| BIOS Recovery | BIOS Recovery Occurred | 500 | This message indicates that BIOS recovery was completed successfully. No further action is required. |

Table 7-6 System diagnostics failure codes and user actions (continued)

| | | | |
|------------------|-----------------------------|-----|--|
| BIOS Application | BIOS Application Error | 501 | The BIOS installation may have become corrupted. Download the latest version of the BIOS and install it. If reinstalling the BIOS fails, contact support for further assistance. |
| CMOS Recovery | CMOS Recovery Occurred | 502 | This message indicates that CMOS recovery was completed successfully. No further action is required. |
| Battery Check | Primary Battery Replace | 601 | This message indicates that the primary battery has very low capacity. See Checking the Status of the Battery for details on using the HP Support Assistant to verify the battery capacity and, if necessary, order a replacement. |
| Wireless Modules | Not installed or responding | 701 | Reseat the wireless LAN adapter module and antennas. Because seating or reseating a wireless LAN adapter is unique to each computer model, see the WLAN module removal section in the removal and replacement chapter for further details. Contact support if third-party wireless adapters are installed in the computer. |
| Fan | Fan not operating correctly | 90B | The system fan may be malfunctioning. Replace the fan. |

Power Good (Troubleshooting) lights

HP has added troubleshooting power lights to ZBook G3 Mobile Workstations (Studio, ZBook 15, and ZBook 17) to help troubleshoot power-on issues. The lights indicate when the system board power rails are unstable and/or the system needs a hardware reset.

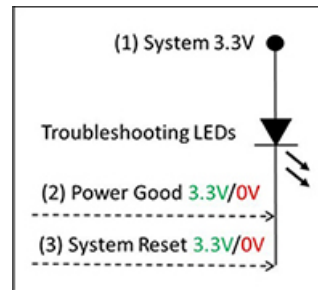
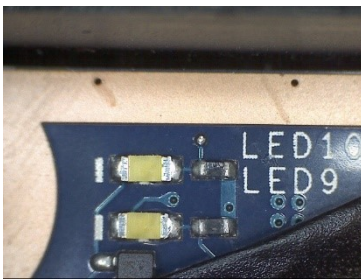

These lights should be visible after removing the service door or bottom cover. Consult with support for platform-specific locations of the lights.

Troubleshooting LEDs diagram

- Example: System board is good. Lights that turn on briefly (< 1 second) and immediately turn off indicate normal function. In this case, system (3.3V), power good (3.3V), and system reset (3.3V) are all good and troubleshooting lights should not be lit. However, other external lights should be lit as normal afterward.

| Troubleshooting lights | External lights | Action | Note |
|------------------------|-----------------|-----------------------------|-------------------|
| Off | On | Do not replace system board | No power-on issue |
| On | Off | Replace board | Power-on issue |

- Example: System board needs replacement. When (1) system 3.3V exists, but one power rail is bad then (2) power good is low (0V), and troubleshooting lights will turn on.

After you press the system power button, troubleshooting lights will turn on for 5 seconds and turn off. The system external lights will not light up. Follow general troubleshooting steps (i.e., remove recently added hardware, test with minimum configuration, etc.) prior to replacing the system board.



Resolve the issue

8. Hard reset

A [hard reset](#) (or forced reset) erases all information in the computer's memory and may restore functionality. Resetting the computer forces the system to clear and reestablish the connections between the BIOS and the hardware.

Performing a hard reset might fix the following common conditions:

- Windows stops responding.
- Computer stops before Windows loads, indicated by incomplete boot-up, blinking cursor on a black background, and errors relating to operating system not found or a missing drive.
- Display suddenly goes blank and stays blank.
- Software freezes.
- Keyboard stops responding.
- The computer does not exit Sleep or Suspend state.
- An external device stops responding. Turn off the power to that device in addition to performing the steps in this document.

Before performing a hard reset, you must disconnect or remove all peripheral devices. You should start and test the computer by itself, and if the problem is not resolved, reconnect one peripheral device at a time. To resolve the startup or operational problem, run HP Support Assistant, or manually install all updated drivers from Microsoft and HP.

Before beginning, turn the computer over and look for a battery compartment door (service door). For 2015 platforms, the battery is considered removable but not accessible. See the battery section for how to remove/unplug the battery.

To perform a hard reset on a computer with a sealed or non removable battery, use the following steps:

1. Turn off the computer.
2. Remove the computer from any port replicator or docking station.
3. Disconnect all external connected peripheral devices such as USB storage devices, external displays, and printers.

4. Unplug the AC adapter from the computer.
5. Disconnect the battery.
6. Press and hold the power button for at least 15 seconds to drain residual power.
7. Reconnect the battery and plug the AC adapter back into the computer, but do not connect any of the peripheral devices.
8. Press the power button to turn on the computer.
9. If a startup menu appears, use the arrow keys to select **Start Windows Normally**, and then press the **Enter** key.
10. After reconnecting each of the peripheral devices, run Windows Update and HP Support Assistant to update all device drivers.

Clear CMOS

CMOS refers to the battery-powered, semiconductor chip located on computer's system board. Notebooks store low-level settings like the system time and hardware settings in CMOS. Sometimes it is necessary to clear CMOS, which requires removing and reinserting the 3V RTC battery for a short period of time (a few minutes before reinserting), in addition to removing the AC adapter and battery.



NOTE: Clearing the CMOS should only be performed for troubleshooting purposes. There is no reason to clear CMOS if the computer is working properly.

The notebook service door must be removed to access the CMOS battery. See the RTC battery replacement section for the battery removal/replacement.

9. Soft reset (Default Settings)



NOTE: Some company policies prohibit updates or changes. Check whether the computer has custom BIOS settings before taking action.

If your computer is having issues booting, has errors during boot, is running into issues after adding hardware, or you are having other abnormal system behaviors that cannot be resolved through any other methods (i.e., hard reset), it may be necessary to reset the system BIOS to default settings.

To load BIOS to default settings: Reboot the computer, and then press **F10 > Main > Restore defaults**. For more information, see the BIOS F10 Setup technical white paper at <http://support.hp.com>, enter your computer model, and then go to **Manuals > White papers > HP PC BIOS F10 Setup Guide**.

10. Reseat cables and connections



NOTE: Before disassembling the computer to reseat cables and connections, always disconnect power and remove the battery or disconnect a non removable battery.

Many problems are caused by improper connections or loose connections due to abnormal movement and vibration. See [Cable management on page 133](#) and [Connector types on page 134](#) for suggested cable management practices when removing and installing components.

You can access and reseat connections for Customer Self-Repair (CSR) parts (see the “Removal and replacement procedures for Customer Self-Repair parts” chapter for details). Examples of reseating hardware include:

- Reseating the battery into the battery bay can resolve no-battery found and no-charging issues.
- Reseating memory modules can resolve memory error, no-boot, and blue screen issues.

- Reseating the hard drive can resolve a POST error 3F0 (no boot device) issue (see [POST Error Messages and User Actions on page 124](#)).
- Reseating the keyboard cable can resolve an unrecognized keys error.
- Reseating the wireless module and antenna cable can resolve a wireless connection issue.

For field replaceable units (FRUs), authorized service providers can try the following steps (for more information, see the "Removal and replacement procedures for authorized service provider parts" chapter).

- Reseating the fan cable can fix POST error 90B (no fan detected) issue (see [POST Error Messages and User Actions on page 124](#)).
- Reseating the power cable can fix a no boot issue.
- Reseating the daughterboards (some models may have a power button board, VGA board, etc.) can resolve their functional issues.
- Reseating graphics cables and panel connectors can fix distorted/flickering video.
- Replacing thermal pads may resolve thermal power-down issue.

11. Test with minimum configuration

The factory-shipped computer (hardware configuration and preinstalled operating system image) is well tested and ready for use. Therefore, using the original factory hardware configuration and/or booting to operating system safe mode often resolves issues quickly.

- Disconnect any external USB storage, remove any discs in optical drives, remove the computer from a docking station, remove external video, etc.
- In addition to removing recently added components, the issue can be narrowed down further with a minimum configuration. For example, if HP PC Diagnostics reports a memory error, test one memory module at a time to isolate the defective module.
- If the computer does not successfully boot the operating system, booting to safe mode may help identify what may be causing the issue as described below.

Essential hardware configuration



NOTE: This step is to be used by authorized service providers only. HP will not honor the warranty for a system tested with the system board removed without the heat sink, fan, etc.

If none of the steps above resolve the issue, start the computer with essential hardware only. The purpose is to remove as much as hardware as possible while still maintaining the computer's ability to turn on.

This essential configuration is often used to troubleshoot power-on related issues, such as no-boot, reboot, and freezing issues.

The essential hardware consists of the following:

- System board
- AC adapter (unplug nonremovable battery or remove battery)
- Processor (and heat sink/fan). (Processor may be integrated into the system board.)
- Memory (one verified working memory DIMM)
- Graphics card (if no VGA port is available on the system board). Platform may have both Intel integrated graphics and discrete graphics. Therefore, discrete graphics card may not be needed.
- External VGA monitor

- External USB keyboard
- External mouse

 **NOTE:** After the service door is removed, disconnect all connections (internal keyboard, display, discrete GPU, hard drive/solid-state drive, daughterboards, etc.) to achieve the essential hardware configuration above. DO NOT disassemble the system board from its enclosure at this time.

Reverse the procedure above by reinstalling each piece of hardware removed, one piece at a time, and testing your computer after each installation. Since your computer works with only the essential hardware installed, those parts must be working properly. This means that one of the hardware components removed is causing the computer to not work properly. By installing each device back into the computer and testing each time, the failing hardware will eventually be identified.

Safe mode

A driver conflict often results in a blue screen error message. Therefore, booting in safe mode can resolve many issues in Windows because safe mode forces the computer to load a limited version of Windows which only contains essential files. Safe mode is useful for troubleshooting problems with programs and drivers that might not start correctly or that might prevent Windows from starting correctly.

If a problem does not reappear when you start in safe mode, eliminate the default settings and basic device drivers as possible causes. Refer to the links below for how to start your computer in safe mode:

- [HP PCs – Windows 7 Safe Mode](#)
- [HP PCs – Windows Safe Mode \(Windows 10, 8\)](#)

12. Test with verified working configuration (hardware and/or operating system)

One troubleshooting technique that can quickly isolate an issue is using a verified working part while testing. A good example is to use an external keyboard, mouse, or VGA monitor when you have issues with an internal keyboard, TouchPad, or display. Testing with a verified working AC adapter can identify an error caused by a faulty one. Similarly, testing with a verified working operating system can determine bad behaviors of the current operating system. See [Non HP diagnostics tools on page 70](#) for instructions about obtaining and using a Windows-To-Go USB.

 **NOTE:** In some situations, more than one item may contribute to a problem.

13. Replace the system board

The system board may be replaced only by authorized service providers. This should not be considered an initial step taken to resolve an issue. Review and perform all steps discussed previously before replacing the system board. [4. Update BIOS and drivers on page 66](#), [7. Status lights, blinking light codes, troubleshooting lights, and POST error messages on page 71](#), [8. Hard reset on page 74](#), and [9. Soft reset \(Default Settings\) on page 75](#), and/or [10. Reseat cables and connections on page 75](#) can resolve many system board issues without requiring the effort of replacing unnecessary hardware.

Review [Table 7-1 Troubleshooting methodology and general troubleshooting steps on page 62](#) for appropriate troubleshooting steps.

 **IMPORTANT:** System board failure is not common. Do not replace the system board until you have tried all other troubleshooting options.

 **NOTE:** Determine whether a previous service case might be related to the current problem. For example, a fan detection issue may be caused by a loose connection resulting from previous service.

 **TIP:** Without an RTC battery (3V coin-cell battery), the computer automatically reboots. This is a useful feature when the power connector cable (between external AC adapter and system board) is defective.

 **NOTE:** Most of the time, effective troubleshooting can prevent a system board replacement.

Items that may prevent resolution of the issue:

- The information provided about the issue omits key details, including any actions taken before the issue occurred.
 - BIOS, software, and drivers have not been updated.
 - Cables or connections are loose.
 - Technician is unaware of information available from the HP Support website (i.e., CA - Customer Advisory).
 - The issue is related to existing or known issues that may be identified in existing support articles.
 - Technician may have omitted steps in the provided repair instructions (e.g., Spare Part Replacement Instructions).
 - Skipping one of steps from Troubleshooting Methodology table results in No Defect Found (NDF)/No Fault Found (NFF)/No Issue Detected (NID) messages.
-

Verify solution

- Verify that the implemented solution works. Reboot the system or device and try to complete the task that produced the issue.
- If a part has been replaced, verify other basic functions. For example, GPU replacement requires keyboard removal. Therefore, it is good practice to verify all basic components to be sure that the solution is complete.
- Explain to the customer why the issue occurred and what was done to resolve it. If the solution you used was in an HP Public document, provide the document information to the customer, letting them know it can be located on www.hp.com. Also, tell them that there are other solutions available on the website. Advise the customer to check the website first when they have an issue. It may save them time calling in.
- Document the correct issue. Update the case with as many details as possible for other agents and engineering to analyze and study for lessons learned.

Helpful Hints

After you become familiar with the general troubleshooting steps above ([General troubleshooting steps on page 62](#)), follow the helpful hints below before running diagnostics and troubleshooting.

At startup

 **TIP:** If you have installed an operating system other than the factory-installed operating system, go to <http://www.hp.com/go/quickspecs> and verify that it is supported on your system.

1. Be sure that the computer is plugged into a working AC outlet.
2. Be sure that power is connected to the docking station if a dock is used.
3. Be sure that the AC adapter light is on.
4. Be sure that the AC adapter is connected when you update BIOS to avoid BIOS corruption.
5. Be sure that the computer is turned on, the rear power light is solid white (connected to an external power source) and the front power light is solid white (normal operation).
6. Remove all optical and flash drives from your system before turning it on.

7. Be sure that the boot option is set to a working operating system drive.
8. Be sure that externally connected monitors are turned on and their power lights are on. Not all monitors are equipped with lights to indicate their functionality.
9. Turn up the brightness and contrast controls of a display or external display device if the screen is dim.

During operation

1. To wake the computer:
 - a. Press the power button or any key on the keyboard.
 - b. If the system remains in the Sleep (Windows), Suspend (Linux), or Hibernate state, shut down the system by pressing and holding the power button for at least four seconds.
 - c. If the system does not shut down, unplug the power cord, wait a few seconds, and then plug it in again. Then press the power button again to restart the system. If it does not turn on, press the power button to start the computer.
2. Look for blinking lights on the computer. The blinking lights could be error codes that will help diagnose the problem.
3. Check all cables for loose or incorrect connections (external devices, power cords, dock, etc.).
4. After installing a non-Plug and Play expansion board or other option, reconfigure the computer. For example, if you upgrade to a solid-state drive, you may need to reconfigure the boot order.
5. Be sure that all required device drivers have been installed. For example, if you have connected a printer, you must install a printer driver.
6. If there is a network connection issue, plug another computer with a different cable into the network connection. There might be a problem with the network plug or cable.
7. If hardware has recently been installed, remove it and determine whether the computer functions properly.
8. If software has recently been installed, uninstall it and determine whether the computer functions properly.
9. If the screen is blank, confirm the display choice by pressing **Windows logo**  + **P** and set to screen only. Or plug an external monitor into a different video port on the computer if one is available and close the computer lid.
10. Verify that the latest version of BIOS, drivers, and software are installed. A new release might support new features or fix the problem.
11. Press the **caps lock** and/or **num lock** key. If the **caps lock** and/or **num lock** light toggles on or off, the keyboard is likely operating correctly.
12. Press the TouchPad On/Off button light. If the light toggles on or off, the TouchPad is likely operating correctly.

Consulting with HP Service

If further HP support is required, a lot of the following information may be requested when you call, so it may be helpful to take notes.

- Technical support registration number (if applicable)
- Product serial number

- Product model name and number
- Product identification number
- Applicable error messages
- Add-on boards or hardware
- Third-party hardware or software
- Operating system type and revision level

Common issues and possible solutions

This section contains common issues, symptoms, and a series of tables that describe possible solutions to issues from [Failure classification on page 63](#) tables. The following sections identify the issue with symptoms and solutions to resolve an issue.

Power-on issues

No Power

When a unit experiences no power there are several contributing factors to consider. Be sure to consider all symptoms related to this behavior in troubleshooting.

| <i>Symptoms</i> | <i>Possible causes</i> |
|--|---|
| <ul style="list-style-type: none"> • Computer does not start • Display is black or blank • No fan noise • No hard drive spinning • Lights do not glow | <ul style="list-style-type: none"> Failed power input to the computer (external power source, AC adapter, faulty battery). Bad connection to the computer (bad power button, power connector). Defective parts (memory, hard drive, graphics) or failed system board. |
| | <p><i>Troubleshooting steps</i></p> <p>Perform quick check</p> <p>Remove all external devices, including docking station.</p> <p>Verify external power source (2. Examine the environment on page 65).</p> <p>Perform a hard reset (8. Hard reset on page 74).</p> |



Verify AC adapter

It is preferable to verify the battery before verifying the AC adapter. However, you can verify the AC adapter first, before opening the service door for a battery check.

- Verify AC adapter is compatible with product. Verify that the part number is for this computer if possible.
- Verify AC adapter and power cord are good (no physical damage, bent middle ID pin).
- Verify AC adapter works on a verified working computer.
- Plug in AC adapter and power on computer without battery.
- Inspect power port on computer side for any damage, dust, or debris.



- Check power light ([7. Status lights, blinking light codes, troubleshooting lights, and POST error messages on page 71](#)). Rear power light indicates external power to the computer is good.

NOTE: Refer to battery replacement section for removing/replacing the battery

Verify battery condition/status

1. Check battery condition (overall result, cycle life, voltage, etc.) using HP PC Hardware Diagnostics (UEFI) or HPSA tools.
2. Verify that battery is installed properly in battery bay without a gap and that latch locks are tight (for models with removable batteries).
3. Check battery status light ([7. Status lights, blinking light codes, troubleshooting lights, and POST error messages on page 71](#)). Be sure that battery is not fully discharged, preventing system from booting.
4. Determine whether the computer can turn on with battery only.
5. Remove service door and test with a verified working battery. If the computer boots, inspect original battery before replacement.
6. Test battery with a verified working computer to verify that it is OK.
7. If there is still no boot, remove battery and boot on AC power only.

The sections below are intended for authorized service providers/technicians.

Verify AC adapter – voltage

1. Measure DC voltage output that should be around 19.5 VDC and acceptable voltage range is from 18.5 – 20.5 VDC.
2. If the DC voltage is out of range, replace the AC adapter.

NOTE: This action requires a digital voltmeter.

NOTE: 2015 mWS does not have the power cable between system board and power connector on chassis



Verify power button, power connector

1. Be sure that power button is not stuck.
2. Reseat power connector cable (if applicable).
3. Replace new power connector cable (if the cable exists and is defective)
4. To isolate faulty power connector cable and power button, technicians can short power-on pads/pins to power up the computer. Contact HP Engineering for this information.

Verify blinking lights ([7. Status lights, blinking light codes, troubleshooting lights, and POST error messages on page 71](#))

At this point, there should be sufficient power from the AC adapter to the system board. Expect to hear the fan spinning and see blinking lights or error messages (i.e., faulty memory, HDD, etc)

Verify Power Good (Troubleshooting) lights

1. Verify if the system board has power-on issue related. If there is no power-on issue, move to next steps. For more information, see [Power Good \(Troubleshooting\) lights on page 73](#).
2. Verify all connections and reseat parts ([10. Reseat cables and connections on page 75](#)).

Verify system board

1. Test essential hardware configuration ([11. Test with minimum configuration on page 76](#), [12. Test with verified working configuration \(hardware and/or](#)

[operating system](#)) on page 77, 13. Replace the system board on page 77) by removing nonessential parts.

2. If there is still no boot, replace system board.

Tips and tricks

Computer automatically boots without pressing power button when RTC 3V battery has been removed. Therefore, after the service door and RTC 3V battery are removed, no need to press power button from top side.

In essential hardware configuration, mWS G1 and G2 may require discrete GPU to boot. However, mWS G3 can boot with integrated graphics.

See [Overview of How to Troubleshoot Problems When a Computer Does Not Start Up or Boot Properly](#)

Intermittent power-on, shutdown, reboot

Symptoms

- Does not always turn on
- Intermittently hangs
- Intermittently shuts down
- Spontaneously reboots

Possible causes

Electrical short, fluctuating power source, unstable power rails, loose connections, bent pins, stray wires, dust, obvious damage, nearly faulty parts (bulging/leaking capacitor).

Potentially will turn into a no power issue soon ([No Power on page 80](#)).

Troubleshooting steps

1. Visually check power ports on both AC adapter and computer sides.
2. Inspect power sources:
 - a. Verify AC adapter working correctly. Use a confirmed working adapter to test.
 - b. Verify that battery is not depleted while system is in Sleep state. Test with a confirmed working battery.

The sections below are intended for authorized service providers/technicians.

1. Follow actions in [No Power on page 80](#).
 - a. Be sure that AC adapter has correct DC voltage.
 - b. Verify battery - test with a confirmed working battery.
 - c. Verify that power button is not stuck.
 - d. Verify that power connector is not loose.
 - e. Verify that Power Good LEDs are solid.
 - f. Remedy loose connections and reseat major components (processor, memory, GPU, hard drive/solid-state drive, etc).
 2. Perform visual check for loose connections, bent pins, stray wires, dust, nearly faulty parts (bulging/leaking capacitor).
 3. Test **essential hardware configuration** ([11. Test with minimum configuration on page 76](#))
 - a. If system boots, reinstall nonessential hardware one component at a time to isolate issue.
 - b. If system does not boot, replace essential hardware with verified working parts, one component at a time. If system still does not boot, replace system board.
-

AC adapter issue

| Solution | |
|--|--|
| <i>Symptoms</i> | <i>Possible causes</i> |
| <ul style="list-style-type: none">No sign of powerNo bootNo rear power lightNo front power lightBattery does not charge when AC adapter is connected | AC adapter and others (i.e., external power source) |
| | <i>Troubleshooting steps</i> |
| | Quick check |
| | <ol style="list-style-type: none">Verify external power source (2. Examine the environment on page 65).Remove all external devices, including docking station.Perform a hard reset for the computer (8. Hard reset on page 74).Disconnect and reassemble the power cord and adapter in case the adapter experienced short circuit, over current, over temperature events.Use a verified working adapter. If the computer operates normally, there is a problem with the original adapter.Verify that the AC adapter works on a verified working computer. If the computer operates normally, there is no problem with the adapter. See HP Smart Adapter warning message on page 97 for further information. |
| | Verify AC adapter |
| | <ol style="list-style-type: none">Remove working battery.Verify that AC adapter is compatible with product. Verify that part number is for this computer if possible.Inspect AC adapter and power cord for physical damage, bent middle ID pin.Plug in AC adapter and power the computer without battery.Inspect the power port on computer side for any damage, dust, debris.Check power light (7. Status lights, blinking light codes, troubleshooting lights, and POST error messages on page 71). Rear power light indicates that external power to the computer is good.If there is still no rear power light or no boot, replace the AC adapter. |
| Tips and tricks | <p>The HP Smart AC adapter has a special pin in the middle, called the ID pin, for power rating and throttling purpose. If this pin is broken, the rear power light will be on but the power button and front power lights will blink continuously and the computer will not turn on. Third party AC adapter will not work on the computer.</p> <p>Use the AC adapter that came with the computer for better performance.</p> <p>See HP Notebook PCs - Testing and Using the AC Power Adapter</p> |

Battery not recognized, not charging

| | |
|--|---|
| <i>Symptoms</i> | <i>Possible causes</i> |
| <ul style="list-style-type: none">No battery status lightBlinking amber (critically low battery level)No boot without AC adapter | <p>Defective AC adapter and/or battery.</p> <p>NOTE: Before proceeding, verify that the computer can boot to BIOS or Windows with a good AC adapter.</p> |

Troubleshooting steps

Visual inspections

1. Inspect battery connectors for any signs of damage.
2. Verify that battery is installed properly in battery bay without gap or obstructions and latch locks are tight. Reseat battery (for models with removable batteries).
3. Determine whether battery gets hot (batteries heat up when charging, but not too hot to touch).

Check battery warranty to see whether the battery is new or its warranty is expired. Battery capacity degrades over time.

Verify front battery status light

1. Battery status light is off: battery not recognized.
2. Battery status light is blinking amber: critically low battery level.

Reset

1. Hard reset ([8. Hard reset on page 74](#))
2. Soft reset ([9. Soft reset \(Default Settings\) on page 75](#))

Verify AC adapter

1. Determine whether the computer needs the AC adapter to boot and operate. Sometimes, intermittently bad AC adapter and loose connection between adapter and computer results in inability to charge battery which causes short run time.
2. Inspect AC adapter to verify that it is functioning.
3. Test with a working AC adapter and confirm whether battery is charging.
4. Be sure that battery is fully charged (AC adapter plugged in at least 2.5 hours).

Diagnostics: HP tools will report results such as passed, calibrate, weak, replace, no battery and unknown, and suggest corresponding actions.

Use HP Hardware Diagnostics (UEFI) ([6. HP Hardware Diagnostics and Tools on page 67](#))

- HP PC Hardware Diagnostics (UEFI) is a good tool to use to isolate and determine faulty battery, especially for quickly discharging (short life) battery.

Use HP Support Assistant tools in Windows ([HP Support Assistant \(HPSA\) on page 69](#))

1. Verify that battery is recognized and charging.
2. Verify battery condition if battery cycle life is over specs (i.e., long life of 1000-cycle life and 3-year warranty). Battery may have premature capacity loss within its cycle life or warranty.
3. If issue remains, test with a verified working battery and verify battery status lights and battery conditions.
4. If issue remains, replace system board.
5. Verify the new replacement.

Tips and tricks

See the computer user guide for instructions regarding battery maintenance and increasing battery life.

- Reference: [HP Notebook Mobile Workstations - Improving Battery Performance \(Windows 10, 8, 7, Vista\)](#)
 - Reference video: [Testing and Calibrating the Battery on PC Notebooks](#)
-

Battery discharges too fast

| <i>Symptoms</i> | <i>Possible causes</i> |
|---|--|
| Battery has good status light but discharges too fast | <p>AC adapter and/or battery.</p> <hr/> <p><i>Troubleshooting steps</i></p> <p>Verify AC adapter</p> <p>Determine whether the computer needs the AC adapter to boot and operate. Sometimes, intermittently bad AC adapter and loose connection between adapter and computer results in inability to charge battery and causes short run time.</p> <ol style="list-style-type: none">1. Inspect AC adapter to verify that it is working.2. Test with AC adapter alone and with a verified working AC adapter. <hr/> <p>Verify battery: Battery capacity can degrade over time, so check the warranty coverage. Run a battery test to confirm if issue is hardware-related.</p> <ol style="list-style-type: none">1. Review battery power plans in Control Panel > Power Options that may consume more energy and discharge battery faster. Resetting default to Power Saver option can conserve battery power.2. Determine whether any graphics processing is running.3. Verify battery maintenance and operations. Leaving the battery at a high level of charge in a high-temperature environment for extended periods accelerates the loss of capacity.4. Test and calibrate battery using HP PC Hardware Diagnostics (UEFI).5. Verify battery life cycle using HP Support Assistant tool. <p>If battery cycle life is over specs (long life battery of 1000-cycle life and 3-year warranty), battery may have capacity loss beyond its lifecycle or warranty.</p> <ol style="list-style-type: none">6. Compare discharge time with a verified working battery (remove AC adapter) using Hardware Diagnostics (UEFI) > Hard Drive Tests > Extensive Test > Loop until error. <hr/> <p>Tips and tricks</p> <p>To conserve battery power, turn off Wireless On-Off button and other peripherals/USB devices, applications, processes (in Task Manager) when not in use; also, reduce screen brightness.</p> <p>Follow HP instructions of how to maintain battery and increase battery life.</p> <p>Reference: HP Notebook Mobile Workstations - Improving Battery Performance (Windows 10, 8, 7, Vista)</p> <p>Reference video: Testing and Calibrating the Battery on PC Notebooks</p> <hr/> |

Burnt smell

Symptoms

Emits smoke, burnt smell

Possible causes

Defective on-board components.

Troubleshooting steps

General visual inspection

1. Disconnect the computer from power source (AC adapter and battery).
2. Inspect for visual damage on AC adapter and battery. Test on a known working computer to isolate issue. If issue follows AC adapter or battery, replace it.
3. Inspect any sign of liquid spill on the computer (back of keyboard).

The sections below are intended for authorized service providers/technicians.

Further inspection on components

1. Inspect further sources internally after disassembling chassis, such as burnt or damaged components.
 2. If the issue persists, replace boards, AC adapter, and battery for safety concern and report issues to HP.
-

POST

No video (with power)

Symptoms

- No video (black/blank image) but have power
- Light activity
- No error messages
- Fan noise
- Hard drive light blinking and hard drive noise

Possible causes

Failed display
Failed critical components (memory, hard drive, system board)
Loose connection
Recently added hardware

NOTE: Assume the computer has not previously been set up for multiple displays.

Troubleshooting steps

Quick check

1. Verify that system light activity is OK.
2. Remove all external devices, including docking station. Recently added hardware and/or applications may cause graphics driver conflict and result in loss of video.
3. Perform hardware reset ([8. Hard reset on page 74](#)) and verify that HP Logo is presented correctly on display screen when pressing **F10**.
4. Test with external monitor via VGA port (or DisplayPort, HDMI, etc). Press power button and close the computer lid to force video output to external video. If unsuccessful, contact HP service.

-
5. If external video is OK, update BIOS, software, and drivers ([4. Update BIOS and drivers on page 66](#)) and perform soft reset ([9. Soft reset \(Default Settings\) on page 75](#)) if needed. Go to next step to verify display.
-

Verify display

- When booting to Windows, determine whether image appears on display screen (via Windows Screen Solutions or [Windows logo](#)  + P for display switcher).
 - If there is video on display, disconnect external display device, open the computer lid and restart.
-

The sections below are intended for authorized service providers/technicians.

1. Verify Power Good lights are on to be sure that system board power is functional.
 2. Reseat display cable connection on system board.
 3. Reseat display cable connection on display panel side.
 4. Examine and reseat major components, such as hard drive, memory.
 5. Test with minimum configuration ([11. Test with minimum configuration on page 76](#)) by removing hard drive to isolate operating system issues and testing video in F10 Setup.
 6. If video is present, restart and retest the computer.
 7. If video is present but bad, go to [Display on page 98](#) section.
 8. If issue persists (no video), test with external video.
 9. If issue persists, test or replace a confirmed working display.
 10. If issue persists, replace discrete graphics card.
 11. If issue persists, replace system board due to defective video function.
-

Tips and tricks

Swipe a metal piece (screwdriver) over wireless/mute buttons to act as if closing lid to force video output to external display device. See the “External component identification – Display” section for location of the magnetic sensor.

Blinking lights

Symptoms

Lights blink on keyboard [caps lock/num lock](#) keys

Possible causes

Blinking lights on startup usually indicate a problem with basic functionality of a critical component (processor, BIOS, graphics cards, memory, etc.) due to loose connection, defective parts, or recently added parts.

Troubleshooting steps

1. Check for any blink patterns. Count the number of blinks in a sequence, followed by a pause for a few seconds.
 2. See Status, Blinking Lights, and Error Message ([7. Status lights, blinking light codes, troubleshooting lights, and POST error messages on page 71](#)) for corrective actions.
 3. If internal hardware components (memory, hard drive, etc.) have been recently added, a component may not be connected properly. Remove and reseat new components ([10. Reseat cables and connections on page 75](#)) one at a time.
-

Note

Since the display may not be functional, lights are used to indicate an error.

Diagnostics error messages

Symptoms

- Computer has power
- POST error message displays (Windows logo has not yet appeared)

Possible causes

Diagnostic error messages indicate a problem. There may be a problem with the instruction being sent from the BIOS to a hardware component (e.g., keyboard failures), or incompatible hardware. Can usually be resolved by installing updated firmware for the component.

Troubleshooting steps

1. See [7. Status lights, blinking light codes, troubleshooting lights, and POST error messages on page 71](#) for corrective actions. An example of a POST error message is shown below.

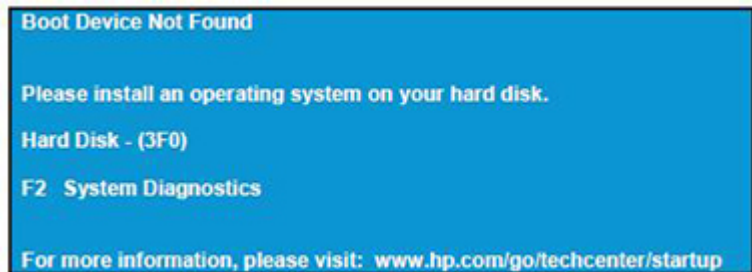

2. If there is power, you may be able to access BIOS. Reset BIOS to its default condition. ([9. Soft reset \(Default Settings\) on page 75](#))
3. Restore hardware to its original condition (i.e., bootable solid-state drive instead of hard drive).
4. Reseat suspected components and verify connection.
5. Test suspected components using HP PC Hardware Diagnostics (UEFI) tool.

Note

An Error Message means the system has finished BIOS hardware validation and is ready to launch the **Startup Menu**. To access the **Startup Menu** for further options, press the **Esc** key while restarting the computer.

BIOS password

| | |
|--|---|
| <i>Symptoms</i> | <i>Possible causes</i> |
| Some sections are unavailable (grayed out) | BIOS administration password is required. |
| | <i>Troubleshooting steps</i> |
| | <ol style="list-style-type: none">1. Review F10 BIOS Setup Overview to determine which features must be enabled.2. Your BIOS settings may be managed by a BIOS administrator password setup.3. If you lost or forgot user password, contact your IT personnel.4. If you lost or forgot administrator password, contact HP service to reset the password. This process requires a unique UUID. |
| Reference | HP F10 Setup Overview HP Business Notebook and Desktop PC F10 setup overview – 2012 and 2013 Business PC models HP Business Notebook and Desktop PC F10 setup overview – 2014 Business PC models 2015 Business PC models – see the BIOS F10 Setup technical white paper at http://support.hp.com , enter your computer model, and then go to Manuals > White papers > HP PC BIOS F10 Setup Guide . |

Performance (OS)

 **NOTE:** Most software problems occur as a result of the following:

- The application was not installed or configured correctly.
- There is insufficient memory available to run the application.
- There is a conflict between applications.

Make sure that all the needed device drivers are installed.

If an operating system other than the factory operating system is installed, check whether the operating system is supported and the application is certified for the version of the operating system.

HP ships and supports Windows 7 with BIOS Legacy boot mode and Windows 8, 10 with BIOS UEFI boot mode. Therefore, HP recommends that you switch BIOS boot mode from Legacy to UEFI Native for clean Windows 8, 10 installations, or to UEFI Hybrid (if available) for upgrading the option from Windows 7 to Windows 8, 10. UEFI Windows 8, 10 avoids many unexpected behaviors (i.e., blue screen error, graphics/video issues) in the BIOS Legacy setting.

Intermittent shutdown

Symptoms

- Shutdown during startup
- Shutdown during operation

Possible causes

It is often difficult to troubleshoot an intermittent issue. Possible causes include the following:

Power-related issue: defective or insufficient power sources, poor connection.

OS Custom Setting: Energy Saver (Power Management).

Thermal-related issue: thermal sensors reach limits.

Hardware related issue: voltage, out-of-range current; electrical short.

Troubleshooting steps

1. Update BIOS and drivers. ([4. Update BIOS and drivers on page 66](#))
 2. Perform hard reset ([8. Hard reset on page 74](#))
 3. Perform soft reset ([9. Soft reset \(Default Settings\) on page 75](#))
-

Power related issue

1. Verify functionality of AC adapter alone. If no functionality, test with a verified working adapter.
 2. Verify battery alone. Verify that battery is not depleted. Test battery using HP PC Hardware Diagnostics (UEFI) tool.
 3. Verify connection of power button, power cable.
-

OS custom settings

1. Advise users to reset power options and close all applications that are not in use, including applications in the background.
 2. Test with a confirmed working operating system to isolate custom settings by users or any conflicting applications that cause shutdown.
-

The sections below are intended for authorized service providers/technicians.

Thermal-related issue

1. Verify thermal condition:
 - a. Test fan using HP PC Hardware Diagnostics (UEFI) tool ([6. HP Hardware Diagnostics and Tools on page 67](#))
 - b. Check fan and connection. Reseat fan cable.
 - c. Be sure that no obstructions or dust are in heat sink fan, fin, or vent.
 - d. Test with a verified working fan.
 - e. Remove old thermal compound and pads and replace with new compound and pads.
 2. Verify thermal solution:
 - Use Thermal Monitor tool (available only to authorized service providers/technicians) to perform stress test (processor and GPU) ([6. HP Hardware Diagnostics and Tools on page 67](#)) and verify that thermal sensors are within limits after thermal condition is serviced.
-

Hardware related issue

1. Check for any signs of loose connections, bent pins, stray wires, dust, nearly faulty parts (bulging/leaking capacitor).

2. Verify that lights are solid.
3. If shutdown is reproducible, test essential hardware configuration:
 - a. If no issue with hardware configuration, reinstall one non essential component at a time to determine faulty hardware.
 - b. If issue persists, replace essential hardware with a confirmed working part, one at a time. If no boot, replace system board.

Tips and tricks

Intermittent issue is difficult to reproduce and troubleshoot. It is important to record details on shutdown frequencies, system configuration (3D video application) and operating conditions.

Blue screen

Symptoms

- Have power, light activity, fan spinning
- HP Logo displays briefly
- Fails to boot into Windows operating system, displays blue screen, and then crashes, restarts, or stops responding

Possible causes

Recent changes: conflict of instructions from multiple programs or just added hardware.

Incompatible hardware and driver.

Poor connection (hard drive, memory).

Hardware malfunctioning due to overheating (GPU, processor).

Defective hardware (memory, hard drive).

Important Notes & Resources

Troubleshooting steps

There are many different ways to troubleshoot a blue screen error. Therefore, you need to identify working configuration (Windows 7/8/10) and specific symptoms of the failure in order to narrow down the issue. Refer to [Blue screen \(BSOD\) error on page 115](#).

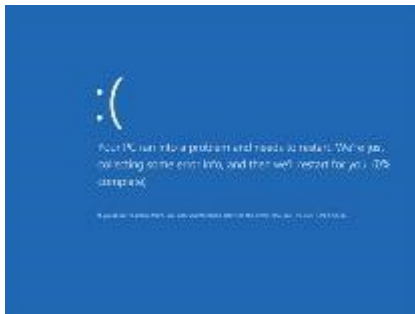

Recommended resources

Microsoft knowledge base:

[Resolving Blue Screen errors in Windows](#)

HP Troubleshooting Error Messages on a blue screen:

[HP Notebook PCs - Troubleshooting Error Messages on a Blue Screen that may Occur During Startup or Boot](#)

Overview of General Troubleshooting Steps for a blue screen error

1. Note the blue screen error message and what activity was performed at the time.
2. Perform a hard reset ([8. Hard reset on page 74](#)) after disconnecting all external peripherals.
3. Reset BIOS to default ([9. Soft reset \(Default Settings\) on page 75](#)) to prevent booting to another device.
4. Run HP Hardware Diagnostics ([6. HP Hardware Diagnostics and Tools on page 67](#)) to isolate major faulty hardware issues.

- HP PC Hardware Diagnostics (UEFI) tool to test hard drive, memory and system.
 - Thermal Monitor (available only to authorized service providers/technicians) tool to monitor temperature limits of processor and GPU. See “HP Thermal Monitor” in [6. HP Hardware Diagnostics and Tools on page 67](#).
5. Remove or undo recently added hardware ([5. Remove or uninstall recently added hardware, software on page 66](#)). For example, incompatible memory or new solid-state drive storage.
 6. Reseat cables and connections ([10. Reseat cables and connections on page 75](#)). Pay attention to proper installation of memory and hard drive.
 7. Verify that a minimum of at least 100 MB of free space is available on your Windows partition.
 8. If you can start Windows:
 - a. Update BIOS and drivers ([4. Update BIOS and drivers on page 66](#)) to support updates for incompatibilities.
 - b. Get all the latest updates, using Windows Update.
 - c. Undo recent changes:
 - Startup using Last Known Good Configuration.
 - Use System Restore.
 - Roll back device driver in Device Manager.
 - d. Check for specific Error Message. See [Common Blue Screen Error Messages on page 126](#).
 - e. Boot to safe mode ([11. Test with minimum configuration on page 76](#)) to troubleshoot issues.
 9. If you cannot start Windows:
 - a. Boot to safe mode. ([11. Test with minimum configuration on page 76](#))
 - b. Use Startup Repair to fix Windows startup files.
 - c. Undo recent changes using System Restore to revert to a previous “working” state.
 - d. Check for specific STOP error by analyzing Crash Dump (retrieved via a bootable USB). See [Use Windows Debugging Tool on page 127](#).
 - e. Restore computer using System Recovery or image backup to factory settings.
 10. Lastly, test with essential hardware configuration ([11. Test with minimum configuration on page 76](#)) along with a verified working operating system (i.e., USB Windows-To-Go), if available, to isolate the software issue.

Tips & tricks

In some cases, the computer may reboot automatically before you have time to read the blue screen.

To identify the error message itself, disable the automatic restart using one of the following methods:

Right-click on **My Computer**, and then select **Properties** > **Advanced**. Under **Startup and Recovery**, select **Settings**. Clear the **Automatically Restart** check box.

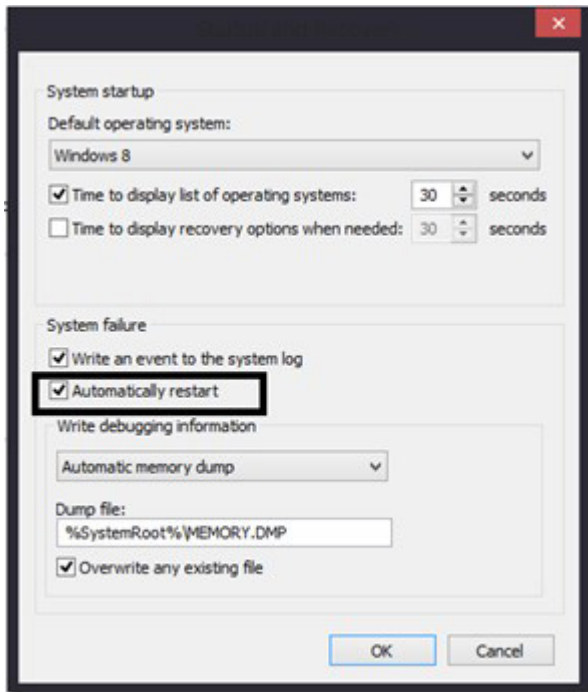

Windows Advanced Boot Option

Windows 7:

1. Press **F8** to open the Windows Advanced Boot Option screen.
2. Select **Disable automatic restart on system failure** to view error messages.

Windows 8:

1. Press **F11** (System Recovery) to open the Windows Advanced Boot Option screen.
2. Select **Startup Settings** to view error messages.

Freeze at Windows Logo (hang/lockup)

| <i>Symptoms</i> | <i>Possible causes</i> |
|---|--|
| <ul style="list-style-type: none"> • Has power, light activity, fan spinning • HP Logo displays briefly • Attempt to boot to operating system and freeze/hang at Windows logo • No response to pressing num lock or caps lock key | <p>Conflict of instructions from multiple programs or drivers; installing a new hardware or program that is not compatible (may also cause a blue screen error—see blue screen issue).</p> |

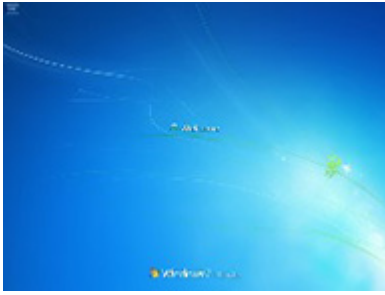

Troubleshooting steps

Follow suggested steps below one at a time to verify normal boot process:

1. Disconnect all external peripherals, and perform a hard reset ([8. Hard reset on page 74](#)).
2. Perform soft reset ([9. Soft reset \(Default Settings\) on page 75](#)).
3. Update BIOS and drivers ([4. Update BIOS and drivers on page 66](#)).
 - a. Roll back to previous version may be necessary.
 - b. Go to safe mode to install drivers.
4. Run Hardware Diagnostics ([6. HP Hardware Diagnostics and Tools on page 67](#)) to isolate hardware issue.
5. Undo recent changes in Windows ([5. Remove or uninstall recently added hardware, software on page 66](#)).
6. Reseat cables and connections ([10. Reseat cables and connections on page 75](#)).
7. Start Windows in safe mode ([11. Test with minimum configuration on page 76](#)).
8. Use Startup Repair Windows to fix Windows damaged files.
9. Test with essential hardware configuration ([11. Test with minimum configuration on page 76](#)) along with a verified working operating system (i.e., USB Windows-To-Go) if available to isolate the software issue.

Tips and tricks

For more information, see [HP PCs - Using Task Manager \(Windows 10, 8\)](#).

Electromagnetic Interference (EMI)

Symptoms

System locks up, freezes in certain physical area or location

Possible causes

Electromagnetic interference (EMI).

Troubleshooting steps

1. See ([2. Examine the environment on page 65](#)). Pay attention to external power source, high-frequency signals such as cell phones, microwave ovens.
2. Move the computer to different locations nearby to determine where it fails and where it does not fail.
3. Test with a verified working computer in original factory configuration.
4. Consult with support.

No wake up

Symptoms

When resuming from a power management state the computer may display:

- Blank screen
- Some light activity

Possible causes

Power-saving mode; multiple-display setting.

Troubleshooting steps

1. Verify that front power light ([7. Status lights, blinking light codes, troubleshooting lights, and POST error messages on page 71](#)) is blinking (indicating Sleep state). Press power button to exit Sleep.
2. Reset BIOS to default (associated with **OS Power Management in Power Menu**) ([4. Update BIOS and drivers on page 66](#))
3. Verify power management settings in Windows **Power Options**. Disable Sleep options if the issue is resolved.

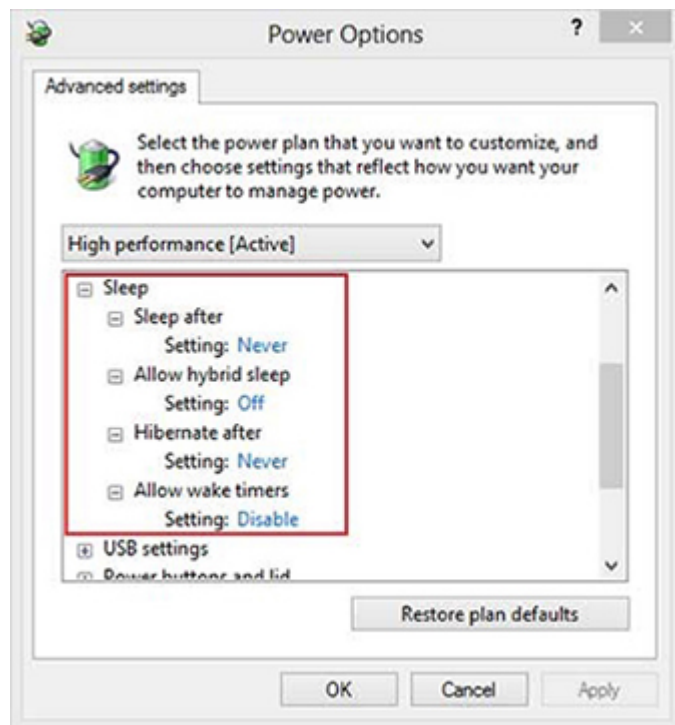

4. Screen saver is set. Press any key or touch TouchPad to resume.
5. Verify that Display Choice is set to external video only. Toggle screen control key combination **Fn + F4** or **Windows logo**  **+P**.

Tips and tricks

If you are using a docking station, set your notebook display as a primary display. When the computer is undocked, you may think it is in a power-saving state, but the screen image may actually display on an external display device in the docking configuration.

Unresponsive

| <i>Symptom</i> | <i>Possible causes</i> |
|----------------|------------------------|
|----------------|------------------------|

| | |
|--------------|--|
| Unresponsive | Program in use has stopped responding to commands. |
|--------------|--|

| <i>Troubleshooting steps</i> | |
|------------------------------|--|
|------------------------------|--|

- | | |
|--|--|
| <ol style="list-style-type: none">1. If possible, use the Windows Task Manager to isolate and terminate the offending process.2. Attempt the normal Windows shutdown procedure.3. Restart the computer using the power button. | |
|--|--|
-

Slow performance

| <i>Symptom</i> | <i>Possible causes</i> |
|----------------|------------------------|
|----------------|------------------------|

| | |
|--|---|
| Slow performance when performing small tasks, or even in idle mode | Processor is hot or hard drive is full. |
|--|---|

| <i>Troubleshooting steps</i> | |
|------------------------------|--|
|------------------------------|--|

| | |
|-------------------------|--|
| Processor is hot | |
|-------------------------|--|

- | | |
|--|--|
| <ol style="list-style-type: none">1. Verify that airflow to the computer is not blocked.2. Verify that chassis fans are connected and working properly. Some fans operate only when needed.3. Verify that the processor heat sink is installed properly. | |
|--|--|
-

| | |
|---------------------------|--|
| Hard drive is full | |
|---------------------------|--|

- | | |
|--|--|
| <ol style="list-style-type: none">1. Transfer data from the hard drive to create more space on the hard drive. Microsoft recommends at least 200 MB to sync system files.2. Perform disk defragmentation to consolidate fragmented data on the hard drive so it will work more efficiently. | |
|--|--|

Also see [Slow performance on page 115](#).

| | |
|------------------------|--|
| Tips and tricks | See Improving System Performance (see Routine Maintenance for Performance Improvement on page 126). |
|------------------------|--|

See [Tips to free up drive space on your PC](#).

See [Optimize Windows for better performance](#).

HP Smart Adapter warning message

Symptom

Warning message displayed in Window



Possible causes

Less powerful AC adapter, BIOS out of date.

Troubleshooting steps

1. Update BIOS that may contain a table that assigns an appropriate adapter for a certain configuration.
2. Update the latest **HP Hotkey Support** software from Drivers website.
3. Verify sufficient power source (where adapter is connected).
4. Use appropriate AC adapter (often supplied with system) for optimum system performance.
5. Test with a verified working AC adapter.
6. Test the adapter on a verified working computer.
7. Contact HP for configuration details.

Note

HP Smart AC adapter warning message: informs you that as power demands increase, the notebook may not perform at full capacity, which may result in longer battery-charging time. In cases of extreme power demands, the system may also throttle back the processor, or with systems that have a discrete video sub-system, a video balance mode may occur to further balance the power needs of the system.

System processor functions always have priority over battery charging, so charging delays will occur first.

Incorrect time and date

Symptom

Incorrect date and time

Possible cause

Real-time clock (RTC) battery might need replacement.

Troubleshooting steps

1. Reset the date and time in the operating system Control Panel.
2. Replace the RTC battery.
3. Verify that date and time are correct.

Display

Display anomalies

The display panel is a field replaceable unit (FRU) and must be replaced by only authorized technicians. However, HP highly recommends that users and technicians observe specific symptom vs. generic symptoms and utilize the HP PC Hardware Diagnostics (UEFI) tool before any replacement.

Symptom

Common display issues with symptoms:

- Blank/black video
- Incorrect/missing color/distorted image
- Flickering image
- Vertical lines (due to LDVS, decreased signal integrity, and data loss)
- Dead pixel (due to display liquid, internal transistor, etc.)
- Horizontal lines (due to video memory)
- Distorted when hot (due to thermal issue)
- Cracked screen/image (physical damage)
- Light leakage/bleeding

Contact support for assistance.

- Humming noise (due to frequency settings)

Contact support for assistance.



Cracked screen

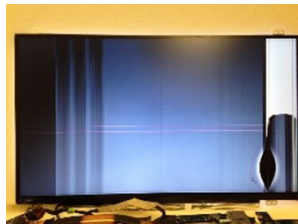

Cracked image

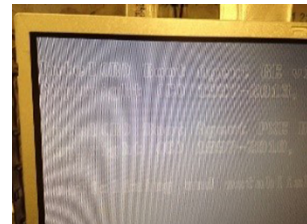

Blurred image

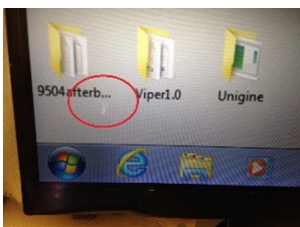

Dead pixel

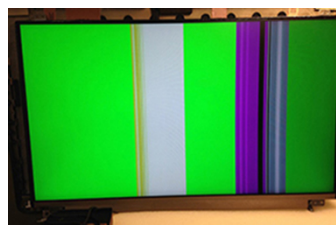

Vertical lines



Horizontal lines

Quick check

- Visually examine the display for cracked screen, liquid crystal leak, dirty spots on glass, etc.
- Reset and update BIOS and docking firmware.
- Update operating system (OS), graphics/video drivers (Intel/AMD/NVidia, etc).
For custom images, HP highly recommends upgrading or installing Windows in UEFI mode (or Legacy disabled) to fully support hybrid graphics and avoid unexpected behaviors (i.e., blue screen error, graphics/video issues) in the BIOS Legacy setting.
- Configure Windows settings (Power options, Screen brightness, Personalization, Screen resolution, etc.).
- Test with a verified working external display.
- Boot to Windows in safe mode.
- Test with a verified working operating system (i.e., shipping image).

HP PC Hardware Diagnostics (UEFI) for video test

Use this tool to quickly determine if the display issue is related to a real hardware issue.

To start HP PC Hardware Diagnostics (UEFI) ([6. HP Hardware Diagnostics and Tools on page 67](#)), when the computer is at boot, press the **F2** key, select **Component Tests**, and then select **Video**.

There are three options:

- **Video Memory Check:** to test video memory
- **Palette Check:** to test the three video color components (red, green, blue)
- **Dead Pixel Check:** to check dead pixels in eight different colors (Dead Pixel Check is available with the “HP PC Diagnostics 3-in-1 USB Key” tool)

Review the video troubleshooting in the Display section below for specific issues and possible solutions. For additional information about display problems, refer to documentation provided by the product manufacturer.

Display assembly diagram

The display assembly diagram shows basic video components: system board, graphics cards, display cables, display connectors, operating system (OS), graphics driver, and LCD display panel. Any component or a combination of these components can contribute to a video issue.

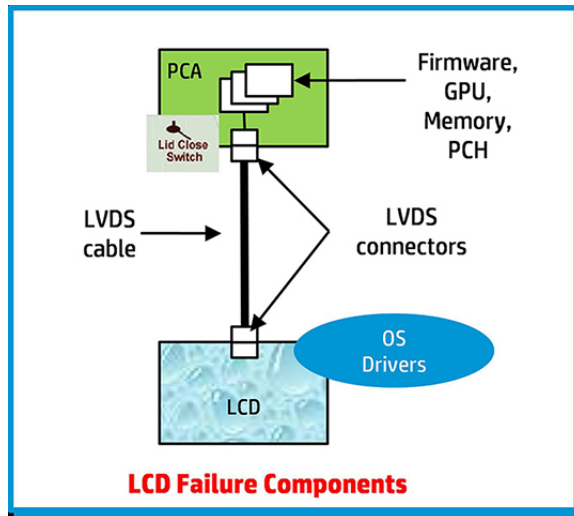

NOTE: The lid close switch is a Hall-effect sensor located in the top cover. When the display is closed, the sensor acts like a switch is closed. A notebook can force a video output to an external monitor, or go to hibernation or standby mode through power management. If the display screen does not light up when the display is open, the lid close switch (Hall-effect sensor) could be faulty.

Dead pixel

Display panel may show one or more pixels that are not properly lit when displaying a single color over the screen area. Use HP PC Hardware Diagnostics (UEFI) tool to determine those defective pixels. There is no solution for dead pixels. Refer to [Display Issue: Pixel Anomalies on page 132](#) for the HP dead pixel policy.

No video (internal)

Symptoms

No internal video with certain programs (i.e., video-intensive games)

Possible causes

Display resolution, brightness, faulty lid switch, running a program requiring a higher resolution than the display screen can support..

Faulty lid switch may put the system into Sleep or Hibernation mode.

Troubleshooting steps

Use an external monitor with higher resolution.

Test with external monitor using HDMI or HP port. Press the power button and close the computer lid to force video output to external video. If there is still no video, contact support.

References

See section [No video \(with power\) on page 86](#) for display information.

No video (external)

| <i>Symptom</i> | <i>Possible causes</i> |
|------------------------------|---|
| No image on external monitor | External monitor, resolution, display configuration, drivers. |
| | <i>Troubleshooting steps</i> |
| | <ol style="list-style-type: none">1. Be sure external monitor is compatible with the computer.2. Be sure that external monitor is turned on.3. Press any key to get out power saving mode.4. Adjust the brightness of the monitor.5. Test with a verified working monitor.6. Test the monitor via internal ports (VGA, DP ports).7. Install latest video driver.8. Reset the screen resolution as described in the documentation.9. Configure display choice, and then force output to external video by closing the notebook lid or pressing Fn + F4 to switch screen output. |

DisplayPort/VGA

See [No video \(external\) on page 101](#).

HDMI

| <i>Symptoms</i> | <i>Possible causes</i> |
|---|---|
| <ul style="list-style-type: none">• Display issue• Sound issue | Cable, connection, settings. |
| | <i>Troubleshooting steps</i> |
| | Quick Check |
| | <ol style="list-style-type: none">1. Verify HDMI device input source is set correctly (i.e., HDMI1).2. Be sure you are using the correct HDMI cable.3. Check connection and reconnect the HDMI cable.4. Verify if sound output is configured correctly in Control Panel > Sound Manager. |
| | <ol style="list-style-type: none">1. Perform hard reset (4. Update BIOS and drivers on page 66).2. Update BIOS and drivers (4. Update BIOS and drivers on page 66) when sound is heard but no video on HDTV. |
| References | HP Notebook PCs - Troubleshooting HDMI Display and Sound Issues |

No or bad external video via docking

| <i>Symptoms</i> | <i>Possible causes</i> |
|--|--|
| No or bad image on external monitor via ports of docking station (VGA, DP, TB, display port, etc.) | Rooted from system board, software/drivers, dock connectors, docking station hardware/firmware, dock video ports (DP, VGA, etc). |
| | <i>Troubleshooting steps</i> <ol style="list-style-type: none">1. Be sure that external monitor is powered on.2. Be sure that external monitor is compatible with the computer.3. If applicable, plug the dock in different Type-C ports. For more information, see the technical white paper titled "HP ZBook 65/150/200 W Thunderbolt 3 Dock User Guide." Go to http://support.hp.com/, enter your model number, and then click Manuals > Technical white papers.4. If the screen image is distorted, try a DP-to-VGA adapter. Connect the adapter to each DisplayPort and VGA port of the dock.5. Test the monitor via internal ports (VGA, DP, HDMI, etc.).6. Verify that dock connectors of the notebook and the dock are clean, without dust, debris (e.g., using air duster).7. Ideally, use a verified working operating system/system connected to the dock to isolate the issue of the current operating system.8. Ideally, use a verified working docking station to isolate the faulty dock.9. Update latest dock firmware. Be sure to follow the installation instructions carefully. You may want to try a DP-to-VGA adapter if you have a distorted screen image. Connect the adapter to each DisplayPort of the dock. If you still cannot update the dock, attempt to update it on a confirmed working notebook before having the dock replaced. |
| Note | See the technical white paper titled "Multiple displays on HP ZBook Mobile Workstations" from HP platform support website. Go to http://support.hp.com/ , enter your model number, and then click Manuals > Technical white papers . |

Incorrect or missing color/distorted image

| <i>Symptoms</i> | <i>Possible causes</i> |
|--|--|
| System works normally but the display shows: <ul style="list-style-type: none">• Missing or strange color• Image distortion | Loose connection, display cable, display, graphics card. |
| | <i>Troubleshooting steps</i> <p>Verify with external monitor (i.e., VGA)</p> <ol style="list-style-type: none">1. Use combination Fn + F4 to enable output to external monitor.2. Close the lid. <p>If the external monitor also shows incorrect color, it is graphics card issue. Test with a verified working graphics card.</p> <p>Verify display cable and cable connection—Display disassembly is required.</p> <p>Be sure that external display cables are not pinched or damaged.</p> |

Be sure that external display cables have good connection at both ends (system board and display panel).

- If moving cables affects the image, it is display cable. Test with a confirmed working cable.
 - If moving cables does not affect the image, is display issue. Test with a confirmed working display
-

Touch screen

Symptoms

Unresponsive

Inaccurate

Possible causes

Dirt and smudge, driver, touch display configuration, power management.

Troubleshooting steps

Quick check

Turn off the computer, spray glass cleaner onto a soft, damp cloth, and gently wipe the screen to remove dirt and smudge.

NOTE: Do not spray cleaner directly onto the screen.

Configure the touch display in **Control Panel > Tablet PC Settings**

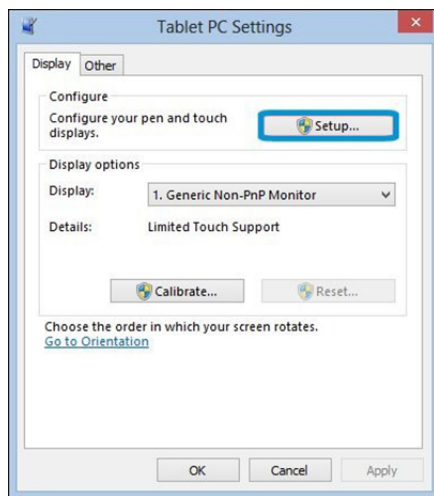

1. Restart the computer.
2. Verify touch screen and graphics drivers.
3. Configure the touch display to identify the screen as a touch screen as shown in the image at left.
4. Calibrate the screen and reset if touch functionality is still not working correctly.
5. Perform diagnostic test in HP Hardware Diagnostics under **Component Tests > Touch Screen**.

If the diagnostics tests pass but the touch screen still does not respond, continue following the steps.

6. Adjust the power management settings for your touch screen.

If the touch screen stops working after waking from sleep, adjust the power management settings so that the touch screen device stays active while the computer is in sleep mode.

7. Perform Microsoft System Restore and restore to a time when the system was working.
8. Perform HP System Recovery if none of the above actions resolves the issue.

References

[HP Notebook PCs - Touch Screen Issues \(Windows 10\)](#)

[HP Notebook PCs - Touch Screen Issues \(Windows 8\)](#)

I/O devices



NOTE:

- Make sure external devices are supported and compliant (i.e., USB Type C, Thunderbolt 3, PCI Express, etc).
- If you have problems with external devices not provided by HP, contact device manufacturers for compatibility and latest drivers prior to troubleshooting (i.e., USB devices, Thunderbolt devices, PCI Express Card reader, VGA/Display/HDMI monitors, Speakers, etc).
- Be sure I/O devices are properly inserted into the I/O ports, and then be sure the I/O devices are recognized by Windows Device Manager.

Keyboard

Symptoms

Keystrokes not recognized
Characters not matched

Possible causes

Dust trapped under keycap, loose keycap, loose keyboard connection, defective keyboard.

Troubleshooting steps

1. Inspect the keyboard for any signs of dust, liquid, or debris trapped under sticky keys that might prevent keystroke recognition.
2. Check for incomplete connection between keyboard and system board by verifying that [caps lock](#) or [num lock](#) light turns on when key is pressed.
3. Verify whether the keyboard is recognized in Windows Device Manager and verify whether the keyboard driver is installed properly.
4. Test with a working external keyboard (i.e., USB keyboard).

Also test in Windows for special keys ([Caps Lock](#), [Shift](#), [Ctrl](#), [Fn](#), [Windows](#), [Alt](#)) if necessary.
5. Test with HP PC Hardware Diagnostics (UEFI) to isolate a hardware issue from a software issue.
6. Verify that BIOS is up to date. If so, resetting BIOS to default may help.
7. Test with verified working operating system or restore operating system to be sure that the issue is not caused by different language settings, sticky keys feature, etc.
8. Verify that keyboard flex cables are fully inserted and in good condition.

The sections below are intended for authorized service providers/technicians.

1. Verify if keyboard flex cable is in good condition (no delamination or torn cable end, no missing or cracked tracks, pads).
2. Verify keyboard flex cable ends are fully inserted and aligned with connectors on system board, and those connector tabs are properly closed. Reseat cables.
3. Replace new internal keyboard and retest.

Tips and tricks

A key only works when pressed with force. Inspect and remove debris trapped under keycap.

Keyboard point stick

| <i>Symptom</i> | <i>Possible causes</i> |
|---|--|
| Point stick not working properly | Dust trapped under point stick, loose point stick cap. |
| <i>Troubleshooting steps</i> | |
| <ol style="list-style-type: none">1. Inspect any signs of dust, liquid spill that prevent point stick from working.2. Check whether point stick cap is loose and reseal it if necessary. | |

The sections below are intended for authorized service providers/technicians.

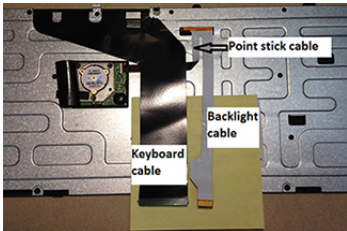

1. Verify whether keyboard flex cables are in good condition (no delamination or torn cable end, no missing or cracked tracks, pads).
2. Verify keyboard flex cable ends are fully inserted and aligned with connectors on system board and back of keyboard and that connector tabs are properly closed.
3. Reseat point stick cables.

Example of back of keyboard, including keyboard, point stick, and backlight cables.

Keyboard backlight

| <i>Symptom</i> | <i>Possible causes</i> |
|--|---------------------------------------|
| Backlight function not working properly | Backlight disabled, loose connection. |
| <i>Troubleshooting steps</i> | |
| NOTE: Not all notebook computers have backlit keyboards. A keyboard function key lets you turn the light on and off. Verify if backlit feature is not disabled by pressing a combination of Fn + Backlit key. | |

The sections below are intended for authorized service providers/technicians.

1. Verify if backlight flex cables are in good condition (no delamination or torn cable end, no missing or cracked tracks, pads).
 2. Verify backlight flex cable ends are fully inserted and aligned with connectors on system board and that connector tabs are properly closed.
 3. Reseat backlight cable.
-

TouchPad

Symptoms

Not working properly

Possible causes

On/Off enabled, driver, settings.

(1) – Touchpad on/off button

(2) – Touchpad

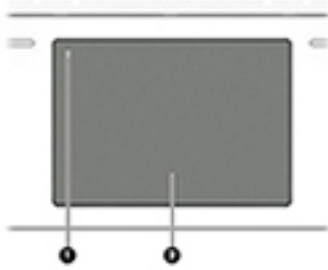

Troubleshooting steps

1. Ensure touchpad On/Off light is not amber (disabled). Double touch to enable.
2. Verify if touchpad device is listed in **Device Manager > Mice and other pointing devices**.
3. Install the latest touchpad driver.
4. Adjust touchpad settings (**Control Panel > Mouse**).
5. Test touchpad controller using the HP PC Hardware Diagnostics (UEFI) tool (**F2 > Component Tests > Mouse Test > Pointer Test & Drag and Drop Test**).

The sections below are intended for authorized service providers/technicians.

1. Check the touchpad cable for damage or a loose connection, and then reseat the touchpad cable.
2. If issue persists, replace the touchpad and verify the change.

Network Connectivity Ethernet (RJ-45 jack)

Symptoms

- Unable to find networks (yellow bang)
- Connection dropouts
- Slow performance

Possible causes

Network source, cable, connection, RJ-45 port, driver, settings.

Troubleshooting steps

Quick Check: verify the network status lights that supposed to flash when there is network activity.

HP Support Assistant tool - No network detected in HPSA



1. Turn off the computer's wireless feature (press wireless button).
2. Verify that networking source with recommended distance to the base is less than 300 feet.
3. Examine the Ethernet cable for damage. Test with a verified working cable.
4. Test with different networks and jacks and check with IT for hardware compatibility settings.
5. Connect a verified working RJ-45 cable directly to the computer to isolate other related issues (e.g., router, switch, docking station).
6. Verify Ethernet port lights (RJ-45):
 - Green (left): network is connected.
 - Amber (right): network is showing activity.

7. Test with HP Support Assistant in Windows.
8. Diagnose with HP PC Hardware Diagnostics (UEFI) to isolate a hardware issue from a software issue.
9. Examine Ethernet ports on the computer, docking station, and wall for damage, dust, obstructions.
10. **Update drivers:** Verify that Ethernet module is displayed in Device Manager and be sure that device driver is up to date. If updating drivers does not help, try rolling back to previous drivers.
11. **Reset BIOS to Default:** If other devices can connect to network, but computer cannot connect, a BIOS setting might be the cause of the problem. Restore BIOS to default.
12. Test with verified working operating system or perform operating system recovery to verify that the issue is not caused by customized settings.
13. Replace system board and verify that the issue is fixed.

Network connectivity wireless (WLAN)

Symptoms

- Unable to find networks (yellow bang)
- Connection dropouts
- Slow performance

Possible causes

Network source, cable, connection, wireless module, driver, settings.

HP Support Assistant tool - No network detected in HPSA



Wireless Adapter Properties - U-APSD support

Troubleshooting steps

1. Turn off the computer's wired network (remove RJ-45 cable).
2. Examine environment for interference, such as cell phone or microwave, that may emit high frequencies (above 1 GHz).
3. Verify wireless source by moving computer closer to the wireless base/router.
4. Test with different wireless networks and check with your IT department for hardware compatibility, settings.
5. Verify that the wireless light is on. If the light is amber, press the wireless button to enable the wireless device.
6. Test with HP Support Assistant in Windows.
7. Diagnose with HP PC Hardware Diagnostics (UEFI) to isolate a hardware issue from a software issue.
8. **Update drivers:** Verify that wireless module is displayed in Device Manager and be sure that wireless drivers are up to date using www.hp.com or HP Support Assistant. If updating drivers does not help, try rolling back to previous drivers.
9. **Reset BIOS to Default:** If other devices can connect to your wireless network, but your computer cannot connect, a BIOS setting might be the cause of the problem. Restore BIOS to default.
10. Configure power management advanced settings as necessary.

In the example to the left, **U-APSD support** (Unscheduled Automatic Power Save Delivery) is changed to **Disabled** to resolve an incompatible access

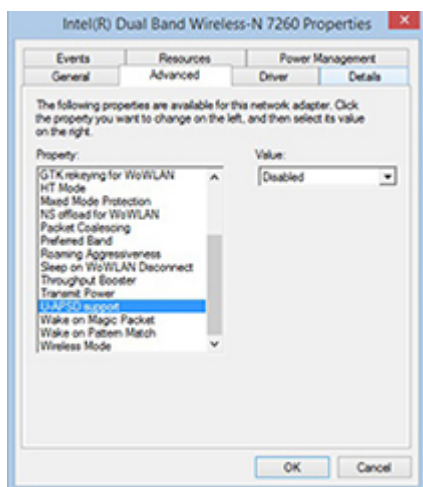

point. If disabling U-APSD improves the throughput issue, check with the access point provider for updated firmware that resolves the issue.

11. Test with verified working operating system or perform operating system recovery to verify that the issue is not caused by customized settings.
12. Test with a verified working wireless module.

The sections below are intended for authorized service providers/technicians.

1. Verify that the wireless module and its antenna cables are fully inserted and in good condition (see WLAN module removal and replacement section). Reseat wireless module and antenna connection.
2. Verify module antenna cable connection are not loose.
3. Verify antenna cables are properly connected to the MAIN and AUX terminals (see WLAN module removal and replacement section).

WWAN

| Symptom | Possible causes |
|---------------------------------|---|
| Unable to find networks/service | Network source, cable, connection, driver, settings. |
| | <i>Troubleshooting steps</i> |
| | <ol style="list-style-type: none"> 1. Update to the latest driver and utility. 2. Check with network service provider for signal coverage. 3. Make sure signal strength is good. 4. Make sure your service is active. |

The sections below are intended for authorized service providers/technicians.

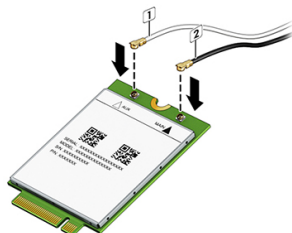

- Verify module and antenna cable connections are not loose.
- Verify antenna cables are properly connected to the correct terminals. For example, the antenna cable labeled “1” connects to the “Main” terminal labeled “1”. The antenna cable labeled “2” connects to the “Aux” terminal labeled “2”.

Symptoms

- USB devices are not recognized
- USB devices are not charging

Possible causes

USB devices do not have the latest software drivers, port insufficient power, or not compliant.

NOTE: USB Type-C uses a different connector entirely

Examples of USB device Not Recognized

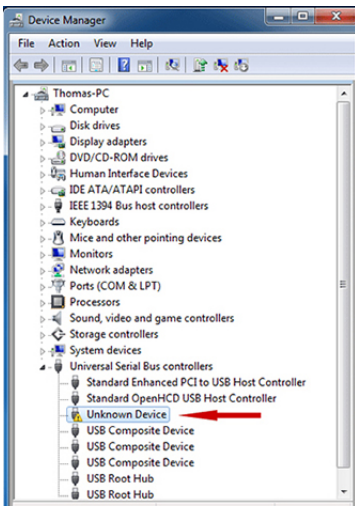
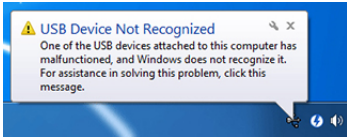

Troubleshooting steps

1. Unplug USB device and/or restart the computer (wait for 2-5 minutes) to reset USB port/hub in case of power surge.
2. Soft Reset ([9. Soft reset \(Default Settings\) on page 75](#)) and verify if USB device is recognized.
3. Verify if USB device is recognized in **Device Manager > Universal Serial Bus Controller**, or USB is recognized without Yellow bang.
4. Verify if the latest USB driver or/and USB chipset driver are installed. USB driver could be removed and reinstalled.
5. Make sure USB device is supported, for example, USB 3.0 device requires more power drawn (0.9A) from USB port than USB 2.0 device (0.5A). As a result, identify USB charging port to be used for charging a USB device, or an external AC power adapter may be required for an external USB storage to work properly.
6. Test with verified working USB devices (keyboard, mouse, USB key) to make sure USB ports are functional.
7. Test USB device on a verified working computer to make sure USB device is not malfunctioning.

Smart card reader

Symptoms

- Not recognized
- Unable to write

Possible causes

Physical damage, incorrect insertion, dirt, driver, malfunctioning card reader.

NOTE: Some cards have a read/write security switch on the card. Make sure that switch is set to “write enabled” before attempting to write data to it.

Card Reader Removal Policy

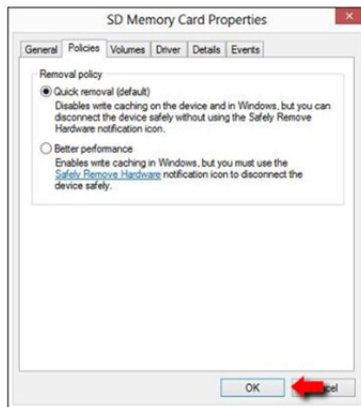

Troubleshooting steps

1. Verify card reader removal policy.
2. Make sure there is no physical damage to the card.
3. Inspect the ends of the memory cards for dirt or material closing a hole or spoiling a metal contact. Clean the contacts with a lint-free cloth and small amounts of isopropyl alcohol. Replace the memory card if necessary.
4. Reinstall and update the drivers for the card reader.
5. Make sure the smart card reader is compliant with ISO 7816 Class A, B, and C.
6. Reinsert the card reader with correct face as described in its documentation.
7. Check reader function with a verified working card.

CAUTION: If the card reader has an in-use indicator light, do not insert or remove memory cards while the light is flashing. Doing so may cause loss of data on the card or may permanently damage the card reader.

Speaker, headphone - audio issues

| <i>Symptoms</i> | <i>Possible causes</i> |
|---|--|
| <ul style="list-style-type: none">• No sound from external or internal speakers• Distorted sound, too soft, too loud, intermittent | <p>Volume turned down, sound card not recognized, malfunctioning hardware, electronic interference.</p> |
| | <p><i>Troubleshooting steps</i></p> <ol style="list-style-type: none">1. Remove any device connected to the Audio jack to enable the internal speaker.2. Close all open programs.3. Adjust volume by pressing Fn + F6/F7. Be sure that volume button light is not amber (mute). - or - Adjust Windows volume control by clicking the speaker icon on the Windows taskbar. Be sure that the sound is not muted.4. Verify that sound card is detected in Windows Device Manager.5. Reinstall the latest audio driver.6. Test audio device using HP PC Hardware Diagnostics (UEFI) tool (F2 > Component Tests > Audio).7. Test with a verified working operating system. If issue is resolved, restore full operating system.8. Test with verified working external speakers or headset.9. Reseat internal speaker connections.10. Test with verified working internal speakers.11. Replace internal speakers. |
| No sound from headphones | <ol style="list-style-type: none">1. Adjust volume by pressing Fn + F6/F7. Be sure that volume button light is not amber (mute). Or adjust Windows volume control by clicking the speaker icon on the Windows taskbar. Be sure that the sound it not muted.2. Check headphone cable connection.3. Test with a verified working audio board.4. Replace audio board and verify the change. |
| No sound from external speakers | <ol style="list-style-type: none">1. Verify that external speakers are turned on.2. Disconnect headphones from headphone jack.3. Adjust volume by pressing Fn + F6/F7. Be sure that volume button light is not amber (mute). - or - Adjust Windows volume control by clicking the speaker icon on the Windows taskbar. Be sure that the sound is not muted.4. Check for possible interference devices nearby that may impact the audio (cell phone or portable communications handset.) |

Thunderbolt (TB)

| | |
|--------------------------------|-----------------------------------|
| <i>Symptom</i> | <i>Possible causes</i> |
| Thunderbolt device not working | BIOS, drivers, and user settings. |

Troubleshooting steps

1. Update to the latest BIOS and choose appropriate TB Port settings.
2. Reset **User Account Settings** to default.
3. Update Intel Thunderbolt software that includes firmware version (for TB controller), driver version (operating system driver), and application version.

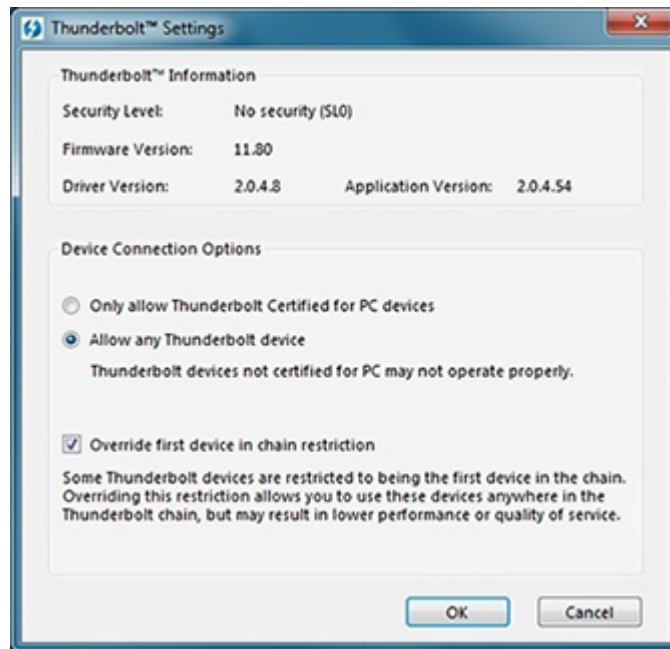

4. Verify that TB device is detected in Windows Device Manager.
5. Verify TB port, cable and connection.
6. Test with a verified working TB board, if possible.

NOTE: Thunderbolt is new technology. Thunderbolt cable and Thunderbolt device must be compatible with Windows. To determine whether your device is Thunderbolt Certified for Windows, see <https://thunderbolttechnology.net/products>.

Storage



NOTE:

- Back up all critical data prior to drive troubleshooting.
- Prior to contacting support, HP recommends that you run a drive (HDD, SSD, M.2 drive) test using the HP PC Hardware Diagnostics (UEFI) tool on the suspected failed drive.
- Diagnose the hard drive using BIOS, Diagnostics built in the shipping image, or an external USB ([HP PC Diagnostics 3-in-1 USB Key](#)).
- The drive quick test is recommended to quickly (less than 10 minutes) identify the malfunctioning drive. If the issue still exists, run Extensive Test (more than 2 hours, or loop mode, which will run until an error occurs).
- If any test fails, record failure code and contact support for instructions on how to order a replacement hard drive.
- If all of the tests pass, the hard drive is not damaged. As a rule, HP will not replace a hard drive under warranty that does not fail the HP Hard Drive Self-Test.
- If there is no physical problem with the hard drive (or memory), then try reinstalling the Windows operating system to troubleshoot the problem.

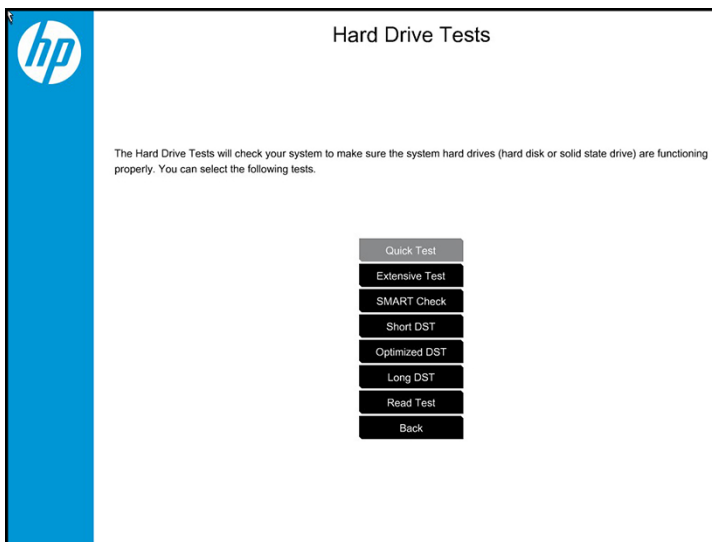

Hard drive/solid-state drive not recognized

| <i>Symptom</i> | <i>Possible causes</i> |
|--|--|
| Hard drive is not recognized during POST | Loose connection, faulty hard drive, faulty drive configuration/BIOS setting. |
| | <i>Troubleshooting steps</i> |
| | <ol style="list-style-type: none">1. Perform a hard reset (8. Hard reset on page 74).2. Reset BIOS to default.3. Verify hard drive connection and flex cable. Reseat hard drive and cable connection. For multiple storage devices, keep the primary drive with the operating system and remove other devices.4. Use the HP Hardware Diagnostics tool to verify the drive is recognized and test it.5. If the hard drive fails diagnostics, record failure and have the drive replaced.6. Identify when the issue is related to software. If the hard drive passes diagnostics, test the drive on a verified working computer. If the failure follows the drive, reinstall the operating system to make sure software is not an issue.7. Test with a verified working hard drive. If it is still not recognized, the system board is faulty. |
| | NOTE: If the drive is seen in BIOS and Diagnostics, try a secure erase prior to replacing a drive as this may resolve related issues. |

No boot to operating system (no read/write error)

| <i>Symptoms</i> | <i>Possible causes</i> |
|---|--|
| <ul style="list-style-type: none">• Post error message: Boot Device not found (3F0)• Hang when booting to operating system | Operating system, loose connection, faulty hard drive, BIOS configuration, Secure Boot. |
| | <i>Troubleshooting steps</i> |
| | <ol style="list-style-type: none">1. Verify if Secure Boot is enabled in BIOS. Secure Boot prevents legacy boot devices from starting the computer, including bootable CDs and DVDs. For more information, see HP PCs - Secure Boot (Windows 8).2. Reset BIOS to default. Be sure that BIOS Boot Mode in Boot Option is set up properly for bootable device and its operating system (i.e., UEFI Native for Windows 8). Another example, choosing Legacy Boot Order for an UEFI device will cause "Boot Device not found (3F0)" error.3. Verify hard drive connection and flex cable. Reseat connection. For multiple storage devices, keep the primary drive with the operating system and remove other devices.4. Use PC Hardware Diagnostics tool to test. Record failure code and have the hard drive replaced.5. If there is no error, reinstall the operating system using HP Restore.6. Test with a verified working operating system hard drive, if available. |
| Note | If there is a hard drive POST error message, see POST Error Messages and User Actions on page 124 . |

Read-write error

| | |
|---|--|
| <i>Symptoms</i> | <i>Possible causes</i> |
| <ul style="list-style-type: none">• Post error message (i.e., error code 301)• Hang when working on data, files, documents | Loose connection, faulty hardware. |
| | <i>Troubleshooting steps</i> |
| | <ol style="list-style-type: none">1. Perform a hard reset (8. Hard reset on page 74).2. Reset BIOS to default (9. Soft reset (Default Settings) on page 75).3. Verify drive connection and flex cable. Reseat connection (10. Reseat cables and connections on page 75).4. Use the HP Hardware Diagnostics tool to test. If failed, record failure code and have the hard drive replaced.5. If no error with HP PC Hardware Diagnostics (UEFI) tool, try to repair the hard drive and its files in Windows (using command <code>CHKDSK /f /r /x</code>). Use HP Restore to reinstall the operating system, if needed.6. Test with a verified working hard drive. If it is not recognized, the system board is faulty. |
| Note | If there is a hard drive POST error message, see POST Error Messages and User Actions on page 124 . |

Slow performance

| | |
|---|--|
| <i>Symptoms</i> | <i>Possible causes</i> |
| Slow performance even when performing small read/write operations | Operating system files, hard drive is full. |
| | <i>Troubleshooting steps</i> |
| | <ol style="list-style-type: none">1. Transfer data from the hard drive to create more space. Microsoft recommends at least 200 MB to sync system files.2. Perform disk defragmentation to consolidate fragmented data on the hard drive so it will work more efficiently. <p>NOTE: Do not defrag an SSD.</p> |
| Tips & tricks | For optimal system performance, you need to place your operating system and all of your most commonly used applications and files in the fastest hard drive (solid-state drive) and fastest areas on the drive (primary partition of 200 GB max). |
| | See Improving System Performance . Also see Routine Maintenance for Performance Improvement on page 126 . |

Blue screen (BSOD) error

Faulty hard drive may cause blue screen error. Perform the drive tests using the HP Diagnostics Tool to make sure the drive is functional. If all of the tests pass, see [Common Blue Screen Error Messages on page 126](#) for detailed troubleshooting steps.

Noisy hard drive



IMPORTANT: An SSD has no moving parts, so it does not make loud or clicking noise.

Depending on type and rotational speed, some hard drives will make more noise than others.

Not all noises are related to the fan or hard drive.

| <i>Symptoms</i> | <i>Possible causes</i> |
|---|--|
| <ul style="list-style-type: none">• Loud noise from hard drive• Clicking noise from hard drive• Still boots to operating system and operates normally | BIOS, hard drive firmware, driver, faulty drive, power supply (AC adapter). |
| | <i>Troubleshooting steps</i> |
| | <ol style="list-style-type: none">1. Update BIOS and hard drive firmware.2. Examine AC adapter to be sure that it is not faulty or overloaded. Disconnect all peripherals (USB storages, dock, etc.).3. Remove hard drive to isolate the noise.4. Test the hard drive on a verified working computer if the noise continues. If the hard drive makes the same noise or clicking sounds, the sounds are either normal sounds for the hard drive or a fault with the hard drive.5. Verify original hard drive connection and flex cable. Reseat hard drive and connection.6. Run HP PC Hardware Diagnostics (UEFI). If failed, record failure code and have the hard drive replaced.7. If no error with HP PC Hardware Diagnostics (UEFI), perform disk defragmentation (some hard drives make a clicking noise when highly fragmented). |
| Tips & tricks | <p>For optimal system performance, place your operating system and all of your most commonly used applications and files on the fastest hard drive or solid-state drive and on the fastest areas on the drive (primary partition of 200 GB max).</p> <p>See Improving System Performance. Also, see Routine Maintenance for Performance Improvement on page 126.</p> |

Mechanical

Fan error message - 90B

Symptoms

Fan error 90B at boot

CAUTION: May lead to system shutdown, data loss or possible system damage.

Possible causes

Defective fan; out-of-date BIOS.

- The system fan is not spinning or not spinning properly (loose connection, fan is stuck or defective).
- The temperature inside the case is too high, and the fan cannot spin fast enough to remove the heat due to an obstruction to air flow.



Troubleshooting steps

General actions

1. Update BIOS and drivers ([4. Update BIOS and drivers on page 66](#)) or reset BIOS to default. BIOS may implement new fan characteristics and updates for other components.
2. Perform a hard reset ([8. Hard reset on page 74](#)). Performing a hard reset can reset recorded thermal values in memory.

Thermal-related issue

1. Verify thermal condition:
 - a. Check fan and connection. Reseat fan cable.
 - b. Be sure that no obstructions or dust are in heat sink fan, fin, or vent.
 - c. Test fan using HP PC Hardware Diagnostics (UEFI) tool ([6. HP Hardware Diagnostics and Tools on page 67](#)). Be sure that the fan is not producing loud noise and that fan blades spin correctly.
 - d. Test with a verified working fan.
 - e. Remove old thermal compound and pads, and replace properly with new pads.
2. Verify thermal solution
 - ▲ Use Thermal Monitor tool (available only to authorized service providers/ technicians) to run stress test (processor and GPU) and verify that thermal sensors are within limits after thermal condition is serviced.

Note

BIOS currently omits fan presence detection to shorten boot time delay less than four seconds. Therefore, the fan error is generated based on previous boot to operating system that found system fan error.

Fan often is part of thermal solution, including heat sink, fin/ muffler, and thermal grease. Fan replacement requires reboot and fan function verification using HP PC Hardware Diagnostics (UEFI) tool.

See [Reducing Heat Inside the PC to Prevent Overheating](#).

Noise (sound)

| <i>Symptoms</i> | <i>Possible causes</i> |
|--|--|
| Computer emits abnormal noise | Aside from basic components (power adapter/supply, fan, speaker, hard drive, optical drive, display panel, external devices), it is also common for electronic components to produce noise. <i>Troubleshooting steps</i> <ol style="list-style-type: none">1. Inspect external power source and change to verified working one.2. Determine whether the noise comes from AC power adapter. Test with a verified working AC adapter. Disconnect external devices and all cables connected to the computer to isolate issue to computer only. |
| Noisy fan | Determine whether the noise comes from the fan. Disconnect the fan briefly to isolate whether noise originates from fan. If noise is absent with fan disconnected, refer to Fan runs constantly on page 119 . |
| Noisy hard drive | Determine whether the noise comes from the hard drive. See Noisy hard drive on page 116 . |
| Noisy optical drive | <ol style="list-style-type: none">1. Determine whether the noise comes from an optical drive.2. Remove CD/DVD from the optical drive. |
| Noisy speaker | <ol style="list-style-type: none">1. Determine whether the noise comes from speaker.2. Test with a verified working external headset/speaker. |
| Noisy display | Determine whether the noise comes from display panel (humming noise). Change display frequency settings. See Display on page 98 . |
| The section below is intended for authorized service providers/technicians. | |
| | <ol style="list-style-type: none">1. After disassembling the chassis, inspect components of the interior for excessive wear or damage.2. If noise issues persist, proceed with process of elimination for battery, AC adapter, or boards. |

Fan runs constantly

| | |
|---|--|
| <i>Symptoms</i> | <i>Possible causes</i> |
| <ul style="list-style-type: none">• Fan never stops running• Generates heat• Decreased computer performance | <ul style="list-style-type: none">• BIOS not up to date.• Thermal condition (fan, air flow)--fan may not be defective but must run constantly to remove excess heat generated by electrical components.• Inappropriate configuration. |
| | <i>Troubleshooting steps</i> |
| | General actions |
| | <ol style="list-style-type: none">1. Verify whether BIOS is set to Fan Always on while on AC Power F10 Setup. When booting the computer, press F10 to open Setup, and then select Advanced > Built-In Device Options Menu.2. Update BIOS and drivers (4. Update BIOS and drivers on page 66) and reset BIOS to default. BIOS may implement new fan characteristics and updates for other components.3. Perform a hard reset (8. Hard reset on page 74). Performing a hard reset can reset recorded thermal values in memory. |
| | Thermal-related issue |
| | <ol style="list-style-type: none">1. Verify fan is spinning. Reseat fan cable before moving to next step.<ol style="list-style-type: none">a. Check fan and connection. Reseat fan cable.b. Be sure that no obstructions or dust are in heat sink fan, heat sink fin, or vent.c. Test fan using HP PC Hardware Diagnostics (UEFI) tool (6. HP Hardware Diagnostics and Tools on page 67). Be sure that the fan is not producing loud noise and that fan blades spin correctly.d. Test with a verified working fan.e. Replace the fan.2. Verify thermal solution<p>Use Thermal Monitor tool (available only to authorized service providers/technicians) (HP Thermal Monitor on page 70) to run stress test (processor and GPU) and verify that thermal sensors are within limits after thermal condition is serviced.</p> |
| | User configuration |
| | Change Power Options in Windows (i.e., choosing Balanced mode instead of High performance). High performance and extensive graphics may cause the fan run constantly to release the heat. |
| Notes | <p>BIOS currently omits fan presence detection to shorten boot time delay less than four seconds. Therefore, the fan error is generated based on previous boot to operating system that found system fan error.</p> <p>Fan often is part of thermal solution, including heat sink, heat sink fin/muffler, and thermal grease. Fan replacement requires reboot and fan function verification using HP PC Hardware Diagnostics (UEFI) tool.</p> <p>For more information, see the following links:</p> <ul style="list-style-type: none">• HP Notebook PCs - Fan is Noisy and Spins Constantly, PC is Warmer than Normal.• Reducing Heat Inside the PC to Prevent Overheating.• Improving System Performance. |

Thermal shutdown (hot)

| | |
|--|---|
| <i>Symptoms</i> | <i>Possible causes</i> |
| Similar to fan runs constantly issue (Fan runs constantly on page 119) | BIOS not up to date, thermal condition (fan, air flow) |
| <ul style="list-style-type: none">• System shutdown• Abnormal heat• Continually running fan• Decreased computer performance | <i>Troubleshooting steps</i> <ol style="list-style-type: none">1. Update BIOS and drivers (4. Update BIOS and drivers on page 66) and reset BIOS to default. BIOS may implement new fan characteristics and updates for other component.2. Perform a hard reset (8. Hard reset on page 74). Performing a hard reset can reset recorded thermal values in memory.3. Determine whether you are using a correct AC adapter.4. Be sure to turn power off completely when putting a notebook in a travel bag. |
|  | Thermal-related issue <ol style="list-style-type: none">1. Verify thermal condition:<ol style="list-style-type: none">a. Check fan and connection. Reseat fan cable.b. Be sure that no obstructions or dust are in heat sink fan, fin, or vent.c. Be sure that the notebook is not sitting on a hot surface that blocks vent intakes.d. Test fan using HP PC Hardware Diagnostics (UEFI) tool (6. HP Hardware Diagnostics and Tools on page 67). Be sure that the fan is not producing a loud noise and that fan blades spin correctly.e. Test with a verified working fan.f. Remove old thermal compound and pads, and replace properly with new pads.2. Verify thermal solution:<ul style="list-style-type: none">◦ Use Thermal Monitor tool (available only to authorized service providers/ technicians) to run stress test (processor and GPU) and verify that thermal sensors are within limits after thermal condition is serviced. |
| Note | See Reducing Heat Inside the PC to Prevent Overheating . |

Stuck power button

| | |
|--|--|
| <i>Symptoms</i> | <i>Possible causes</i> |
| <ul style="list-style-type: none">• Rear power indicator light is on• Will not turn on when power button is pressed• Automatically powers on | Sticky or defective power button. |
| | <i>Troubleshooting steps</i> |
| | General actions |
| | <ol style="list-style-type: none">1. Perform a hard reset (8. Hard reset on page 74).2. Perform a soft reset if system can turn on. |
| The sections below are intended for authorized service providers/technicians. | |
| | <ol style="list-style-type: none">1. Disassemble the unit.2. Inspect power button on the top cover and on the system board to make sure these buttons moves freely. |

Additional information

The following sections provide additional information that can be used during the troubleshooting process.

Acronyms

The following acronyms are used in this chapter.

Blue screen (BSOD)—A Windows error screen that can occur if a problem causes your computer to shut down or restart unexpectedly. When you experience this type of error, you will not be able to see items such as the Start menu or the taskbar when your computer is turned on. Instead you might see a blue screen with a message that your computer ran into a problem and needs to restart.

CPU—Central processing unit

DIMM—Dual in-line memory module

Daughterboard—Type of circuit board that plugs into or is attached to the system board or similar expansion card to extend its features and services.

GPU—Graphics processor unit

GTS—General Troubleshooting Step

HDD—Hard drive

KB—Keyboard

LVDS—Low-Voltage Differential Signaling

MSG—Maintenance and Service Guide

mWS—Mobile Workstations

WS—Workstations

OS—Operating system

PC—Personal computer

POST—Power-On Self-Test

SSD—Solid-state drive

TSG—Troubleshooting Guide

UEFI—Unified Extensible Firmware Interface

WLAN—Wireless local area network

WWAN—Wireless wide area network

Blinking lights and boot error codes

The information below is from the white paper [HP Business Notebook and Desktop PC F10 Setup, 2014 Business PC models](#).

In some cases, when the host processor is not executing code or does not have the necessary code to drive the display, light blink codes inform you of a problem.

Table 7-7 Boot-error codes

| Blink codes | Error |
|---|--|
| Amber battery light: blinks 1 Hz continuously | Embedded Controller unable to load firmware |
| Caps/num lock lights = 1 blink | Processor not executing code |
| Caps/num lock lights = 2 blinks | BIOS recovery code unable to find valid BIOS recovery image |
| Caps/num lock lights = 3 blinks | Memory module error |
| Caps/num lock lights = 4 blinks | Graphics controller error |
| Caps/num lock lights = 5 blinks | System board error |
| Caps/num lock lights = 6 blinks | Intel Trusted Execution Technology (TXT) Error |
| Caps/num lock lights = 7 blinks | Sure Start unable to find valid BIOS Boot Block image |
| Caps/num lock lights = 8 blinks | Sure Start has identified a problem (Manual Recovery Policy Set) |

Processor not executing code

This computer has experienced a problem due to the failure of certain code to execute, resulting in a failed startup of the processor. The issue could be related to the processor or the system board in the computer. If the processor is socketed, be sure that the processor is seated correctly in the socket. If this error reoccurs, refer to [General troubleshooting steps on page 62](#).

 **NOTE:** The computer will attempt to notify you of this problem through a series of blinking lights. When you attempt to turn on the computer from an “Off” or “Hibernated” state, lights associated with the [caps lock](#) and [num lock](#) keys will both **blink once** followed by a pause, and then continue in a repeating pattern.

BIOS recovery code unable to find valid BIOS recovery image

This computer has experienced a problem in locating a valid BIOS image, resulting in a failed startup. This problem may be resolved by placing a clean copy of the system BIOS on a USB key or in the appropriate hard drive directory and performing a reboot. If this error reoccurs, refer to [General troubleshooting steps on page 62](#).

 **NOTE:** The computer will attempt to notify you of this problem through a series of blinking lights. When you attempt to turn on the computer from an “Off” or “Hibernated” state, lights associated with the [caps lock](#) and [num lock](#) keys will both **blink twice** followed by a pause, and then continue in a repeating pattern.

Memory module error

This computer has experienced a memory initialization problem resulting in a failed startup. This issue may be related to the memory modules in the computer. This problem may be resolved by ensuring that memory modules are correctly inserted and seated. If this error reoccurs, a service event is required to determine the source of the error (memory modules or system board) and take the appropriate corrective action.

 **NOTE:** The computer will attempt to notify you of this problem through a series of blinking lights. When you attempt to turn on the computer from an “Off” or “Hibernated” state, lights associated with the [caps lock](#) and [num lock](#) keys will both **blink three times** followed by a pause, then continue in a repeating pattern.

Graphics Controller Error (No Controller)

This computer has experienced a graphics controller initialization problem resulting in a failed startup. This issue may be related to the graphics controller in your machine. This problem may be resolved by ensuring that the graphics controller module is seated correctly in machines with modular graphics. If this error reoccurs, a service event is required to identify the source of the error and take the appropriate corrective action.

 **NOTE:** The computer will attempt to notify you of this problem through a series of blinking lights. When you attempt to turn on the computer from an “Off” or “Hibernated” state, lights associated with the [caps lock](#) and [num lock](#) keys will both **blink four times** followed by a pause, then continue in a repeating pattern.

Failure - System Board Error

This computer has experienced a system board initialization problem resulting in a failed startup. This issue may be related to the system board in the computer. A service event is required to identify the source of the error and take the appropriate corrective action.

 **NOTE:** The computer will attempt to notify you of this problem through a series of blinking lights. When you attempt to turn on the computer from an “Off” or “Hibernated” state, lights associated with the [caps lock](#) and [num lock](#) keys will both **blink five times** followed by a pause, then continue in a repeating pattern.

Intel Trusted Execution Technology (TXT) Error

This computer has experienced a problem related to the Intel Trusted Execution Technology resulting in a failed startup. The error occurs when all of the following are true:

- The Intel Trusted Execution Technology (TXT) has been enabled on the computer.
- Policies have been set to prevent startup if the BIOS measurement has changed.
- The BIOS measurement has changed.

For more information about Intel TXT, go to <http://www.intel.com/content/dam/www/public/us/en/documents/white-papers/trusted-execution-technology-security-paper.pdf>.

A service event is required to resolve this issue.

 **NOTE:** The computer will attempt to notify you of this problem through a series of blinking lights. When you attempt to turn on the computer from an “Off” or “Hibernated” state, lights associated with the [caps lock](#) and [num lock](#) keys will both **blink six times** followed by a pause, then continue in a repeating pattern.

Sure Start unable to find valid BIOS Boot Block image

This computer has experienced a problem in locating a valid BIOS image, resulting in a failed startup. A service event is required to identify the source of the error and take appropriate corrective action.

 **NOTE:** The computer will attempt to notify you of this problem through a series of blinking lights. When you attempt to turn on the computer from an “Off” or “Hibernated” state, lights associated with the [caps lock](#) and [num lock](#) keys will both **blink seven times** followed by a pause, then continue in a repeating pattern.

Sure Start has identified a problem (Manual Recovery Policy Set)

This computer has experienced a problem in locating a valid BIOS image, resulting in a failed startup. HP Sure Start will normally repair this type of issue; however, on this computer HP Sure Start has been configured to operate in manual mode key sequence. To proceed with the repair, press and hold the following keys: <ESC> +<UP arrow>+<DOWN arrow>. To avoid the need for this manual recovery step, set the HP Sure Start recovery policy to automatic. If this error reoccurs, a service event is required to identify the source of the error and take appropriate corrective action.



NOTE: The computer will attempt to notify you of this problem through a series of blinking lights. When you attempt to turn on the computer from an “Off” or “Hibernated” state, lights associated with the [caps lock](#) and [num lock](#) keys will both **blink eight times** followed by a pause, then continue in a repeating pattern.

POST Error Messages and User Actions

| Test description | Failure descriptions | Error code | Possible user actions |
|---------------------|----------------------|------------|--|
| Product information | Invalid value | 00A | Contact support for assistance. |
| Startup test | Memory module | 200 | Attempt to reseat the memory module and then repeat the test. See Overview of How to Troubleshoot Problems When a Computer Does Not Start Up or Boot Properly for details on troubleshooting issues related to the memory module. If the memory module still fails, contact support. |
| Startup test | Hard Disk 1 SMART | 301 | Attempt to reseat the hard drive and repeat the test. The hard disk drive may have failed. Contact support for assistance. |
| Startup test | Hard Disk 2 SMART | 302 | The hard drive may have failed. Contact support for assistance. |
| Startup test | Hard Disk 1 Quick | 303 | The hard drive may have failed. Contact support for assistance. |
| Startup test | Hard Disk 2 Quick | 304 | The hard drive may have failed. Contact support for assistance. |
| Run-in test | Memory module | 200 | Attempt to reseat the memory module and then repeat the test. See Overview of How to Troubleshoot Problems When a Computer Does Not Start Up or Boot Properly for details on troubleshooting issues related to the memory module. If the memory module still fails, contact support. |
| Run-in test | Hard Disk 1 SMART | 301 | Attempt to reseat the hard drive and repeat the test. The hard drive may have failed. Contact support for assistance. |
| Run-in test | Hard Disk 2 SMART | 302 | The hard drive may have failed. Contact support for assistance. |
| Run-in test | Hard Disk 1 Quick | 303 | The hard drive may have failed. Contact support for assistance. |
| Run-in test | Hard Disk 2 Quick | 304 | The hard drive may have failed. Contact support for assistance. |
| Hard Disk Test | Hard Disk 1 SMART | 301 | Attempt to reseat the hard drive and repeat the test. The hard drive may have failed. Contact support for assistance. |
| Hard Disk Test | Hard Disk 2 SMART | 302 | The hard drive may have failed. Contact support for assistance. |
| Hard Disk Test | Hard Disk 1 Quick | 303 | The hard drive may have failed. Contact support for assistance. |
| Hard Disk Test | Hard Disk 2 Quick | 304 | The hard drive may have failed. Contact support for assistance. |

| | | | |
|---------------------|-----------------------------|-----|---|
| Hard Disk Test | Hard Disk 1 Full | 305 | The hard drive may have failed. Contact support for assistance. |
| Hard Disk Test | Hard Disk 2 Full | 306 | The hard drive may have failed. Contact support for assistance. |
| Boot Device Manager | Boot device not found | 3F0 | Indicates a potential problem with the hard drive. Please run the hard drive test. See Testing a Hard Disk using the Built in Self Test for more information. |
| Boot Device Manager | Hard Disk 1 Error | 3F1 | Indicates a potential problem with the hard drive. Run the hard drive test. See Testing a Hard Disk using the Built in Self Test for more information. |
| Boot Device Manager | Hard Disk 2 Error | 3F2 | Indicates a potential problem with the hard drive. Run the hard drive test. See Testing a Hard Disk using the Built in Self Test for more information. |
| Boot Device Manager | Hard Disk 1 SMART | 301 | Indicates a potential problem with the hard drive. Run the hard drive test. See Testing a Hard Disk using the Built in Self Test for more information. |
| Boot Device Manager | Hard Disk 2 SMART | 302 | Indicates a potential problem with the hard drive. Run the hard drive test. See Testing a Hard Disk using the Built in Self Test for more information. |
| BIOS Recovery | BIOS Recovery Occurred | 500 | This message indicates that BIOS recovery was completed successfully. No further action is required. |
| BIOS Application | BIOS Application Error | 501 | The BIOS installation may have become corrupted. Download the latest version of the BIOS and install it. See 4. Update BIOS and drivers on page 66 for more information. If reinstalling the BIOS fails, contact support for further assistance. |
| CMOS Recovery | CMOS Recovery Occurred | 502 | This message indicates that CMOS recovery was completed successfully. No further action is required. |
| Battery Check | Primary Battery Replace | 601 | This indicates that the primary battery has very low capacity. See Checking the Status of the Battery for details on using the HP Support Assistant to verify the battery capacity and, if necessary, order a replacement. |
| Battery Check | Secondary Battery Replace | 602 | This indicates that the secondary battery has very low capacity. See Checking the Status of the Battery for details on using the HP Support Assistant to verify the battery capacity and, if necessary, order a replacement. |
| Wireless Module | Not installed or responding | 701 | Reseat the wireless LAN adapter module, if your notebook supports it. Because seating or reseating a wireless LAN adapter is unique to each computer model. For more information, see the chapter titled "Removal and replacement procedures for Customer Self-Repair parts." |
| Fan | Fan not operating correctly | 90B | The system fan may be malfunctioning. For information on troubleshooting heat-related issues, see HP Notebook PCs - Fan is Noisy and Spins Constantly, PC is Warmer than Normal . A hard reset can sometimes restore the system fan to working order. See Use Hard Reset to Resolve Hardware and Software Issues for details. If the system fan continues to malfunction, contact support. |

Routine Maintenance for Performance Improvement

See [HP Notebook PCs - Improving the Performance of Your Computer](#).

The following table presents a summary of the suggested times for performing the routine maintenance tasks described in this document.

| Tasks | Weekly | Monthly | Occasionally |
|---|--------|---------|--------------|
| Perform a system tune up. | X | | |
| Run Windows Update. | X | | |
| Scan for and remove viruses. | X | | |
| Scan for and remove spyware and adware. | X | | |
| Empty the Recycle Bin. | X | | |
| Delete temporary Internet files. | X | | |
| Back up user files. | | X | |
| Create a restore point. | | X | |
| Defragment the hard drive. | | X | |
| Run Scan Disk. | | X | |
| Clean the exterior of the computer. | | | X |
| Close programs that are not being used. | | | X |
| Prevent programs from loading at startup. | | | X |

Common Blue Screen Error Messages

Error message list

The following image shows an example of one possible “[Bug Check \(Blue Screen\) Code Reference](#)” from Microsoft:

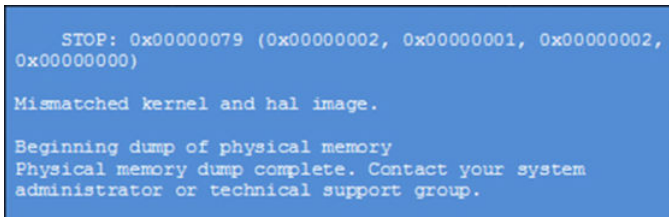

```
STOP: 0x00000079 (0x00000002, 0x00000001, 0x00000002,
0x00000000)

Mismatched kernel and hal image.

Beginning dump of physical memory
Physical memory dump complete. Contact your system
administrator or technical support group.
```

The hexadecimal number following the word "STOP" is called the bug check code or Stop code. This is the most important item on the screen.

Bug check symbolic names

Each bug check code also has an associated symbolic name. In the example, the screen shows [bug check 0x79](#) (MISMATCHED_HAL).

Microsoft general troubleshooting of Windows bug check codes

- If you recently added hardware to the system, try removing or replacing it. Or check with the manufacturer to see if any patches are available.
- Try running HP PC Hardware Diagnostics (UEFI).
- Check with the manufacturer to see if an updated system BIOS or firmware is available.
- Be sure that any expansion board is properly seated and all cables are completely connected.
- Confirm that any new hardware that is installed is compatible with the installed version of Windows.
- If new device drivers or system services have been added recently, try removing or updating them.



NOTE: Use safe mode when removing or disabling components. Safe mode loads only the minimum required drivers and system services during the Windows startup. To enter safe mode, restart your computer and press **F8** at the menu that displays the operating system choices. At the resulting **Windows Advanced Options** menu, choose **Safe Mode**.

- Run a virus detection program. Viruses can infect all types of hard drives formatted for Windows, and resulting drive corruption can generate system bug check codes. Be sure that the virus detection program checks the Master Boot Record for infections.
- Verify that the system has the latest service pack installed. To detect which service pack, if any, is installed on your system, click **Start**, click **Run**, type `winver`, and then press **Enter**. The **About Windows** dialog box displays the Windows version number and the version number of the service pack, if one has been installed.
- Disable BIOS memory options such as caching or shadowing.
- Check the System Log and Application Log in Event Viewer to see if any additional error messages have been logged recently. These might pinpoint the cause of the error.

Use Windows Debugging Tool

The [Windows Debugger](#) is one of the primary tools used by Microsoft software developers to analyze and resolve errors that result in memory dumps. Use the tool to determine the cause of the error. Follow general steps for downloading, setting up, and using the Windows 10 debugging tool. A similar process is used for Windows 7 or Windows 8.



NOTE: The following screen shots provide only an example of the tool. Specifics shown are not representative of all applications of the debugging tool. This is a Microsoft tool supported by Microsoft.

Windows Software Development Kit (SDK)

1. Download the SDK from the following link:
<https://msdn.microsoft.com/en-us/windows/desktop/bg162891.aspx>
2. Set up the SDK in the configuration window (Windows 10 shown).

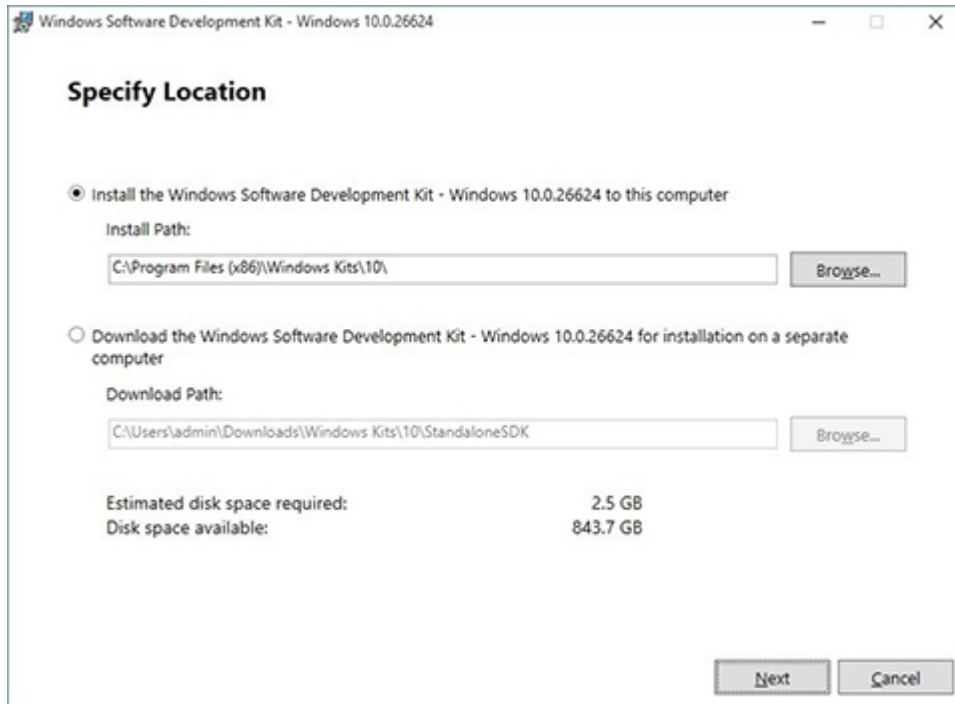

3. Select features to install.

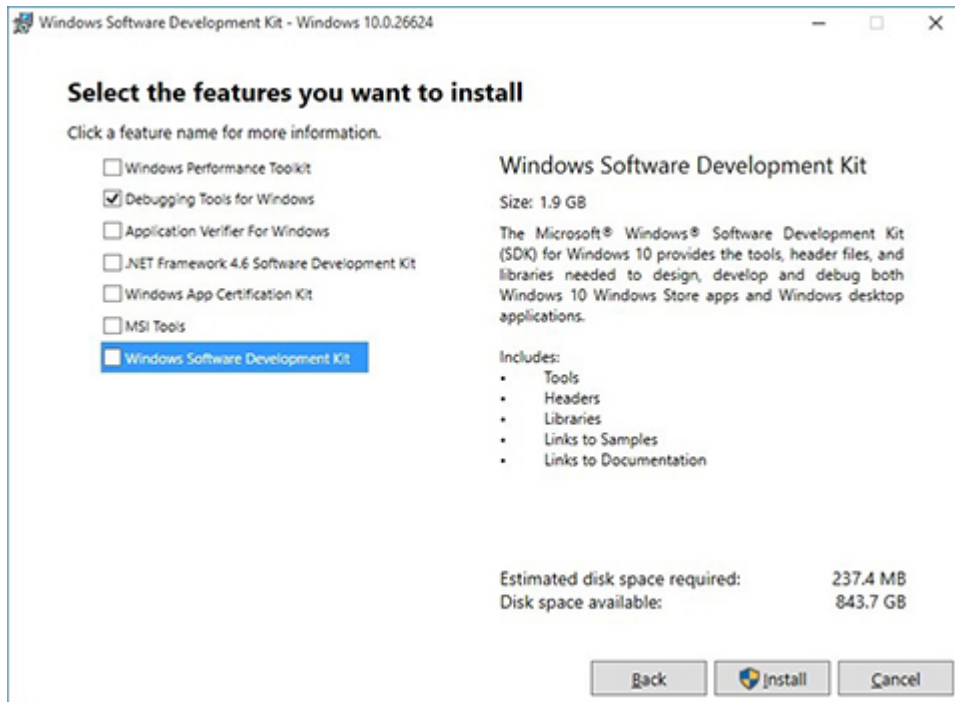

4. Run the SDK as an administrator.

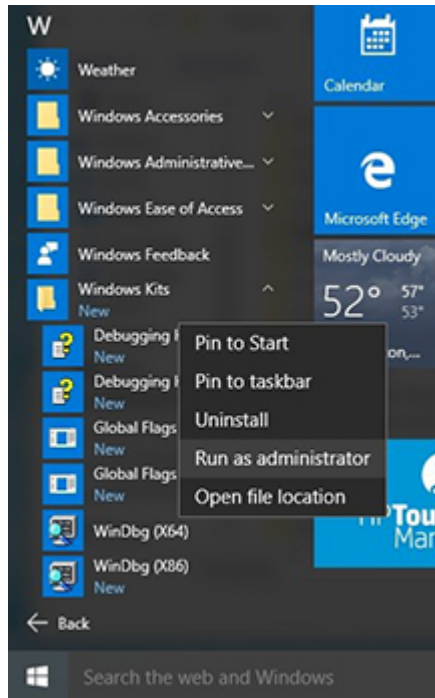

5. Set the symbol path. Select **File > Symbol File Path**.

- In the **Symbol path** box, type `SRV*C:\Windows\symbol_cache*http://msdl.microsoft.com/download/symbols`.
- Save the workspace.

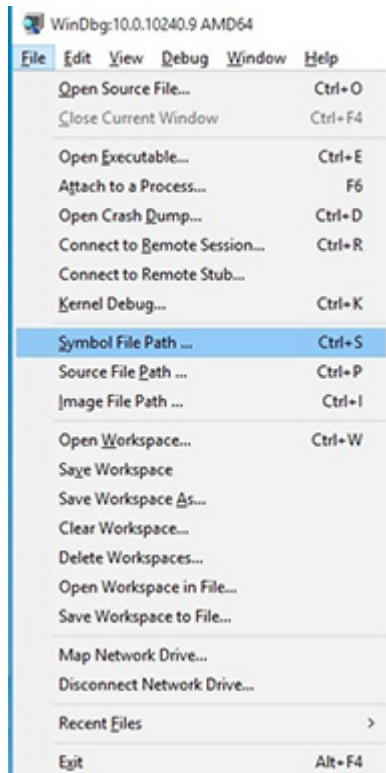

6. Open the crash dump file.

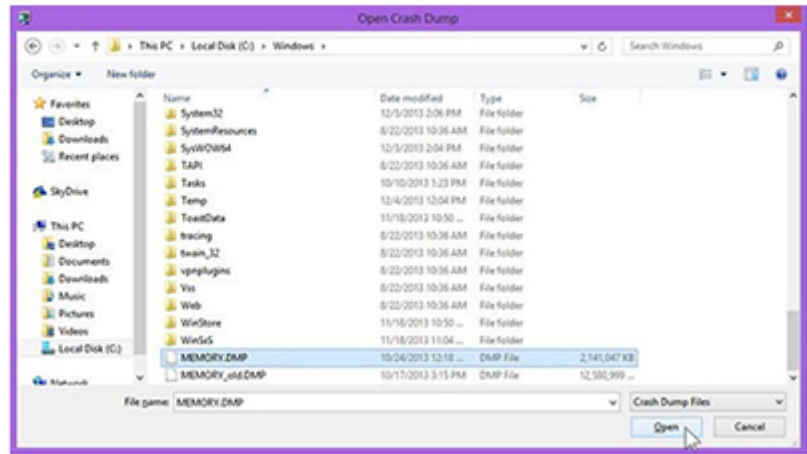
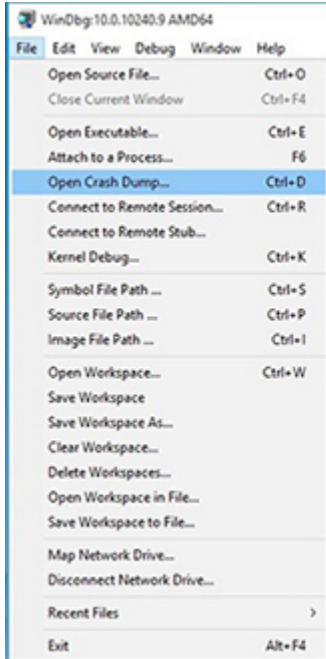

- Analyze the file. In the following memory dump sample, look for Bug Check 0x3B. The ATKMAG driver needs to be investigated for further root cause.

Lookup for Bug Check 0xC2.

```

1: kd> !analyze -v
.....
*                                     *
*                               Bugcheck Analysis                               *
*                                     *
*                                     *
.....

SYSTEM_SERVICE_EXCEPTION (3b)
An exception happened while executing a system service routine.
Arguments:
Arg1: 0000000c00000005, Exception code that caused the bugcheck
Arg2: fffff8006d927acf, Address of the instruction which caused the bugcheck
Arg3: fffffd00020e4e500, Address of the context record for the exception that caused the bugcheck
Arg4: 0000000000000000, zero.

Debugging Details:
-----
BUGCHECK_P1: c0000005
BUGCHECK_P2: fffff8006d927acf
BUGCHECK_P3: fffffd00020e4e500
BUGCHECK_P4: 0
EXCEPTION_CODE: (NTSTATUS) 0xc0000005 - The instruction at 0x%p referenced memory at 0x%p. The memory

FAULTING_IP:
atikmpag+2facf
fffff800`6d927acf 4539bc2434030000 cmp     dword ptr [r12+334h],r15d
...

SYMBOL_STACK_INDEX: 0
SYMBOL_NAME: atikmpag+2facf
FOLLOWUP_NAME: MachineOwner
MODULE_NAME: atikmpag
IMAGE_NAME: atikmpag.sys
DEBUG_FLR_IMAGE_TIMESTAMP: 55479b42
STACK_COMMAND: .cxr 0xffffd00020e4e500 ; kb
BUCKET_ID_FUNC_OFFSET: 2facf
FAILURE_BUCKET_ID: 0x3b_atikmpag!Unknown_Function
BUCKET_ID: 0x3b_atikmpag!Unknown_Function
PRIMARY_PROBLEM_CLASS: 0x3b_atikmpag!Unknown_Function
ANALYSIS_SOURCE: KM
FAILURE_ID_HASH_STRING: km:0x3b_atikmpag!unknown_function
FAILURE_ID_HASH: {adb00875-801c-005a-68e8-645bb2f2c848}

```

```

Command - Dump C:\Windows\MEMORY.DMP - WinDbg.6.3.9600.16384 AMD64
.....
Loading User Symbols
Loading unloaded module list
.....
*                                     *
*                               Bugcheck Analysis                               *
*                                     *
*                                     *
.....

Use !analyze -v to get detailed debugging information.

BugCheck C2, {7, 1205, 1159400, fffff80001137350}

*** ERROR: Module load completed but symbols could not be loaded for nldr.sys
Probably caused by : NETIO.SYS ( NETIO! ?? ::FNODOBFN::'string'+797c )

Followup: MachineOwner
-----
0: kd>

```

Display Issue: Pixel Anomalies

All HP notebook displays adhere to strict quality and reliability specifications. A small percentage of display panels may have minor cosmetic manufacturing anomalies or irregularities such as bright or dark dots in the viewable area. These cosmetic imperfections are common to all display panel types and are not specific to any HP model or product line.

All display panel defects should be examined at the highest possible resolution using both the brightest and darkest possible backgrounds, because some sub-pixel failures may not be readily visible under certain conditions.

- Type 1: Bright dot on a dark background = Always On
- Type 2: Dark dot on a bright background = Always Off
- Combination = in any combination and any color that are always on or off

Use the HP PC Hardware Diagnostics (UEFI) tool to determine numbers of pixels and their distance. HP uses the following set of criteria when damaged displays are submitted for warranty coverage.

Source: [HP Notebook PCs and Tablets - About LCD Panel Defects and Terminology for Notebook PCs and Tablets](#)

Table 7-8 Electrical defect allowances

| Panel resolution | Accept | Reject |
|---|------------------------------|--------------|
| Sub-pixel faults | | |
| VGA, SVGA, SD, WSVGA, XGA, 720p, SD+, WXGA, HD | N ≤ 2 Type 1 N ≤ 2 Type 2 | N ≥ 3 Type 1 |
| WXGA+, SXGA+, HD+, SXGA+ | N ≤ 3 Type 1 N ≤ 3 Type 2 | N ≥ 4 Type 1 |
| WSXGA+, UXGA, FHD, WUXGA | N ≤ 4 Type 1 N ≤ 4 Type 2 | N ≥ 5 Type 1 |
| QHD, QHD+, WQXGA, UD | N ≤ 5 Type 1 N ≤ 5 Type 2 | N ≥ 6 Type 1 |
| Electrical defect clusters (defects within a 5x5 pixel block) | | |
| Minimum distance between ANY allowable defects (unless otherwise specified) | S ≥ 25 mm | S < 25 mm |
| Cluster with 2 or more sub-pixels with sub-pixel faults | | Not allowed |
| Dim lines | | Not allowed |
| Cross line(s) on/off | | Not allowed |
| Horizontal line(s) on/off | | Not allowed |
| Vertical line(s) on/off | | Not allowed |

 **NOTE:** All LCD panel defects should be examined at the highest possible resolution using both the brightest and darkest possible backgrounds, as some sub-pixel failures may not be readily visible under certain conditions.

 **NOTE:** Contact support for assistance if issues are not listed.

Cable management

Proper routing of the internal cables is critical to the operation of the computer. Follow good cable management practices when removing and installing components.

- Handle cables with care to avoid damage.
- Apply only the tension required to seat or unseat cables during insertion or removal from the connector.
- When possible, handle cables by the connector or pull-strap.
- Route cables in such a way that they cannot be caught or snagged by parts being removed or replaced.
- Keep cables away from direct contact with major heat sources, such as the heat sink. (Some air flow guides have a cable guide that lets you route cables safely around the heat sink.)
- Do not jam cables on top of daughterboards or memory modules (DIMMs). Circuit cards and DIMMs are not designed to take excessive pressure.
- Keep cables clear of any movable or rotating parts (such as a fan) to prevent them from being cut or crimped when the component is lowered into its normal position.
- In all cases, avoid bending or twisting the cables. Do not bend any cable sharply. A sharp bend can break the internal wires.
- Do not rely on components like the keyboard or service door to push cables down internally. Always position the cables to lay properly by themselves or in the cable guides and chassis areas designed for cable routing.

 **CAUTION:** Always release connector latch before removing the cable. Otherwise, pulling the cable could damage the cable pins and result in a failed device.

Connector types

 **IMPORTANT:** Connector pins and connector gold fingers should not be touched directly with bare hands.

There are several different types of connectors on the system board with different requirements for cable removal or insertion.

Flex cable

When connecting flex cables, push the cable completely, evenly into the connector.

When removing flex cables from a ZIF connector on the system board, always follow these steps:

1. Squeeze on the top of the retaining latch attached to the cable end of the connector.
2. Grasp the cable end of the connector and pull it straight out.

 **CAUTION:** Always release connector latch before removing the cable. Otherwise, pulling the cable could damage the cable pins and result in a failed device.

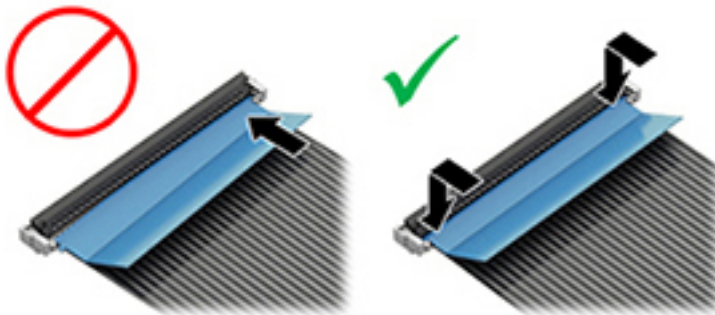

Horizontal installation cable

Use flat tool to pull connector evenly. Do not pull on cable to remove.

Slide connector into receptacle on same horizontal plane as board and use flat tool to push evenly into receptacle.

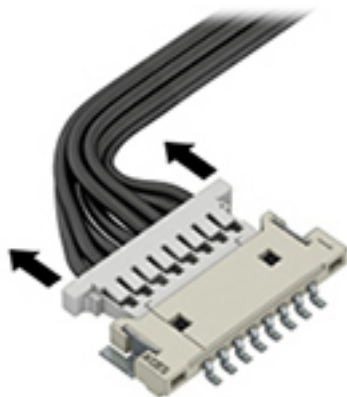

Multi-pin horizontal insert connector (LVDS cable to display panel)

Insert procedure:

1. Slide connector evenly into receptacle on same horizontal plane as PCB connector.
2. Pull lock bar to insert and push both side connector horizontally to firmly lock.
3. Tape down lock bar over the panel to hold in position.

Reverse the procedure above to remove the connector:

1. Remove tape.
2. Pull up bar (pull tape) and release the lock with the PCB connector.
3. Pull to the direction in parallel with PCB to withdraw the connector.

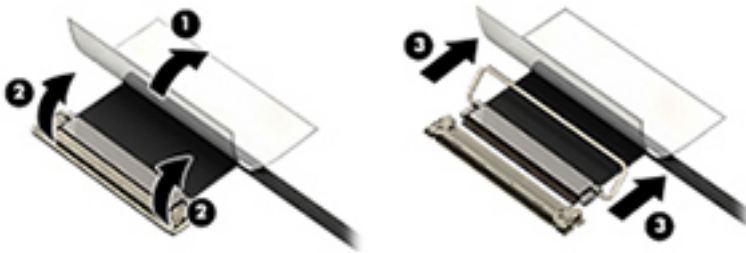

Multi-pin vertical insert connector (LVDS cable to system board)

- Remove the connector gasket prior to removing the connector.
- Use flat tool under the connector to remove evenly. Do not pull on the cable to remove.
- Press evenly when reseating/reconnecting/installing the connector.

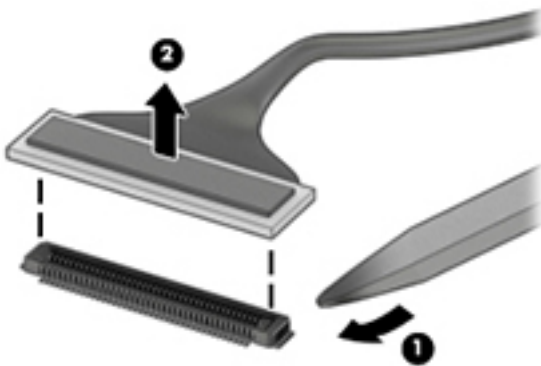

For more information about cable management, see [Cable management on page 133](#).

8 Computer Setup (BIOS), TPM, and HP Sure Start in Windows 7

Using Computer Setup

Computer Setup, or Basic Input/Output System (BIOS), controls communication between all the input and output devices on the system (such as disk drives, display, keyboard, mouse, and printer). Computer Setup includes settings for the types of devices installed, the startup sequence of the computer, and the amount of system and extended memory.

 **NOTE:** Use extreme care when making changes in Computer Setup. Errors can prevent the computer from operating properly.

Starting Computer Setup

 **NOTE:** An external keyboard or mouse connected to a USB port can be used with Computer Setup only if USB legacy support is enabled.

To start Computer Setup, follow these steps:

- ▲ Start Computer Setup.
 - Computers or tablets with keyboards:
 - ▲ Turn on or restart the computer, and when the HP logo appears, press **F10** to enter Computer Setup.
 - Tablets without keyboards:
 - ▲ Turn off the tablet. Press the power button in combination with the volume down button until the Startup menu is displayed, and then tap **F10** to enter Computer Setup.

Navigating and selecting in Computer Setup

- To select a menu or a menu item, use the **tab** key and the keyboard arrow keys and then press **enter**, or use a pointing device to select the item.

 **NOTE:** On tablets without keyboards, you can use your finger to make selections.

- To scroll up and down, select the up arrow or the down arrow in the upper-right corner of the screen, or use the up arrow key or the down arrow key on the keyboard.
- To close open dialog boxes and return to the main Computer Setup screen, press **esc**, and then follow the on-screen instructions.

To exit Computer Setup menus, choose one of the following methods:

- To exit Computer Setup menus without saving your changes:
Select the **Exit** icon in the lower-right corner of the screen, and then follow the on-screen instructions.
– or –
Select **Main**, select **Ignore Changes and Exit**, and then press [enter](#).
- To save your changes and exit Computer Setup menus:
Select the **Save** icon in the lower-right corner of the screen, and then follow the on-screen instructions.
– or –
Select **Main**, select **Save Changes and Exit**, and then press [enter](#).

Your changes go into effect when the computer restarts.

Restoring factory settings in Computer Setup

 **NOTE:** Restoring defaults will not change the hard drive mode.

To return all settings in Computer Setup to the values that were set at the factory, follow these steps:

1. Start Computer Setup. See [Starting Computer Setup on page 136](#).
2. Select **Main**, and then select **Apply Factory Defaults and Exit**.

 **NOTE:** On select products, the selections may display **Restore Defaults** instead of **Apply Factory Defaults and Exit**.

3. Follow the on-screen instructions.
4. To save your changes and exit, select the **Save** icon in the lower-right corner of the screen, and then follow the on-screen instructions.
– or –
Select **Main**, select **Save Changes and Exit**, and then press [enter](#).

Your changes go into effect when the computer restarts.

 **NOTE:** Your password settings and security settings are not changed when you restore the factory settings.

Updating the BIOS

Updated versions of the BIOS may be available on the HP website.

Most BIOS updates on the HP website are packaged in compressed files called *SoftPaqs*.

Some download packages contain a file named *Readme.txt*, which contains information regarding installing and troubleshooting the file.

Determining the BIOS version

To decide whether you need to update Computer Setup (BIOS), first determine the BIOS version on your computer.

BIOS version information (also known as *ROM date* and *System BIOS*) can be accessed by pressing **fn+esc** (if you are already in Windows) or by using Computer Setup.

1. Start Computer Setup. See [Starting Computer Setup on page 136](#).
2. Select **Main**, and then select **System Information**.
3. To exit Computer Setup without saving your changes, select the **Exit** icon in the lower-right corner of the screen, and then follow the on-screen instructions.

– or –

Select **Main**, select **Ignore Changes and Exit**, and then press **enter**.

To check for later BIOS versions, see [Downloading a BIOS update on page 138](#).

Downloading a BIOS update

 **CAUTION:** To reduce the risk of damage to the computer or an unsuccessful installation, download and install a BIOS update only when the computer is connected to reliable external power using the AC adapter. Do not download or install a BIOS update while the computer is running on battery power, docked in an optional docking device, or connected to an optional power source. During the download and installation, follow these instructions:

Do not disconnect power on the computer by unplugging the power cord from the AC outlet.

Do not shut down the computer or initiate Sleep.

Do not insert, remove, connect, or disconnect any device, cable, or cord.

1. Access Help and Support by selecting **Start > All Programs > HP Help and Support > HP Support Assistant**.
2. Make the selection for updates.
3. Follow the on-screen instructions.
4. At the download area, follow these steps:
 - a. Identify the most recent BIOS update and compare it to the BIOS version currently installed on your computer. Make a note of the date, name, or other identifier. You may need this information to locate the update later, after it has been downloaded to your hard drive.
 - b. Follow the on-screen instructions to download your selection to the hard drive.

Make a note of the path to the location on your hard drive where the BIOS update is downloaded. You will need to access this path when you are ready to install the update.

 **NOTE:** If you connect your computer to a network, consult the network administrator before installing any software updates, especially system BIOS updates.

BIOS installation procedures vary. Follow any instructions that are revealed on the screen after the download is complete. If no instructions are revealed, follow these steps:

1. Select **Start > Computer**.
2. Select your hard drive designation. The hard drive designation is typically Local Disk (C:).
3. Using the hard drive path you recorded earlier, open the folder that contains the update.
4. Double-click the file that has an .exe extension (for example, *filename.exe*).
The BIOS installation begins.
5. Complete the installation by following the on-screen instructions.

 **NOTE:** After a message on the screen reports a successful installation, you can delete the downloaded file from your hard drive.

Changing the boot order using the f9 prompt

To dynamically choose a boot device for the current startup sequence, follow these steps:

1. Access the Boot Device Options menu:
 - Computers or tablets with keyboards:
 - ▲ Turn on or restart the computer, and when the HP logo appears, press **f9** to enter the Boot Device Options menu.
 - Tablets without keyboards:
 - ▲ Turn off the tablet. Press the power button in combination with the volume down button until the Startup menu is displayed, and then tap **F9** to enter the Boot Device Options menu.
2. Select a boot device, then press [enter](#).

TPM BIOS settings (select products only)

 **IMPORTANT:** Before enabling Trusted Platform Module (TPM) functionality on this system, you must ensure that your intended use of TPM complies with relevant local laws, regulations and policies, and approvals or licenses must be obtained if applicable. For any compliance issues arising from your operation/usage of TPM which violates the above mentioned requirement, you shall bear all the liabilities wholly and solely. HP will not be responsible for any related liabilities.

TPM provides additional security for your computer. You can modify the TPM settings in Computer Setup (BIOS).

 **NOTE:** If you change the TPM setting to Hidden, TPM is not visible in the operating system.

To access TPM settings in Computer Setup:

1. Start Computer Setup. See [Starting Computer Setup on page 136](#).
2. Select **Security**, select **TPM Embedded Security**, and then follow the on-screen instructions.

Using HP Sure Start (select products only)

Select computer models are configured with HP Sure Start, a technology that monitors the computer's BIOS for attacks or corruption. If the BIOS becomes corrupted or is attacked, HP Sure Start automatically restores the BIOS to its previously safe state, without user intervention.

HP Sure Start is configured and already enabled so that most users can use the HP Sure Start default configuration. The default configuration can be customized by advanced users.

To access the latest documentation on HP Sure Start, go to <http://www.hp.com/support>, and select your country. Select **Drivers & Downloads**, and then follow the on-screen instructions.

9 Computer Setup (BIOS), TPM, and HP Sure Start in Windows 10

Using Computer Setup

Computer Setup, or Basic Input/Output System (BIOS), controls communication between all the input and output devices on the system (such as disk drives, display, keyboard, mouse, and printer). Computer Setup includes settings for the types of devices installed, the startup sequence of the computer, and the amount of system and extended memory.

 **NOTE:** Use extreme care when making changes in Computer Setup. Errors can prevent the computer from operating properly.

Starting Computer Setup

 **NOTE:** An external keyboard or mouse connected to a USB port can be used with Computer Setup only if USB legacy support is enabled.

To start Computer Setup, follow these steps:

- ▲ Start Computer Setup.
 - Computers or tablets with keyboards:
 - ▲ Turn on or restart the computer, and when the HP logo appears, press **F10** to enter Computer Setup.
 - Tablets without keyboards:
 - ▲ Turn off the tablet. Press the power button in combination with the volume down button until the Startup menu is displayed, and then tap **F10** to enter Computer Setup.

Navigating and selecting in Computer Setup

- To select a menu or a menu item, use the **tab** key and the keyboard arrow keys and then press **enter**, or use a pointing device to select the item.

 **NOTE:** On tablets without keyboards, you can use your finger to make selections.

- To scroll up and down, select the up arrow or the down arrow in the upper-right corner of the screen, or use the up arrow key or the down arrow key on the keyboard.
- To close open dialog boxes and return to the main Computer Setup screen, press **esc**, and then follow the on-screen instructions.

To exit Computer Setup menus, choose one of the following methods:

- To exit Computer Setup menus without saving your changes:
Select the **Exit** icon in the lower-right corner of the screen, and then follow the on-screen instructions.
– or –
Select **Main**, select **Ignore Changes and Exit**, and then press [enter](#).
- To save your changes and exit Computer Setup menus:
Select the **Save** icon in the lower-right corner of the screen, and then follow the on-screen instructions.
– or –
Select **Main**, select **Save Changes and Exit**, and then press [enter](#).

Your changes go into effect when the computer restarts.

Restoring factory settings in Computer Setup

 **NOTE:** Restoring defaults will not change the hard drive mode.

To return all settings in Computer Setup to the values that were set at the factory, follow these steps:

1. Start Computer Setup. See [Starting Computer Setup on page 141](#).
2. Select **Main**, and then select **Apply Factory Defaults and Exit**.

 **NOTE:** On select products, the selections may display **Restore Defaults** instead of **Apply Factory Defaults and Exit**.

3. Follow the on-screen instructions.
4. To save your changes and exit, select the **Save** icon in the lower-right corner of the screen, and then follow the on-screen instructions.
– or –
Select **Main**, select **Save Changes and Exit**, and then press [enter](#).

Your changes go into effect when the computer restarts.

 **NOTE:** Your password settings and security settings are not changed when you restore the factory settings.

Updating the BIOS

Updated versions of the BIOS may be available on the HP website.

Most BIOS updates on the HP website are packaged in compressed files called *SoftPaqs*.

Some download packages contain a file named *Readme.txt*, which contains information regarding installing and troubleshooting the file.

Determining the BIOS version

To decide whether you need to update Computer Setup (BIOS), first determine the BIOS version on your computer.

BIOS version information (also known as *ROM date* and *System BIOS*) can be accessed by pressing **fn+esc** (if you are already in Windows) or by using Computer Setup.

1. Start Computer Setup. See [Starting Computer Setup on page 141](#).
2. Select **Main**, and then select **System Information**.
3. To exit Computer Setup without saving your changes, select the **Exit** icon in the lower-right corner of the screen, and then follow the on-screen instructions.

– or –

Select **Main**, select **Ignore Changes and Exit**, and then press **enter**.

To check for later BIOS versions, see [Downloading a BIOS update on page 143](#).

Downloading a BIOS update

 **CAUTION:** To reduce the risk of damage to the computer or an unsuccessful installation, download and install a BIOS update only when the computer is connected to reliable external power using the AC adapter. Do not download or install a BIOS update while the computer is running on battery power, docked in an optional docking device, or connected to an optional power source. During the download and installation, follow these instructions:

Do not disconnect power on the computer by unplugging the power cord from the AC outlet.

Do not shut down the computer or initiate Sleep.

Do not insert, remove, connect, or disconnect any device, cable, or cord.

1. Type `support` in the taskbar search box, and then select the HP Support Assistant app.
– or –
Select the question mark icon in the taskbar.
2. Select **Updates**, and then select **Check for updates and messages**.
3. Follow the on-screen instructions.
4. At the download area, follow these steps:
 - a. Identify the most recent BIOS update and compare it to the BIOS version currently installed on your computer. Make a note of the date, name, or other identifier. You may need this information to locate the update later, after it has been downloaded to your hard drive.
 - b. Follow the on-screen instructions to download your selection to the hard drive.
Make a note of the path to the location on your hard drive where the BIOS update is downloaded. You will need to access this path when you are ready to install the update.

 **NOTE:** If you connect your computer to a network, consult the network administrator before installing any software updates, especially system BIOS updates.

BIOS installation procedures vary. Follow any instructions that are revealed on the screen after the download is complete. If no instructions are revealed, follow these steps:

1. Type `file` in the taskbar search box, and then select **File Explorer**.
2. Select your hard drive designation. The hard drive designation is typically Local Disk (C:).
3. Using the hard drive path you recorded earlier, open the folder that contains the update.
4. Double-click the file that has an `.exe` extension (for example, `filename.exe`).
The BIOS installation begins.
5. Complete the installation by following the on-screen instructions.

 **NOTE:** After a message on the screen reports a successful installation, you can delete the downloaded file from your hard drive.

Changing the boot order using the f9 prompt

To dynamically choose a boot device for the current startup sequence, follow these steps:

1. Access the Boot Device Options menu:
 - Computers or tablets with keyboards:
 - ▲ Turn on or restart the computer, and when the HP logo appears, press **f9** to enter the Boot Device Options menu.
 - Tablets without keyboards:
 - ▲ Turn off the tablet. Press the power button in combination with the volume down button until the Startup menu is displayed, and then tap **F9** to enter the Boot Device Options menu.
2. Select a boot device, then press `enter`.

TPM BIOS settings (select products only)

 **IMPORTANT:** Before enabling Trusted Platform Module (TPM) functionality on this system, you must ensure that your intended use of TPM complies with relevant local laws, regulations and policies, and approvals or licenses must be obtained if applicable. For any compliance issues arising from your operation/usage of TPM which violates the above mentioned requirement, you shall bear all the liabilities wholly and solely. HP will not be responsible for any related liabilities.

TPM provides additional security for your computer. You can modify the TPM settings in Computer Setup (BIOS).

 **NOTE:** If you change the TPM setting to Hidden, TPM is not visible in the operating system.

To access TPM settings in Computer Setup:

1. Start Computer Setup. See [Starting Computer Setup on page 141](#).
2. Select **Security**, select **TPM Embedded Security**, and then follow the on-screen instructions.

Using HP Sure Start (select products only)

Select computer models are configured with HP Sure Start, a technology that monitors the computer's BIOS for attacks or corruption. If the BIOS becomes corrupted or is attacked, HP Sure Start automatically restores the BIOS to its previously safe state, without user intervention.

HP Sure Start is configured and already enabled so that most users can use the HP Sure Start default configuration. The default configuration can be customized by advanced users.

To access the latest documentation on HP Sure Start, go to <http://www.hp.com/support>, and select your country. Select **Drivers & Downloads**, and then follow the on-screen instructions.

10 Using HP PC Hardware Diagnostics (UEFI)

HP PC Hardware Diagnostics is a Unified Extensible Firmware Interface (UEFI) that allows you to run diagnostic tests to determine whether the computer hardware is functioning properly. The tool runs outside the operating system so that it can isolate hardware failures from issues that are caused by the operating system or other software components.

When HP PC Hardware Diagnostics (UEFI) detects a failure that requires hardware replacement, a 24-digit Failure ID code is generated. This ID code can then be provided to support to help determine how to correct the problem.

 **NOTE:** To start diagnostics on a convertible computer, your computer must be in notebook mode and you must use the keyboard attached.

To start HP PC Hardware Diagnostics (UEFI), follow these steps:

1. Turn on or restart the computer, and quickly press *esc*.
2. Press *f2*.

The BIOS searches three places for the diagnostic tools, in the following order:

- a. Connected USB drive

 **NOTE:** To download the HP PC Hardware Diagnostics (UEFI) tool to a USB drive, see [Downloading HP PC Hardware Diagnostics \(UEFI\) to a USB device on page 146](#).

- b. Hard drive

- c. BIOS

3. When the diagnostic tool opens, select the type of diagnostic test you want to run, and then follow the on-screen instructions.

 **NOTE:** If you need to stop a diagnostic test, press *esc*.

Downloading HP PC Hardware Diagnostics (UEFI) to a USB device

 **NOTE:** The HP PC Hardware Diagnostics (UEFI) download instructions are provided in English only, and you must use a Windows computer to download and create the HP UEFI support environment because only .exe files are offered.

There are two options to download HP PC Hardware Diagnostics to a USB device.

Download the latest UEFI version

1. Go to <http://www.hp.com/go/techcenter/pcdiags>. The HP PC Diagnostics home page is displayed.
2. In the HP PC Hardware Diagnostics section, click the **Download** link, and then select **Run**.

Download any version of UEFI for a specific product

1. Go to <http://www.hp.com/support>, and then select your country. The HP Support page is displayed.
2. Click **Drivers & Downloads**.

3. Use the categories listed to find your product.

– or –

Click **Find Now** to let HP automatically detect your product.

4. Select your computer, and then select your operating system.

5. In the **Diagnostic** section, follow the on-screen instructions to select and download the UEFI version you want.

11 Backup and recovery in Windows 7

Your computer includes HP and Windows tools to help you safeguard your information and retrieve it if you ever need to. These tools will help you return your computer to a proper working state, all with simple steps. This section provides information about the following processes:

- Creating recovery media and backups
- Restoring and recovering your system

Creating recovery media and backups

Recovery after a system failure is only as good as your most recent backup.

1. After you successfully set up the computer, create HP Recovery media. This step creates a Windows 7 operating system DVD and a *Driver Recovery* DVD. The Windows DVD can be used to reinstall the original operating system in cases where the hard drive is corrupted or has been replaced. The *Driver Recovery* DVD installs specific drivers and applications. See [Creating recovery media with HP Recovery Disc Creator on page 148](#).
2. Use Windows Backup and Recovery tools to perform the following:
 - Back up individual files and folders
 - Back up your entire hard drive (select models only)
 - Create system repair discs (select models only) with the installed optical drive (select models only) or an optional external optical drive
 - Create system restore points

 **NOTE:** This guide describes an overview of backing up, restoring, and recovering options. For more details about the tools provided, see Help and Support. To access Help and Support, select **Start > Help and Support**.

 **NOTE:** HP recommends that you print the recovery procedures and save them for later use, in case of system instability.

In case of system failure, you can use the backup files to restore the contents of your computer. See [Backing up your information on page 149](#).

Guidelines

- When creating recovery media or backing up to discs, use any of the following types of discs (purchased separately): DVD+R, DVD+R DL, DVD-R, DVD-R DL, or DVD±RW. The discs you use will depend on the type of optical drive you are using.
- Be sure that the computer is connected to AC power before you start the recovery media creation process or the backup process.

Creating recovery media with HP Recovery Disc Creator

HP Recovery Disc Creator is a software program that offers an alternative way to create recovery media. After you successfully set up the computer, you can create recovery media using HP Recovery Disc Creator. This recovery media allows you to reinstall your original operating system as well as select drivers and

applications if the hard drive becomes corrupted. HP Recovery Disc Creator can create two kinds of recovery DVDs:

- Windows 7 operating system DVD—Installs the operating system without additional drivers or applications.
- *Driver Recovery* DVD—Installs specific drivers and applications only, in the same way that the HP Software Setup utility installs drivers and applications.

Creating recovery media

 **NOTE:** The Windows 7 operating system DVD can be created only once. Thereafter, the option to create that media will not be available after you create a Windows DVD.

To create the Windows DVD:

1. Select **Start > All Programs > Productivity and Tools > HP Recovery Disc Creator**.
2. Select **Windows disk**.
3. From the drop-down menu, select the drive for burning the recovery media.
4. Click the **Create** button to start the burning process.

After the Windows 7 operating system DVD has been created, create the *Driver Recovery* DVD:

1. Select **Start > All Programs > Productivity and Tools > HP Recovery Disc Creator**.
2. Select **Driver disk**.
3. From the drop-down menu, select the drive for burning the recovery media.
4. Click the **Create** button to start the burning process.

Backing up your information

You should create system repair media and your initial backup immediately after initial system setup. As you add new software and data files, you should continue to back up your system on a regular basis to maintain a reasonably current backup. You should also create Windows system repair media (select models only) which can be used to start up (boot) the computer and repair the operating system in case of system instability or failure. Your initial and subsequent backups allow you to restore your data and settings if a failure occurs.

You can back up your information to an optional external hard drive, a network drive, or discs.

Note the following when backing up:

- Store personal files in the Documents library, and back it up regularly.
- Back up templates that are stored in their associated directories.
- Save customized settings that appear in a window, toolbar, or menu bar by taking a screen shot of your settings. The screen shot can be a time-saver if you have to reset your preferences.
- When backing up to discs, number each disc after removing it from the drive.

 **NOTE:** For detailed instructions on various backup and restore options, perform a search for these topics in Help and Support. To access Help and Support, select **Start > Help and Support**.

 **NOTE:** Windows includes the User Account Control feature to improve the security of your computer. You may be prompted for your permission or password for tasks such as installing software, running utilities, or changing Windows settings. Refer to Help and Support. To access Help and Support, select **Start > Help and Support**.

To create a backup using Windows Backup and Restore:

 **NOTE:** The backup process may take over an hour, depending on file size and the speed of the computer.

1. Select **Start > All Programs > Maintenance > Backup and Restore**.
2. Follow the on-screen instructions to set up your backup, create a system image (select models only), or create system repair media (select models only).

Performing a system recovery

In case of system failure or instability, the computer provides the following tools to recover your files:

- Windows recovery tools: You can use Windows Backup and Restore to recover information you have previously backed up. You can also use Windows Startup Repair to fix problems that might prevent Windows from starting correctly.
- f11 recovery tools (select models only): You can use the f11 recovery tools to recover your original hard drive image. The image includes the Windows operating system and software programs installed at the factory.

 **NOTE:** If you are unable to boot (start up) your computer and you cannot use the system repair media you previously created (select models only), you must purchase Windows 7 operating system media to reboot the computer and repair the operating system. For additional information, see [Using Windows 7 operating system media on page 151](#).

Using the Windows recovery tools

Using the Windows recovery tools, you can:

- Recover individual files
- Restore the computer to a previous system restore point
- Recover information using recovery tools

 **NOTE:** For detailed instructions on various recovery and restore options, perform a search for these topics in Help and Support. To access Help and Support, select **Start > Help and Support**.

 **NOTE:** Windows includes the User Account Control feature to improve the security of your computer. You may be prompted for your permission or password for tasks such as installing software, running utilities, or changing Windows settings. Refer to Help and Support. To access Help and Support, select **Start > Help and Support**.

To recover information you previously backed up:

1. Select **Start > All Programs > Maintenance > Backup and Restore**.
2. Follow the on-screen instructions to recover your system settings, your computer (select models only), or your files.

To recover your information using Startup Repair, follow these steps:

 **CAUTION:** Some Startup Repair options will completely erase and reformat the hard drive. All files you have created and any software installed on the computer are permanently removed. When reformatting is complete, the recovery process restores the operating system, as well as the drivers, software, and utilities from the backup used for recovery.

1. If possible, back up all personal files.
2. If possible, check for the presence of the Windows partition.

To check for the Windows partition, select **Start > Computer**.



NOTE: If the Windows partition is not listed, you must recover your operating system and programs using the Windows 7 operating system DVD and the *Driver Recovery* media. For additional information, see [Using Windows 7 operating system media on page 151](#).

3. If the Windows partition is listed, restart the computer, and then press **f8** before the Windows operating system loads.
4. Select **Startup Repair**.
5. Follow the on-screen instructions.



NOTE: For additional information on recovering information using the Windows tools, select **Start > Help and Support**.

Using f11 recovery tools (select models only)



CAUTION: Using **f11** completely erases hard drive contents and reformats the hard drive. All files that you have created and any software that you have installed on the computer are permanently removed. The **f11** recovery tool reinstalls the operating system and HP programs and drivers that were installed at the factory. Software not installed at the factory must be reinstalled.

To recover the original hard drive image using **f11**:

1. If possible, back up all personal files.
2. If possible, check for the presence of the HP Recovery partition: click **Start**, right-click **Computer**, click **Manage**, and then click **Disk Management**.



NOTE: If the HP Recovery partition is not listed, you must recover your operating system and programs using the Windows 7 operating system media and the *Driver Recovery* media. For additional information, see [Using Windows 7 operating system media on page 151](#).

3. If the HP Recovery partition is listed, restart the computer, and then press **esc** while the “Press the ESC key for Startup Menu” message is displayed at the bottom of the screen.
4. Press **f11** while the “Press <F11> for recovery” message is displayed on the screen.
5. Follow the on-screen instructions.

Using Windows 7 operating system media

If you cannot use the recovery media you previously created using the HP Recovery Disc Creator (select models only), you must purchase a Windows 7 operating system DVD to reboot the computer and repair the operating system.

To order a Windows 7 operating system DVD, go to the HP website. For U.S. support, go to <http://www.hp.com/support>. For worldwide support, go to http://welcome.hp.com/country/us/en/wwcontact_us.html. You can also order the DVD by calling support. For contact information, see the *Worldwide Telephone Numbers* booklet included with the computer.



CAUTION: Using a Windows 7 operating system DVD completely erases hard drive contents and reformats the hard drive. All files that you have created and any software that you have installed on the computer are permanently removed. When reformatting is complete, the recovery process helps you restore the operating system, as well as drivers, software, and utilities.

To initiate recovery using a Windows 7 operating system DVD:



NOTE: This process takes several minutes.

1. If possible, back up all personal files.
2. Restart the computer, and then insert the Windows 7 operating system DVD into the optical drive before the Windows operating system loads.
3. When prompted, press any keyboard key.
4. Follow the on-screen instructions.
5. Click **Next**.
6. Select **Repair your computer**.
7. Follow the on-screen instructions.

After the repair is completed:

1. Eject the Windows 7 operating system DVD and then insert the *Driver Recovery* DVD.
2. Install the Hardware Enabling Drivers first, and then install Recommended Applications.

12 Backing up, restoring, and recovering in Windows 10

This chapter provides information about the following processes. The information in the chapter is standard procedure for most products.

- Creating recovery media and backups
- Restoring and recovering your system

For additional information, refer to the HP Support Assistant app.

- ▲ Type `support` in the taskbar search box, and then select the **HP Support Assistant** app.

– or –

Click the question mark icon in the taskbar.

 **IMPORTANT:** If you will be performing recovery procedures on a tablet, the tablet battery must be at least 70% charged before you start the recovery process.

IMPORTANT: For a tablet with a detachable keyboard, connect the keyboard to the keyboard dock before beginning any recovery process.

Creating recovery media and backups

The following methods of creating recovery media and backups are available on select products only. Choose the available method according to your computer model.

- Use HP Recovery Manager to create HP Recovery media after you successfully set up the computer. This step creates a backup of the HP Recovery partition on the computer. The backup can be used to reinstall the original operating system in cases where the hard drive is corrupted or has been replaced. For information on creating recovery media, see [Creating HP Recovery media \(select products only\) on page 153](#). For information on the recovery options that are available using the recovery media, see [Using Windows tools on page 154](#).

- Use Windows tools to create system restore points and create backups of personal information.

For more information, see [Recovering using HP Recovery Manager on page 155](#).

 **NOTE:** If storage is 32 GB or less, System Restore is disabled by default.

Creating HP Recovery media (select products only)

If possible, check for the presence of the Recovery partition and the Windows partition. From the **Start** menu, select **File Explorer**, and then select **This PC**.

- If your computer does not list the Windows partition and the Recovery partition, you can obtain recovery media for your system from support. See the *Worldwide Telephone Numbers* booklet included with the computer. You can also find contact information on the HP website. Go to <http://www.hp.com/support>, select your country or region, and follow the on-screen instructions.

You can use Windows tools to create system restore points and create backups of personal information, see [Using Windows tools on page 154](#).

- If your computer does list the Recovery partition and the Windows partition, you can use HP Recovery Manager to create recovery media after you successfully set up the computer. HP Recovery media can be used to perform system recovery if the hard drive becomes corrupted. System recovery reinstalls the original operating system and software programs that were installed at the factory and then configures the settings for the programs. HP Recovery media can also be used to customize the system or restore the factory image if you replace the hard drive.
 - Only one set of recovery media can be created. Handle these recovery tools carefully, and keep them in a safe place.
 - HP Recovery Manager examines the computer and determines the required storage capacity for the media that will be required.
 - To create recovery discs, your computer must have an optical drive with DVD writer capability, and you must use only high-quality blank DVD-R, DVD+R, DVD-R DL, or DVD+R DL discs. Do not use rewritable discs such as CD±RW, DVD±RW, double-layer DVD±RW, or BD-RE (rewritable Blu-ray) discs; they are not compatible with HP Recovery Manager software. Or, instead, you can use a high-quality blank USB flash drive.
 - If your computer does not include an integrated optical drive with DVD writer capability, but you would like to create DVD recovery media, you can use an external optical drive (purchased separately) to create recovery discs. If you use an external optical drive, it must be connected directly to a USB port on the computer; the drive cannot be connected to a USB port on an external device, such as a USB hub. If you cannot create DVD media yourself, you can obtain recovery discs for your computer from HP. See the *Worldwide Telephone Numbers* booklet included with the computer. You can also find contact information on the HP website. Go to <http://www.hp.com/support>, select your country or region, and follow the on-screen instructions.
 - Be sure that the computer is connected to AC power before you begin creating the recovery media.
 - The creation process can take an hour or more. Do not interrupt the creation process.
 - If necessary, you can exit the program before you have finished creating all of the recovery DVDs. HP Recovery Manager will finish burning the current DVD. The next time you start HP Recovery Manager, you will be prompted to continue.

To create HP Recovery media:



IMPORTANT: For a tablet with a detachable keyboard, connect the keyboard to the keyboard dock before beginning these steps.

1. Type `recovery` in the taskbar search box, and then select **HP Recovery Manager**.
2. Select **Create recovery media**, and then follow the on-screen instructions.

If you ever need to recover the system, see [Recovering using HP Recovery Manager on page 155](#).

Using Windows tools

You can create recovery media, system restore points, and backups of personal information using Windows tools.



NOTE: If storage is 32 GB or less, Microsoft System Restore is disabled by default.

For more information and steps, see the Get started app.

- ▲ Select the **Start** button, and then select the **Get started** app.

Restore and recovery

There are several options for recovering your system. Choose the method that best matches your situation and level of expertise:

 **IMPORTANT:** Not all methods are available on all products.

- Windows offers several options for restoring from backup, refreshing the computer, and resetting the computer to its original state. For more information see the Get started app.
 - ▲ Select the **Start** button, and then select the **Get started** app.
- If you need to correct a problem with a preinstalled application or driver, use the Reinstall drivers and/or applications option (select products only) of HP Recovery Manager to reinstall the individual application or driver.
 - ▲ Type `recovery` in the taskbar search box, select **HP Recovery Manager**, select **Reinstall drivers and/or applications**, and then follow the on-screen instructions.
- If you want to recover the Windows partition to original factory content, you can choose the System Recovery option from the HP Recovery partition (select products only) or use the HP Recovery media. For more information, see [Recovering using HP Recovery Manager on page 155](#). If you have not already created recovery media, see [Creating HP Recovery media \(select products only\) on page 153](#).
- On select products, if you want to recover the computer's original factory partition and content, or if you have replaced the hard drive, you can use the Factory Reset option of HP Recovery media. For more information, see [Recovering using HP Recovery Manager on page 155](#).
- On select products, if you want to remove the recovery partition to reclaim hard drive space, HP Recovery Manager offers the Remove Recovery Partition option.

For more information, see [Removing the HP Recovery partition \(select products only\) on page 157](#).

Recovering using HP Recovery Manager

HP Recovery Manager software allows you to recover the computer to its original factory state by using the HP Recovery media that you either created or that you obtained from HP, or by using the HP Recovery partition (select products only). If you have not already created recovery media, see [Creating HP Recovery media \(select products only\) on page 153](#).

What you need to know before you get started

- HP Recovery Manager recovers only software that was installed at the factory. For software not provided with this computer, you must either download the software from the manufacturer's website or reinstall the software from the media provided by the manufacturer.

 **IMPORTANT:** Recovery through HP Recovery Manager should be used as a final attempt to correct computer issues.

- HP Recovery media must be used if the computer hard drive fails. If you have not already created recovery media, see [Creating HP Recovery media \(select products only\) on page 153](#).
- To use the Factory Reset option (select products only), you must use HP Recovery media. If you have not already created recovery media, see [Creating HP Recovery media \(select products only\) on page 153](#).
- If your computer does not allow the creation of HP Recovery media or if the HP Recovery media does not work, you can obtain recovery media for your system from support. See the *Worldwide Telephone Numbers* booklet included with the computer. You can also find contact information from the HP

website. Go to <http://www.hp.com/support>, select your country or region, and follow the on-screen instructions.

 **IMPORTANT:** HP Recovery Manager does not automatically provide backups of your personal data. Before beginning recovery, back up any personal data you want to retain.

Using HP Recovery media, you can choose from one of the following recovery options:

 **NOTE:** Only the options available for your computer display when you start the recovery process.

- System Recovery—Reinstalls the original operating system, and then configures the settings for the programs that were installed at the factory.
- Factory Reset—Restores the computer to its original factory state by deleting all information from the hard drive and re-creating the partitions. Then it reinstalls the operating system and the software that was installed at the factory.

The HP Recovery partition (select products only) allows System Recovery only.

Using the HP Recovery partition (select products only)

The HP Recovery partition allows you to perform a system recovery without the need for recovery discs or a recovery USB flash drive. This type of recovery can be used only if the hard drive is still working.

To start HP Recovery Manager from the HP Recovery partition:

 **IMPORTANT:** For a tablet with a detachable keyboard, connect the keyboard to the keyboard dock before beginning these steps (select products only).

1. Type `recovery` in the taskbar search box, select **Recovery Manager**, and then select **HP Recovery Environment**.

- or -

For computers or tablets with keyboards attached, press **f11** while the computer boots, or press and hold **f11** as you press the power button.

For tablets without keyboards:

Turn on or restart the tablet, and then quickly hold down the volume down button; then select **f11**.

- or -

Turn on or restart the tablet, and then quickly hold down the Windows button; then select **f11**.

2. Select **Troubleshoot** from the boot options menu.
3. Select **Recovery Manager**, and then follow the on-screen instructions.

Using HP Recovery media to recover

You can use HP Recovery media to recover the original system. This method can be used if your system does not have an HP Recovery partition or if the hard drive is not working properly.

1. If possible, back up all personal files.
2. Insert the HP Recovery media, and then restart the computer.

 **NOTE:** If the computer does not automatically restart in HP Recovery Manager, change the computer boot order. See [Changing the computer boot order on page 157](#).

3. Follow the on-screen instructions.

Changing the computer boot order

If your computer does not restart in HP Recovery Manager, you can change the computer boot order, which is the order of devices listed in BIOS where the computer looks for startup information. You can change the selection to an optical drive or a USB flash drive.

To change the boot order:

 **IMPORTANT:** For a tablet with a detachable keyboard, connect the keyboard to the keyboard dock before beginning these steps.

1. Insert the HP Recovery media.
2. Access BIOS:

For computers or tablets with keyboards attached:

- ▲ Turn on or restart the computer or tablet, quickly press **esc**, and then press **f9** for boot options.

For tablets without keyboards:

- ▲ Turn on or restart the tablet, and then quickly hold down the volume down button; then select **f9**.

- or -

Turn on or restart the tablet, and then quickly hold down the Windows button; then select **f9**.

3. Select the optical drive or USB flash drive from which you want to boot.
4. Follow the on-screen instructions.

Removing the HP Recovery partition (select products only)

HP Recovery Manager software allows you to remove the HP Recovery partition to free up hard drive space.

 **IMPORTANT:** After you remove the HP Recovery partition, you will not be able to perform System Recovery or create HP recovery media from the HP Recovery partition. So before you remove the Recovery partition, create HP Recovery media; see [Creating HP Recovery media \(select products only\) on page 153](#).

 **NOTE:** The Remove Recovery Partition option is only available on products that support this function.

Follow these steps to remove the HP Recovery partition:

1. Type `recovery` in the taskbar search box, and then select **HP Recovery Manager**.
2. Select **Remove Recovery Partition**, and then follow the on-screen instructions.

13 Specifications

Computer specifications

| | Metric | U.S. |
|---|--|---------------------|
| Dimensions | | |
| Width | 375 mm | 14.76 in |
| Depth | 255 mm | 10.04 in |
| Height (front to rear, LED display assembly) | 18 mm | 0.71 in |
| Weight (computer equipped with Intel Dual Core processor, 500-GB hard drive, optical drive, one memory module, WLAN module, fingerprint reader, modem module, and 8-cell battery) | 2.93 kg | 6.45 lb |
| Weight (computer equipped with Intel Dual Core processor one memory module, 128-GB solid-state drive, WLAN module, fingerprint reader, and 8-cell battery) | 2.16 kg | 4.76 lb |
| Input power | | |
| Operating voltage and current | 19.5 V dc @ 6.15 A - 120 W, Slim Smart AC Adapter (select models only) | |
| | 19.5 V dc @ 7.69 A - 150 W, Slim Smart AC Adapter (select models only) | |
| | 19.5 V dc @ 10.3A - 200 W, Slim Smart AC Adapter (select models only) | |
| Temperature | | |
| Operating | 5°C to 35°C | 41°F to 95°F |
| Nonoperating | -20°C to 60°C | -4°F to 140°F |
| Relative humidity (non-condensing) | | |
| Operating | 10% to 90% | |
| Nonoperating | 5% to 95% | |
| Maximum altitude (unpressurized) | | |
| Operating | -15 m to 3,048 m | -50 ft to 10,000 ft |
| Nonoperating | -15 m to 12,192 m | -50 ft to 40,000 ft |
| NOTE: Applicable product safety standards specify thermal limits for plastic surfaces. The device operates well within this range of temperatures. | | |

14 Statement of memory volatility

The purpose of this chapter is to provide general information regarding nonvolatile memory in HP Business PCs. This chapter also provides general instructions for restoring nonvolatile memory that can contain personal data after the system has been powered off and the hard drive has been removed.

HP Business PC products that use Intel®-based or AMD®-based system boards contain volatile DDR memory. The amount of nonvolatile memory present in the system depends upon the system configuration. Intel-based and AMD-based system boards contain nonvolatile memory subcomponents as originally shipped from HP, assuming that no subsequent modifications have been made to the system and assuming that no applications, features, or functionality have been added to or installed on the system.

Following system shutdown and removal of all power sources from an HP Business PC system, personal data can remain on volatile system memory (DIMMs) for a finite period of time and will also remain in nonvolatile memory. Use the steps below to remove personal data from the PC, including the nonvolatile memory found in Intel-based and AMD-based system boards.

 **NOTE:** If your tablet has a keyboard base, connect to the keyboard base before beginning steps in this chapter.

Current BIOS steps

1. Follow steps (a) through (l) below to restore the nonvolatile memory that can contain personal data. Restoring or reprogramming nonvolatile memory that does not store personal data is neither necessary nor recommended.
 - a. Turn on or restart the computer, and then press **esc** while the "Press the ESC key for Startup Menu" message is displayed at the bottom of the screen.

 **IMPORTANT:** If the **Main** menu displays **Restore Defaults** instead of **Apply Factory Defaults and Exit**, go to [Legacy BIOS Steps on page 160](#).

 **NOTE:** If the system has a BIOS administrator password, enter the password at the prompt.
 - b. Select **Main**, select **Apply Factory Defaults and Exit**, and then select **Yes** to load defaults.
The computer will reboot.
 - c. During the reboot, press **esc** while the "Press the ESC key for Startup Menu" message is displayed at the bottom of the screen.

 **NOTE:** If the system has a BIOS administrator password, enter the password at the prompt.
 - d. Select the **Security** menu, select **Restore Security Settings to Factory Defaults**, and then select **Yes** to restore security level defaults.
The computer will reboot.
 - e. During the reboot, press **esc** while the "Press the ESC key for Startup Menu" message is displayed at the bottom of the screen.

 **NOTE:** If the system has a BIOS administrator password, enter the password at the prompt.
 - f. If an asset or ownership tag is set, select the **Security** menu and scroll down to the **Utilities** menu. Select **System IDs**, and then select **Asset Tracking Number**. Clear the tag, and then make the selection to return to the prior menu.

- g. If a DriveLock password is set, select the **Security** menu, and scroll down to **Hard Drive Utilities** under the **Utilities** menu. Select **Hard Drive Utilities**, select **DriveLock**, then uncheck the checkbox for **DriveLock password on restart**. Select **OK** to proceed.
- h. Select the **Main** menu, and then select **Reset BIOS Security to factory default**. Click **Yes** at the warning message.
The computer will reboot.
- i. During the reboot, press **esc** while the "Press the ESC key for Startup Menu" message is displayed at the bottom of the screen.



NOTE: If the system has a BIOS administrator password, enter the password at the prompt.

- j. Select the **Main** menu, select **Apply Factory Defaults and Exit**, select **Yes** to save changes and exit, and then select **Shutdown**.
 - k. Reboot the system. If the system has a Trusted Platform Module (TPM) and/or fingerprint reader, one or two prompts will appear—one to clear the TPM and the other to Reset Fingerprint Sensor; press or tap **F1** to accept or **F2** to reject.
 - l. Remove all power and system batteries for at least 24 hours.
2. Complete one of the following:
- Remove and retain the storage drive.
 - or –
 - Clear the drive contents by using a third party utility designed to erase data from an SSD.
 - or –
 - Clear the contents of the drive by using the following BIOS Setup Secure Erase command option steps:



IMPORTANT: If you clear data using Secure Erase, it cannot be recovered.

- a. Turn on or restart the computer, and then press **esc** while the "Press the ESC key for Startup Menu" message is displayed at the bottom of the screen.
- b. Select the **Security** menu and scroll down to the **Utilities** menu.
- c. Select **Hard Drive Tools**.
- d. Under **Utilities**, select **Secure Erase**, select the hard drive storing the data you want to clear, and then follow the on-screen instructions to continue.

Legacy BIOS Steps

Use the steps for older versions of BIOS.



NOTE: If you already completed the steps in [Current BIOS steps on page 159](#), skip this section.

1. Follow steps (a) through (i) below to restore the nonvolatile memory that can contain personal data. Restoring or reprogramming nonvolatile memory that does not store personal data is neither necessary nor recommended.



NOTE: If you have not already done so, access the BIOS menu.

- Turn on or restart the computer, and then press **esc** while the "Press the ESC key for Startup Menu" message is displayed at the bottom of the screen.

 **NOTE:** If the system has a BIOS administrator password, enter the password at the prompt.

- a. Select **Main**, select **Restore Defaults**, and then select **Yes** to load defaults.
 - b. Select the **Security** menu, select **Restore Security Level Defaults**, and then select **Yes** to restore security level defaults.
 - c. If an asset or ownership tag is set, select the **Security** menu and scroll down to the **Utilities** menu. Select **System IDs**, and then select **Asset Tracking Number**. Clear the tag, and then make the selection to return to the prior menu.
 - d. If a DriveLock password is set, select the **Security** menu, and scroll down to **Hard Drive Tools** under the **Utilities** menu. Select **Hard Drive Tools**, select **DriveLock**, then uncheck the checkbox for **DriveLock password on restart**. Select **OK** to proceed.
 - e. If an Automatic DriveLock password is set, select the **Security** menu, scroll down to **Hard Drive Tools** under the **Utilities** menu. Select **Hard Drive Tools**, scroll down to **Automatic DriveLock**, then select the desired hard drive and disable protection. At the automatic drive lock warning screen, select **Yes** to continue. Repeat this procedure if more than one hard drive has an Automatic DriveLock password.
 - f. Select the **Main** menu, and then select **Reset BIOS Security to factory default**. Click **Yes** at the warning message.
 - g. Select the **Main** menu, select **Save Changes and Exit**, select **Yes** to save changes and exit, and then select **Shutdown**.
 - h. Reboot the system. If the system has a Trusted Platform Module (TPM) and/or fingerprint reader, one or two prompts will appear—one to clear the TPM and the other to Reset Fingerprint Sensor; press or tap **F1** to accept or **F2** to reject.
 - i. Remove all power and system batteries for at least 24 hours.
2. Complete one of the following:
- Remove and retain the storage drive.
 - or –
 - Clear the drive contents by using a third party utility designed to erase data from an SSD.
 - or –
 - Clear the contents of the drive by using the following BIOS Setup Secure Erase command option steps:

 **IMPORTANT:** If you clear data using Secure Erase, it cannot be recovered.

- a. Turn on or restart the computer, and then press **esc** while the "Press the ESC key for Startup Menu" message is displayed at the bottom of the screen.
 - b. Select the **Security** menu and scroll down to the **Utilities** menu.
 - c. Select **Hard Drive Tools**.
 - d. Under **Utilities**, select **Secure Erase**, select the hard drive storing the data you want to clear, and then follow the on-screen instructions to continue.
- or –
- Clear the contents of the drive by using the following Disk Sanitizer command steps:

 **IMPORTANT:** If you clear data using Disk Sanitizer, it cannot be recovered.

 **NOTE:** The amount of time it takes for Disk Sanitizer to run can take several hours. Plug the computer into an AC outlet before starting.

- a. Turn on or restart the computer, and then press **esc** while the "Press the ESC key for Startup Menu" message is displayed at the bottom of the screen.
- b. Select the **Security** menu and scroll down to the **Utilities** menu.
- c. Select **Hard Drive Tools**.
- d. Under **Utilities**, select **Disk Sanitizer**, select the hard drive storing the data you want to clear, and then follow the on-screen instructions to continue.

Nonvolatile memory usage

| Nonvolatile Memory Type | Amount (Size) | Does this memory store customer data? | Does this memory retain data when power is removed? | What is the purpose of this memory? | How is data input into this memory? | How is this memory write-protected? |
|---|---|---------------------------------------|---|---|--|--|
| HP Sure Start flash (select models only) | 2 MBytes | No | Yes | Provides protected backup of critical System BIOS code, EC firmware, and critical PC configuration data for select platforms that support HP Sure Start. For more information, see Using HP Sure Start (select models only) on page 166. | Data cannot be written to this device via the host processor. The content is managed solely by the HP Sure Start Embedded Controller. | This memory is protected by the HP Sure Start Embedded Controller. |
| Real Time Clock (RTC) battery backed-up CMOS configuration memory | 256 Bytes | No | Yes | Stores system date and time and noncritical data. | RTC battery backed-up CMOS is programmed using the Computer Setup (BIOS), or changing the Windows date & time. | This memory is not write-protected. |
| Controller (NIC) EEPROM | 64 KBytes (not customer accessible) | No | Yes | Stores NIC configuration and NIC firmware. | NIC EEPROM is programmed using a utility from the NIC vendor that can be run from DOS. | A utility is required to write data to this memory and is available from the NIC vendor. Writing data to this ROM in an inappropriate manner will render the NIC non-functional. |
| DIMM Serial Presence Detect (SPD) configuration data | 256 Bytes per memory module, 128 Bytes programmable (not customer accessible) | No | Yes | Stores memory module information. | DIMM SPD is programmed by the memory vendor. | Data cannot be written to this memory when the module is installed in a PC. The specific write-protection method varies by memory vendor. |
| System BIOS | 4 MBytes to 5 MBytes | Yes | Yes | Stores system BIOS code and PC configuration data. | System BIOS code is programmed at the factory. Code is updated when the system BIOS is updated. Configuration data and settings are input using the Computer Setup (BIOS) or a custom utility. | NOTE: Writing data to this ROM in an inappropriate manner can render the PC non-functional. A utility is required for writing data to this memory and is available on the HP website; go to http://www.hp.com/support , and select your country. Select Drivers & |

| Nonvolatile Memory Type | Amount (Size) | Does this memory store customer data? | Does this memory retain data when power is removed? | What is the purpose of this memory? | How is data input into this memory? | How is this memory write-protected? |
|--|------------------------|---------------------------------------|---|---|---|---|
| Intel Management Engine Firmware (present in only specific ZBook and EliteBook models. For more information, go to http://www.hp.com/support , and select your country. Select Drivers & Downloads , and then follow the on-screen instructions.) | 1.5 MBytes or 5 MBytes | Yes | Yes | Stores Management Engine Code, Settings, Provisioning Data and iAMT third-party data store. | Management Engine Code is programmed at the factory. Code is updated via Intel secure firmware update utility. Unique Provisioning Data can be entered at the factory or by an administrator using the Management Engine (MEBx) setup utility. The third party data store contents can be populated by a remote management console or local applications that have been registered by an administrator to have access to the space. | Downloads , and then follow the on-screen instructions. The Intel chipset is configured to enforce hardware protection to block all direct read/write access to this area. An Intel utility is required for updating the firmware. Only firmware updates digitally signed by Intel can be applied using this utility. |
| Bluetooth flash | 2 Mbit | No | Yes | Stores Bluetooth configuration and firmware. | Bluetooth flash is programmed at the factory. Tools for writing data to this memory are not publicly available but can be obtained from the silicon vendor. | A utility is required for writing data to this memory and is made available through newer versions of the driver whenever the flash requires an upgrade. |
| 802.11 WLAN EEPROM | 4 Kbit to 8 Kbit | No | Yes | Stores configuration and calibration data. | 802.11 WLAN EEPROM is programmed at the factory. Tools for writing data to this memory are not made public. | A utility is required for writing data to this memory and is typically not made available to the public unless a firmware upgrade is necessary to address a unique issue. |
| Web camera | 64 Kbit | No | Yes | Stores webcam configuration and firmware. | Webcam memory is programmed using a utility from the device manufacturer that can be run from Windows. | A utility is required for writing data to this memory and is typically not made available to the public unless a firmware upgrade is necessary to address a unique issue. |
| Fingerprint reader | 512 KByte flash | Yes | Yes | Stores fingerprint templates. | Fingerprint reader memory is programmed by user enrollment in HP ProtectTools Security Manager. | Only a digitally signed application can make the call to write to the flash. |

Questions and answers

1. How can the BIOS settings be restored (returned to factory settings)?



IMPORTANT: Restore defaults does not securely erase any data on your hard drive. See question and answer 6 for steps to securely erase data.

Restore defaults does not reset the Custom Secure Boot keys. See question and answer 7 for information about resetting the keys.

- a. Turn on or restart the computer, and then press **esc** while the "Press the ESC key for Startup Menu" message is displayed at the bottom of the screen.
- b. Select **Main**, and then select **Restore defaults**.
- c. Follow the on-screen instructions.
- d. Select **Main**, select **Save Changes and Exit**, and then follow the on-screen instructions.

2. What is a UEFI BIOS, and how is it different from a legacy BIOS?

The Unified Extensible Firmware Interface (UEFI) BIOS is an industry-standard software interface between the platform firmware and an operating system (OS). It is a replacement for the older BIOS architecture, but supports much of the legacy BIOS functionality.

Like the legacy BIOS, the UEFI BIOS provides an interface to display the system information and configuration settings and to change the configuration of your computer before an OS is loaded. BIOS provides a secure run-time environment that supports a Graphic User Interface (GUI). In this environment, you can use either a pointing device (touch screen, TouchPad, pointing stick, or USB mouse) or the keyboard to navigate and make menu and configuration selections. The UEFI BIOS also contains basic system diagnostics.

The UEFI BIOS provides functionality beyond that of the legacy BIOS. In addition, the UEFI BIOS works to initialize the computer's hardware before loading and executing the OS; the run-time environment allows the loading and execution of software programs from storage devices to provide more functionality, such as advanced hardware diagnostics (with the ability to display more detailed system information) and advanced firmware management and recovery software.

HP has provided options in Computer Setup (BIOS) to allow you to run in legacy BIOS, if required by the operating system. Examples of this requirement would be if you upgrade or downgrade the OS.

3. Where does the UEFI BIOS reside?

The UEFI BIOS resides on a flash memory chip. A utility is required to write to the chip.

4. What kind of configuration data is stored on the DIMM Serial Presence Detect (SPD) memory module? How would this data be written?

The DIMM SPD memory contains information about the memory module, such as size, serial number, data width, speed/timing, voltage, and thermal information. This information is written by the module manufacturer and stored on an EEPROM. This EEPROM cannot be written to when the memory module is installed in a PC. Third-party tools do exist that can write to the EEPROM when the memory module is not installed in a PC. Various third-party tools are available to read SPD memory.

5. What is meant by "Restore the nonvolatile memory found in Intel-based system boards"?

This message relates to clearing the Real Time Clock (RTC) CMOS memory that contains PC configuration data.

6. How can the BIOS security be reset to factory defaults and data erased?

 **IMPORTANT:** Resetting will result in the loss of information.

These steps will not reset Custom Secure Boot Keys. See question and answer 7 for information about resetting the keys.

- a. Turn on or restart the computer, and then press **esc** while the "Press the ESC key for Startup Menu" message is displayed at the bottom of the screen.
- b. Select **Main**, and then select **Reset BIOS Security to Factory Default**.
- c. Follow the on-screen instructions.
- d. Select **Main**, select **Save Changes and Exit**, and then follow the on-screen instructions.

7. How can the Custom Secure Boot Keys be reset?

Secure Boot is a feature to ensure that only authenticated code can start on a platform. If you enabled Secure Boot and created Custom Secure Boot Keys, simply disabling Secure Boot will not clear the keys. You must also select to clear the Custom Secure Boot Keys. Use the same Secure Boot access procedure you used to create the Custom Secure Boot Keys, but make the selection to clear or delete all Secure Boot Keys.

- a. Turn on or restart the computer, and then press **esc** while the "Press the ESC key for Startup Menu" message is displayed at the bottom of the screen.
- b. Select the **Security** menu, select **Secure Boot Configuration**, and then follow the on-screen instructions.
- c. At the **Secure Boot Configuration** window, select **Secure Boot**, select **Clear Secure Boot Keys**, and then follow the on-screen instructions to continue.

Using HP Sure Start (select models only)

Select computer models are configured with HP Sure Start, a technology that continuously monitors your computer's BIOS for attacks or corruption. If the BIOS becomes corrupted or is attacked, HP Sure Start restores the BIOS to its previously safe state, without user intervention. HP Sure Start is configured and already enabled so that most users can use the HP Sure Start default configuration. The default configuration can be customized by advanced users.

To access the latest documentation on HP Sure Start, go to <http://www.hp.com/support>, and select your country. Select **Drivers & Downloads**, and then follow the on-screen instructions.

15 Recycling

When a non-rechargeable or rechargeable battery has reached the end of its useful life, do not dispose of the battery in general household waste. Follow the local laws and regulations in your area for battery disposal.

HP encourages customers to recycle used electronic hardware, HP original print cartridges, and rechargeable batteries. For more information about recycling programs, see the HP Web site at <http://www.hp.com/recycle>.

Index

Symbols/Numerics

2nd SSD bracket
illustrated 19

A

AC adapter and/battery 10
AC adapter, spare part numbers 21
antennas
removal 58, 59
spare part number 59
audio, product description 2
audio-out (headphone)/audio-in
(microphone) combo jack,
identifying 10

B

Backup and Restore 150
backup tools 148
backups 153
creating 149
recovering 150
battery
removal 30
spare part numbers 17, 30
battery light 11
BIOS
determining version 138, 143
downloading an update 138,
143
updating 138, 143
Blu-ray R/RE DVD±RW SuperMulti
Double-Layer Drive
precautions 23
Blu-ray ROM DVD±RW SuperMulti
Double-Layer Drive
precautions 23
Bluetooth label 13
boot order
changing 157
bottom 13
bottom cover
removal 29
spare part number 29
bottom cover, spare part number
17

Bracket Kit
spare part number 19
buttons
power 8

C

cables, service considerations 23
caps lock light, identifying 7
card reader insert
illustrated 20
chipset, product description 1
components
bottom 12
display 5
front 11
left side 9
right side 10
top 6
computer
major components 14
specifications 158
Computer Setup
navigating and selecting 136,
141
restoring factory settings 137,
142
connector, power 10
connectors, service considerations
23

D

display assembly
removal 53
spare part numbers 15, 53
display bezel
removal 54
spare part numbers 18, 55
display brackets
removal 58
display cable
removal 45
spare part number 45, 59
display cable bracket
spare part number 16

display enclosure
spare part numbers 18
display panel
product description 1
removal 55
spare part numbers 18
display panel bracket
illustrated 19
docking
product description 3
drive light 11
Driver Recovery DVD,
creating 148
using for restore 151
drives, preventing damage 23
DVD-ROM Drive
precautions 23
DVD±RW SuperMulti Double-Layer
Drive
precautions 23

E

EDP bracket
illustrated 19
eDP bracket
spare part number 16
electrostatic discharge 23
equipment guidelines 26
Ethernet, product description 2

F

f11 recovery 151
fan/heat sink assembly
spare part numbers 16
fingerprint reader board
removal 42
spare part number 15, 42
fingerprint reader board bracket
removal 42
fingerprint reader insert
illustrated 20
fingerprint reader, identifying 9

G

graphics, product description 1

grounding guidelines 23
guidelines

- equipment 26
- grounding 23
- packaging 25
- transporting 25
- workstation 25

H

hard drive

- precautions 23
- removal 32
- spare part numbers 32

hard drive recovery 151

HDMI port, identifying 10

hinge

- removal 57
- spare part number 18, 58

HP PC Hardware Diagnostics (UEFI)

using 146

HP Recovery Disc Creator, using 148

HP Recovery Manager

- correcting boot problems 157
- starting 156

HP Recovery media

- creating 153
- recovery 156

HP Recovery partition

- checking for presence 151
- recovery 156
- removing 157
- using for recovery 151

HP Sure Start 166

I

I/O support bracket

- illustrated 19
- removal 49
- spare part number 16, 49

integrated webcam light,
identifying 5

internal microphones, identifying 5

J

jacks

- audio-out (headphone)/audio-in
(microphone) combo 10
- network 9
- RJ-45 (network) 9

K

keyboard

- product description 3
- removal 51
- spare part numbers 15, 51

L

labels

- Bluetooth 13
- regulatory 13
- serial number 13
- service 13
- wireless certification 13
- WLAN 13

LED board

- removal 43
- spare part number 16, 43

legacy support, USB 136, 141

lights

- AC adapter and battery 10
- battery 11
- caps lock 7
- drive 11
- microphone mute 7
- num lock 7
- power 7, 11
- RJ-45 (network) 9
- TouchPad 7
- webcam 5
- wireless 7, 11

M

mass storage device

precautions 23

memory

- nonvolatile 159
- volatile 159

memory card reader, identifying 9

memory module

- product description 1
- removal 36
- spare part numbers 16, 36

microphone

product description 2

microphone module

- removal 56
- spare part number 57

microphone mute light, identifying
7

minimized image recovery 156

minimized image, creating 155
model name 1

N

network jack, identifying 9

nonvolatile memory 159

num lock light 7

O

operating system, product
description 3

optical drive

precautions 23

original system recovery 155

P

packaging guidelines 25

plastic parts, service
considerations 22

Plastics Kit

spare part number 20

pointing device, product
description 3

ports

- HDMI 10
- product description 3
- USB 3.0 charging (powered) 9
- USB Type-C (charging) 10

power button, identifying 8

power connector, identifying 10

power cord

spare part numbers 21

power lights 7, 11

power requirements, product
description 3

processor

product description 1

product description

- audio 2
- chipset 1
- display panel 1
- docking 3
- Ethernet 2
- external media cards 3
- graphics 1
- keyboard 3
- memory module 1
- microphone 2
- operating system 3
- pointing device 3
- ports 3

- power requirements 3
- processor 1
- product name 1
- security 3
- serviceability 4
- solid-state drive 2
- video 2
- wireless 2
- product name 1
- product name and number, computer 13
- R**
- recover
 - options 155
- recovery
 - discs 154, 156
 - HP Recovery Manager 155
 - media 156
 - starting 156
 - supported discs 154
 - system 155
 - USB flash drive 156
 - using HP Recovery media 154
- recovery media
 - creating 153
 - creating using HP Recovery Manager 154
- recovery media, creating 148
- recovery media, using for restore 151
- recovery partition 151
 - removing 157
- recovery tools 148
- recovery tools, Windows 150
- recovery, system 150
- regulatory information
 - regulatory label 13
 - wireless certification labels 13
- removal/replacement
 - procedures 27, 39
- removing personal data from volatile system memory 159
- restoring the hard drive 151
- RJ-45 (network) jack, identifying 9
- RJ-45 (network) lights, identifying 9
- RTC battery
 - removal 38
 - spare part number 15, 38

- S**
- Screw Kit, spare part number 21
- security cable slot, identifying 9
- security, product description 3
- serial number 13
- serial number, computer 13
- service considerations
 - cables 23
 - connectors 23
 - plastic parts 22
- service door
 - removal 28
 - spare part number 17, 28
- service labels, locating 13
- serviceability, product description 4
- setup utility
 - navigating and selecting 136, 141
 - restoring factory settings 137, 142
- slots
 - security cable 9
- solid-state drive
 - precautions 23
 - product description 2
 - removal 31
 - spare part numbers 16, 31
- Speaker Kit, spare part number 16
- speakers
 - removal 50
 - spare part number 16, 50
- speakers, identifying 9
- specifications
 - computer 158
- Startup Repair, using 150
- supported discs, recovery 154
- Sure Start
 - using 140, 145
- system board
 - removal 46
 - spare part numbers 16, 46
- system memory, removing personal data from volatile 159
- system recovery 155
- system restore point
 - creating 154
- system restore point, creating 153

- T**
- thermal board
 - removal 57
 - spare part number 18, 57
- thermal module
 - removal 39
 - spare part numbers 39
- tools required 22
- top cover
 - spare part number 15, 60
- TouchPad
 - removal 44
 - spare part number 15, 44
- TouchPad light, identifying 7
- TouchPad zone
 - identifying 6
- TPM settings 139, 144
- transporting guidelines 25
- traveling with the computer 13
- U**
- USB 3.0 charging (powered), identifying 9
- USB 3.0 port 9, 10
- USB legacy support 136, 141
- USB ports, identifying 9, 10
- USB Type-C (charging) port, identifying 10
- V**
- vent, identifying 12
- video, product description 2
- W**
- webcam 5
- webcam light, identifying 5
- webcam module
 - removal 56
 - spare part number 18, 57
- webcam, identifying 5
- Windows
 - system restore point 153, 154
- Windows 7 operating system DVD
 - creating 148
 - using for restore 151
- Windows 7 operating system media
 - creating 148
 - using for restore 151
- Windows Startup Repair, using 150
- Windows tools
 - using 154

- wireless certification label 13
- wireless light 7, 11
- wireless, product description 2
- WLAN antennas, identifying 5
- WLAN device 13
- WLAN label 13
- WLAN module
 - removal 34
 - spare part numbers 17, 34
- workstation guidelines 25