

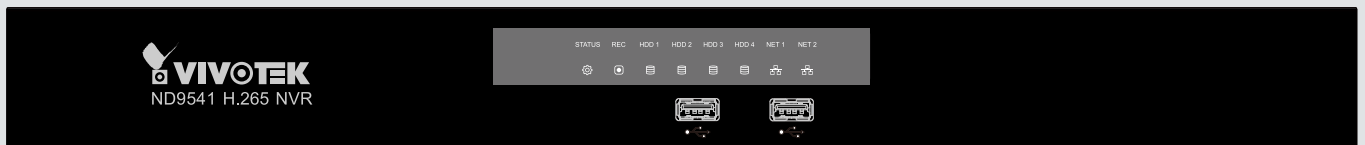

# ND9541 ND9441 Network Video Recorder User's Manual

H.265 • 32-CH & 16-CH • 4 HDDs • ONVIF • Dual LAN • Fisheye Dewarp •  
HDMI/VGA Monitor Display • Storyboard Search • Mobile EZConnect



Rev. 1.0

## **Table of Contents**

<b>Chapter One Hardware Installation and Initial Configuration .....</b>	<b>6</b>
Introducing the Network Video Recorder .....	6
Special Features .....	6
Safety .....	7
Chassis Dimensions .....	8
Physical Description .....	9
LED Indicators.....	29
Power Up and Power Down .....	30
<b>Section One Management over a Local Console.....</b>	<b>31</b>
<b>Chapter Two Introduction to the Local Console Interface.....</b>	<b>31</b>
2-1. How to Begin.....	33
2-2. Operation on Camera View Cell.....	39
2-2-1. PTZ Panel.....	39
2-2-2. Digital zoom Panel.....	41
2-2-3. Play Recording Clips Panel .....	42
2-2-4. DI/DO.....	43
2-2-5. Others .....	43
2-2-6. Right-click Commands.....	44
<b>Chapter Three Configuration Using the Local Console .....</b>	<b>45</b>
The Main Control Portal .....	45
3-1. Layout .....	45
3-2. DI/DO .....	45
3-3. Search recording clips .....	46
3-3-1. Basic Search.....	46
3-3-2. Advanced Search.....	50
3-3-3. Storyboard .....	53
3-4. Export recordings.....	57
3-5. Settings .....	59
3-5-1. Settings - Overview.....	59
3-5-2. Settings - Camera - Management.....	60
3-5-3. Settings - Camera - Recording .....	65
3-5-4. Settings - Camera - Media.....	67
3-5-5. Settings - Camera - Image.....	70
3-5-6. Settings - Camera - Motion Detection.....	72
3-5-7. Settings - Camera - PTZ settings .....	73
3-5-8. Settings - Alarm - Alarm .....	75
3-5-9. Settings - Alarm - Email .....	84
3-5-10. Settings - System - Information .....	85
3-5-11. Settings - System - Maintenance .....	86
3-5-12. Settings - System - Display.....	87

3-5-13. Settings - System - UPS .....	88
3-5-14. Settings - System - Log .....	89
3-5-15. Settings - System - EZConnect service .....	91
3-5-16. Settings - User .....	92
3-5-17. Settings - Storage .....	94
3-5-18. Settings - Network .....	96
Bonding mode .....	96
Settings - Network - IP .....	97
Settings - DDNS .....	98
Settings - Service .....	99
3-6. Information .....	100
<b>Section Two Management over a Web Console .....</b>	<b>101</b>
<b>Chapter Four Login and Getting Started .....</b>	<b>102</b>
4-1. Login .....	102
4-2. Graphical Layout and Screen Elements - Liveview .....	106
4-2-1. Camera List Panel .....	107
4-2-2. Layout .....	109
4-2-3. Layout contents .....	110
4-2-4. Logo & Menu .....	110
4-2-5. View Cell panel .....	111
Adding Cameras to View Cells .....	111
4-2-6. PTZ panel .....	120
4-2-7. Alarm panel .....	122
4-3. Graphical Layout and Screen Elements - Search recording clips .....	126
4-3-1. Camera List Panel .....	127
4-3-2. Search Recording Clips Layout .....	128
4-3-3. Logo & Menu .....	128
4-3-4. View Cells in Search Recording Clips .....	129
Search Recording Clips Control Panel .....	130
4-3-5. Alarm Panel .....	132
4-3-6. Calendar Panel .....	133
<b>Chapter Five System Settings .....</b>	<b>134</b>
5-1. System .....	135
5-1-1. Settings - Camera > Management .....	135
5-1-2. Settings - Camera > Recording .....	139
5-1-3. Settings - Camera > Media .....	141
5-1-3. Settings - Camera > Image .....	144
5-1-4. Settings - Camera > Motion Detection .....	146
5-1-5. Settings - Camera - PTZ settings .....	147
5-2-1. Settings - Alarm - Alarm .....	149
5-2-2. Settings - Alarm - Email .....	159
5-3-1. Settings - System - Information .....	160
5-3-2. Settings - System - Maintenance .....	161
5-3-3. Settings - System - Display .....	162

5-3-4. Settings - System - UPS .....	163
5-3-5. Settings - System - Log .....	164
5-3-6. Settings - System - EZConnect service .....	166
5-4. Settings - User .....	167
5-5. Settings - Storage .....	169
5-6. Settings - Network.....	171
Bonding mode .....	171
Settings - Network - IP .....	172
Settings - DDNS.....	173
Settings - Service .....	174
5-7. Information .....	175
<b>Chapter Six Operation .....</b>	<b>176</b>
6-1. Liveview .....	176
6-1-1. Placing Cameras into the Layout.....	176
6-1-2. PTZ and Other Screen Controls .....	180
6-1-3. Audio.....	183
6-1-4. Camera Properties and Controls .....	184
6-1-5. Alarm Panel .....	185
6-1-6. Layout view Control Buttons .....	186
6-2. Search Recording Clips .....	187
6-2-1. Begin Playback and Search for Past Recordings .....	187
6-2-2. Past Alarms and Bookmarks.....	188
6-2-3. Synchronous Playback .....	189
6-2-4. Export media.....	190
6-2-5. Time Search.....	192
<b>Technical Specifications .....</b>	<b>194</b>
<b>Safety and Compatibility.....</b>	<b>196</b>

## Revision History

\* Rev. 1.0: Initial release.

## Read Before Use

The use of surveillance devices may be prohibited by law in your country. The Network Camera is not only a high-performance web-ready camera but can also be part of a flexible surveillance system. It is the user's responsibility to ensure that the operation of such devices is legal before installing this unit for its intended use.

It is important to first verify that all contents received are complete according to the Package Contents listed below. Take note of the warnings in the Quick Installation Guide before the Network Camera is installed; then carefully read and follow the instructions in the Installation chapter to avoid damage due to faulty assembly and installation. This also ensures the product is used properly as intended.

The Network Camera is a network device and its use should be straightforward for those who have basic networking knowledge. It is designed for various applications including video sharing, general security/surveillance, etc. The Configuration chapter suggests ways to best utilize the Network Camera and ensure proper operations. For creative and professional developers, the URL Commands of the Network Camera section serves as a helpful reference to customizing existing homepages or integrating with the current web server.



### NOTE:

The operating system and management software are installed on a flash memory mounted on the main board. Except for the plug-ins for the onscreen control, there is no need to install software.

## Package Contents

<ul style="list-style-type: none"> <li>■ ND9541 or ND9441</li> <li>■ Power adapter &amp; power cord</li> <li>■ Software CD</li> <li>■ Quick Installation Guide</li> </ul>	<ul style="list-style-type: none"> <li>■ Mouse</li> <li>■ Screws and HDD brackets</li> <li>■ SATA cables</li> <li>■ Slide rails (separately purchased)</li> </ul>
---	---

## Symbols and Statements in this Document



**INFORMATION:** provides important messages or advices that might help prevent inconvenient or problem situations.



**NOTE:** Notices provide guidance or advices that are related to the functional integrity of the machine.



**Tips:** Tips are useful information that helps enhance or facilitate an installation, function, or process.



**WARNING!** or **IMPORTANT:** These statements indicate situations that can be dangerous or hazardous to the machine or you.



**Electrical Hazard:** This statement appears when high voltage electrical hazards might occur to an operator.

# Chapter One Hardware Installation and Initial Configuration

## Introducing the Network Video Recorder

VIVOTEK ND9541 and ND9441 series is a compact Linux embedded 32-CH or 16-CH stand-alone desktop NVR designed for any small-scale video surveillance installation. The series features ease of installation, and facilitates “One Button Setup” with its plug & play and auto setup functionality.

Supporting HDMI and VGA local video output, users can control the GUI OSD interface via mouse & keyboard, eliminating the need for a separate PC to search video or to playback from the NVR. The new local display design - Auto Adaptive Stream will dynamically modify Stream 2 resolution of a camera to best fit the display resolution according to the layout type, resulting in an efficient display, while maintaining superb image quality. What’s more, the NVR provides various I/O ports, such as alarm input/output and RS485 giving users great flexibility with applications.

Together with VAST CMS and ST7501 VMS, users can set up an easy-to-use IP surveillance system with ease. VIVOTEK also provides the mobile application, iViewer, for both iOS and Android handheld devices, enabling users to monitor live video anytime, anywhere.

## Special Features

- Runs on embedded Linux
- 1 x HDMI and 1 x VGA for local display
- 4 x HDD bay, for a max. capacity of 24TB
- 2 x Gigabit RJ45 Ethernet ports;
- 3 x USB Ports (2 USB 2.0 in front and 1 USB 3.0 in Back)
- Size: 430 mm (W) x 400 mm (D) x 44.5 mm (H). Weight: 3.87kg.
- 32- or 16-CH Live View & 4-CH Synchronous Playback (web console)
- H.265 / H.264 / MJPEG
- PTZ Support
- Snapshot / Export Media
- Digital zoom Video Control
- EZConnect for effortless access from cell phones using a QR code
- Terminal block pins for DI/DO and RS-485 connection.
- Configuration Backup / Restore
- Compatible with VIVOTEK VAST Central Management Software\*
- Integration with VIVOTEK Network Cameras
- VIVOTEK iViewer Support (iOS/Android cellphone/hand-held devices)

\*The VIVOTEK VAST Central Management Software is not included in the package.

## Safety

- Connect the system to an earthed main power outlet.
- Never open the housing of the power supply unit.
- Install and operate the system only in a dry, weather-proof location.
- Observe the following safety factors:
  - Is there visible damage to the system or power cord?
  - Is the system operating correctly?
  - Has the system been exposed to rain or moisture?
  - Has the system been in a long storage under harsh conditions or exposed to unconfirming stress?
- The relevant electrical engineering regulations must be complied with at all times during installation.
- Ensure that all maintenance and repair work is handled by qualified personnel such as electrical engineers or network specialists.
- Read this manual before installing or operating the system. The documentation contains important safety instructions about permitted uses.
- The rated AC input is: **100-240V~ 2-1A, 60-50Hz**; the max. consumption: **120W** (DC56V, 2.5A)
- If a fault occurs, disconnect the power cord from the power supply.
- Do not install the system close to heaters or other heat sources. Avoid locations with direct sunlight.
- All ventilation openings must not be blocked.
- Use only the cables shipped with system or use appropriate cables that can withstand electromagnetic interference.

## Chassis Dimensions

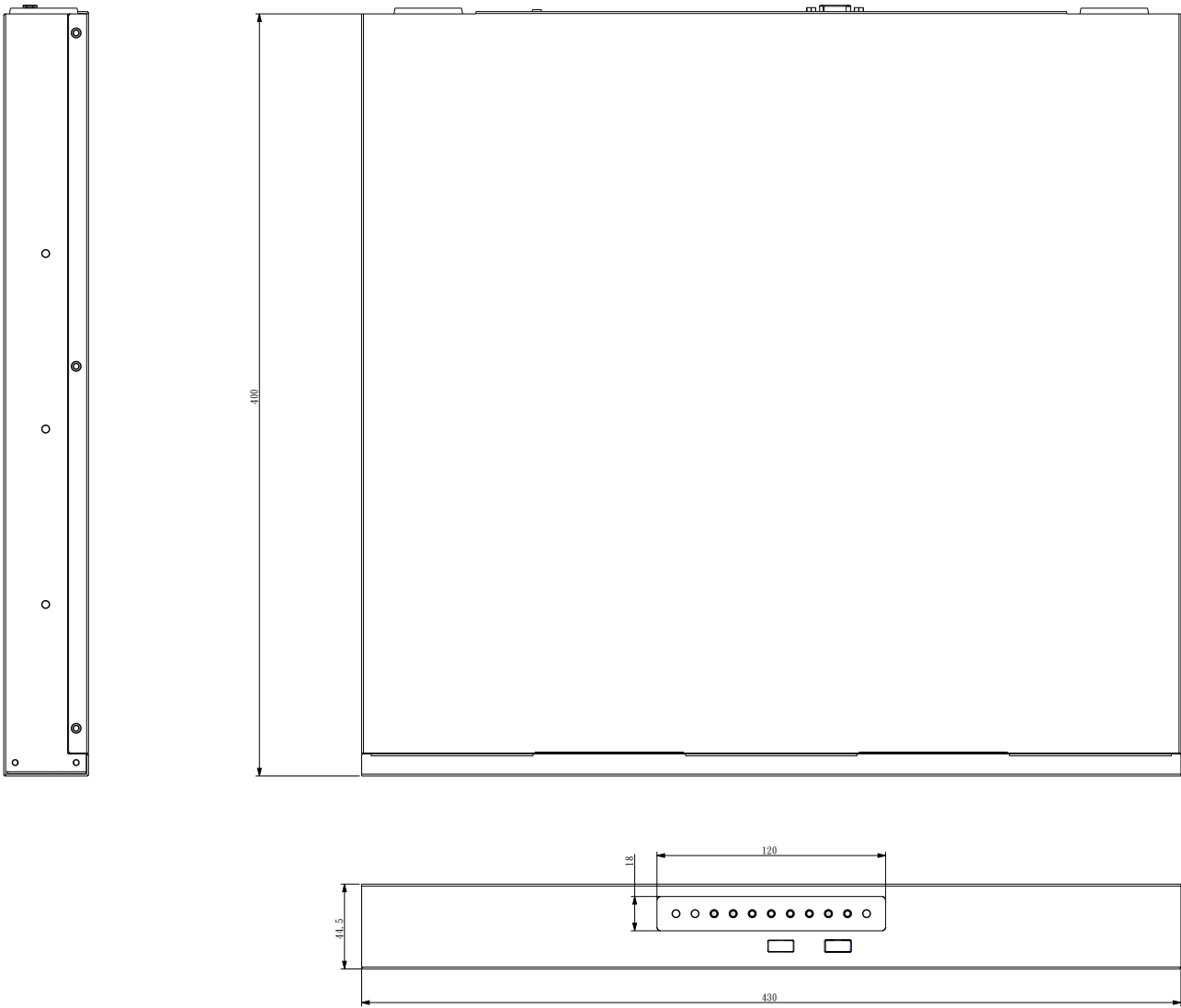



# 1 Physical Description

## Front View

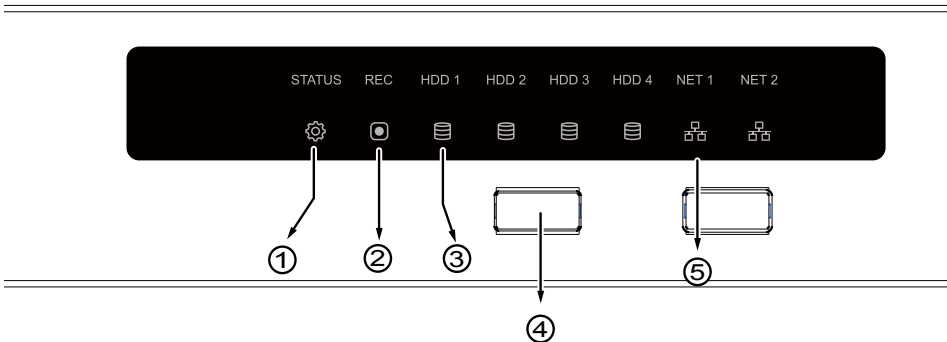

1	System status LED
2	Recording activity LED
3	HDD activity LED (#1 ~ 4)
4	USB 2.0 ports
5	Network status/activity LED

## Rear View

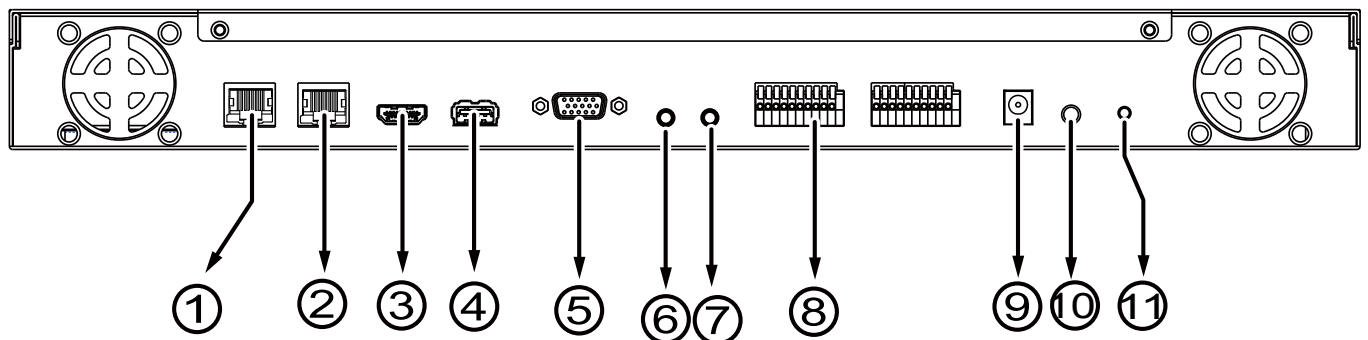

1	Net 1 RJ45 port - GbE uplink	7	Audio IN
2	Net 2 RJ45 port - GbE uplink	8	DI/DO terminal block
3	HDMI	9	Power socket (DC56V, 2.5A)
4	USB 3.0 port	10	Power button
5	VGA	11	Reset button
6	Audio OUT		

 **NOTE:**

You can also use the Reset button to restore system defaults. Press and hold down the button for longer than 5 seconds. The system should start restoring defaults.

 **IMPORTANT:**

It is important to leave a clearance of 25cm behind the chassis. The clearance is required to ensure an adequate airflow through the chassis to ventilate heat.

To ensure normal operation, maintain ambient airflow. Do not block the airflow around chassis such as placing the system in a closed cabinet.

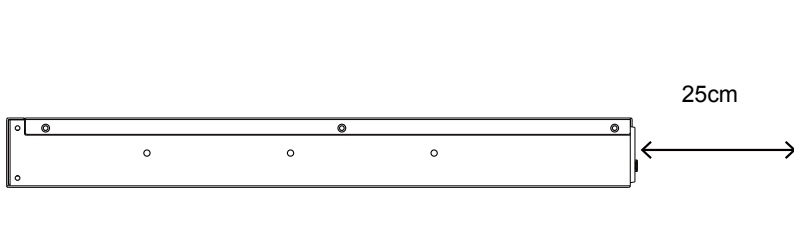

## **Hardware Installation**

SATA hard disk(s) are user-supplied. The network video recorder can readily accommodate most of the off-the-shelf SATA hard drives.

1. Use a screwdriver to loosen the retention screw on the sides of the chassis. Slide the top cover back, and then remove the top cover.

**1**

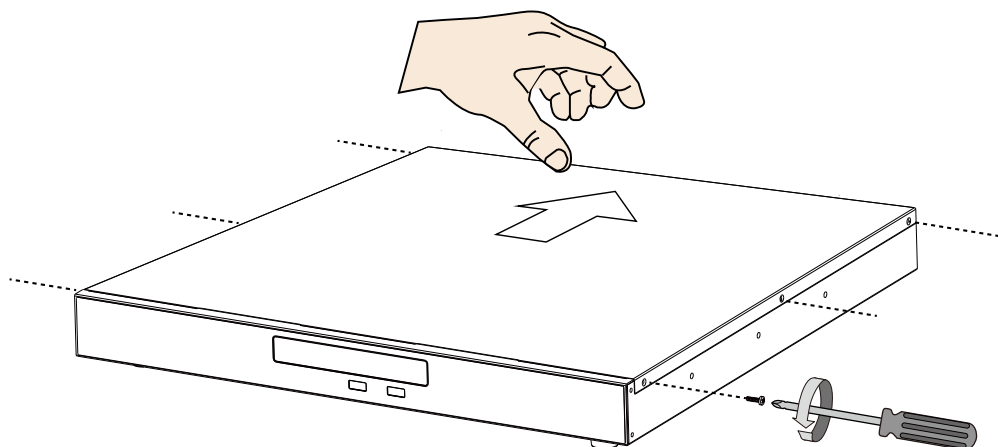

2. Secure the HDD brackets to the hard drives.

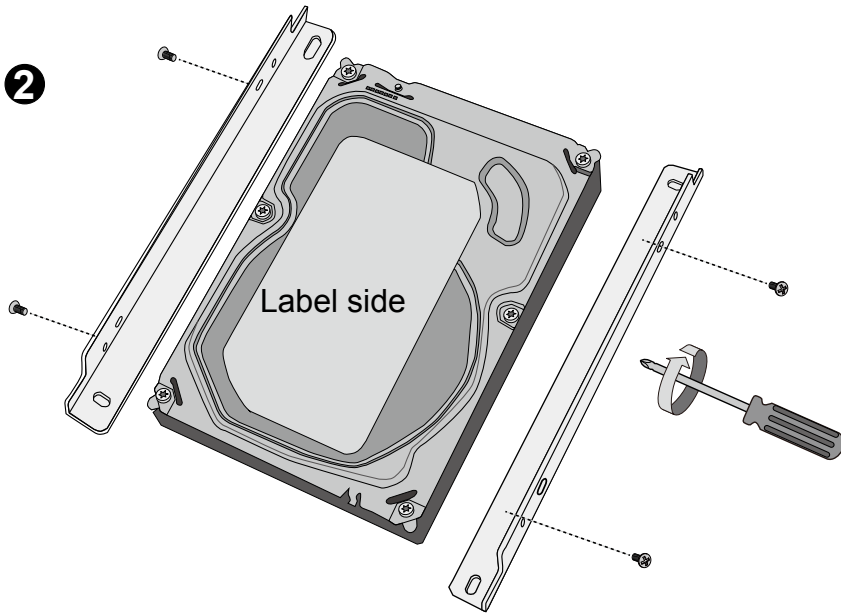

3. Connect SATA data cables to the connectors on the main board.

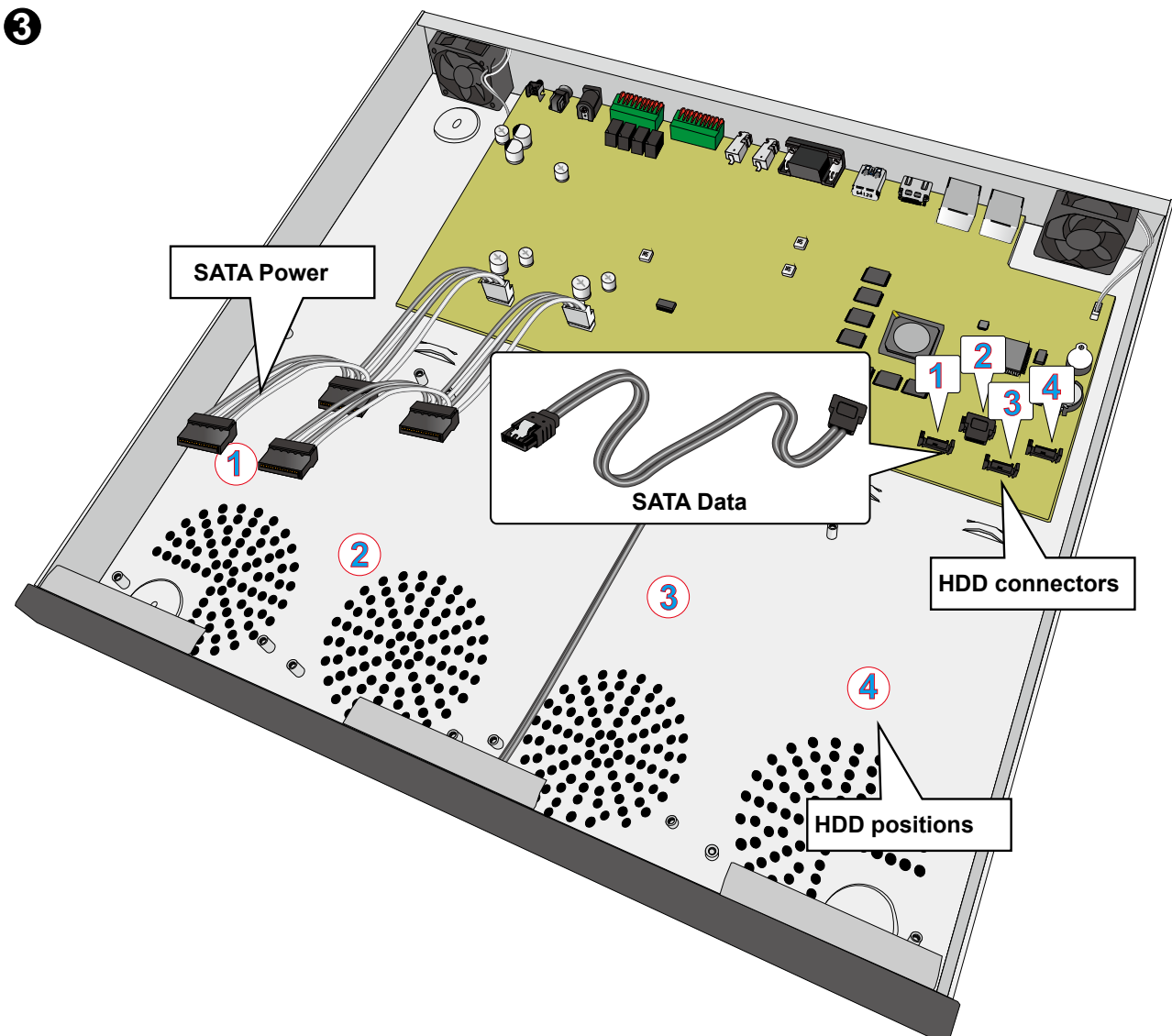

4. Connect SATA data and power cables to the hard drives.

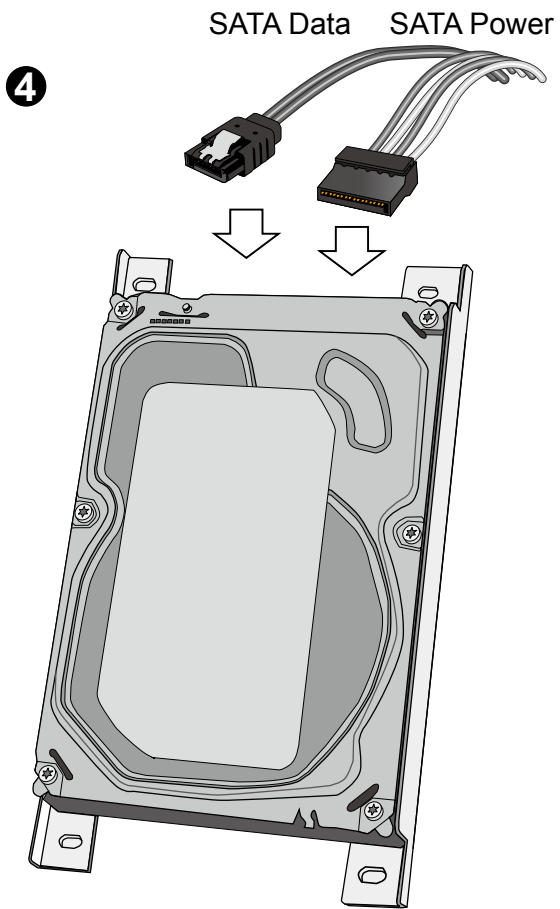

5. Secure the hard disks to the mounting positions in the chassis with its label side facing up, and the connectors facing the inside of the chassis.

5

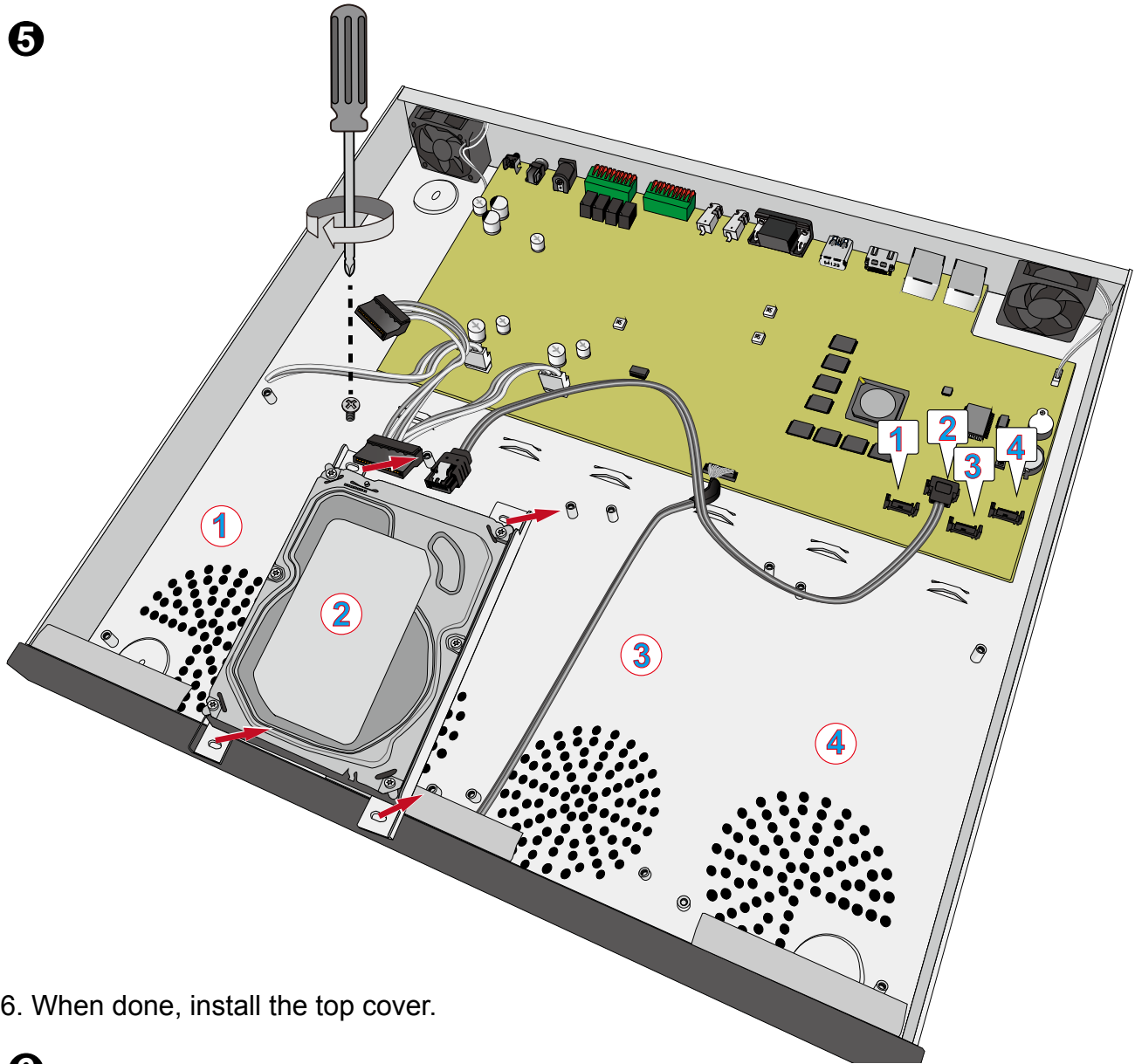

6. When done, install the top cover.

6

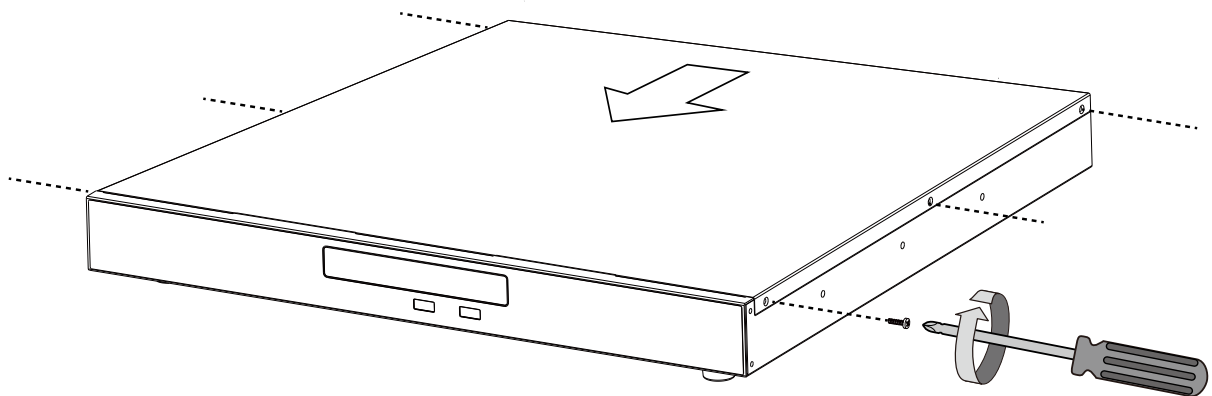

## Rack-mounting (Optional, and the slide rails are separately purchased)

### IMPORTANT:

If you have either a round-holed or square-holed rack, install cage nuts or clip nuts to the desired positions on the rack posts.

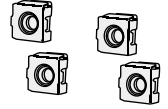

The instructions below are based on the installation to a 4-post equipment rack. The slide rails apply to rack cabinet of a depth of 700 to 900mm. With 4 hard drives, the chassis can weigh up to 7kg.

If you need to install the NVR system into a rack cabinet,

1. Remove the foot pads from underneath the chassis.

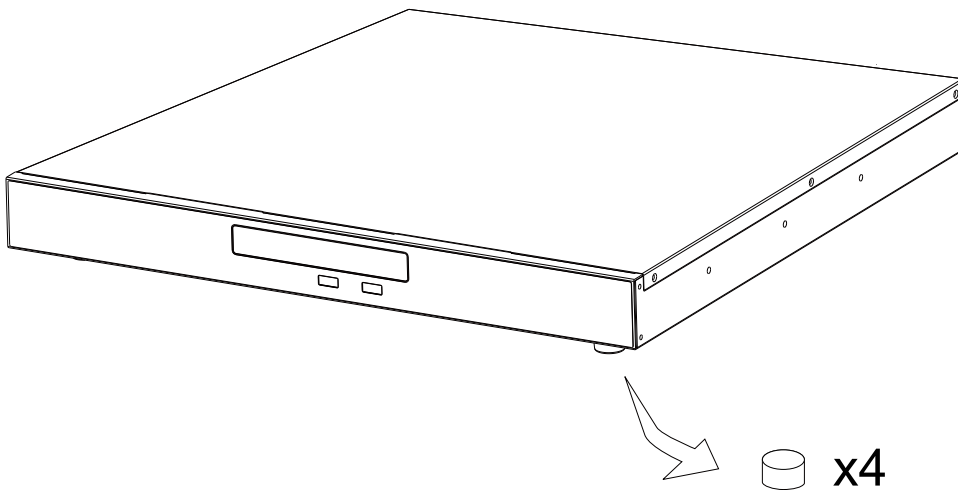

2. Unpack the rack-mount rails' package, and detach the inner rails from the rail assembly. Detach the inner rail by pressing on the release tab.

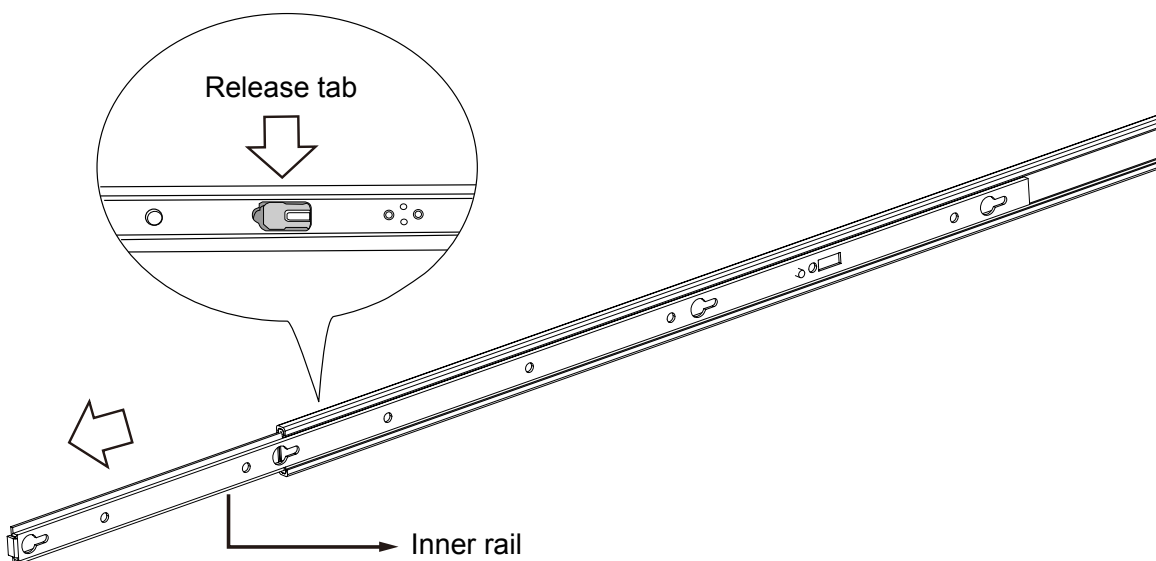

3. Secure the inner rails to the sides of the chassis using the M4 screws.

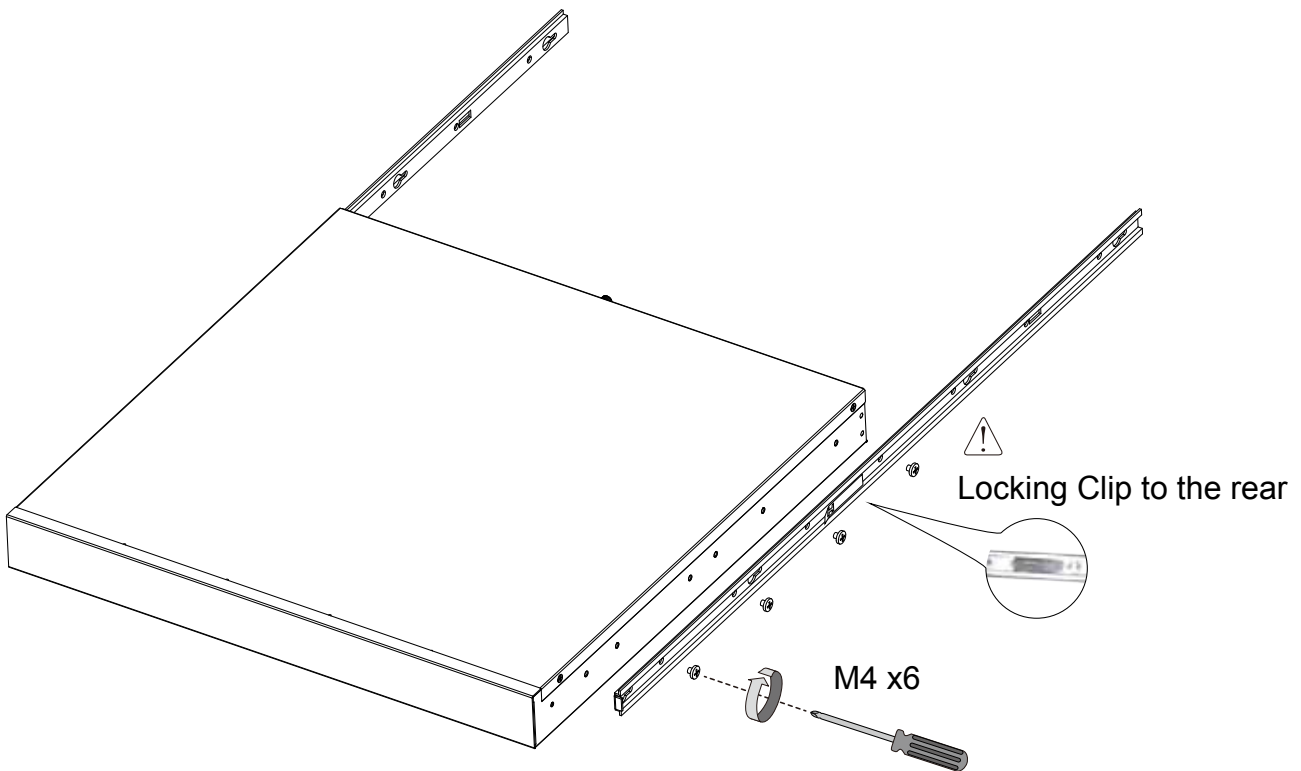

4. Secure the L-shape brackets to the front- and rear-ends of outer rails using the **black** round head screws and washers. Do not completely tighten the screws yet. Adjust the length of slide rails by extending and matching the rails between rack posts.

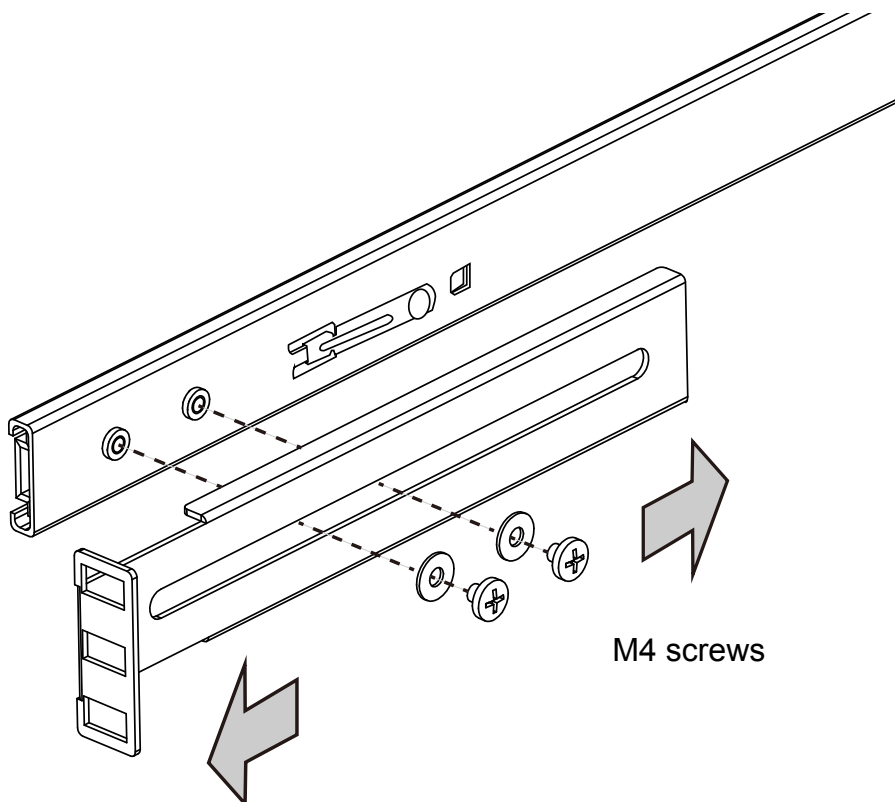

Adjust the length of rails to match the rack posts.

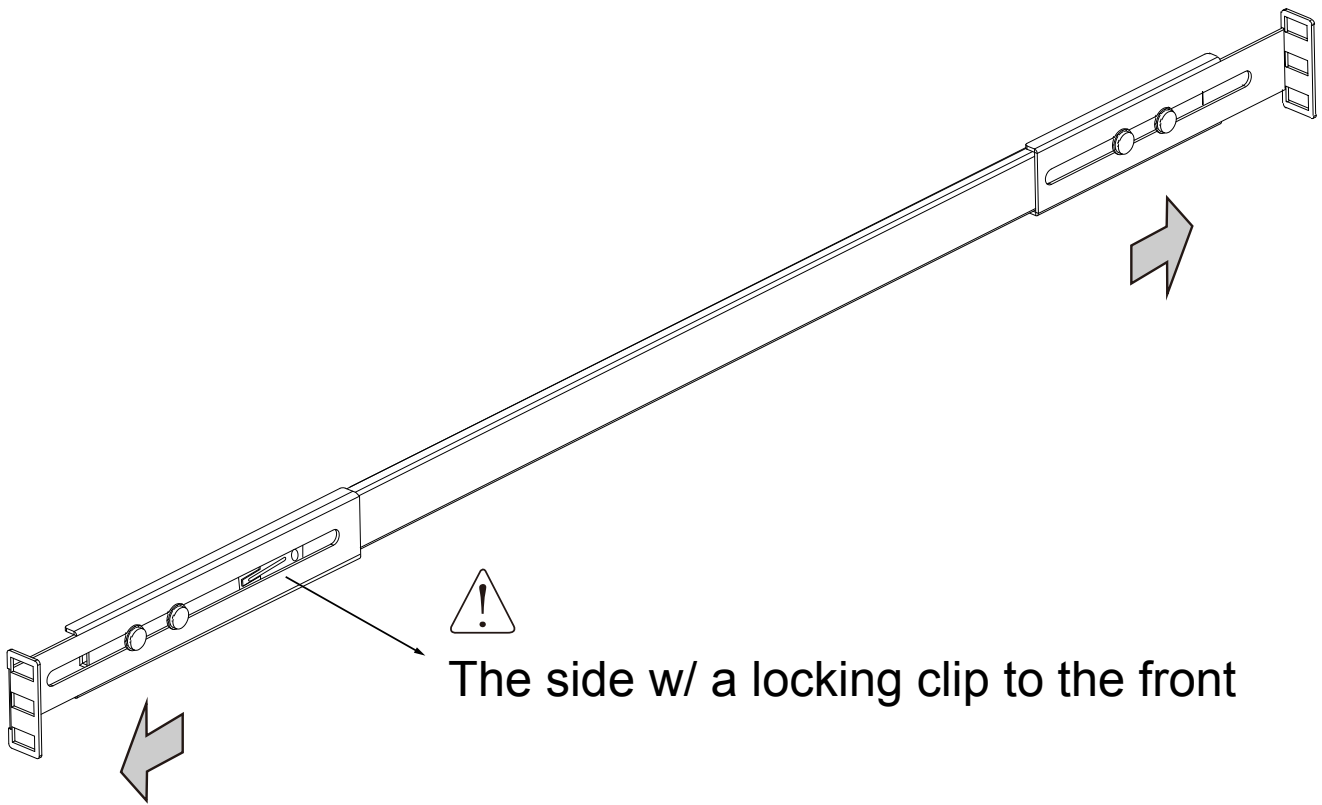

5. Secure the slide rails to rack posts using the #10 screws.

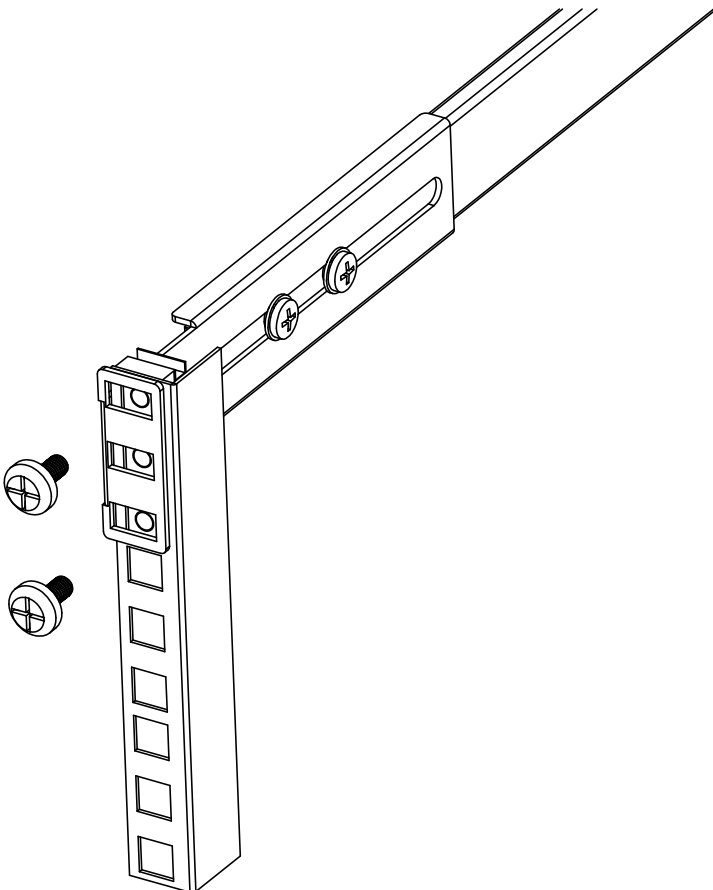



6. Pull the middle rails out of the slide rail assemblies.

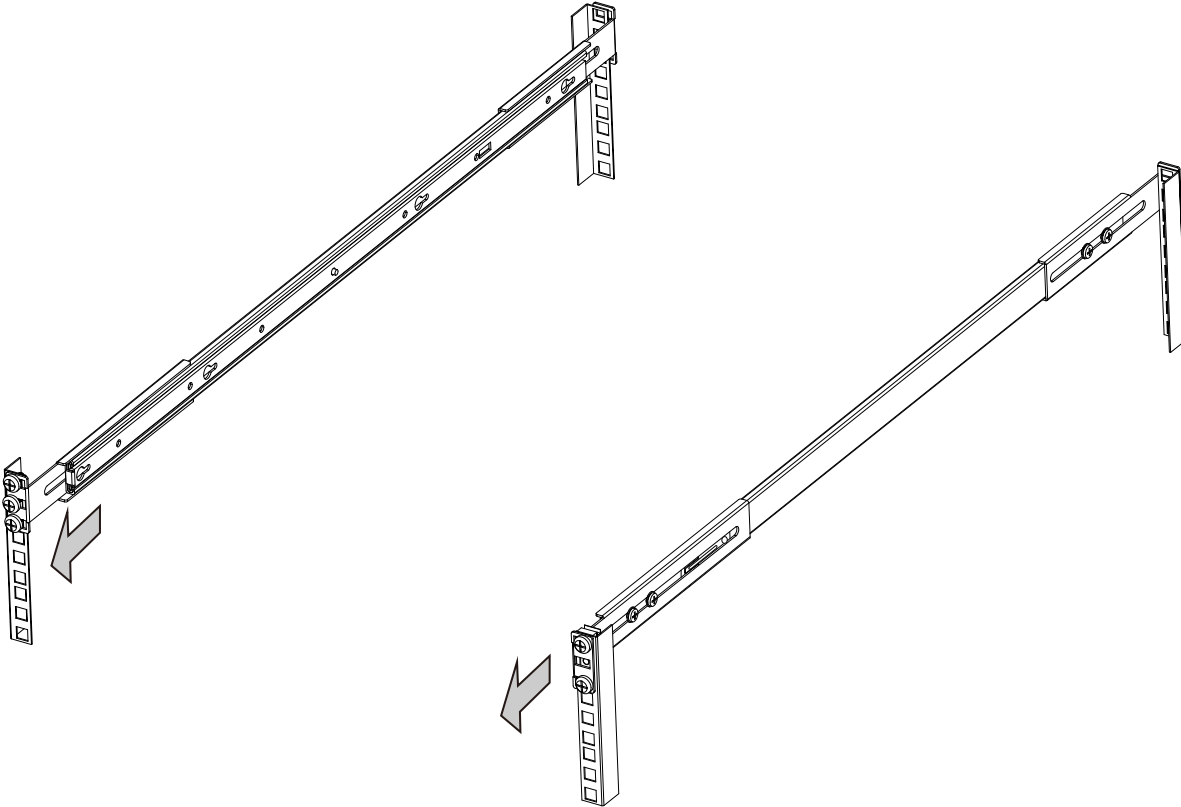

7. Hold the chassis using both hands on the sides of the chassis. Align the tips of inner rails on the chassis with the open portion of the slide rail assemblies. Push the system into the assemblies until the system stops.

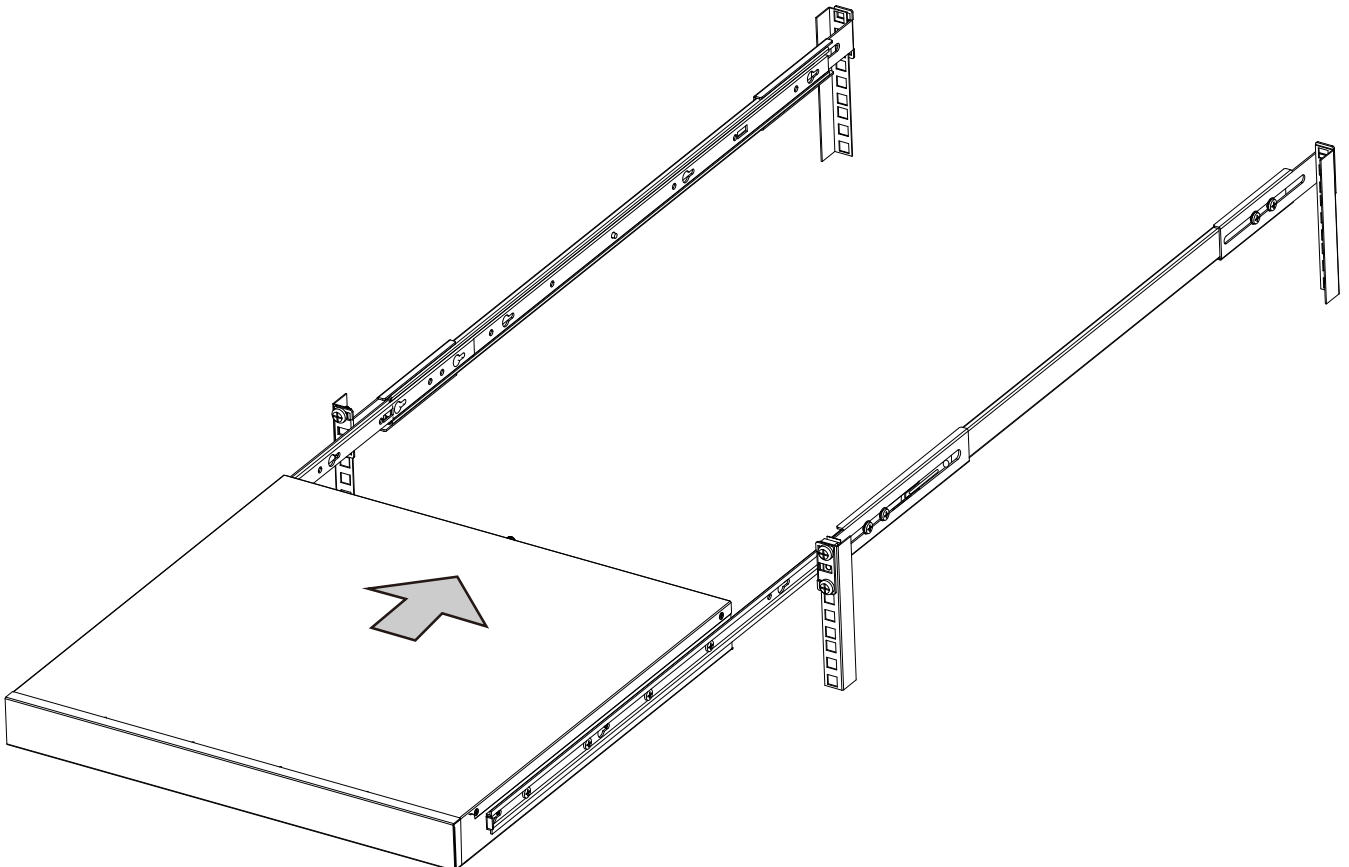

8. The inner rails and the rail assemblies should be locked on the way into the rack cabinet. Press the release tabs on the sides to slide the chassis into rack.

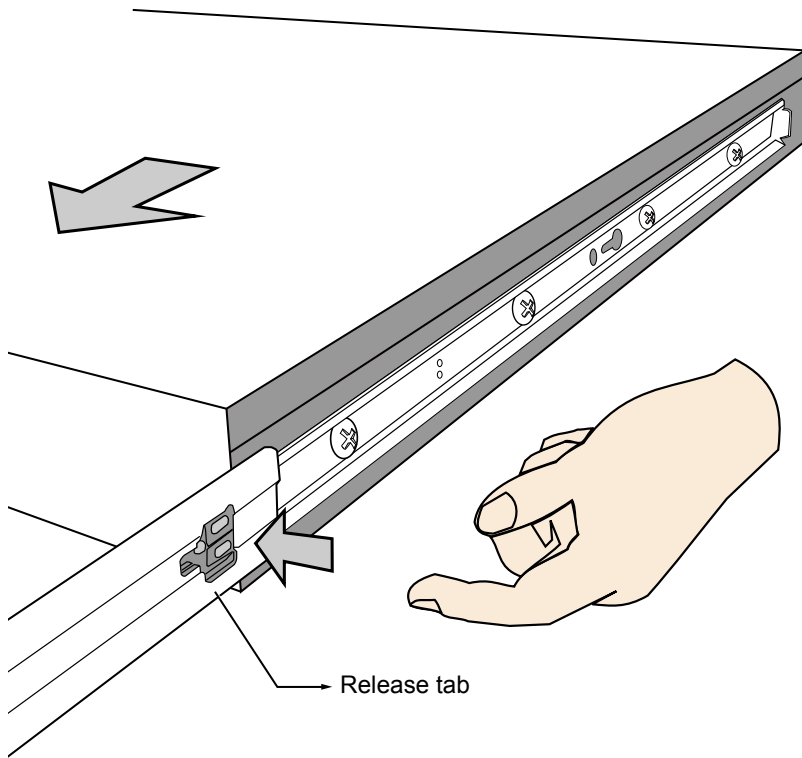

### 3 Interface Connections

1. Connect to a monitor using an HDMI cable. VGA is also supported.
2. Connect CAT5e or better-quality Ethernet cable to the Gb/E Ethernet ports. IP cameras are connected via an Ethernet switch or PoE switches.
3. Connect USB devices such as, mouse, keyboard, USB optical drive, or USB thumb drive (formatted in FAT format), or UPS.
4. Connect external devices, such as sensors, relays, or alarms to the terminal block.
5. Connect the power adaptor to the power mains and the system.

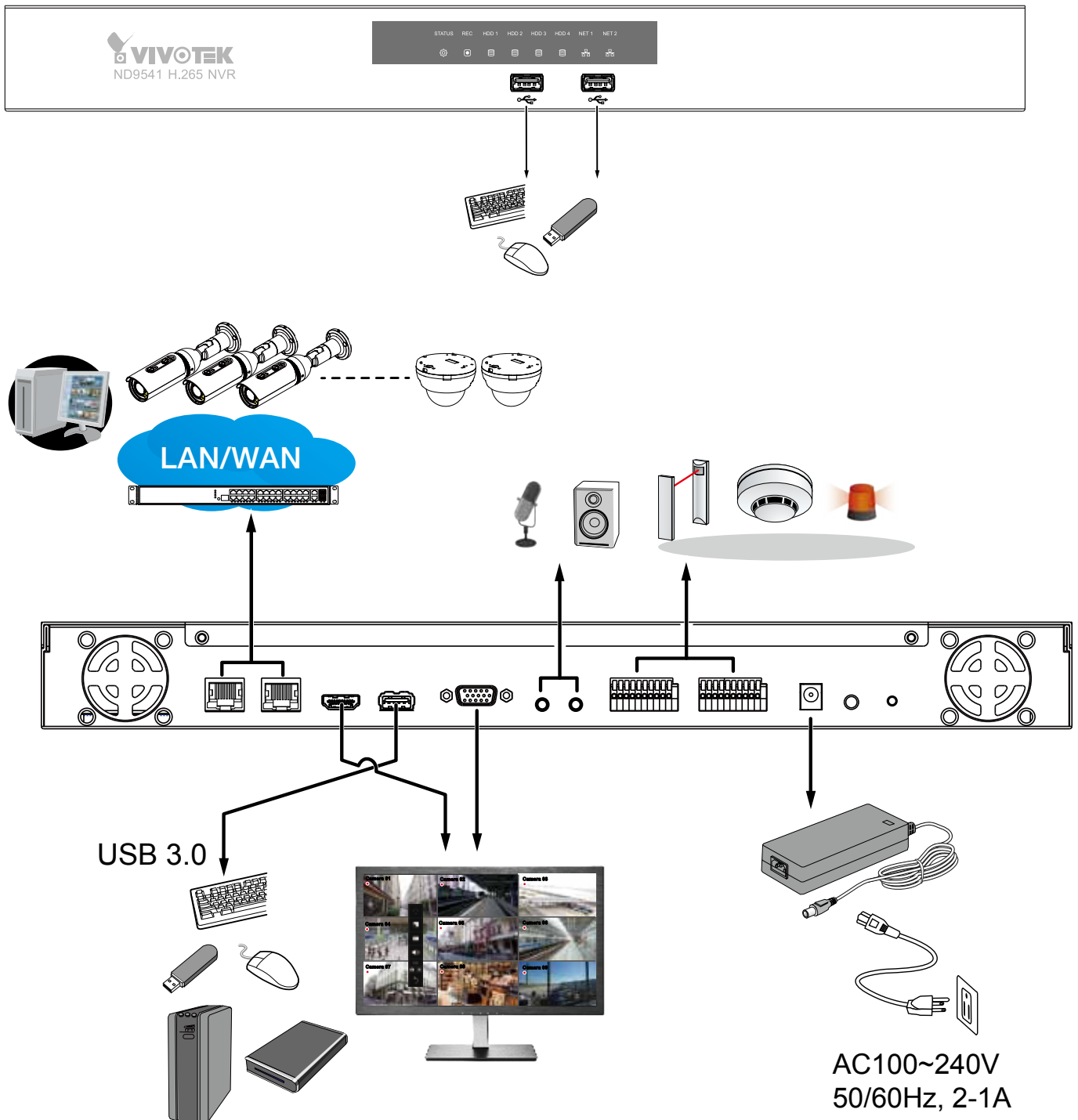

AC100~240V  
50/60Hz, 2-1A



**NOTE:**

Although the system supports MAC Binding, the system should be able to detect VIVOTEK's cameras within the network regardless of the presence of a DHCP server. Ideally, cameras and the NVR should reside in the same subnet. If a camera's IP is changed for some reasons, the system should be able to detect its new IP.

---

## Terminal Block Connections

The terminal block pinouts is shown as follows:

The DO pins default status is set to Normally Closed. Connect your relay or external devices' signal wires to the system, the system will automatically detect the current signal status. You can then trigger the external devices using the DI/DO panel on the live view.

You can also configure the system alarm setting for the system to automatically trigger a DO on the occurrence of system events. See Alarm settings on page 75.

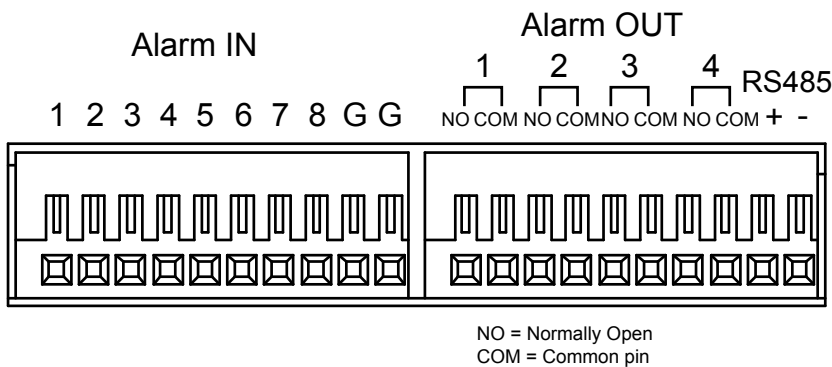
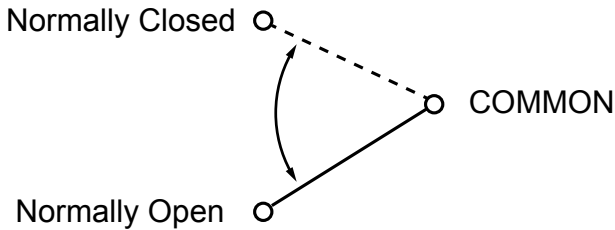

The pins are listed and described from left to right as shown in the drawing above.

Pin	Description	NOTE
DI no. 1 ~ 8	Open-short-to-GND	
G	Pins #1~4 share a common ground. Pins #5~8 share a common ground.	
NO	Normally open. Use the DO trigger buttons on the live view window to trigger the digital output.	
COM	Common pin	
RS485+	RS485 Data+	A 120Ω terminator is enabled on the bus. The terminator cannot be disabled.
RS485-	RS485 Data-	

 **WARNING:**

If you connect the NVR to a PoE port of the AW-FED series PoE switch, make sure you turn off the PoE output on that specific port using the onboard DIP switch. Otherwise, the high power output can damage the LAN port on NVR.

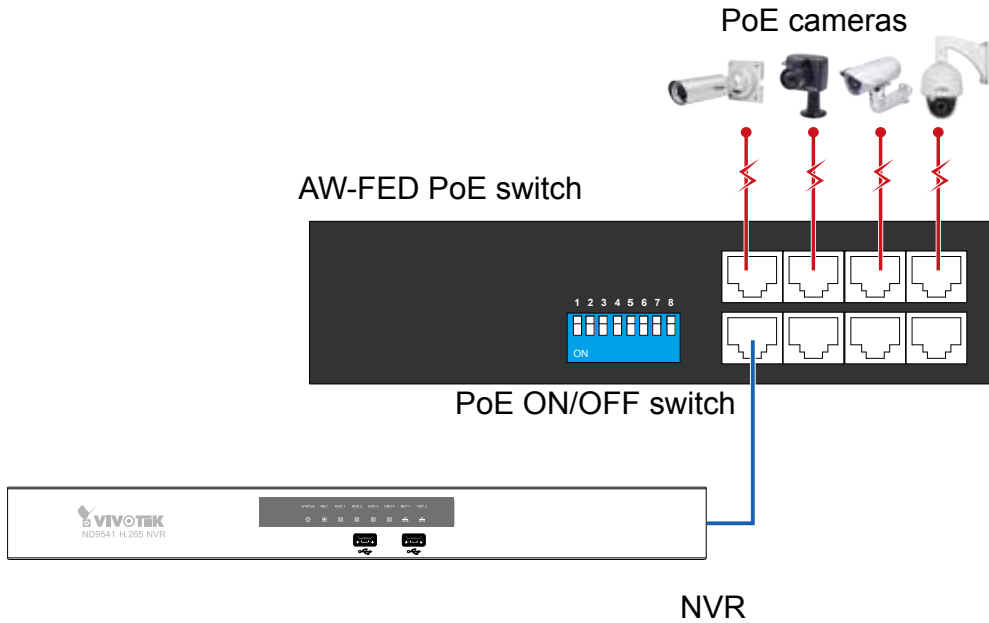

## 4 Initial Configuration - via a Local Console

A local console requires the following:

1. A monitor is connected via an HDMI or VGA cable.
2. A mouse and/or a keyboard are connected to the system.
3. It is presumed that the system has not been configured yet.

Follow the onscreen messages to complete the initial configuration:

1. Select the UI language, Time zone, and current date and time. Click on the Continue button to proceed.

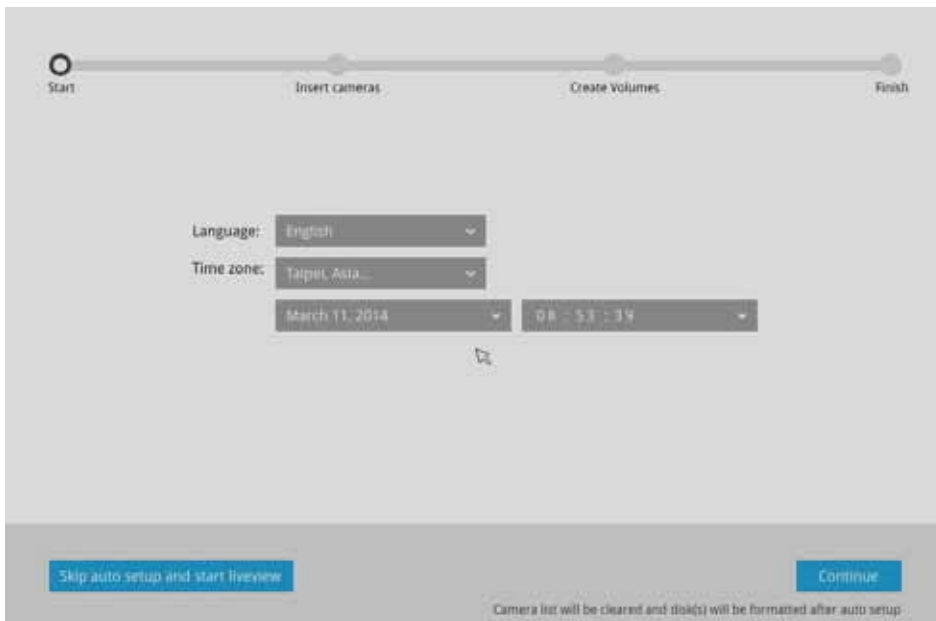

### IMPORTANT:

Except in the initial setup, changing system time can produce disruptions to the existing recordings. Turning the current system time back to a time when video recording was taking place can generate duplicate files. And those files may not be playable.

2. The system will then start to scan the local subnet for connected cameras.

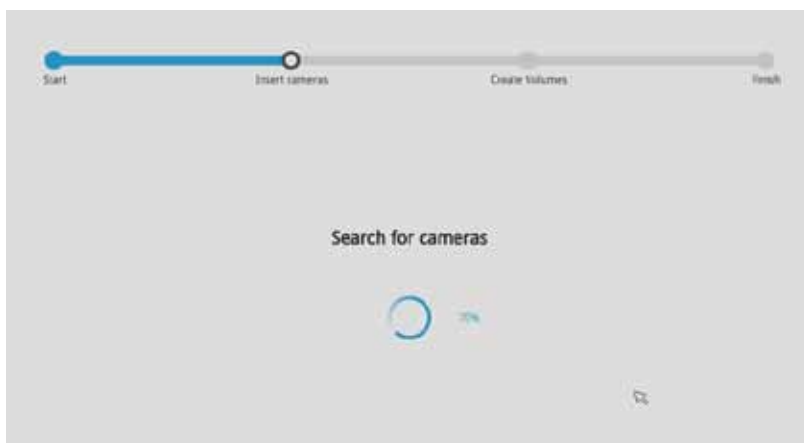

- All cameras detected on the network will be automatically selected. If necessary, deselect the cameras you want to exclude from the configuration. Click **Continue** to proceed.

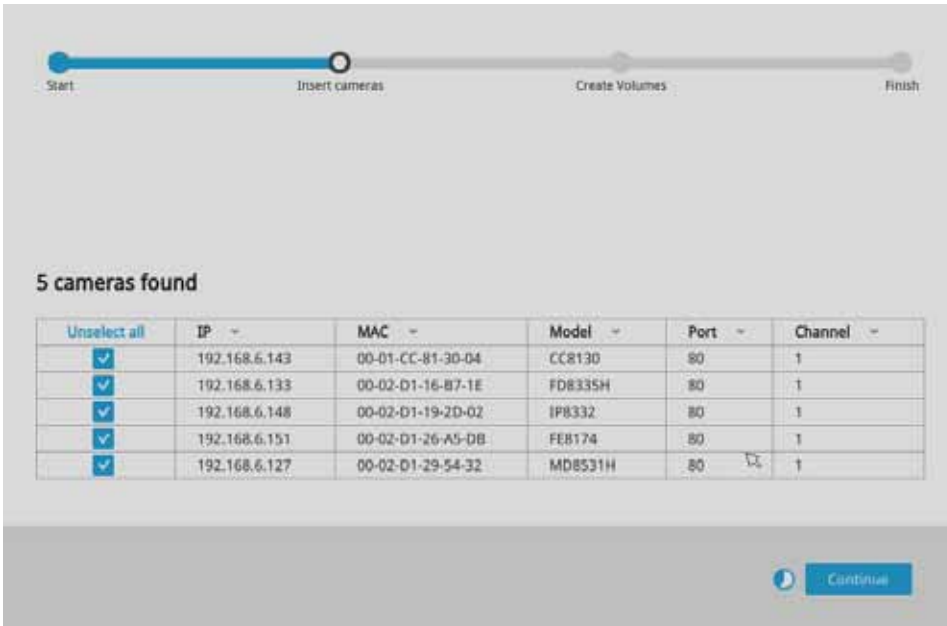

**NOTE:**

- The maximum recording bandwidth is  
 2560x1920 @ 120 fps (4-CH)  
 1920x1080 @ 480 fps (16-CH)  
 1280x720 @ 960 fps (32-CH)

Display bandwidth:

- 2560x1920 @ 30 fps (1-CH)
- 1920x1080 @ 120 fps (4-CH)
- 1280x720 @ 240 fps (8-CH)
- 1280x720 @ 480 fps (16-CH)
- 720x480 @ 960 fps (32-CH)

When cameras are recruited into the configuration, their stream 1 is used as the recording stream.

The resolution and fps (frame rate per second) of stream 1 may vary depending on the specifications of different cameras.

- If there are more than 16 or 32 cameras in your local network, you will need to manually select cameras.

If there are less than 8 or 16 cameras, the Auto Setup will automatically move to the next configuration step.



- The system will automatically create volumes from the installed disk drives. The process will take several minutes.



- An optional utility, **EZConnect**, is available through the Apple and Android App Stores. The EZConnect works with a server hosted by VIVOTEK for bridging and tunneling video requests between client devices and network cameras/CMS/NVR. The utility simplifies and facilitates network configuration for access across the Internet.

The prerequisites for using the EZConnect are as follows:

- Download and install the EZConnect utility to your cell phone.
- Both the NVR and your cell phone have access to the Internet.

With this utility, you do not need to configure IP port forwarding on router or set up a DDNS address for the NVR. You do not even need to know the IP address of the NVR. The EZConnect utility automatically manages the network parameters required for making the connection. The EZConnect comes with viewing and playback interfaces very similar to those in the iViewer utility.



To connect the NVR from a cell phone using the EZConnect:

- 5-1. Click on the **EZConnect** button on the wizard.



5-2. The QR code will be generated.

5-3. Open the utility from your cell phone. If you already registered an account, tap **LOG IN**. If not, tap **SIGN UP** to register an account from a VIVOTEK server.

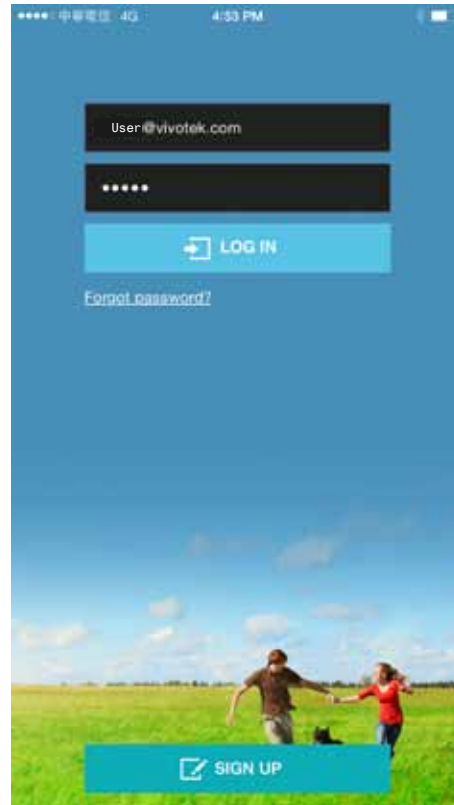

5-4. You can be defaulted to the Live view page. Tap the Add button below to add devices.

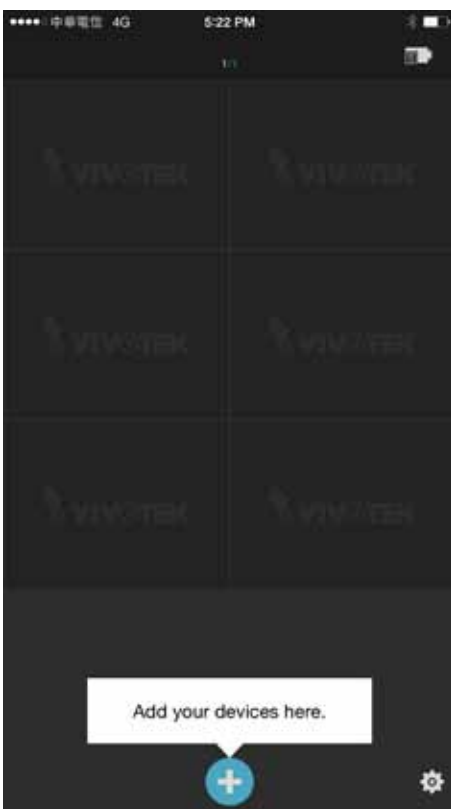

5-5. Tap the **ADD DEVICES MANUALLY** button.



5-6. You can then point your cell phone lens at the NVR screen (Step 5-3.) and use the **SCAN QR CODES** function to establish the connection. You may also manually enter the device ID.



5-7. The process will take several seconds to complete.



5-8. The NVR and the cameras under it will be ready for access.

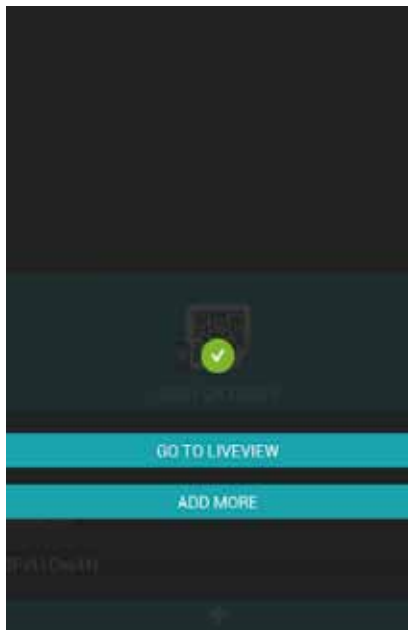

6. Click the Done button. The **LiveClient** screen will display, and, by default, the recording from the selected cameras will immediately take place.

**5**

**LED Indicators**

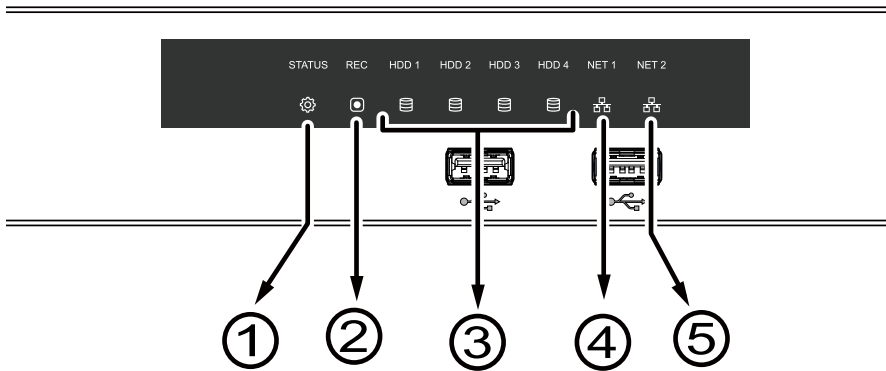

Name	Behavior	Definitions
<b>1. Status LED</b>	1 Constant <b>Green</b>	System is ready.
	2 Blinking <b>Green</b> every 1 second	Updating firmware or device pack.
	3 Constant <b>Red</b>	S.M.A.R.T.-related disk errors, or a configured H.D.D. is missing, or H.D.D. is full. Buzzer will also be sounded. When buzzer is turned off, LED will return normal.
<b>2. Record LED</b>	1 Flashing <b>Red</b>	Camera streams are recorded to the system storage.
	2 OFF	No recording.
<b>3. HDD activity LED</b>	1 Constant <b>Green</b>	H.D.D. is connected and ready.
	2 Constant <b>Red</b>	SMART-related disk errors or a configured H.D.D. is missing.
	3 Blinking <b>Red</b> every 1 second	H.D.D. configuration errors.
	4 OFF	H.D.D. is disconnected or removed.
<b>4 &amp; 5. NET activity LED</b>	1 Flashing <b>Orange</b>	Indicating on-going traffic over the LAN connection.
	2 Solid <b>Orange</b>	Ethernet is connected.
	3 OFF	Ethernet is disconnected.

## 6 Power Up and Power Down

To power up and power down,

On the initial configuration:

1. Connect the power adapter between the system and power outlet.
2. Turn on the system by pressing the power button for more than one second.

After the initial connection,

1. Press the power button for 1 second to power on.
2. Press the power button for 4 seconds to power down. The system should start flushing the cached contents in system memory and gracefully shut down.

Press the Reset button for longer than 5 seconds can restore system defaults.

### WARNING:

1. No storage system is completely fail-safe. Damage to data might occur due to file system corruption, operating system malfunction, virus infection, HDD component failures, and so on. Therefore, it is highly recommended to regularly back up your data, and VIVOTEK disclaims responsibilities of data loss or recovery.
2. Always power off the system using the power button. Do not disconnect the power cord while the system is still operating. Doing so will result in data inconsistencies. The normal power-off procedure allows cached data to be written to disks.

### NOTE:

If system buzzer is sounded, move your mouse cursor to reveal the main screen portal, and then click on the **Stop buzzer** button.

Serious system faults, such as a missing volume, can trigger the system buzzer. Verify the cause of system fault and turn off the buzzer.

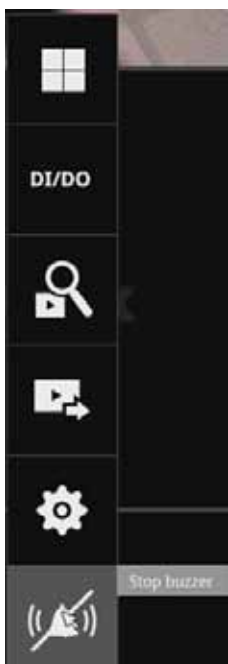

# Section One

## Management over a Local Console

### Chapter Two

### Introduction to the Local Console Interface

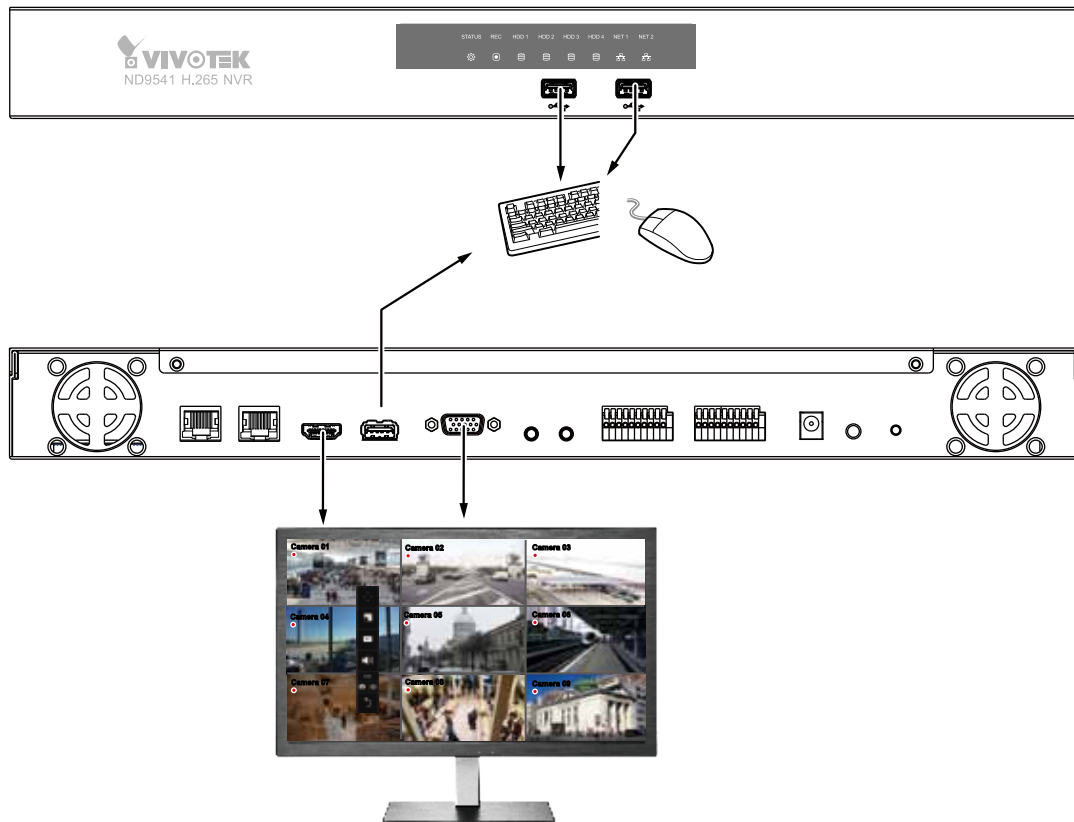

By default, a live view appears on an HDMI monitor. The interface architecture of the local console is illustrated as follows:

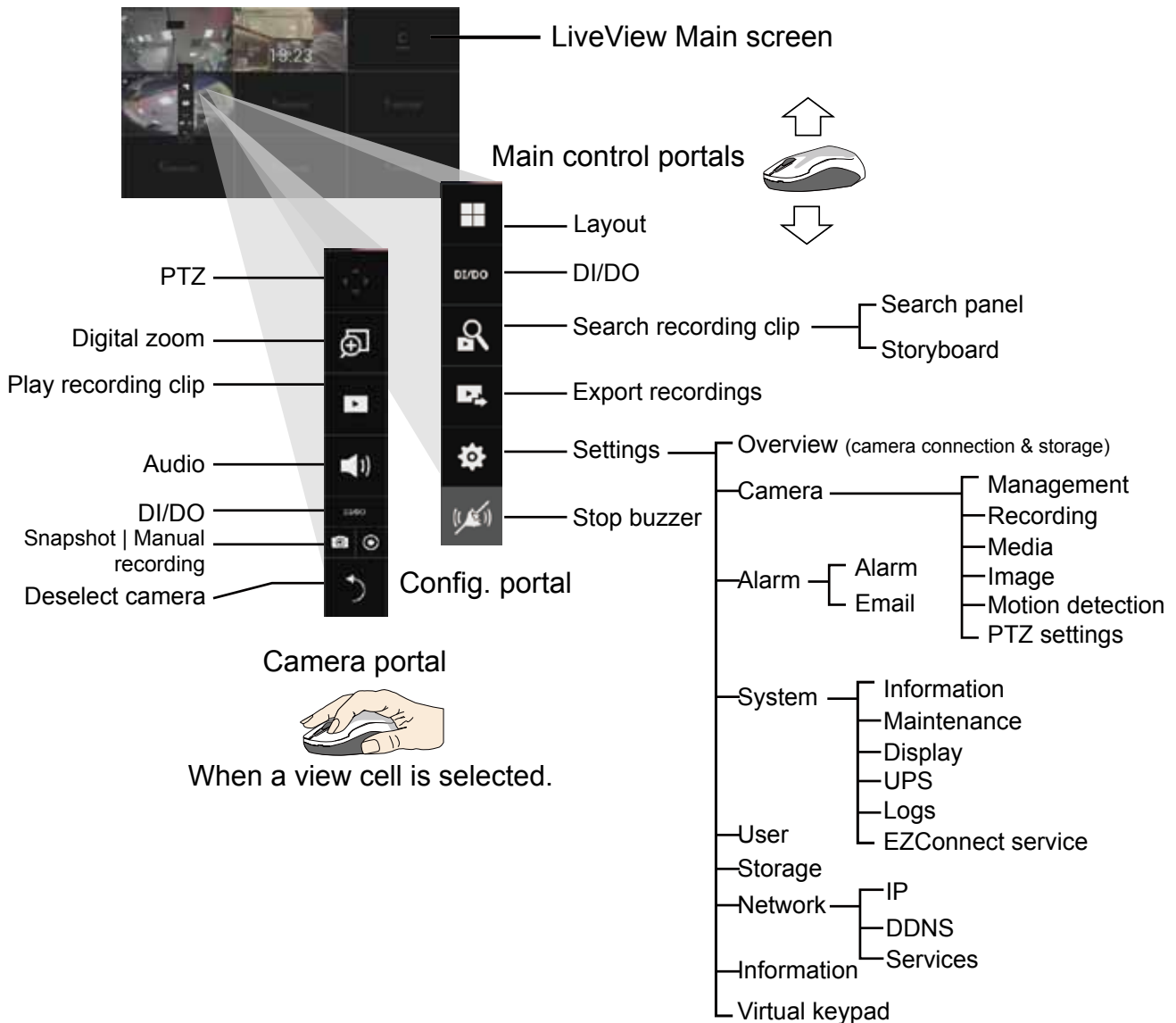

After you finish configuring using a Camera portal, click again on the camera view cell to reveal the main control portals.

**! IMPORTANT:**

Due to the limitation of system resources, the fisheye dewarp (1R & 1P modes) can only take place on one view cell, for one fisheye camera.



## 2-1. How to Begin

### 1. How to access the Configuration Portal?

Make sure a mouse is attached to your NVR. Move your mouse cursor, and the Configuration Portal will appear on screen. For all the configurable options available through this portal, please refer to Chapter 3 on page 45.



You can also hide these portal toolbar. Right-click on the LiveView screen to display the option.

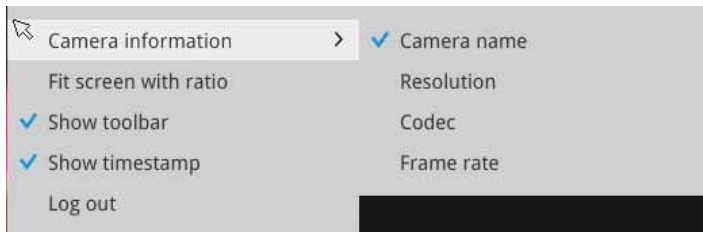

### 2. How to access the Camera Portal?

Single click to select a view cell, the Camera Portal will appear. The system automatically detects the characteristics of an individual camera when you select a view cell.

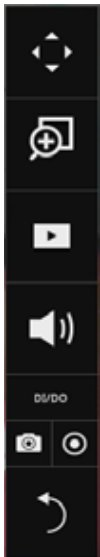

This portal appears with a camera that supports mechanical PTZ.



This portal appears with a camera that does not support mechanical PTZ.

#### Tips:

Here are some operation steps using the tool bar:

1. Single-click to select a view cell and bring out the tool bar.
2. Double-click to expand a view cell to the full view.
3. Double-click again to shrink the view cell to the original size.

PTZ control panel for ordinary PTZ type

PTZ control panel for joystick type PTZ



### 3. How to retrieve and access recorded videos?

3-1. One is to access the video clips taken within 2 hours. Left-click to select a view cell, and then click on the Recording clips button.

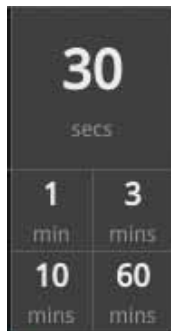
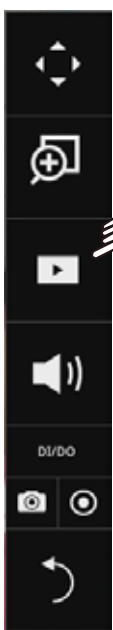

Select a time value by a single click. You will be prompted for User name and Password, enter **admin** and **admin** (the default user name and password), and then click **Login**.

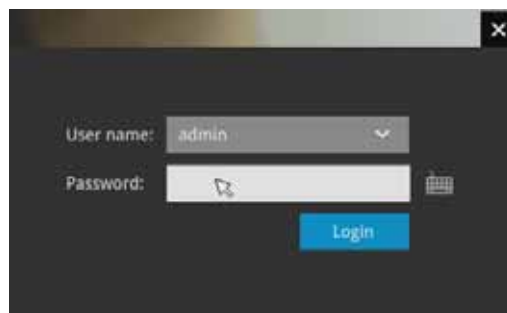

The **Playback** window will prompt, and a playback begins from the point in time you selected, e.g., 30 seconds ago. This function allows you to quickly review what has just happened.

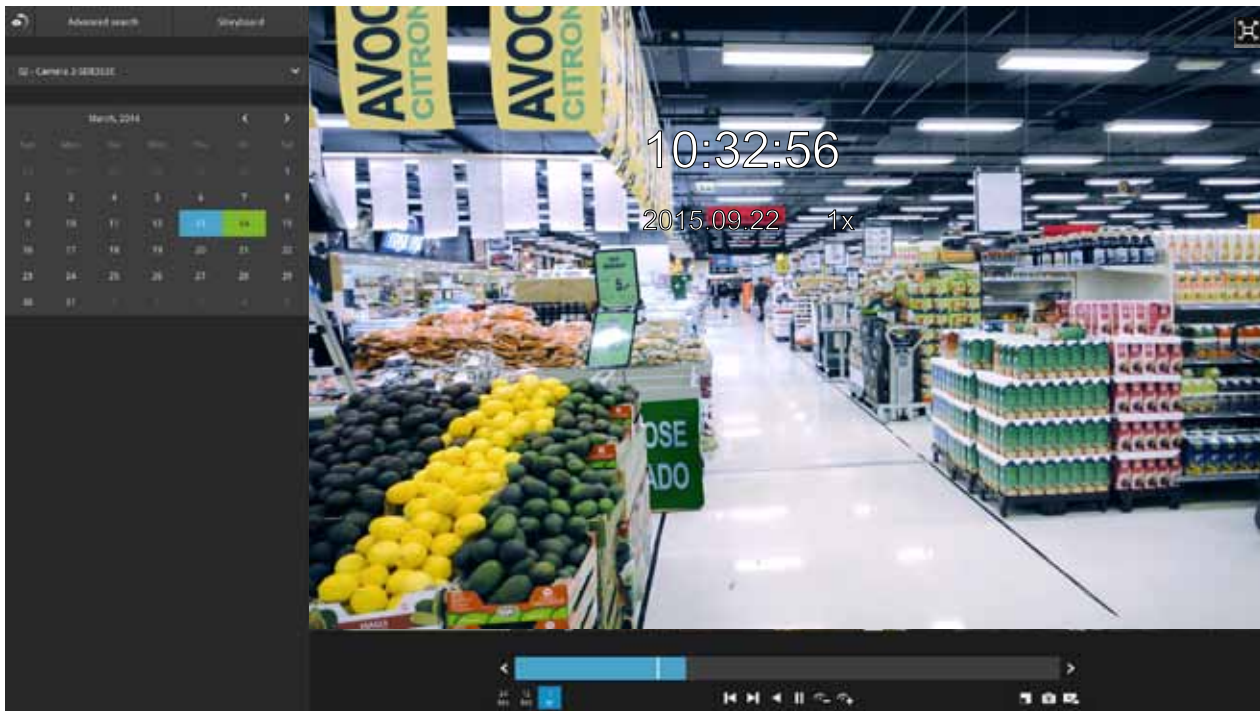

3-2. Another way to access past videos is to open the **Search recording clips** window. Move your mouse cursor to display the **Configuration Portal** (without selecting any view cell). Click on the Search recording clips button. Please refer to page 46 for more information about the search functions.

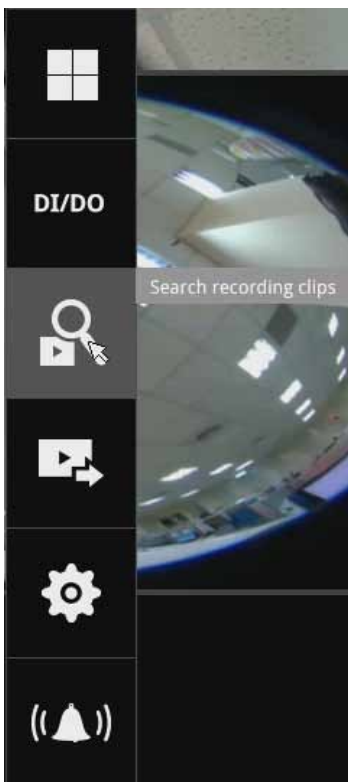

You will be prompted for User name and Password, enter **admin** and **admin** (the default user name and password) and click Login.

It is highly recommended to change the password after you log in.

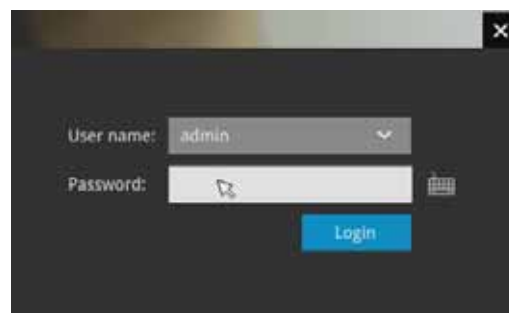

#### 4. How to receive system alarm?

Please refer to page 75 for how to configure system alarm triggers. When the alarm is triggered, e.g., by digital inputs or motion detection, an alarm message will prompt on the screen.

Use the > arrow button to browse through the alarm messages.

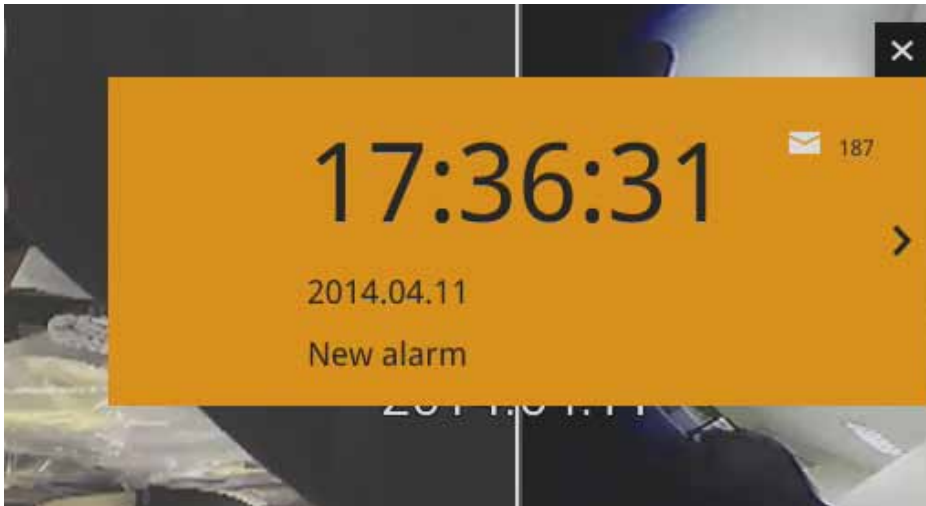

If the alarm is configured with video recording as the responding action, you can click on the alarm entry. The Playback window will appear, allowing an instant playback of the alarm-related footage. You will enter the "Search alarm results" page even if the alarm does not trigger a recording action.

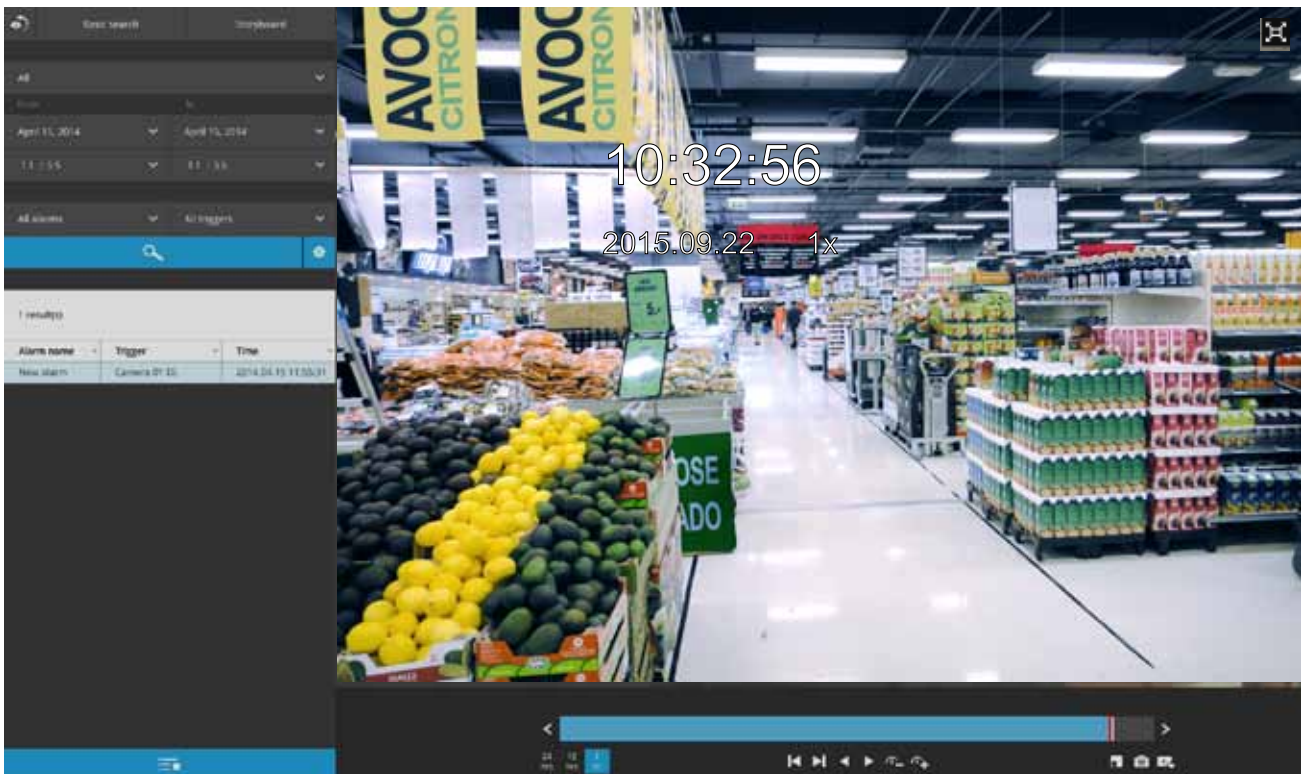

## 5. Why live view is unavailable?

The default live view receives a camera's stream #1. If a camera's stream #1 is configured using **MPEG-4** as the video codec, the following message will prompt.

You can go to the Settings > Camera > Media > Video window to configure the video codec of stream #1 into H.264 or H.265.

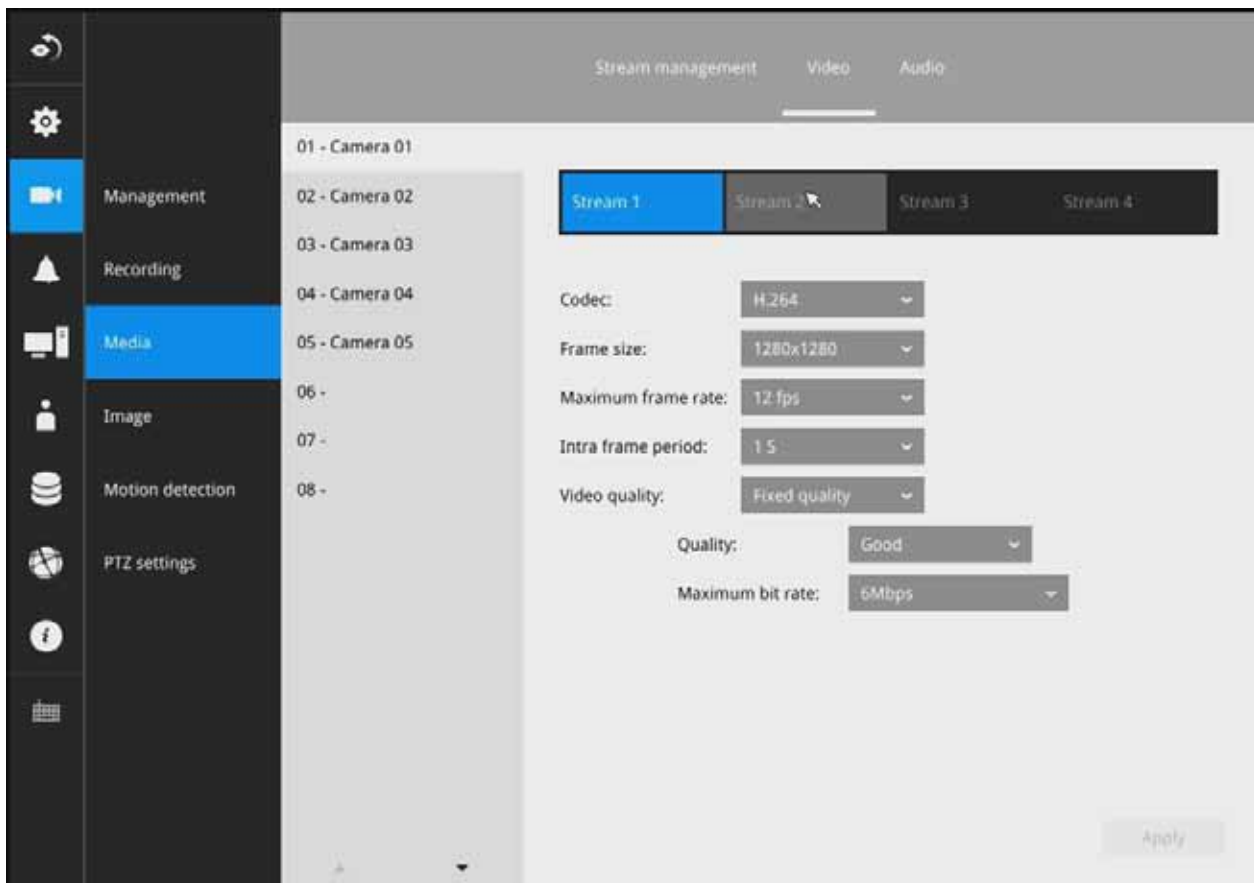
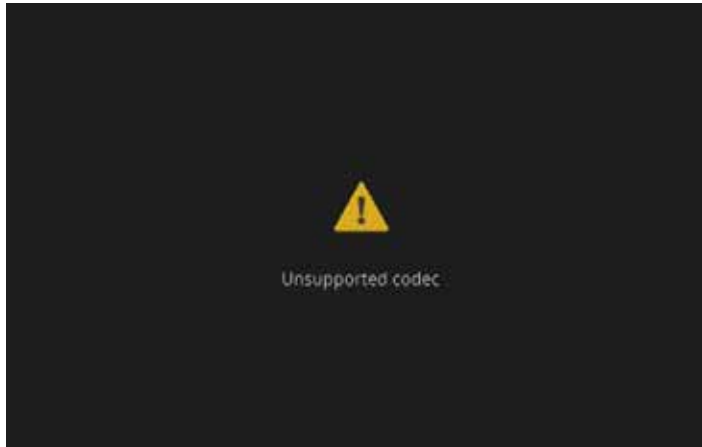

## 6. How do I move to another layout page?

Move your cursor to the right hand side of your screen. The page turner buttons will appear as shown below.

For example, if you have 8 cameras placed on 2 2x2 layout pages, use these buttons to visit different pages.

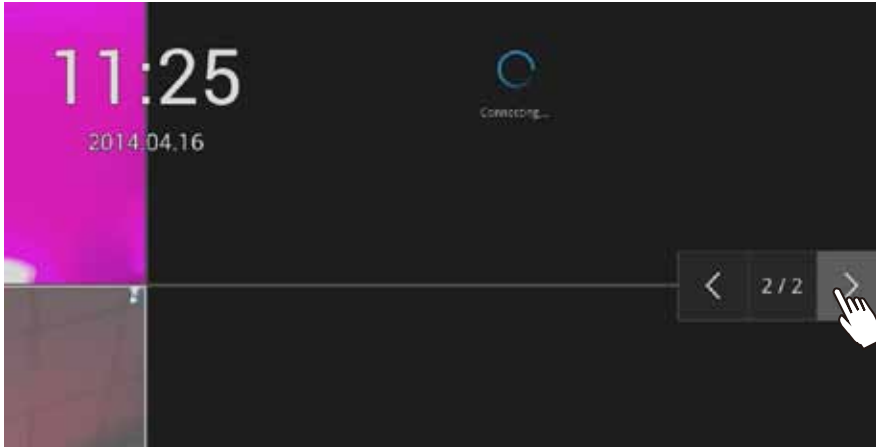

## 7. Why the onscreen tool bars disappear after some time?

The system comes with idle modes. Below are the applicable conditions:

1. **Live view:** if no management activities occur for 5 seconds, the tool bars disappear from screen. When in the idle mode, mouse cursor and tool bars will disappear. Moving the mouse cursor will re-activate the screen.
2. **Settings page:** If left unattended for 10 minutes, system will automatically log out. The system will prompt for user credentials if a user tries to access the Settings page again.
3. **Search recording clips window:** If currently there is a video playback, the system will not enter the idle mode.

## 2-2. Operation on Camera View Cell

### 2-2-1. PTZ Panel

Once you selected a camera, click on the PTZ button on a camera portal.

The PTZ panel will prompt. Below are the description of its functions:

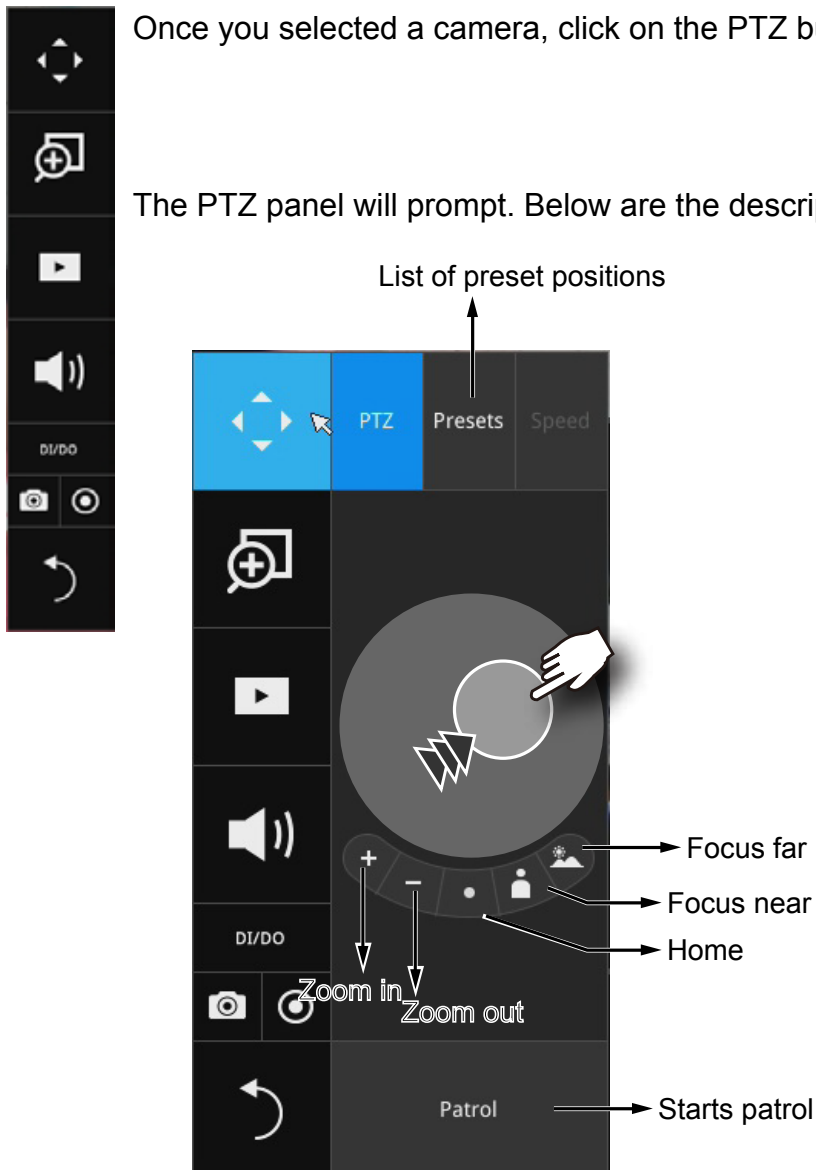

1. PTZ control: Click and drag the nudget in the center towards the direction you wish to move to.
2. Focus: Click on the Focus near and Focus far buttons to adjust camera focus.
3. Home: Click to move the camera lens towards the default home position.
4. Zoom: Use the Zoom in and Zoom out buttons to adjust the camera's zoom ratio.
5. Presets: If you configured preset positions, a list of preset positions will appear.
6. Patrol: If you configured preset positions into a patrolling tour, click on this button and the camera will proceed with patrolling through preset points.

Note that on a speed dome camera, the farther you pull the nudget away from the center, the faster the lens moves. This works like speed control.

Below is the PTZ panel that appears with ordinary PTZ cameras.

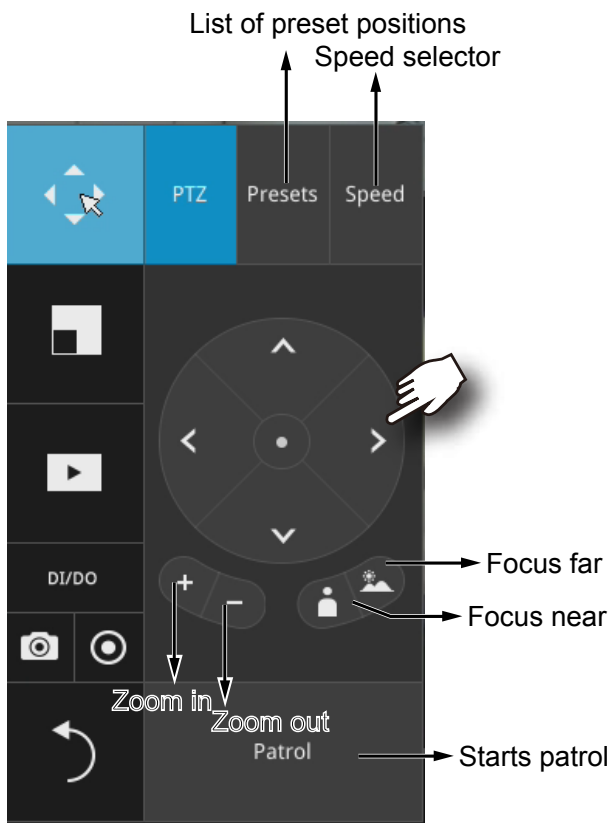

1. PTZ control: Click on the arrow buttons to move towards the direction you wish to move to.
2. Focus: Click on the Focus near and Focus far buttons to adjust camera focus.
3. Zoom: Use the Zoom in and Zoom out buttons to adjust the camera's zoom ratio.
4. Presets: If you configured preset positions, a list of preset positions will appear.
5. Speed: Adjusts the speed when moving across the field of view.
6. Patrol: If you configured preset positions into a patrolling tour, click on this button and the camera will proceed with patrolling through the preset points.



This portal appears with a fisheye camera. The PiP and PTZ buttons will then be disabled.

**! IMPORTANT:**

Due to the limitation of system resources, the fisheye dewarp (1R & 1P) can only take place on one view cell, for one fisheye camera.



## 2-2-2. Digital zoom Panel



Digital zoom is a function that provides digital zoom into a live video.

When activated, a Global view window will appear at the lower right of the view cell as shown below. You can display only a portion of the complete video frame as an area of your interest. Using a click and drag on the ROI window, you can instantly move to other areas within the video frame. Use the zoom ratio pull bar at the bottom to change the zoom ratio. You may also move the ROI around by click and drags.

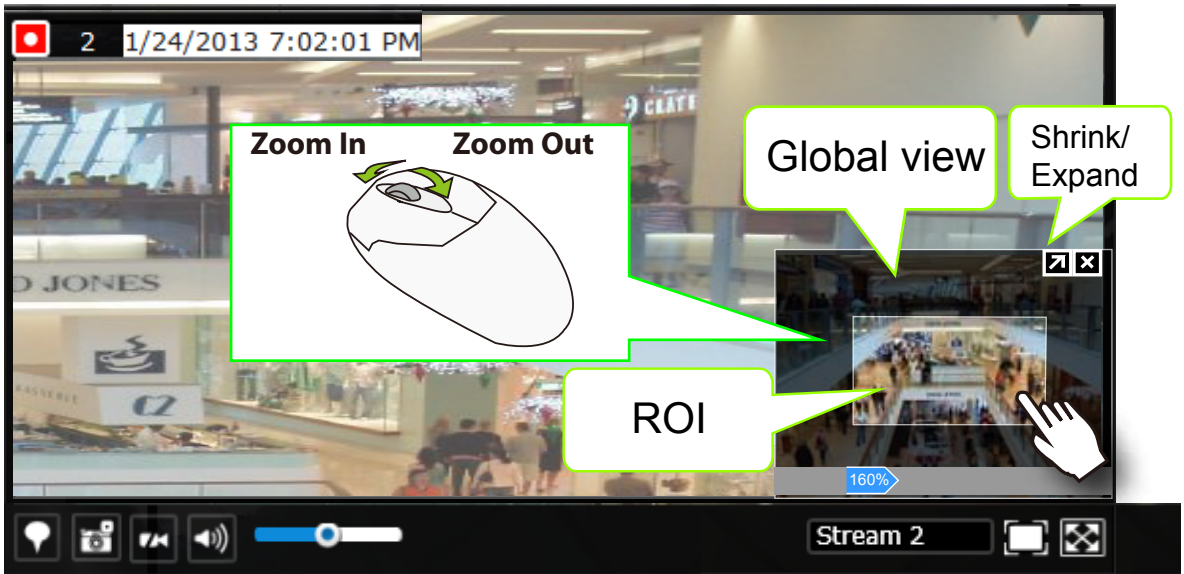

Note that not every camera supports the PiP function.

### NOTE:

Please refer to page 118 for the description of fisheye display modes. The working theory on fisheye modes is identical for use on both local and web consoles. The fisheye mount type setting is found in the **Settings** window.

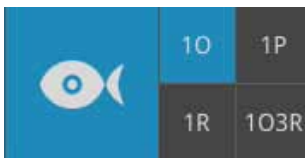

## 2-2-3. Play Recording Clips Panel

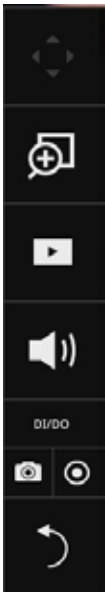

The Play Recording Clips function provides a shortcut to the latest recordings on the system. You can select 30 secs, 1 min, 3 mins, 10 mins, and 60 mins for an immediate playback.

For security reasons, using this function requires users to enter his/her credentials.

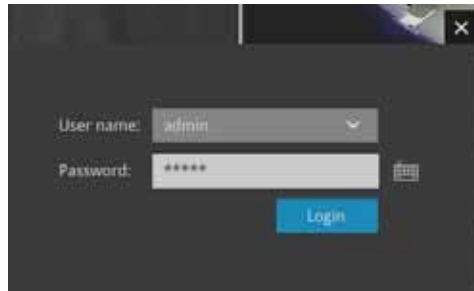
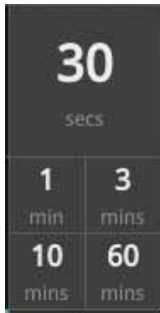

The **Playback** window will prompt, and a playback begins from the point in time you selected, e.g., 30 seconds ago. This function allows you to quickly review what has just happened.

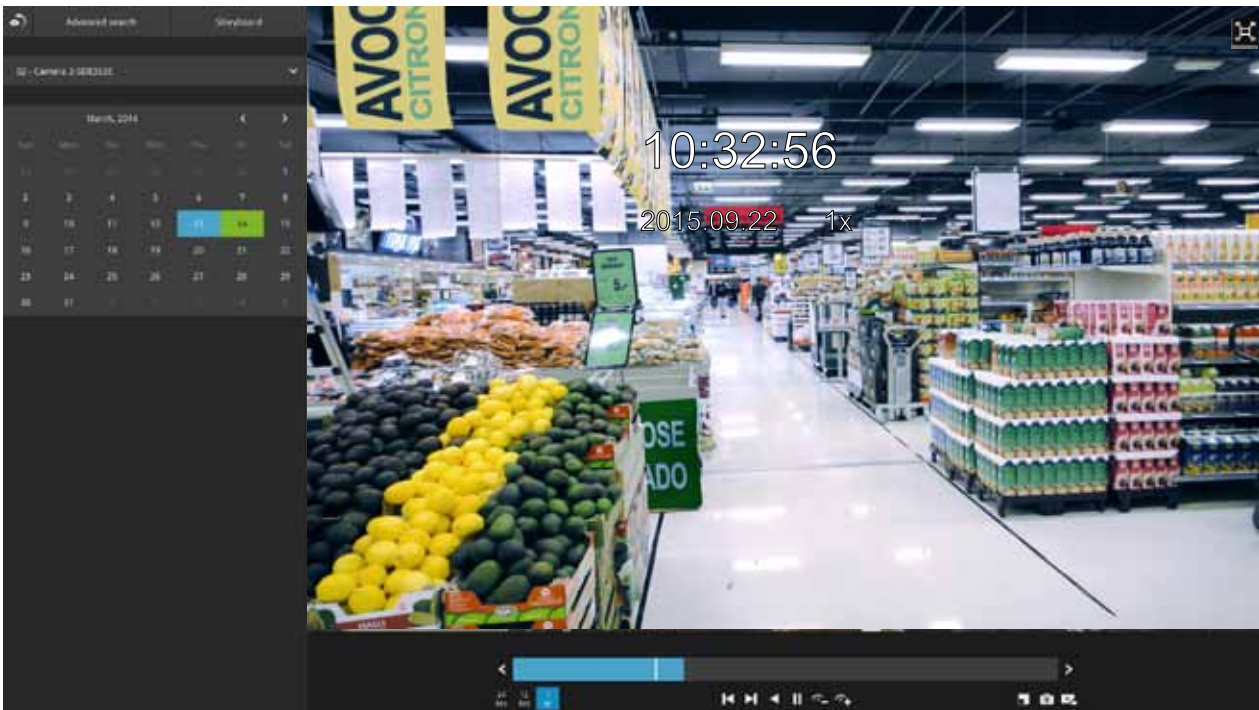

## 2-2-4. DI/DO



The DI/DO panel provides a glimpse of all DI and DO signal statuses from the connected cameras. You can manually trigger a digital output by clicking on its indicators.

When a digital input is triggered, its status will also be indicated on the panel.

### **WARNING:**



Please note that DO is triggered by one click. You should then click again to disable the DO. Otherwise, the DO signal will be continuously triggered. As the result, if the DO is configured as an alarm trigger, many alarm messages will be generated.

## 2-2-5. Others

1. Snapshot : is used to take a snapshot from the camera currently selected. Note that this function only saves the snapshot (in JPEG) to a USB thumb drive.

### **IMPORTANT:**

The USB thumb drive has to be one that is formatted in FAT format.

2. Manual Recording : Press the button to start a manual recording from a selected camera. Click again to stop the recording.
3. Return button : Click to return to the LiveView window.

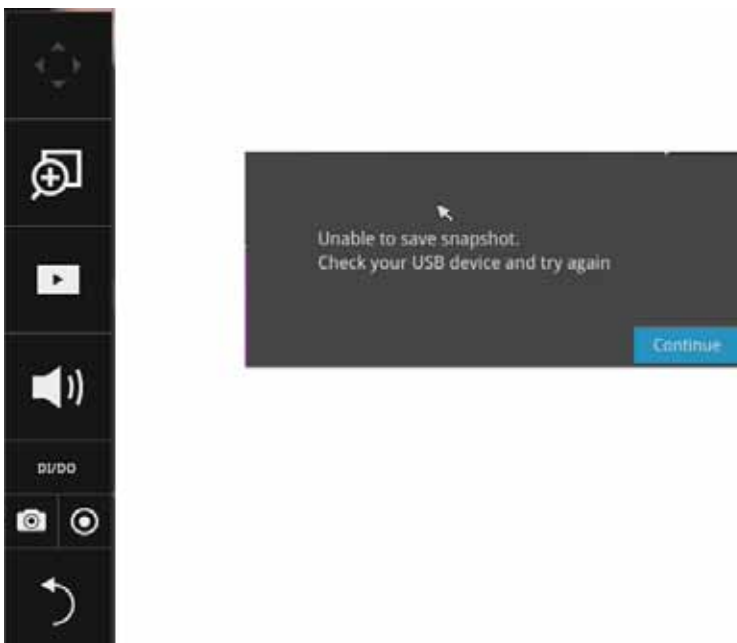

## 2-2-6. Right-click Commands

Left-click to select a camera. Right-click to display the selection menu.

1. Camera information: Click to display camera name, resolution, codec, or frame rate on the view cell. The information will display on the upper left corner of a view cell.
2. Fit screen with ratio: The NVR server automatically optimizes the display of camera view cells. However, you can still select this option to display the camera's original aspect ratio: for example, the original video feed can be 4:3. Without the fit screen, every camera's image will be expanded to fill the view cell.
3. Show tool bar: You can hide the tool bars by deselecting this option.
4. Show timestamp: You can hide the time stamp bars by deselecting this option.
5. Log in: Log in to enable system configuration.

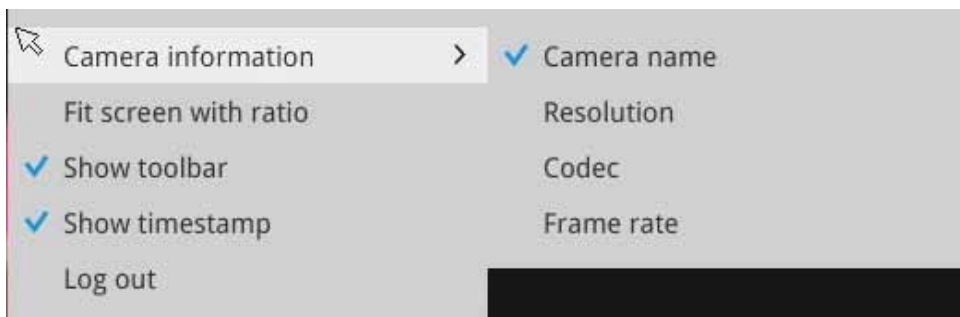

# Chapter Three

## Configuration Using the Local Console

### The Main Control Portal

#### 3-1. Layout

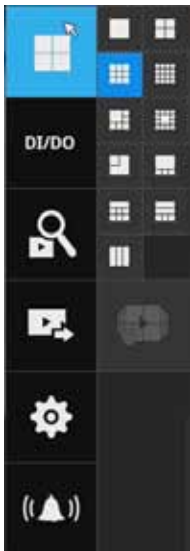

Move your mouse cursor across the screen to display the portal.

By default, 5 typical layouts are provided for the user. They include: 1x1, 2x2, 3x3, 4x4, 1P+3, 1M+5, 1M+12, and 1M+31. If you select the single view layout, the rotation button  will appear. Click the rotation button below to let the system swap the display of different cameras by every 10 seconds. The rotation speed is configurable via Settings > System > Display.

#### 3-2. DI/DO



Click on the DI/DO button to display the full list of all DI and DO signals (whether they are connected or not) from all cameras in the configuration. If a digital input signal is triggered, e.g., the DI-4 on the left, its indicator will turn solid white.

### 3-3. Search recording clips

#### 3-3-1. Basic Search



Click the button to start searching for recorded clips. A confirm box will prompt. Enter User name and Password to proceed.

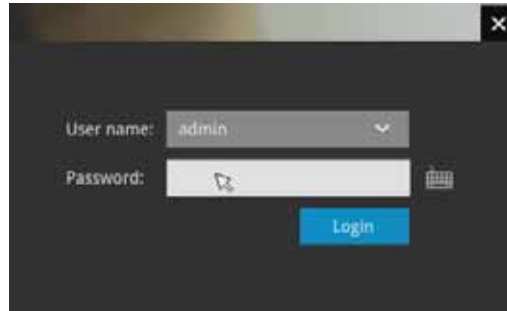

The search and calendar view will appear. Select a day on the calendar when the the recordings took place (the days with recorded clips will be highlighted in blue and green). Double-click on a day to begin playback and search.

The date highlighted in green indicates today, and the green indicator does not necessarily mean that there are recorded videos today.

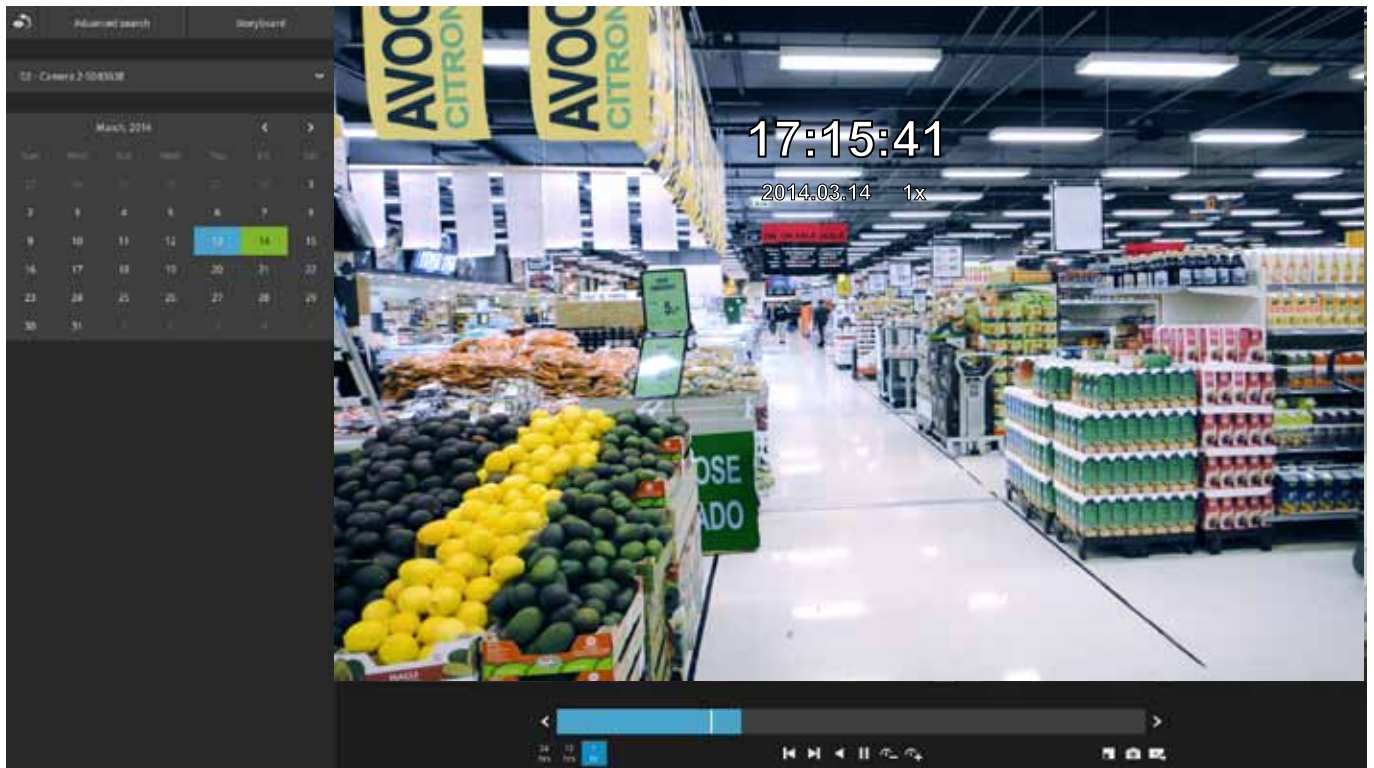

The timeline bar enables quick skimming through the recording. Its functions are described as follows:

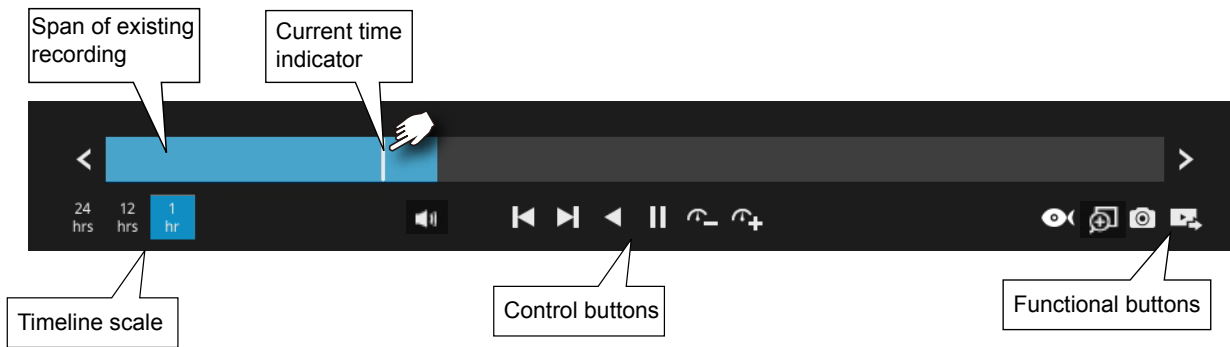

Buttons	Description
	Time scale selector. Use the buttons to select the span of time displayed on the tool bar.
	Previous frame. (I-frame only)
	Next frame. (I-frame only) After you paused a playback, use this button to browse video frame by frame.
	Play backwards.
	Play. This button is available after you paused a playback.
	Pause.
	Each click on it speeds down by 1/2. The slowest speed is 1/16.
	Each click on it speeds up by 2x. The fastest speed is 16 times. The current playback status is indicated on the screen.
	PiP (Picture in Picture). This applies when a camera is displaying the full of its field of view. You can use the PiP function to move to unrevealed areas.
	Snapshot. Takes a snapshot of the current FOV.
	Export clips. Use this function to select a span of time you want to export to other medias.

By default, the playback starts from the beginning of a day's recording. While playing the recorded video, click on the timeline to replay a point in time in the video.



The fisheye dewarp modes can be selected during a playback: e.g., 1R, 1P, and 1O3R.

When playing the video recorded by a fisheye camera, the fisheye display options  will be available on screen. You can click to select the 1O, 1P (Panoramic), 1R (Regional), or 1O3R (1 Original and 3 Regional) modes. If 1P, 1R, or 1O3R mode is selected, you can exert the mouse control on screen, such as swiping the view, or hold down the mouse button and swipe the field of view.

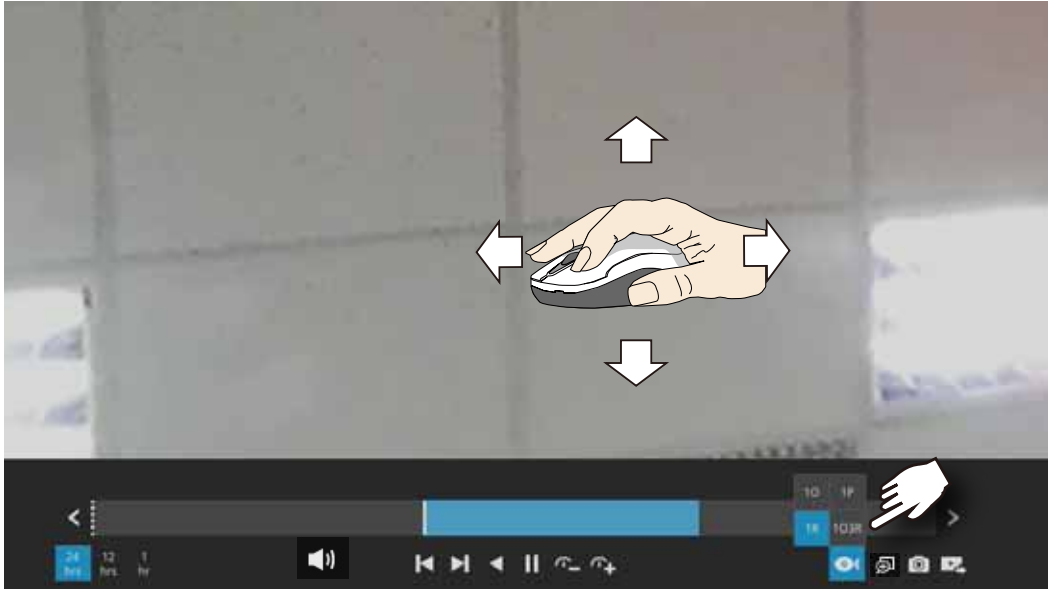

Please refer to the User Manuals that came with fisheye cameras, or page 118 for description of fisheye display modes.



Note that to export a video segment from the playback timeline,

1. Click on the **Export** button ,
2. Insert a USB drive formatted in the FAT format.
3. Select the "From time" by clicking on the timeline. You can also manually enter the "From time" and the "To time."
4. Click on the "From time" tab using a single click.
5. Repeat steps 3 and 4 to configure the To time.
6. Click on the Export button.

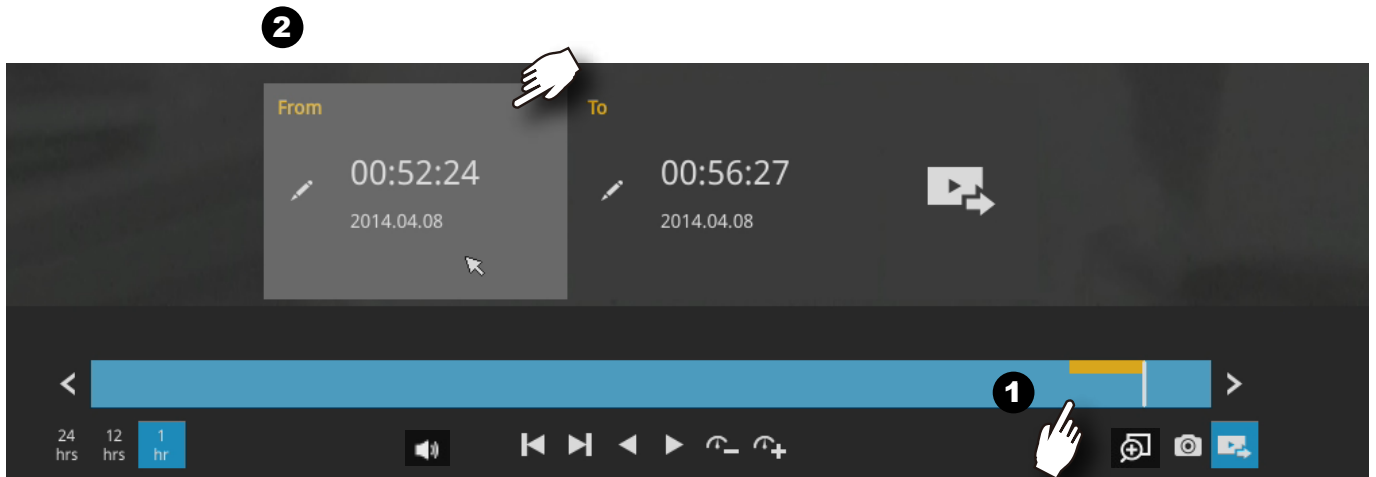

The export process is indicated on the right. Depending on the length of footage to be exported, this process can take minutes.

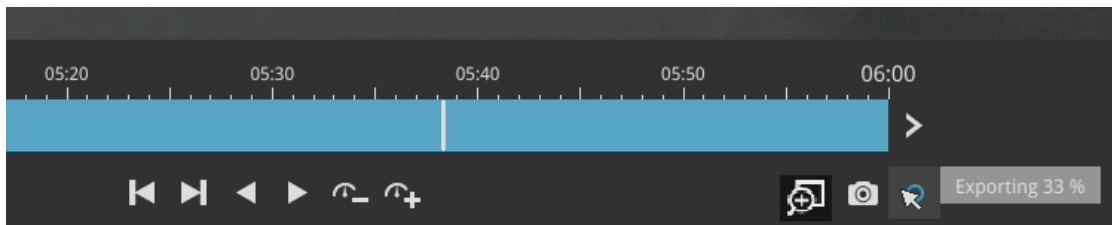

When completed, a message will display on screen.

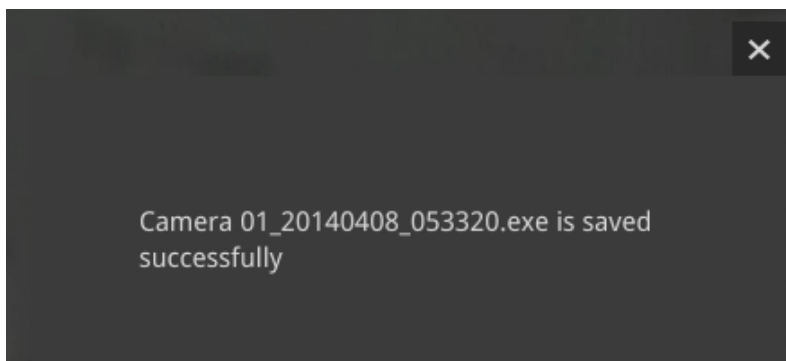

The default for export is 5 minutes before and 5 minutes after the point in time that is currently selected.

### 3-3-2. Advanced Search

Click on the Advanced search button on the upper left of the screen to enter the Advanced Search mode.

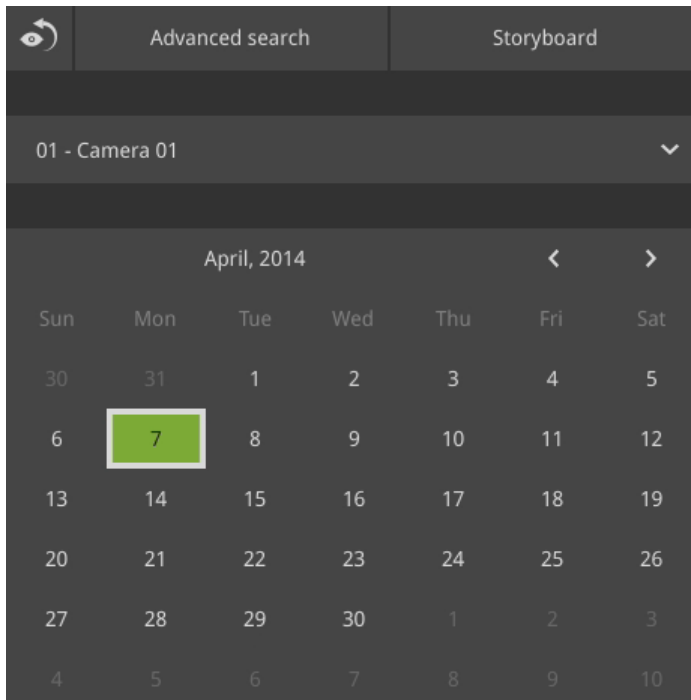

You can specify the search criteria by selecting the devices to be involved in the advanced search.

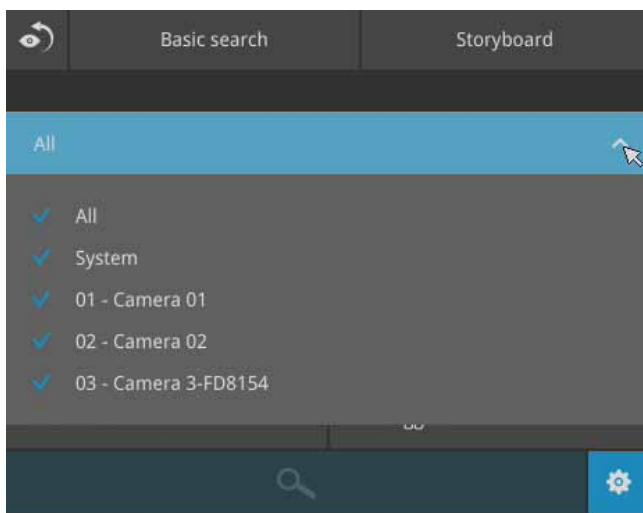

You can then specify the start time and end time to configure a span of time to be searched.

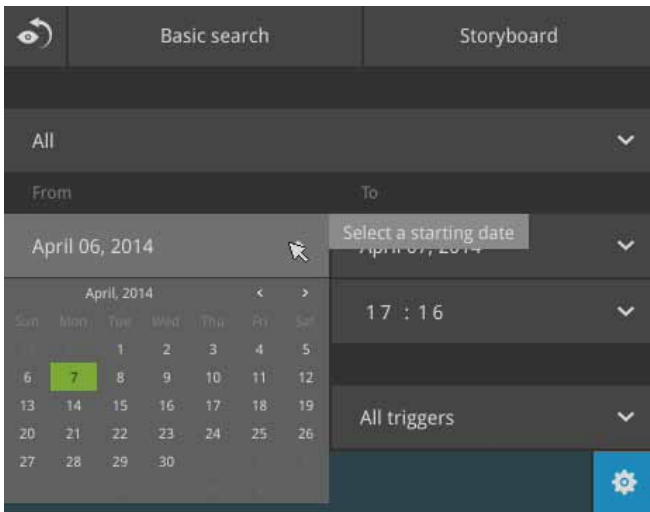

You can also determine what alarms will be included in the search.

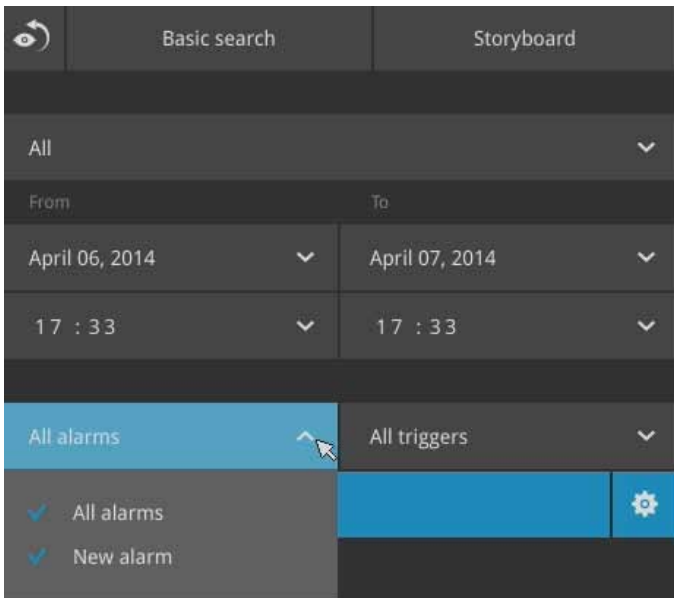

You can select what types of triggers were associated with the recordings you want to find.

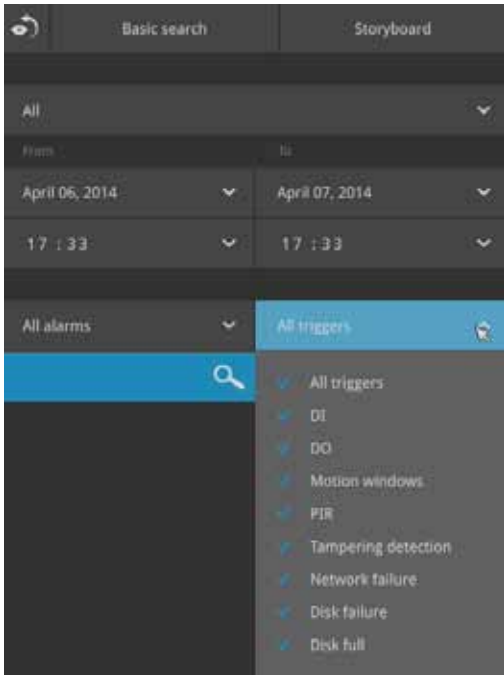

When done with the selection, click on the Search button. In the sample screen below, a list of alarms is displayed, and you can double-click on any of them to replay the moment when the alarm was triggered. The alarm-related recording will typically include a length of 5 seconds of pre-alarm and 20 seconds of post-alarm footage.

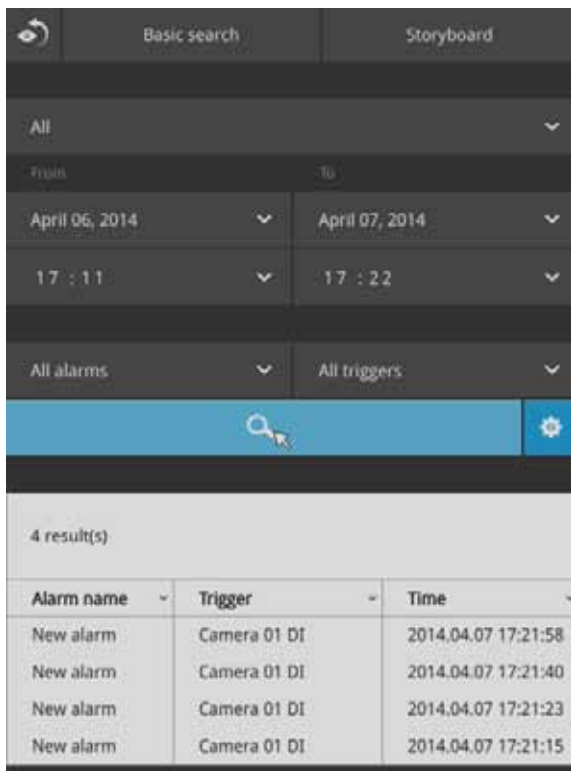

Up to 200 search result entries will appear. If more than 200 entries have been found, click on the New results button on the last entry page.

If two cameras participate in the recording of an alarm-related event, the footage of one camera will be played first, and then that of the other.

If user's operation takes place (pause, rewind, etc.) during the playback, the system will stop the consecutive playback of multiple alarm footages.

**NOTE:**

When the Search window is left unattended for 10 minutes, the NVR will return to the live view display. To enter the Search window, you will have to enter the user credentials again.

### 3-3-3. Storyboard

The Storyboard interface provides a glimpse of past recordings over a timeline. It looks like doing the film editing after a film was shot.

To enter the Storyboard window, click on the Storyboard shortcut on the upper-left of screen.

Below are the screen elements of the Storyboard window:

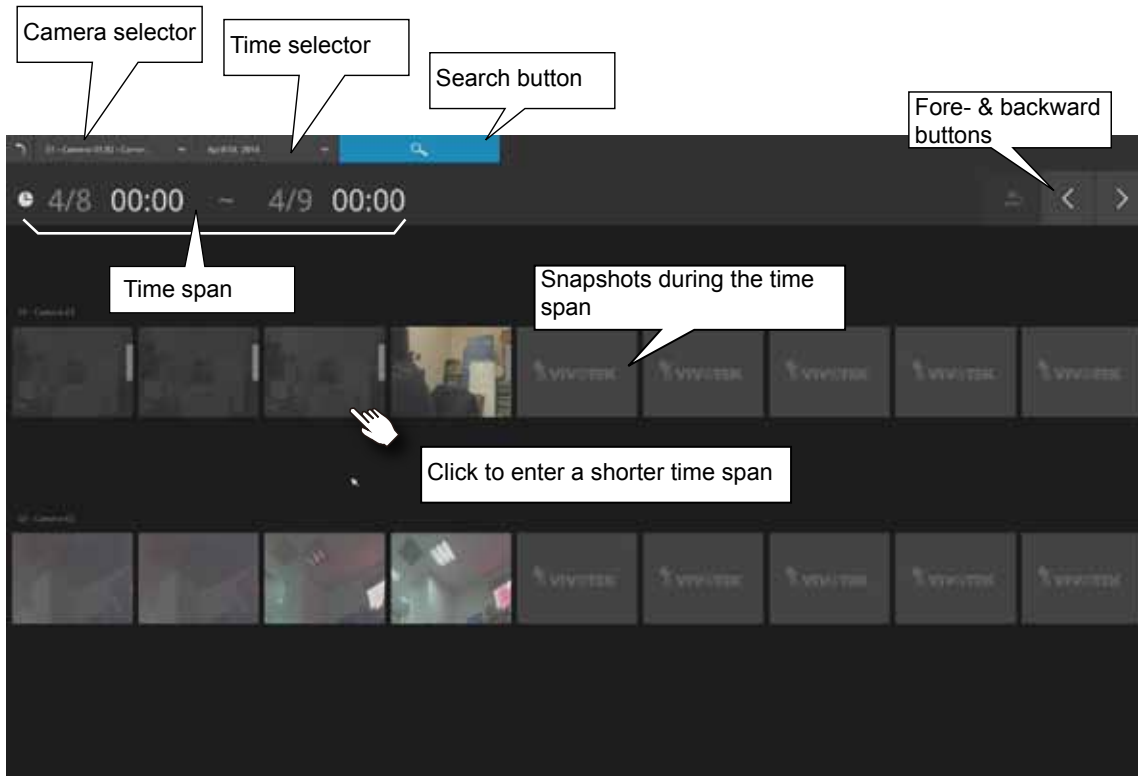

To search for a particular video footage, select the target cameras and the time of recording. On the Storyboard, the timelines of up to two cameras can be displayed.

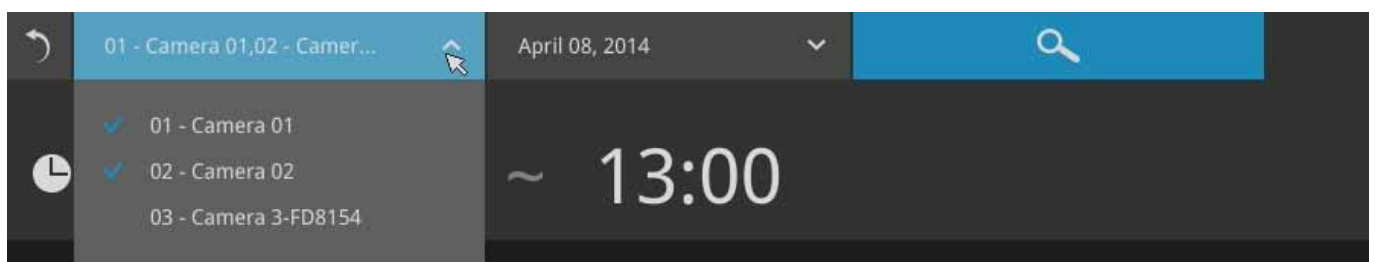

Click on the **Search** button .

Mouse over the line of snapshots to display its time of recording. Click on a snapshot of your interest. The time of recording is immediately displayed on top of it.

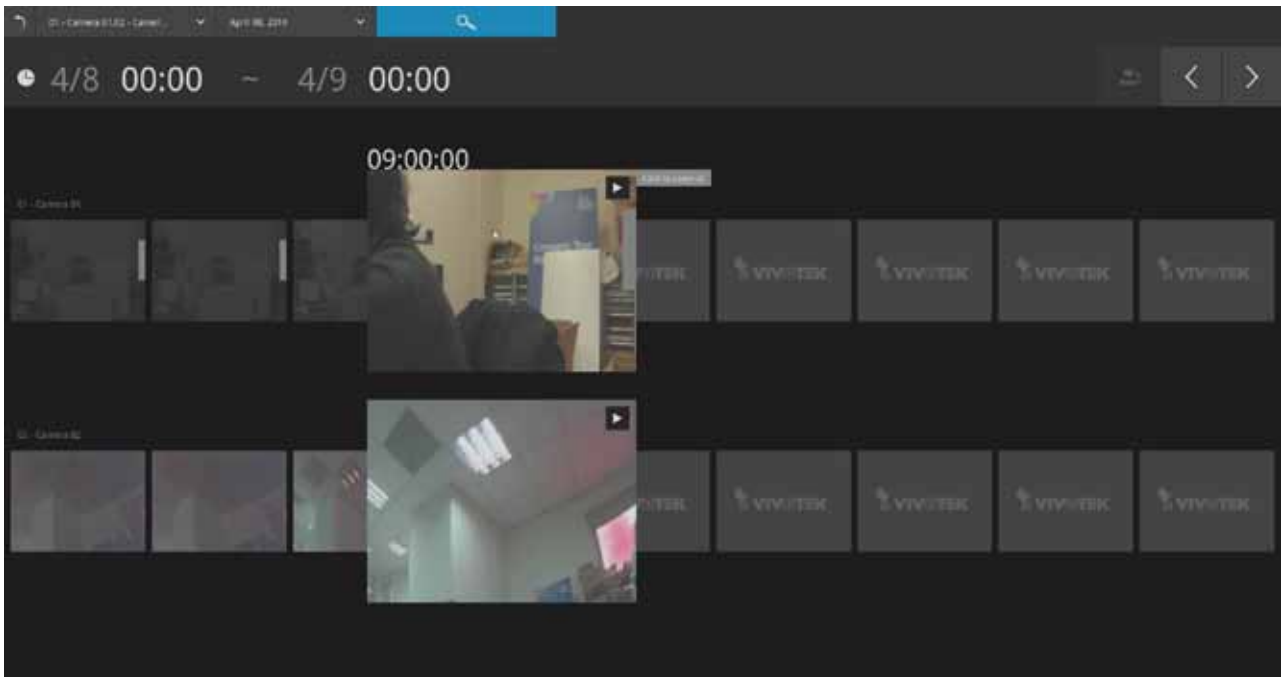

The detailed search is based on a narrow-down criteria. The search begins from a 24-hour time span, and then moving in to a 4-hour, 1-hour, 10-minutes, and 2-minutes span. When the screen displays a 24-hour span, each snapshot represents a 3-hour time span.

Each click on a snapshot brings you deeper into the timeline.

- 24 hour
- ↓
- 4 hour
- ↓
- 1 hour
- ↓
- 10 mins
- ↓
- 2 mins

Below is a sample screen showing the screen of a one-hour time span. Each snapshot represents a point in time 7.5 minutes apart. Click on a snapshot of your interest to get deeper into the timeline.

Time span:  
1 hour

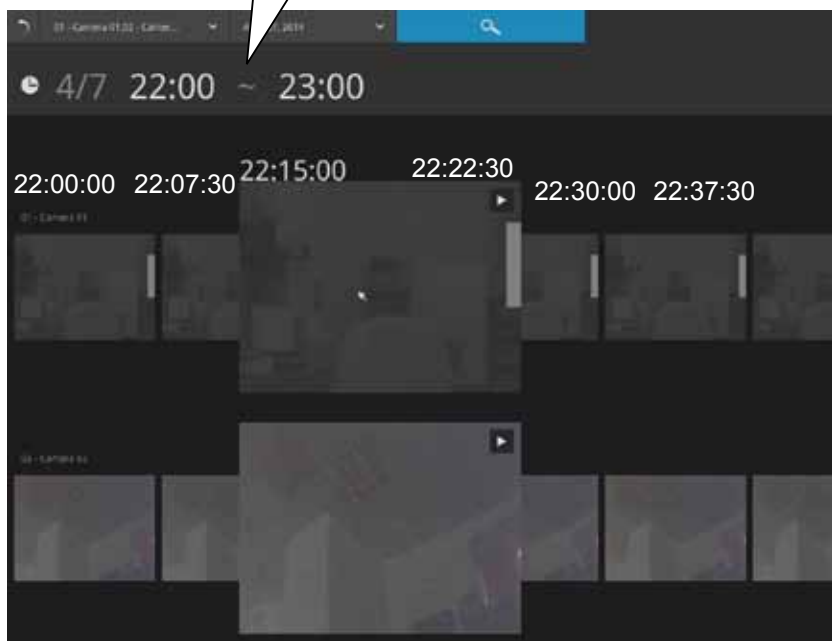

If you find yourself in the wrong segment on the timeline, use the buttons on the upper-right of the screen to travel.

The definitions of these buttons depend on the time span of your current position. For example, if you are in a 4-hour time span, the "Back to previous state button" will bring you back to the 24-hour time span.

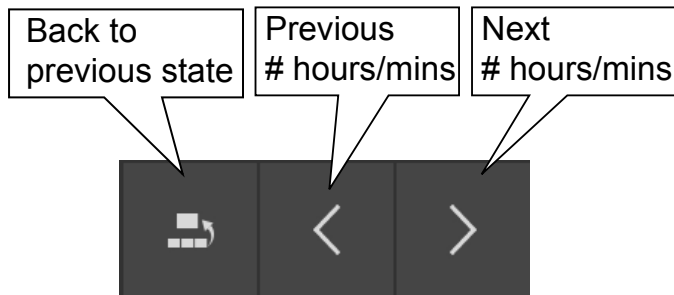

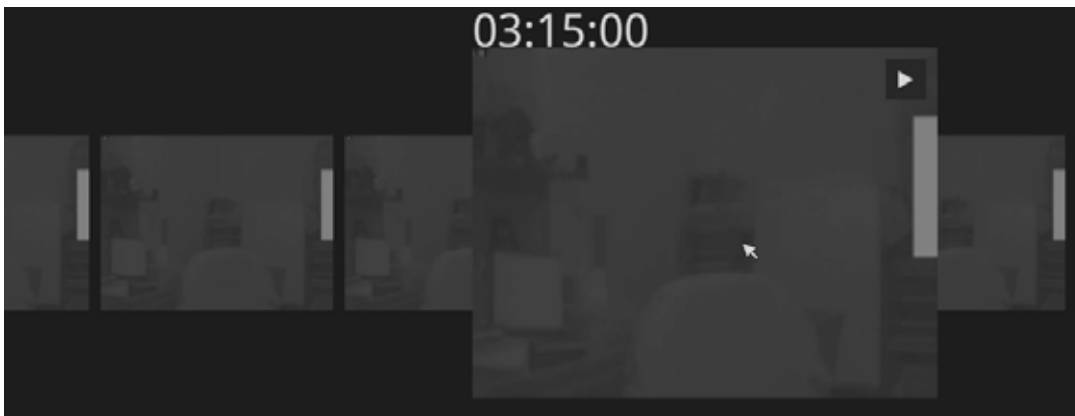

The smallest time span is 2 minutes. And on the screen of 2-mins span, each snapshot represents a 15 seconds video footage.

You can then click on the Play button  to playback the recorded footage.

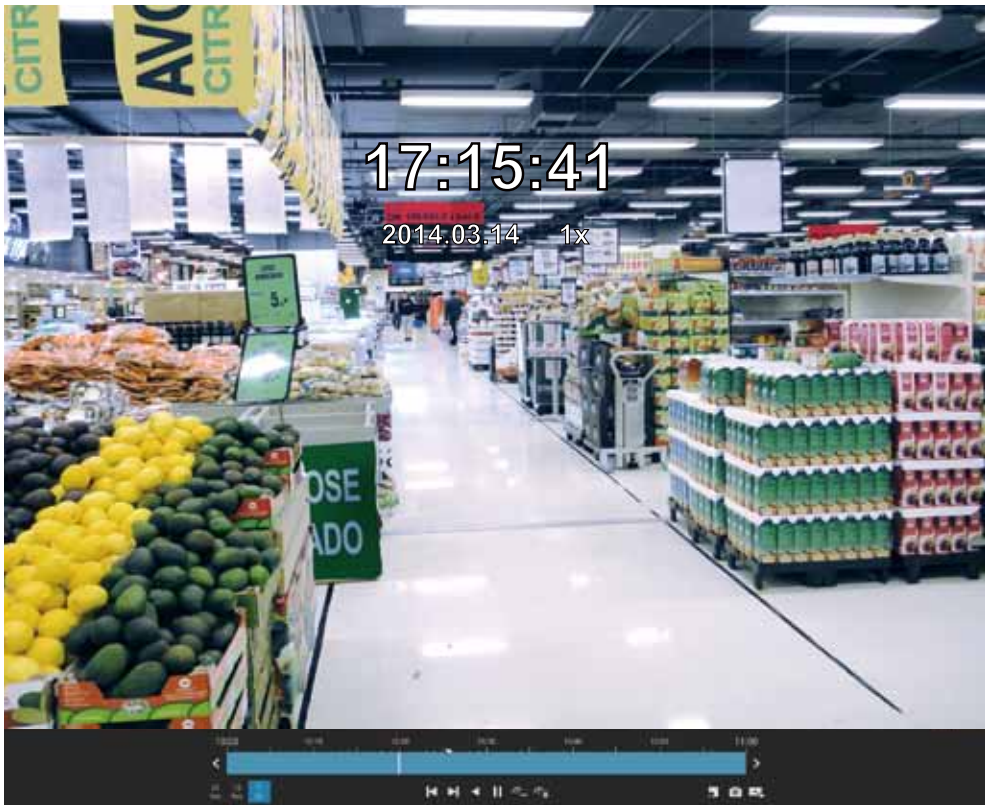

The playback window will appear. Please refer to page 47 for the operation details.



To return to the Live View window, click on the Back to Search recording clips button  and the Back to Liveview button  on the upper-left of the screen.



### 3-4. Export recordings



The Export recordings button allows users to directly select a piece of recordings by a specific camera, and export that to a USB thumb drive. Users can select one or multiple cameras, select a period of time in which the recording took place, and then click export.

The max. length of recording export is 24 hours.

To export recordings:

1. Attach a USB thumb drive formatted in FAT format to the NVR's USB port.
2. Select one or multiple cameras from the list.

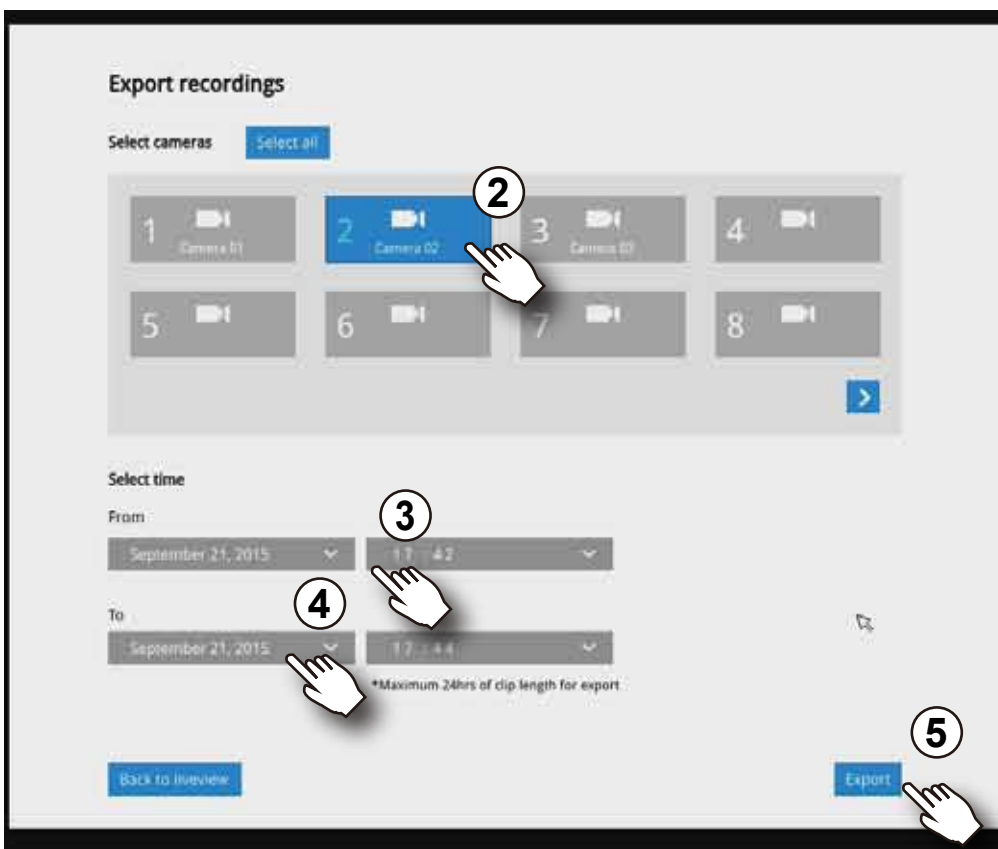

3. Select the start time of the period of recording time.
4. Select the end time of the period of recording time.
5. Click the Export button.

6. The Export progress will be shown.

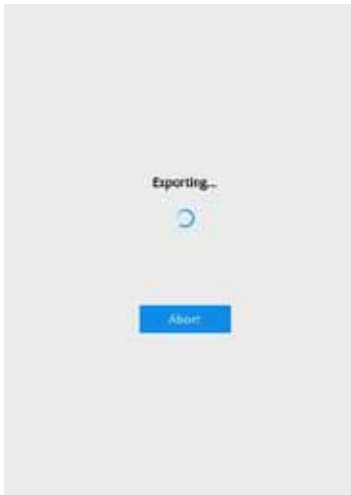

7. When the Export process is done, select to resume another export or go back to the live view.

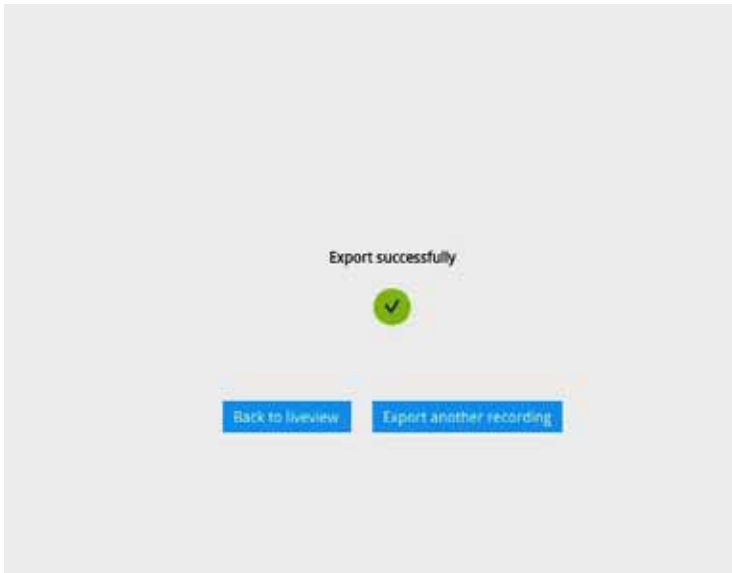



## 3-5. Settings

### 3-5-1. Settings - Overview

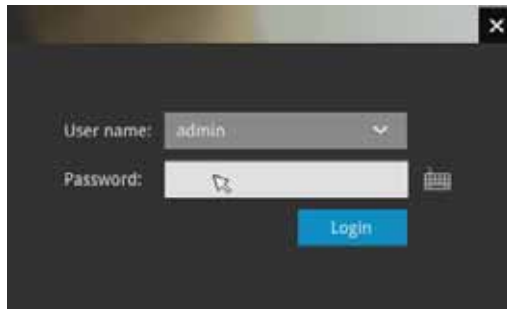

Click the Settings button to start the camera and system settings window. A confirm box will prompt. Enter User name and Password to proceed.



The system will default to the overview page displaying the camera connection and storage statuses. An empty position will be left in blank, and a disconnected camera will be indicated as . The storage volume usage is displayed as the used and unused spaces.

The **Stop Buzzer**, **Reboot**, and **Power-down** buttons are also available on this page. There are critical conditions that can sound the system buzzer, such as a disk failure.

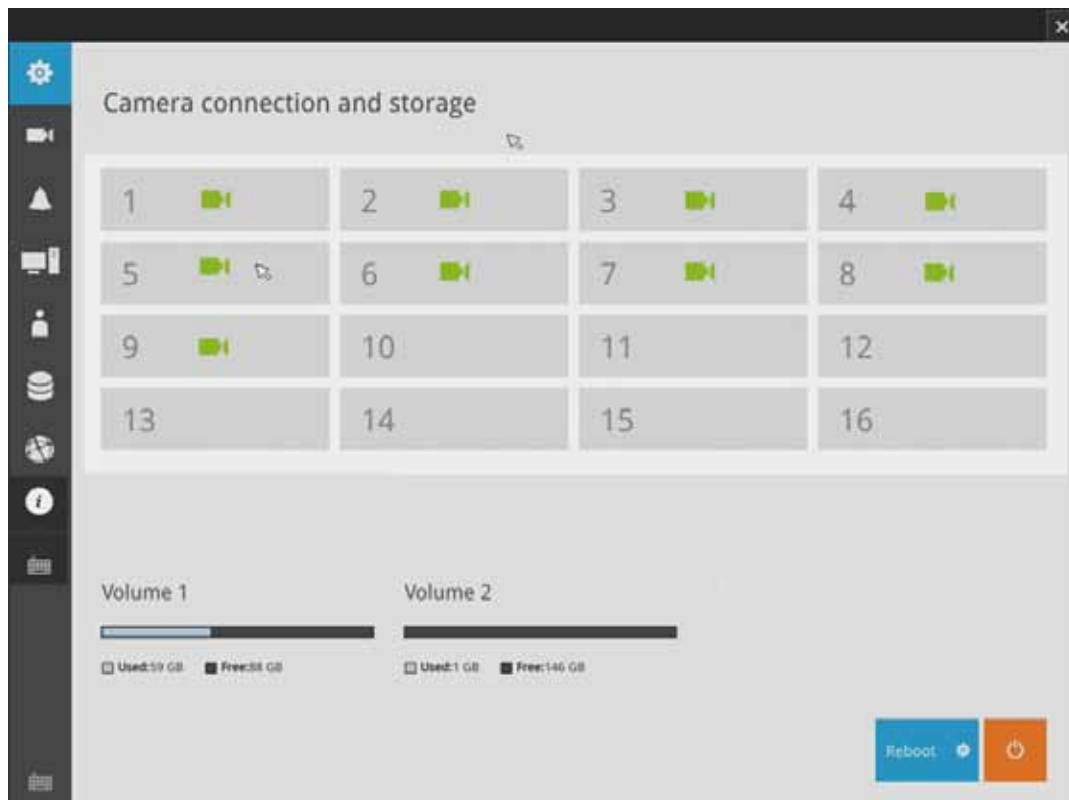

The Camera menu provides access to **Management, Recording, Media, Image, Motion detection, and PTZ settings** pages.

### 3-5-2. Settings - Camera - Management

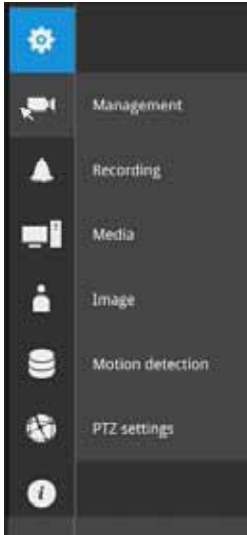

On the camera Management page, you can configure the following:

1. Recruit or disband cameras.
2. Create a camera name.
3. Assign User name and Password, or apply the credentials to all cameras in your configuration.
4. Change the Network settings.
5. Change the cameras' positions on the layout screen.

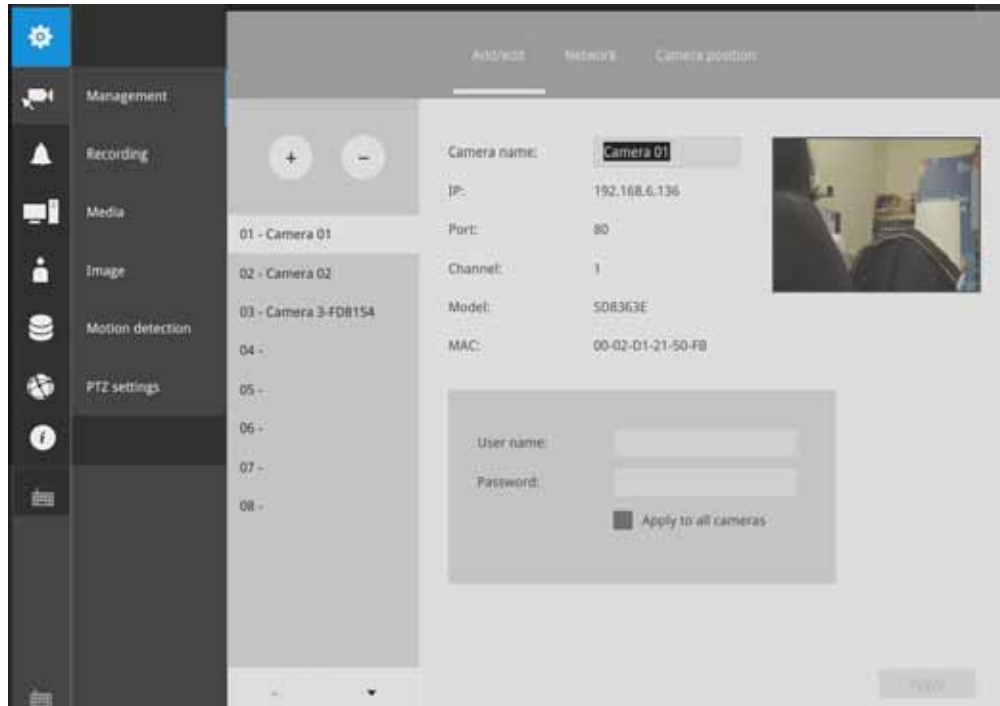

For camera name, you can enter up to 64 alphabetic and numeric characters including [0-9][a-z][A-Z][\_][ ] . For user name and password, you can enter up to 64 alphabetic and numeric characters including [0-9][a-z][A-Z][!][\$][%][^][\_][`][@][~].

To recruit cameras:

1. Click on the Add  button. A list of cameras in the same subnet will appear.

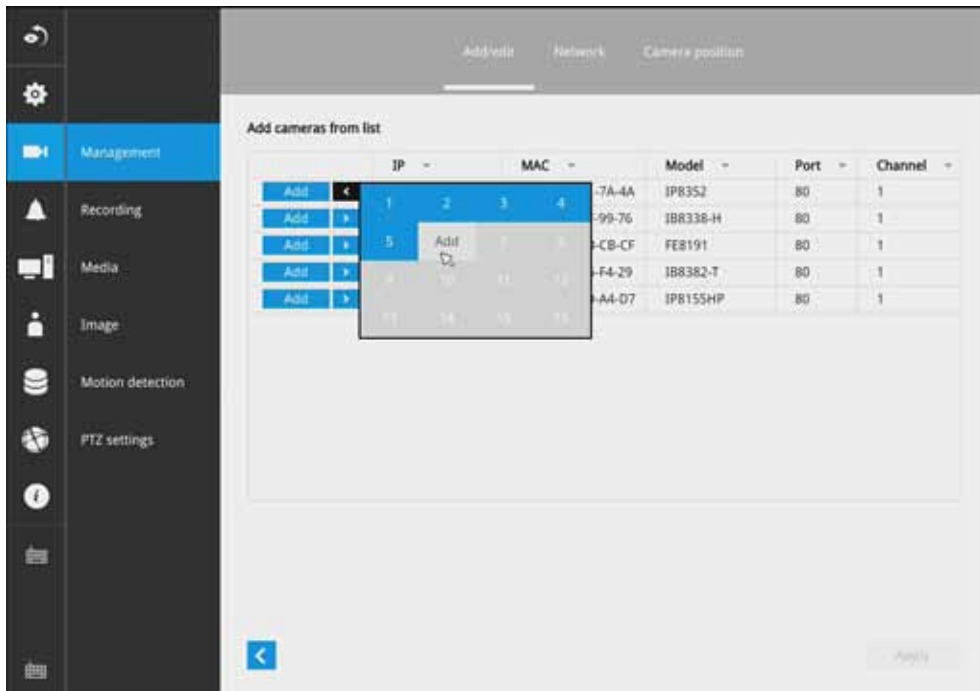

2. Click the **Add** button, the camera will be placed at an unoccupied position. You may also expand the menu on the side of the Add button to select a position number.
3. When a camera is added, it should appear on the graphical placement below.
4. Click the Apply button after you added cameras.
5. You may click the page back button  to return to the previous window.

To disband cameras:

1. Click on the Remove  button. A list of cameras will appear.

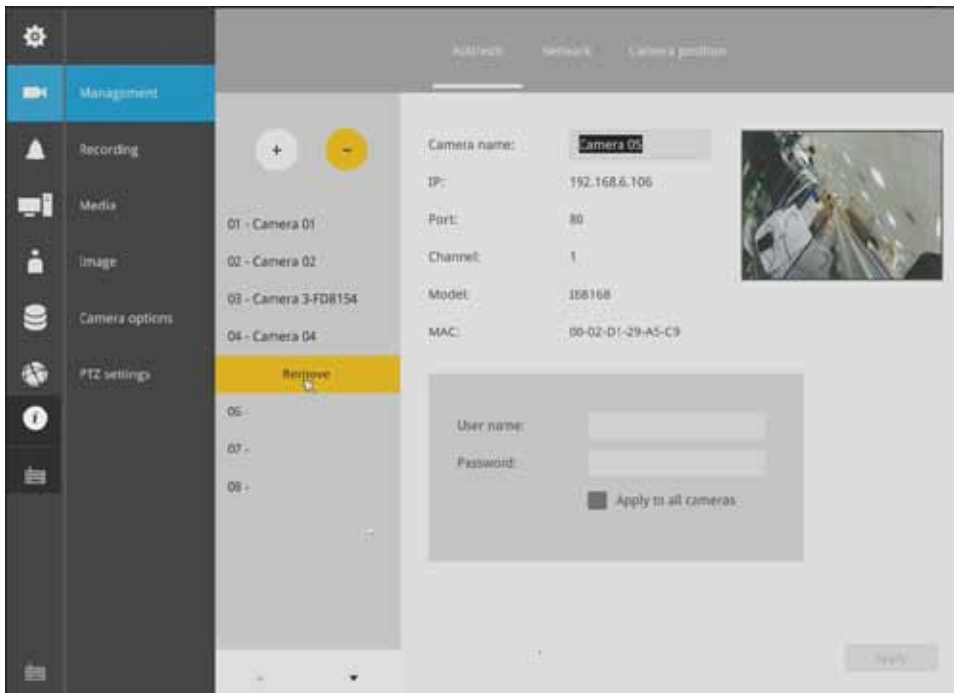

2. The **Remove** button will turn yellow . Mouse over to the camera you want to remove, and its entry will display the **Remove** message.
3. Click on the Remove message. The camera should then disappear from the camera list. The recording from that camera will also be discontinued.

## Network

On the Network tabbed window, you can configure the network type, IP address, and the connection ports for video streaming.

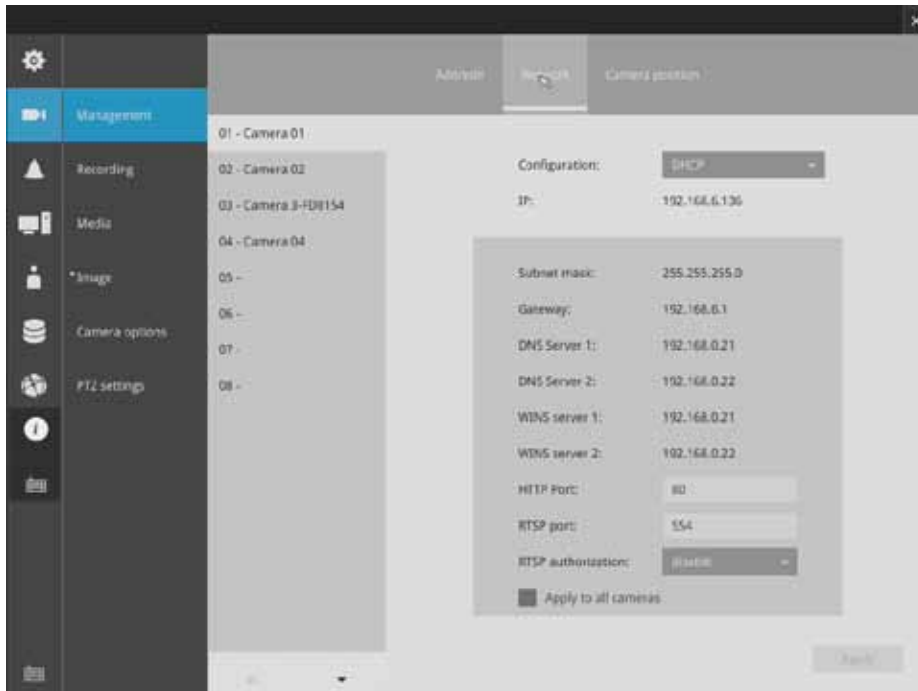

You can select DHCP as the method for cameras to acquire IP addresses, or you can manually configure static IPs for a single or all cameras. Using static IPs is recommended. Although the NVR can remember the MAC addresses of cameras, if IPs are changed under the DHCP configuration, your NVR may still fail to connect the cameras. Please consult your network administrator for details about network settings.

It is usually not necessary to change port numbers for the HTTP and RTSP ports unless there is a conflict in your network environment.

## Camera position

To change a camera's position on the Liveview layout, click and drag a camera to an unpopulated position. Note that you cannot swap the positions of two cameras by dragging a camera onto a position already populated by the other. Also, the camera index number on the management list is not affected by the change of positions.

Click the **Apply** button for the configuration change to take effect. The position screen displays the current layout on the Liveview screen.

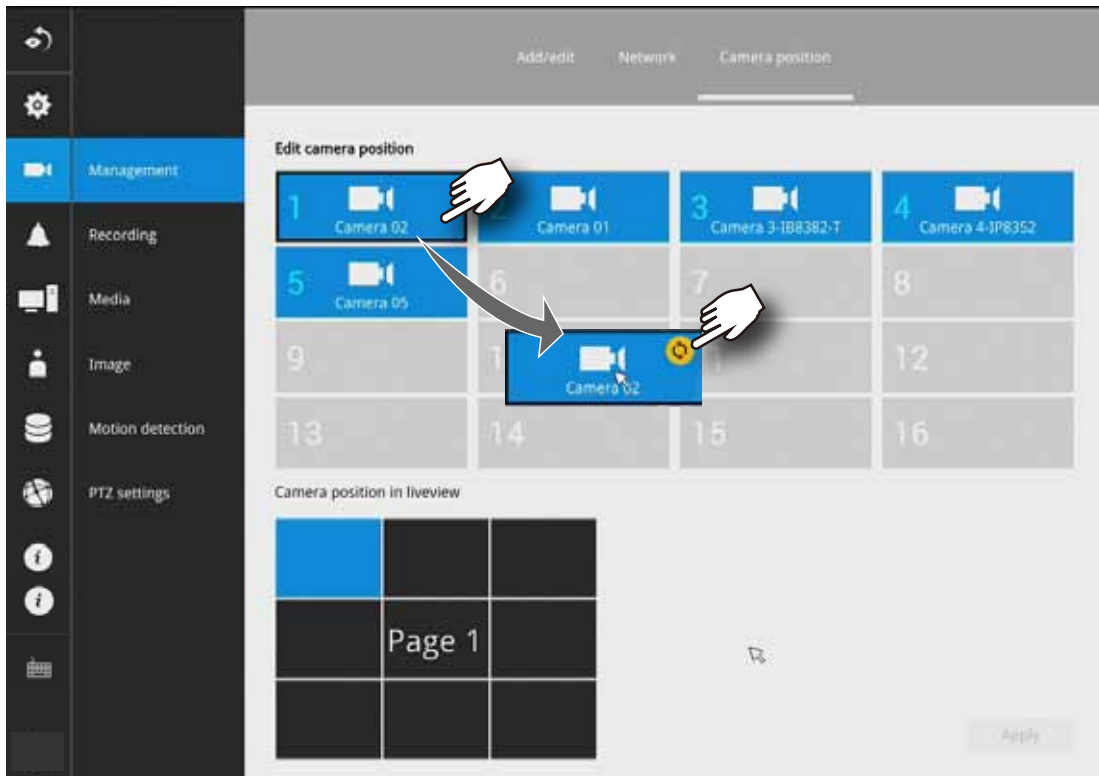



### 3-5-3. Settings - Camera - Recording

#### Recording options

On the camera Recording page, you can configure the following:

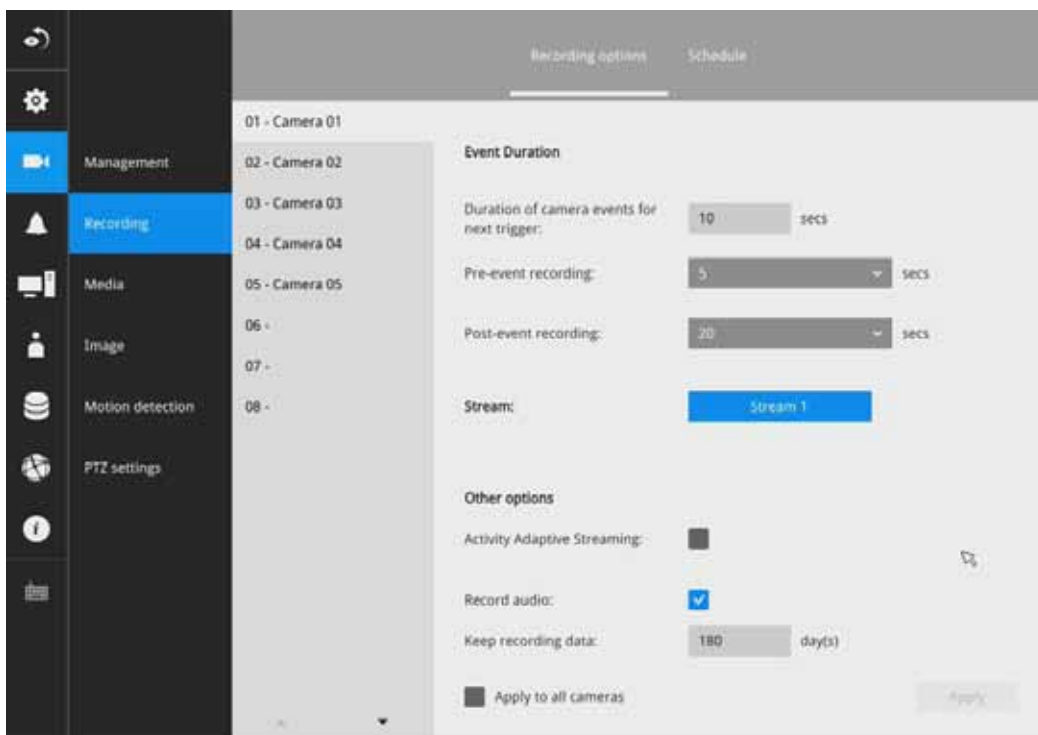

1. Configure the duration of camera events, for the concern that camera can be too frequently triggered.
2. Enter the Pre- and Post-event recording time. The triggering events can be DI, DO, Motion detection, PIR, or Tampering detection.
3. The default recording stream is Stream 1, and the system automatically adjusts the frame rate, resolution, etc. for optimum performance. However, you can still change the streaming characteristics. Note that you can not assign the recording task to other video stream.
4. Enable the Activity Adaptive Streaming feature. This feature records the I-frames only when there are no activities detected. When activities or alarm are triggered, the camera raises the recording stream to the full frame rate. This feature can save tremendous amount of bandwidth.
5. Enable or disable audio recording. Note that audio transmission through HDMI cable is currently not available.
6. Change the life expectancy of the recording data.
7. You can apply a typical configuration to all cameras using the Apply to all cameras checkbox.



You can refer to the User Manuals that come with your network cameras for more discussions of these configurable options.

## Recording Schedule

By default, all video feeds from cameras are recorded at all time. You can modify the recording task using the schedule tool:

1. Click to select a recording condition's checkbox - 1. Continuous recording , Event recording , and 3. Clear  (no recording).
2. Click and drag on the cells on the time table. For example, to stop the recording during a period of time, select the the Clear checkbox and move the cursor across the time table. The minimum unit on the table is half an hour.

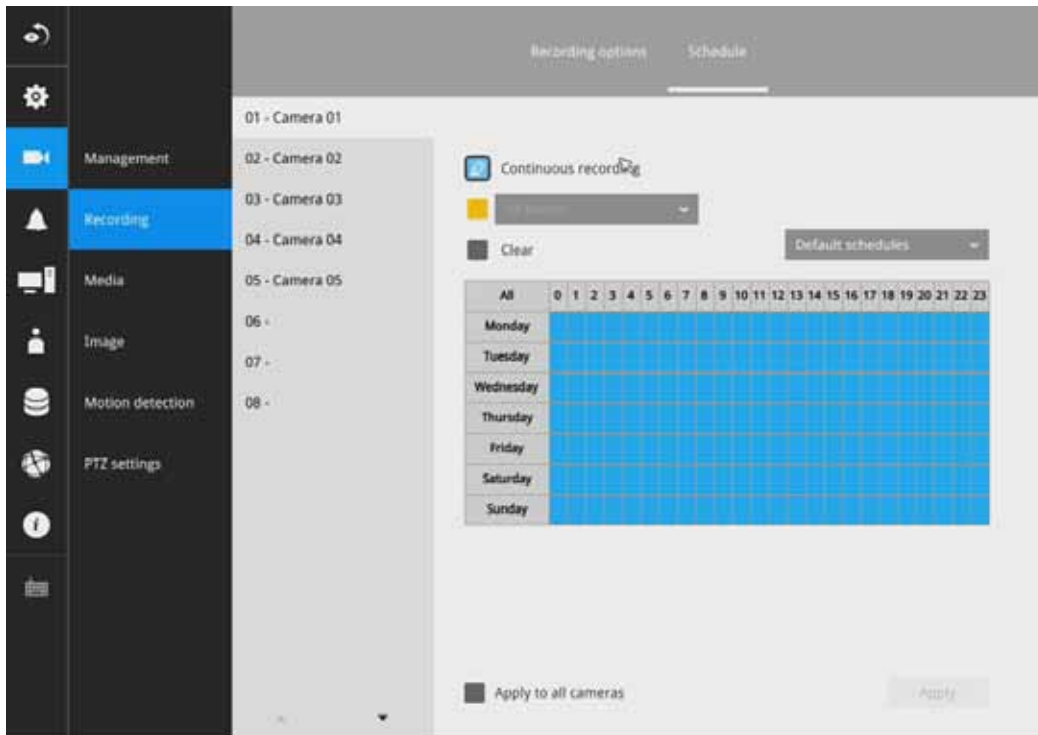

3. You may also use the scheduler tool on the right to facilitate the process. You can select a condition checkbox, and then select the All day, Work hour, Off duty, Working day, Weekend options to apply a time selection.
4. Repeat the process on individual cameras or select the **Apply to all** checkbox if the schedule can apply to all cameras.
5. When done with the configuration, click on the Apply button.

Note that Event-triggered recording and continuous recording can not be take place at the same time.

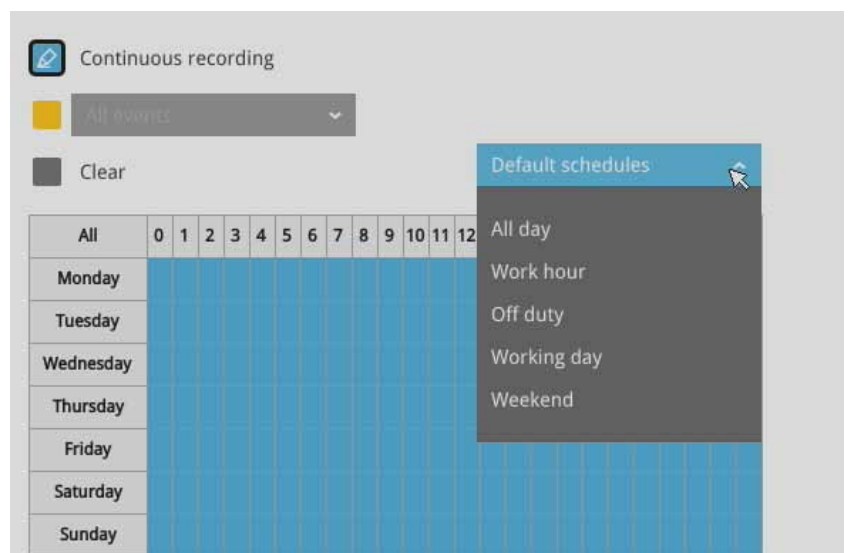

### 3-5-4. Settings - Camera - Media

#### Stream management

The stream here refers to the recording stream, namely, Stream 1. You can use these preset conditions to configure the resolution, image quality, frame rate, and the bandwidth consumption of the recording stream on this window.

Recommended setting	Configuration
Default	Medium resolution; full frame rate
High Quality	Guaranteed video quality set as Good; full frame rate
Economical	Medium to low resolution; frame rate at 5fps
High quality w/ economical	High resolution, Good image quality; frame rate at 5fps

With each recommended configuration applied, the estimated bandwidth consumption value is immediately calculated and displayed at the lower screen.

Click the **Apply** button for the configuration change to take effect.

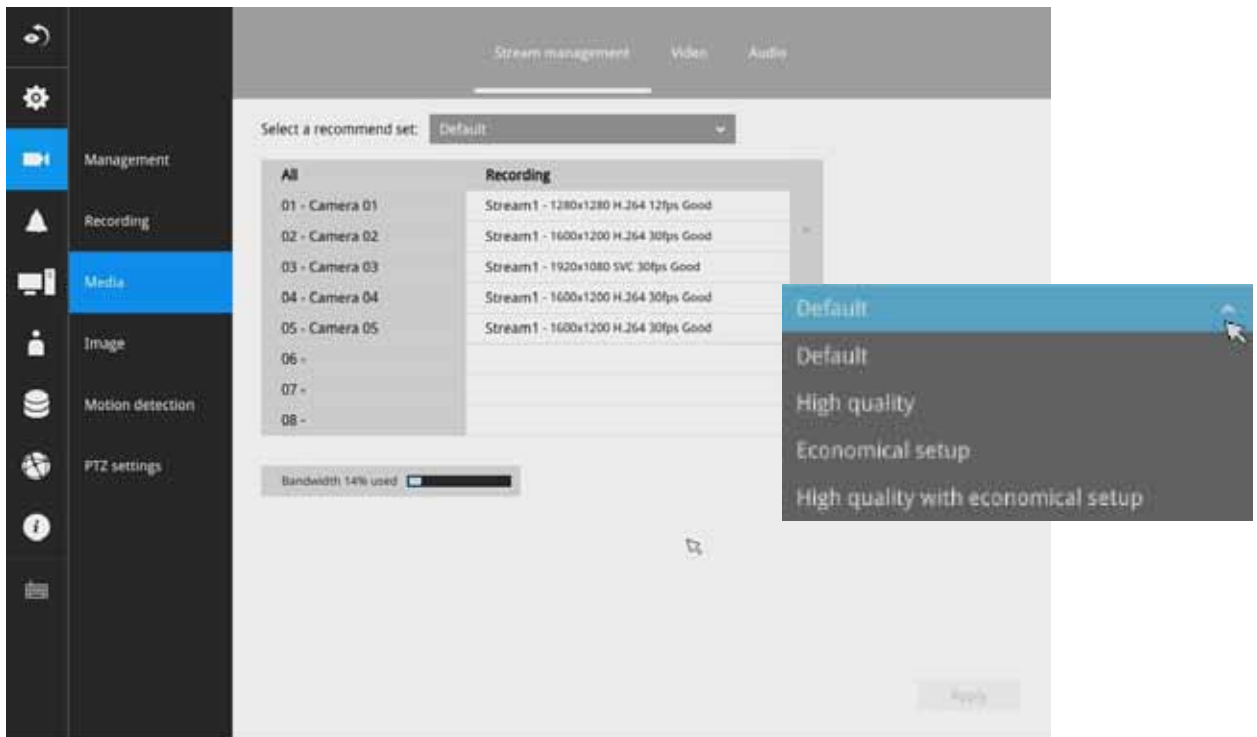

## Video

The Video window allows you to configure all video streams (the no. of stream available can be different for different models). You can configure the following:

1. Codec: video compression codec in H.264, MPEG-4, or MJPEG. Note that MPEG-4 is not supported for Liveview.
2. Frame size: video resolution. Note that due to the limited CPU resources, you may not be able to change the resolution to a very high value, e.g., 5MP in the 1920x1920 resolution.
3. Maximum frame rate: the highest frame rate.
4. Intra frame period: How often an I-frame will be inserted into the video stream.
5. Video quality: You may either select Constant bit rate or Fixed Quality as the defining rules for video transmission:

Constant bit rate	Places a packet size threshold on video frames; This guarantees the frame rate per second performance, yet image quality can be compromised if bandwidth is not sufficient in your network environment.
Fixed Quality	Guaranteed video quality, and to ensure image quality, some frames may be dropped when bandwidth is not sufficient.

When done with the configuration, click the **Apply** button.

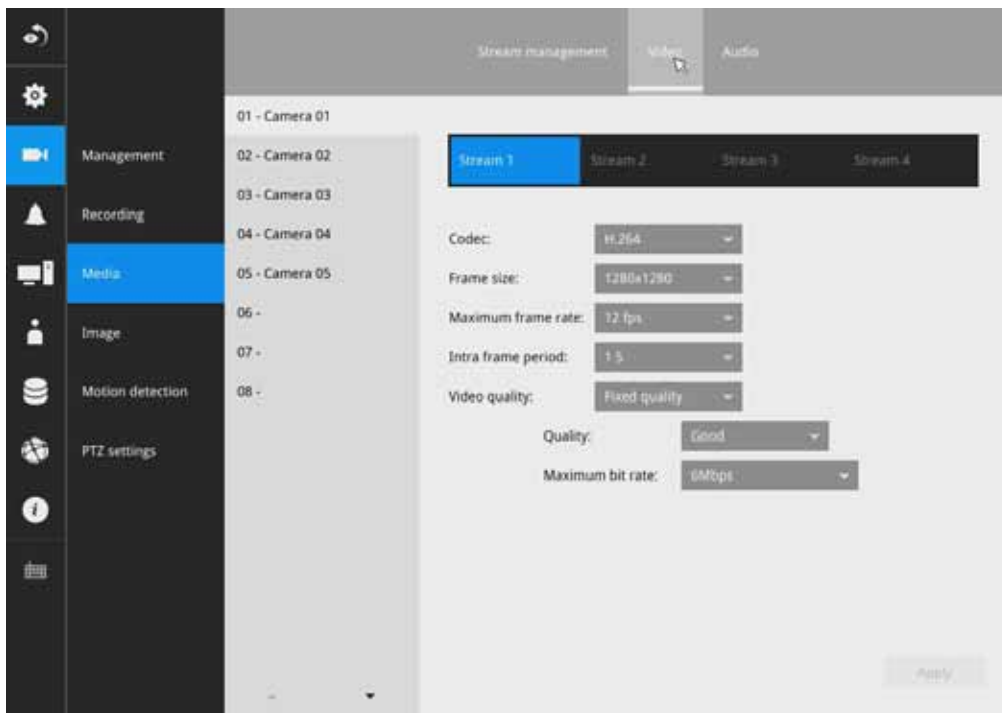

## Audio

The Audio window allows you to configure all audio codec, sampling rate, and Microphone input gains. Depending on design of the camera models, some codecs may not be available. Also, there are cameras that come without embedded microphones.

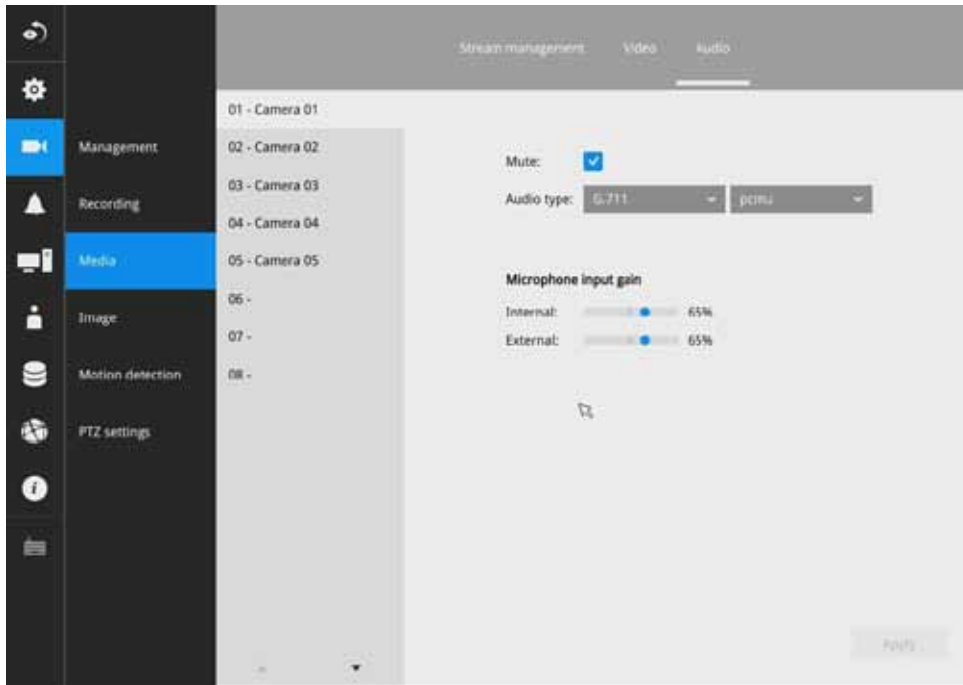

### 3-5-5. Settings - Camera - Image

#### Display

The Display window allows users to tune the image display options:

1. Video name: the video name is displayed on the title bar that is displayed on each view cell. The screen shot below shows a name as "Speed dome."

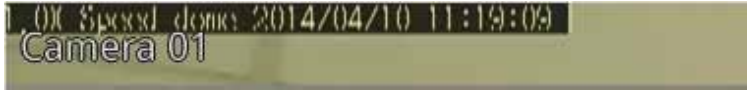

2. Video name and timestamp: Default is enabled. If enabled, the video name and time is displayed on the view cell.
3. Power line frequency: Depending on power line frequency of your country, select a matching option, NTSC 60Hz or PAL 50Hz, to avoid image flickering due to unmatched electricity.
4. Video orientation: select these options if the image from camera needs to be vertically or horizontally flipped.
5. Click Restore to poll for the original settings or click the Apply button to finish the process.

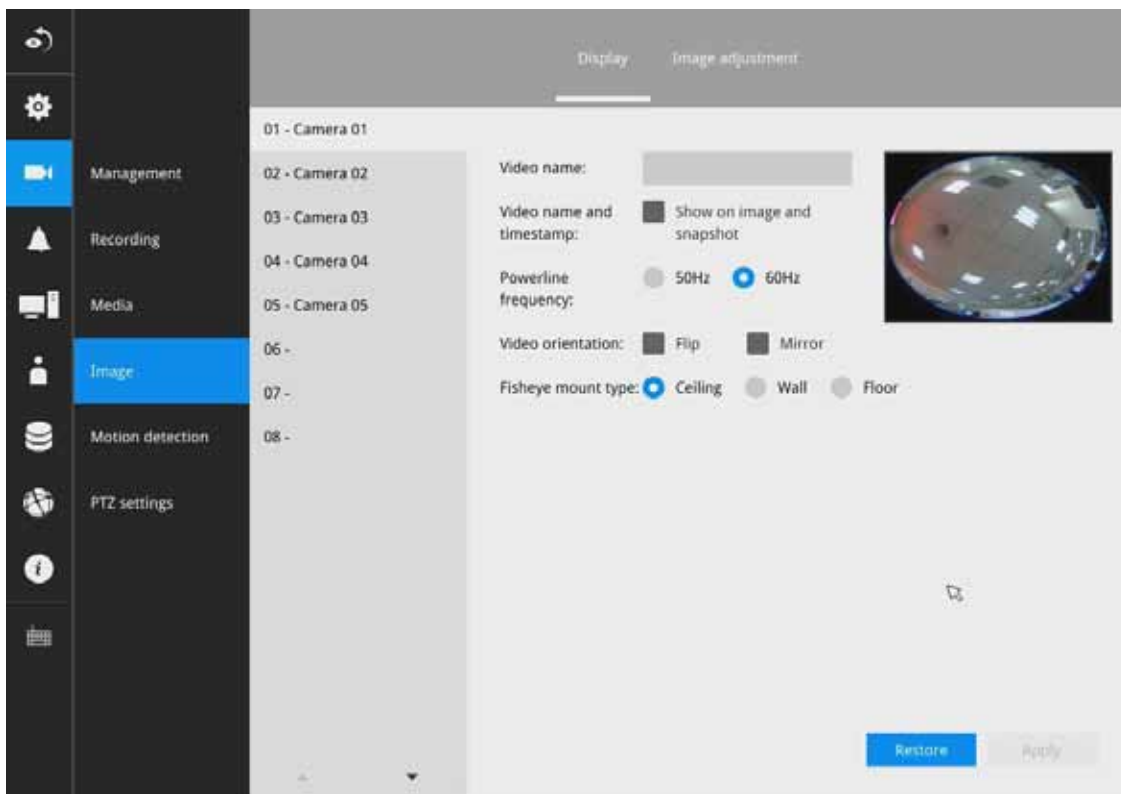

## Image adjustment

The Image adjustment window allows users to tune the basics about image display options:

1. Color: Select to display image as color or black and white.
2. Brightness.
3. Saturation.
4. Contrast.
5. Sharpness.
6. High TV line, Gamma curve, low light compensation, etc. The rest of the options depend on the lens and image sensor type of each individual camera. Therefore, the options here can vary. For unique options coming with each individual camera, please refer to their User Manuals for more information.

Click Restore to poll for the original settings or click the **Apply** button to finish the process. For features common among cameras, you may select the **Apply to all cameras** checkbox.

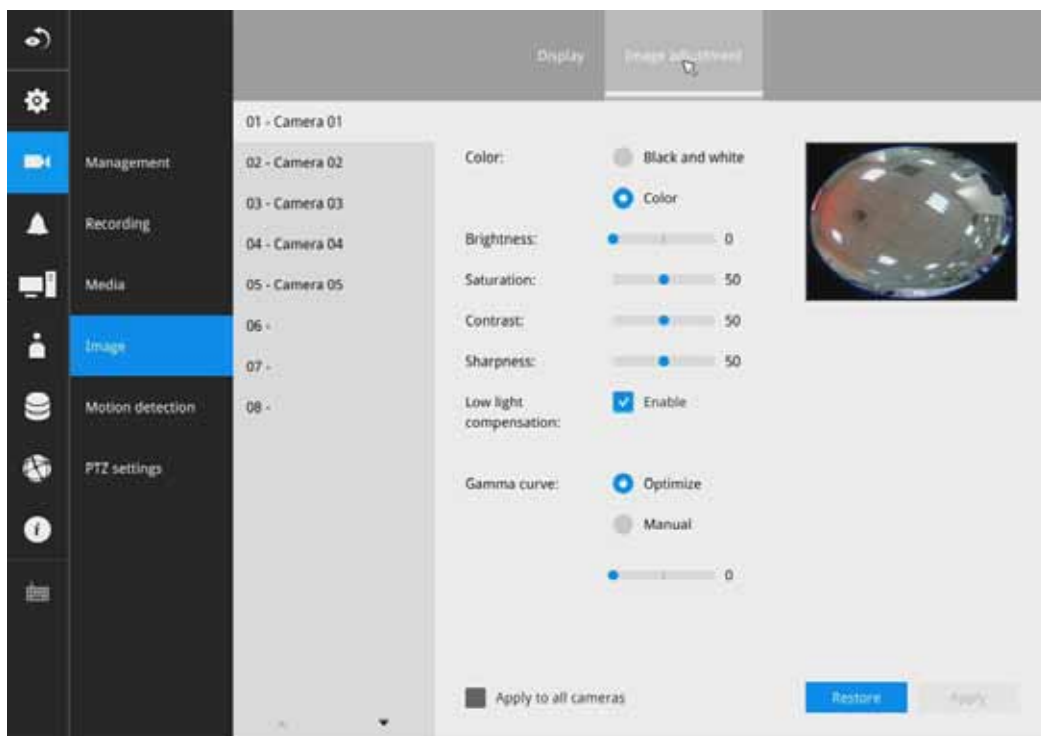

### 3-5-6. Settings - Camera - Motion Detection

#### Motion Detection

To set up a detection window:

1. Select a camera by a single click.
2. Use the PTZ panel to move to a field of view where you want to place a detection window.
3. Click and drag to draw a rectangular detection window.
4. Pull the detection area level up to a preferred position. An object must be larger than the detection area to trigger an alarm.
5. Select a Sensitivity level using the slide bar.
6. Click the **Apply** button for the configuration to take effect.

The sample screen shows a connection with a speed dome camera.

If you already configured Preset positions, expand its menu and click on the presets to move to a position.

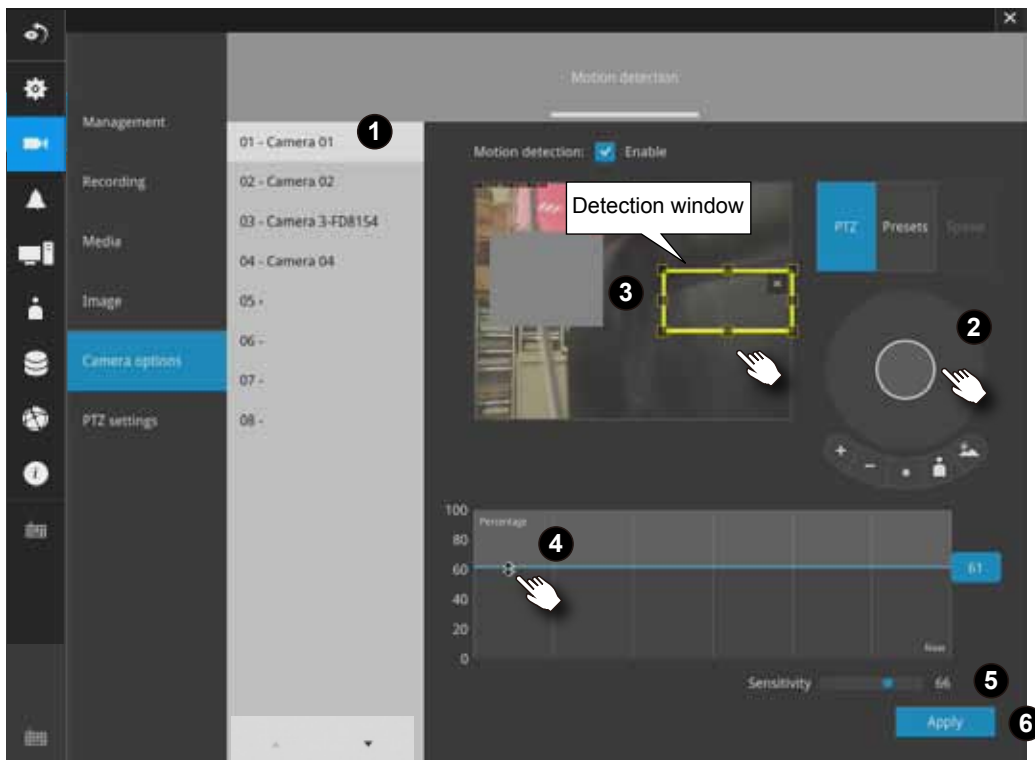



### 3-5-7. Settings - Camera - PTZ settings

To configure PTZ preset positions:

1. Select a PTZ camera by a single click.
2. Use the PTZ panel to move to a field of view where you want to designate as a preset position.
3. Click the add button, and enter a name for the position. Press Enter to proceed.  
Repeat the configuration to create more positions.
4. Click the **Apply** button for the configuration to take effect.

Note that the PTZ panel can vary with different PTZ cameras.

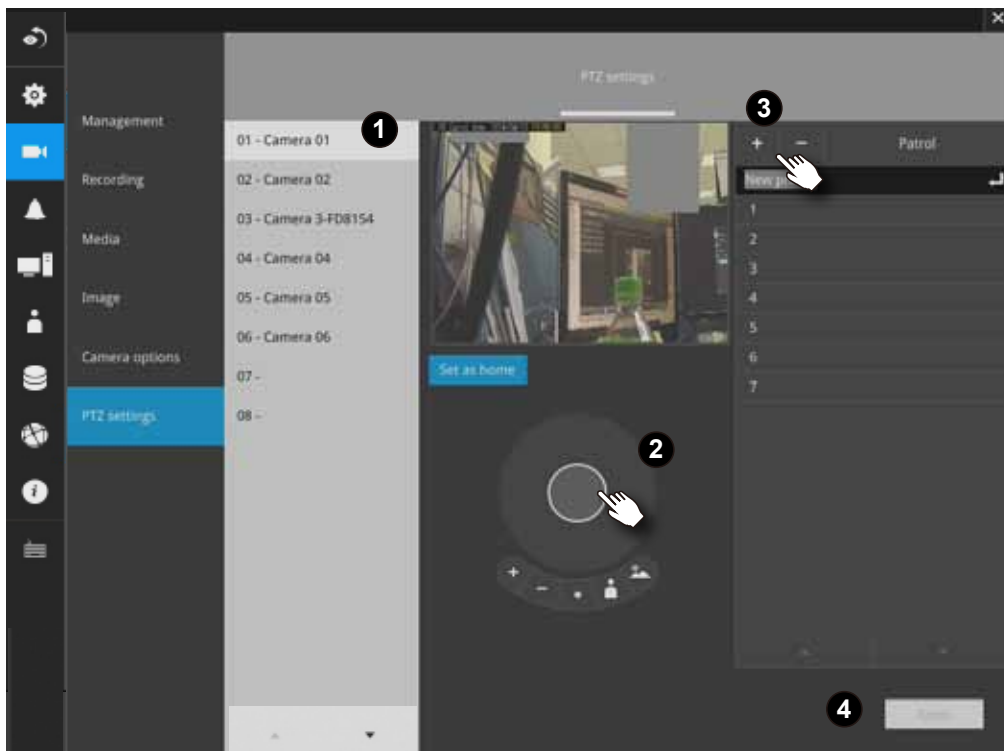

To configure a patrol:

1. Click to enter the Patrol menu. Select a preset position if you want to change its position on the patrolling order.
2. Click the up and down buttons to change the position on the order, or click the remove button to disband a position from the order. You can also change the interval to stay before moving from one position to the next position.
3. You may then click on the Preview patrol button to see if it runs as expected.
4. Click the **Apply** button for the configuration to take effect.
5. Click on the Back to preset list button to return to the preset window.

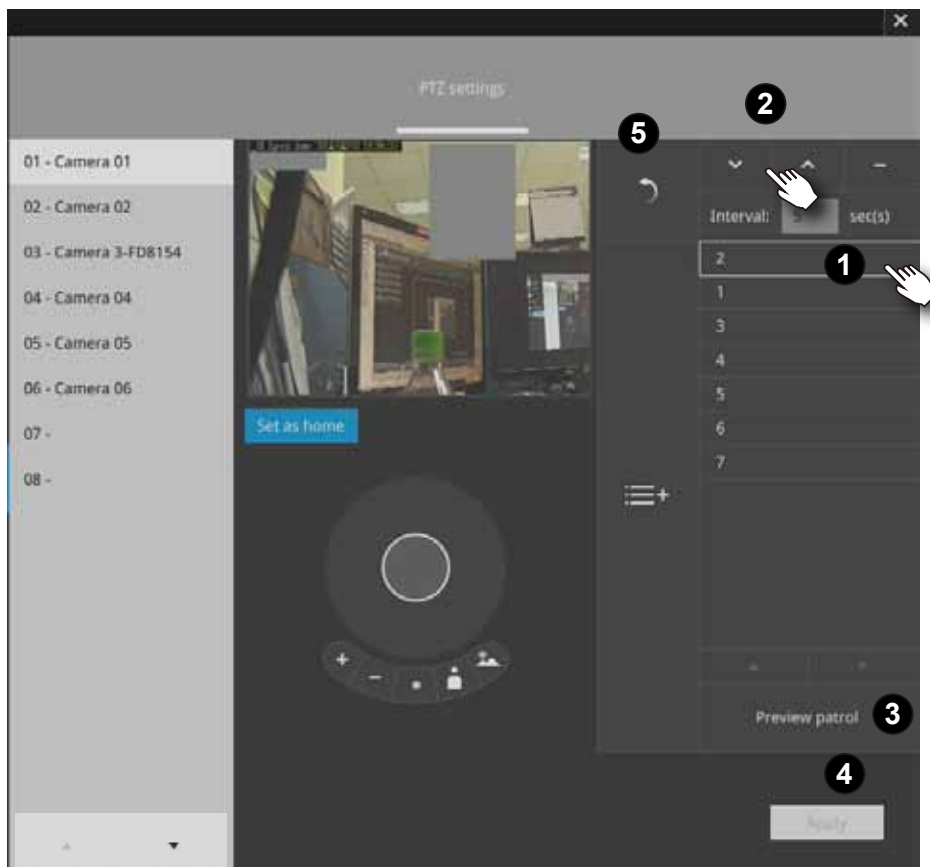

Fisheye camera has its unique options such as the mount types.

Please refer to page 117 or the camera's User Manual for fisheye display mode options.

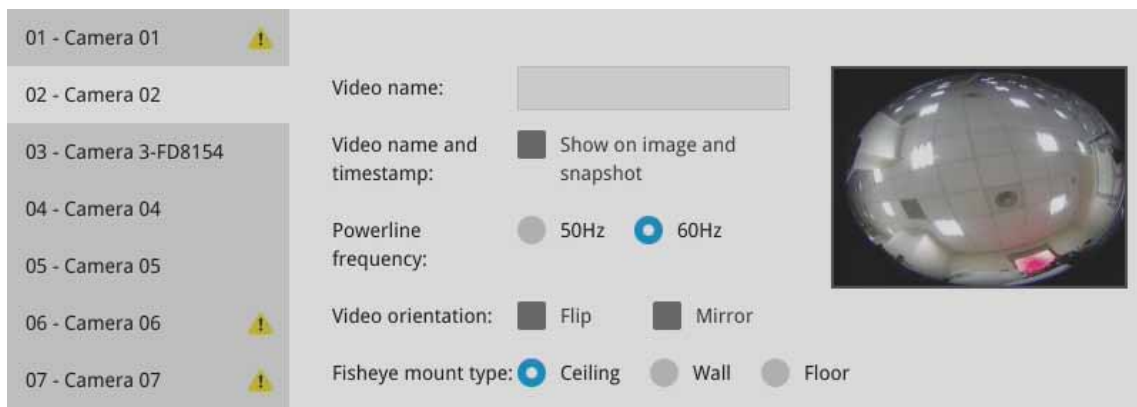

### 3-5-8. Settings - Alarm - Alarm

The events reported from individual cameras' digital inputs, digital outputs, and motion detection can be accommodated in the NVR system's alarm settings. These events will then be reported or trigger corresponding actions as follows:

1. Reporting events via Email or system buzzer.
2. Triggering video snapshot and text message by the occurrences of events to an FTP site.
3. Triggering the camera(s) for its lens to move to a preset position.
4. Triggering the cameras' digital output.

You can create up to 10 instances of alarm.

Hardware connections to DIs or DOs, e.g., window sensors, should be made separately. The motion detection configuration can be made in the Camera configuration window.

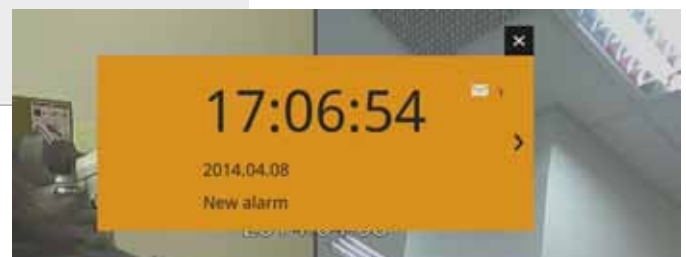
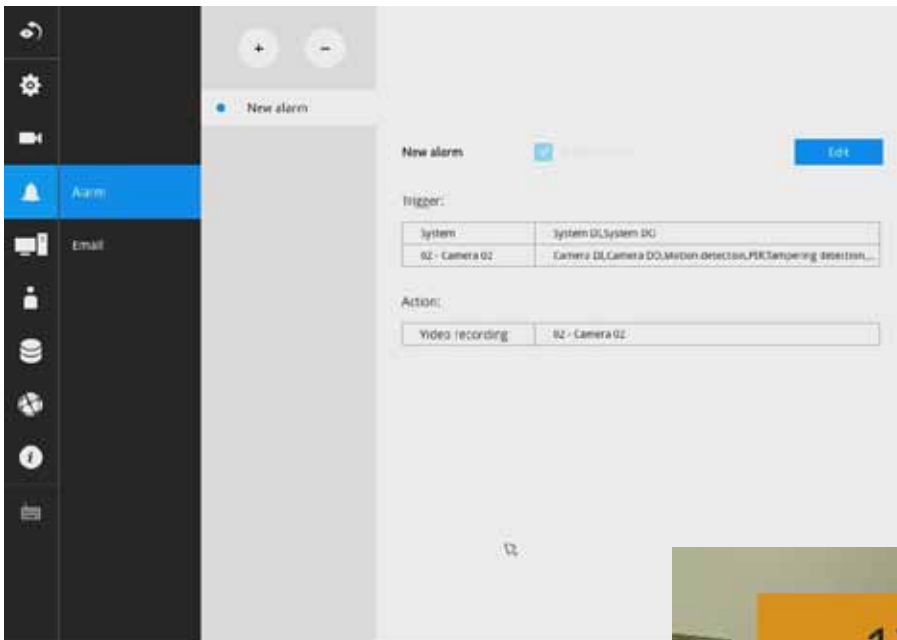

When an alarm is triggered, a message prompt will appear on the Liveview or any configuration window.

Below is a glimpse of alarm sources and alarm actions:

Sources		Actions	
DI	▶	Video recording	▶ video footage
DO		Email	▶ snapshots
Motion detection		Buzzer	
Network failure		FTP	▶ snapshots
Disk full		Camera preset points	▶ Pan-Tilt-Zoom
Disk failure			
PIR		Camera DO	
Tampering			

To create an alarm,

1. Click on the **Add** button .

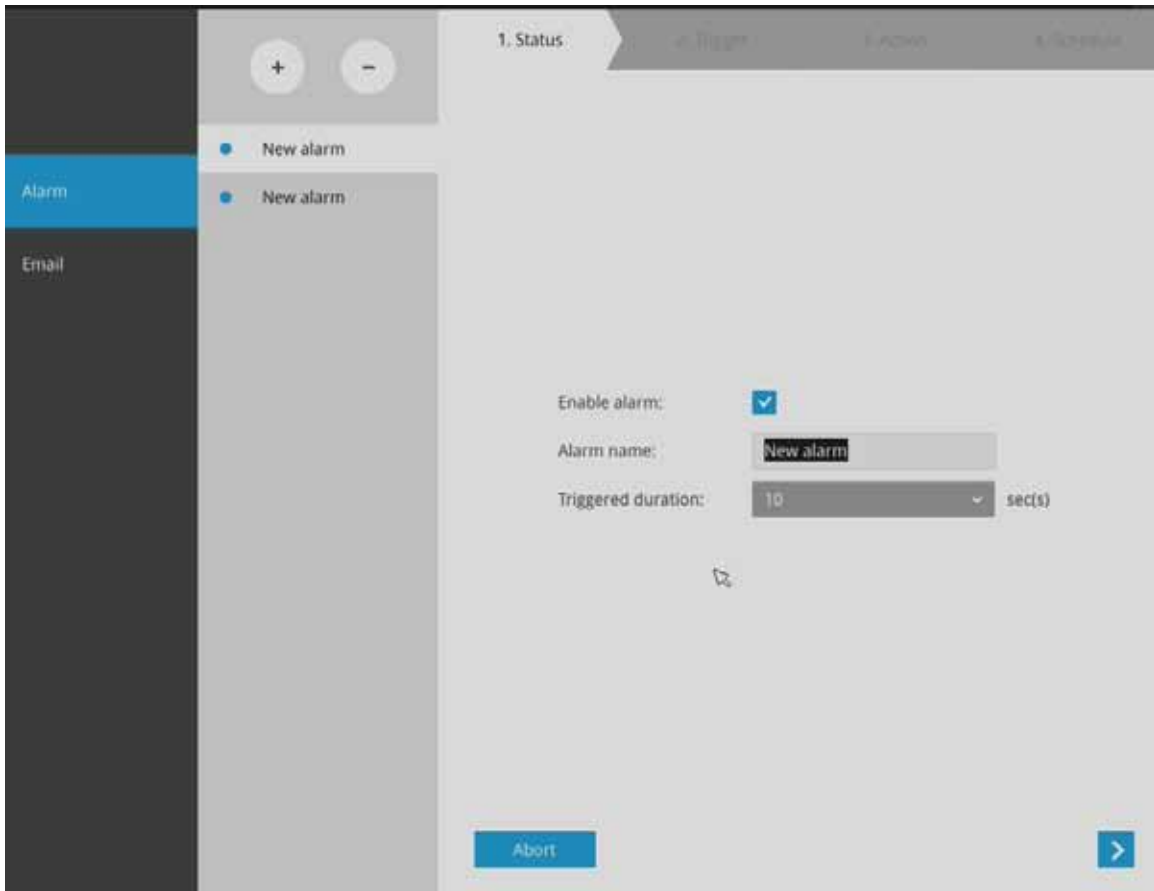

You can manually enter a name for the current setting. You can enter up to 16 numeric or alphabetic characters for the name, including symbols such as [0-9][a-z][A-Z][\_][ ]. You can also designate the interval between one alarm and the next triggered alarm to avoid the situation that the alarms can be too frequently triggered.

Click on the next button  to proceed.

Please note that on a fisheye camera's Motion window, you can click and move the corner marks of a window to change its shape. The Motion window does not have to be a square.

3. On the **Trigger** window, select system triggering conditions, or one or more cameras by selecting their checkboxes. The number of DI or DOs on each camera is automatically detected and displayed through individual checkboxes. The **Motion detection** function, if there are many detection windows configured on a camera, is all triggered by one checkbox.

Note that the triggering sources will be listed even if the camera is currently not connected.

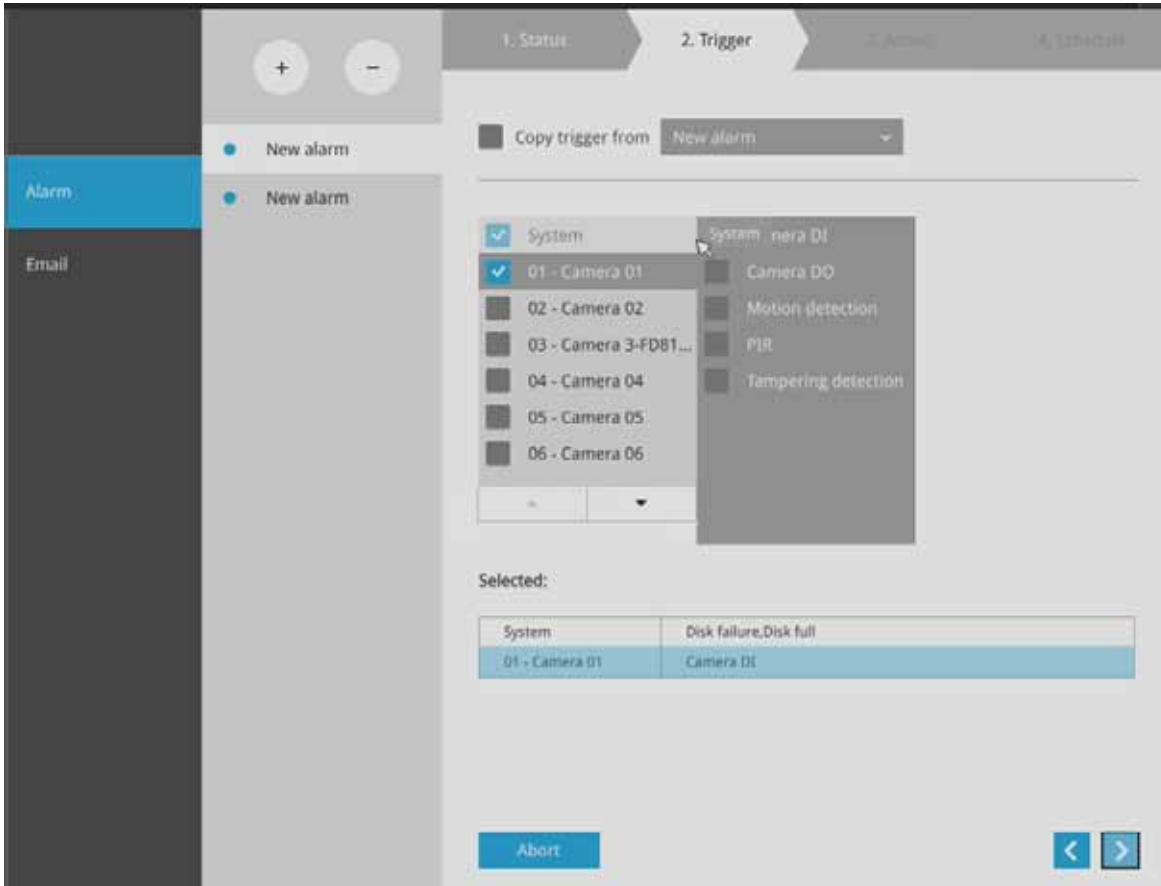

You may also select the "Copy trigger from" menu to borrow the setting you previously configured.

Click on the next button  to proceed.

4. On the **Action** window, you can select the Action type from a drop-down menu. The configuration details of each action type is discussion below.

4-1. **Recording** - When an event is triggered, the selected camera will record a video footage of the length defined by the pre-/post-event setting, to the NVR system.

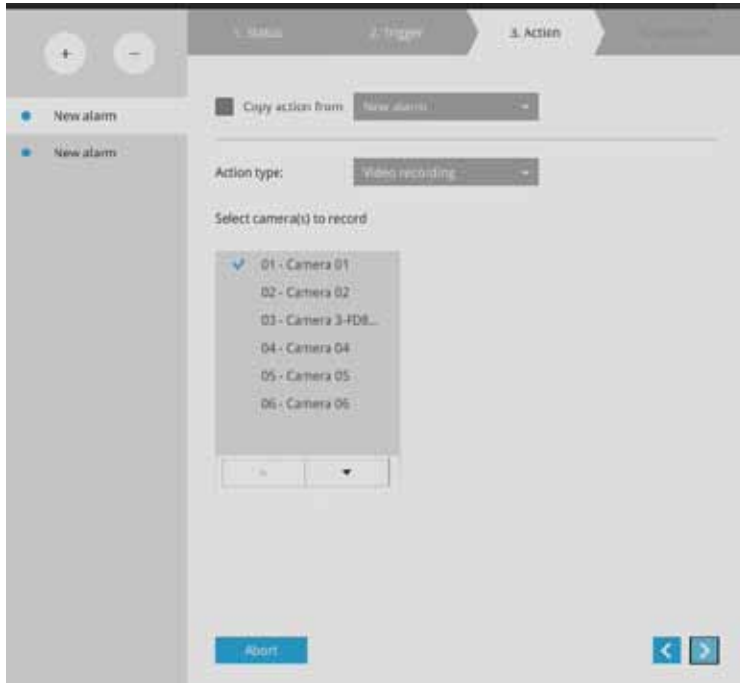

4-2. **Email** - The Email action sends an Email to the administrator along with a snapshot of the event.

To configure Email notification, enter valid Email addresses as the Sender and Recipient addresses, an Email subject, and the SMTP server address through which the Email will be delivered. If you need to log in to SMTP server to deliver an Email, enter the User name and password for access to that account.

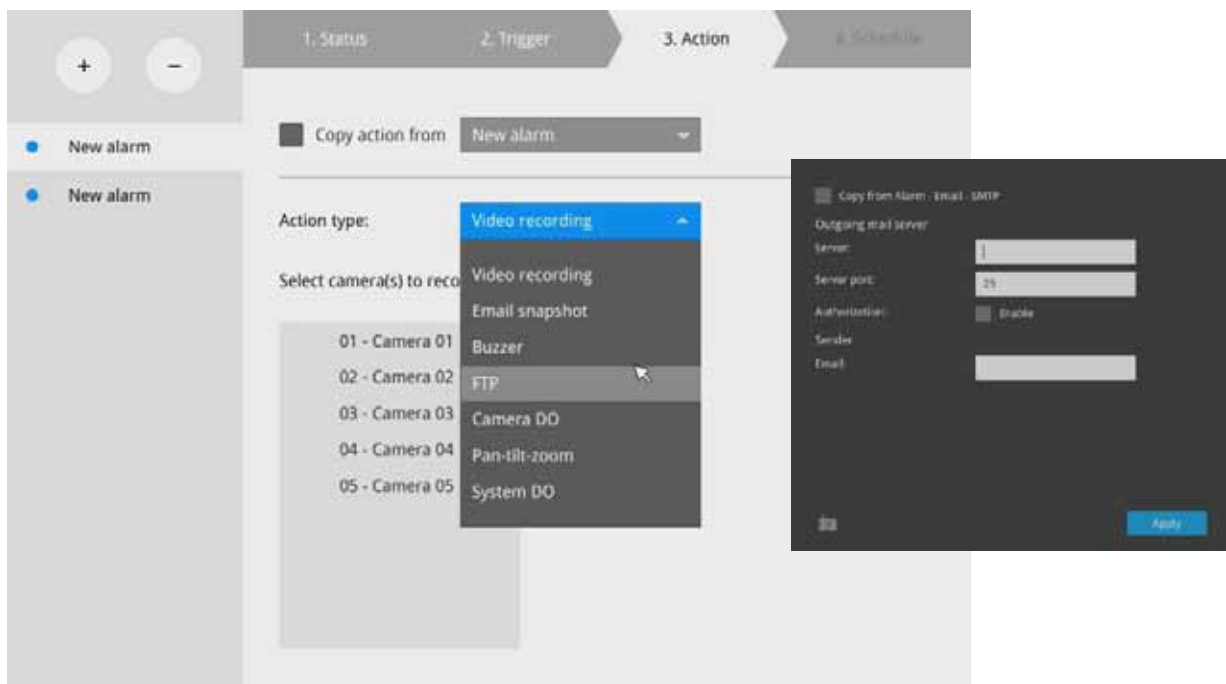

The Email subject and addresses can be composed of 254 characters in numeric or alphabetic characters including: [0-9][a-z][A-Z][\_ ][-].,],[@]. You can enter the addresses of multiple recipients. Use semicolons, (;), to separate the addresses of multiple recipients.

- 4-3. **Buzzer** - The buzzer is sounded on the occurrence of the event. The buzzer tones are categorized into: **Critical** (1 long, 1 sec interval) **Major** (1 long 2 shorts, 1 sec interval), **Normal** (3 shorts, 2 sec interval), **Minor** (2 shorts, 2 sec interval), and **Notify** (2 very shorts) depending on the importance of an event. Select a Buzzer modulation from the drop-down list. A long tone has a duration of 1 second, while a short tone 0.5 second. A very short tone lasts only for 0.1 second.

Select how many times the buzzer tones will be repeated on the occurrence of an event.

The screenshot displays a configuration window for the 'Buzzer' action. At the top, a progress bar indicates the current step is '3. Action'. Below this, a 'Copy action from' dropdown is set to 'New alarm'. The main configuration area includes three dropdown menus: 'Action type' is set to 'Buzzer', 'Buzzer severity' is set to 'Normal', and 'Repeat times' is set to '10'. A mouse cursor is visible over the 'Repeat times' dropdown.

If events of different importance are issued at the same time, e.g., one major and one minor event, system will ignore the minor event and sound the buzzer tone for the major event only. The buzzer can be sounded either by the Alarm actions or the system events. If Alarm actions and system service events occur at the time, Alarm actions have the higher priority.

If multiple Alarm actions occur, the currently-sounded events can be depleted by the new event.

There are conditions that the system will sound the buzzer, and the conditions are not configurable.

1. Disk failure - missing drives or SMART detected failures.
2. Disk full - the free space is too small for recording tasks.

4-4. **FTP** - Snapshots from specified cameras can be uploaded to an FTP site on the occurrence of an event. Enter the FTP site address in the dotted-decimal notation, e.g., 159.22.151.20. Enter the login name and password for the user account. You can enter a directory name you prefer on the FTP site. The server port default is 21, a different number between 1025 and 65535 can also be assigned.

The snapshot thus delivered has a size of 320x240 pixels.

If authentication is not applied, login will proceed using the [anonymous] account. The file names of the snapshot jpeg files will look like this:

[MAC]\_[DATE]\_[TIME]\_[CAMERA\_INDEX].jpg - If similar files already exist, an additional index number will be added to the end of file name.

The screenshot shows the configuration page for an FTP action. At the top, there are four tabs: '1. Status', '2. Trigger', '3. Action', and '4. Schedule'. The '3. Action' tab is selected. Below the tabs, there is a 'Copy action from' dropdown menu set to 'New alarm'. Underneath, the 'Action type:' dropdown is set to 'FTP'. The interface is split into two columns. The left column, titled 'Select camera(s) to snapshot', contains a list of cameras: '01 - Camera 01' (checked with a blue checkmark), '02 - Camera 02', '03 - Camera 3-FD8...', '04 - Camera 04', '05 - Camera 05', and '06 - Camera 06'. The right column, titled 'FTP setup', contains several input fields: 'FTP Server:' (empty), 'Port:' (set to '21'), 'Authorization:' (checked 'Enable'), and 'Upload folder: /' (empty). At the bottom right of the 'FTP setup' section, there is a blue button labeled 'Upload test file'.



4-5. **Camera DO** - A triggered alarm triggers a camera's DO, e.g., an alarm siren.

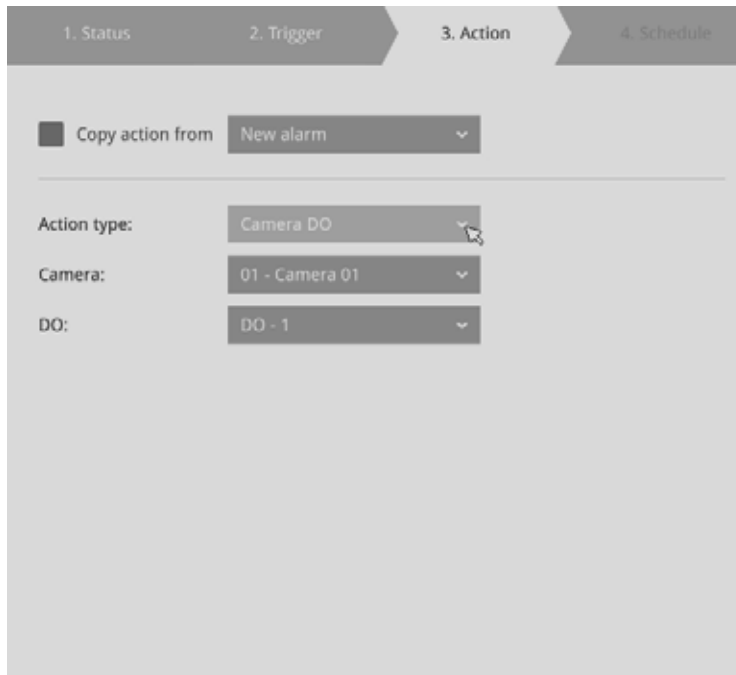

4-6. **Camera pan-tilt-zoom** - A PTZ capable camera can move its lens to the preset position in case of a triggered alarm. For example, a triggered sensor may indicate an area of interest has been intruded, and a camera's field of view should be moved to cover that area. The precondition is that you properly set up preset positions on your PTZ cameras using a local or a web console.

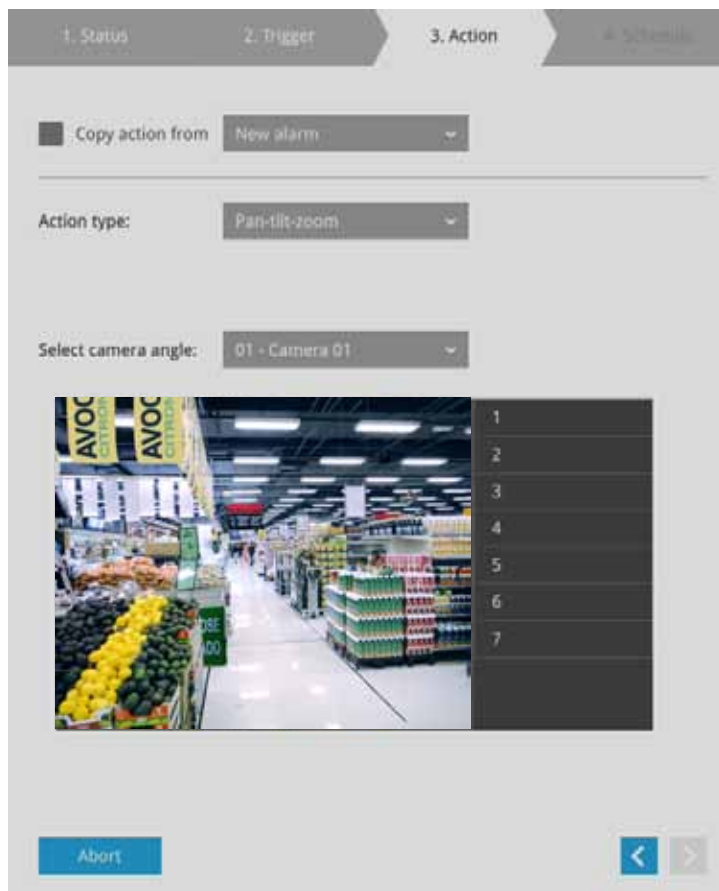

4-7. **System DO** - A triggered alarm can be used to toggle the NVR's digital output, e.g., to sound an alarm siren.

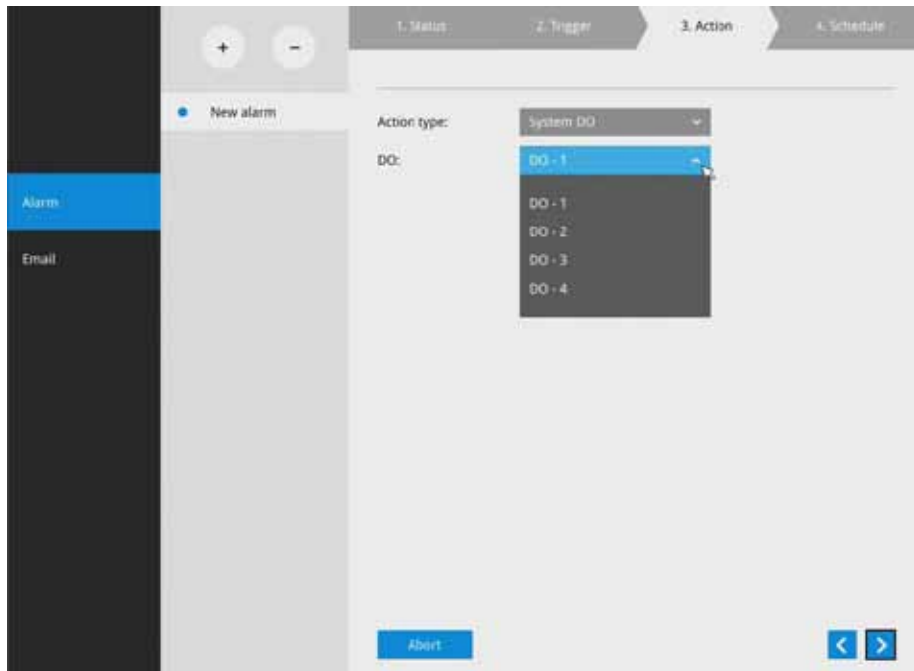

- On the **Schedule** page, you can select to activate or de-activate alarm triggers throughout a specific timeline. For example, in some situations you can disable the alarm triggers during the office hours, and choose to enable the triggers only during the off-office hours.

1. Status 2. Trigger 3. Action 4. Schedule

Copy schedule from New alarm

Apply Alarm

Clear Default schedules

All	0	1	2	3	4	5	6	7	8	9	10	11	12	13	14	15	16	17	18	19	20	21	22	23
Monday																								
Tuesday																								
Wednesday																								
Thursday																								
Friday																								
Saturday																								
Sunday																								

Abort < Finish

- Click **Finish** to end the configuration.
- Repeat the process above to create more alarms according to the needs in your surveillance deployment.

### 3-5-9. Settings - Alarm - Email

This window provides an interface where you can configure the connection to a Mail server. Via the Mail server, the system can deliver Emails containing system alarm messages to multiple receivers. A reachable Mail server and Email accounts must be provided before you can apply the settings.

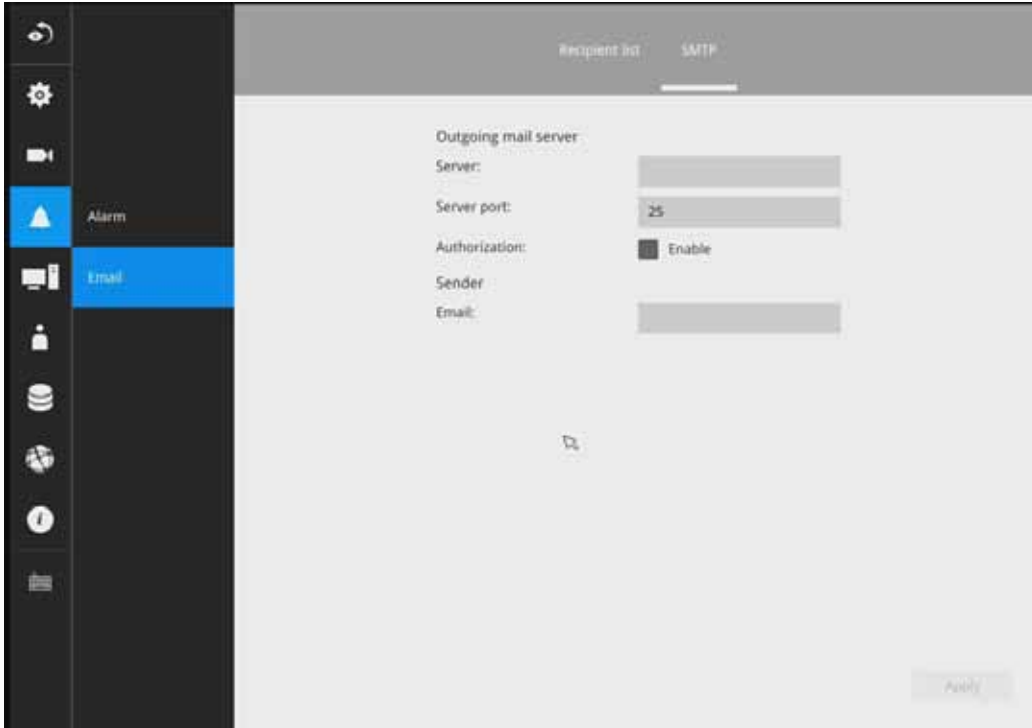

The configuration options are identical to those found in the Email configuration in Settings - Alarm window.

### 3-5-10. Settings - System - Information

On this window, you can configure the following:

1. Change the system name.
2. Select the UI text language.
3. Configure system time, time zone, and if you are connected to a DNS server where Auto Daylight Saving time can be applied, you can acquire the associated setting from a server within your network.
4. Click the **Apply** button for the configuration to take effect.

Note that if **NTP** time server configuration (Auto) is preferred, the system will automatically configure all cameras to be listening to the system, and therefore to the same time server.

The screenshot shows the 'System - Information' settings page. On the left is a dark sidebar with icons and labels for 'Information', 'Maintenance', 'Display', 'UPS', 'Log', and 'EZConnect service'. The 'Information' menu item is highlighted in blue. The main content area is light gray and contains the following settings:

- Name and language:**
  - System name: ND9541
  - Language: English (dropdown)
- Time:**
  - System time: Manual setup (dropdown)
  - Date: September 22, 2015 (dropdown)
  - Time: 14 : 35 : 42 (dropdown)
  - Buttons: 'Now' and 'Auto setup Daylight Saving Time' (highlighted in blue)
- Time zone:**
  - Asia/Taipei (CST, GM... (dropdown)
- Set up Network - IP - DNS server to update Daylight Saving Time:**
  - Manual setup:**
    - 1 Download update file from <https://www.iana.org/time-zones>
    - 2 Save file to USB device
    - 3 Import file to update (button highlighted in blue)

An 'Apply' button is located at the bottom right of the settings area.



#### IMPORTANT:

Changing system time can produce disruptions to the existing recordings. Turning the current system time back to a time when video recording was taking place can generate duplicate files. And those files may not be playable.

### 3-5-11. Settings - System - Maintenance

If the need arises for updating system firmware, acquire the update from VIVOTEK's technical support or download site. Locate the firmware binaries, and click the Import button. The upgrade should take several minutes to complete. Note that during the upgrade, the recording task will be interrupted.

On this window, you can perform 4 maintenance tasks:

1. **Update firmware** - Download firmware and save it to a USB drive in the FAT format, attach the USB device to the NVR for firmware upgrade.
2. **Update device pack** - A device pack allows you to import associated configurations and parameters for new camera models so that these cameras can be integrated into your NVR configuration. The information in the device pack is related to some tunable parameters.
3. **Backup** - You can backup your system configuration using the Backup function. Click Backup, a message window will prompt. Click Save to preserve your system configurations.

Select a location for your backup file, then click Save to complete the process. If you back up to a USB thumb drive, that thumb drive must be formatted using the FAT format.

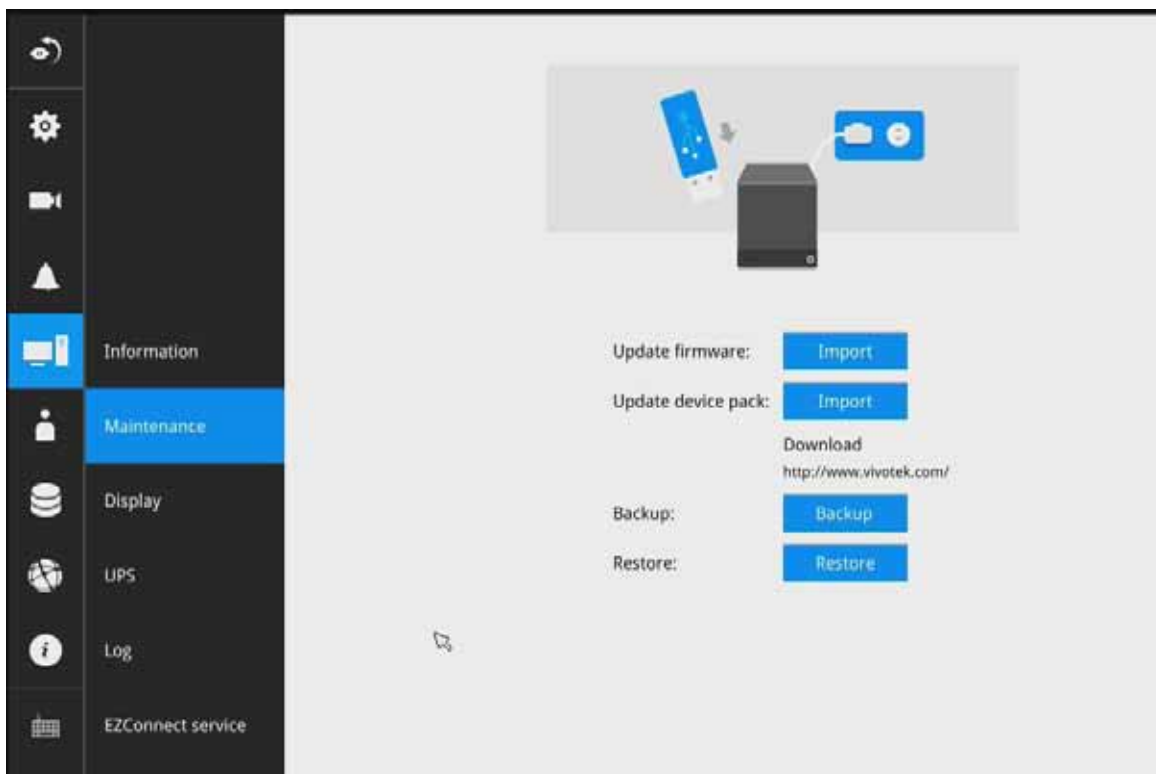

Note that the backup action does not involve the following:

1. Recorded videos and database,
  2. Alarm records, bookmarks, and bookmarked footages.
4. **Restore** - If you have a previously-saved profile, you can restore your previous configuration. Click the Restore button.

A file location window will prompt. Locate the backup file, and click Open. The Restore process will take several minutes to complete, and system operation will be interrupted during the process.

### 3-5-12. Settings - System - Display

On this page, you can configure the system to consecutively display (rotate) cameras' view cells on the Liveview window. For example, if you have 8 cameras in 2 2x2 layouts, the rotation can let you see the live views of all cameras by every few seconds.

You can also enable or disable the Alarm notification.

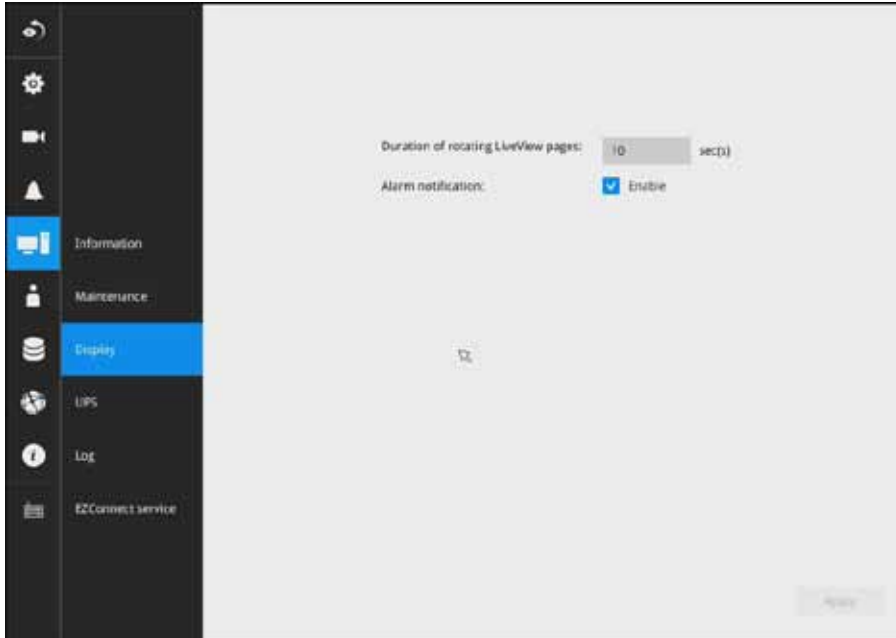

To enable the rotate function, click on the rotate button on the layout panel.

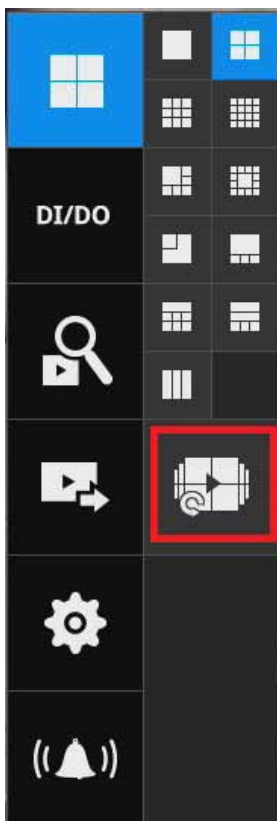

### 3-5-13. Settings - System - UPS

On this page, you can configure the system to gracefully shut down when UPS battery is lower than a certain level. You may also let it shut down when the estimated sustainable time is reached.

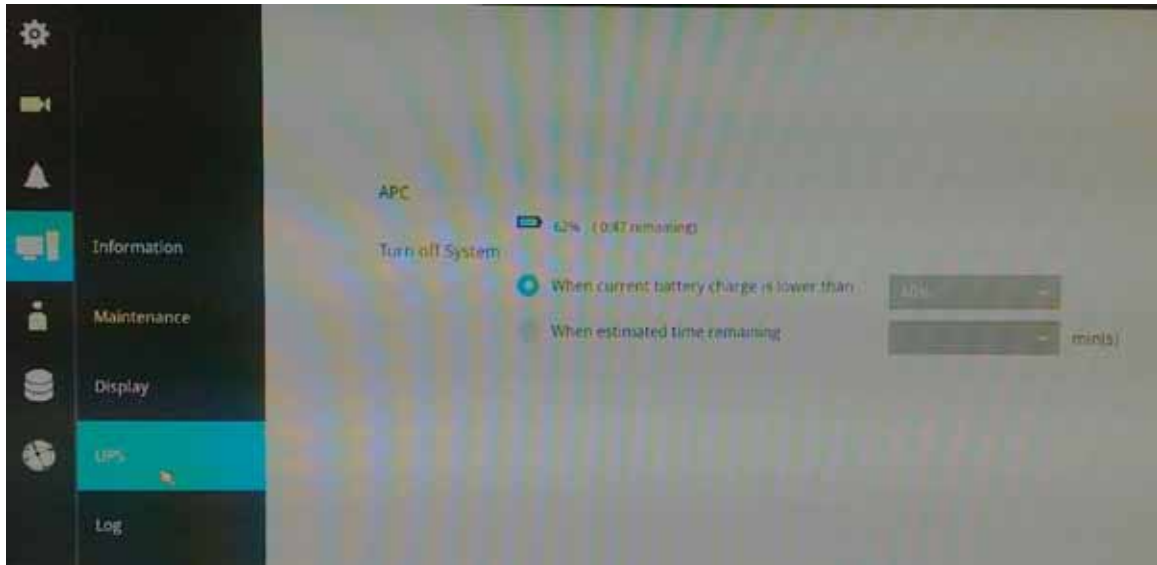



### 3-5-14. Settings - System - Log

System logs are categorized as **System**, **Recording**, **User**, and **Error**. To display system logs, select a range of time and click on the Search button.

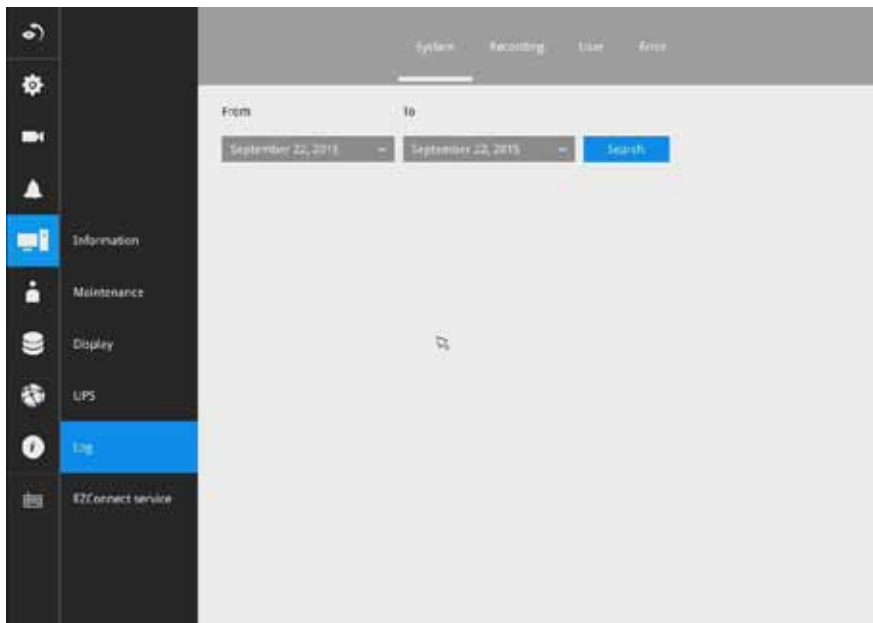

You can search for past logs in each category window.

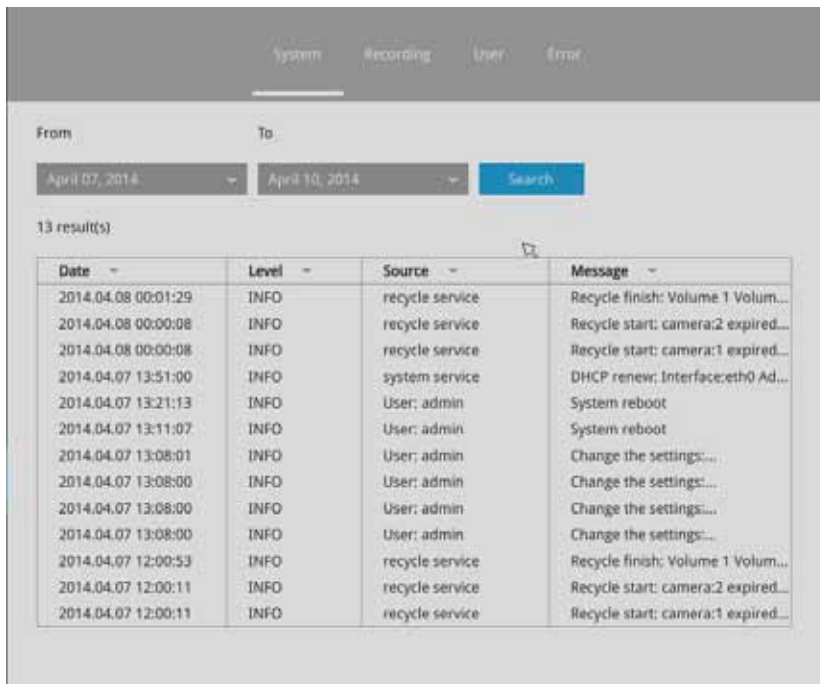

System Recording User Error

From: April 07, 2014 To: April 10, 2014 Search

76 result(s)

Date	Camera	Source	Message
2014.04.10 16:27:25	1	recording service	Recording stop: RTSP Fail
2014.04.10 16:03:30	4	camera service	Camera online
2014.04.10 16:03:28	4	camera service	Camera offline
2014.04.10 16:02:23	4	camera service	Camera offline
2014.04.10 16:02:04	4	recording service	Recording stop: RTSP Fail
2014.04.10 15:59:08	4	camera service	Camera online
2014.04.10 15:59:04	4	camera service	Camera offline
2014.04.10 15:57:53	6	camera service	Camera online
2014.04.10 15:57:07	6	camera service	Camera offline
2014.04.10 15:56:55	6	recording service	Recording stop: RTSP Fail
2014.04.10 15:56:42	4	camera service	Camera offline
2014.04.10 15:56:40	4	recording service	Recording stop: RTSP Fail
2014.04.10 15:56:34	4	recording service	Recording stop: RTSP Fail
2014.04.10 15:56:16	4	recording service	Recording stop: RTSP Fail
2014.04.10 11:19:22	1	camera service	Camera online
2014.04.10 11:19:08	1	camera service	Camera offline

System Recording User Error

From: April 07, 2014 To: April 10, 2014 Search

4 result(s)

Date	Source	User name	Message
2014.04.08 08:49:19	192.168.6.135	admin	Login
2014.04.07 13:17:15	169.254.132.244	admin	Login
2014.04.07 13:08:54		admin	Update layout: ("view":...
2014.04.07 13:06:55	169.254.132.244	admin	Login

### 3-5-15. Settings - System - EZConnect service

This window provides access to the EZConnect configuration. Please refer to page 25 for how to configure system access using the EZConnect functionality.

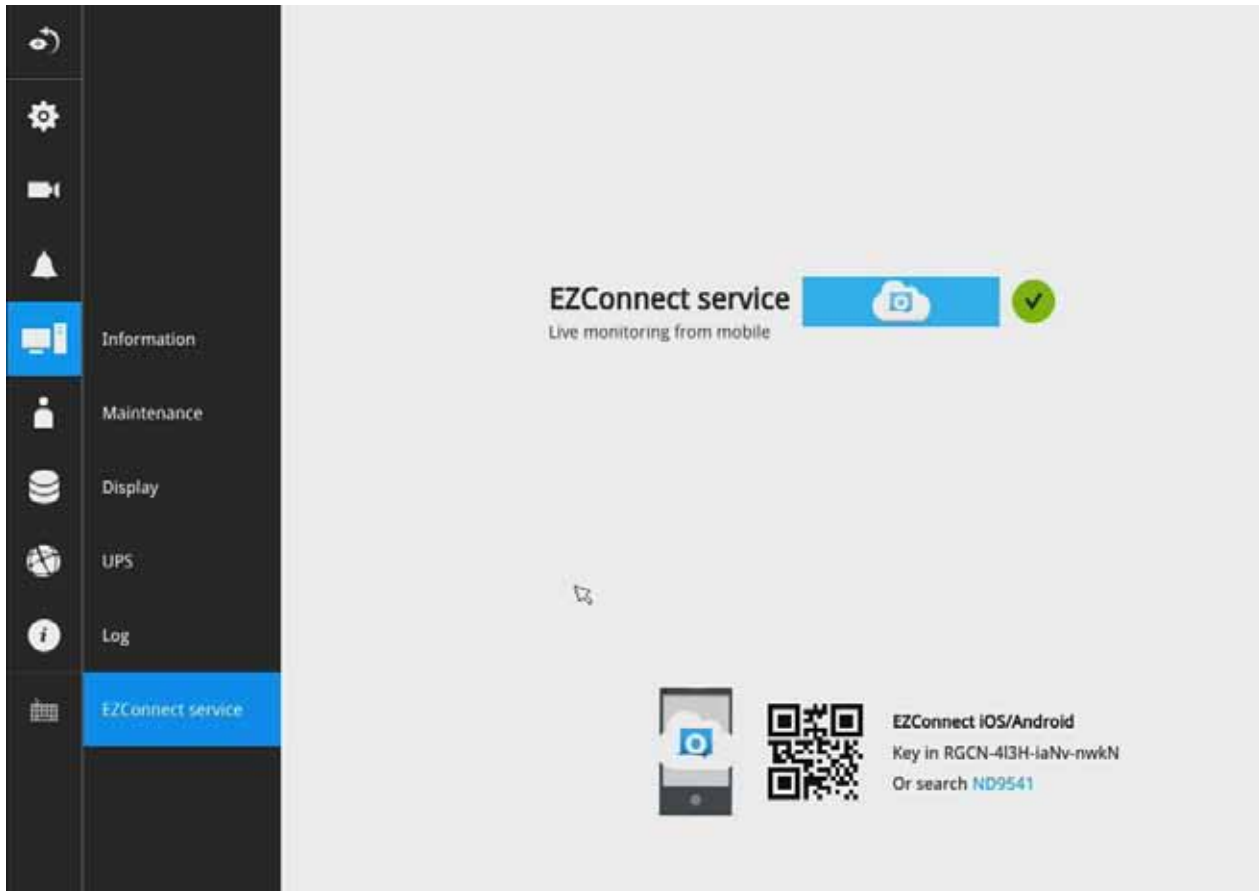

### 3-5-16. Settings - User

The User window allows you to create more users, to change user password, and place limitations on users' privileges and administration rights. Up to 16 users can be created, including the default administrator.

1. By default, there are two user groups: **Administrator** and **Regular user**.
2. The regular users cannot access the **Settings** window, meaning that regular users can not add or remove cameras, make changes to alarm, network, and all other system settings.

When users try to access the Settings window, the login window prohibits regular users to log in. There is simply no regular user's name on the login window.

3. The administrator users can access all cameras recruited in the configuration; while the regular users can be configured to have access to some or all cameras.
4. The system blocks out the video feeds from users who are denied of the access to particular cameras. The alarms and the alarm-triggered recordings from those cameras will also be inaccessible for unauthorized users.

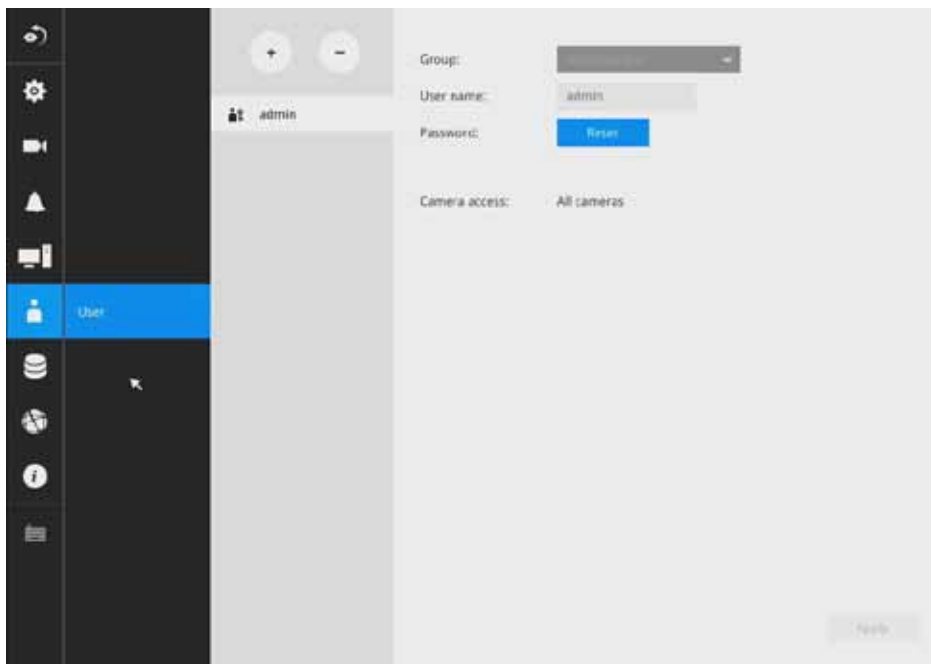

#### IMPORTANT:

The default administrator name and password are: admin and admin. It is highly recommended to change the default password to prevent unauthorized access to the system.

To create or edit users,

1. Select a User group by unfolding its pull-down menu. Select either an Administrator or regular user as the user group.

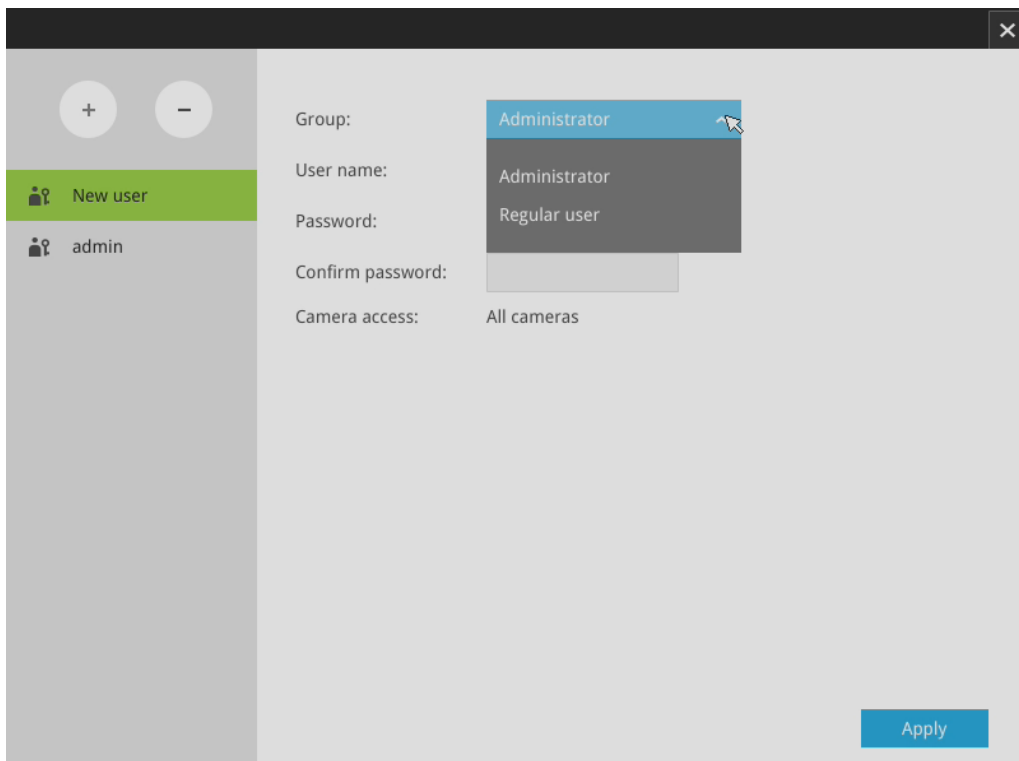

2. Enter the User name and password. The max. number of characters for a user name is 64, with alphabetic and numeric characters including [0-9][a-z][A-Z][\_][ ][-].[,][@]. The max. number for password is also 64.

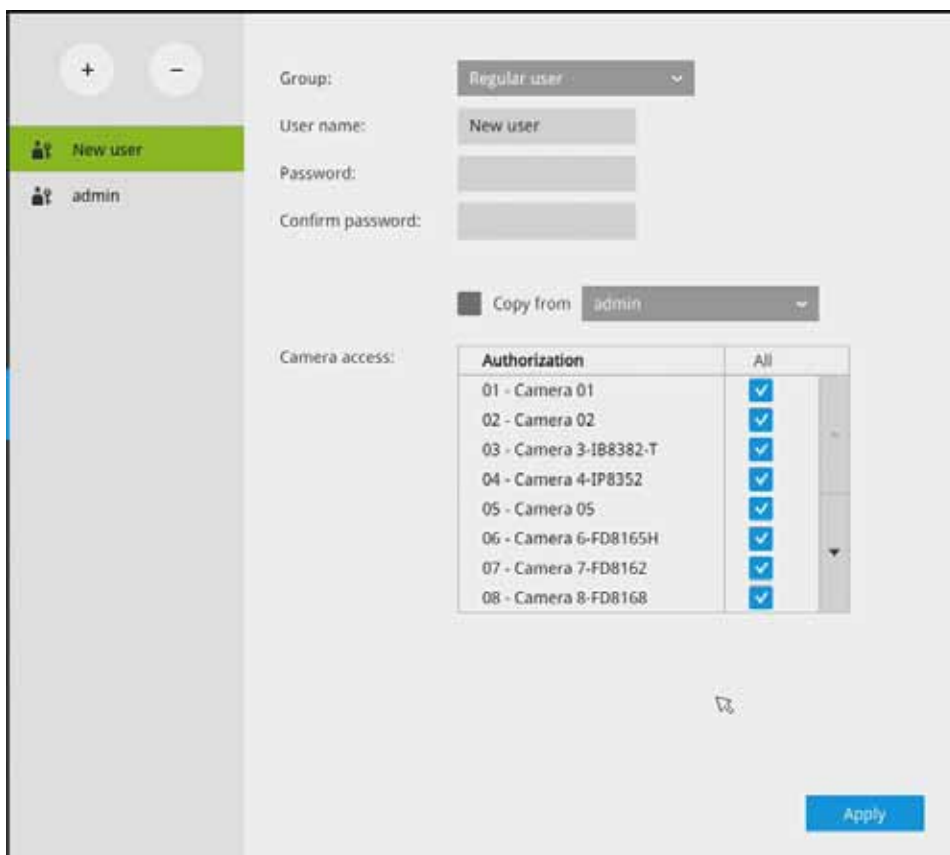

3. If you are creating a regular user with limited access to cameras, deselect the checkboxes by the cameras to deny the user access.
4. Click **Apply** to close the configuration window. Repeat the process to create more users.

### 3-5-17. Settings - Storage

The storage page displays the volume information including physical position, total capacity, used and free space, and associated commands such as Format and Delete. Since each volume contains only 1 hard drive, details information about the hard drive is also displayed on this page.

You can format an existing storage volume in situations such as when you need to re-deploy the system elsewhere.

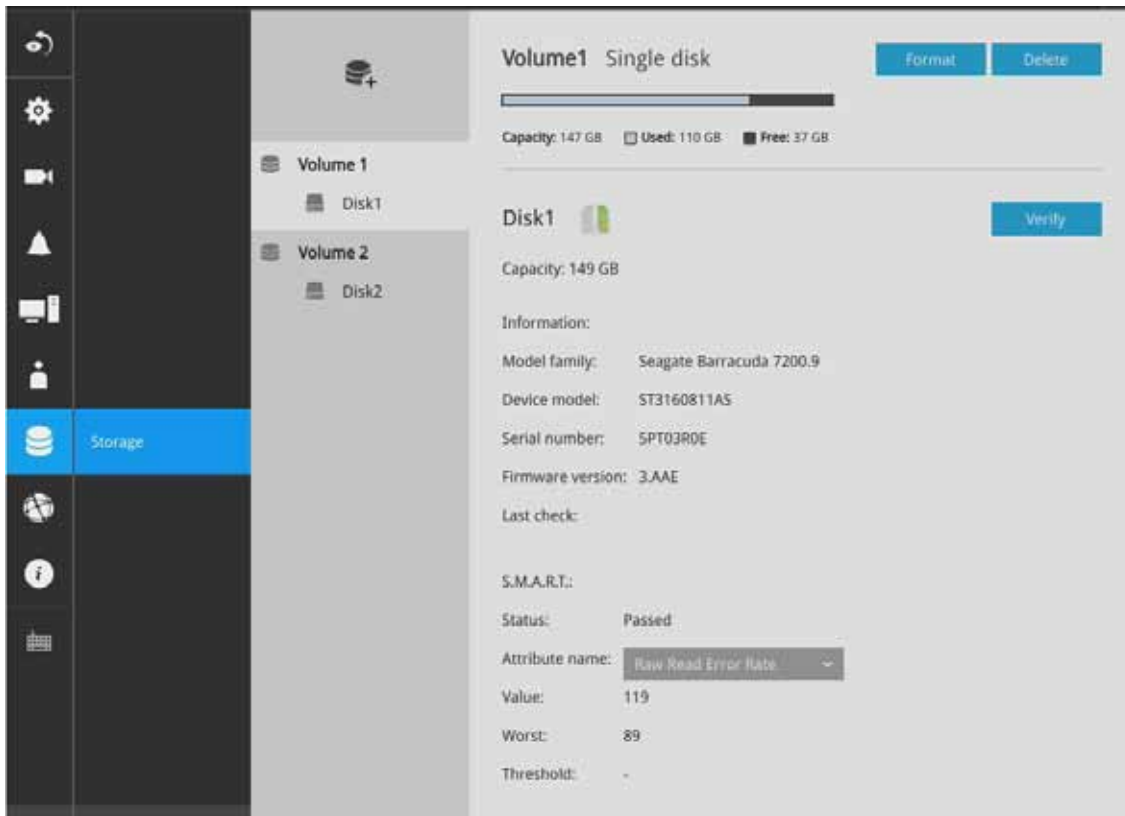

#### Disk Information:

**Model family:** The brand name of the HDD manufacturer.

**Device model:** The disk model name.

**Serial number:** Serial number assigned to the disk drive.

**Firmware version:** The version of firmware running on this disk drive.

**Last check:** The bad block check or S.M.A.R.T. test previously executed on this drive.

**Status:** S.M.A.R.T. status polled from the disk drive. This is not the results from a manually-executed S.M.A.R.T. test.

**Attribute:** The various attributes can vary from different HDD manufacturers.

**Value:** Value for the currently selected attribute.

**Worst:** Worst value acquired for that attribute.

**Threshold:** A predefined threshold or triggering value. The threshold below which the normalized value will be considered exceeding specifications.

**Raw value:** The detected parameters for that attribute.

**Status:** The judgement made to deem the current reading as OK or failed.



**Verify:**

Three types of check disk actions can be initiated through this button.

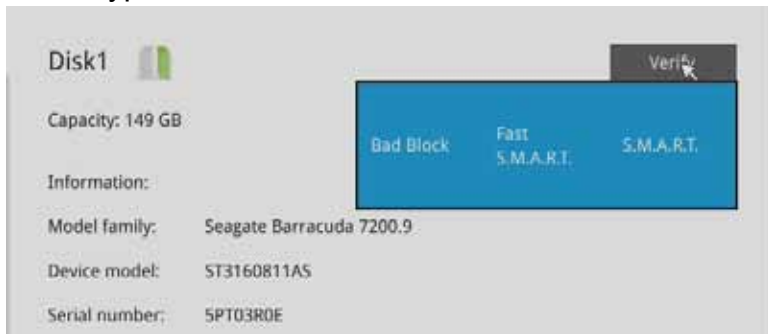

**Bad block check:** Performs read/write test to drive sectors to locate bad blocks. This action may take several hours to complete.

**Fast S.M.A.R.T. test:** Tests the electronic and mechanical performance and disk read performance, including those on disk buffer, read head, seek time, and integrity of drive sectors. The short test is performed on a small section of disk platters, and takes about 2 minutes to complete.

**S.M.A.R.T. long test:** The long test is more thoroughly and is performed to all drive sectors. The actual completion time depends on drive sizes and the attributes put to test.

The Check disk functions mentioned above, when performed during active I/Os, can consume system resources and cause dropped frames with the recording tasks.

### 3-5-18. Settings - Network

#### Bonding mode

**Single:** Only the NET1(Eth0) port is effective. NET2(Eth1) is not functional.

**Dual LAN:**

1. The network parameters of two Ethernet ports are independent. You can attach these two Ethernet ports to different subnets, e.g., one for a network console or as an uplink; the other to a PoE switch for connecting IP cameras.
2. The major gateway of the system is NET1(Eth0) as the Ethernet port for a network console. NET2(Eth1) can be used for connecting to a PoE switch and then to IP cameras.
3. Do not connect IP cameras that come with virtual IPs (cameras' default 169.254.x.x) to NET1(Eth0). The DRM search will not be able to find cameras that come without a designated IP. Also, if a DHCP server is not present in a network NET1 is attached to, you will not be able to find the NVR using the IW2 utility.
4. In this mode, do not attach NET1(Eth0) and NET2(Eth1) to the same subnet.

**Failover:** (system default)

1. The two Ethernet ports share the same IP address. NET1(Eth0) is the default main access route for the system, while the NET2(Eth1) acts as a standby port. They act as a fault-tolerant pair.
2. In this mode, NET1(Eth0) and NET2(Eth1) ports must be attached to the same subnet.

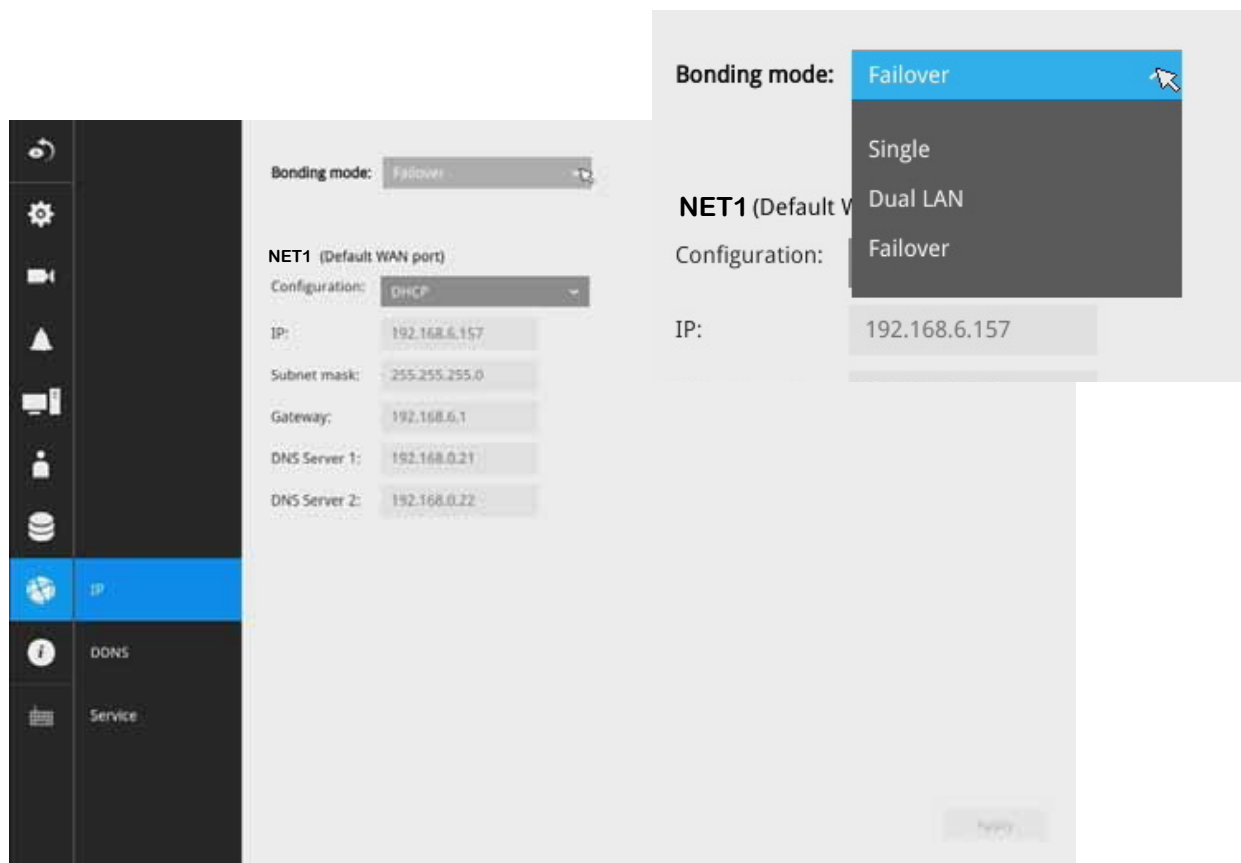



## Settings - Network - IP

DHCP: Default is selected, the server obtains an available dynamic IP address assigned by the DHCP server each time the system is connected to the LAN.

Manual setup: Select this option to manually assign a static IP address to the Network Camera.

Enter the Static IP, Subnet mask, Default router, and Primary DNS provided by your ISP.

Subnet mask: This is used to determine if the destination is in the same subnet. The default value is "255.255.255.0".

Default router: This is the gateway used to forward frames to destinations in a different subnet. Invalid router setting will fail the transmission to destinations in different subnet.

Primary DNS: The primary domain name server that translates hostnames into IP addresses.

Secondary DNS: Secondary domain name server that backups the Primary DNS.

When finished with the network settings, click on the **Apply** button.

## Settings - DDNS

VIVOTEK provides Safe100.net, as a free DDNS dynamic domain name service for users who want access from the internet or a domain name service for the NVR. VIVOTEK maintains a database of product MAC addresses for the Safe100.net service, and you can apply one domain name for each NVR system.

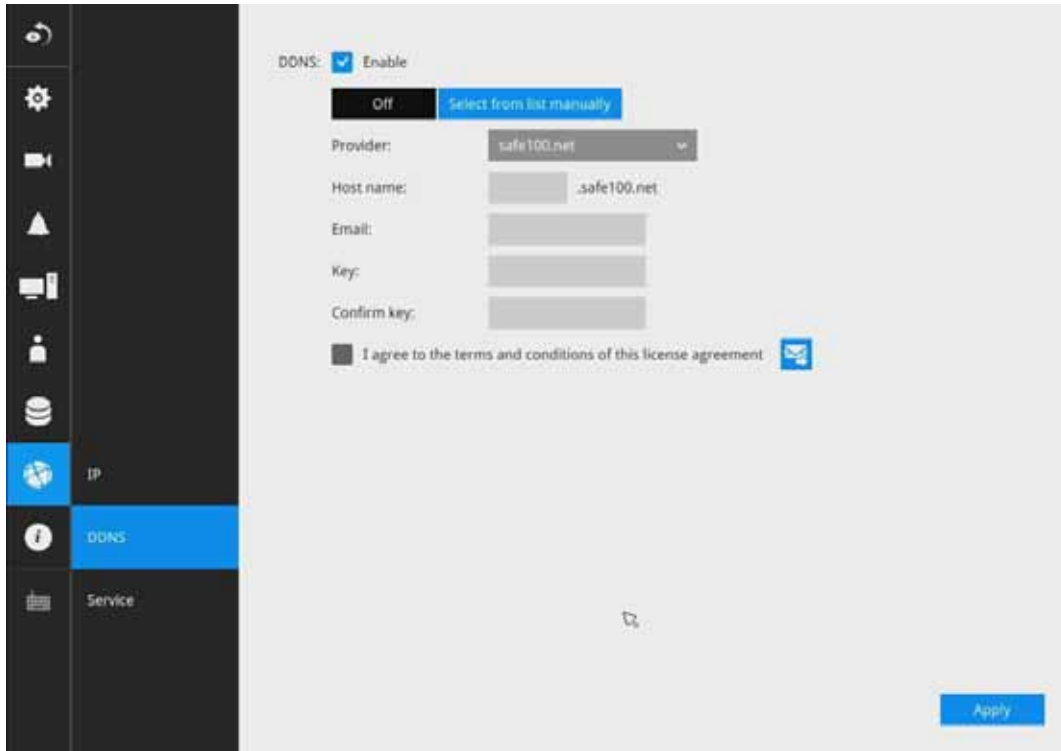

**DDNS Enable:** Select this checkbox to enable the DDNS setting.

Enter a Host name, Email address, and password twice, and then click **Apply** to proceed.

Make sure you have internet access.

Click the **Register** button. The terms of service agreement window is selected from a checkbox at the bottom. Click  to read the license agreement terms.

The acceptable characters for email address are: [0-9][a-z][A-Z][!][#][\$][%][&][\*][+][-]/[=][?][^]\_[`][~][.]. Two successive periods, [..], are not acceptable. The address filed can accommodate up to 256 characters.

Use only alphabetic and numeric characters for the password. The maximum number of characters is 64.

When completed, a confirm message will prompt. You will also receive a confirm Email. You can now access your NVR system using the [xxx.safe100.net](http://xxx.safe100.net) domain name address. Note that access from the Internet should be routed to the private IP assigned to your NVR, using methodologies such as port forwarding, etc.

## Settings - Service

By default, the NVR service and video streaming are accessed via HTTP port 80 and RTSP port 554. You can designate a different port number if the need arises. Usually it is not necessary to change these ports. HTTPS encrypted connection is enabled by default.

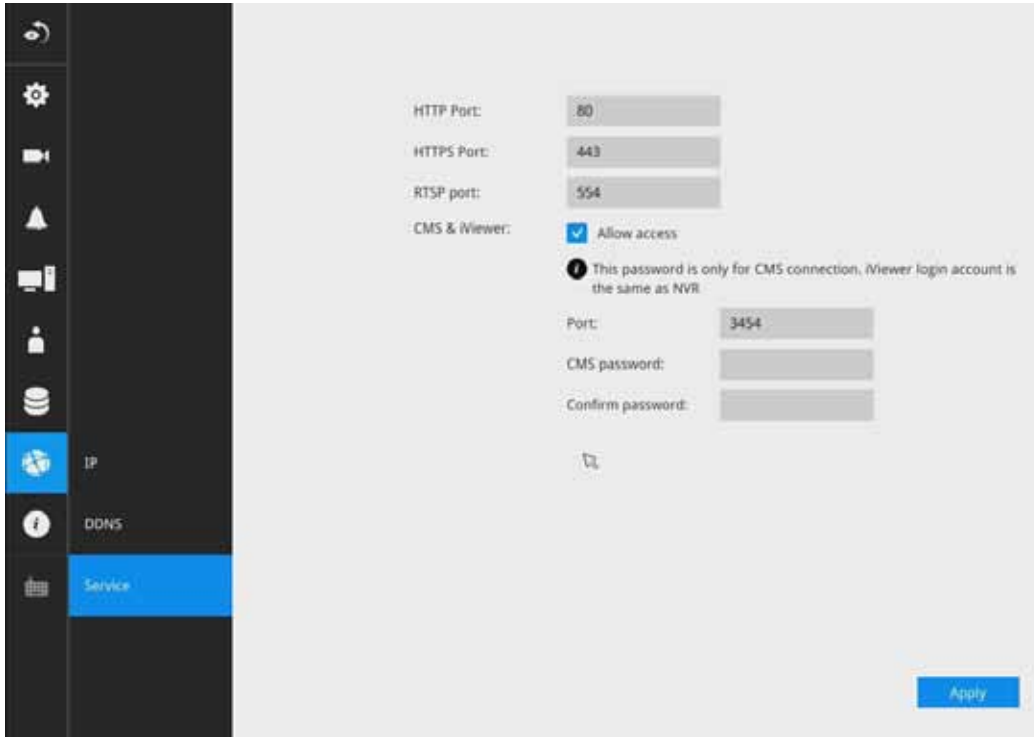

Instead of a web console, you can also access the NVR and the subordinate cameras using the **iViewer** and VIVOTEK's **VAST** software. The NVR can be managed as one of the sub-stations in a hierarchical device structure.

Set up a password for access from the VAST server before you can join the NVR to a VAST configuration. For access from the iViewer, you log in using the same user name and password for the login to the NVR.

Below is the screen showing the sub-station recruitment process from a VAST server.

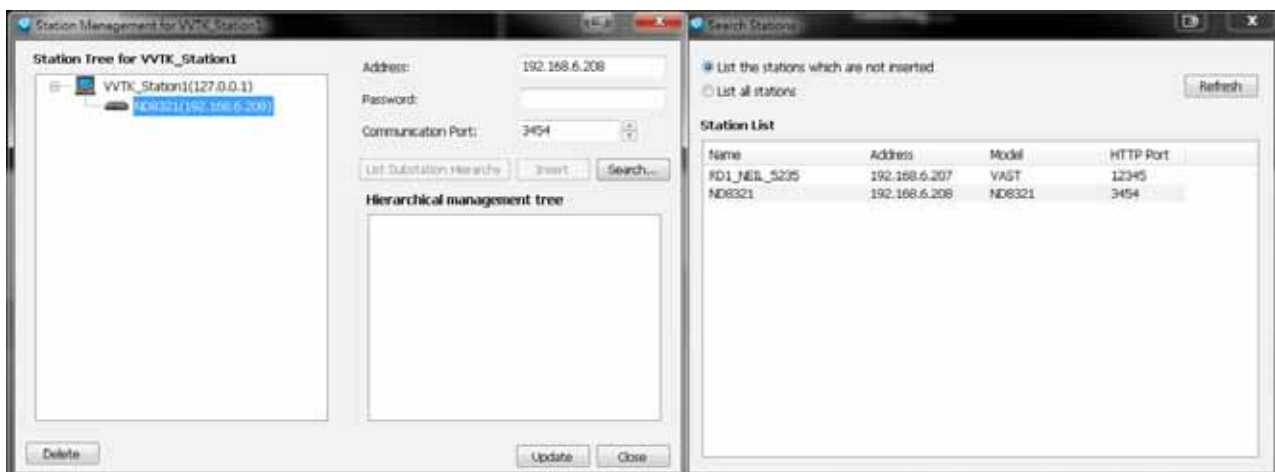

### 3-6. Information

This window shows the revision number of the firmware running on this machine.

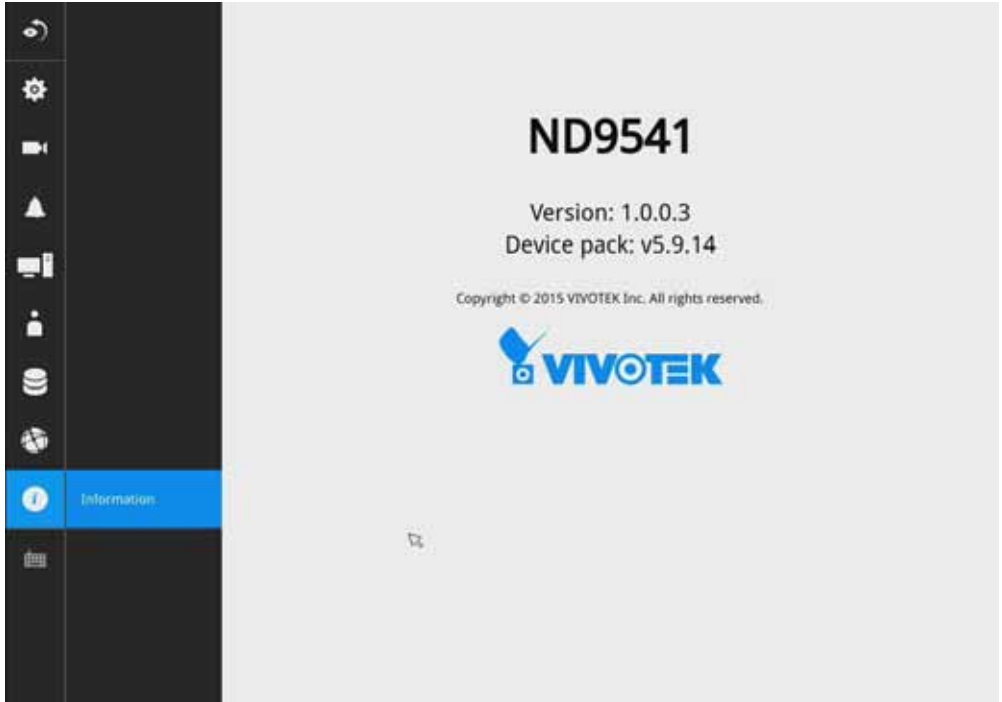

# Section Two

## Management over a Web Console

There are two different interfaces on the system:

1. One is connecting mouse and keyboard, and an HDMI cable to a TV screen or monitor. The local management thus made is described in **Section One** of this manual.
2. The other is accessed through the Ethernet connection. Management via a web console will be described in **Section Two** of this manual.

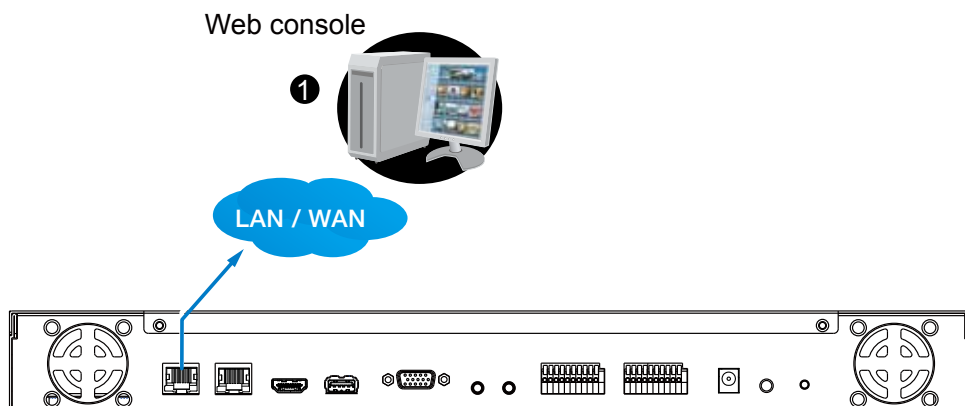

# Chapter Four Login and Getting Started

## 4-1. Login

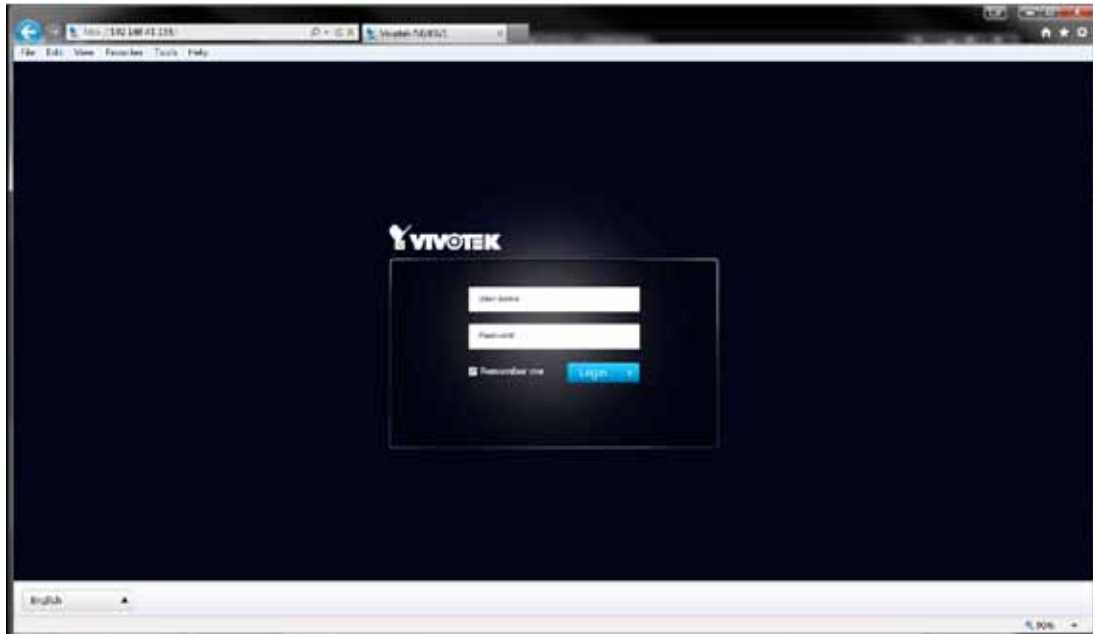

This is the login page on the browser. The minimum for resolution is 1280x960.

If you enable the IE7 compatible mode when using the IE8 browser, please disable the compatibility function. While you are in the browser, press F12 to check its status.

It is highly recommended that you should change the default password. Please refer to **Settings > Security > User account** page to see how to prevent unauthorized access. The system will prompt you if you entered an incorrect user name or password.

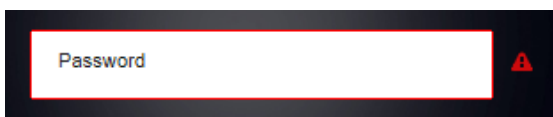

**Remember me:** Your user name will be preserved in browser cookies for two days if you select the Remember me checkbox. The user name will be automatically erased if you do not log in to the system for two days.

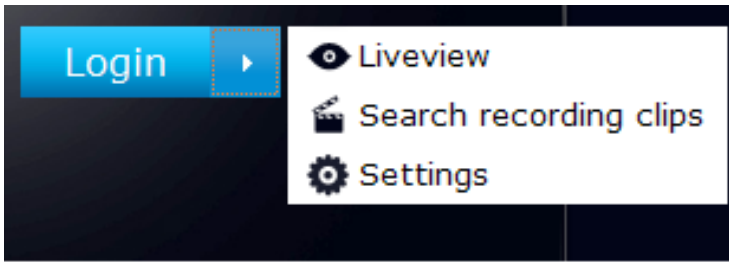

You may login to a different software utility by unfolding the side panel on the **Login** button.

You can also select a different language using the **Multilingual** selector menu on the **lower left** corner of the Login screen. The functional items, menus, and dialogues will then be displayed using the selected language.



**Remember me:**

Select the checkbox to save your user name for use on the next login. The user name will be preserved in browser cookies for two days. If you do not login within the next two days, the user name will be erased.



**Login errors:** below are the login errors that might occur.

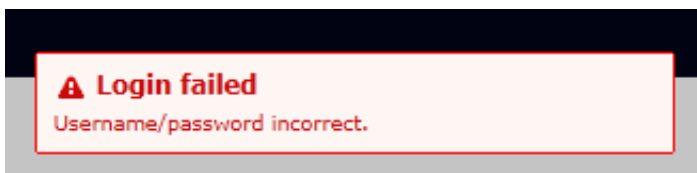

A Login failure can result from the incorrect user name and passwords.

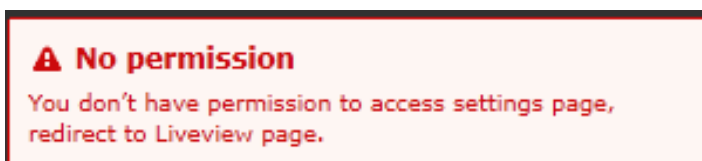

The No permission error occurs when a user logs in using an authentication that has no access rights to the Settings page. He will then be re-directed to the Liveview page.

**Login options:**

You may also mouse over the Login button to display the login options. You can then enter the Liveview, Playback, or Settings window.



The NVR system features a simple UI structure which consists of a Liveview window, a Playback utility, and a system Settings window. Once logged in, you can move from one window to another by selecting the hot link buttons on the upper right of the screen.

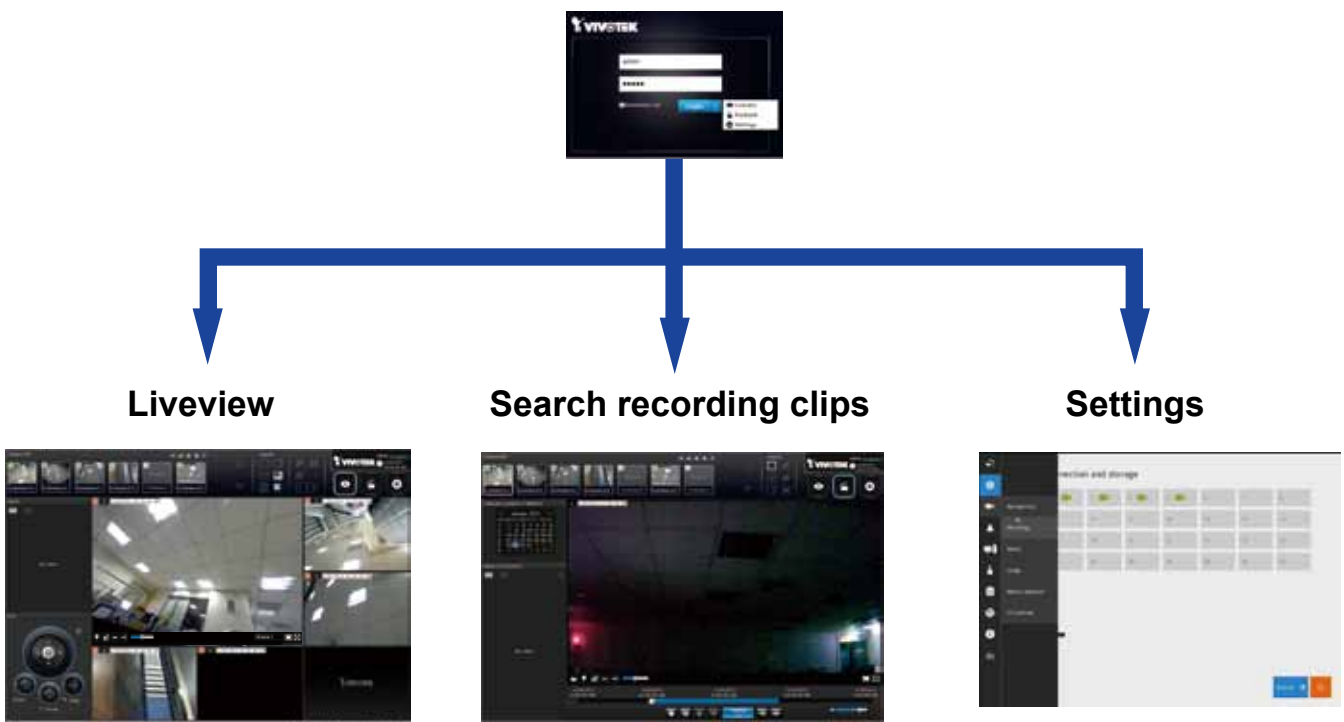



**⚠ IMPORTANT:**

1. Before operating the NVR, make sure you have properly installed hard drives and configured the storage volumes. Otherwise, you will not be able to operate some of the system's functionality.
2. Since the NVR system comes with 32-bit plug-ins for screen control, if your PC runs a default 64-bit IE browser and you manually enter the NVR's address on the browser, your browser session may malfunction. Instead, if you double-click on the discovered NVR on the IW2 utility, a 32-bit IE browser will open.
3. When you log in to the Liveview or Playback interface to stream a live or recorded video, install the ActiveX plug-ins. If it does not prompt when you log in, install plug-ins when you try to playback a recorded video. You may then need to re-start the IE browser console.

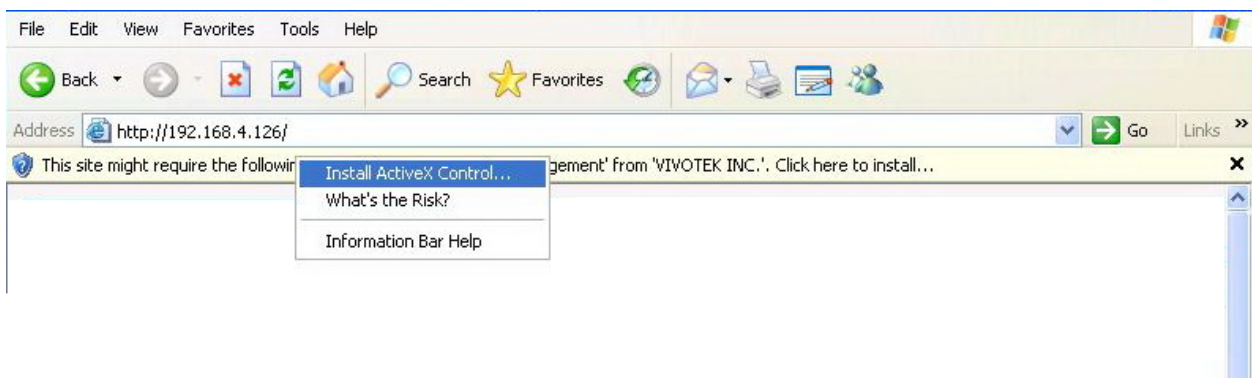

## 4-2. Graphical Layout and Screen Elements - Liveview

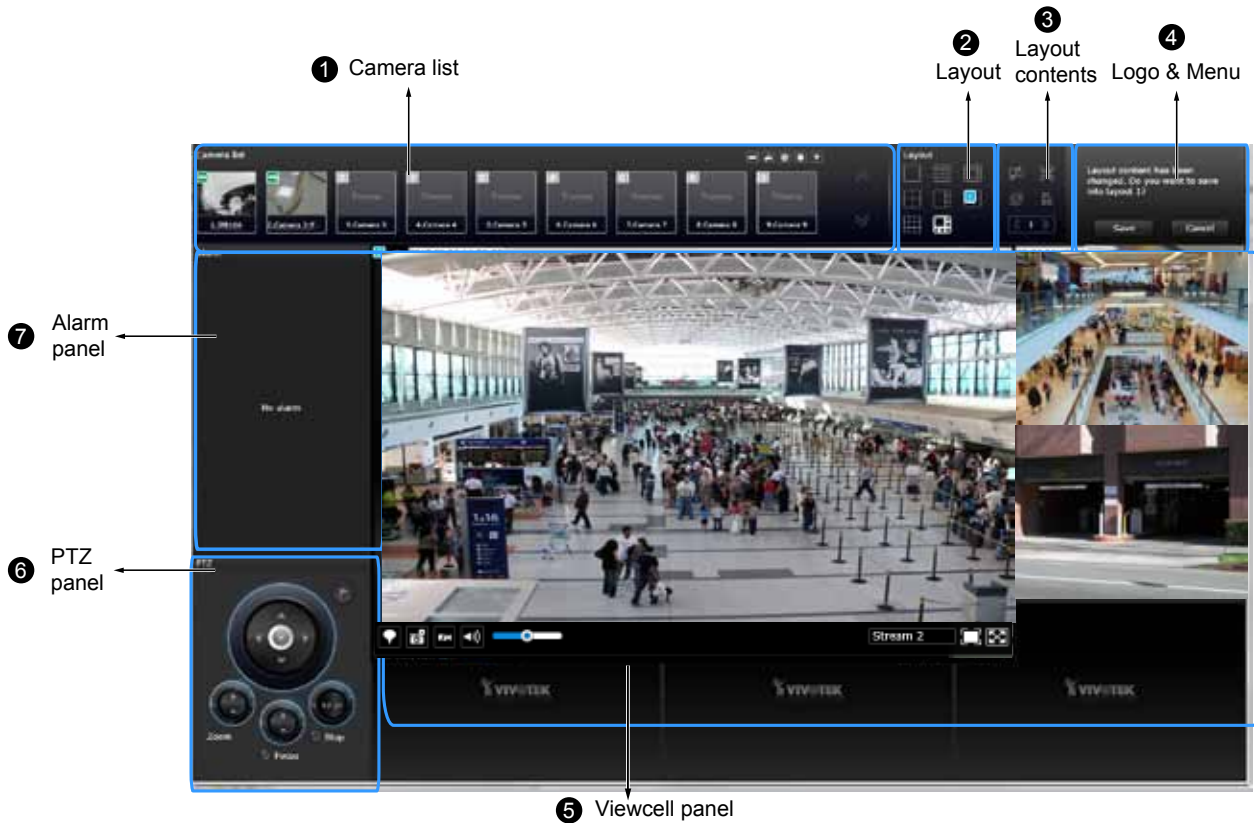

Once you log in, the system defaults to the Liveview page, which provides access to other configuration utilities, live view screen, and other functional panels. The screen elements are described as follows:

Item	Name	Description
1	Camera List	Provides a glimpse of all cameras inserted into your configuration. Basic information is also provided along with a screenshot.
2	Layout	Provides access to various layouts
3	Layout contents	Provides functions to extend, rotate, and redo the layout. System DI/DOs are also shown in here.
4	Logo & Menu	Provides access to the <b>Playback</b> and System <b>Settings</b> utilities, as well as system time and logout function.
5	View cell panel	Displays video streams from one or multiple cameras. Snapshot, streaming, bookmark, and audio control functions are also available on individual view cells.
6	PTZ panel	Exerts Pan/Tilt control on a selected view cell if the camera comes with mechanical PTZ mechanism. Note that the use of joystick is currently not available.
7	Alarm panel	Reports alarms transmitted via cameras' DI connections or those by the Motion Detection, Tampering, etc.

Each panel will be described in further discussions.

## 4-2-1. Camera List Panel

The camera list displays the recruited cameras by the sequential numbering order you configured in the System Settings utility.



Depending on the size and screen resolution of your monitor, the snapshots of 8 cameras are displayed in this panel. If a user logged in using a credential of a limited access, he may only see cameras that he can access instead of all of the cameras.







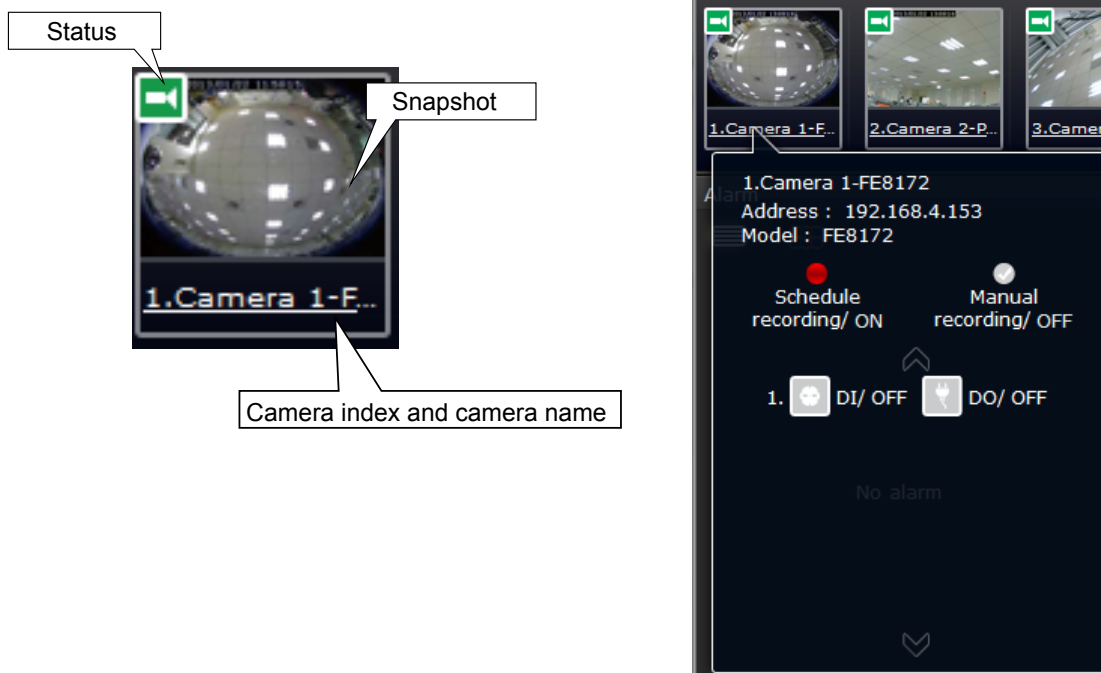

To arrange a view cell layout, users can click and drag a camera to a view cell. Once connected, a camera's video stream is displayed in the view cell.

### Camera Thumbnail:

A mouse click on the camera name under the thumbnail brings forth the summary of IP address, model name, recording setup and DI/DO information.







- \* **Snapshot:** the camera's image snapshot is replenished every 5 minutes. If a camera is disconnected, the last image taken will be used to represent a camera.
- \* **Camera index & Camera name:** Placing the mouse cursor on top of a camera text displays the camera index number and the camera name. You can click on the camera index to display the information box.
- \* **Status:**

	Online: the online status can be accompanied by the DI/DO icon  
	Offline: camera is disconnected.
	An unconfigured camera instance
	Digital input is triggered
	Connected and recording video to system storage
	Connected with live streaming
	Disconnected or trying to establish a connection

### Sorting criteria

Use the sorting buttons to re-arrange the order of the cameras on the list. Cameras that match the condition will be brought to higher places on the list (front of the order) regardless of its original camera index.













	Online: the online cameras.
	Offline: the offline cameras.
	Unconfigured camera instances
	Cameras whose Digital inputs have been triggered
	Cameras whose Digital outputs have been triggered



### NOTE:



For online cameras, the snapshots on the camera list are refreshed by every 5 minutes, and therefore may not represent the latest occurrences on the surveillance areas.

## 4-2-2. Layout

	1x1
	2x2
	3x3
	4x4
	1P+3
	1M+5
	1M+12
	1M+31
	User layout #1
	User layout #2
	User layout #3
	User layout #4

By default, 5 typical layouts are provided for the user. They include: 1x1, 2x2, 3x3, 4x4, 1P+3, 1M+5, 1M+12, and 1M+31. System default is the 4x4 layout. Cameras that do not fit into the first page of a layout, say, a 3x3 layout, will be displayed on the succeeding layout pages.

Each functional button on the screen is activated by a mouse hover. For example, the below states designate user's operation on a button:

- : not selected.
- : moused over, and is ready for selection.
- : selected, and is taking effects.

Because the maximum number of supported cameras is 8, the last view cell on the 3x3 page configuration will be unusable.

Only an administrator can change and preserve a custom layout, and every user can designate a specific layout to be displayed when he/she logs in. The default layout for each user is stored in a browser's cookies.

Whenever changes are made to the current layout, a message prompt will appear on the side of the layout panel reminding you to save your current setting.

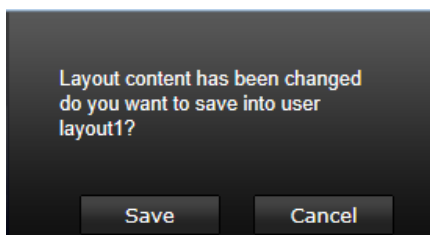

Note that a user who did not log in as an administrator can change a layout, but his configuration changes (with cameras placed on view cells) **will not** be saved.

### User Layouts







There are another 4 user layouts that can be individually configured. An administrator can insert camera views into these layouts, and save the configuration. These user layouts can be seen by all users.

If you click the **Rotate** button before the configuration changes can be saved, your configuration changes will be lost.

### 4-2-3. Layout contents

A few functional buttons are available on the Layout contents page.

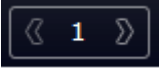
	<b>Clears</b> all view cells on the current layout.
	<b>Full view:</b> extends the view cells on the current layout to the full of the screen.
	<p><b>Rotate:</b> the rotate function lets system display successive layout pages by the intervals of <b>10</b> seconds. The layout page that does not contain camera views will be skipped.</p> <p>A Rotate action will stop when you</p> <ol style="list-style-type: none"> <li>1. move to another page,</li> <li>2. move to a user layout,</li> <li>3. click to select a view cell,</li> <li>4. remove a camera from view cell.</li> </ol>
	Click to display the NVR's DI/DO statuses.
	If your current layout spans across multiple pages, use the arrow buttons to switch from one page to another. The index number of the current page will be shown between the arrow buttons.

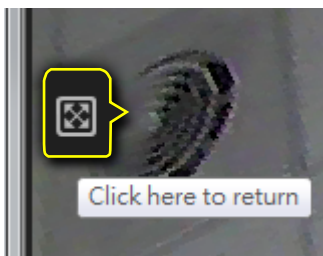

When your current layout is displayed in a full view, move your cursor to the left center of the screen to return to the default Liveview screen. The **Return** button will appear.

### 4-2-4. Logo & Menu

A logout button, system time panel , and 3 hot link buttons to access the **Liveview**, **Search recording clips**, and **System Settings** utilities.



The system date and time refers to the date and time kept on the NVR system's real time clock.

Due to the limited space for the user name, user name may be partially displayed until you hover your mouse cursor.

#### **IMPORTANT:**

Your configuration changes will be lost if you click one of the hot link buttons to move to another utility window. For example, you have changed your Live View layout and then click on the Playback button, you will enter the Playback window without saving your configuration. **Save your changes before you use these buttons.**

## 4-2-5. View Cell panel

A single view cell is shown below. Each view cell contains a video stream display area, an information bar, and functional buttons at the bottom. A view cell is displayed in Normal, Focused, or Maximized mode.

1. **A single click** selects a view cell from the View Cell panel, enables its function buttons, and turn it into the Focused mode.
2. **The 2nd click** maximizes the size of the view cell to the full of the panel.
3. **The 3rd click** shrinks the maximized view back into the focused mode.

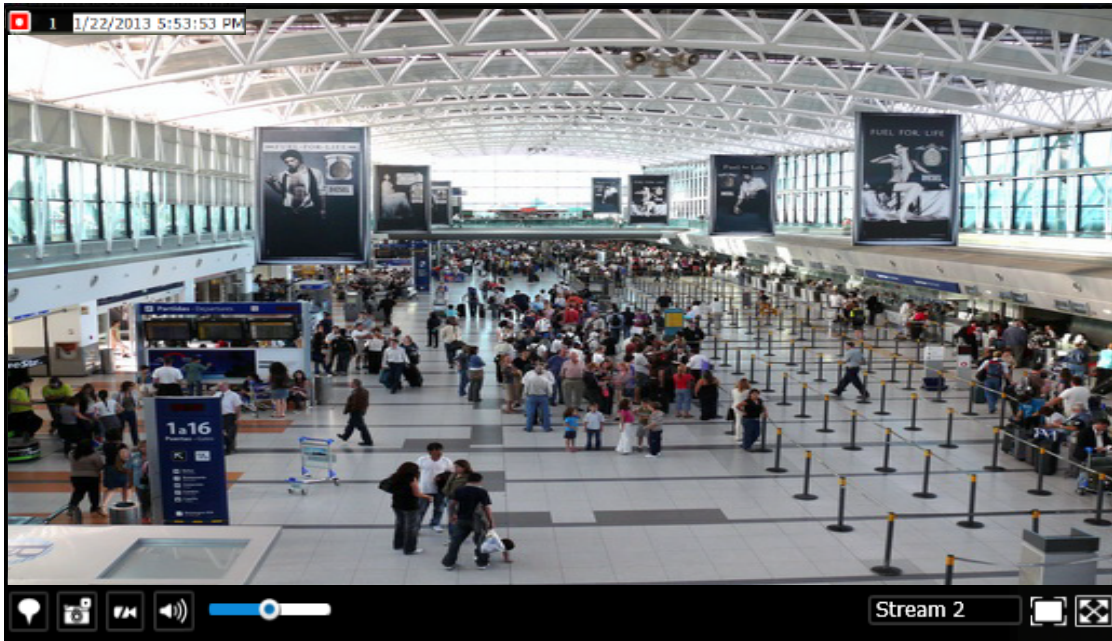

Although the system automatically selects the video stream to display on the view cell, you can still manually select a different video stream from the Stream tab below.

To deselect a view cell and return to the normal view, click on the **Restore**  button at the lower right of the window.

## Adding Cameras to View Cells

1. Click and drag a camera from the camera list to an unoccupied view cell.
2. Double-click a camera on the camera list. The camera will be added to the first available view cell.

To deselect a view cell and return to the normal view, click on the **Restore** button at the lower right of the window. You can also click on another view cell to continue adding other cameras.

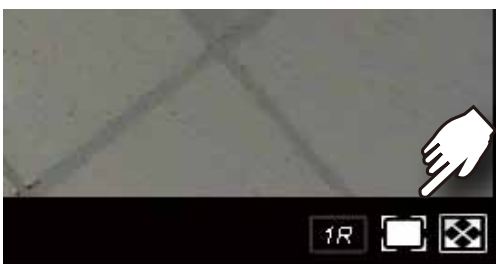

A view cell attempting to connect to a network camera will look like this. If the connection attempt takes a long time, it may result from network problems or incorrect configuration with video streaming. For example, you may have configured the camera to be streaming a 5MP stream. The NVR uses video stream #1 for recording, and stream #2 from cameras for live viewing. You should then open an individual web console with the network camera to change its video streaming configuration.

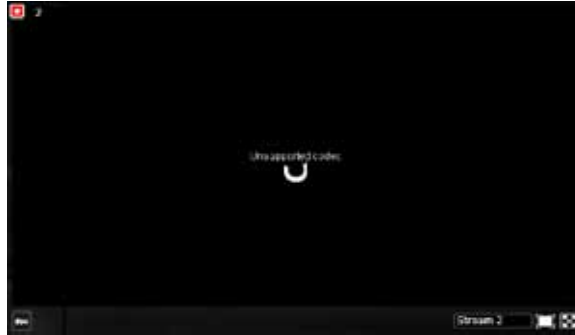

**! IMPORTANT:**

A camera can be inserted into multiple view cells. This way, a camera with a wide field of view, can simultaneously display different regions of interest on different view cells.

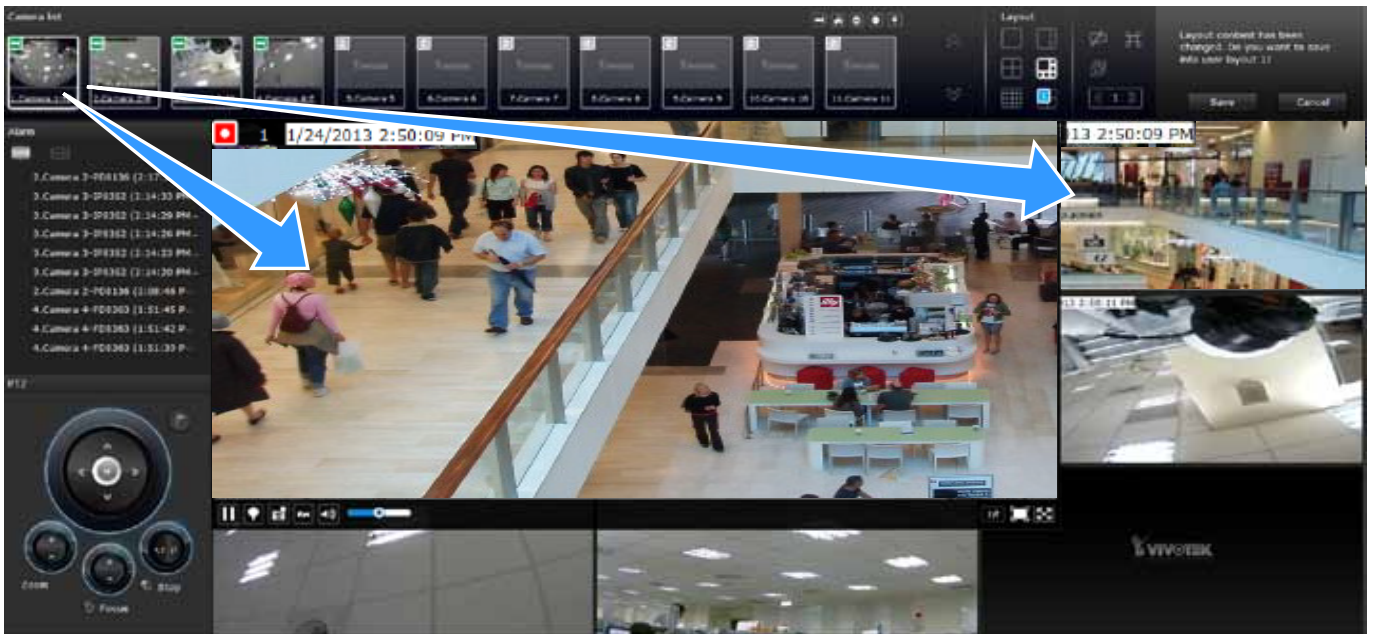

If the current layout already contain the max. number of cameras, e.g., 16 for the ND9441, the following message will prompt.

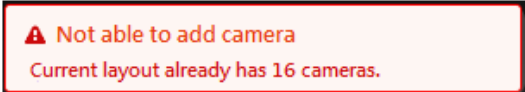

If you are using the 16-CH ND9441, there can be more than 16 view cells across multiple layout pages, e.g., on the second page of the 1M+12 layout. Placing a camera in the 17th to 18th view cells will bring out the following message.

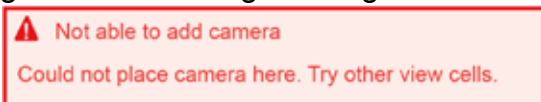



## Information Bar

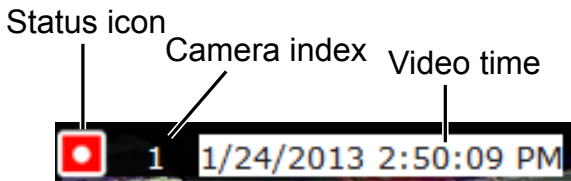

Status icon	Description
	Connected with live streaming; a single click on this icon can trigger a manual recording.
	Connected and recording video to system storage.
	Disconnected or trying to establish a connection.



### NOTE:

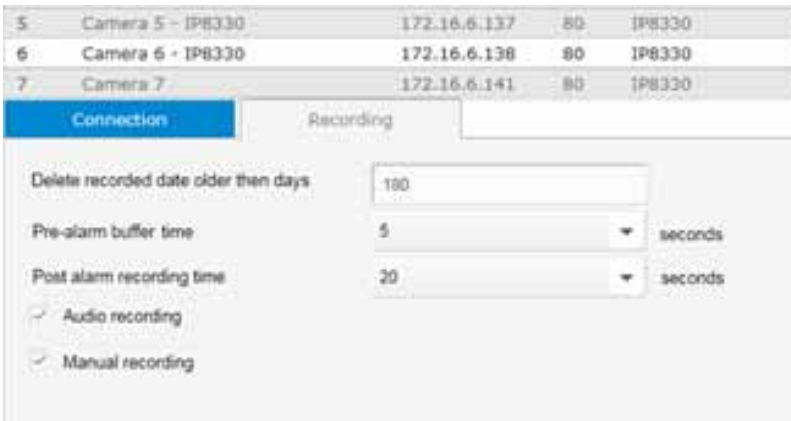

If you disable the **Manual recording** function on the **Settings** page, you will not be able to use the Manual Recording function on the Liveview.

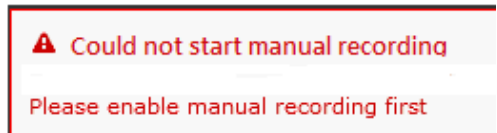

A mouse hover over the status icon will produce the following messages:

1. "Connecting..." or "Cannot connect"	Connecting to a camera, or connection problem might have occurred.
2. "Live streaming"	Video is being streamed.
3. "Recording"	Currently recording the video stream.

**Camera index:** an index number appointed to a camera following the order you inserted cameras during the initial setup.

**Video time:** The time configured on the NVR system is displayed here.

The time display format is as follows:

yyyy/m/d/yyyy	hh:mm:ss	2014.05.05 16:15:41
---------------	----------	---------------------

## Tool Bar Buttons

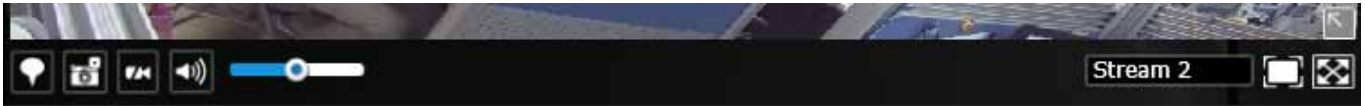

Buttons	Description
	Resumes streaming.
	Pauses a video stream.
	Adds a Bookmark (that saves a short description and a one-minute footage from the current feed)
	Takes a snapshot.
	Removes camera from the view cell.
	Mutes (if there is audio input from the camera.)
	Unmutes
	Stream selector.
	Restores the view cell's original position on the Liveview panel.
	Maximize the size of current view cell.
	Activates the PiP function.
	Disables digital zoom (PiP).
	<p>Fisheye display modes - if the view cell contains video from a fisheye camera, the fisheye display mode selector will be available:</p> <p>1O: the original circular view.                      1P: the panoramic view.                      1R: the regional view.</p> <p>Please refer to the fisheye camera's User Manual for more information.</p>
	Volume controller

## Tool Bar Functions in Details

### 1. **Play** and **Pause** buttons:

These buttons pause and resume a video stream currently being played on your web browser. Note that this operation does not affect the video recording taking place between a camera and the NVR system.

### 2. **Bookmark**:

This function allows you to place a bookmark on a recorded stream when you observe a situation from your live view window. The bookmark is preserved as a one-minute footage along with a short description of a particular incident. The precondition of using this function is that the video stream, while you are watching it on the view cell, must be recorded to the NVR at the same time.

To add a bookmark,

1. Click on the button,
2. Enter a short description that can be as long as 120 characters.

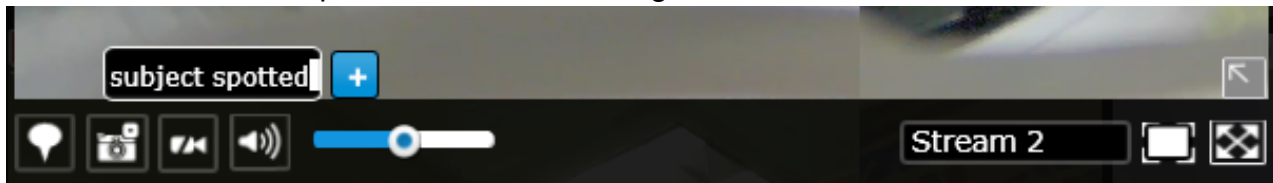

3. A confirm message will prompt at the lower right of the screen.

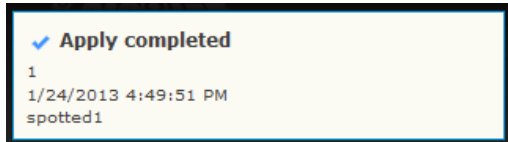

If the current video feed is not being recorded to storage, you will receive the following message:

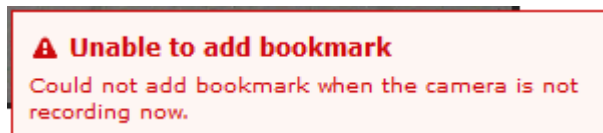

Errors with creating bookmarks may also result from network and server errors.

Below are two bookmarks (yellow tags) shown along with a recorded video in the Playback utility screen. Bookmarks help find and retrieve important moments in a recorded video.

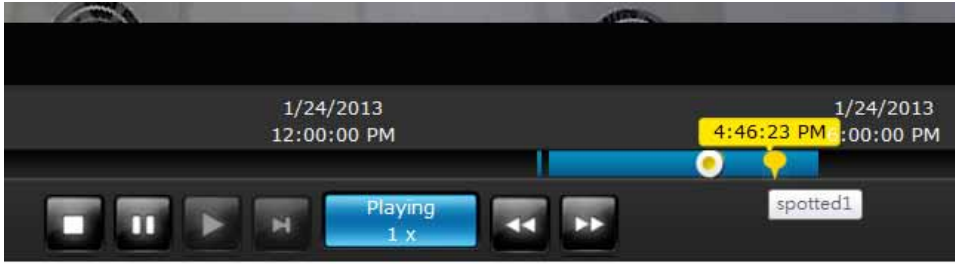

 **NOTE:**

Bookmarks will be erased if the user/system erases the video clips they were appended to. For example, system will recycle storage space by deleting old videos along with their bookmarks.

**3. Snapshot:** 

This button produces a snapshot prompt. You may then right-click on the snapshot image to save it to a preferred location.



Note that the size of a snapshot is equal to the frame size set for the video stream.

4. **Clear:** 

This button removes camera from the current view cell. The view cell will then be available for other cameras

5. **Mute and Unmute:** 

These buttons stops or resumes audio from a live stream.

6. **Restore:** 

This button restores the view cell's original position on the Liveview panel.

7. **Maximize:** 

This button extends the size of current view cell to the full of the Liveview panel.

8. Activate and Deactivate **PiP** function: 

PiP is short for **Picture in Picture**, a function that provides digital zoom into a live video. When activated, a Global view window will appear at the lower right of the view cell as shown below. You can display only a portion of the complete video frame as an area of your interest. Using a click and drag on the ROI window, you can instantly move to other areas within the video frame.

You can resize the ROI window by a mouse hover on the lower-right corner of the window until the resize mark appears. The default size of the ROI window is 25% of the Global view.

Click on the deactivate  button to close the PiP window.

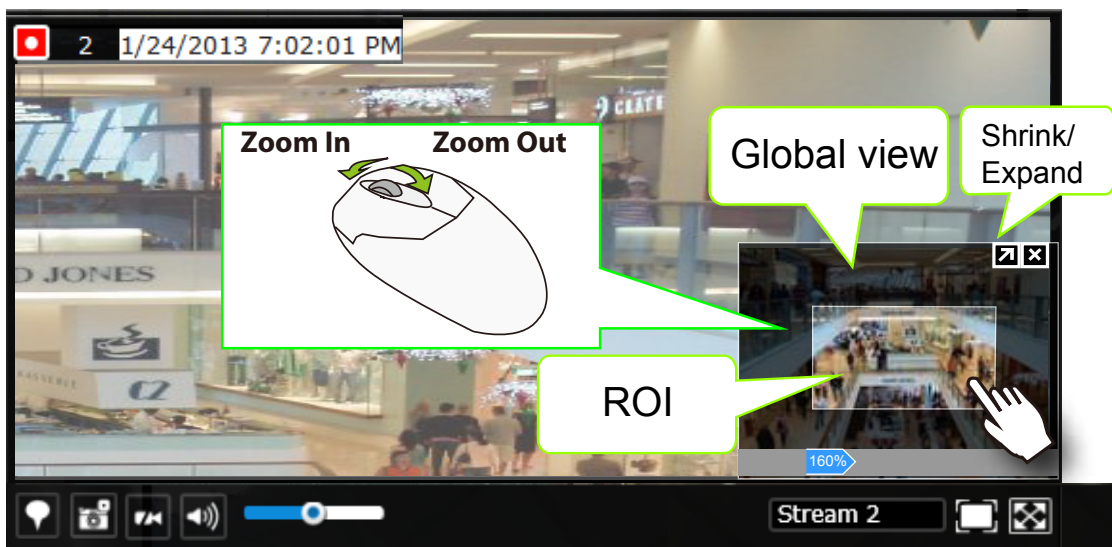

Note that not every camera supports the PiP function.

 **NOTE:**

The Talk function in the two-way audio is currently not supported.

**9. Volume controller:**



The volume control takes effect when audio input from the network camera is available. Audio is heard only from a focused window, one that you selected by a mouse click from the Liveview panel. Some network cameras do not come with an embedded microphone, and its audio is disabled by system default. The actual sound level is also dependent on the system volume of the PC having a web console with the NVR.

The sound volume configuration will not be preserved when a camera is removed from a view cell, web console is restarted, or when the Liveview layout is re-configured.

**10. Fisheye display modes:**



A view mode selector icon appears in a view cell of a fisheye camera. You can click to select a viewing mode. The viewing modes are illustrated as follows:

1O (Original view)

**1O View (Original View)**

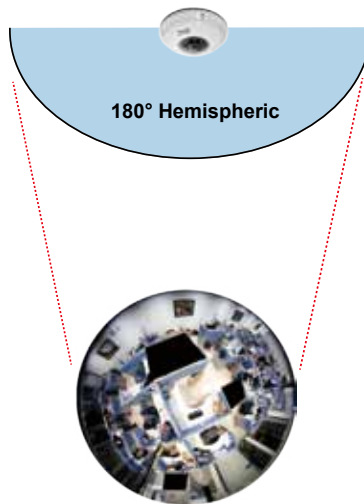

1P (Panoramic view)



## 1R (Regional view)

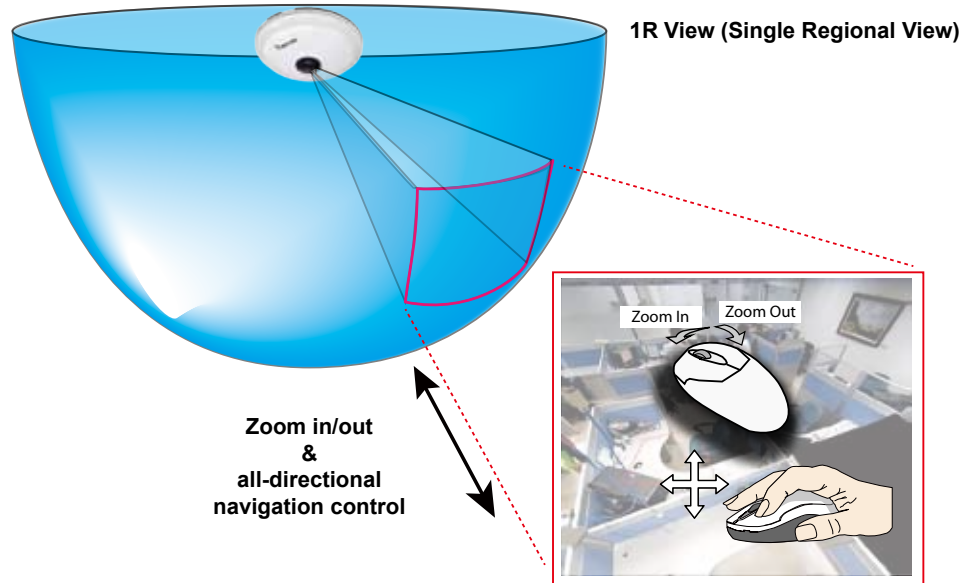

The 1R mode (or rectilinear) provides access to one image section within the hemisphere. You can zoom in or out (using the mouse wheel or PTZ panel) or travel through to other areas within the hemisphere using simple mouse clicks and drags. A single click on a particular object can bring the object to the center of your view window. Click and hold down the left mouse button, and you can swipe the view both horizontally and vertically.

Note that if your fisheye mounting type is set to the **Wall Mount** type, your screen control in the view cell will be limited to 90° pan and tilt. Make sure your mounting type and camera settings have been properly configured.

Because fisheye lens can cover a wide surveillance area, you can insert a fisheye camera into multiple view cells, and let different regional views display in these view cells. In this way, you can have a glimpse of multiple areas of interest, and the configuration of these different view windows will be preserved when you save your layout settings.

## 4-2-6. PTZ panel

The PTZ panel takes effect for cameras that come with mechanical PTZ functions. It does not support digital PTZ functions. To utilize its functions, select a view cell populated by a PTZ camera, such as a speed dome.

Depending on the individual functions that come with PTZ cameras, some functions will not be available for every cameras. For example, the zoom controller will not apply for a PTZ camera that comes without a mechanized zoom module, such as PD8136 and PT8133.



Listed below are the camera models and the types of supported PTZ controls:

Model (series)	Pan/tilt controller	Preset location	Zoom controller	Focus controller	Auto Pan/Patrol controller
PD	Yes	Yes	No	No	Yes
VS (VS8100 and 8102)	* Depends	Depends	Depends	Depends	No
VS84xx/88xx	Depends	Depends	Depends	Depends	Depends

\* If the analogue cameras connected through the video server support PTZ mechanism.

### NOTE:

On the Liveview window, currently the Continuous Move and the Click-on-image functions for PTZ cameras are not supported. Neither can you zoom in/out using the mouse wheel.



**PTZ presets:** If your PTZ cameras have preset locations, click on the button to unfold the preset menu. Click on any of the preset locations to move to the area of your interest. Refer to your camera's User Manual for how to configure preset locations.

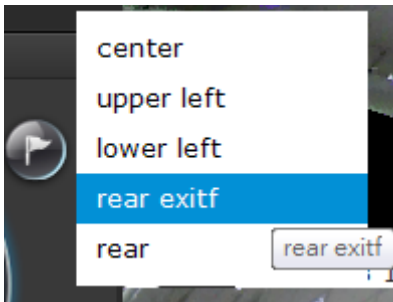

The following message will prompt if the camera has no preset locations.

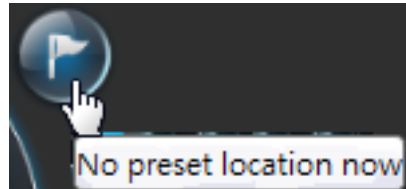

**Pan/Tilt controller:** A mouse hover over the arrow buttons activates the arrow button. Use the buttons to navigate to a preferred location.



**Zoom controller:** The zoom controller buttons only apply to cameras that come with an optical zoom module, such as a speed dome camera.



**Focus controller:** The focus controller buttons apply to cameras that come with focus control over its lens module, such as a speed dome camera.

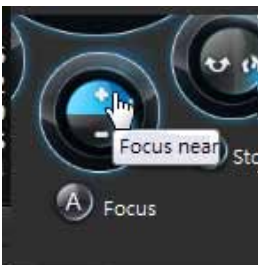

**Auto Focus:** If your camera supports the auto focus function, use this button to acquire an optimal focus point.

**Auto pan/patrol controller:** These buttons provides pan and patrol functions provided that preset locations have been configured on the camera. For a speed dome camera, the pan command tells the camera to continuously pan 360 degrees until it is stopped by a user command. For PZ or PT series cameras, the pan action only takes place once to cover reachable areas.



The **Stop** button ends a pan or patrol tour.

## 4-2-7. Alarm panel

To receive alarms from cameras, you need to configure alarm triggers in the **Settings > Alarm** configuration window (see page 75). Network cameras' digital inputs, digital outputs, or motion detection can all be used to detect conditions in external environments. When the alarms are triggered, you can configure certain kind of actions to take place in response to the alarms, such as:

1. **recording** the immediate image,
2. sending an **Email**,
3. sounding the **buzzer**,
- 4, sending snapshots to an **FTP** server,
5. sending event messages to **web server**,
6. moving camera lens to a **preset** location,
7. triggering a camera **digital output**.

The alarm panel displays the latest 10 alarm entries with the latest alarm on top of the list. The alarm list keeps up to 200 events. Older events will be erased if the number exceeds 200.

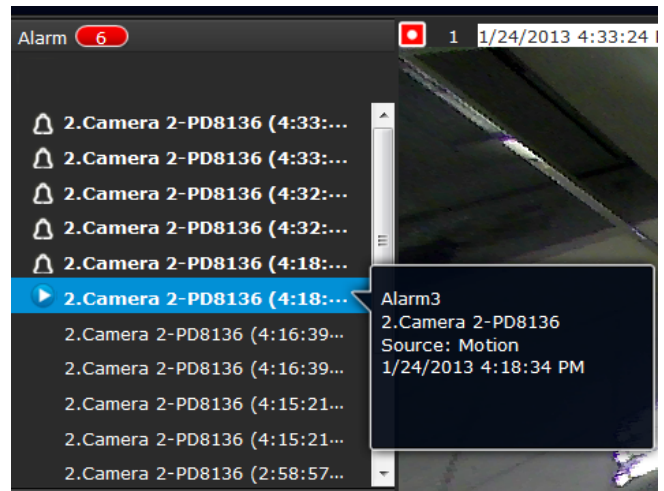

The alarm panel is polled every 10 seconds. A mouse hover on an alarm entry displays full information of the event.

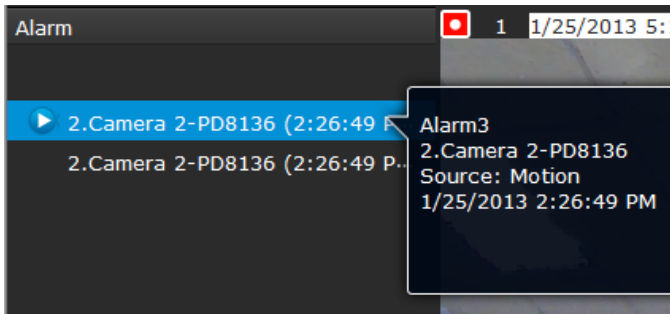

Note that multiple alarms can be triggered by one incident. See page 75 for how to configure the alarm settings.

If an event is configured with a recording action, there will be a play button to the left of the alarm message.

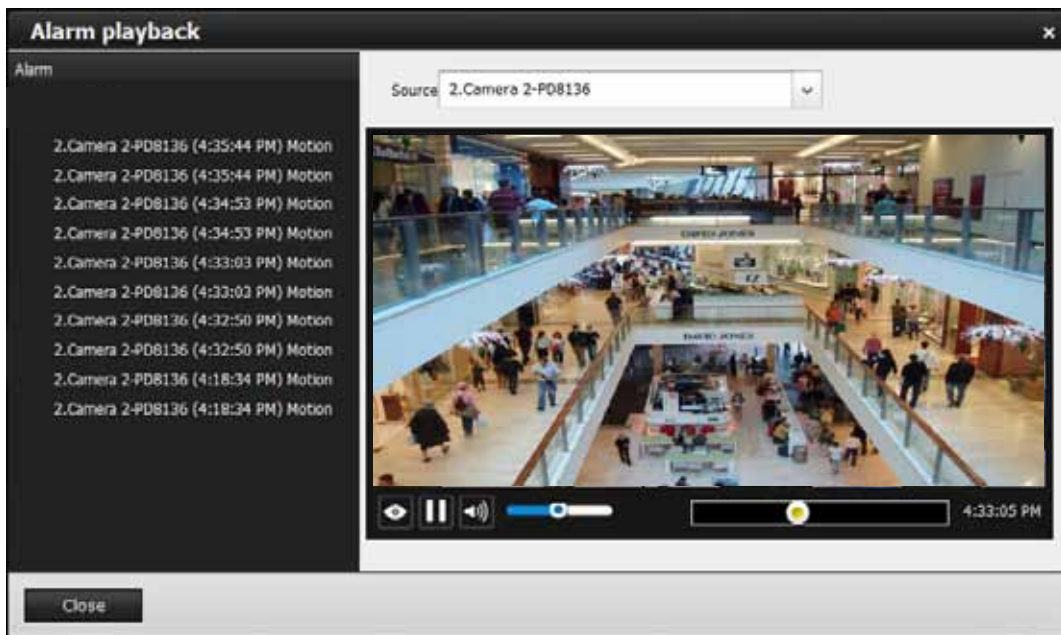

The alarm playback window will begin playback of a footage taken **10 seconds** before the occurrence of an alarm. The playback of an alarm-triggered recording will normally last for **one minute**. If, however, you configured a shorter pre- and post-alarm recording time, your alarm recording may be slightly shorter. The default for **pre-** and **post-alarm** buffer time are 5 seconds and 20 seconds.





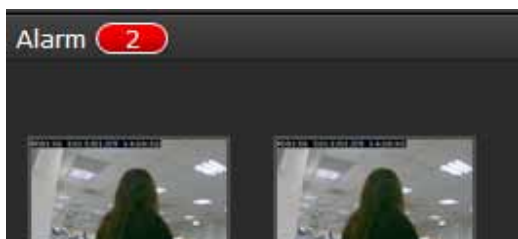

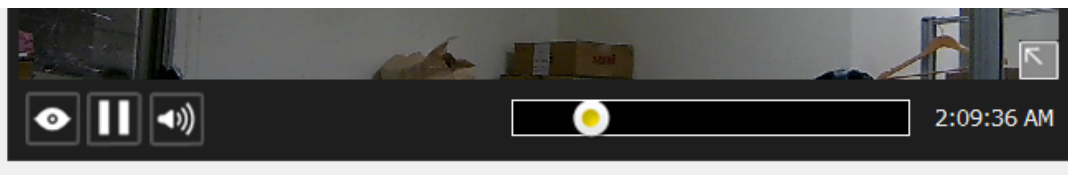
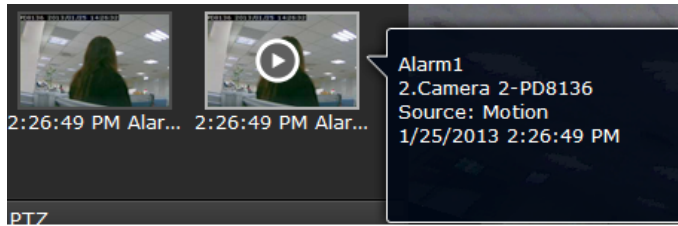

Click and read a text-only alarm will turn off the alarm icon . The alarm icons  indicate unread alarms. The number of unread alarms will be listed on the title bar.



Move your cursor over an alarm with a recorded footage. The Play button will become available.

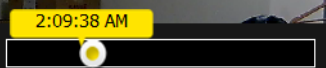

The following buttons are available in the alarm playback window.

Buttons	Description
	View live video: displays the live view streaming instead of the alarm recording.
	Resumes the alarm playback.
	Begins the alarm playback.
	Pauses the current playback.
	Mute or unmute the audio with the current playback. Drag the controller to change the audio volume level.
	Use the playback slider to quickly change the playback position.
	Click to enable the digital zoom function.

## Incoming Alarms

New alarms will be indicated by the messages in bold letters, the alarm bell icons, and the increasing number of unread messages **3** on the title bar.

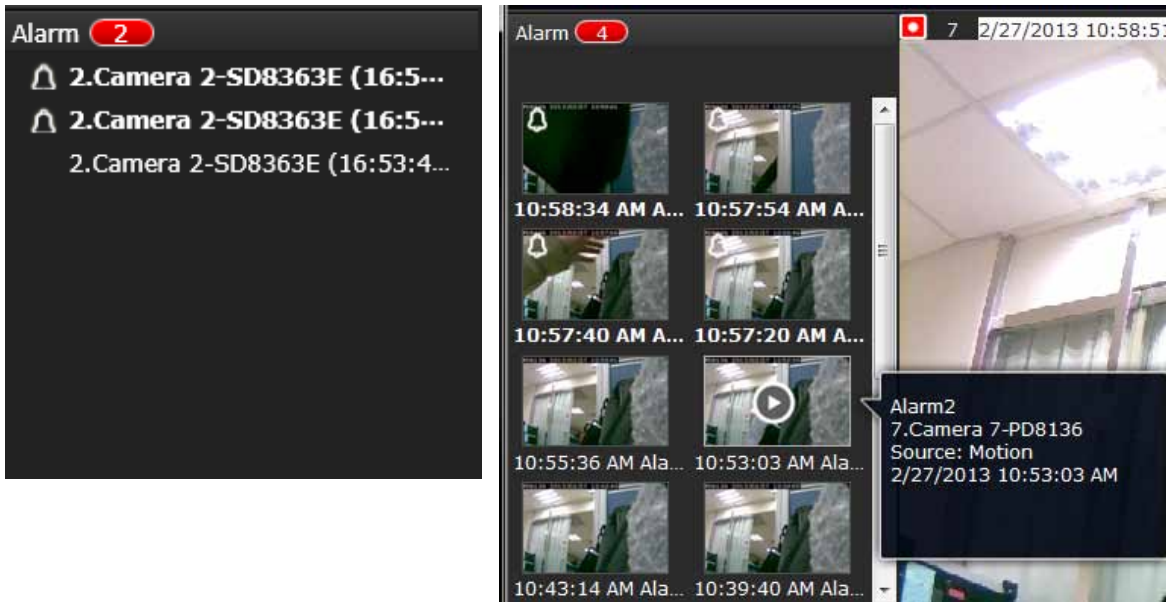

## 4-3. Graphical Layout and Screen Elements - Search recording clips

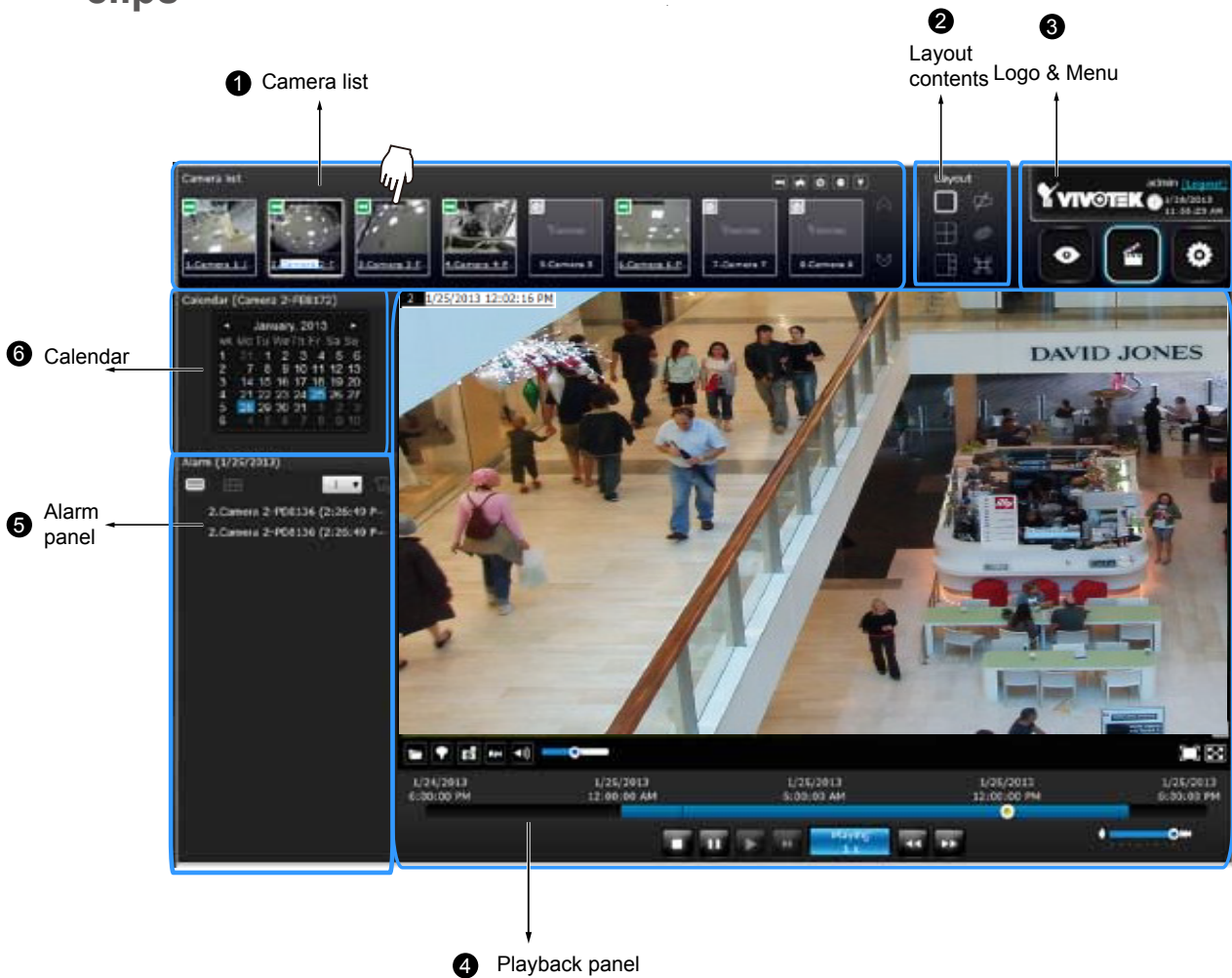

The screen elements of the **Playback** window are described as follows:

Item	Name	Description
1	Camera List	Provides a glimpse of all cameras that have recorded data. Basic information is also provided along with a screenshot.
2	Layout contents	Provides functions to extend, rotate, redo the layout, and the synchronous playback.
3	Logo & Menu	Provides access to the <b>Playback</b> and System <b>Settings</b> utilities, as well as system time and logout function.
4	Playback panel	Displays the playback functions. Snapshot, bookmark, and export functions are also available on individual view cells.
5	Alarm panel	Reports alarms transmitted via cameras' DI connections or those by the Motion Detection, etc.
6	Calendar	Shows when the recording took place, and thus enables users to quickly locate a specific part of recording in history.

### 4-3-1. Camera List Panel

The camera list displays the 8 recruited cameras by the sequential numbering order you configured in the System **Settings** window on page 149. The elements in the Camera list on a **Search recording clips** window are identical to those on a **Liveview** window. Please refer to page 107 for details on the Camera list panel.

There are two key differences between the Camera List on Liveview and that on the Playback window:

1. Users **can not** click and drag a camera thumbnail to a playback view cell.
2. A double-click on a camera **does not** display video in a view cell. A double-click displays a **calendar** where days with recorded videos are shown.

To begin playback and search for past recordings,

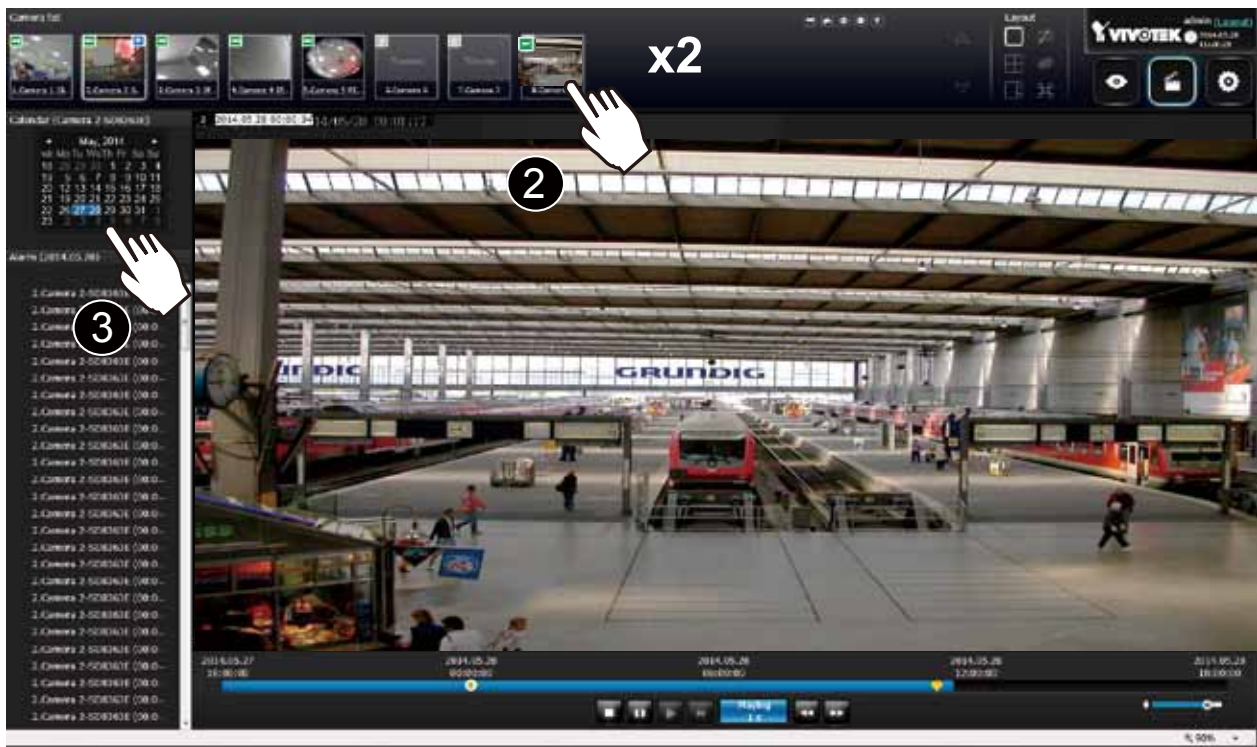

1. Double-click on a camera.
2. The **Calendar** panel will display the days video recording actually took place. And those days will be highlighted by a blue background (as the 25th and 28th in the screen below.)



### 4-3-2. Search Recording Clips Layout

3 types of layouts are provided for the Search recording clips window: 1x1, 2x2, and 1+3.

In the Search recording clips window, users can simultaneously playback up to 4 recorded videos.

	Clears all view cells on the current layout
	Starts or stops the Synchronous playback.
	Full view: extends the view cells on the current layout to the full of the screen.

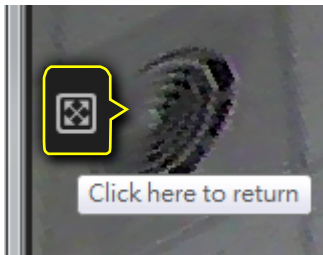

When your current layout is displayed in a full view, move your cursor to the left center of the screen to return to the default Liveview screen. The **Return** button will appear.

### 4-3-3. Logo & Menu

A logout button, system time panel , and 3 hot link buttons to access the **Liveview**, **Playback**, and **Settings** utilities. This panel is identical to that on the Liveview window.















### 4-3-4. View Cells in Search Recording Clips

The view cells in Liveview and Playback windows are similar. Their differences are listed as follows:

1. 3 simple layout types are supported as previously described.
2. The information bar displays camera index and video time information only.
3. The Play and Pause buttons are not available on the Tool bar. One Export function is added on a playback view cell.







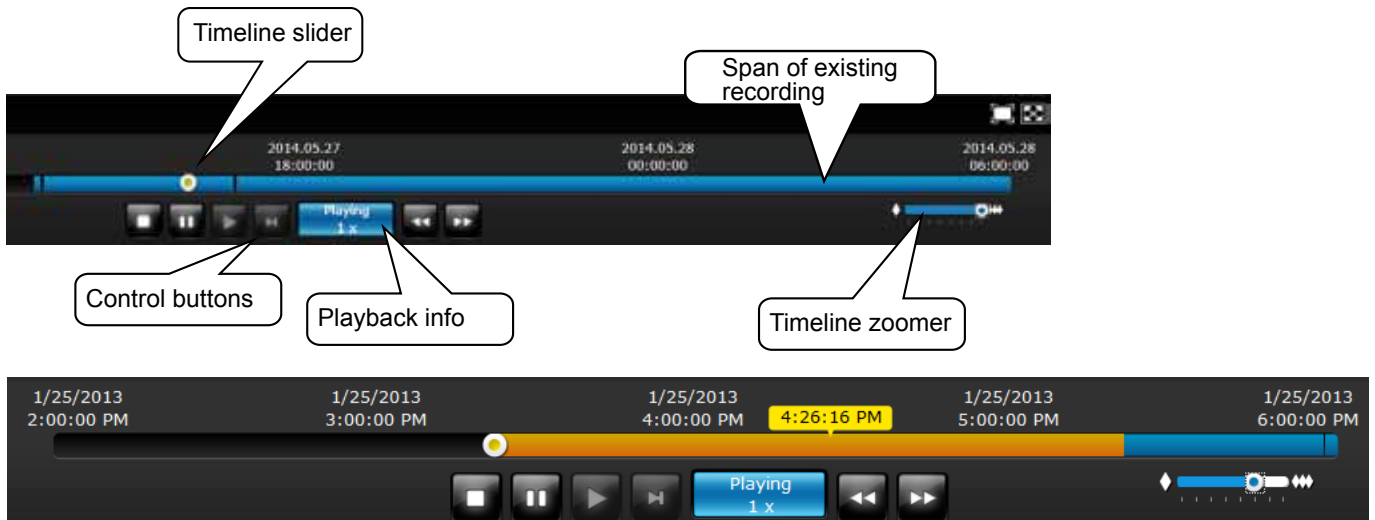

The functional buttons on an individual view cell are described as follows:

Buttons	Description
	Exports a section of the video into a 3GP or Windows exe file. The length of exported video is configurable to 1, 3, 5, or 10 minutes.
	Adds a Bookmark (that saves a short description and a one-minute footage from the current feed)
	Takes a snapshot.
	Removes camera from the view cell.
	Mutes (if there is audio input from the camera.)
	Unmutes
	Restores the view cell's original position on the liveview panel.
	Maximizes the size of current view cell.
	Enables the digital zoom.
	Disables digital zoom (PiP).
	Fisheye viewing modes - if the view cell contains video from a fisheye camera, the fisheye display mode selector will be available: 1O: the original circular view. 1P: the panoramic view. 1R: the regional view.  Please refer to the fisheye camera's User Manual for more information.
	Volume controller

## Search Recording Clips Control Panel

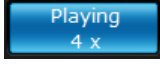

The time slide bar enables quick skimming through the recording. Its functional buttons are described as follows:

Buttons	Description
	Pause
	Play. This button is available after you manually pause a playback.
	Stops the current playback.
	Next frame. After you paused a playback, use this button to browse video frame by frame.
	Speeds down by 1/2. The slowest speed is 1/8.
	Speeds up. Increases the playback speed, to 2x, 4x, 8x, 16x, and then to a maximum of 32x.
	Displays the current playback status, such as Playing, Pause, play speed, or Stop.
	Timeline zoomer. Use the zoomer to zoom in for more precise skimming.
	Timeline slider thumb. Click and drag this thumb button to move along and reach a specific point in time. A click on the time line will also work.

The time line shows the length of existing recording taken on a specific time span. You can use the timeline zoomer to scale down the span of time. For example, if the time span is reduced to 1 hour, then each section on the time line represents 15 minutes of recording. The total time span of a timeline starts from the minimal of 4 minutes, 20 minutes, 40 minutes, 1 hour, and up to a maximum of 24 hours.

In the Synchronous play mode, a change to the zoomer will be reflected by all synchronously playing view cells.

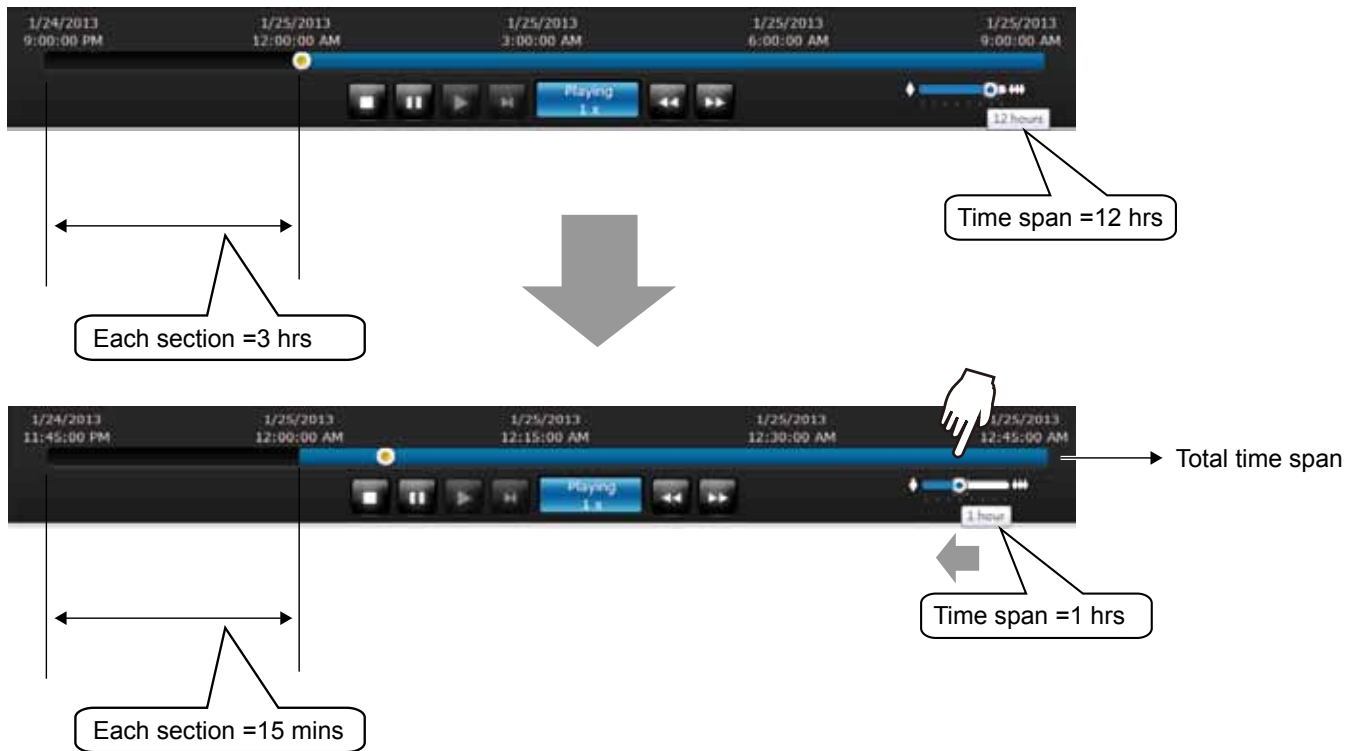

If recordings take place by an event-triggered recording, the intervals between recordings can be down to 1 minute, and the individual recordings will not be easily discernible. In this situation, you can mouse over the timeline to pinpoint individual recording instances.

### 4-3-5. Alarm Panel

The alarm panel displays the alarms or bookmarks recorded by the day of recording. Two additional buttons are available: **Page selector** and **Alarm filter**.

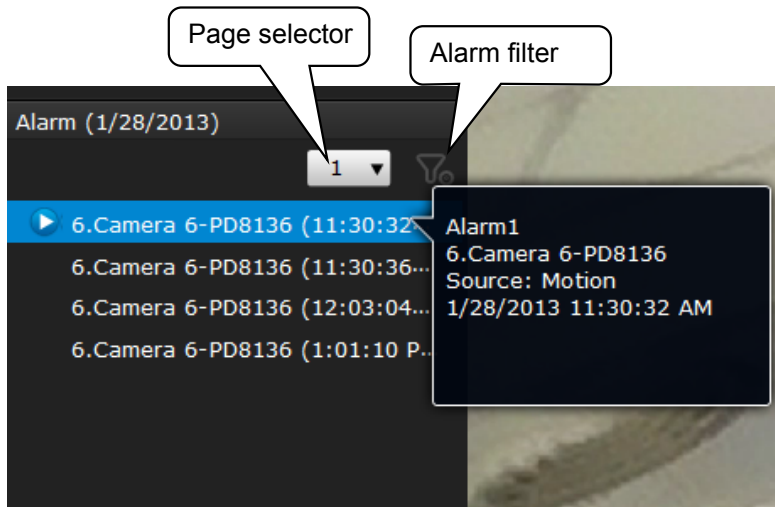

See page 75 for how to configure alarms.

- A playback button will be available with an alarm-triggered recording. The alarm panel in the Playback window also supports the List mode and Icon mode that are similar to that in the Liveview window.
- There can be numerous alarms occurring in a day. Use the page selector to display different pages of alarm entries. Up to 200 entries can appear on one page. Note that the new alarms that occurred seconds or minutes ago may not be instantaneously listed on the page.

If bookmarks are listed in the Alarm list, a bookmark entry will look like this:

[Camera index. camera name \(time\) - bookmark](#)

#### Alarm filter:

Use the alarm filter to find out specific alarms. Use the check circles below to narrow down your search criteria by Alarm name or alarm type by Motion detection, DI, DO, Tampering, PIR, or those manually marked down as Bookmarks.

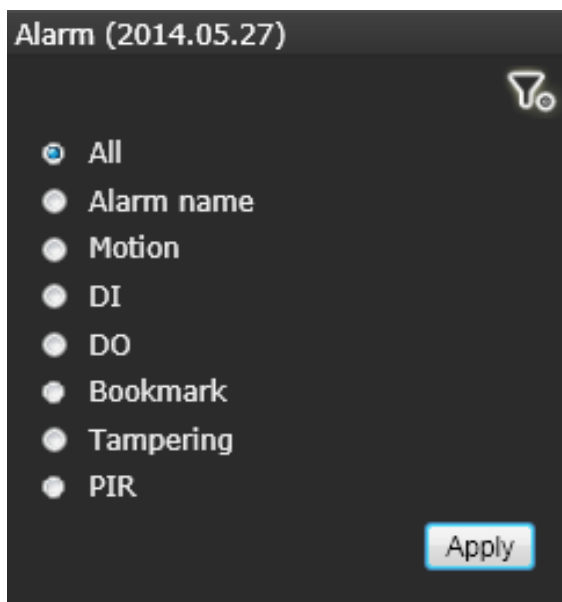

The alarm name is defined by users in the **Settings** > **Alarm** page.

### 4-3-6. Calendar Panel

Double-click on any of the existing cameras to display the Calendar panel. Days with recorded videos will be highlighted in blue regardless of the length of existing recordings that occurred in that day. You may then click on a day to begin viewing the past recordings.

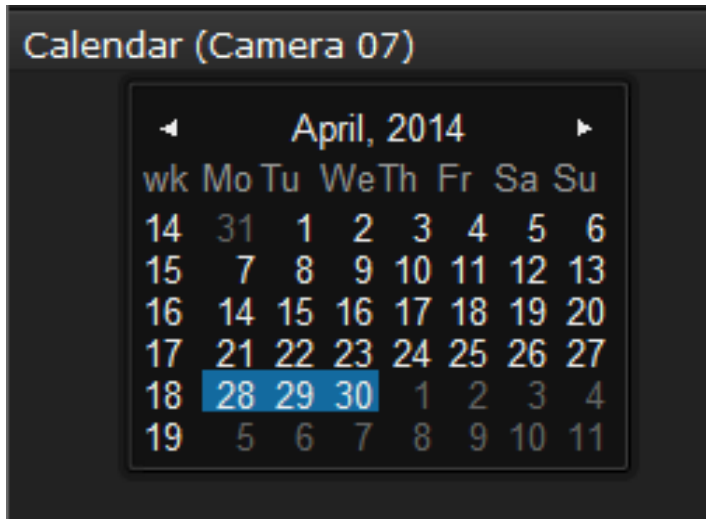

You may use the arrow button to view the records in other months. If there are no recordings in the current month, the recordings taken in the days of the following month will be shown instead.

# Chapter Five System Settings

The Settings window is accessed by clicking on the Settings button on the Logo panel.

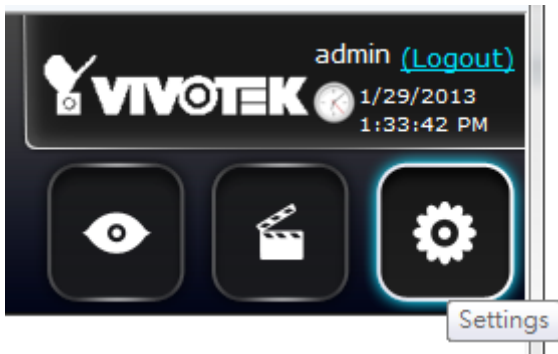

The system will default to the overview page displaying the camera connection and storage statuses. An empty position will be left in blank, and a disconnected camera will be indicated as . The storage volume usage is displayed as the used and unused spaces.

The **Stop Buzzer**, **Reboot**, and **Power-down** buttons are also available on this page. There are critical conditions that can sound the system buzzer, such as a disk failure.

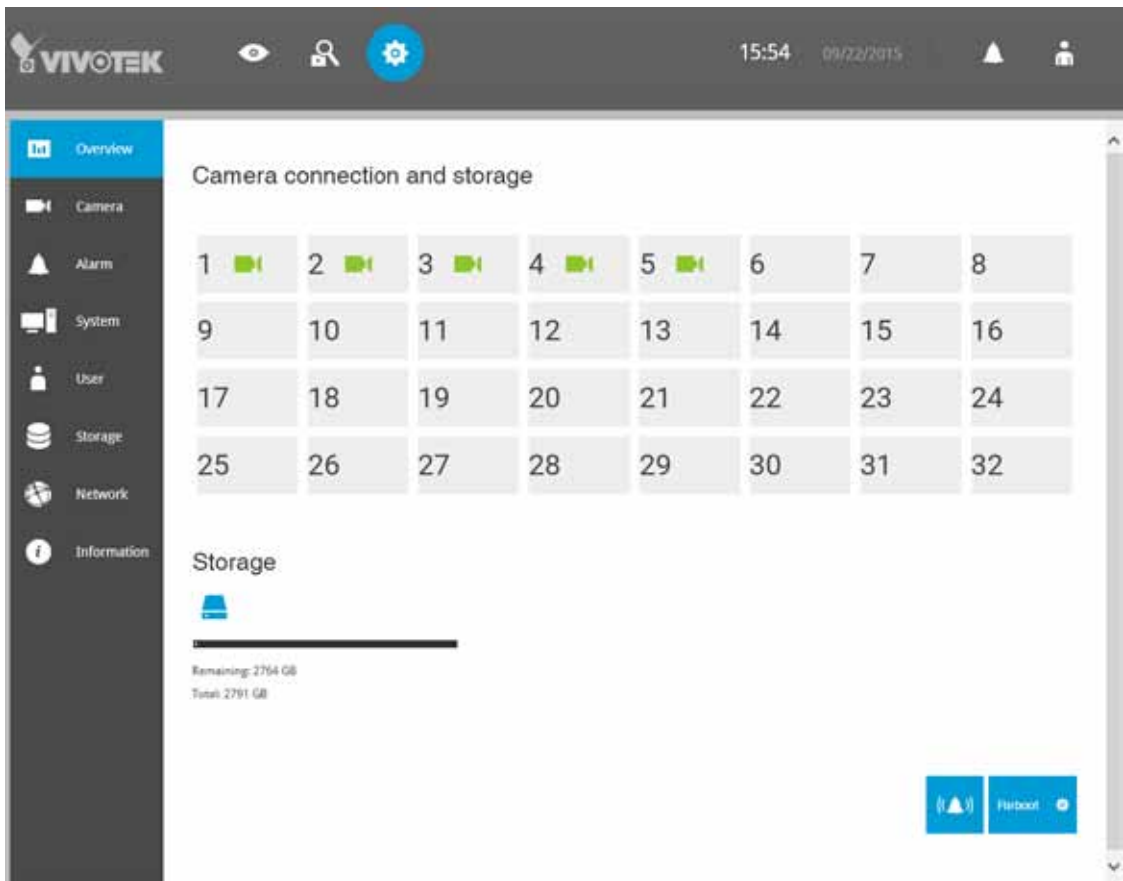

**Notify** - During the configuration process, configuration errors or information will be indicated by a small notify message boxes on the top of the screen.



## 5-1. System

### 5-1-1. Settings - Camera > Management

On the camera Management page, you can configure the following:

1. Recruit or disband cameras.
2. Create a camera name.
3. Assign User name and Password, or apply the credentials to all cameras in your configuration.
4. Change the Network settings.
5. Change the cameras' positions on the layout screen.

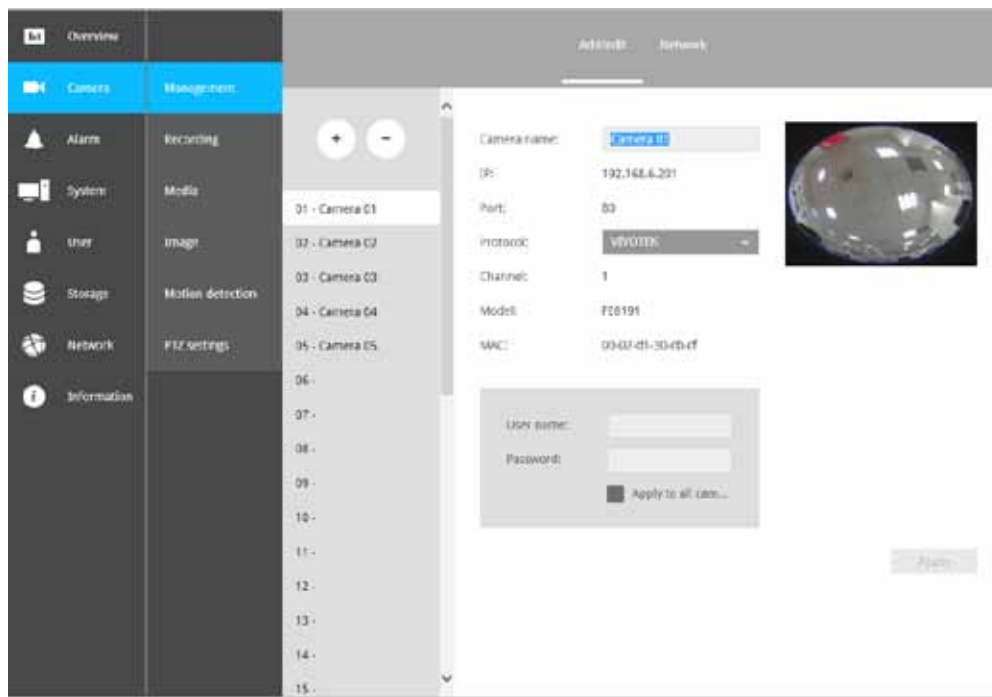

For camera name, you can enter up to 64 alphabetic and numeric characters including [0-9][a-z][A-Z][\_][ ]]. For user name and password, you can enter up to 64 alphabetic and numeric characters including [0-9][a-z][A-Z][!][\$][%][^][\_][.][@]["]['][~].

To recruit cameras:

1. Click on the Add  button. A list of cameras in the same subnet will appear.

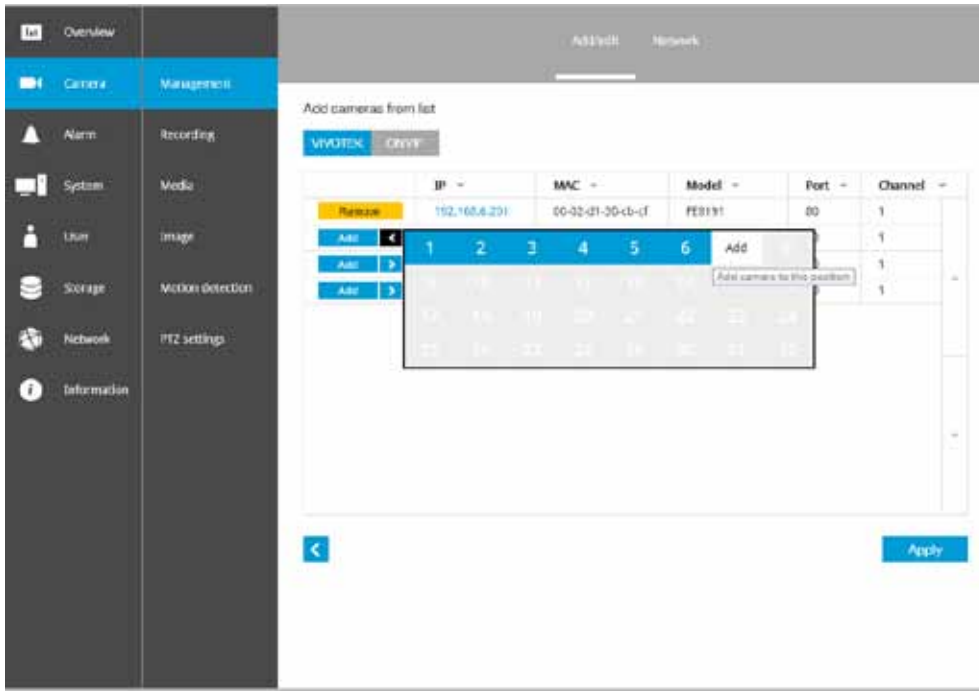



2. Click the **Add** button, the camera will be placed at an unoccupied position. You may also expand the menu on the side of the Add button to select a position number.
3. When a camera is added, it should appear on the graphical placement below.
4. Click the Apply button after you added cameras.
5. You may click the page back button  to return to the previous window.

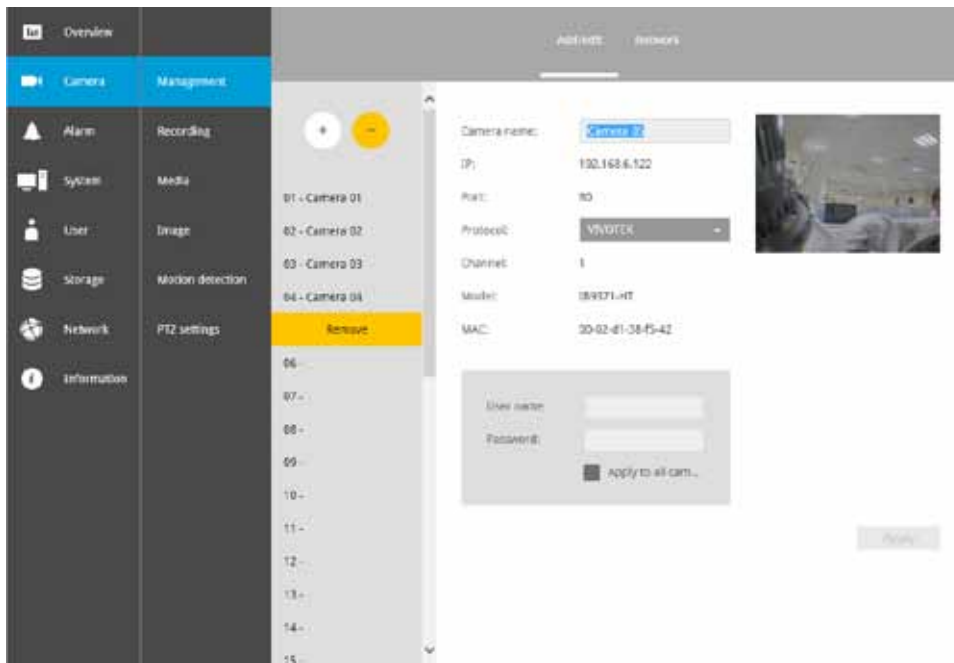

To disband cameras:

1. Click on the Remove  button. A list of cameras will appear.



2. The **Remove** button will turn yellow . Mouse over to the camera you want to remove, and its entry will display the **Remove** message.
3. Click on the Remove message. The camera should then disappear from the camera list. The recording from that camera will also be discontinued.

## Network

On the Network tabbed window, you can configure the network type, IP address, and the connection ports for video streaming.

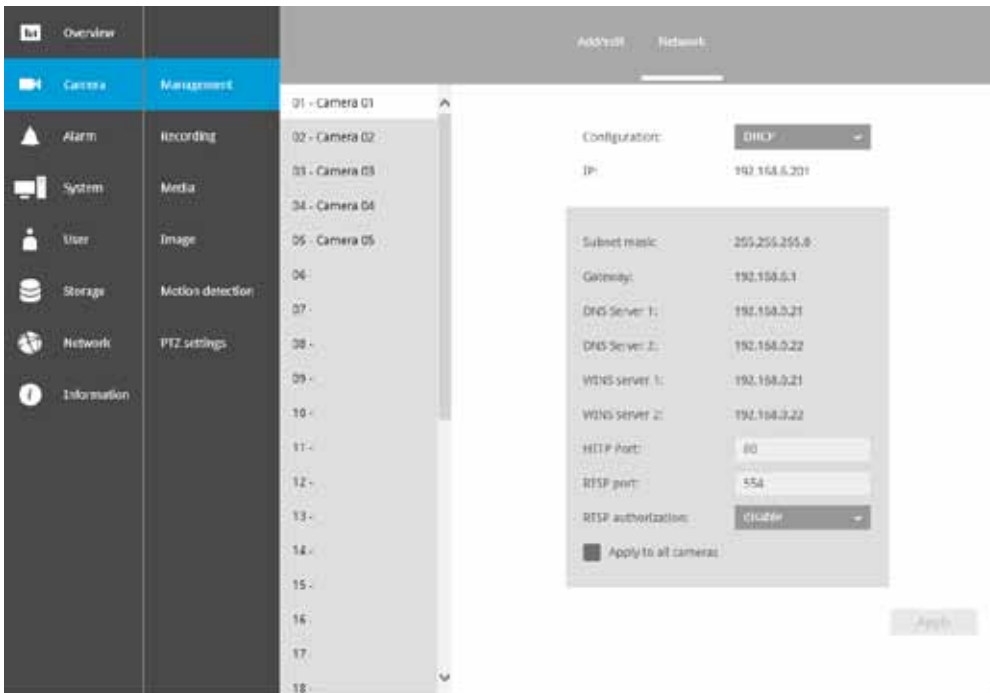

You can select DHCP as the method for cameras to acquire IP addresses, or you can manually configure static IPs for a single or all cameras. Using static IPs is recommended. Although the NVR can remember the MAC addresses of cameras, if IPs are changed under the DHCP configuration, your NVR may still fail to connect the cameras. Please consult your network administrator for details about network settings.

It is usually not necessary to change port numbers for the HTTP and RTSP ports unless there is a conflict in your network environment.

## 5-1-2. Settings - Camera > Recording

### Recording options

On the camera Recording page, you can configure the following:

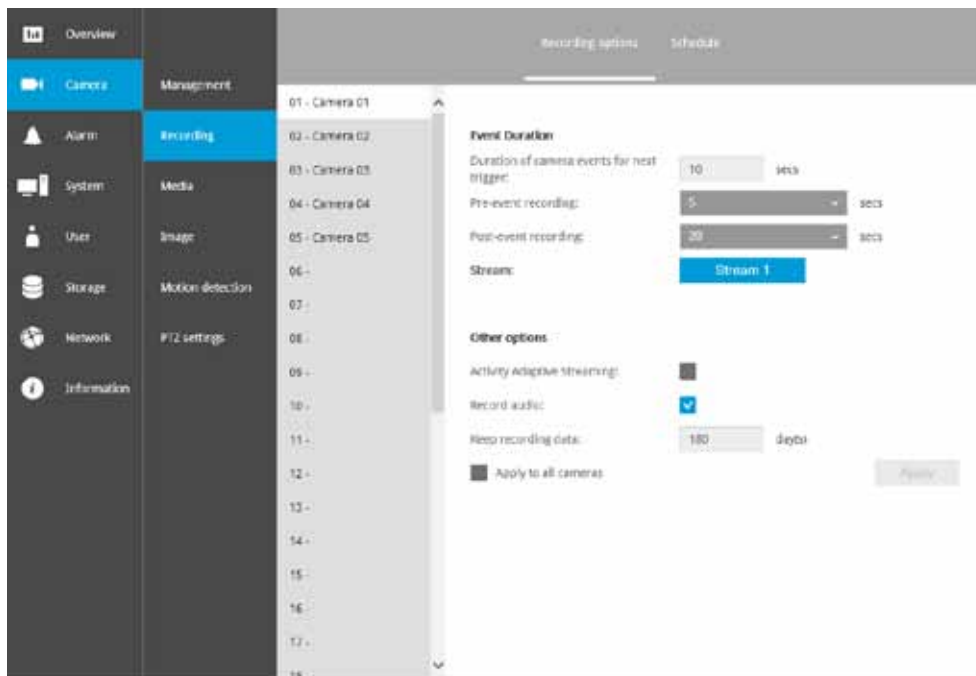

1. Configure the duration of camera events, for the concern that camera can be too frequently triggered.
2. Enter the Pre- and Post-event recording time. The triggering events can be DI, DO, Motion detection, PIR, or Tampering detection.
3. The default recording stream is Stream 1, and the system automatically adjusts the frame rate, resolution, etc. for optimum performance. However, you can still change the streaming characteristics. Note that you can not assign the recording task to other video stream.
4. Enable the Activity Adaptive Streaming feature. This feature records the I-frames only when there are no activities detected. When activities or alarm are triggered, the camera raises the recording stream to the full frame rate. This feature can save tremendous amount of bandwidth.
5. Enable or disable audio recording. Note that audio transmission through HDMI cable is currently not available.
6. Change the life expectancy of the recording data.
7. You can apply a typical configuration to all cameras using the Apply to all cameras checkbox.



You can refer to the User Manuals that come with your network cameras for more discussions of these configurable options.

## Recording Schedule

By default, all video feeds from cameras are recorded at all time. You can modify the recording task using the schedule tool:

1. Click to select a recording condition's checkbox - 1. Continuous recording , Event recording , and 3. Clear  (no recording).
2. Click and drag on the cells on the time table. For example, to stop the recording during a period of time, select the the Clear checkbox and move the cursor across the time table. The minimum unit on the table is half an hour.

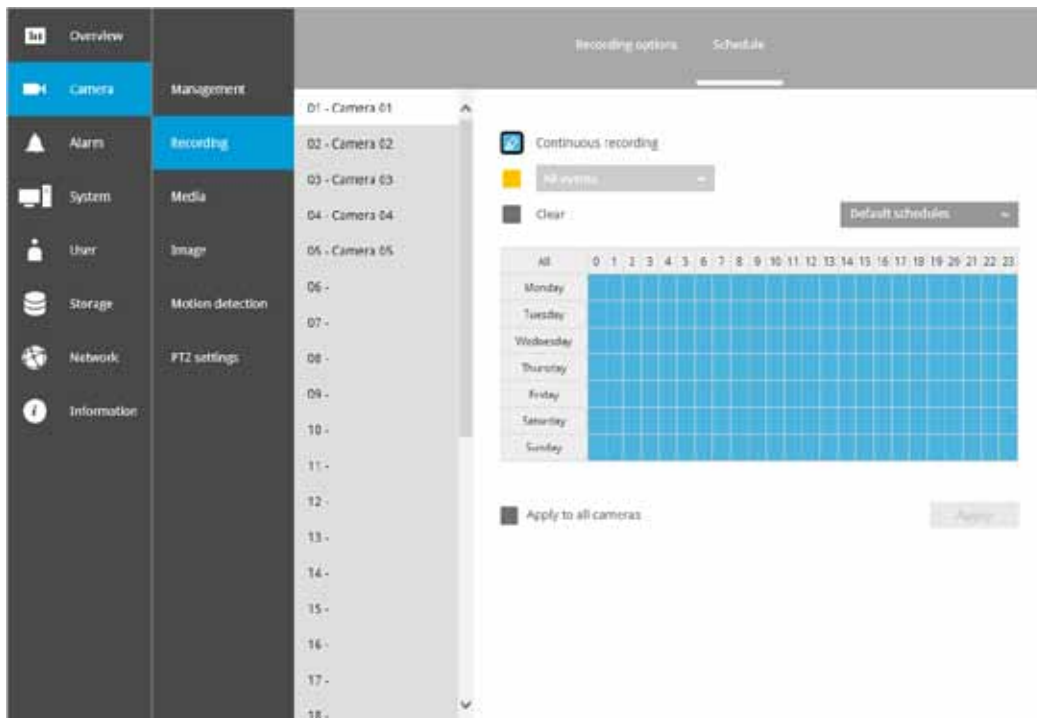

3. You may also use the scheduler tool on the right to facilitate the process. You can select a condition checkbox, and then select the All day, Work hour, Off duty, Working day, Weekend options to apply a time selection.
4. Repeat the process on individual cameras or select the **Apply to all** checkbox if the schedule can apply to all cameras.
5. When done with the configuration, click on the Apply button.

Note that Event-triggered recording and continuous recording can not be take place at the same time.

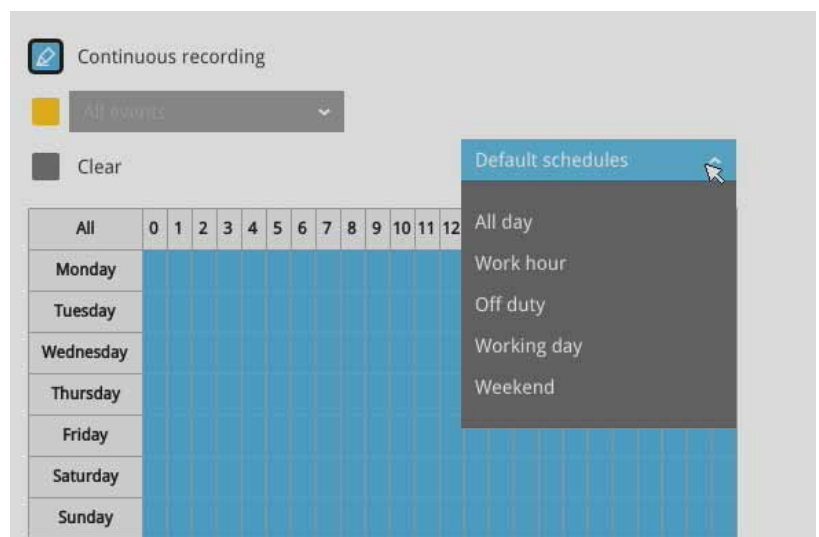

### 5-1-3. Settings - Camera > Media

#### Stream management

The stream here refers to the recording stream, namely, Stream 1. You can use these preset conditions to configure the resolution, image quality, frame rate, and the bandwidth consumption of the recording stream on this window.

Recommended setting	Configuration
Default	Medium resolution; full frame rate
High Quality	Guaranteed video quality set as Good; full frame rate
Economical	Medium to low resolution; frame rate at 5fps
High quality w/ economical	High resolution, Good image quality; frame rate at 5fps

With each recommended configuration applied, the estimated bandwidth consumption value is immediately calculated and displayed at the lower screen.

Click the **Apply** button for the configuration change to take effect.

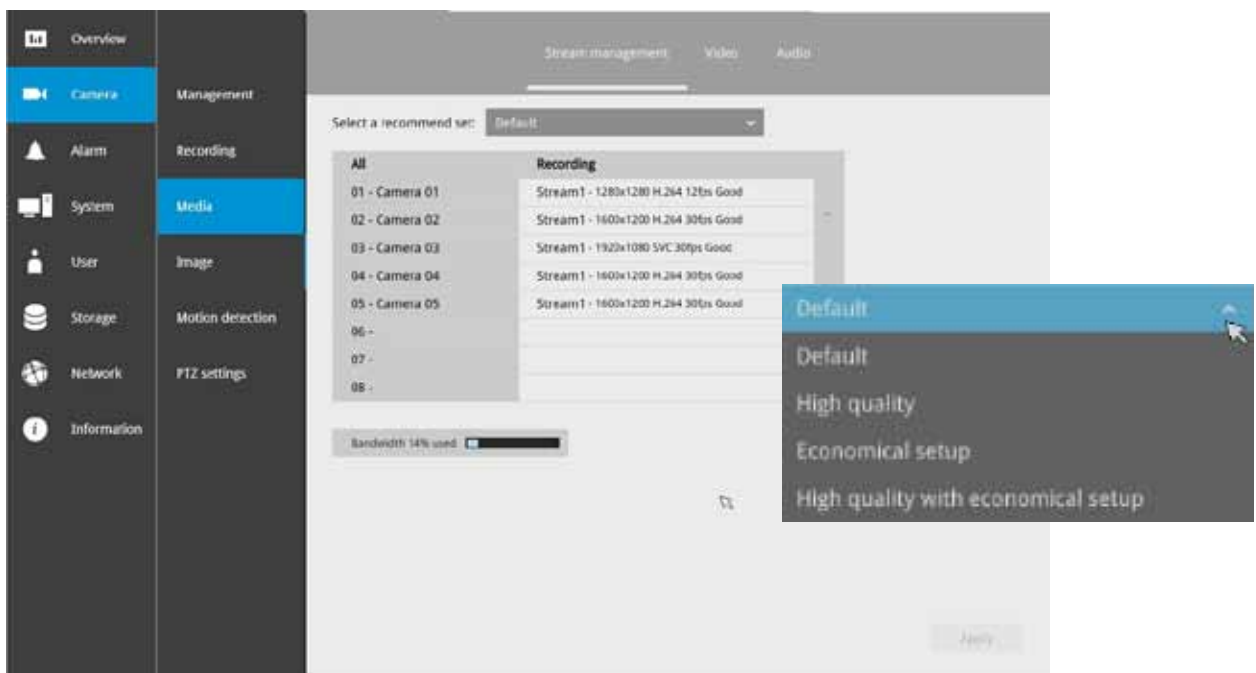

## Video

The Video window allows you to configure all video streams (the no. of stream available can be different for different models). You can configure the following:

1. Codec: video compression codec in H.264, MPEG-4, or MJPEG. Note that MPEG-4 is not supported for Liveview.
2. Frame size: video resolution. Note that due to the limited CPU resources, you may not be able to change the resolution to a very high value, e.g., 5MP in the 1920x1920 resolution.
3. Maximum frame rate: the highest frame rate.
4. Intra frame period: How often an I-frame will be inserted into the video stream.
5. Video quality: You may either select Constant bit rate or Fixed Quality as the defining rules for video transmission:

Constant bit rate	Places a packet size threshold on video frames; This guarantees the frame rate per second performance, yet image quality can be compromised if bandwidth is not sufficient in your network environment.
Fixed Quality	Guaranteed video quality, and to ensure image quality, some frames may be dropped when bandwidth is not sufficient.

When done with the configuration, click the **Apply** button.

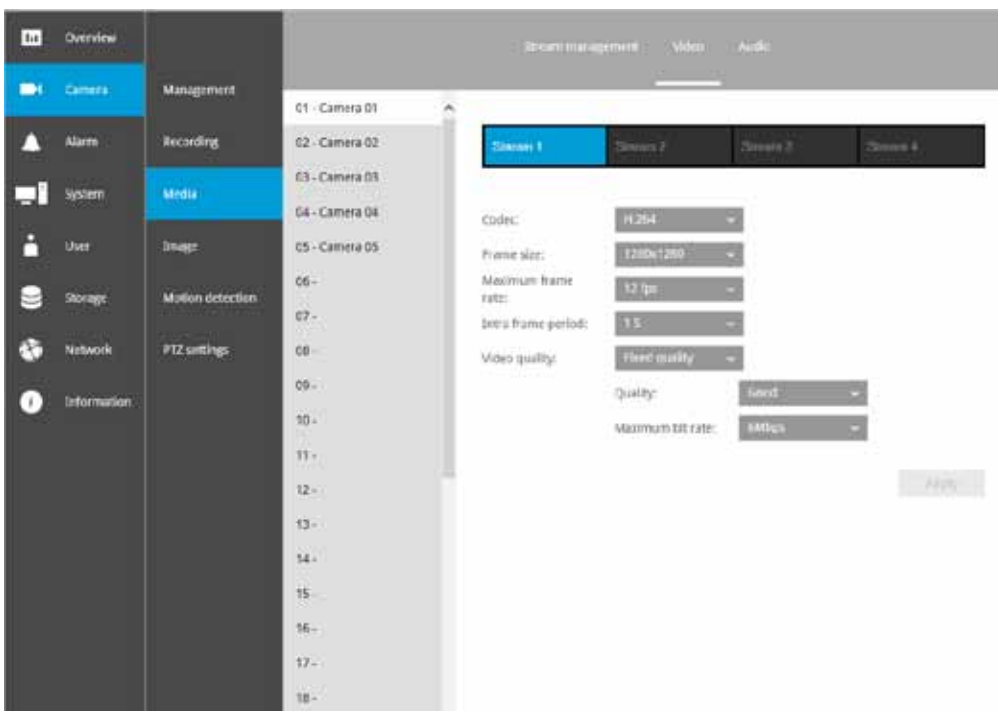

## Audio

The Audio window allows you to configure all audio codec, sampling rate, and Microphone input gains. Depending on design of the camera models, some codecs may not be available. Also, there are cameras that come without embedded microphones.

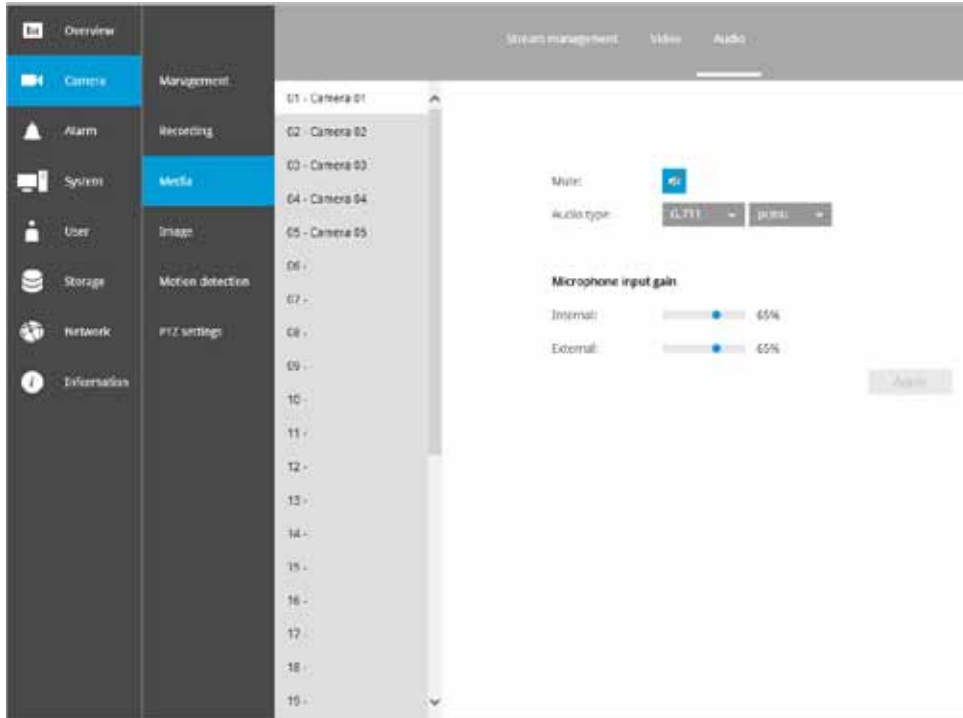

### 5-1-3. Settings - Camera > Image

#### Display

The Display window allows users to tune the image display options:

1. Video name: the video name is displayed on the title bar that is displayed on each view cell. The screen shot below shows a name as "Speed dome."

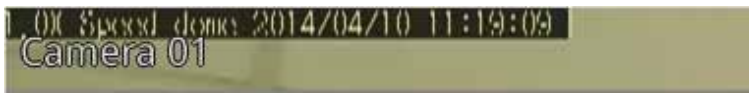

2. Video name and timestamp: Default is enabled. If enabled, the video name and time is displayed on the view cell.
3. Power line frequency: Depending on power line frequency of your country, select a matching option, NTSC 60Hz or PAL 50Hz, to avoid image flickering due to unmatched electricity.
4. Video orientation: select these options if the image from camera needs to be vertically or horizontally flipped.
5. Click Restore to poll for the original settings or click the Apply button to finish the process.

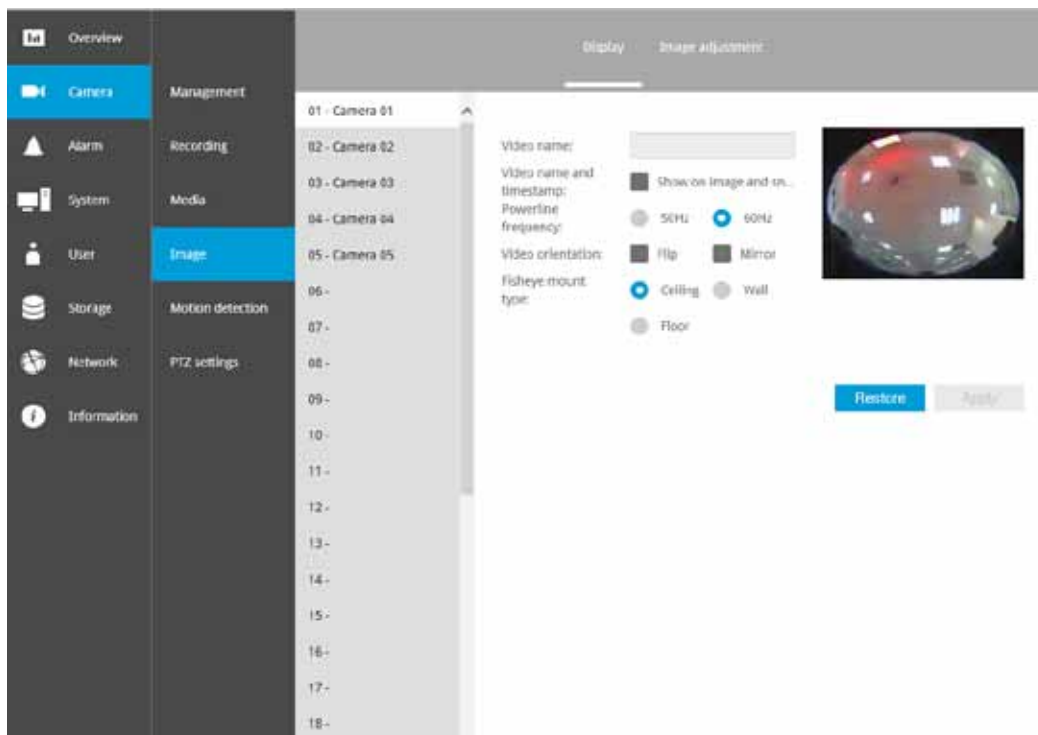



## Image adjustment

The Image adjustment window allows users to tune the basics about image display options:

1. Color: Select to display image as color or black and white.
2. Brightness.
3. Saturation.
4. Contrast.
5. Sharpness.
6. High TV line, Gamma curve, low light compensation, etc. The rest of the options depend on the lens and image sensor type of each individual camera. Therefore, the options here can vary. For unique options coming with each individual camera, please refer to their User Manuals for more information.

Click Restore to poll for the original settings or click the **Apply** button to finish the process. For features common among cameras, you may select the **Apply to all cameras** checkbox.

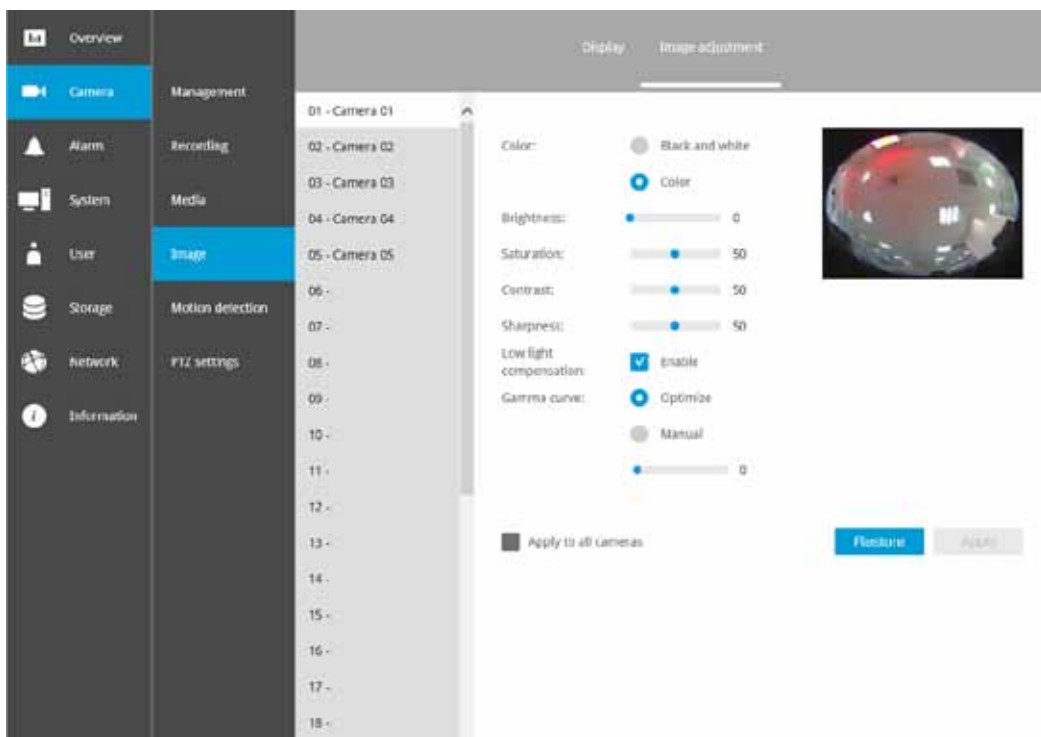

## 5-1-4. Settings - Camera > Motion Detection

### Motion Detection

To set up a detection window:

1. Select a camera by a single click.
2. Use the PTZ panel to move to a field of view where you want to place a detection window.
3. Click and drag to draw a rectangular detection window.
4. Pull the detection area level up to a preferred position. An object must be larger than the detection area to trigger an alarm.
5. Select a Sensitivity level using the slide bar.
6. Click the **Apply** button for the configuration to take effect.

The sample screen shows a connection with a speed dome camera.

If you already configured Preset positions, expand its menu and click on the presets to move to a position.

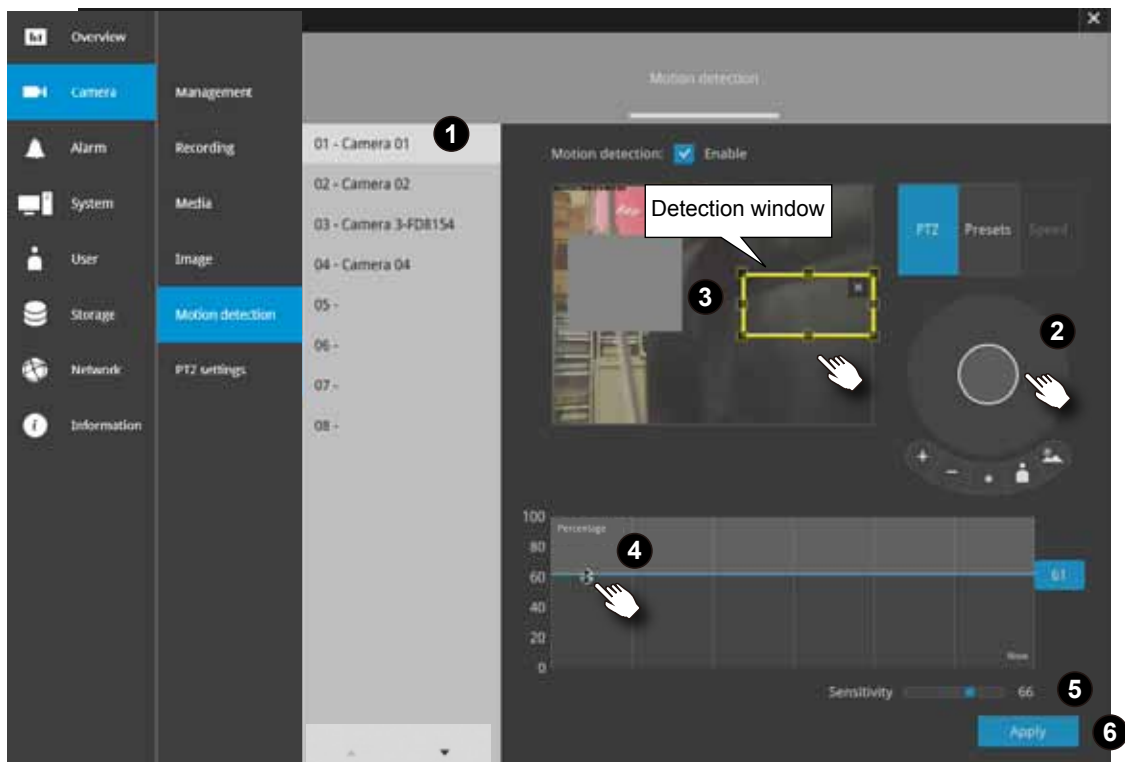

## 5-1-5. Settings - Camera - PTZ settings

To configure PTZ preset positions:

1. Select a PTZ camera by a single click.
2. Use the PTZ panel to move to a field of view where you want to designate as a preset position.
3. Click the add button, and enter a name for the position. Press Enter to proceed.  
Repeat the configuration to create more positions.
4. Click the **Apply** button for the configuration to take effect.

Note that the PTZ panel can vary with different PTZ cameras.

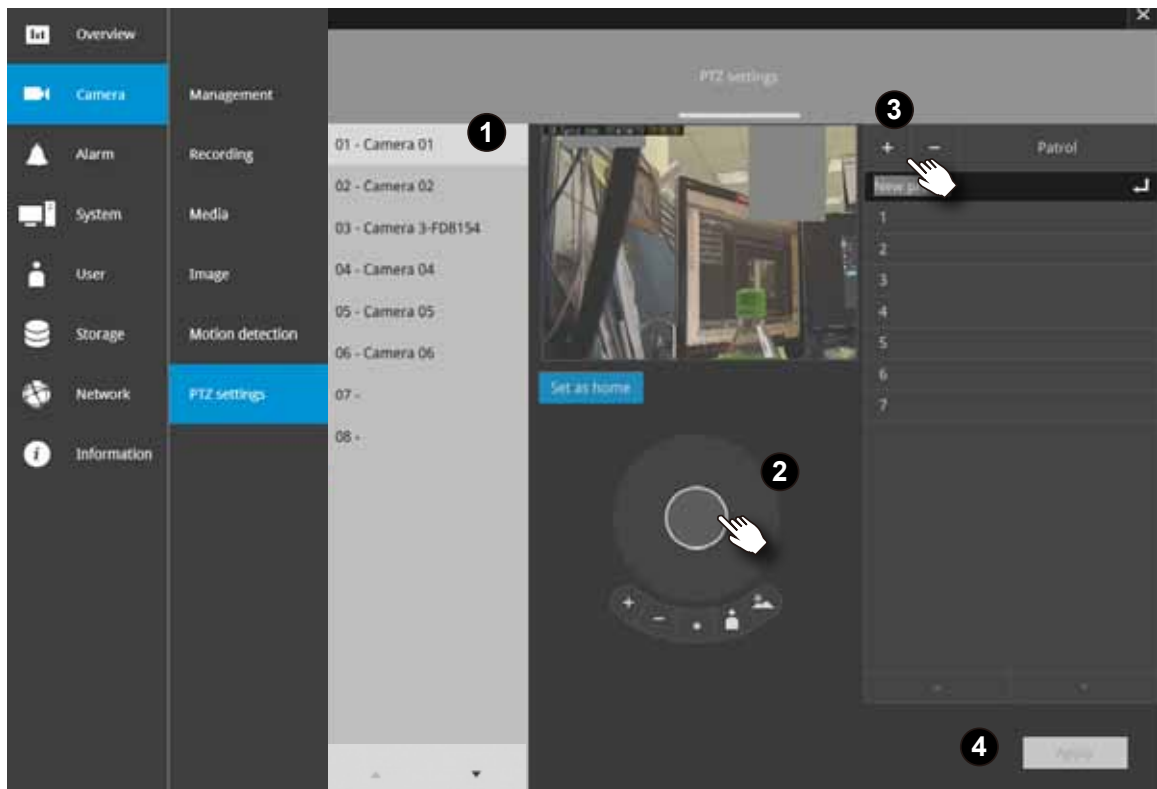

To configure a patrol:

1. Click to enter the Patrol menu. Select a preset position if you want to change its position on the patrolling order.
2. Click the up and down buttons to change the position on the order, or click the remove button to disband a position from the order. You can also change the interval to stay before moving from one position to the next position.
3. You may then click on the Preview patrol button to see if it runs as expected.
4. Click the **Apply** button for the configuration to take effect.
5. Click on the Back to preset list button to return to the preset window.

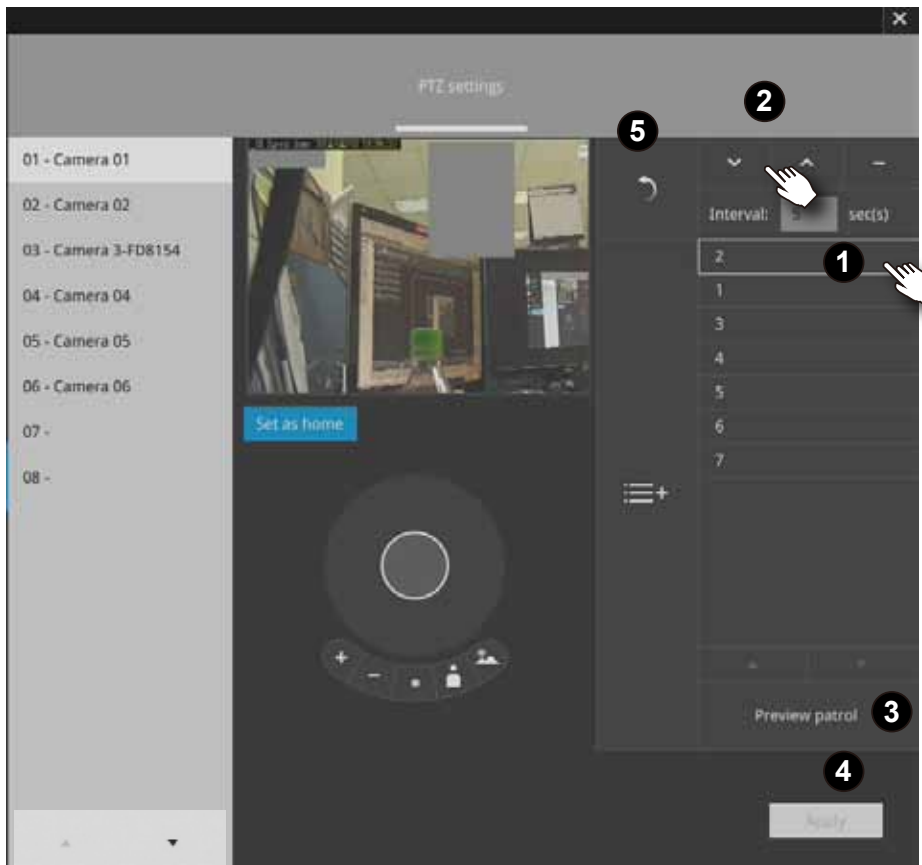

Fisheye camera has its unique options such as the mount types.

Please refer to page 117 or the camera's User Manual for fisheye display mode options.

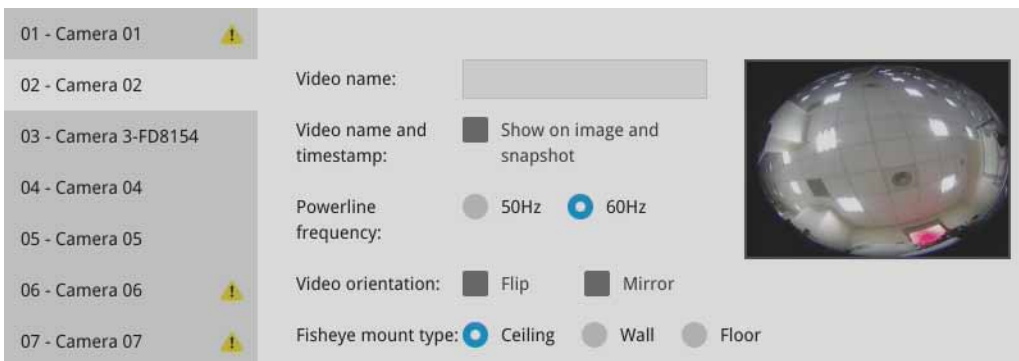

### 5-2-1. Settings - Alarm - Alarm

The events reported from individual cameras' digital inputs, digital outputs, and motion detection can be accommodated in the NVR system's alarm settings. These events will then be reported or trigger corresponding actions as follows:

1. Reporting events via Email or system buzzer.
2. Triggering video snapshot and text message by the occurrences of events to an FTP site.
3. Triggering the camera(s) for its lens to move to a preset position.
4. Triggering the cameras' digital output.

You can create up to 10 instances of alarm.

Hardware connections to DIs or DOs, e.g., window sensors, should be made separately. The motion detection configuration can be made in the Camera configuration window.

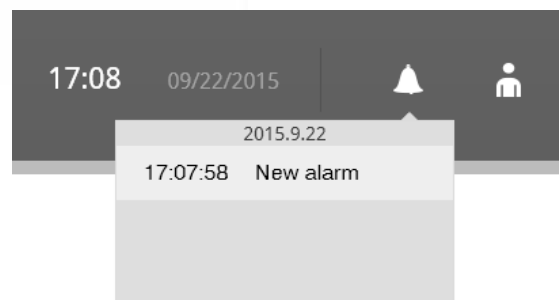
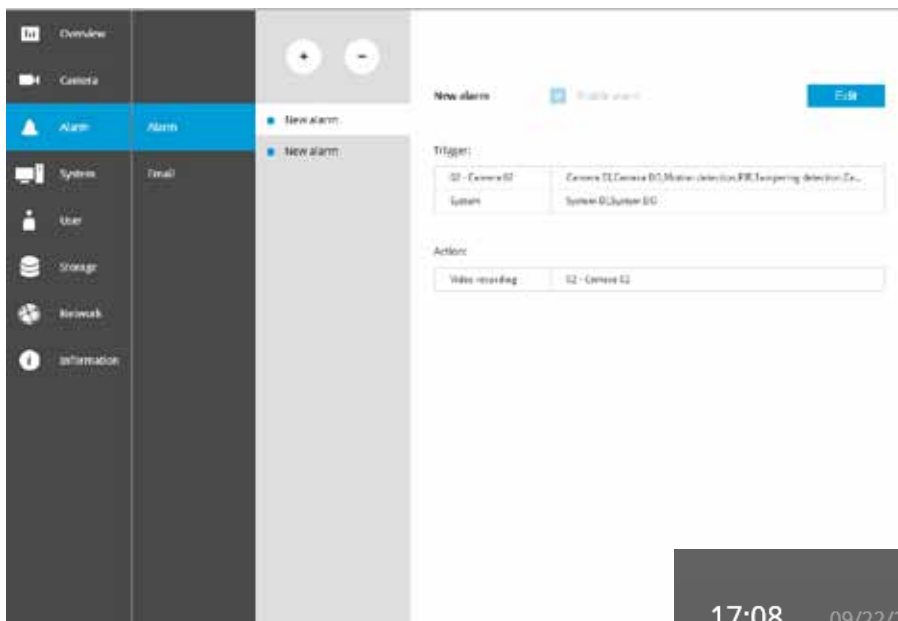

When an alarm is triggered, a message prompt will appear on the Liveview or any configuration window.

Below is a glimpse of alarm sources and alarm actions:

Sources		Actions	
DI	▶	Video recording	▶ video footage
DO		Email	▶ snapshots
Motion detection		Buzzer	
Network failure		FTP	▶ snapshots
Disk full		Camera preset points	▶ Pan-Tilt-Zoom
Disk failure			
PIR		Camera DO	
Tampering			

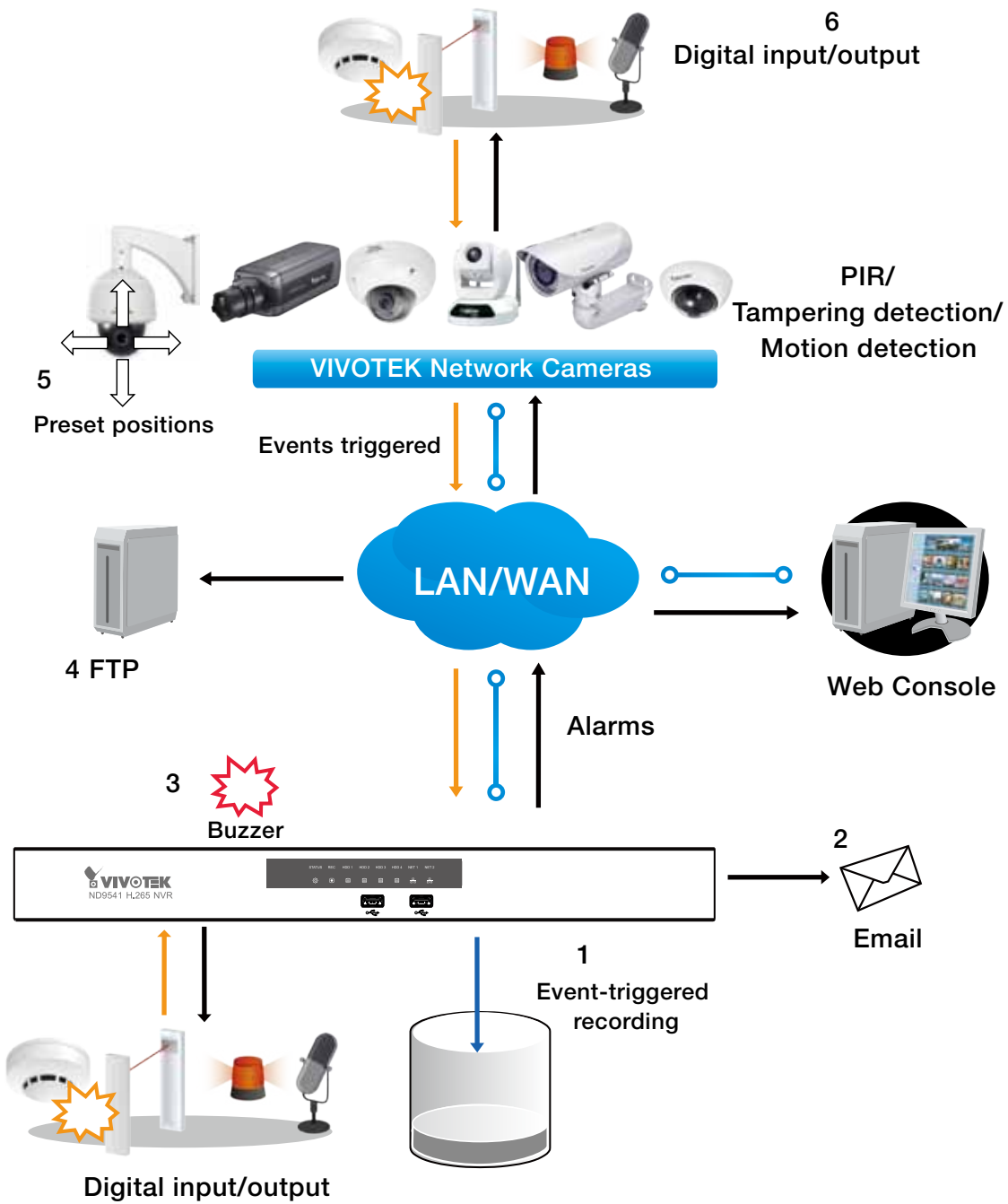

To create an alarm,

1. Click on the **Add** button .

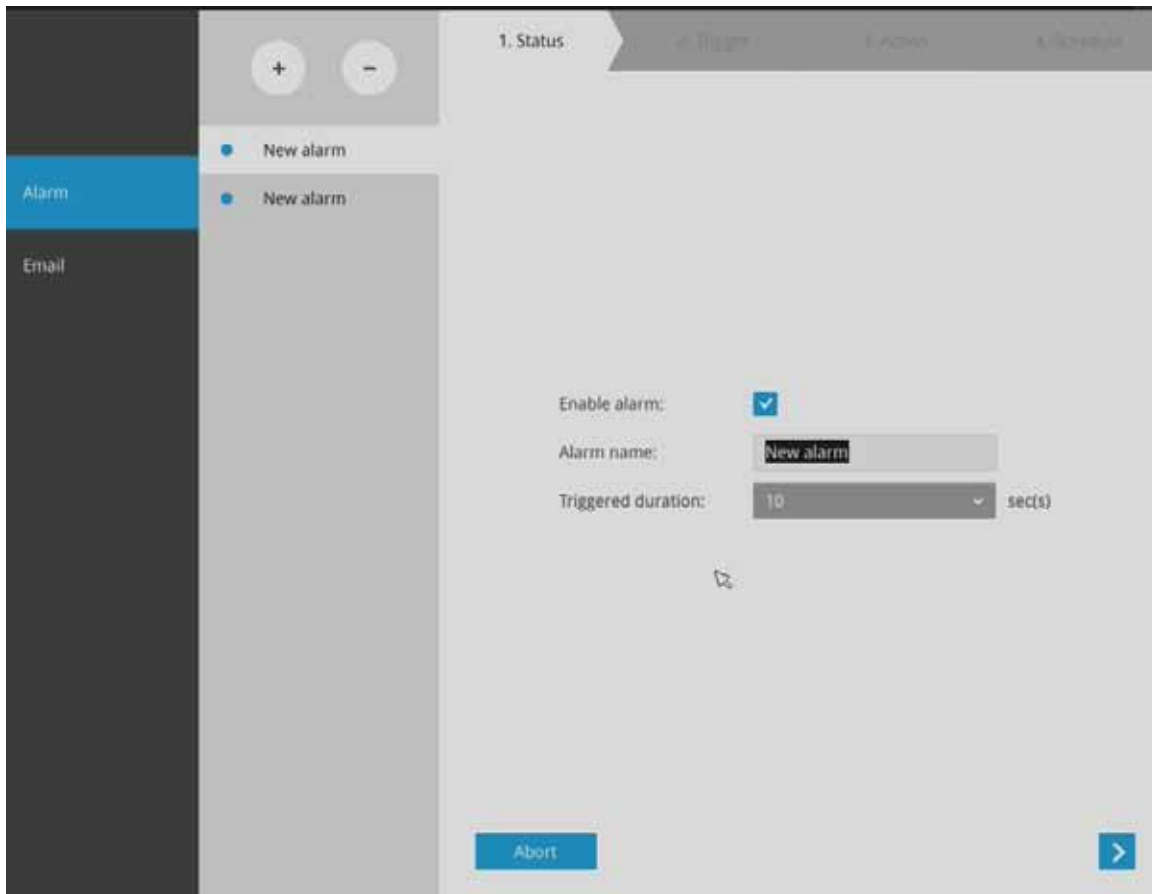

You can manually enter a name for the current setting. You can enter up to 16 numeric or alphabetic characters for the name, including symbols such as [0-9][a-z][A-Z][\_][ ]. You can also designate the interval between one alarm and the next triggered alarm to avoid the situation that the alarms can be too frequently triggered.

Click on the next button  to proceed.

Please note that on a fisheye camera's Motion window, you can click and move the corner marks of a window to change its shape. The Motion window does not have to be a square.

3. On the **Trigger** window, select system triggering conditions, or one or more cameras by selecting their checkboxes. The number of DI or DOs on each camera is automatically detected and displayed through individual checkboxes. The **Motion detection** function, if there are many detection windows configured on a camera, is all triggered by one checkbox.

Note that the triggering sources will be listed even if the camera is currently not connected.

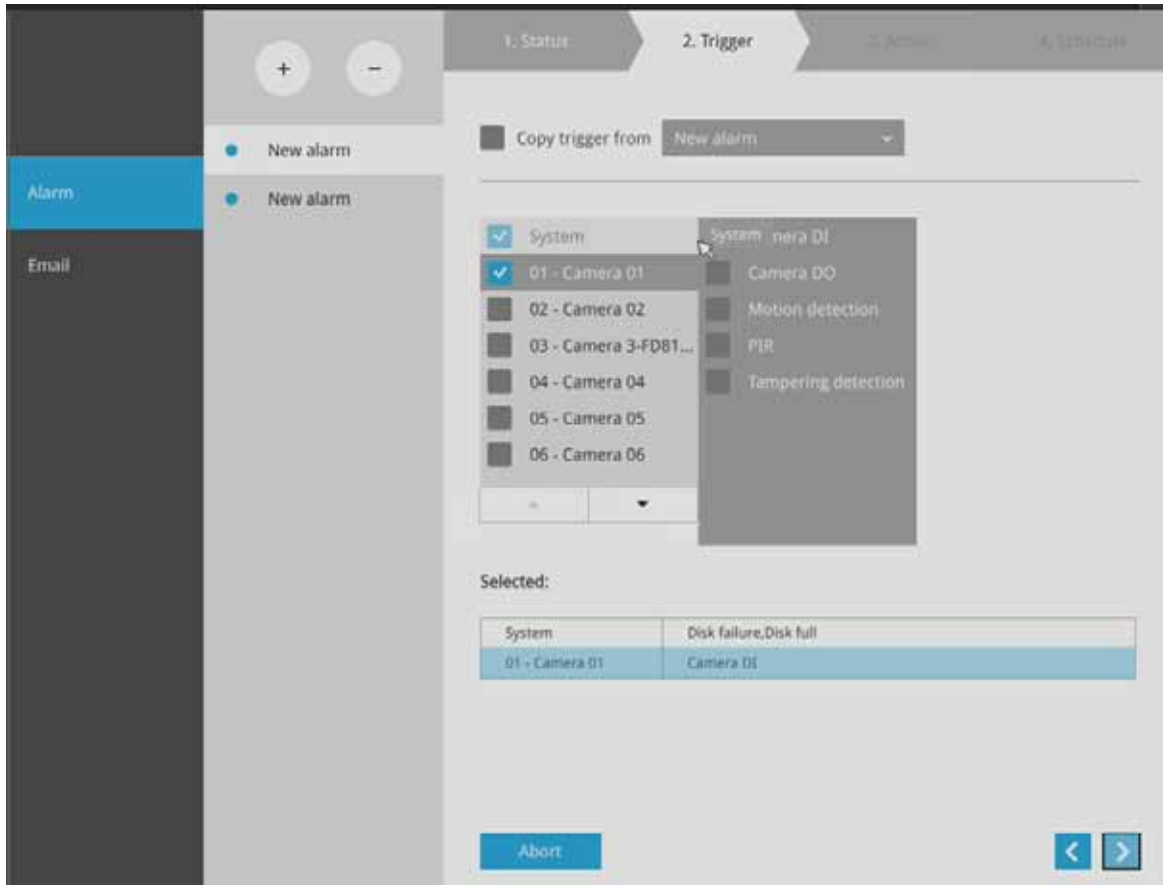

You may also select the "Copy trigger from" menu to borrow the setting you previously configured.

Click on the next button  to proceed.



4. On the **Action** window, you can select the Action type from a drop-down menu. The configuration details of each action type is discussion below.

4-1. **Recording** - When an event is triggered, the selected camera will record a video footage of the length defined by the pre-/post-event setting, to the NVR system.

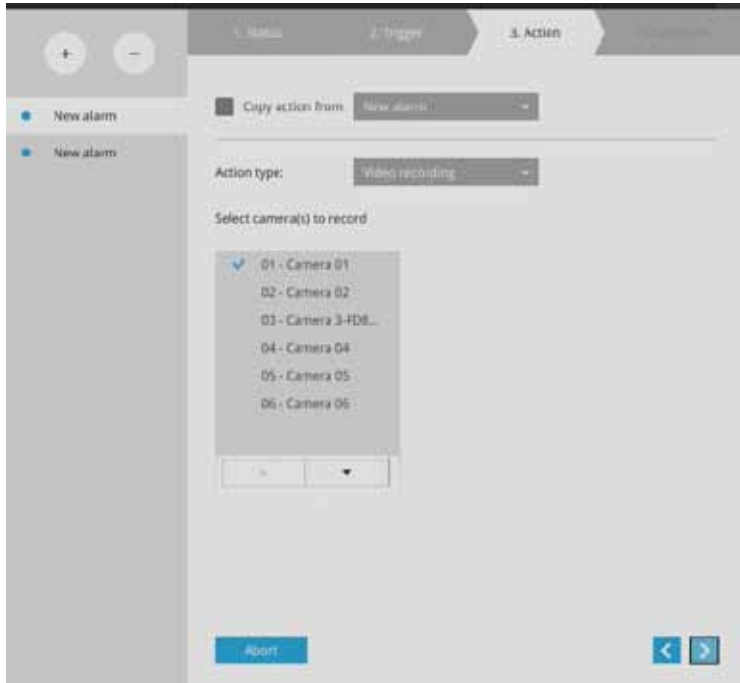

4-2. **Email** - The Email action sends an Email to the administrator along with a snapshot of the event.

To configure Email notification, enter valid Email addresses as the Sender and Recipient addresses, an Email subject, and the SMTP server address through which the Email will be delivered. If you need to log in to SMTP server to deliver an Email, enter the User name and password for access to that account.

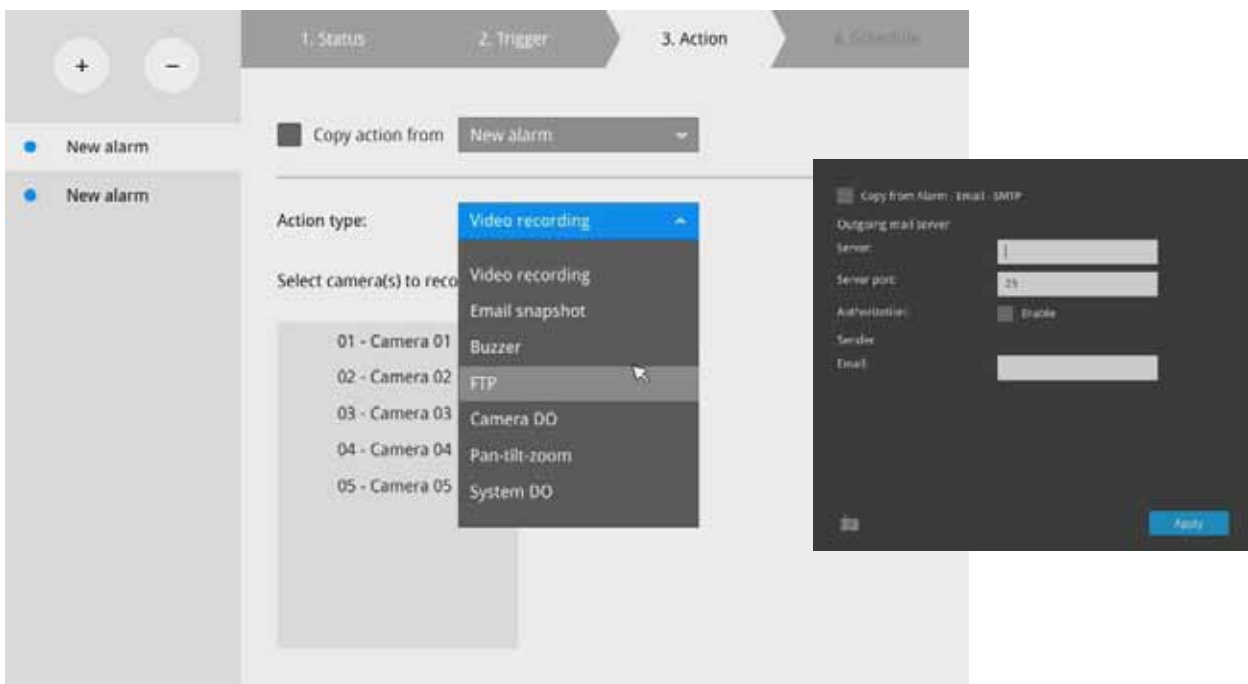

The Email subject and addresses can be composed of 254 characters in numeric or alphabetic characters including: [0-9][a-z][A-Z][\_][ ][-].[,][@]. You can enter the addresses of multiple recipients. Use semicolons, (;), to separate the addresses of multiple recipients.

- 4-3. **Buzzer** - The buzzer is sounded on the occurrence of the event. The buzzer tones are categorized into: **Critical** (1 long, 1 sec interval) **Major** (1 long 2 shorts, 1 sec interval), **Normal** (3 shorts, 2 sec interval), **Minor** (2 shorts, 2 sec interval), and **Notify** (2 very shorts) depending on the importance of an event. Select a Buzzer modulation from the drop-down list. A long tone has a duration of 1 second, while a short tone 0.5 second. A very short tone lasts only for 0.1 second.

Select how many times the buzzer tones will be repeated on the occurrence of an event.

The screenshot displays a configuration window with four tabs: 1. Status, 2. Trigger, 3. Action, and 4. Schedule. The 'Action' tab is active. It contains a 'Copy action from' dropdown menu set to 'New alarm'. Below this, there are three dropdown menus: 'Action type' set to 'Buzzer', 'Buzzer severity' set to 'Normal', and 'Repeat times' set to '10'. A mouse cursor is visible over the 'Repeat times' dropdown.

If events of different importance are issued at the same time, e.g., one major and one minor event, system will ignore the minor event and sound the buzzer tone for the major event only. The buzzer can be sounded either by the Alarm actions or the system events. If Alarm actions and system service events occur at the time, Alarm actions have the higher priority.

If multiple Alarm actions occur, the currently-sounded events can be depleted by the new event.

There are conditions that the system will sound the buzzer, and the conditions are not configurable.

1. Disk failure - missing drives or SMART detected failures.
2. Disk full - the free space is too small for recording tasks.

- 4-4. **FTP** - Snapshots from specified cameras can be uploaded to an FTP site on the occurrence of an event. Enter the FTP site address in the dotted-decimal notation, e.g., 159.22.151.20. Enter the login name and password for the user account. You can enter a directory name you prefer on the FTP site. The server port default is 21, a different number between 1025 and 65535 can also be assigned.

The snapshot thus delivered has a size of 320x240 pixels.

If authentication is not applied, login will proceed using the [anonymous] account. The file names of the snapshot jpeg files will look like this:

[MAC]\_[DATE]\_[TIME]\_[CAMERA\_INDEX].jpg - If similar files already exist, an additional index number will be added to the end of file name.

The screenshot shows a configuration interface with four tabs: 1. Status, 2. Trigger, 3. Action, and 4. Schedule. The 'Action' tab is active. At the top, there is a 'Copy action from' dropdown menu set to 'New alarm'. Below this, the 'Action type' is set to 'FTP'. The interface is divided into two columns: 'Select camera(s) to snapshot' and 'FTP setup'. Under 'Select camera(s) to snapshot', a list of cameras is shown: 01 - Camera 01 (checked), 02 - Camera 02, 03 - Camera 3-FD8..., 04 - Camera 04, 05 - Camera 05, and 06 - Camera 06. Under 'FTP setup', there are fields for 'FTP Server:', 'Port:' (set to 21), 'Authorization:' (checked 'Enable'), and 'Upload folder:' (set to /). A blue button labeled 'Upload test file' is located at the bottom right of the form.

4-5. **Camera DO** - A triggered alarm triggers a camera's DO, e.g., an alarm siren.

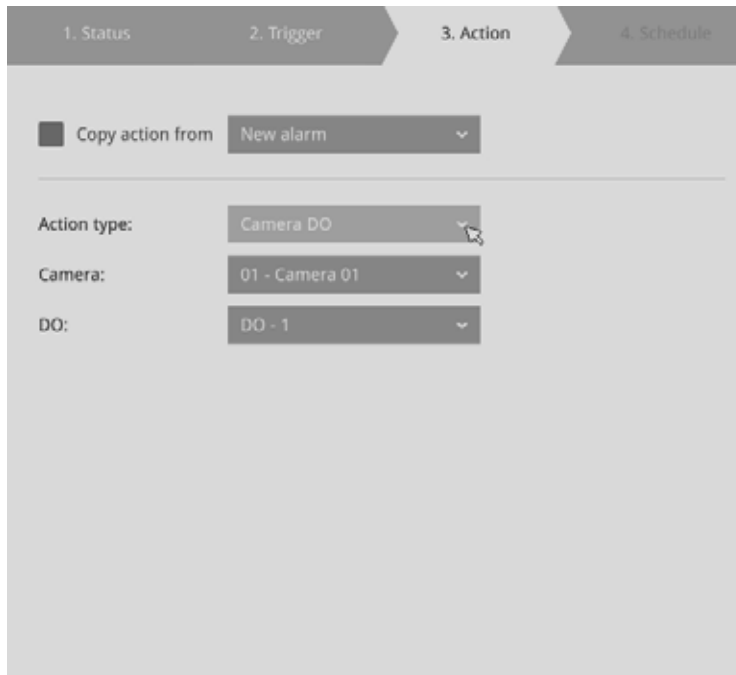

4-6. **Camera pan-tilt-zoom** - A PTZ capable camera can move its lens to the preset position in case of a triggered alarm. For example, a triggered sensor may indicate an area of interest has been intruded, and a camera's field of view should be moved to cover that area. The precondition is that you properly set up preset positions on your PTZ cameras using a local or a web console.

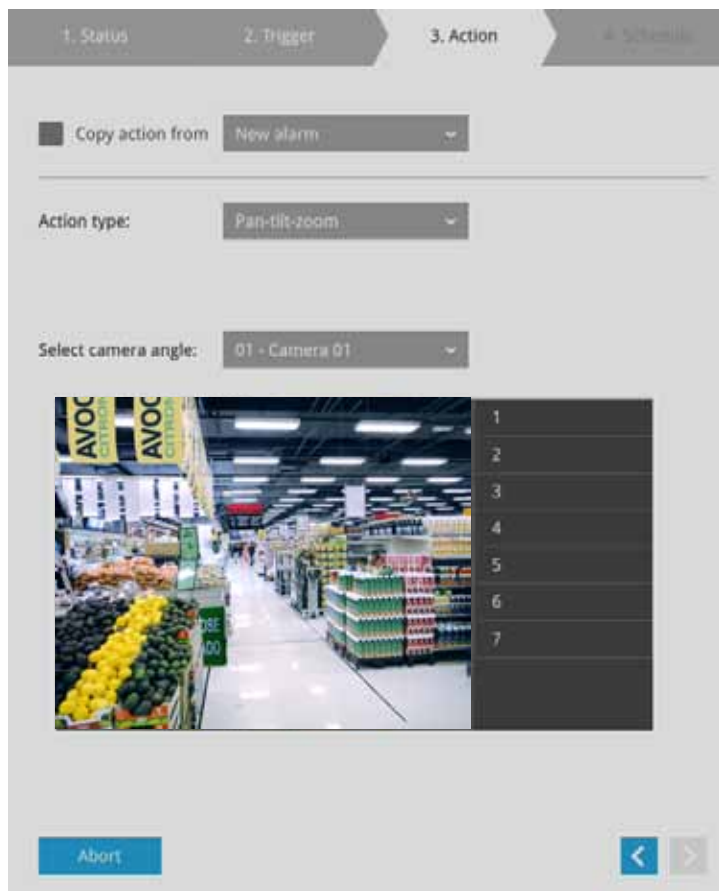

4-7. **System DO** - A triggered alarm can be used to toggle the NVR's digital output, e.g., to sound an alarm siren.

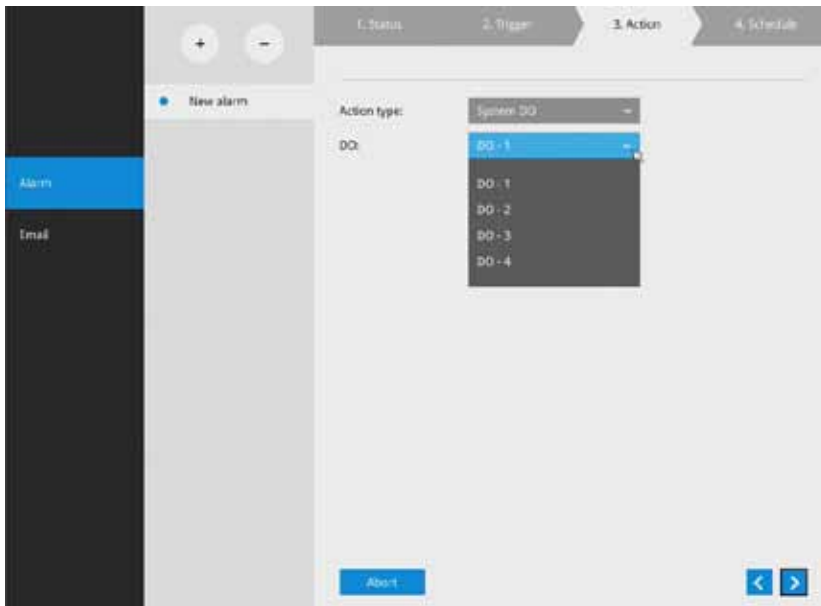

- On the **Schedule** page, you can select to activate or de-activate alarm triggers throughout a specific timeline. For example, in some situations you can disable the alarm triggers during the office hours, and choose to enable the triggers only during the off-office hours.

1. Status    2. Trigger    3. Action    4. Schedule

Copy schedule from New alarm

Apply Alarm

Clear Default schedules

All	0	1	2	3	4	5	6	7	8	9	10	11	12	13	14	15	16	17	18	19	20	21	22	23
Monday																								
Tuesday																								
Wednesday																								
Thursday																								
Friday																								
Saturday																								
Sunday																								

Abort    < Finish

- Click **Finish** to end the configuration.
- Repeat the process above to create more alarms according to the needs in your surveillance deployment.

## 5-2-2. Settings - Alarm - Email

This window provides an interface where you can configure the connection to a Mail server. Via the Mail server, the system can deliver Emails containing system alarm messages to multiple receivers. A reachable Mail server and Email accounts must be provided before you can apply the settings.

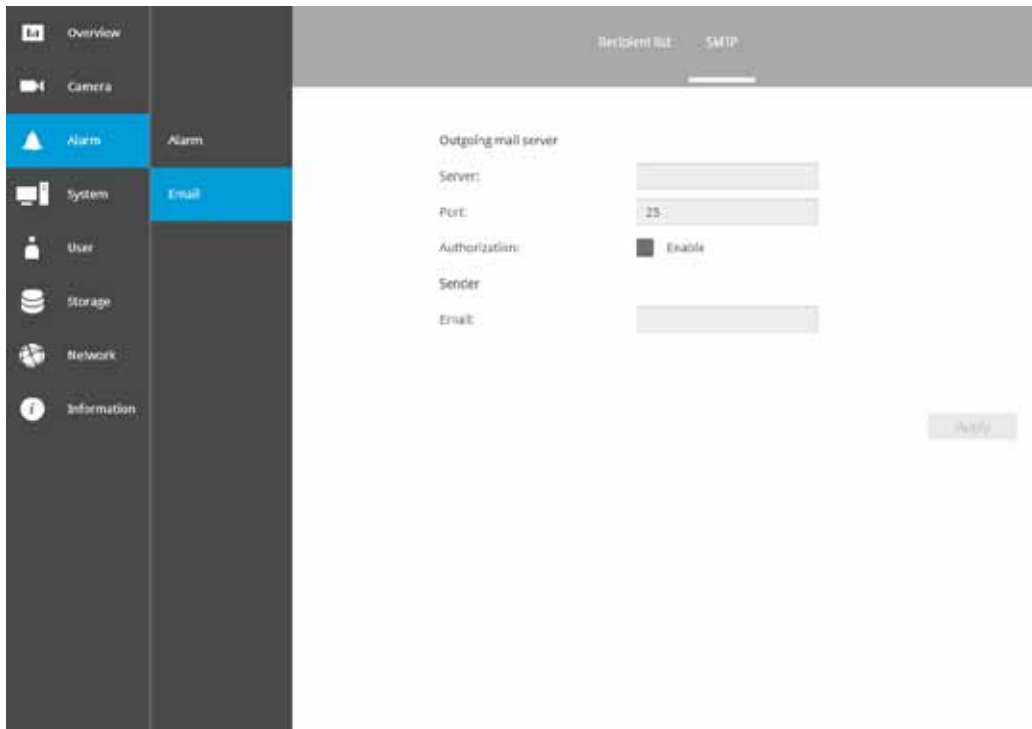

The configuration options are identical to those found in the Email configuration in Settings - Alarm window.

### 5-3-1. Settings - System - Information

On this window, you can configure the following:

1. Change the system name.
2. Select the UI text language.
3. Configure system time, time zone, and if you are connected to a DNS server where Auto Daylight Saving time can be applied, you can acquire the associated setting from a server within your network.
4. Click the **Apply** button for the configuration to take effect.

Note that if **NTP** time server configuration (Auto) is preferred, the system will automatically configure all cameras to be listening to the system, and therefore to the same time server.

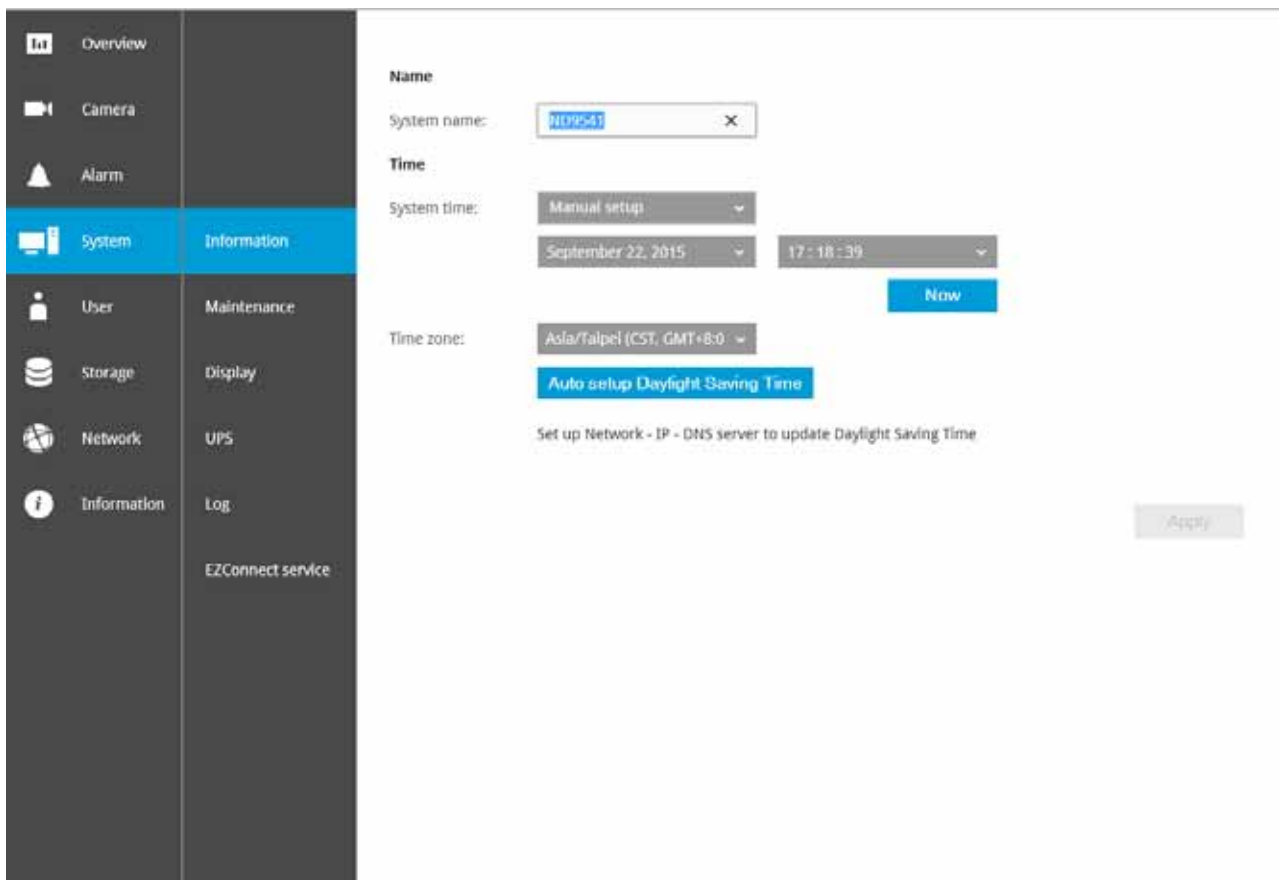

#### IMPORTANT:

Changing system time can produce disruptions to the existing recordings. Turning the current system time back to a time when video recording was taking place can generate duplicate files. And those files may not be playable.



## 5-3-2. Settings - System - Maintenance

If the need arises for updating system firmware, acquire the update from VIVOTEK's technical support or download site. Locate the firmware binaries, and click the Import button. The upgrade should take several minutes to complete. Note that during the upgrade, the recording task will be interrupted.

On this window, you can perform 4 maintenance tasks:

1. **Update firmware** - Download firmware and save it to a USB drive in the FAT format, attach the USB device to the NVR for firmware upgrade.
2. **Update device pack** - A device pack allows you to import associated configurations and parameters for new camera models so that these cameras can be integrated into your NVR configuration. The information in the device pack is related to some tunable parameters.
3. **Backup** - You can backup your system configuration using the Backup function. Click Backup, a message window will prompt. Click Save to preserve your system configurations.

Select a location for your backup file, then click Save to complete the process. If you back up to a USB thumb drive, that thumb drive must be formatted using the FAT format.

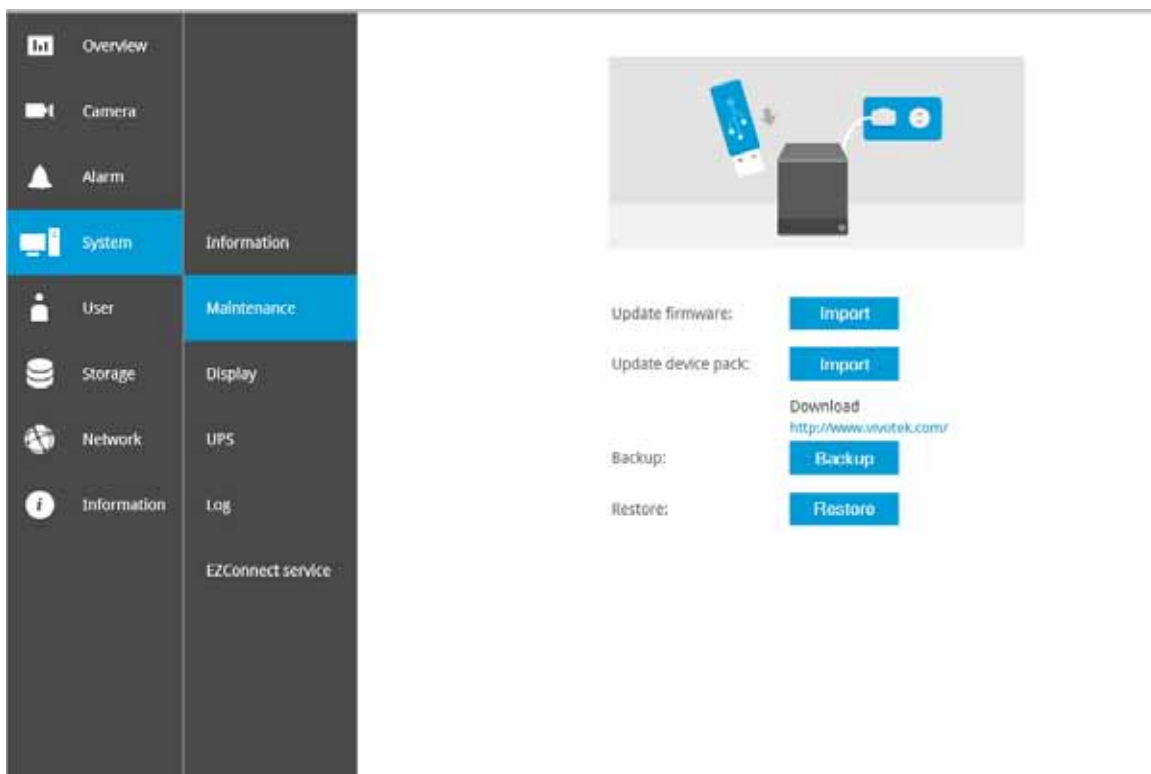

Note that the backup action does not involve the following:

1. Recorded videos and database,
  2. Alarm records, bookmarks, and bookmarked footages.
4. **Restore** - If you have a previously-saved profile, you can restore your previous configuration. Click the Restore button.

A file location window will prompt. Locate the backup file, and click Open. The Restore process will take several minutes to complete, and system operation will be interrupted during the process.

### 5-3-3. Settings - System - Display

On this page, you can configure the system to consecutively display (rotate) cameras' view cells on the Liveview window. For example, if you have 8 cameras in 2 2x2 layouts, the rotation can let you see the live views of all cameras by every few seconds.

You can also enable or disable the Alarm notification.

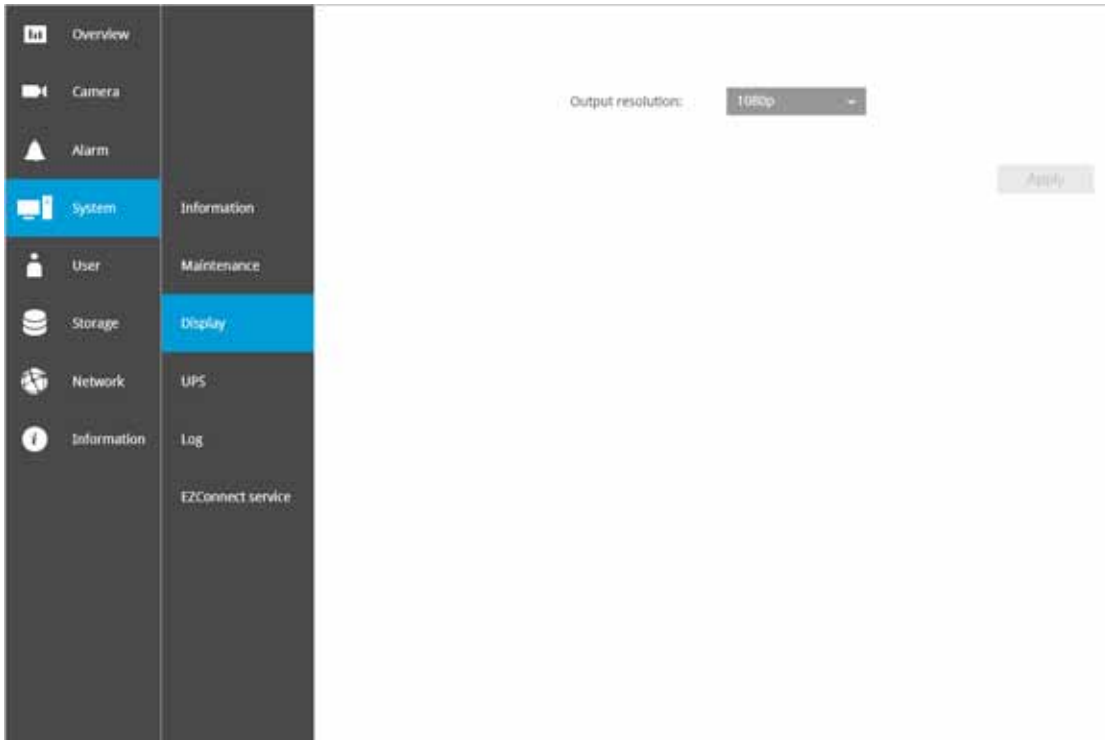

### 5-3-4. Settings - System - UPS

On this page, you can configure the system to gracefully shut down when UPS battery is lower than a certain level. You may also let it shut down when the estimated sustainable time is reached.

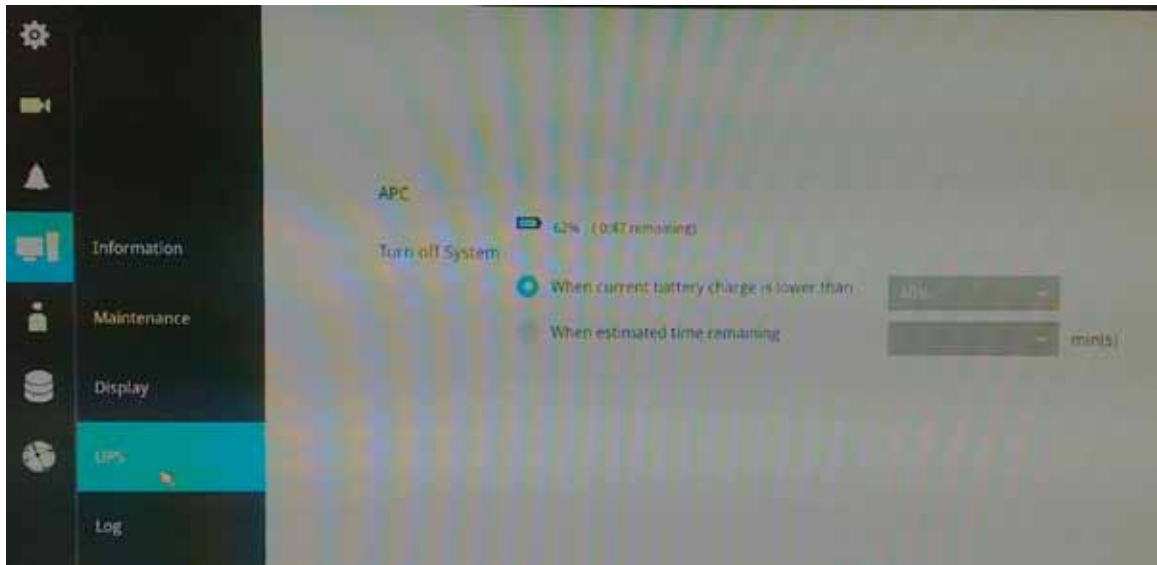

### 5-3-5. Settings - System - Log

System logs are categorized as **System**, **Recording**, **User**, and **Error**. To display system logs, select a range of time and click on the Search button.

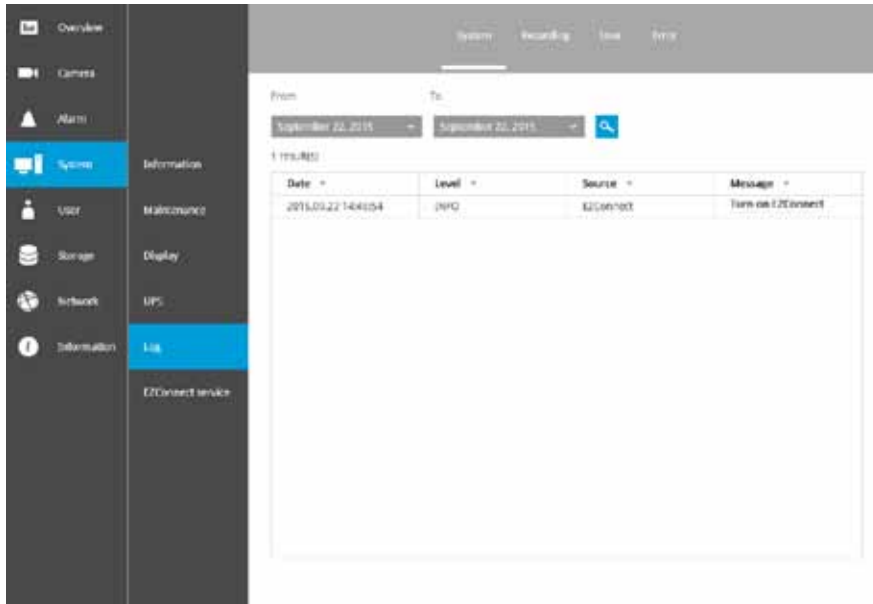

You can search for past logs in each category window.

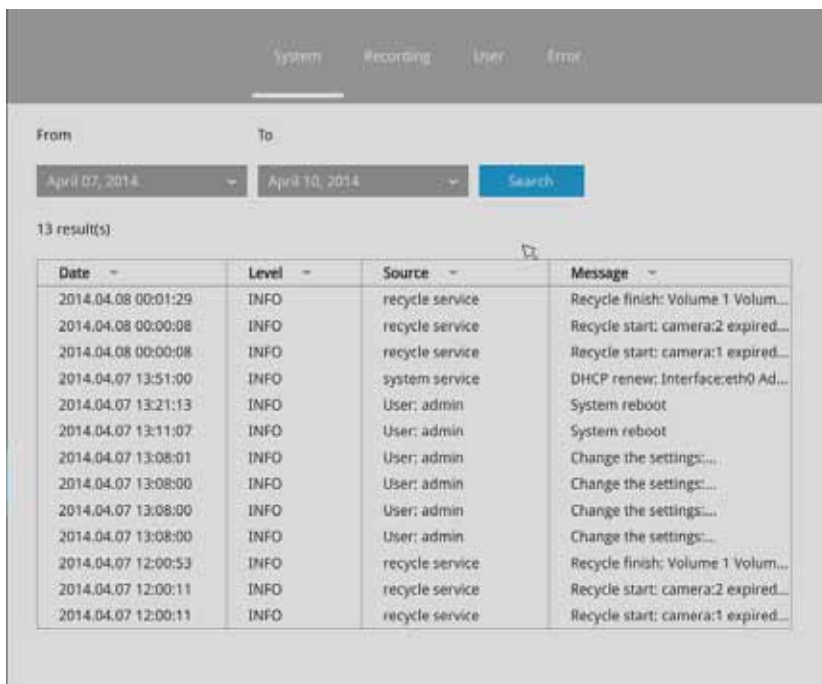

System Recording User Error

From To

April 07, 2014 April 10, 2014 Search

76 result(s)

Date	Camera	Source	Message
2014.04.10 16:27:25	1	recording service	Recording stop: RTSP Fail
2014.04.10 16:03:30	4	camera service	Camera online
2014.04.10 16:03:28	4	camera service	Camera offline
2014.04.10 16:02:23	4	camera service	Camera offline
2014.04.10 16:02:04	4	recording service	Recording stop: RTSP Fail
2014.04.10 15:59:08	4	camera service	Camera online
2014.04.10 15:59:04	4	camera service	Camera offline
2014.04.10 15:57:53	6	camera service	Camera online
2014.04.10 15:57:07	6	camera service	Camera offline
2014.04.10 15:56:55	6	recording service	Recording stop: RTSP Fail
2014.04.10 15:56:42	4	camera service	Camera offline
2014.04.10 15:56:40	4	recording service	Recording stop: RTSP Fail
2014.04.10 15:56:34	4	recording service	Recording stop: RTSP Fail
2014.04.10 15:56:16	4	recording service	Recording stop: RTSP Fail
2014.04.10 11:19:22	1	camera service	Camera online
2014.04.10 11:19:08	1	camera service	Camera offline

System Recording User Error

From To

April 07, 2014 April 10, 2014 Search

4 result(s)

Date	Source	User name	Message
2014.04.08 08:49:19	192.168.6.135	admin	Login
2014.04.07 13:17:15	169.254.132.244	admin	Login
2014.04.07 13:08:54		admin	Update layout: ("view":...
2014.04.07 13:06:55	169.254.132.244	admin	Login

### 5-3-6. Settings - System - EZConnect service

This window provides access to the EZConnect configuration. Please refer to page 25 for how to configure system access using the EZConnect functionality.

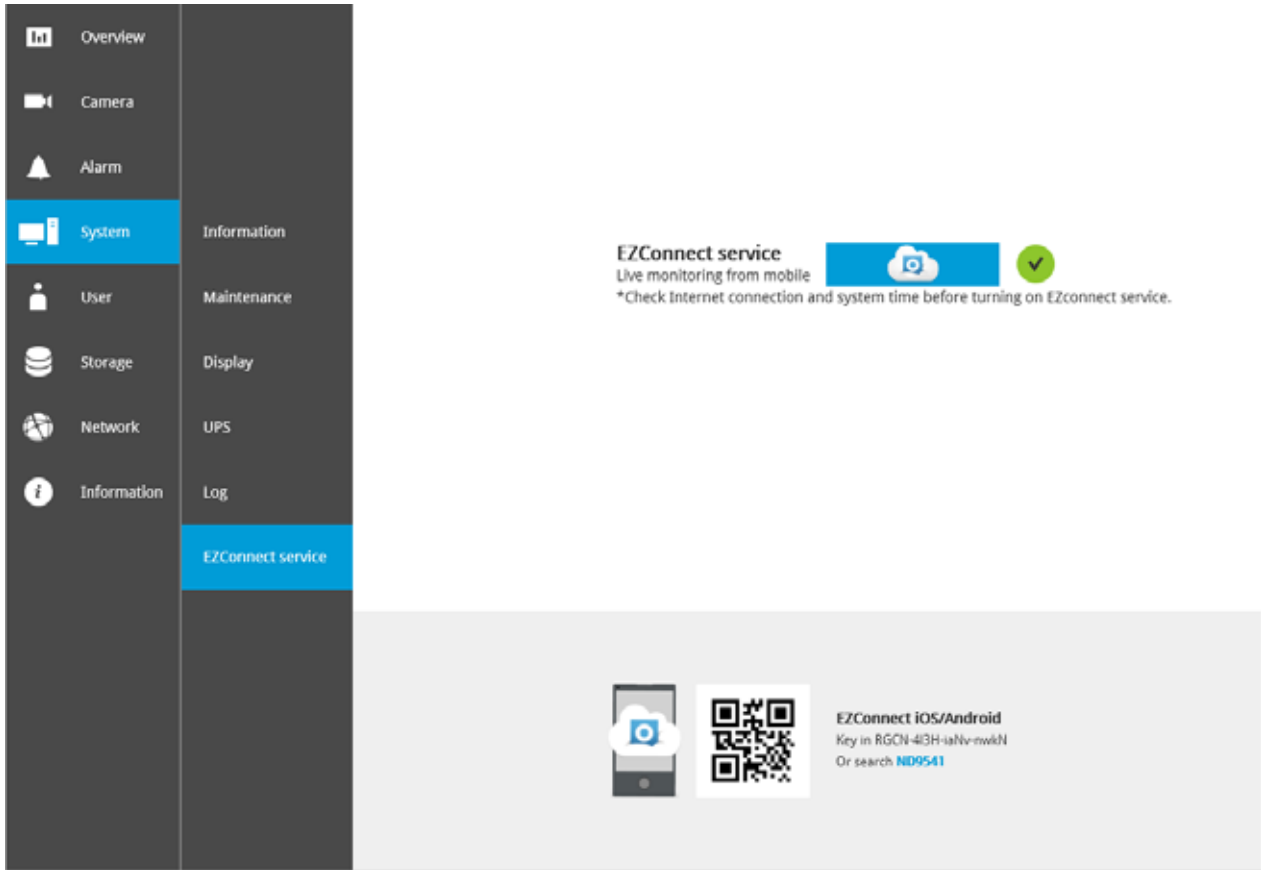

## 5-4. Settings - User

The User window allows you to create more users, to change user password, and place limitations on users' privileges and administration rights. Up to 16 users can be created, including the default administrator.

1. By default, there are two user groups: **Administrator** and **Regular user**.
2. The regular users cannot access the **Settings** window, meaning that regular users can not add or remove cameras, make changes to alarm, network, and all other system settings.

When users try to access the Settings window, the login window prohibits regular users to log in. There is simply no regular user's name on the login window.

3. The administrator users can access all cameras recruited in the configuration; while the regular users can be configured to have access to some or all cameras.
4. The system blocks out the video feeds from users who are denied of the access to particular cameras. The alarms and the alarm-triggered recordings from those cameras will also be inaccessible for unauthorized users.

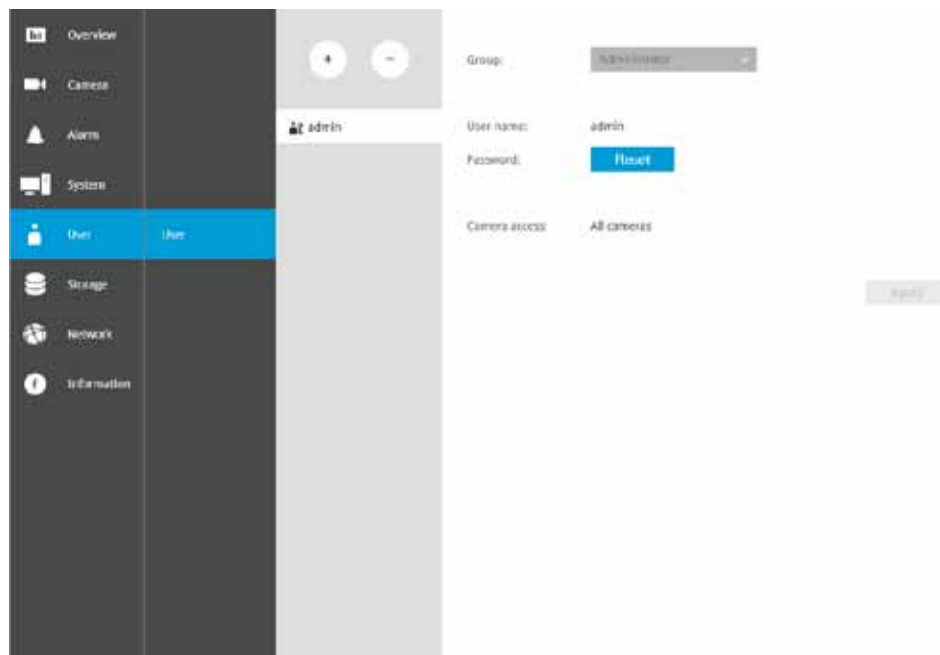

### IMPORTANT:

The default administrator name and password are: admin and admin. It is highly recommended to change the default password to prevent unauthorized access to the system.

To create or edit users,

1. Select a User group by unfolding its pull-down menu. Select either an Administrator or regular user as the user group.

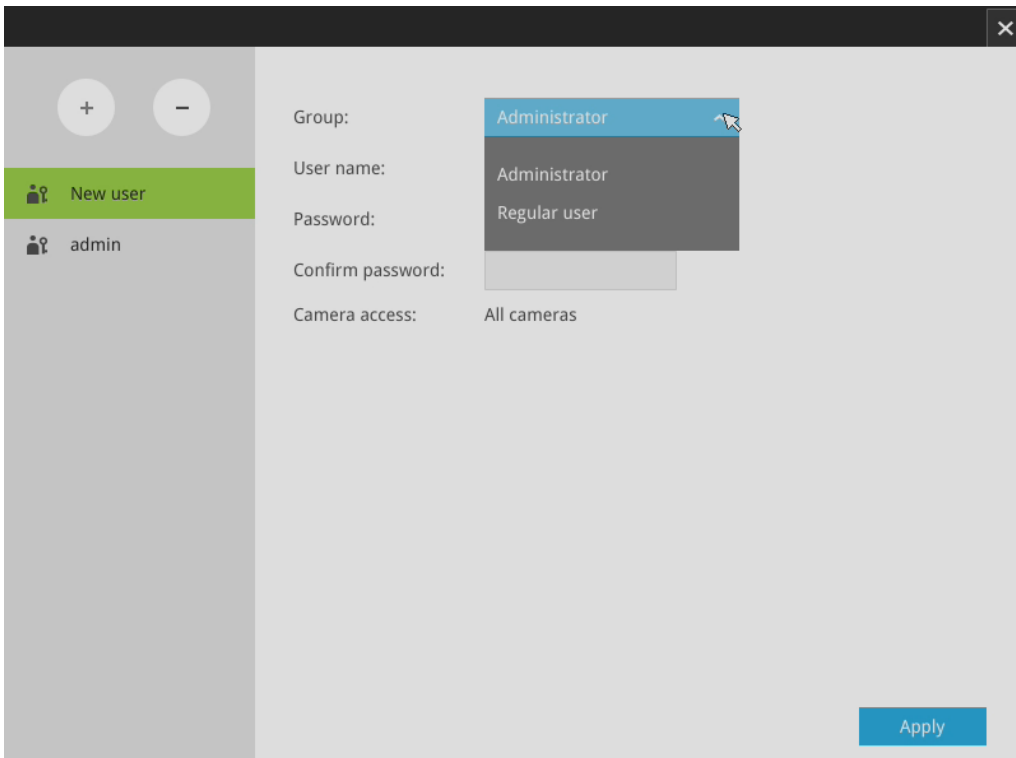

2. Enter the User name and password. The max. number of characters for a user name is 64, with alphabetic and numeric characters including [0-9][a-z][A-Z][\_][ ][-].[,][@]. The max. number for password is also 64.

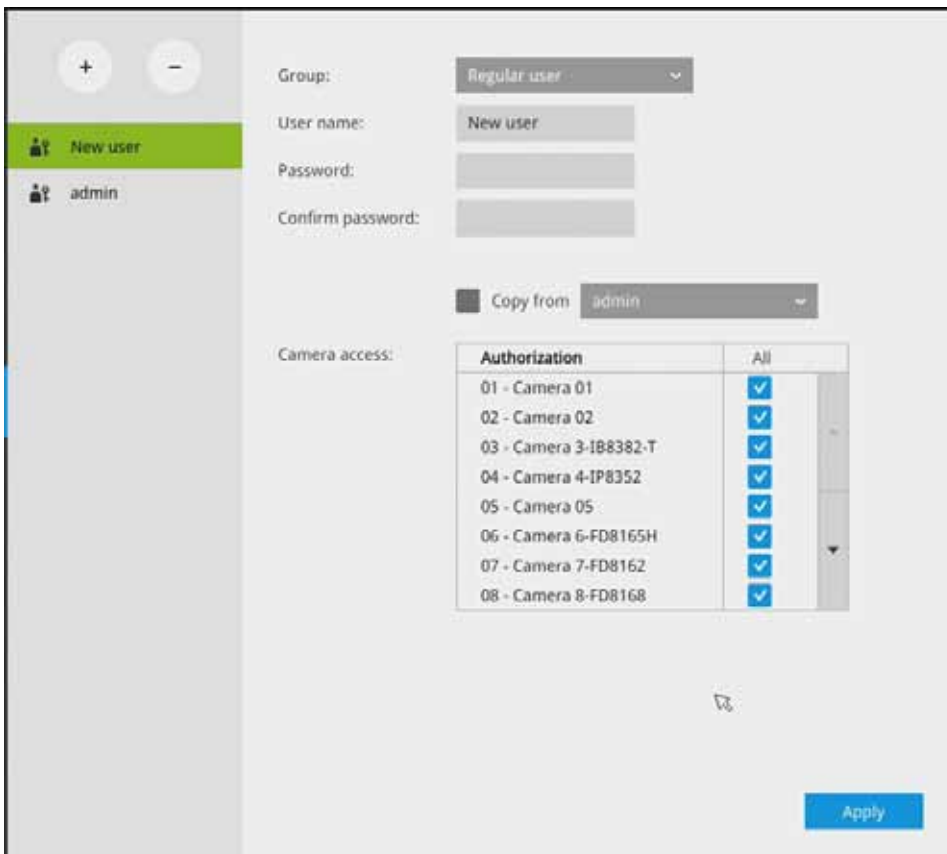



3. If you are creating a regular user with limited access to cameras, deselect the checkboxes by the cameras to deny the user access.
4. Click **Apply** to close the configuration window. Repeat the process to create more users.

## 5-5. Settings - Storage

The storage page displays the volume information including physical position, total capacity, used and free space, and associated commands such as Format and Delete. Since each volume contains only 1 hard drive, details information about the hard drive is also displayed on this page.

You can format an existing storage volume in situations such as when you need to re-deploy the system elsewhere.

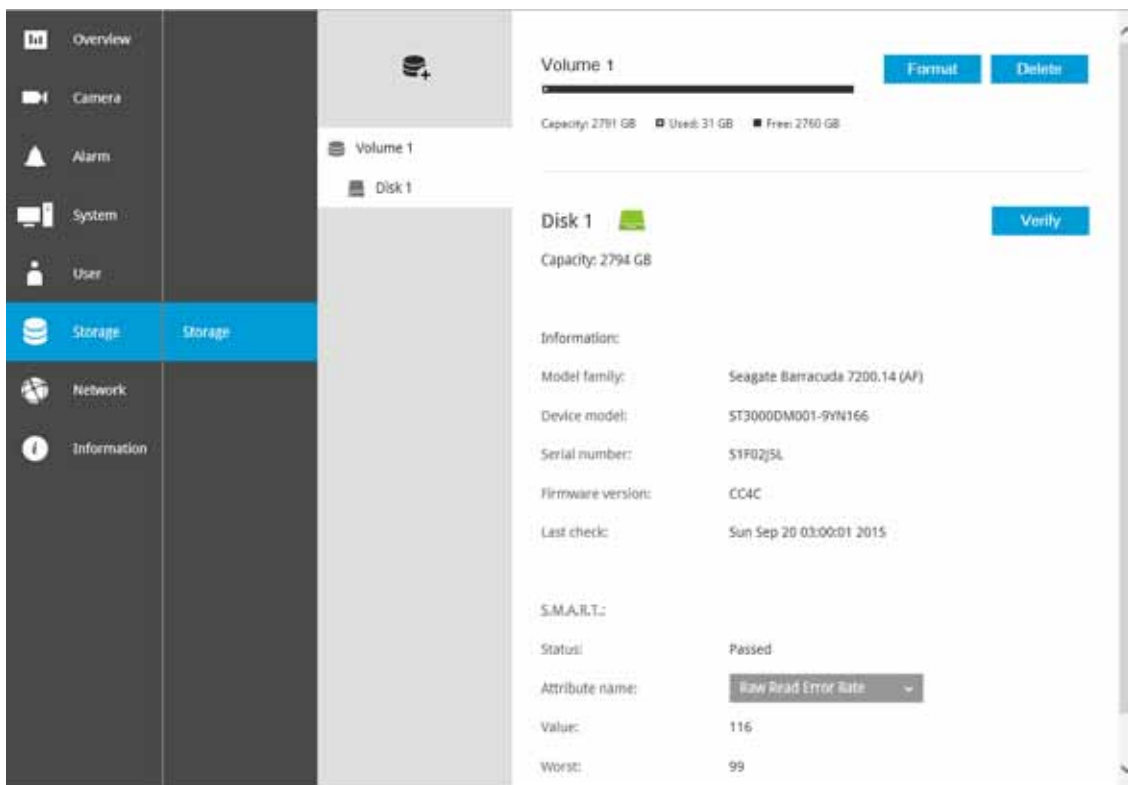

### Disk Information:

**Model family:** The brand name of the HDD manufacturer.

**Device model:** The disk model name.

**Serial number:** Serial number assigned to the disk drive.

**Firmware version:** The version of firmware running on this disk drive.

**Last check:** The bad block check or S.M.A.R.T. test previously executed on this drive.

**Status:** S.M.A.R.T. status polled from the disk drive. This is not the results from a manually-executed S.M.A.R.T. test.

**Attribute:** The various attributes can vary from different HDD manufacturers.

**Value:** Value for the currently selected attribute.

**Worst:** Worst value acquired for that attribute.

**Threshold:** A predefined threshold or triggering value. The threshold below which the normalized value will be considered exceeding specifications.

**Raw value:** The detected parameters for that attribute.

**Status:** The judgement made to deem the current reading as OK or failed.



### Verify:

Three types of check disk actions can be initiated through this button.



**Bad block check:** Performs read/write test to drive sectors to locate bad blocks. This action may take several hours to complete.

**Fast S.M.A.R.T. test:** Tests the electronic and mechanical performance and disk read performance, including those on disk buffer, read head, seek time, and integrity of drive sectors. The short test is performed on a small section of disk platters, and takes about 2 minutes to complete.

**S.M.A.R.T. long test:** The long test is more thoroughly and is performed to all drive sectors. The actual completion time depends on drive sizes and the attributes put to test.

The Check disk functions mentioned above, when performed during active I/Os, can consume system resources and cause dropped frames with the recording tasks.

## 5-6. Settings - Network

### Bonding mode

**Single:** Only the NET1(Eth0) port is effective. NET2(Eth1) is not functional.

**Dual LAN:**

1. The network parameters of two Ethernet ports are independent. You can attach these two Ethernet ports to different subnets, e.g., one for a network console or as a uplink; the other to a PoE switch for connecting IP cameras.
2. The major gateway of the system is NET1(Eth0) as the Ethernet port for a network console. NET2(Eth1) can be used for connecting to a PoE switch and then to IP cameras.
3. Do not connect IP cameras that come with virtual IPs (cameras' default 169.254.x.x) to NET1(Eth0). The DRM search will not be able to find cameras that come without a designated IP. Also, if a DHCP server is not present in a network NET1 is attached to, you will not able to find the NVR using the IW2 utility.
4. In this mode, do not attach NET1(Eth0) and NET2(Eth1) to the same subnet.

**Failover:** (system default)

1. The two Ehternet ports share the same IP address. NET1(Eth0) is the default main access route for the system, while the NET2(Eth1) acts as a standby port. They act as a fault-tolerant pair.
2. In this mode, NET1(Eth0) and NET2(Eth1) ports must be attached to the same subnet.

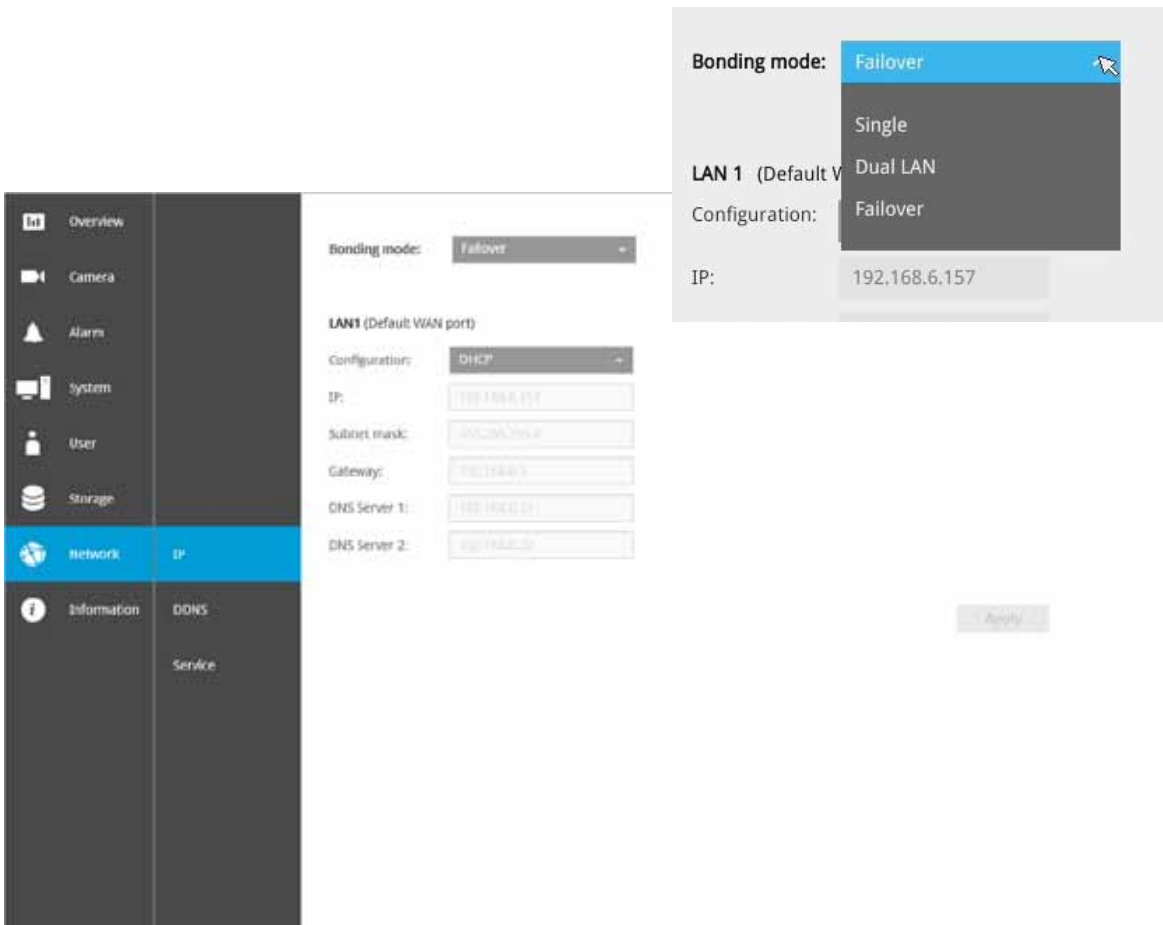

## Settings - Network - IP

DHCP: Default is selected, the server obtains an available dynamic IP address assigned by the DHCP server each time the system is connected to the LAN.

Manual setup: Select this option to manually assign a static IP address to the Network Camera.

Enter the Static IP, Subnet mask, Default router, and Primary DNS provided by your ISP.

Subnet mask: This is used to determine if the destination is in the same subnet. The default value is "255.255.255.0".

Default router: This is the gateway used to forward frames to destinations in a different subnet. Invalid router setting will fail the transmission to destinations in different subnet.

Primary DNS: The primary domain name server that translates hostnames into IP addresses.

Secondary DNS: Secondary domain name server that backups the Primary DNS.

When finished with the network settings, click on the **Apply** button.

## Settings - DDNS

VIVOTEK provides Safe100.net, as a free DDNS dynamic domain name service for users who want access from the internet or a domain name service for the NVR. VIVOTEK maintains a database of product MAC addresses for the Safe100.net service, and you can apply one domain name for each NVR system.

**DDNS Enable:** Select this checkbox to enable the DDNS setting.

Enter a Host name, Email address, and password twice, and then click **Apply** to proceed.

Make sure you have internet access.

Click the **Register** button. The terms of service agreement window is selected from a checkbox at the bottom. Click  to read the license agreement terms.

The acceptable characters for email address are: [0-9][a-z][A-Z][!][#][\$][%][&][\*][+][-]/[=][?][^]\_[`]{|}[]{}~][.]. Two successive periods, [..], are not acceptable. The address filed can accommodate up to 256 characters.

Use only alphabetic and numeric characters for the password. The maximum number of characters is 64.

When completed, a confirm message will prompt. You will also receive a confirm Email. You can now access your NVR system using the xxx.safe100.net domain name address. Note that access from the Internet should be routed to the private IP assigned to your NVR, using methodologies such as port forwarding, etc.

## Settings - Service

By default, the NVR service and video streaming are accessed via HTTP port 80 and RTSP port 554. You can designate a different port number if the need arises. Usually it is not necessary to change these ports. HTTPS encrypted connection is enabled by default.

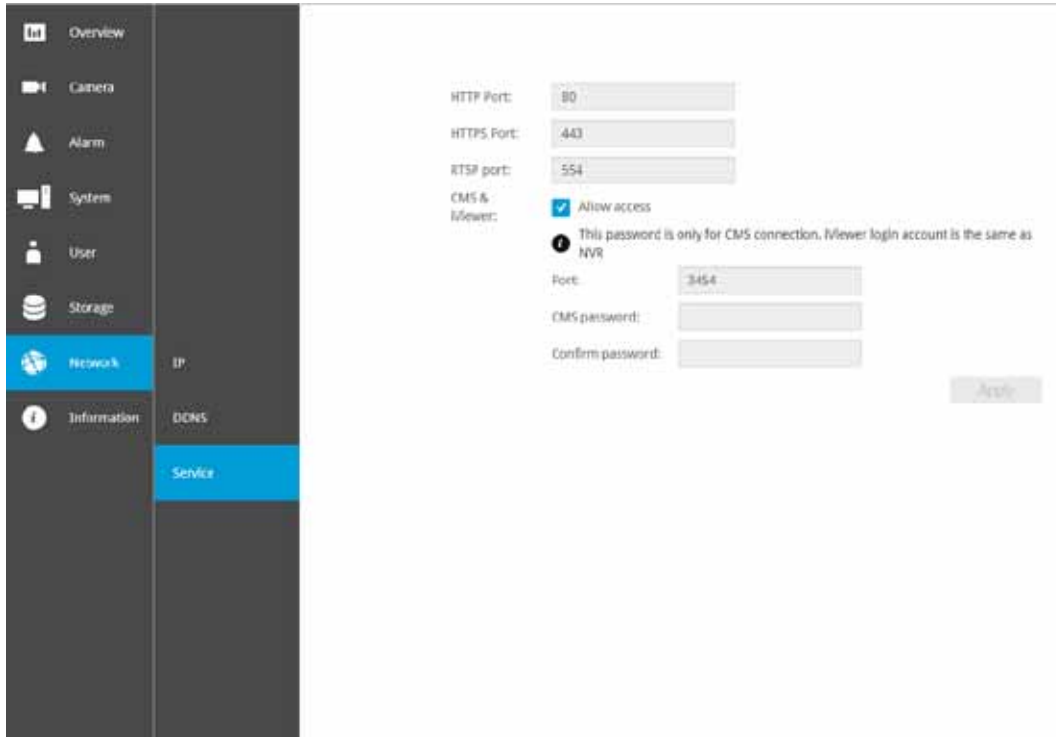

In addition to a web console, you can also access the NVR and the subordinate cameras using the **iViewer** and VIVOTEK's **VAST** management software. The NVR can be managed as one of the sub-stations in a hierarchical device structure.

Set up a password for access from the VAST server before you can join the NVR to a VAST configuration. For access from the iViewer, you log in using the same user name and password for the login to the NVR.

Below is the screen showing the sub-station recruitment process from a VAST server.

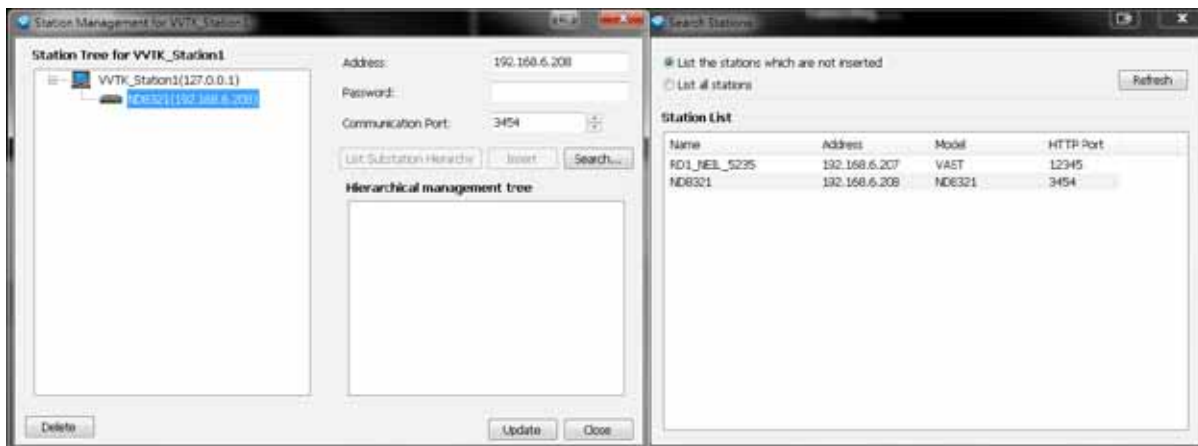

## 5-7. Information

This window shows the revision number of the firmware running on this machine.

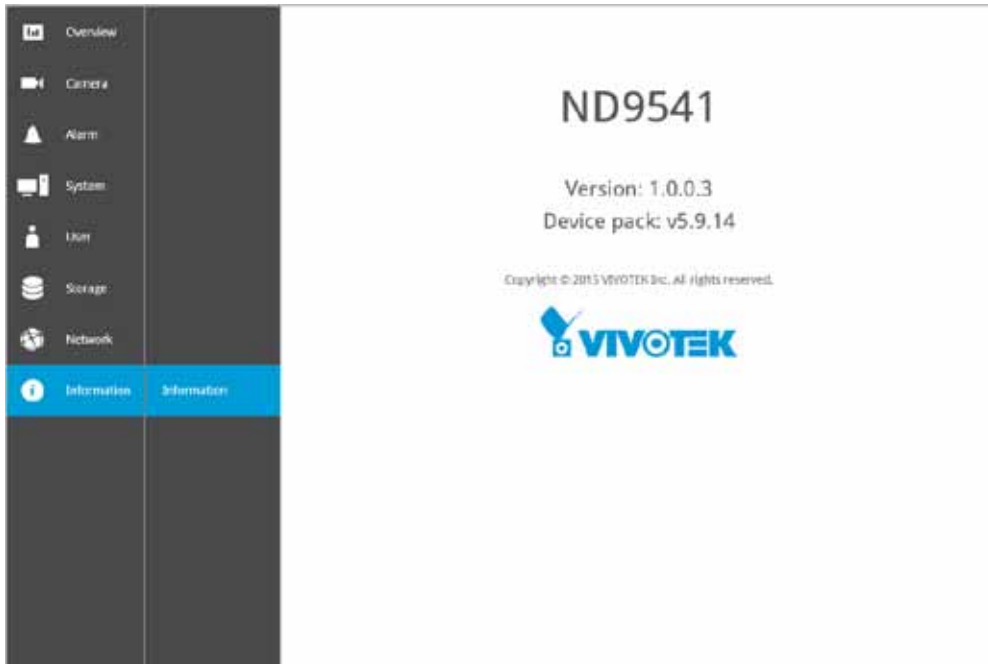

# Chapter Six Operation

**⚠ IMPORTANT:**

1. Before operating the NVR, make sure you have properly installed hard drives and configured the storage volumes. Otherwise, you will not be able to operate most of the system's functionality.
2. Since the NVR system comes with 32-bit plug-ins for screen control, if your PC runs a default 64-bit IE browser and you manually enter the NVR's address on the browser, your browser session may malfunction. Instead, if you double-click on the discovered NVR on the IW2 utility, a 32-bit IE browser will open.

## 6-1. Liveview

### 6-1-1. Placing Cameras into the Layout

Legends and definitions of icons on the layout panel have been described on page 109.

It is presumed that you have properly inserted all network cameras in your deployment as previously described on page 149. All 8 cameras should be listed on the Camera list.

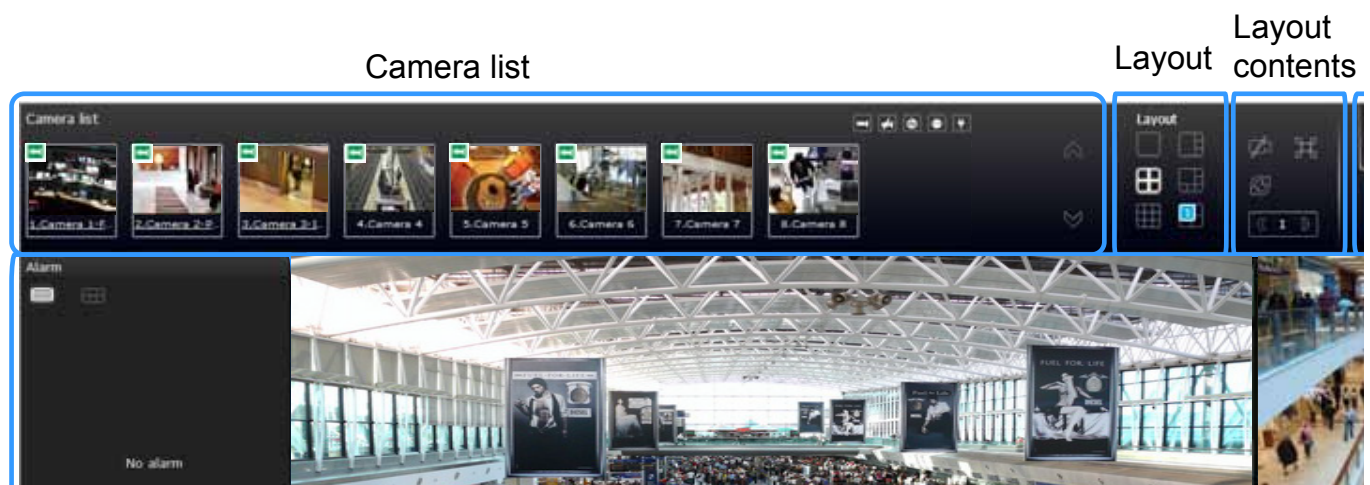

Note that layout design can only be performed by the system administrator.



To begin the design of your layout,

1. Select a layout pattern by a single click. The options are: 1x1, 2x2, 3x3, 4x4, 1P+3, 1M+5, 1M+12, and 1M+31, where 4x4 and 1M+12 are available for the 16-CH model.

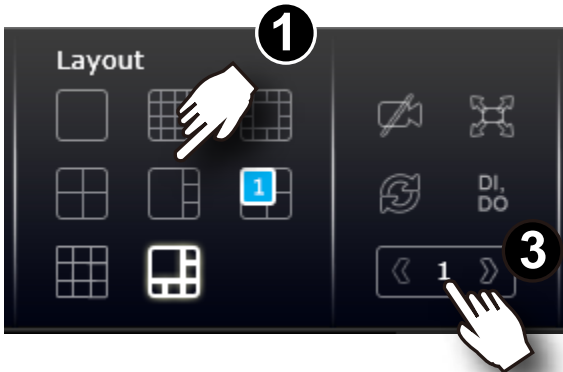

2. Click and drag cameras from the Camera list to empty cells on your layout. Repeat the action until you placed all your cameras into the layout. You may also double-click on a camera's thumbnail to fill it into the first unoccupied view cell.

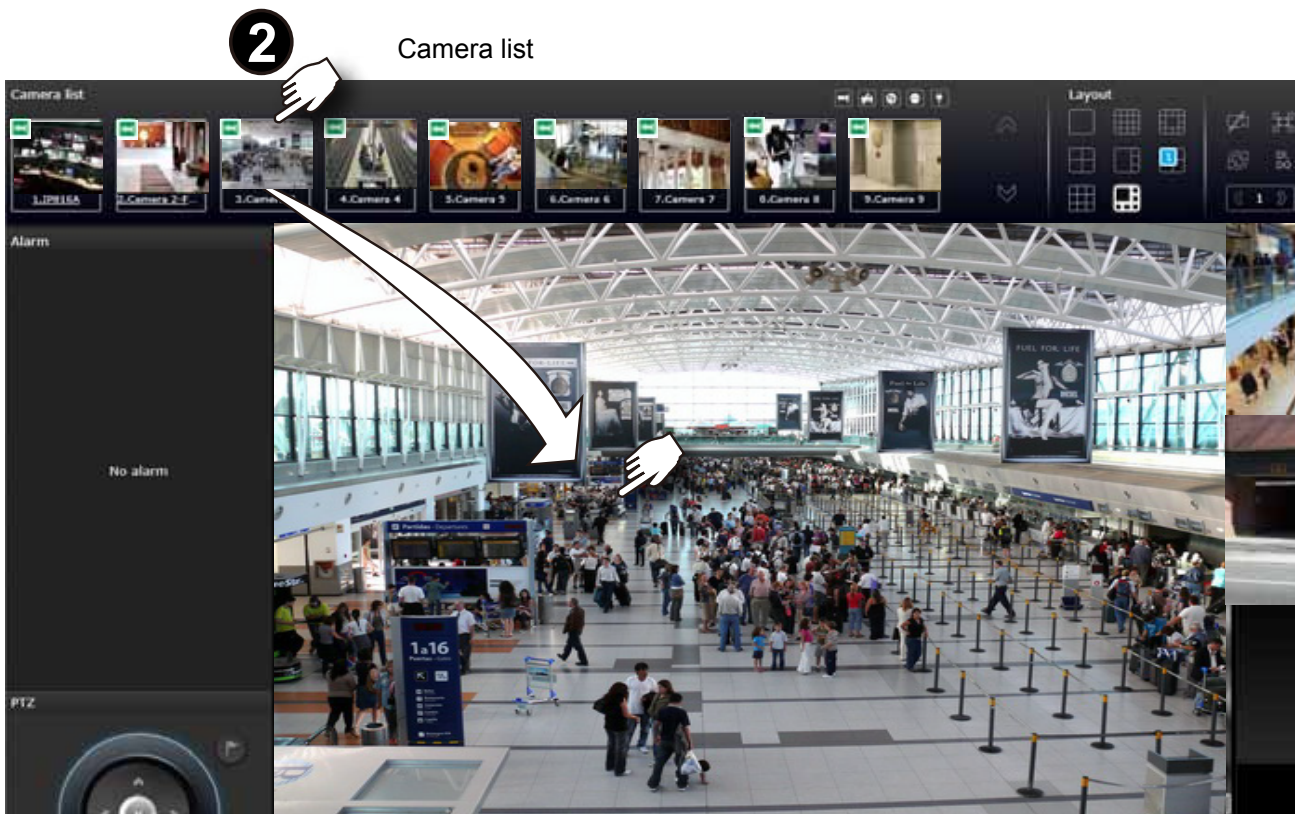

3. When you filled up the current layout, e.g., 6 camera into the 1M+5 layout, click the page switch button to continue on the next layout page.

4. On completion, click **Save** to preserve your setting.

Placing different regional views of a fisheye camera into view cells will look like this:

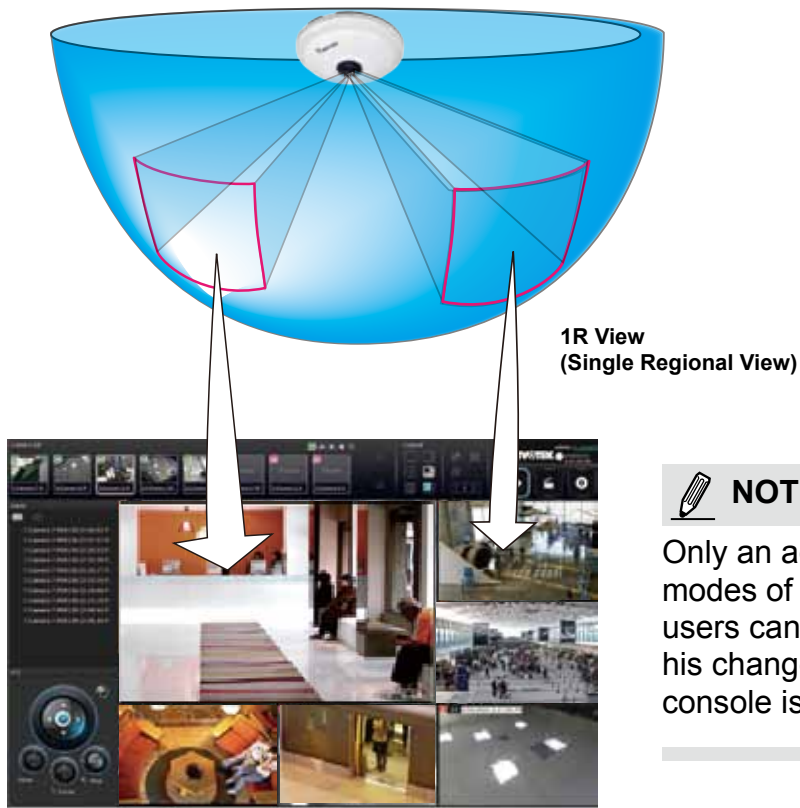

 **NOTE:**  
Only an administrator can alter the display modes of fisheye cameras. Although ordinary users can make changes to a regional view, his changes will not be preserved after a console is re-started.

In addition to fisheye cameras, if a camera has a wide field of view, you may also display its different fields of view in multiple view cells. Some view cells may also contain a PiP view that is digitally zoomed.

The fisheye mode button is available on the view cell where you inserted a fisheye camera. When a regional view is displayed, the shooting angle and image orientation is kept with the layout. See page 118 to see more about fisheye viewing modes.



- When you are done with the current layout design, i.e., [the user layout 1](#), click **Save** to preserve your settings. This message prompts on the screen whenever any change is made to the current layout.

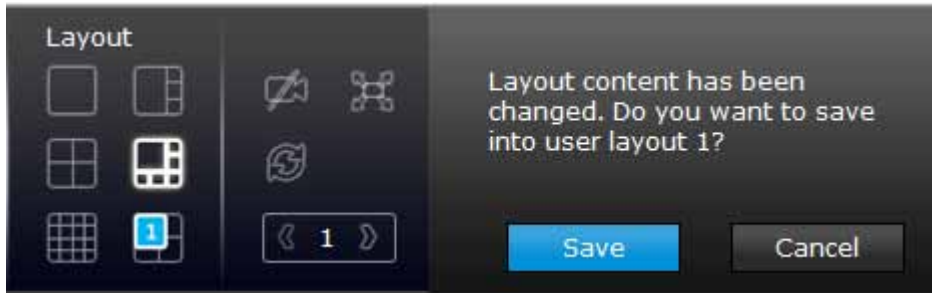

- You can create more user layouts by mouse-overing the user layout button. You may create more user layouts for different purposes, such as for the use of different users, or playing different views of a camera on multiple view cells.

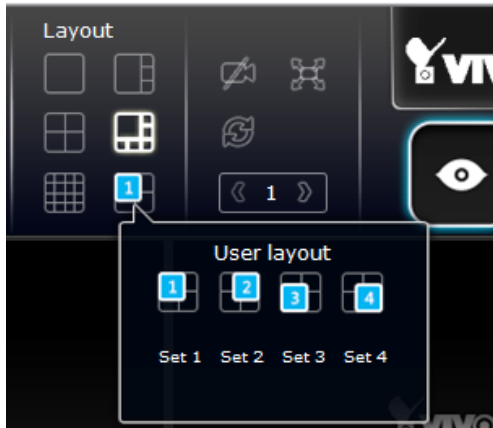

If users were created and some cameras are excluded from their access, a user may log in and see the locked-on cells as shown below:

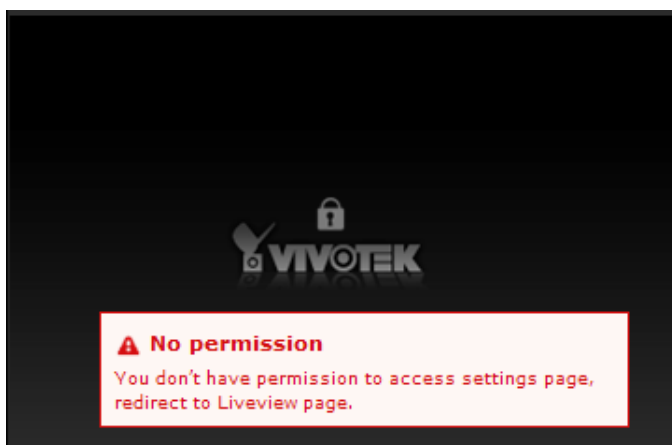

A user who has limited access rights may still re-arrange the layout of view cells. However, his configuration change will not be saved after he leaves the current console.



**NOTE:**

By default, every users or administrator logs in to the Live view window to the last layout page he visited. The last layout page a user visited during the previous console becomes the default layout.

**6-1-2. PTZ and Other Screen Controls**

Note that the PTZ control panel only applies when you select a view cell with a camera that comes with mechanical PTZ functions. Currently the e-PTZ function is not supported by the NVR system.

With a PTZ camera, the buttons on the PTZ panel become functional when you mouse over its GUI elements. For all compatible cameras and exerting Zoom, Focus, and Patrol functions, please refer to page 120 for details. The Zoom function, for example, requires a camera that comes with a motorized zoom module, and may not be applicable to every PTZ camera.



The preset positions and the patrol functions require the associated configuration on the cameras via a web console. Before you make use of these functions, you should set up the preset positions on a web console with the camera. The NVR GUI does not provide the configuration options with PTZ preset positions.

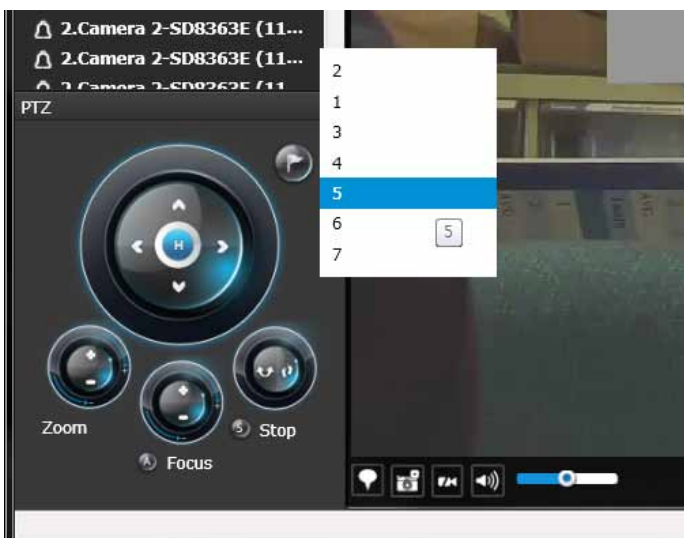

You can use **Preset** button to display preset positions and tell the camera to move and point at the preset direction, and to perform a camera tour to visit these positions in a consecutive order.

**To access live view control,**

1. **Click** on a view cell. The view cell will become a focused view cell. The streaming control buttons will be listed at the bottom of a view cell. These buttons have been discussed on page 114.
2. **The 2nd click** on a view cell enlarges it to the full of the live view area. **The 3rd click** reduces its size to the original focused view.
3. To deselect a view cell, you can click on another view cell in the display area or click on the Restore  button.



A selected, focused, view cell.

**NOTE:**

If you have concerns with the display quality and frame rate per second, refer to page 156 for how to configure video feeds for live viewing as well as for video recording. The configuration options can be found in **Settings > Camera > Video**.

Note that the constant bit rate methodology is applied in this system and it sets an upper threshold on the size of IP packets sent with the video streams. Image quality will be slightly compromised if reaching the ceiling of allowable bandwidth.

### To place bookmarks and exert screen controls,

On a focused view cell, you can place a bookmark  that saves a short description and a one-minute footage from the current feed. The bookmark is also displayed along with the recorded video, and therefore it is easier to look for a specific moment in time when you need to trace back for a scenario later.

The bookmark function can be executed on a live or recorded stream when you observe a situation from your Live view or Playback window. The precondition of using this function is that the video stream, while you are watching it on the view cell, must be recorded to the NVR at the same time.

To add a bookmark,

1. Click on the button,
2. Enter a short description that can be as long as 120 characters.
3. Click on the + button or simply press Enter on your keyboard.

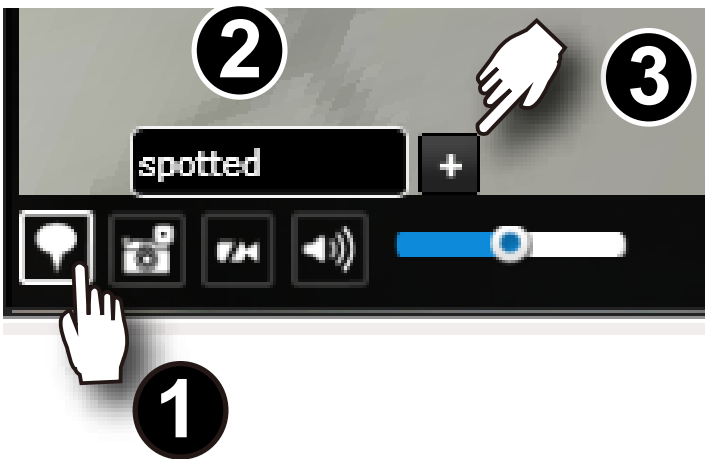

**To Activate and Deactivate PiP function,**  

PiP is short for Picture in Picture, a function that provides digital zoom into a live video. When activated, a Global view window will appear at the lower right of the view cell as shown below. You can display only a portion of the complete video frame as an area of your interest. Using a click and drag on the ROI window, you can instantly move to other areas within the video frame.

You can resize the ROI window by a mouse hover on the lower-right corner of the window until the resize mark appears. The default size of the ROI window is 25% of the Global view.

Click on the deactivate  button to close the PiP window.

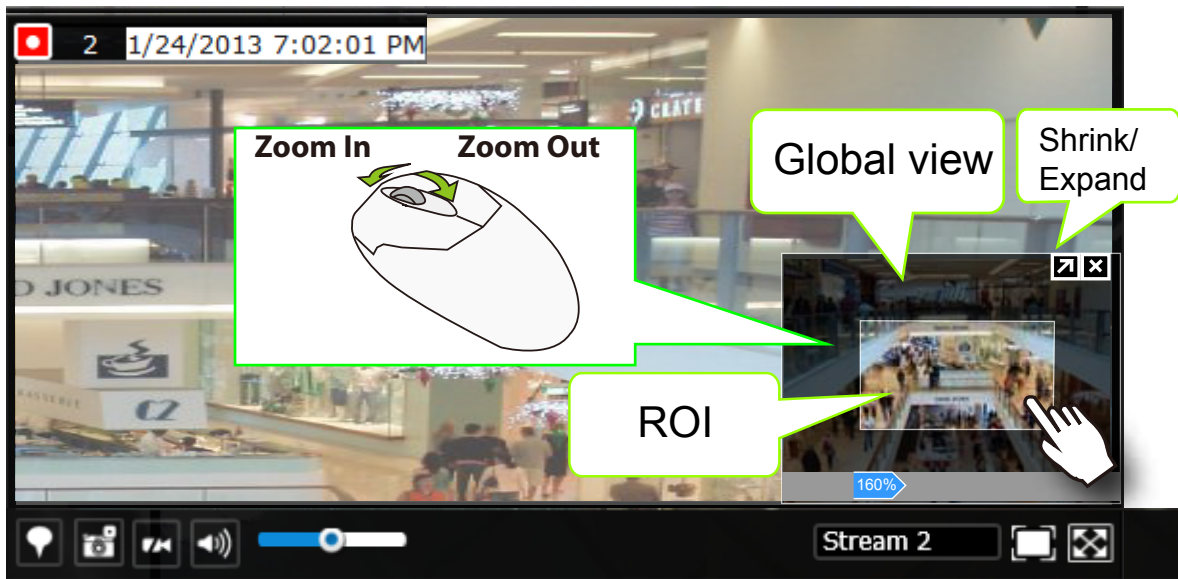



Note that not every camera supports the PiP function. For example, PTZ cameras do not support the PiP feature.

Refer to page 114 for GUI legends and individual functionality.

### 6-1-3. Audio

Audio is only transmitted through the camera in a view cell that is currently selected. You can manually tune the volume level, mute, or unmute the audio feed through a view cell.

### 6-1-4. Camera Properties and Controls

You can click on the underlined name entry of a camera on the camera list to open its properties window. Here you can find a short description of the camera name, address, and model name. You can also enable or disable the scheduled or continuous recording set for the camera. Click on their associated icons, , , to change their recording status.

For a camera that is not performing a continuous recording, you can click on the Manual Recording button, , to start a manual recording. The recording will stop using the same button.

You can also manually turn on the digital output , e.g., to trigger an external alarm that is connected to a specific camera.

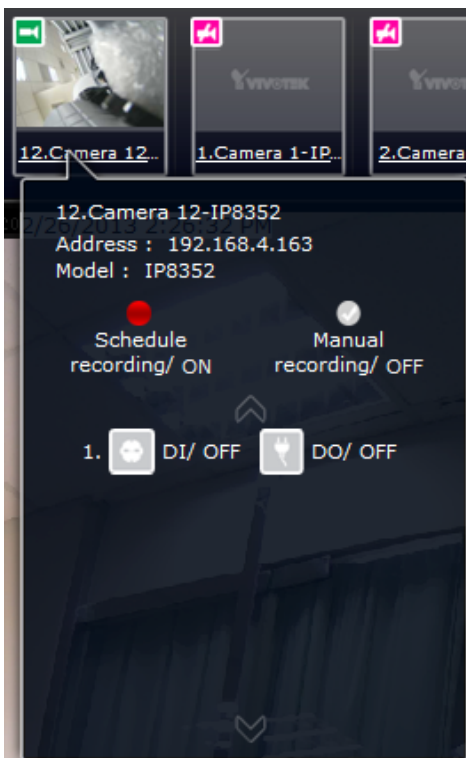



## 6-1-5. Alarm Panel

To receive alarms from cameras, you need to configure alarm triggers in the **Settings > Alarm** configuration window (see page 75). Network cameras' digital inputs, digital outputs, or motion detection can all be used to detect conditions in external environments. You can configure certain kind of actions to take place in response to the alarms: such as,

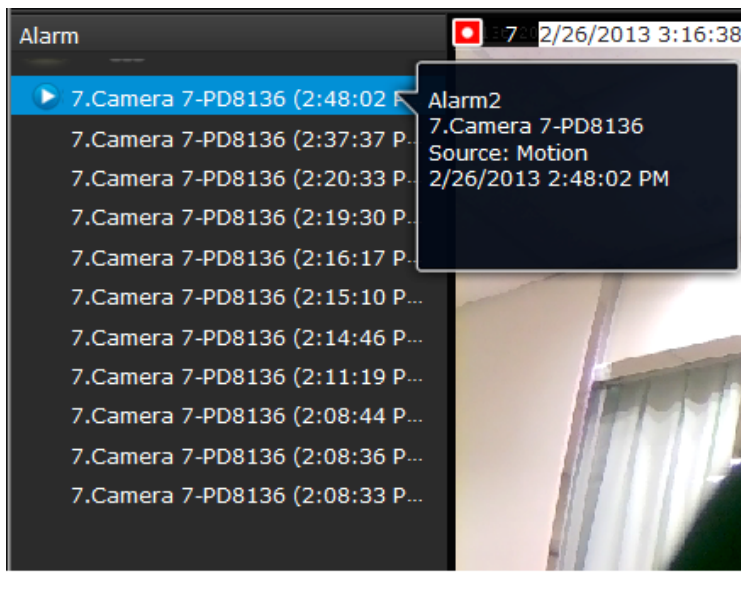

1. recording the immediate image,
2. sending an Email notification,
3. sounding the onboard buzzer,
4. sending snapshots to an FTP server,
5. sending videos to a web server,
6. moving camera lens to a preset location,
7. triggering a camera's digital output.

The operation details of the **Alarm panel** and **Alarm Playback** utility have been described on page 122.

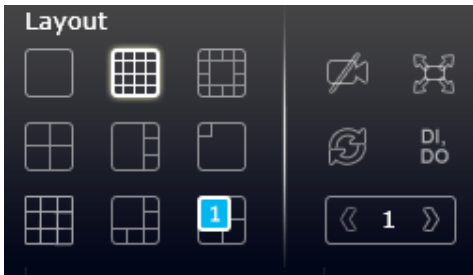

### 6-1-6. Layout view Control Buttons



1.  When editing a user layout, you can use this button to clear all view cells of inserted cameras.
2.  This button extends the current layout to the full of the screen.
3.  The Rotate function lets system display successive pages in a user layout [by the intervals of 10 seconds](#). The layout page that does not contain camera views will be skipped.

A Rotate action will stop when you

1. move to another page in the user layout,
2. move to another user layout,
3. click to select a view cell,
4. remove a camera from view cell,
5. click to disable the rotation function.

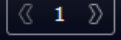
When your current layout spans across multiple pages, use the arrow buttons  to switch from one page to another. The index number of the current page will be shown between the arrow buttons.

## 6-2. Search Recording Clips

The elements in the Camera list on a **Search recording clips** window are similar to those on a **Liveview** window. Please refer to page 107 for details on the Camera list panel.

However, on a Search recording clips window,

1. You **cannot** click and drag a camera thumbnail to a playback view cell.
2. A double-click on a camera does not display video in a view cell. A double-click displays a **calendar** where days with recorded videos are shown.

### 6-2-1. Begin Playback and Search for Past Recordings

1. Select a layout. You can display the playback views of multiple cameras on one screen.
2. Double-click on a camera.
3. The **Calendar panel** will display the days video recording actually took place. And those days will be highlighted by a blue background (as the 25th and 28th in the screen below.)



 **NOTE:**

If a video stream was recorded in the **MPEG-4** format, it will not be playable on the Playback window.

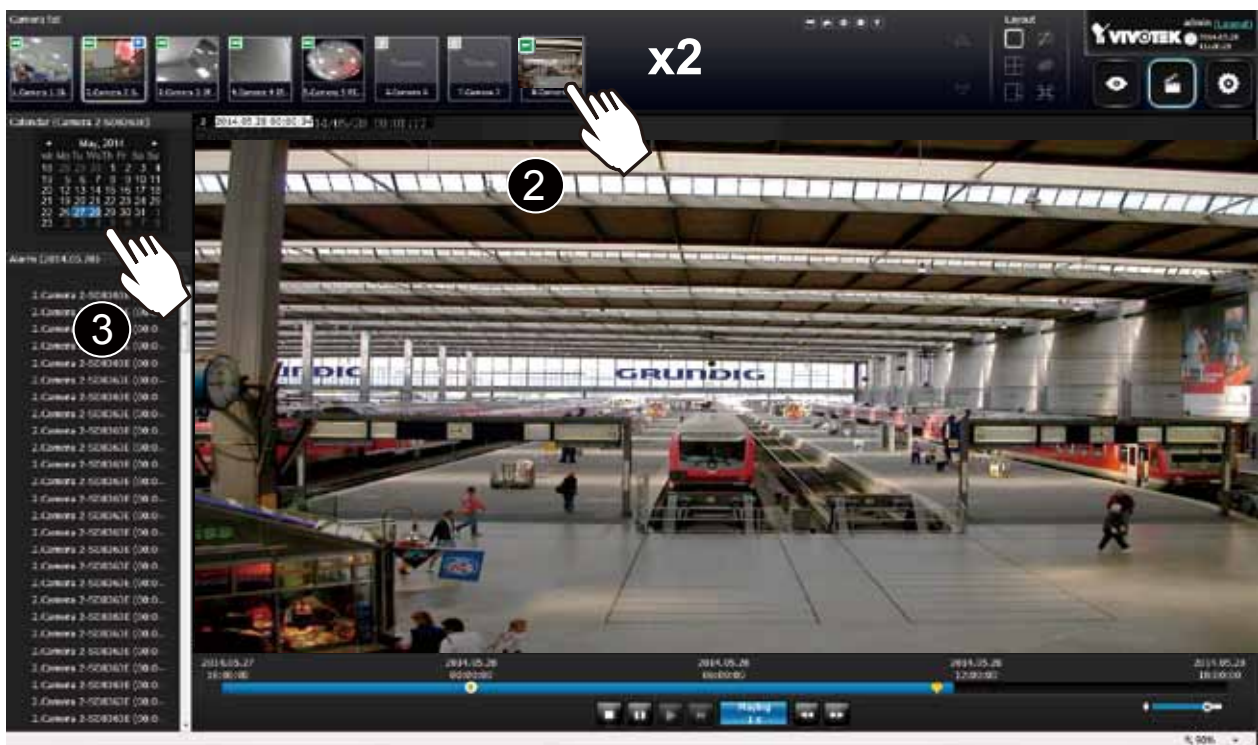



## 6-2-2. Past Alarms and Bookmarks

When you selected a day when alarms took place on a camera, the alarms will be listed on the Alarm panel. Up to 200 entries can be listed on a single page, and a max. of 1,000 entries across multiple pages.

You may then,

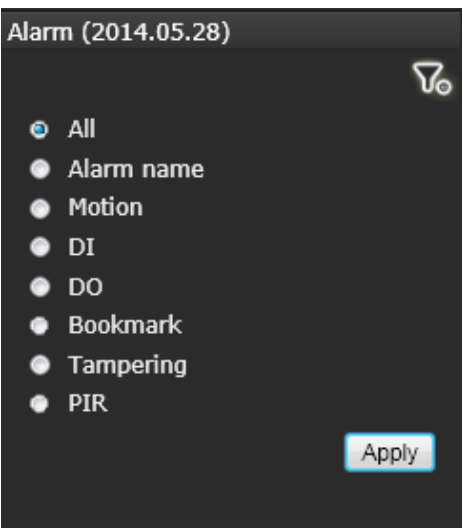
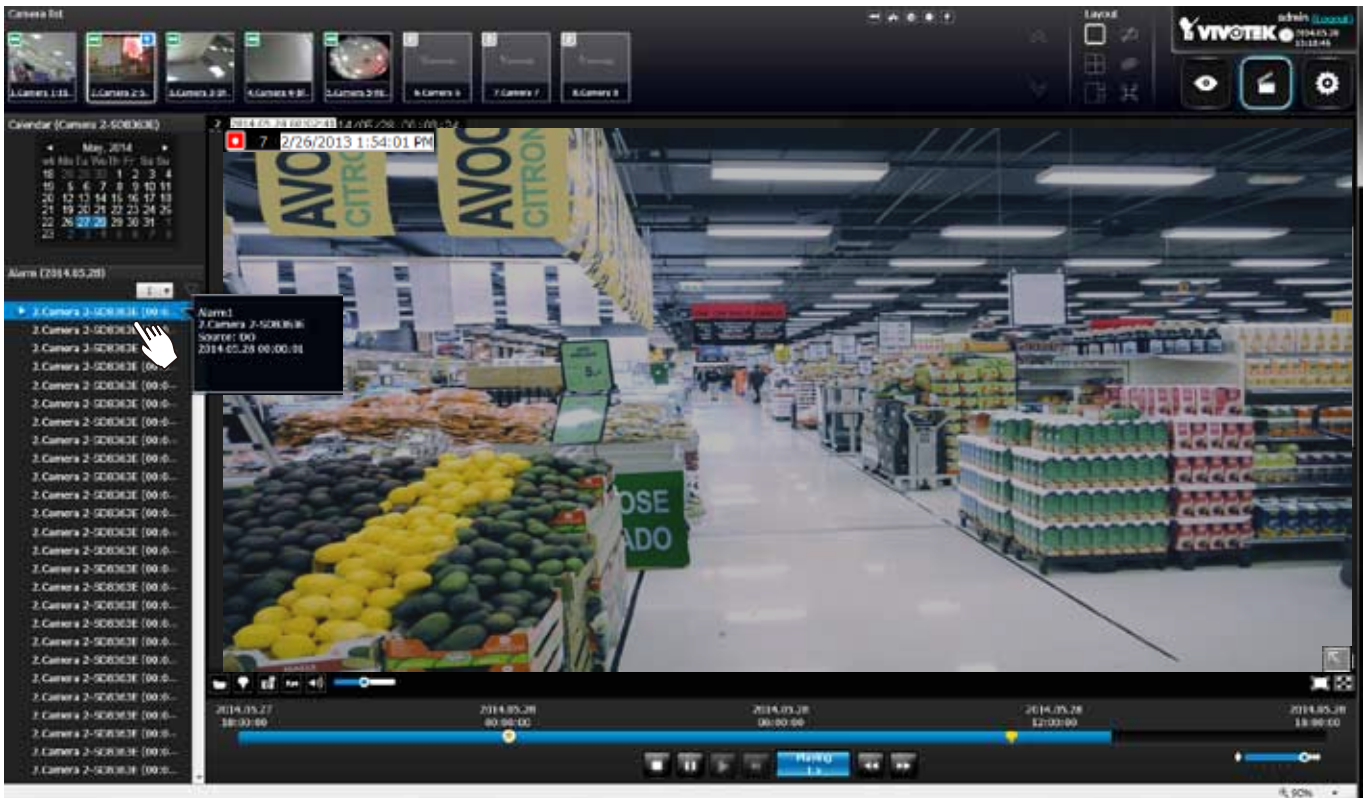
1. Mouse over the alarm thumbnails and click on the play button. The Playback window will then play back the video recorded by the time of the occurrence.
2. Unlike the **Alarm playback** function on the Liveview window, which only plays back the related video for only one minute, the alarm playback will continue throughout the recording of that day.



If you set up multiple triggering sources on a camera, you can use the **Alarm filter**  button to find the alarms of a specific type.

You can select the check circles to narrow down the types of listed alarms using search criteria by **Alarm name, Motion, DI, DO, Bookmark, Tampering, or PIR.**

Note that if searching by the Alarm name, the search does not apply to the camera model name that is automatically appended to the description of an alarm. Only the name of an alarm will apply in the search.

Note that the bookmarks you inserted on the Liveview window will be listed on the Alarm panel, and the bookmarks will also appear on the slide bar of the Playback window.

To retrieve or view the video clip tagged by the bookmark, click on it to play the video that was recorded by the time bookmark was inserted.

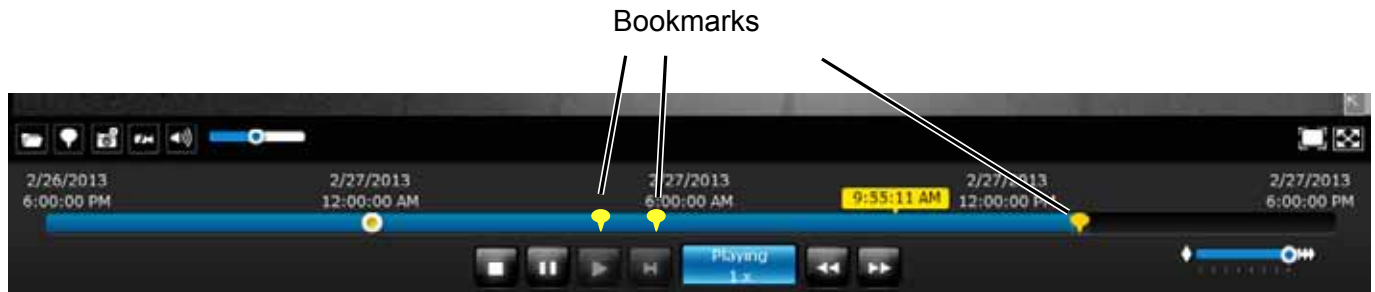

### 6-2-3. Synchronous Playback

The NVR supports synchronous playback, which allows you to review video clips from up to 4 cameras at the same time. These video clips will be retrieved simultaneously all playing for a specific point in time.

To perform synchronous playback:

1. Select a layout from the Layout panel, e.g., a 2x2 layout.
2. Click on the **Synchronous playback**  button.
3. Double-click to select a camera from the camera list. This camera becomes the Master camera.
4. When the Calendar panel appears, click to select a date you prefer.
5. Click and drag other cameras from the camera list to the empty view cells. These cameras will play back videos according to your operation on the Master camera.

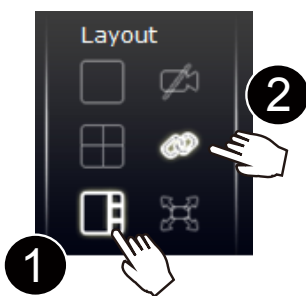

Note the following when using the Synchronous playback:

1. Only the alarms triggered on the Master camera will be shown. In the Synchronous mode, you can not find the alarms or bookmarks generated for other cameras.
2. The playback speed, selection of video clips, and alarm playback of all cameras are made synchronous.

## 6-2-4. Export media

To export video clips,

1. Click on the **Export media**  button on the tool bar, while the Playback window is playing a video section of your interest.
2. An Export media window will prompt.

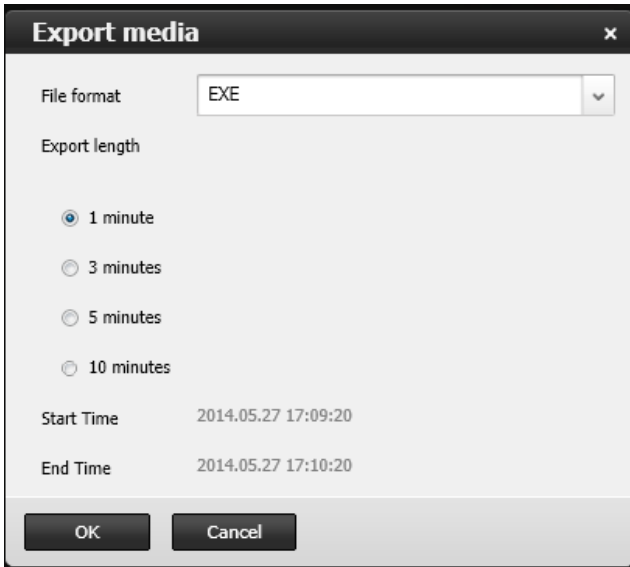

3. Select the file format using the pull-down menu. An **EXE** file is an self-executable file playable by an embedded Media Player. The 3GP format is a multimedia container format for 3G UMTS services. These files can be played on QuickTime, RealPlayer, and VLC. The file name will look like this: [MAC]\_[DATE]\_[TIME]\_[CAMERA\_INDEX].[3gp/exe].
4. Select an export length of video by 1, 3, 5, or 10 minutes. The actual length can be longer due to the fact that the program needs to trace back to the previous I-frame for a complete rendering of video frames into the media.
5. Click **OK** to proceed.
6. System will prompt you for the EXE file. Click **Save** to proceed.

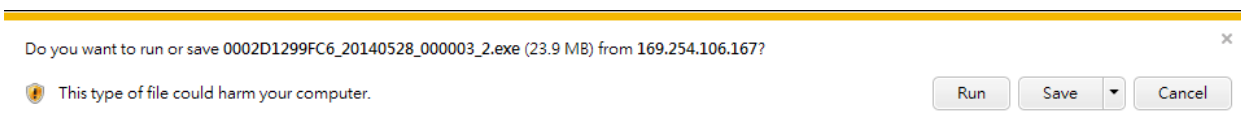

7. The exported media file should be saved to the default download folder.
8. A self-executable EXE file should look like this.



## 6-2-5. Time Search

Use the time line slide bar to find the nearest recording from a specific point in time.

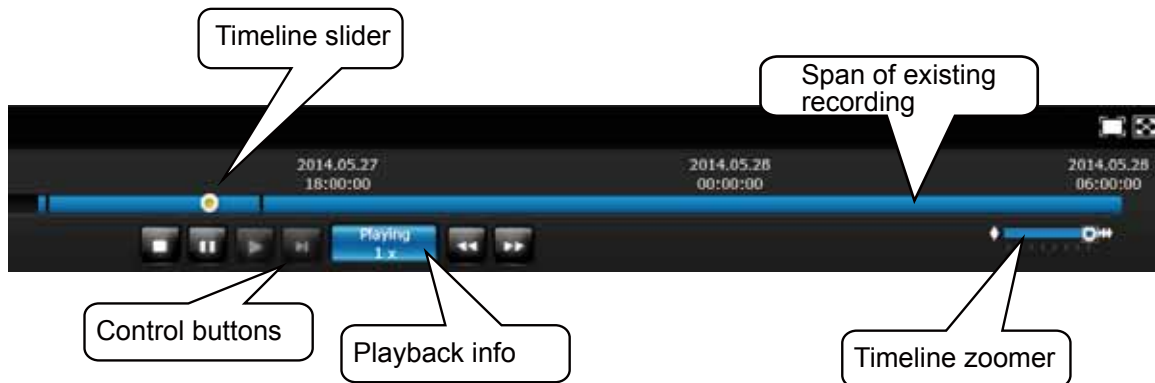

Details of the control bar in the Playback window can be found on [page 130](#).

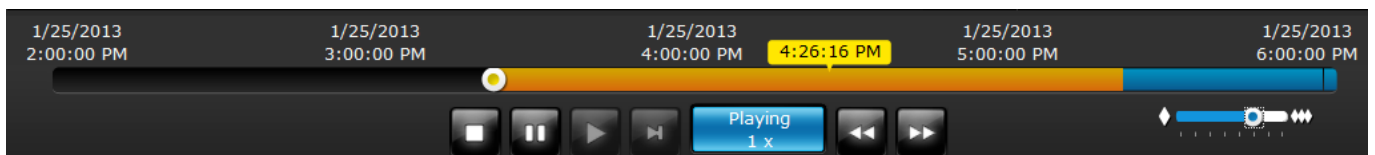

If the need arises to more accurately pin-point the occurrence of an event, you can use the Timeline zoomer and the slider thumb on the time line for a closer view into the existing recording.

	<p>Timeline zoomer. Use the zoomer to zoom in for more precise skimming.</p>
	<p>Timeline slider thumb. Click and drag this thumb button to move along and reach a specific point in time.</p>

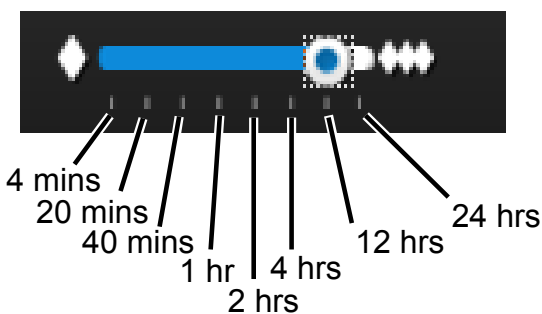

You can use the timeline zoomer to scale down the span of time. For example, if the time span is reduced to 1 hour, then each section on the time line represents 15 minutes of recording. The total time span on a timeline starts from the minimal of 4 minutes, 20 minutes, 40 minutes, 1 hour, and up to a maximum of 24 hours.

In the Synchronous play mode, a change to the zoomer will be reflected by all synchronously playing view cells.



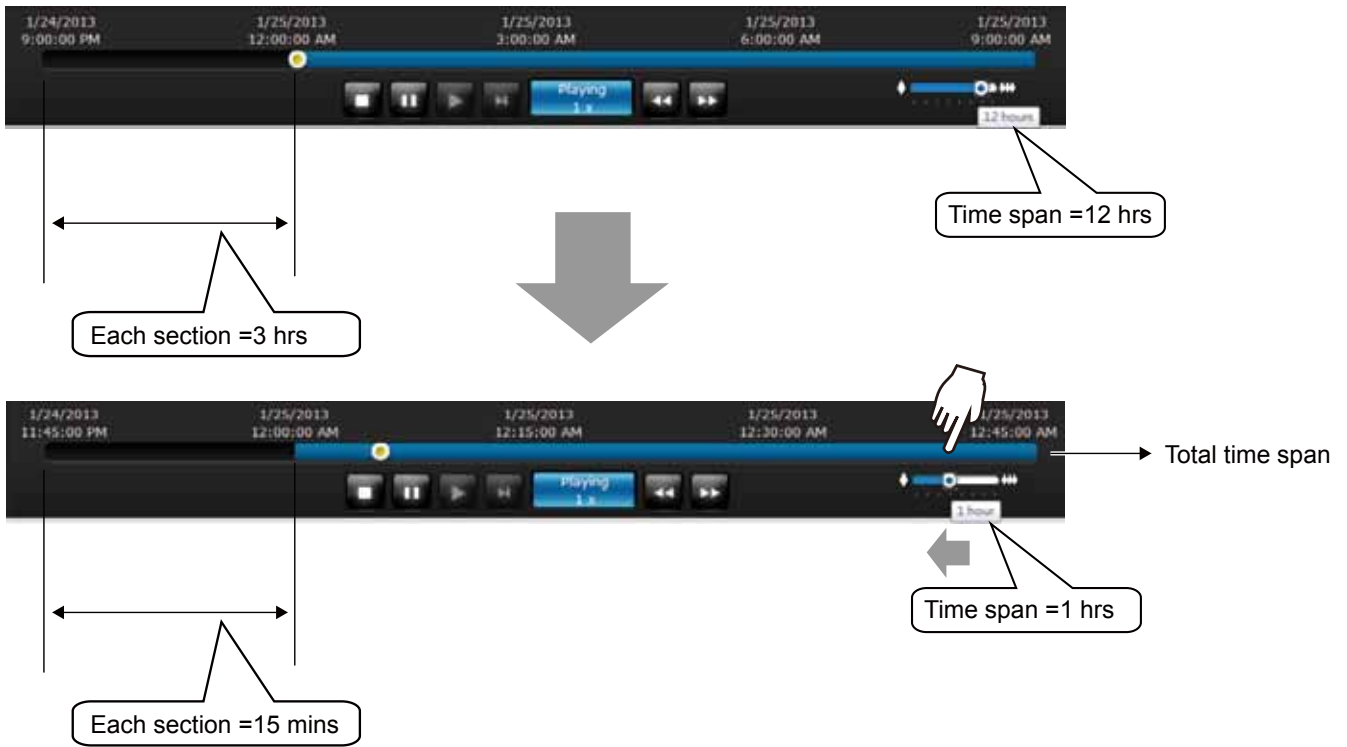

If recordings take place by an event-triggered recording, the intervals between recordings can be down to 1 minute, and the individual recordings will not be easily discernible. In this situation, you can mouse over the timeline to pin-point individual recording instances.

# Technical Specifications

## Hardware Information

Model	ND8322P
<b>System</b>	
OS	Embedded Linux
CPU	ARM Processor
Flash	256MB
RAM	1GB
Watchdog	Hardware + Software
Power Restoration	System Restart Automatically after Power Recovery
<b>Storage</b>	
HDD Devices	Internal x2
HDD Max. Capacity	6TB x2
Disk Management	Create, Format and Remove Disk HDD S.M.A.R.T
<b>Video</b>	
Video Output	1 x HDMI, 1 x VGA
Resolution	1920 x 1080, 1280 x 720
Graphics Decoder	Hardware decoding
Decoding Capacity	H.264: 2560 x 1920 @ 30 fps (1-CH) 1920 x 1080 @ 120 fps (4-CH) 1280 x 720 @ 240 fps (8-CH)
Camera Position	Change the viewcell position on the Live View screens
<b>External Interface</b>	
USB Interface	Front: 2 (USB 2.0) Back: 1 (USB 2.0)
Alarm In	8
Alarm Out	4
Audio	1 x 3.5 Phone Jack Audio Output 1 x 3.5 Phone Jack Audio Input (Reserved)
External HDD	1 x eSATA Port
RS232	1 Port (Reserved)
RS485	1 Port (Reserved)
<b>Network</b>	
Network Interface	1 x RJ-45 10/100/1000Mbps Ethernet Interface
PoE	8x 802.3af Compliant PoE Ports (Total Max. 80W)

Protocols	IPv4, TCP/IP, HTTP, HTTPS, UPnP, RTPSP/RTP/RTCP, SMTP, FTP, DHCP, NTP, DNS, DDNS, IP Filter
<b>Power</b>	
Power Input	DC5V 2.5A
Power Consumption	Max. 120W
<b>LED Indicator</b>	
LED Indicator	Power, Status, Record, HDD1, HDD2, eSATA, Ethernet, Port1-Port8
<b>Mechanic</b>	
Form Factor	Desktop
Operation Buttons	Power (Front) / Reset (Back)
Dimensions	360 mm (W) x 311 mm (D) x 44 mm (H)
Weight	2.7 kg (without HDD)
Operating Temperature	0°C ~ 40°C (32°F ~ 104°F)
Humidity	0-95%
<b>General</b>	
Safety Certifications	CE, LVD, FCC, VCCI, C-Tick
Warranty	24 months
<b>Client PC Requirements</b>	
Operating System	Microsoft Windows OS: XP/Vista/7/8/2008/2012
CPU	Intel Celeron or above
Memory	2 GB or above
Ethernet	10/100Mbps
Display Resolution	1024 x 768 pixels or above
Web Browser	Internet Explorer 10 (32 bit) or above
Software AP	Installation Wizard 2, ST 7501, VAST
Mobile APP, Tablet APP	EZconnect, iViewer (iOS) EZconnect, iViewer (Android)
<b>Accessories</b>	
CD	User's Manual, Quick Installation Guide (QIG), Installation Wizard 2
Others	Power Adapter, Power Cord, Quick Installation Guide, 16 x H.D.D. Screws, 4 x H.D.D. Brackets, 1 x USB Mouse, 2 x SATA Cables

## Software Information

<b>Record</b>	
Maximum Channel	8
Record Throughput (MB)	64 Mbps
Network Throughput (MB)	48 Mbps
Audio Format	G.711, G.726
Video Format	MJPEG, H.264
Video Resolution	VGA, 1MP, 2MP, 3MP & 5MP Camera
Recording Time (sec.)	Pre-Record: 5 (max. 10) Post-Record: 20 (max. 300)
Recording Stream	Single
Recording Mode	Continuous, Schedule, Manual, Event, Activity Adaptive Streaming
Recording Setting	Recycle (Unit: Day)
Recording Path	Local Path
Record Video Format	3GP
<b>LiveView (Local Display)</b>	
Stream Application	Auto Adaptive Stream
LiveView Display	8 Channel Multi Layout display: 1x1, 1x3 (Corridor View), 2x2, 3x3, 1+5, 1+3, 1+1+3 (1P), 1+3+3 (1P)
Monitor Enhancement	OSD Display (NVR), OSD Display (Camera), Camera Information, Remote I/O Control, Event Notification, Aspect Ratio
PTZ Control	Panel Control
PTZ Operation	Direction Control, Home, Iris, Preset, Patrol (Group), PIP Control
<b>Playback (Local Display)</b>	
Playback Display	1 Channel Multi Layout Display: 1x1
Playback Control	Regular (Play, Pause, Stop), Rewind, Next / Previous Frame, Speed Control, Calendar, Event, Timeline, Timeline Scale, Thumbnail (Storyboard)
Video Search	By calendar, by date/time, by alarm
Thumbnail Explorer (Storyboard)	Listing the thumbnail of recorded video (Max. 2 CH)
Monitor Enhancement	OSD Display (Camera), Event Notification, Aspect Ratio, PIP Control
Snapshot	JPEG
Video Clip Export	EXE
<b>LiveView (Remote)</b>	
Stream Application	Stream Selection
Audio Capability	One Way
LiveView Display	8 Channel Multi Layout display: 1x1, 2x2, 3x3, 1+3, 1+5
Monitor Enhancement	OSD Display (NVR), Drag & Drop, Image Freeze, Audio Control, Remote I/O Control, Event Notification, Bookmark
PTZ Control	Panel Control
PTZ Operation	Direction Control, Home, Zoom, Focus, Iris, Preset, Patrol (Group), PIP Control
Snapshot	JPEG
<b>Playback (Remote)</b>	
Playback Display	4 Channel Multi Layout display: 1x1, 2x2, 1+3
Playback Control	Regular (Play, Pause, Stop), Next Frame, Speed Control, Calendar, Timeline, Timeline Scale, Bookmark

Monitor Enhancement	OSD Display (NVR), Drag & Drop, Audio Control, PIP Control
Snapshot	JPEG
Video Clip Export	EXE
<b>Alarm Management</b>	
Schedule Type	Continuous, Schedule, Manual
Event	Motion Detection, PIR Detection, Tampering Detection, Digital Input (Camera), Digital Output (Camera), Connection Abnormal, Storage Abnormal, Storage Full, Camera Network Loss, DI, DO
Action	Record, Email (Text), Email (Snapshot), FTP, Buzzer, PTZ Control (Go to Preset), NVR DO, Camera DO
Recording Time (sec.)	Pre-Record: 5 (max. 10), Post-Record: 20 (max. 300)
<b>Backup</b>	
Manual	USB Dongle (FAT Format)
<b>System</b>	
User Management	User Account: 10 User Account Time Limit: 10 mins User Level: Administrator / Regular User User Feature Definition: By Camera
Log	System, Recording, User, Error
Date&Time	Time Zone, Manual, Automatic Sync NTP, Daylight Saving Time
Firmware	Manual update
Restore Default	Supported
Backup/Restore (Configuration)	Supported
Language	English, French, German, Italian, Japanese, Portuguese, Russian, Spanish, Simplified Chinese, Traditional Chinese, Korean, Czech
<b>Camera Intergration</b>	
Insert Camera	Manual, Search
Video (Media) Setting	Compression, Resolution, FPS, Video Quality
Image Setting	Image Display Image Adjustment
PTZ Control	Panel Control
PTZ Operation	Direction Control, Home, Preset, Patrol (Group)
Motion Detection	Supported
<b>Device Intergration</b>	
UPS	APC Model Compatible

## Dimensions

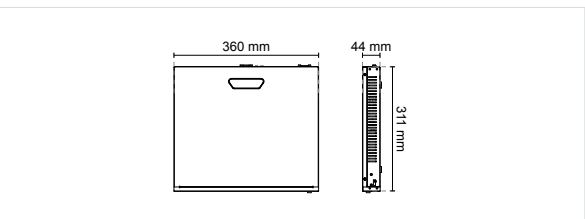

All specifications are subject to change without notice. Copyright © VIVOTEK INC. All rights reserved.

Ver. 9



**VIVOTEK INC.**  
6F, No.192, Lien-Cheng Rd., Chung-Ho,  
New Taipei City, 235, Taiwan, R.O.C.  
T: +886-2-8245282 F: +886-2-82455532  
E: sales@vivotek.com

**VIVOTEK USA**  
2050 Ringwood Avenue,  
San Jose, CA 95131  
T: 408-773-8686 F: 408-773-8298  
E: salesusa@vivotek.com

**VIVOTEK Europe**  
Randstad 22-133, 1316BW Almere,  
The Netherlands  
T: +31(0)36-5298-434  
E: saleseurope@vivotek.com

**VIVOTEK India**  
602, Best sky Tower, Plot No. F-5,  
Netaji Subhash Place, Pitam Pura, Delhi-110 034  
T: +91-11-45137465  
E: salesindia@vivotek.com

### Hardware Information

<b>Model</b>	ND8422P	<b>Protocols</b>	IPv4, TCP/IP, HTTP, HTTPS, UPnP, RTSP/RTP/RTCP, SMTP, FTP, DHCP, NTP, DNS, DDNS, IP Filter
<b>System</b>		<b>Power</b>	
<b>OS</b>	Embedded Linux	<b>Power Input</b>	DC56V 2.5A
<b>CPU</b>	ARM Processor	<b>Power Consumption</b>	Max. 120W
<b>Flash</b>	256MB	<b>LED Indicator</b>	
<b>RAM</b>	2GB	<b>LED Indicator</b>	Power, Status, Record, HDD1, HDD2, eSATA, Ethernet, Port1~Port8
<b>Watchdog</b>	Hardware + Software	<b>Mechanic</b>	
<b>Power Restoration</b>	System Restart Automatically after Power Recovery	<b>Form Factor</b>	Desktop
<b>Storage</b>		<b>Operation Buttons</b>	Power (Front) / Reset (Back)
<b>HDD Devices</b>	Internal x2	<b>Dimensions</b>	360 (W) x 311 (D) x 44 (H) mm
<b>HDD Max. Capacity</b>	6TB x2	<b>Weight</b>	2.7 kg (without HDD)
<b>Disk Management</b>	Create, Format and Remove Disk HDD S.M.A.R.T	<b>Operating Temperature</b>	0°C ~ 40°C (32°F ~ 104°F)
<b>Video</b>		<b>Humidity</b>	0 ~ 95%
<b>Video Output</b>	1 x HDMI, 1 x VGA	<b>General</b>	
<b>Resolution</b>	1920 x 1080, 1280 x 720	<b>Safety Certifications</b>	CE, LVD, FCC, VCCI, C-Tick
<b>Graphics Decoder</b>	Hardware decoding	<b>Warranty</b>	24 months
<b>Decoding Capacity</b>	H.264: 2560 x 1920 @ 30 fps (1-CH) 1920 x 1080 @ 120 fps (4-CH) 1280 x 720 @ 240 fps (8-CH) 720 x 480 @ 480 fps (16-CH)	<b>Client PC Requirements</b>	
<b>Camera Position</b>	Change the viewcell position on the Live View screens	<b>Operating System</b>	Microsoft Windows OS: XP/Vista/7/8/2008/2012
<b>External Interface</b>		<b>CPU</b>	Intel Celeron or above
<b>USB Interface</b>	Front: 2 (USB 2.0) Back: 1 (USB 2.0)	<b>Memory</b>	2 GB or above
<b>Alarm In</b>	8	<b>Ethernet</b>	10/100Mbps
<b>Alarm Out</b>	4	<b>Display Resolution</b>	1024 x 768 pixels or above
<b>Audio</b>	1 x 3.5 Phone Jack Audio Output 1 x 3.5 Phone Jack Audio Input (Reserved)	<b>Web Browser</b>	Internet Explorer 10 (32 bit) or above
<b>External HDD</b>	1 x eSATA Port	<b>Software AP</b>	Installation Wizard 2, ST7501, VAST
<b>RS232</b>	1 Port (Reserved)	<b>Mobile APP, Tablet APP</b>	EZconnect, iViewer (iOS) EZconnect, iViewer (Android)
<b>RS485</b>	1 Port (Reserved)	<b>Accessories</b>	
<b>Network</b>		<b>CD</b>	User's Manual, Quick Installation Guide (QIG), Installation Wizard 2
<b>Network interface</b>	1 x RJ-45 10/100/1000Mbps Ethernet interface	<b>Others</b>	Power Adapter, Power Cord, Quick Installation Guide, 16 x H.D.D. Screws, 4 x H.D.D. Brackets, 1 x USB Mouse, 2 x SATA Cables
<b>PoE</b>	8x 802.3af Compliant PoE Ports (Total Max. 80W)		

### Software Information

<b>Record</b>		<b>Playback Control</b>	Regular (Play, Pause, Stop), Next Frame, Speed Control, Calendar, Timeline, Timeline Scale, Bookmark
<b>Maximum Channel</b>	16	<b>Monitor Enhancement</b>	OSD Display (NVR), Drag & Drop, Audio Control, PIP Control
<b>Record Throughput (MB)</b>	96 Mbps	<b>Snapshot</b>	JPEG
<b>Network Throughput (MB)</b>	48 Mbps	<b>Video Clip Export</b>	EXE
<b>Audio Format</b>	G.711, G.726	<b>Alarm Management</b>	
<b>Video Format</b>	MJPEG, H.264	<b>Schedule Type</b>	Continuous, Schedule, Manual
<b>Video Resolution</b>	VGA, 1MP, 2MP, 3MP & 5MP Camera	<b>Event</b>	Motion Detection, PIR Detection, Tampering Detection, Digital Input (Camera), Digital Output (Camera), Connection Abnormal, Storage Abnormal, Storage Full, Camera Network Loss, DI, DO
<b>Recording Time (sec.)</b>	Pre-Record: 5 (max. 10) Post-Record: 20 (max. 300)	<b>Action</b>	Record, Email (Text), Email (Snapshot), FTP, Buzzer, PTZ Control (Go to Preset), NVR DO, Camera DO
<b>Recording Stream</b>	Single	<b>Recording Time (sec.)</b>	Pre-Record: 5 (max. 10), Post-Record: 20 (max. 300)
<b>Recording Mode</b>	Continuous, Schedule, Manual, Event, Activity Adaptive Streaming	<b>Backup</b>	
<b>Recording Setting</b>	Recycle (unit: Day)	<b>Manual</b>	USB Dongle (FAT Format)
<b>Recording Path</b>	Local Path	<b>System</b>	
<b>Record Video Format</b>	3GP	<b>User Management</b>	User Account: 16 User Account Time Limit: 10 mins User Level: Administrator / Regular User User Feature Definition: By Camera
<b>LiveView (Local Display)</b>		<b>Log</b>	System, Recording, User, Error
<b>Stream Application</b>	Auto Adaptive Stream	<b>Date&amp;Time</b>	Time Zone, Manual, Automatic Sync NTP, Daylight Saving Time
<b>LiveView Display</b>	16 Channel Multi Layout display: 1x1, 1x3 (Corridor View), 2x2, 3x3, 4x4, 1+5, 1+3, 1+12, 1+1+3 (1P), 1+3+3 (1P) *Not support dewarp function from fisheye cameras	<b>Firmware</b>	Manual update
<b>Monitor Enhancement</b>	OSD Display (NVR), OSD Display (Camera), Camera Information, Remote I/O Control, Event Notification, Aspect Ratio	<b>Restore Default</b>	Supported
<b>PTZ Control</b>	Panel Control	<b>Backup/Restore (Configuration)</b>	Supported
<b>PTZ Operation</b>	Direction Control, Home, Iris, Preset, Patrol (Group), PIP Control	<b>Language</b>	English, French, German, Italian, Japanese, Portuguese, Russian, Spanish, Simplified Chinese, Traditional Chinese, Korean, Czech
<b>Playback (Local Display)</b>		<b>Camera Intergration</b>	
<b>Playback Display</b>	1 Channel Multi Layout Display: 1x1	<b>Insert Camera</b>	Manual, Search
<b>Playback Control</b>	Regular (Play, Pause, Stop), Rewind, Next / Previous Frame, Speed Control, Calendar, Event, Timeline, Timeline Scale, Thumbnail (Storyboard)	<b>Video (Media) Setting</b>	Compression, Resolution, FPS, Video Quality
<b>Video Search</b>	By calendar, by date/time, by alarm	<b>Image Setting</b>	Image Display Image Adjustment
<b>Thumbnail Explorer (Storyboard)</b>	Listing the thumbnail of recorded video (Max. 2 CH)	<b>PTZ Control</b>	Panel Control
<b>Monitor Enhancement</b>	OSD Display (Camera), Event Notification, Aspect Ratio, PIP Control	<b>PTZ Operation</b>	Direction Control, Home, Preset, Patrol (Group)
<b>Snapshot</b>	JPEG	<b>Motion Detection</b>	Supported
<b>Video Clip Export</b>	EXE	<b>Device Intergration</b>	
<b>LiveView (Remote)</b>		<b>UPS</b>	APC Model Compatible
<b>Stream Application</b>	Stream Selection		
<b>Audio Capability</b>	One Way		
<b>LiveView Display</b>	16 Channel Multi Layout display: 1x1, 2x2, 3x3, 4x4, 1+3, 1+5, 1+12		
<b>Monitor Enhancement</b>	OSD Display (NVR), Drag & Drop, Image Freeze, Audio Control, Remote I/O Control, Event Notification, Bookmark		
<b>PTZ Control</b>	Panel Control		
<b>PTZ Operation</b>	Direction Control, Home, Zoom, Focus, Iris, Preset, Patrol (Group), PIP Control		
<b>Snapshot</b>	JPEG		
<b>Playback (Remote)</b>			
<b>Playback Display</b>	4 Channel Multi Layout display: 1x1, 2x2, 1+3		

### Dimensions

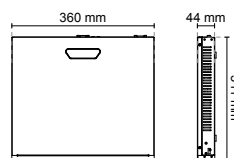

All specifications are subject to change without notice. Copyright © VIVOTEK INC. All rights reserved.



**VIVOTEK INC.**  
6F, No.192, Lien-Cheng Rd., Chung-Ho,  
New Taipei City, 235, Taiwan, R.O.C.  
T: +886-2-82455282 F: +886-2-82455532  
E: sales@vivotek.com

**VIVOTEK USA**  
2050 Ringwood Avenue,  
San Jose, CA 95131  
T: 408-773-8686 F: 408-773-8298  
E: salesusa@vivotek.com

**VIVOTEK Europe**  
Randstad 22-133, 1316BW Almere,  
The Netherlands  
T: +31(0)36-5298-434  
E: sales@vivotek.com

**VIVOTEK India**  
602, Best sky Tower, Plot No. F-5,  
Netaji Subhash Place, Pitam Pura, Delhi-110 034  
T: +91-11-45137465  
E: salesindia@vivotek.com

Ver. 2

## Safety and Compatibility



### Federal Communications Commission (FCC) Statement

This Equipment has been tested and found to comply with the limits for a Class A digital device, pursuant to Part 15 of the FCC rules. These limits are designed to provide reasonable protection against harmful interference when the equipment is operated in a commercial environment. This equipment generates, uses and can radiate radio frequency energy and, if not installed and used in accordance with the instructions, may cause harmful interference to radio communications. Operation of this equipment in a residential area is likely to cause harmful interference in which case the user will be required to correct the interference at his own expense.

### Warning:

[A shielded-type power cord is required in order to meet FCC emission limits and also to prevent interference to the nearby radio and television reception. It is essential that only the supplied power cord be used. ]

[Use only shielded cables to connect I/O devices to this equipment.]

You are cautioned that changes or modifications not expressly approved by the party responsible for compliance could void your authority to operate the equipment.

[ ]: depend on EUT condition.



### Information on Disposal for Users of Waste Electrical & Electronic Equipment (private households)

This symbol on the products and/or accompanying documents means that used electrical and electronic products should not be mixed with general household waste.

For proper treatment, recovery and recycling, please take these products to designated collection points, where they will be accepted on a free of charge basis. Alternatively, in some countries you may be able to return your products to your local retailer upon the purchase of an equivalent new product.

Disposing of this product correctly will help to save valuable resources and prevent any potential negative effects on human health and the environment which could otherwise arise from inappropriate waste handling. Please contact your local authority for further details of your nearest designated collection point.

Penalties may be applicable for incorrect disposal of this waste, in accordance with national legislation.

### For business users in the European Union

If you wish to discard electrical and electronic equipment, please contact your dealer or supplier for further information.

### Information on Disposal in other Countries outside the European Union

This symbol is only valid in the European Union. If you wish to discard this product, please contact your local authorities or dealer and ask for the correct method of disposal.

**Japan VCCI Class A statement**

この装置は、クラス A 情報技術装置です。この装置を家庭環境で使用すると電波妨害を引き起こすことがあります。この場合には使用者が適切な対策を講ずるよう要求されることがあります。 VCCI-A



**ACA (Australian Communications Authority)**

**CAUTION**  
**RISK OF EXPLOSION IF BATTERY IS REPLACED**  
**BY AN INCORRECT TYPE.**  
**DISPOSE OF USED BATTERIES ACCORDING TO THE INSTRUCTIONS**