

EN

User manual

Washing Machine

USER MANUAL

ZWH 6130 P

ZANUSSI

Contents

| | | | |
|----------------------------|---|--------------------------|----|
| Safety information _____ | 2 | First use _____ | 12 |
| Safety instructions _____ | 3 | Daily use _____ | 12 |
| Frost precaution _____ | 4 | Washing programmes _____ | 19 |
| Environment concerns _____ | 5 | Consumption values _____ | 21 |
| Product description _____ | 6 | Care and cleaning _____ | 22 |
| Technical data _____ | 7 | What to do if... _____ | 24 |
| Installation _____ | 7 | | |

Subject to change without notice.

Safety information

Before the installation and use of the appliance, carefully read the supplied instructions. The manufacturer is not responsible if an incorrect installation and use causes injuries and damages. Always keep the instructions with the appliance for future reference.

Children and vulnerable people safety

 **Warning!** Risk of suffocation, injury or permanent disability.

- Do not let persons, children included, with reduced physical sensory, reduced mental functions or lack of experience and knowledge use the appliance. They must have supervision or instruction for the operation of the appliance by a person who is responsible for their safety.
- Do not let children play with the appliance.
- Keep all packaging away from children.
- Keep all detergents away from children.
- Keep children and pets away from the appliance door when it is open.
- If the appliance has a child safety device, we recommend you activate it.

General Safety

- Before maintenance, deactivate the appliance and disconnect the mains plug from the mains socket.
- Do not change the specification of this appliance.

- Obey the maximum load volume of 7 kg (refer to the “Programme chart” chapter).
- If the supply cord is damaged, it must be replaced by the manufacturer, its service agent or similarly qualified persons in order to avoid a hazard.
- The operating water pressure (minimum and maximum) must be between 0,5 bar (0,05 MPa) and 8 bar (0,8 MPa)
- The ventilation openings in the base (if applicable) must not be obstructed by a carpet.
- The appliance is to be connected to the water mains using the new supplied hose-sets. Old hose sets must not be reused.



Safety instructions

Installation

- Remove all the packaging and the transit bolts.
- Keep the transit bolts. When you move the appliance again you must block the drum.
- Do not install or use a damaged appliance.
- Do not install or use the appliance where the temperature is less than 0 °C or where it is exposed to the weather.
- Obey the installation instruction supplied with the appliance.
- Make sure that the floor where you install the appliance is flat, stable, heat resistant and clean.
- Do not install the appliance where the appliance door can not be fully opened.
- Always be careful when you move the appliance because it is heavy. Always wear safety gloves.
- Make sure that there is air circulation between the appliance and the floor.
- Adjust the feet to have the necessary space between the appliance and the carpet.

Electrical connection



Warning! Risk of fire and electrical shock.

- The appliance must be earthed.
- Make sure that the electrical information on the rating plate agrees with the power supply. If not, contact an electrician.
- Always use a correctly installed shockproof socket.
- Do not use multi-plug adapters and extension cables.
- Make sure not to cause damage to the mains plug and to the mains cable. Should the appliance power supply cable need to be replaced, this must be carried out by our Service Centre.
- Connect the mains plug to the mains socket only at the end of the installation. Make sure that there is access to the mains plug after the installation.
- Do not pull the mains cable to disconnect the appliance. Always pull the mains plug.
- Do not touch the mains cable or the mains plug with wet hands.
- Only for UK and Ireland. The appliance has a 13 amp mains plug. If it is necessary to change the fuse in the mains plug, use a 13 amp ASTA (BS 1362) fuse.

This appliance complies with the E.E.C. Directives.

Water connection

- Make sure not to cause damage to the water hoses.
- The appliance is to be connected to the water mains using the new supplied hose-sets. Old hose sets must not be reused.
- Before you connect the appliance to new pipes or pipes not used for a long time, let the water flow until it is clean.
- The first time you use the appliance, make sure that there is no leakage.

Use

 **Warning!** Risk of injury, electrical shock, fire, burns or damage to the appliance.

- Use this appliance in a household environment.
- Obey the safety instructions on the detergent packaging.
- Do not put flammable products or items that are wet with flammable products in, near or on the appliance.
- Do not touch the glass of the door while a programme operates. The glass can be hot.
- Make sure that you remove all metal objects from the laundry.

Frost precaution

If the appliance is installed in a place where the temperature could drop below 0°C, proceed as follows to remove any water remaining inside the appliance:

1. unplug the appliance;
2. turn off the water tap;
3. unscrew the water inlet hose from the tap;
4. unscrew the drain hose from the rear support and unhook it from sink or spigot;

- Do not put a container to collect possible water leakage under the appliance. Contact the Service to ensure which accessories can be used.

Care and Cleaning

 **Warning!** Risk of injury or damage to the appliance.

- Do not use water spray and steam to clean the appliance.
- Clean the appliance with a moist soft cloth. Only use neutral detergents. Do not use abrasive products, abrasive cleaning pads, solvents or metal objects.

Disposal

 **Warning!** Risk of injury or suffocation.

- Disconnect the appliance from the mains supply.
- Cut off the mains cable and discard it.
- Remove the door catch to prevent children and pets to get closed in the appliance.

Service

- Contact the Service to repair the appliance. We recommend only the use of original spare parts.

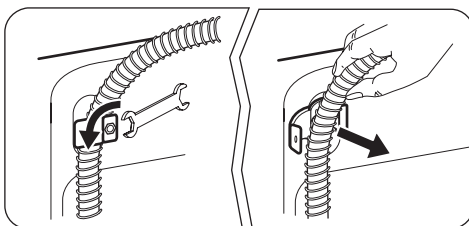

5. place a bowl on the floor;
6. let the drain hose run along the floor, place the external extremities of the drain and inlet hoses in the bowl placed on the floor and let water drain out completely;

7. screw the water inlet hose to the tap and the drain hose to the rear of the appliance again;

When you intend to start the appliance up again, make sure that the room temperature is above 0°C.

Environment concerns

The symbol  on the product or on its packaging indicates that this product may not be treated as household waste. Instead it should be taken to the appropriate collection point for the recycling of electrical and electronic equipment. By ensuring this product is disposed of correctly, you will help prevent potential negative consequences for the environment and human health, which could otherwise be caused by inappropriate waste handling of this product. For more detailed information about recycling of this product, please contact your local council, your household waste disposal service or the shop where you purchased the product.

Packaging materials

The materials marked with the symbol  are recyclable.

>PE<=polyethylene

>PS<=polystyrene

>PP<=polypropylene

This means that they can be recycled by disposing of them properly in appropriate collection containers.

Ecological hints

To save water, energy and to help protect the environment, we recommend that you follow these tips:

- Normally soiled laundry may be washed without prewashing in order to save detergent, water and time (the environment is protected too!).
- The machine works more economically if it is fully loaded.
- With adequate pre-treatment, stains and limited soiling can be removed; the laundry can then be washed at a lower temperature.
- Measure out detergent according to the water hardness, the degree of soiling and the quantity of laundry being washed.

Product description

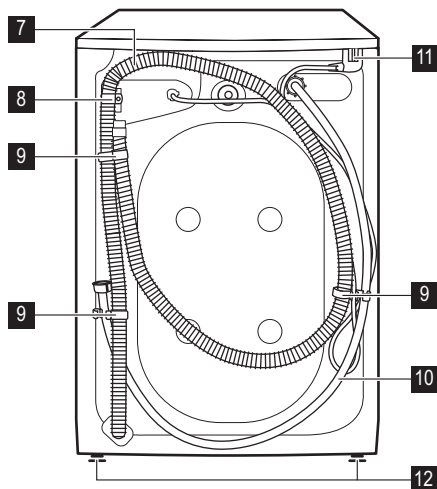
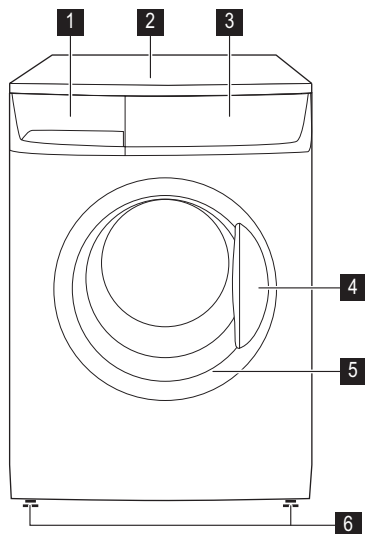

- 1 Detergent dispenser drawer
- 2 Worktop
- 3 Control panel
- 4 Door opening handle
- 5 Rating plate (on the inner edge)
- 6 Front adjustable feet

- 7 Water drain hose
- 8 Drain hose support
- 9 Hose holders
- 10 Water inlet hose
- 11 Mains cable
- 12 Back feet

Child safety device

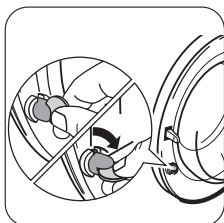

To **activate** this device, rotate the button (without pressing it) inside the door clockwise until the groove is horizontal. If necessary use a coin.

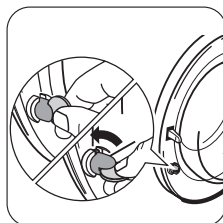

To **disable** this device and restore the possibility of closing the door, rotate the button anti-clockwise until the groove is vertical.

Technical data

| | | |
|---|---|-------------------------|
| Dimensions | Width Height Depth | 60 cm 85 cm 54 cm |
| Electrical connection Voltage - Overall power - Fuse | Information on the electrical connection is given on the rating plate, on the inner edge of the appliance door. | |
| Water supply pressure | Minimum Maximum | 0,05 MPa 0,8 MPa |
| Maximum Load | Cotton | 7 kg |
| Spin Speed | Maximum | 1300 rpm |

Installation

Unpacking



Warning!

- Read carefully the "Safety information" chapter before installing the appliance.

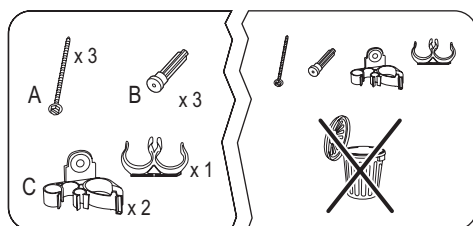

Warning! Remove and keep all transit devices

so that they can be re-fitted if the appliance ever has to be transported again.

Necessary tools

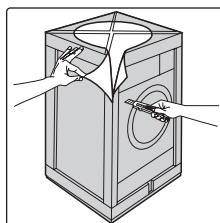
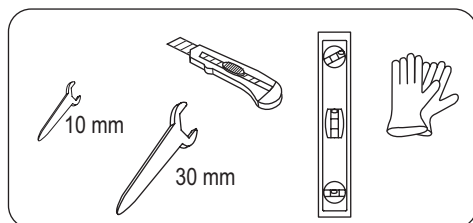

- Remove the external film. Use a cutter, if necessary.

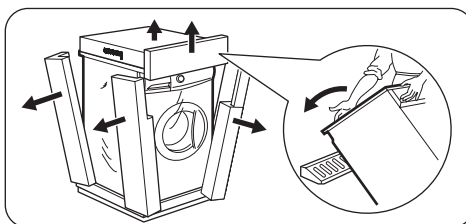

- Remove the cardboard top.
- Remove the polystyrene packaging materials.

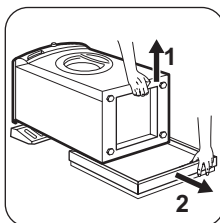

- Spread the front piece on the floor behind the appliance and then lay the appliance carefully rear side down on it. Make sure that no hoses are crushed in the process.

- Remove the polystyrene base from the bottom.

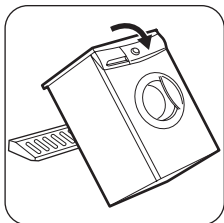

- Return appliance to its upright position.

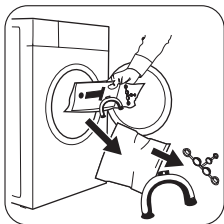

- Open the door and remove the plastic hose guide, the bag containing the instruction booklet and the plastic plug caps from the drum.

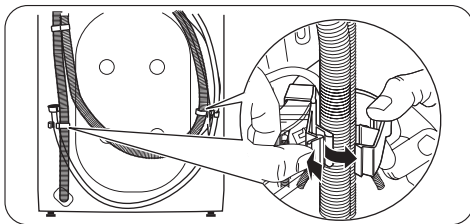

- Remove the power supply cable and the draining and inlet hose from the hose holders on the rear of the appliance.

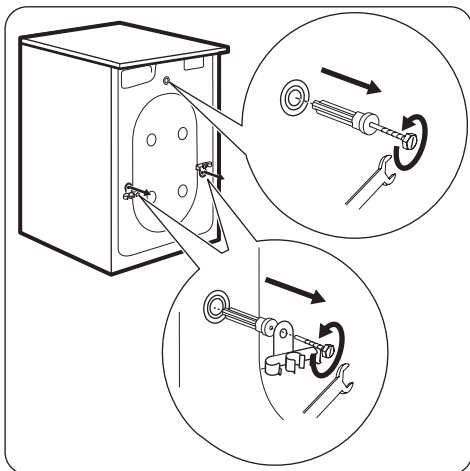

- Unscrew the three bolts and remove the hose holders.
- Slide out the relevant plastic spacers.

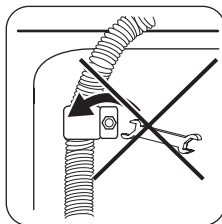

Warning! Do not remove the drain hose from the rear support. Remove this hose only if it is necessary to drain the water. Refer to "Frost precaution" and "What to do if".

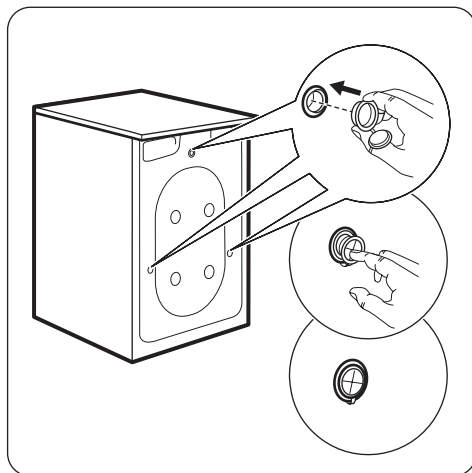
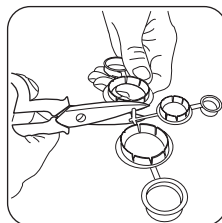

- Plug the smaller upper hole and the two large ones with the corresponding plastic plug caps.

Positioning and levelling

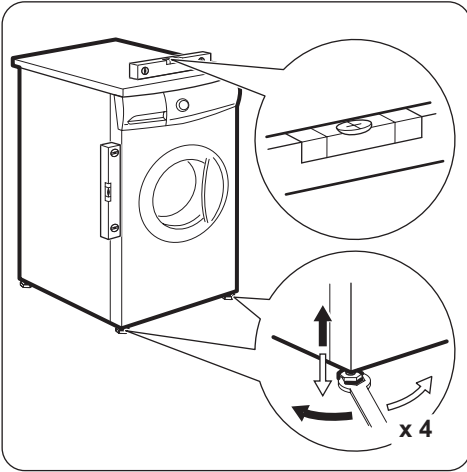

Level the appliance by raising or lowering the feet.

The appliance **MUST** be level and stable on a flat hard floor. If necessary, check the setting with a spirit level. Any necessary adjustment can be made with a spanner.

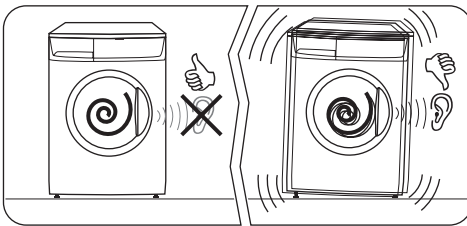

Accurate levelling prevents vibration, noise and displacement of the appliance during operation.

Repeat the levelling action, if the appliance is not level and stable.

Warning! This appliance is free standing only. Do not remove the worktop for any reason.

Water inlet

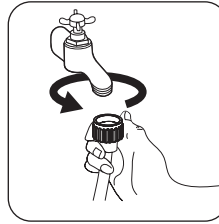

Connect the hose to a tap with a 3/4" thread.

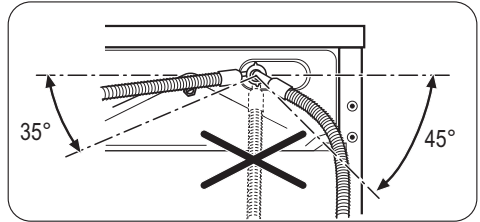

Loosen the ring nut to angle the hose to the left or right depending on the position of your water tap. **Do not place the inlet hose downwards.** After positioning the inlet hose, be sure to tighten the ring nut again to prevent leaks.

Water drainage

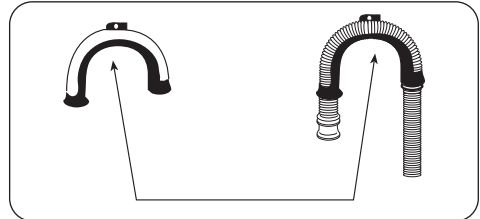

Firstly form a hook in the end of the drain hose using the plastic hose guide supplied with the appliance .

The end of the drain hose can be positioned in four ways:

- **Hooked over the edge of a sink using the plastic hose guide.**

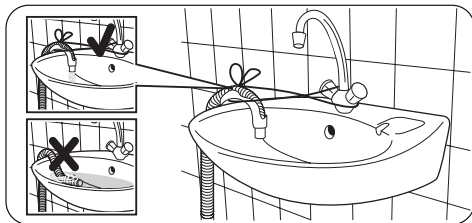

Tie the plastic hose guide to the tap with a string to prevent that the drain hose unhooks when the appliance is emptying.

- **Onto a sink outlet spigot.**

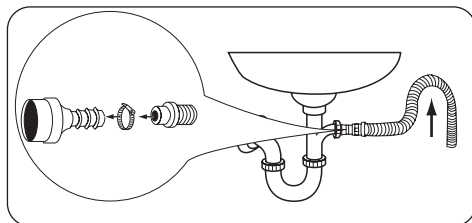

Push the drain hose onto the spigot and secure with a clip, ensure a loop is formed in the drain hose to prevent waste from the sink entering the appliance.

If the outlet spigot has not been used before, remove any blanking plug that may be in place.

- **Directly into a drain pipe at a height** of not less than 60 cm and not more than 100 cm.

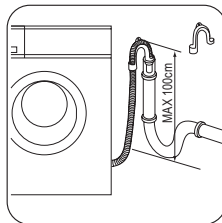

The end of the drain hose must always be **ventilated**, i.e. the inside diameter of the drain pipe must be larger than the outside diameter of the drain hose. The drain hose must not be kinked.

If your drain hose looks like this (see beside) you do not require the “U” piece”. Just push the hose firmly in to the standpipe.

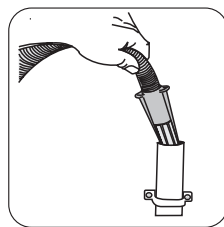

- **Directly to a built-in drain pipe** in the room wall.

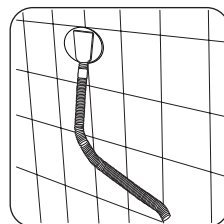
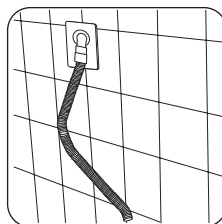

i The drain hose may be extended to a maximum of 4 metres. An additional drain hose and joining piece is available from your Local Centre.

Connections overview

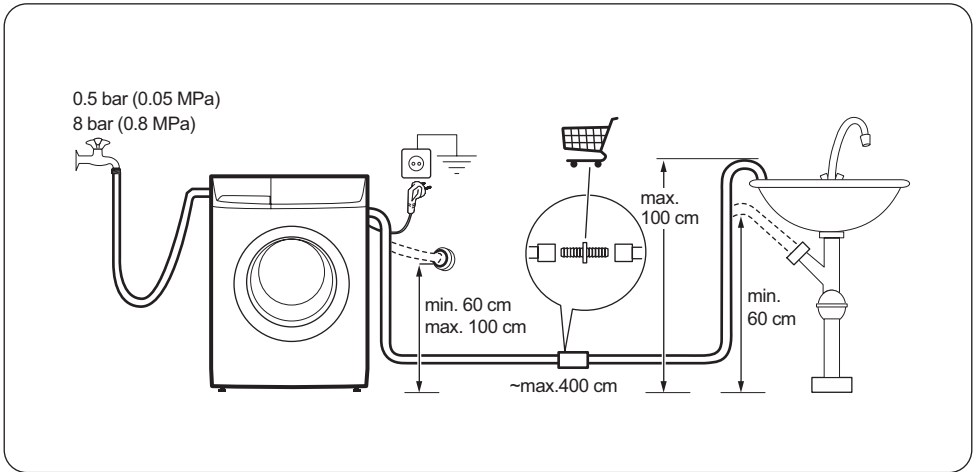

In the interest of the environment

The appliance should be connected to the FOUL drainage system, the water will then be taken to a sewage works for treatment before being discharged safely into a river.

It is essential that these appliances are not connected to the surface water drainage system as this water is discharged directly into a river or stream and may cause pollution.

If you require any further advice please contact your local water authority.

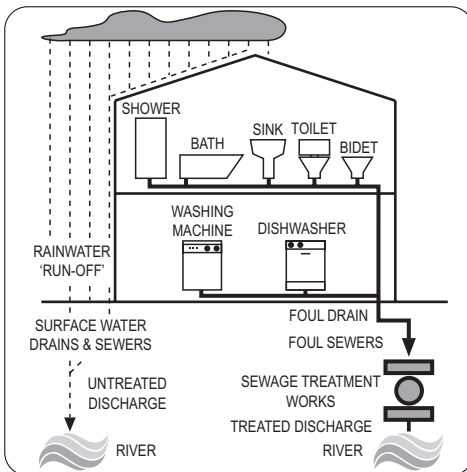

Electrical connection

- The appliance must be earthed.
- Make sure that the electrical information on the rating plate agree with your domestic power supply.
- Always use a correctly installed shockproof socket.
- Do not use multi-way plugs, connectors and extension cables. There is a risk of fire.
- Do not replace or modify the mains cable yourself. Contact the After Sales Service.
- Make sure that the mains plug and cable is not squashed or damaged by the back of the appliance.
- The mains plug must be accessible without moving machine to enable electrical isolation of appliance prior to cleaning or service.
- Do not pull the mains cable to disconnect the appliance. Always pull the mains plug.
- This appliance complies with the E.E.C. Directives.

Warning! The appliance is supplied with a 13 amp plug attached. Use a 13 amp ASTA approved (BS 1362) fuse if it is necessary to change the fuse in the plug

supplied. A cut off plug inserted into a 13 amp socket is a serious safety danger. Make sure that it is disposed of safely.

First use

- i** ▪ Ensure that the electrical and water connections comply with the installation instructions.
- i** ▪ Ensure that the drum is empty.
- i** ▪ Before the first wash, run a cotton cycle at the highest temperature without any

laundry in the machine, to remove any manufacturing residue from the drum and tub. Pour 1/2 a measure of detergent into the main wash compartment and start the machine.

Daily use

Sort out the laundry

Follow the wash code symbols on each garment label and the manufacturer's washing instructions. Sort the laundry as follows: whites, coloureds, synthetics, delicates, woollens.

Before Loading The Laundry

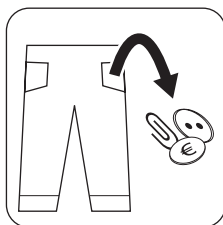

Important! Make sure that no metal objects are left in the laundry (e.g. hair clips, safety pins, pins). Button up pillowcases, close zip fasteners, hooks and poppers. Tie any belts or long tapes. Remove any hooks (e.g. curtains).

- Never wash whites and coloureds together. Whites may lose their «whiteness» in the wash.
- New coloured items may run in the first wash; they should therefore be washed separately the first time.
- Rub particularly soiled areas with a special detergent or detergent paste.

- Treat curtains with special care.
- Wash the socks and the gloves inside the bag or a net.

Remove stubborn stains before washing:

Blood: treat fresh stains with cold water. For dried stains, soak overnight in water with a special detergent then rub in the soap and water.

Oil based paint: moisten with benzine stain remover, lay the garment on a soft cloth and dab the stain; treat several times.

Dried grease stains: moisten with turpentine, lay the garment on a soft surface and dab the stain with the fingertips and a cotton cloth.

Rust: oxalic acid dissolved in hot water or a rust removing product used cold. Be careful with rust stains which are not recent since the cellulose structure will already have been damaged and the fabric tends to hole.

Mould stains: treat with bleach, rinse well (whites and fast coloureds only).

Grass: soap lightly and treat with bleach (whites and fast coloureds only).

Ball point pen and glue: moisten with acetone¹⁾, lay the garment on a soft cloth and dab the stain.

Lipstick: moisten with acetone as above, then treat stains with methylated spirits. Treat any residual marks with bleach.

1) do not use acetone on artificial silk.

Red wine: soak in water and detergent, rinse and treat with acetic or citric acid, then rinse.

Treat any residual marks with bleach.

Ink: depending on the type of ink, moisten the fabric first with acetone¹⁾, then with acetic acid; treat any residual marks on white fabrics with bleach and then rinse thoroughly.

Tar stains: first treat with stain remover, methylated spirits or benzine, then rub with detergent paste.

Open the door by carefully pulling the door handle outwards

Load the laundry

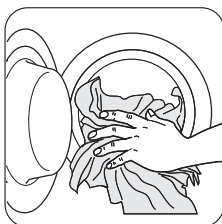

Place the laundry in the drum, one item at a time, shaking them out as much as possible.

Maximum Loads

i Recommended loads are indicated in the «Washing Programmes».

General rules:

- **Cotton, linen:** drum full but not too tightly packed;
- **Synthetics:** drum no more than half full;
- **Delicate fabrics and woollens:** drum no more than one third full.

Close the door gently

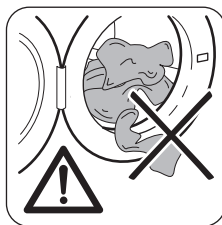

Warning! Make sure that any fabrics were not trapped when closing the door.

Detergents and additives

Good washing results also depend on the choice of detergent and use of the correct quantities to avoid waste and protect the environment.

Although biodegradable, detergents contain substances which, in large quantities, can upset the delicate balance of nature.

The choice of detergent will depend on the type of fabric (delicates, woollens, cottons, etc.), the colour, washing temperature and degree of soiling.

All commonly available washing machine detergents may be used in this appliance:

- powder detergents for all types of fabric,
- powder detergents for delicate fabrics (40°C max) and woollens,
- liquid detergents, preferably for low temperature wash programmes (60°C max) for all types of fabric, or special for woollens only.

i The detergent dispenser drawer is provided with an insert for liquid detergent. Do not use the insert downwards for gelatinous detergents, with programmes including pre-wash, with the delay start option. In all these cases you can use metering balls or sachets provided with the detergent, Take out the metering aid at the end of the washing cycle.

Quantity of detergent to be used

The type and quantity of detergent will depend on the type of fabric, load size, degree of soiling and hardness of the water used.

For the quantity of detergent, refer always to what is written on the product packing.

Use less detergent if:

- you are washing a small load,
- the laundry is lightly soiled,
- large amounts of foam form during washing.

Degrees of water hardness

Water hardness is classified in so-called “degrees” of hardness. Information on hardness of the water in your area can be obtained from the relevant water supply company, or from your local authority.

If the water hardness degree is medium or high we suggest you to add a water softener following always the manufacturer's instructions. When the degree of hardness is soft, readjust the quantity of the detergent.

Open the detergent dispenser drawer

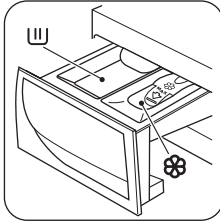

☐ Compartment for powder or liquid detergent used for main wash. ⊗ Compartment for liquid additives (fabric softener, starch).

Warning! If you wish to carry out the prewash, pour the detergent for prewash phase among washing items into the drum.

Warning! Depending on the type detergent you use (powder or liquid), ensure that the flap, placed in the main wash compartment, is in the desired position.

Flap for powder or liquid detergent

UP- Flap position if using POWDER detergent

DOWN - Flap position if using LIQUID detergent during main wash

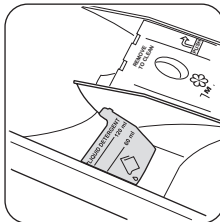
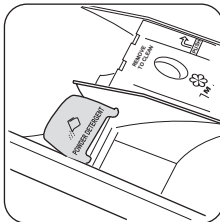

If the flap is not in the desired position:

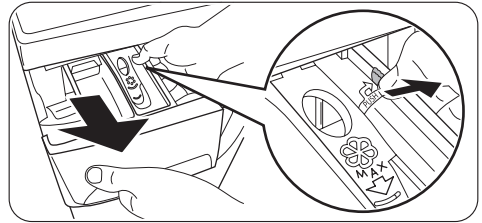

- Remove the drawer. Push the drawer edge outwards where indicated by the arrow (PUSH) to facilitate drawer removal.

The flap is down and you wish to use powder detergent:



- Rotate the flap upwards. Ensure to fit the flap completely in.
- Carefully put the drawer back.

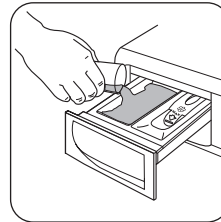

- Measure out the detergent.
- Pour the powder detergent into the main wash compartment ☐.

The flap is up and you wish to use liquid detergent:

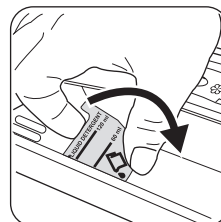

- Rotate the flap downwards.
- Carefully put the drawer back.

- Measure out the detergent.

i For the quantity of detergent, refer always to what is written on the product packing and ensure that the detergent can be poured in the drawer.

- Pour the liquid detergent in the compartment (U) without exceeding the limit indicated in the flap. The detergent must be placed in the appropriate compartments of the dispenser drawer before starting the wash programme.

Warning! Do not use the flap in "DOWN" position with:

- Gelatinous detergent or thick detergent.
- Powder detergent.
- With programmes with prewash.
- Do not use liquid detergent if the washing programme doesn't start immediately.

i In all above listed cases, use the flap in "UP" position .

Set your washing programme

The control panel permits to select a washing programmes and different options. When an option button is selected, the corresponding pilot light is on. Otherwise it is off.

i For compatibility among washing programmes and options, see the "Washing Programme Chart". If an incorrect option is selected, the integrated red pilot light of the button **6** flashes 3 times.

Measure out the fabric softener

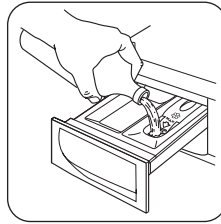

Pour fabric softener or any additives into the compartment marked  (do not exceed the «MAX» mark in the drawer). Any additives must be placed in the appropriate compartments of the dispenser drawer just before starting the wash programme.

Close the detergent dispenser drawer

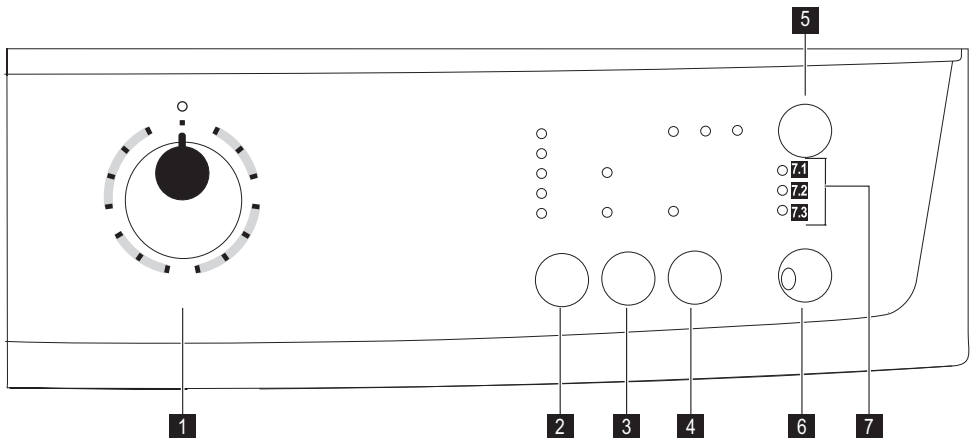

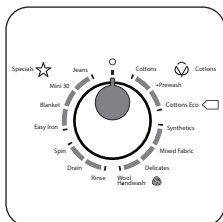

1 Programme selector dial



Turn the programme selector dial to the required programme. The selector dial can be turned either clockwise or counter-clockwise. The green pilot light of the button **6** starts flashing: the appliance is now switched on.

i If you turn the programme selector dial to another programme when the appliance is working, the red pilot light of the button **6** will flash 3 times to indicate a wrong selection. The appliance will not perform the new selected programme.

- To **switch the appliance off**, turn the programme selector dial to the position .
- To **cancel or change** a running programme, switch the appliance off by turning the programme selector dial to the position . Select the new programme by turning the selector to the desired programme. Start the new programme by pressing the button **6** again. The water in the tub will be not emptied out.

2 Temperature button

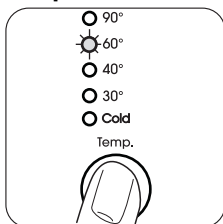

Push the temperature button to select the most suitable temperature for washing your laundry .

3 Automatic Spin reduction and Rinse Hold

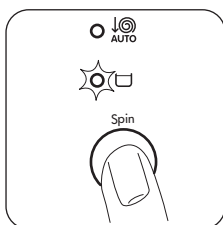

By selecting a programme, the appliance proposes automatically the maximum spin speed provided for that programme. By selecting Automatic Spin reduction () the spin speed is reduced to a half, but not less than 400 rpm. The relevant light illuminates.

Rinse Hold

By selecting this function the water of the last rinse is not emptied out to prevent the fabrics from creasing. Before opening the door it will be necessary to empty out the water.

To empty out the water, please read the paragraph «At the end of the programme».

4 Super Quick

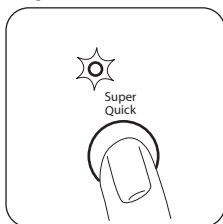

By pressing this button the corresponding pilot light illuminates.

Short cycle for lightly soiled items or for laundry which needs only freshening up.

With this option, a reduced load of laundry is recommended:

- Cottons 3,5 kg
- Synthetics and delicates 2 kg

3 Extra Rinse

+

4

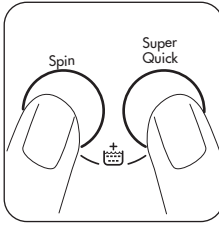

This appliance is designed for saving water. However, for people with very delicate skin (allergic to detergents) it may be necessary to rinse the laundry using an extra quantity of water. Press simultaneously the buttons **3** and **4** for some seconds: the pilot light **7.2** comes on. This function stays permanently on. To remove it press the same buttons again until the pilot light **7.2** goes off.

5 Delay Start

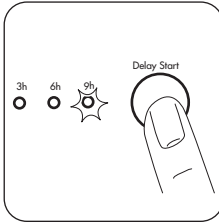

The start of the programme can be delayed by 9, 6 or 3 hours by means of this button. The relevant light illuminates. You must select this option after you have set the programme and before you start the programme.

Select a delayed start:

- select the programme and the required options;
- select the delay start by pressing the button **5**;
- press the button **6**:
 - the appliance starts its hourly countdown.
 - The programme will start after the selected delay has expired.

Cancelling the delayed start after having started the programme:

- set the appliance to PAUSE by pressing the button **6**;
 - press the button **5** once, the light relevant to the selected delay goes off;
 - press the button **6** again to start the programme.
- The DELAY START **cannot** be selected with the drain programme.

Important! The selected delay can be changed only after selecting the washing programme again. The door will be locked throughout the delay time. If you need to open the door, you must set the appliance to PAUSE (by pressing the button **6**) and then wait a few minutes. After you have closed the door, press the button **6** again.

6 Start/Pause

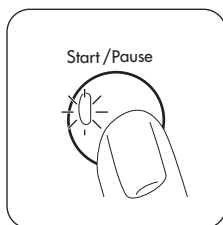

Start the programme by pressing the button 6

- To **start** the selected programme, press the button **6**, the corresponding green pilot light stops flashing. The pilot light **7.1** illuminates to indicate that the appliance starts operating and the door is locked. If you have chosen a delayed start, the appliance will begin the countdown.
- To **interrupt** a programme which is running, press the button **6**: the corresponding green pilot light starts flashing. It is possible to **change** some options of a running programme before the programme carries them out.
- To **restart** the programme from the point at which it was interrupted, press the button **6**.
- After the programme has started the door is locked. If, for any reason, you need to **open the door**, set firstly the appliance to PAUSE by pressing the button **6**. After a few minutes it will be possible to open the door.
If the door remains locked, this means that the appliance is already heating or that the water level is too high. In any case, do not try to force the door!
If you cannot open the door but you need to open it you have to switch the appliance off by turning the selector dial to . After a few minutes the door can be opened (**pay attention to the water level and temperature!**). After closing the door, it is necessary to select the programme and options again and to press the button **6**.

Indicator pilot lights

7.1  Washing

7.2  Extra Rinse

7.3  End

- When you start the programme by pressing the button **6**, the washing phase pilot light (**7.1**) illuminates. This means that the appliance is operating.
- The additional rinses pilot light (**7.2**) illuminates when the appliance performs an extra rinse.
- When the programme has finished the end cycle pilot light (**7.3**) comes on.

At the end of the programme

The appliance stops automatically. The pilot light of the button **6** and the pilot light corresponding to the just finished washing phase go off. The light **7.3** illuminates.

If a programme or an option that ends with water left in the tub has been selected and the door remains locked to indicate that the water must be emptied out before opening the door. Follow the below instructions to empty out the water:

- Turn the programme selector dial to .
- Select the draining or spinning programme.
- Reduce the spin speed if needed, by pressing the relevant button.
- Press the button **6**.

At the end of the programme, the door can be now opened. Turn the programme selector dial to  to switch the appliance off. Remove the laundry from the drum and carefully check that the drum is empty. If you do not intend to carry out another wash, close the water

tap. Leave the door open to prevent the formation of mildew and unpleasant smells.

Warning! If there are children or pets in the house, **activate the child safety device** in the inner side of the door frame (for more details read " Child safety" in the chapter "Safety Information").

Stand by: during programme setting up and once the programme has finished, if the programme selector dial and any button are not touched, after a few minutes the energy saving system is enabled. The pilot lights go off. The green pilot light of the button **6** flashes with

a low frequency. By pressing any button the appliance will come out of the energy saving status.



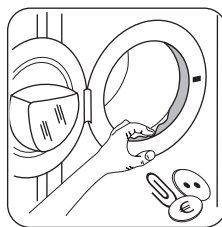

Door seal



At the end of every cycle, check from the door seal and remove objects that could be trapped in the fold.

Washing programmes

| Programme - Maximum and Minimum Temperature - Cycle Description - Maximum Spin Speed - Maximum Fabrics Load - Type of Laundry | Options | Detergent Compartment |
|--|---|-----------------------|
| COTTONS 90°-Cold Main wash - Rinses - Maximum spin speed 1300 rpm Max. load 7 kg - Reduced load 3,5 kg White, coloured cotton and linen. Normally soiled items. | AUTOMATIC SPIN REDUCTION RINSE HOLD SUPER QUICK ¹⁾ EXTRA RINSE DELAY START | |
| COTTONS + PREWASH²⁾ 90°- Cold Prewash - Main wash - Rinses - Maximum spin speed 1300 rpm Max. load 7 kg - Reduced load 3,5 kg White, coloured cotton and linen. Heavy soiled items. | AUTOMATIC SPIN REDUCTION RINSE HOLD SUPER QUICK ¹⁾ EXTRA RINSE DELAY START | |
| COTTONS ECO ³⁾ 60° - 40° Main wash - Rinses - Maximum spin speed 1300 rpm Max. load 7 kg White and coloured cotton. This programme can be selected for slightly or normally soiled cotton items. The temperature will decrease and the washing time will be extended. This allows to obtain a good washing efficiency by saving energy. | AUTOMATIC SPIN REDUCTION RINSE HOLD EXTRA RINSE DELAY START | |
| SYNTHETICS 60° - Cold Main wash - Rinses - Maximum spin speed at 1200 rpm Max. load 3,5 kg - Reduced load 2 kg Synthetic or mixed fabrics: underwear, coloured garments, non-shrink shirts, blouses . Normally soiled items. | AUTOMATIC SPIN REDUCTION RINSE HOLD SUPER QUICK ¹⁾ EXTRA RINSE DELAY START | |

| Programme - Maximum and Minimum Temperature - Cycle Description - Maximum Spin Speed - Maximum Fabrics Load - Type of Laundry | Options | Detergent Compartment |
|--|--|---|
| <p>MIXED FABRIC Cold Main wash - Rinses - Maximum spin speed at 1200 rpm Max. load 3,5 kg Highly energy efficient cold wash programme for lightly soiled laundry. This programme requires a detergent which is active in cold water.</p> | <p>AUTOMATIC SPIN REDUCTION RINSE HOLD EXTRA RINSE DELAY START</p> |  |
| <p>DELICATES 40°- Cold Main wash - Rinses - Maximum spin speed at 700 rpm Max. load kg 3,5 - Reduced load 2 kg Delicate fabrics: acrylics, viscose, polyester . Normally soiled items.</p> | <p>AUTOMATIC SPIN REDUCTION RINSE HOLD SUPER QUICK ¹⁾ EXTRA RINSE DELAY START</p> |  |
| <p>WOOL / HANDWASH 40°- Cold Main wash - Rinses - Maximum spin speed at 1200 rpm Max. load 1 kg Machine washable wool, hand washable woollens and delicate fabrics with «hand washing» care symbol. Note: A single or bulky item may cause imbalance. If the appliance doesn't perform the final spin phase, add more items, redistribute the load manually and then select the spinning programme.</p> | <p>AUTOMATIC SPIN REDUCTION RINSE HOLD DELAY START</p> |  |
| <p>RINSE Rinse - Short spin speed at 700 rpm. Max. load 7 kg To rinse and spin cotton garments which have been washed by hand. Select the EXTRA RINSE option to intensify the rinsing action. The appliance adds additional rinses.</p> | <p>AUTOMATIC SPIN REDUCTION RINSE HOLD EXTRA RINSE DELAY START,</p> |  |
| <p>DRAIN Draining of water For emptying out the water left in the drum in the programmes with Rinse Hold option.</p> | | |
| <p>SPIN Drain and long spin at maximum spin speed: 1300 rpm Max. load 7 kg Separate spin for hand washed garments and after programmes with the Rinse Hold option selected. If the Automatic Spin reduction is selected, by pressing the relevant button, the appliance performs a short spin.</p> | <p>AUTOMATIC SPIN REDUCTION DELAY START</p> | |
| <p>EASY IRON 60°- Cold Main wash - Rinses - Maximum spin speed at 900 rpm In order to obtain the best anti-creasing result, reduce the load of synthetics items. (Recommended load 1 Kg) Synthetic or mixed fabrics. Gentle wash and spin to avoid any creasing. The appliance performs additional rinses.</p> | <p>AUTOMATIC SPIN REDUCTION RINSE HOLD EXTRA RINSE DELAY START</p> |  |

| Programme - Maximum and Minimum Temperature - Cycle Description - Maximum Spin Speed - Maximum Fabrics Load - Type of Laundry | Options | Detergent Compartment |
|---|---|-----------------------|
| BLANKET 30° Main wash - Rinses - Maximum spin speed at 700 rpm Special programme for a single synthetic blanket, duvet, bed-spread and so on. The Extra Rinse option is activated automatically. | AUTOMATIC SPIN REDUCTION DELAY START | |
| MINI 30 30° Main wash - Rinses - Maximum spin speed at 700 rpm Max. load 2 kg Synthetics and delicates. Lightly soiled items or which only needs freshening up. | AUTOMATIC SPIN REDUCTION DELAY START | |
| JEANS 60°- Cold Main wash - Rinses - Maximum spin speed at 1200 rpm Max. load 3 kg Trousers, shirts or jackets in denim and jersey realized with hi-tech materials. The Extra Rinse option is activated automatically. | AUTOMATIC SPIN REDUCTION RINSE HOLD DELAY START | |

1) If you select the SUPER QUICK option by pressing button **5**, we recommend that you reduce the maximum load as indicated. Full loading is possible however with somewhat reduced cleaning results.

2) In case of prewash phase, put the detergent directly into the drum.

3) Standard programmes for the Energy Label consumption values.

According to regulation 1061/2010, these programmes are respectively the «Standard 60 °C cotton programme» and the «Standard 40 °C cotton programme». They are the most efficient programmes in terms of combined energy and water consumptions for washing normally soiled cotton laundry.

The water temperature of the washing phase may differ from the temperature declared for the selected programme.

Consumption values

The data of this table are approximate. Different causes can change the data: the quantity and type of laundry, the water and ambient temperature.

| Programmes | Load (kg) | Energy consumption (kWh) | Water consumption (litre) | Approximate programme duration (minutes) | Remaining moisture (%) ¹⁾ |
|----------------------|-----------|--------------------------|---------------------------|--|--------------------------------------|
| Cottons 60 °C | 7 | 1.3 | 73 | 170 | 52 |
| Cottons 40 °C | 7 | 0.85 | 73 | 145 | 52 |
| Synthetics 40 °C | 3,5 | 0.65 | 58 | 95 | 35 |
| Delicates 40 °C | 3,5 | 0.65 | 71 | 77 | 35 |
| Wool/Hand wash 30 °C | 2 | 0.3 | 48 | 55 | 30 |

| Programmes | Load (kg) | Energy consumption (kWh) | Water consumption (litre) | Approximate programme duration (minutes) | Remaining moisture (%) ¹⁾ |
|-----------------------------------|-----------|--------------------------|---------------------------|--|--------------------------------------|
| Standard cotton programmes | | | | | |
| Standard 60 °C cotton | 7 | 1.07 | 50 | 236 | 52 |
| Standard 60 °C cotton | 3,5 | 0.79 | 36 | 192 | 52 |
| Standard 40 °C cotton | 3,5 | 0.57 | 36 | 166 | 52 |

1) At the end of spin phase.

| Off Mode (W) | Left On Mode (W) |
|--------------|------------------|
| 0.65 | 0.65 |

The information given in the charts above are in compliance with the EU Commission regulation 1015/2010 implementing directive 2009/125/EC.

Care and cleaning

Warning! Switch the appliance off and remove the mains plug from the socket before any cleaning action.

Maintenance Wash

With the use of low temperature washes it is possible to get a build up of residues inside the drum.

We recommend that a maintenance wash be performed on a regular basis.

To run a maintenance wash:

- The drum should be empty of laundry.
- Select the hottest cotton wash programme.
- Use a normal measure of detergent, must be a powder with biological properties.

Cleaning the dispenser drawer

The washing powder and additive dispenser drawer should be cleaned regularly.

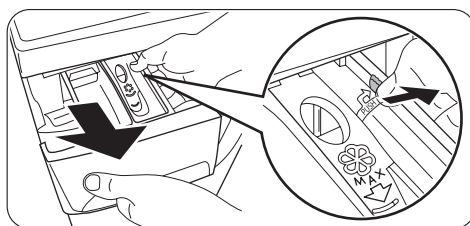

- Remove the drawer.
- To aid cleaning, the top part of the additive compartment should be removed.

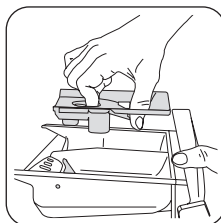

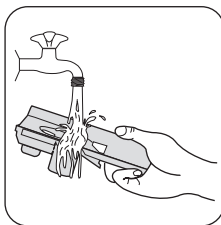
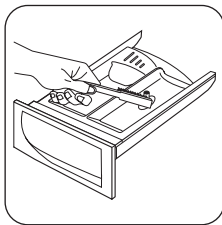

- Use a stiff brush to clean and remove all washing powder residue.
- Clean all the removed parts of the dispenser drawer under a tap to remove any traces of accumulated powder.

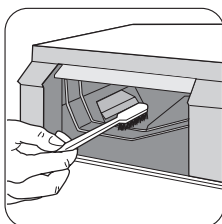

- Use the previous brush to clean the recess, ensuring that upper and lower part of it is well cleaned.

After having cleaned the dispenser and the drawer recess, replace it.

Cleaning the drain filter

The filter permits to hold fluff or foreign bodies left unawares in the laundry.

The pump must be cleaned regularly.

To clean the filter, proceed as follows:

- turn programme selector dial to position  ;
- unplug the appliance;
- open the door;

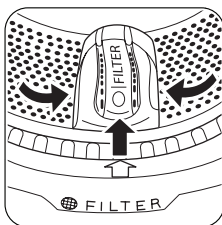

- turn the drum and align the filter cover (**FILTER**) with the arrow on the door seal;

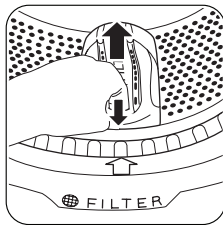

- open the filter cover by pressing the special hook and by rotating the cover upwards;

 **Warning!** Keep the filter cover open until the filter removal.

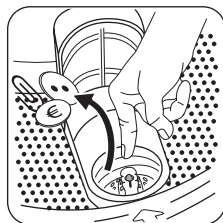

- before removing the filter, remove any fluff or small objects from around the filter;

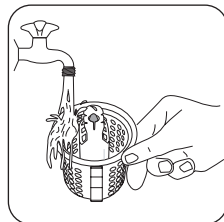
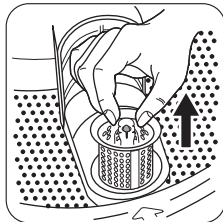

- remove the filter and clean it under the tap;

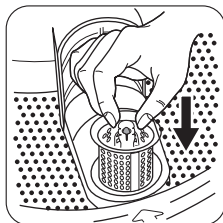

- if necessary, place the filter cover in the right position again.
- open the filter cover and insert the filter again;

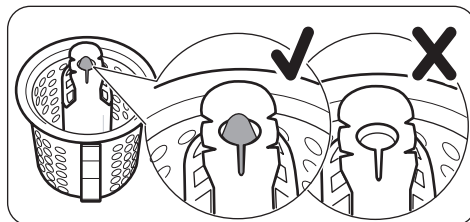

The filter is inserted correctly when the indicator on its top is visible and blocked.



- close the filter cover;
- insert the mains plug again.

Cleaning the water inlet filters

Important! If the appliance doesn't fill, it takes a long time to fill with water, the starting button flashes red or the display (if available) shows the relevant alarm (see chapter "What to do if..." for more details), check if the water inlet filters are blocked .

To clean the water inlet filters:

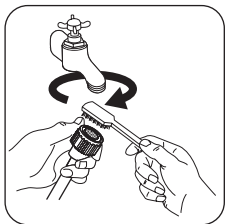

- Turn off the water tap.
- Unscrew the hose from the tap.
- Clean the filter in the hose with a stiff brush.

- Screw the hose back onto the tap. Make sure the connection is tight.

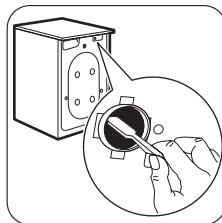

- Unscrew the hose from the appliance. Keep a towel nearby because some water may flow.
- Clean the filter in the valve with a stiff brush or with the piece of cloth.
- Screw the hose back to the appliance and make sure the connection is tight.
- Turn on the water tap.

What to do if...

The appliance does not start or stops during operation. Certain problems are due to lack of simple maintenance or oversights, which can be solved with the help of the indications described in the charts, without calling out an engineer.

During appliance operation it is possible that the **red** pilot light of the button **6** flashes and one of the indicator pilot lights illuminates to indicate that the appliance is not working. Before contacting your local Service Centre, please carry out the checks listed below.

Fault code and malfunction Possible cause - Solution

The light of button 6 flashes and the light 7.1 illuminates: Problem with the water supply

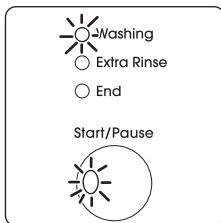

The water tap is closed.

- Open the water tap.

The inlet hose is squashed or kinked.

- Check the inlet hose connection.

The filter in the inlet hose or the inlet valve filter are blocked

- Clean the water inlet filters (read "Cleaning the water inlet filters" for more details).

The light of button 6 flashes and the light 7.2 illuminates: Problem with the water drainage

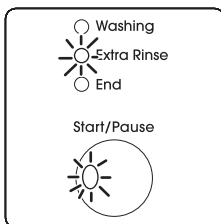

The drain hose is squashed or kinked.

- Check the drain hose connection.

The drain filter is clogged

- If the appliance stops working without discharging the water , first carry out an emergency drain:

- Turn the programme selector dial to ○ ;

- Unplug the appliance;

- Close the water tap;

- If necessary, wait until the water has cooled down;

- Unscrew the drain hose from the rear support (see "Frost precaution") and unhook it from the sink or spigot;

- Let it run along the floor;

- Place a bowl on the floor and place the end of the draining hose into the bowl. The water should drain by gravity into the bowl. When the bowl is full, empty it. Repeat the procedure until water stops flowing out ;

- Screw the draining hose to the rear support and reposition it;

- Open the door and remove the laundry;

- Carry out the drain filter cleaning as described in "Cleaning the drain filter";

- At the end of cleaning action, close the door and insert the mains plug again;

- Run a drain programme to check if the appliance works now.

The light of button 6 flashes and the light 7.3 illuminates: Door open

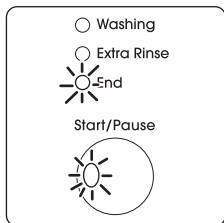

The door has not been closed or is not closed properly.

- Close firmly the door.

The appliance does not start or stops during operation without any visible alarm.

Before contacting your local Service Centre, please carry out the checks listed below.

| Malfunction | Possible cause / Solution |
|--|---|
| <p>The appliance does not start:</p> | <p>The plug is not properly inserted in the power socket.</p> <ul style="list-style-type: none"> ▪ Insert the plug into the power socket. <p>There is no power at the socket.</p> <ul style="list-style-type: none"> ▪ Please check your domestic electrical installation. <p>The main fuse has blown.</p> <ul style="list-style-type: none"> ▪ Replace the fuse. <p>The programme selector dial is not correctly positioned and the button 6 has not been pressed.</p> <ul style="list-style-type: none"> ▪ Please turn the selector dial and press the button 6 again. <p>The delay start has been selected.</p> <ul style="list-style-type: none"> ▪ If the laundry are to be washed immediately, cancel the delay start. |
| <p>The appliance fills then empties immediately:</p> | <p>The end of the drain hose is too low.</p> <ul style="list-style-type: none"> ▪ Refer to paragraph in "Water drainage" in chapter "Installation". |
| <p>The appliance does not empty and/or does not spin:</p> | <p>An option or a programme that ends with the water still in the tub or a that eliminates all the spinning phases has been selected.</p> <ul style="list-style-type: none"> ▪ Select the draining or spinning programme. <p>The laundry is not evenly distributed in the drum.</p> <ul style="list-style-type: none"> ▪ Redistribute the laundry. |
| <p>There is water on the floor:</p> | <p>Too much detergent or unsuitable detergent (creates too much foam) has been used.</p> <ul style="list-style-type: none"> ▪ Reduce the detergent quantity or use another one. <p>Check whether there are any leaks from one of the inlet hose fittings. It is not always easy to see this as the water runs down the hose; check to see if it is damp.</p> <ul style="list-style-type: none"> ▪ Check the water inlet hose connection. <p>The drain or inlet hose is damaged.</p> <ul style="list-style-type: none"> ▪ Replace it with a new one. |
| <p>The door will not open:</p> | <p>The programme is still running.</p> <ul style="list-style-type: none"> ▪ Wait the end of washing cycle. <p>The door lock has not been released.</p> <ul style="list-style-type: none"> ▪ Wait until the door lock is released. <p>There is water in the drum.</p> <ul style="list-style-type: none"> ▪ Select drain or spin programme to empty out the water. |

| Malfunction | Possible cause / Solution |
|--|--|
| <p>The appliance vibrates noisily:</p> <p>Spinning starts late or the appliance does not spin:</p> | <p>The transit bolts and packing have not been removed.</p> <ul style="list-style-type: none"> ▪ Check the correct installation of the appliance. <p>The appliance is not levelled correctly.</p> <ul style="list-style-type: none"> ▪ Adjust the feet. <p>The laundry is not evenly distributed in the drum.</p> <ul style="list-style-type: none"> ▪ Redistribute the laundry. <p>Maybe there is very little laundry in the drum.</p> <ul style="list-style-type: none"> ▪ Load more laundry. <p>The electronic unbalance detection device has cut in because the laundry is not evenly distributed in the drum. The laundry is redistributed by reverse rotation of the drum. This may happen several times before the unbalance disappears and normal spinning can resume. If, after 10 minutes, the laundry is still not evenly distributed in the drum, the appliance will not spin. In this case, redistribute the load manually and select the spin programme.</p> <ul style="list-style-type: none"> ▪ Load more laundry. <p>The load is too small.</p> <ul style="list-style-type: none"> ▪ Add more items, redistribute the load manually and then select the spinning programme. |
| <p>No water is visible in the drum:</p> | <p>Appliances based on modern technology operate very economically using very little water without affecting performance.</p> |
| <p>Unsatisfactory washing results</p> | <p>Too little detergent or unsuitable detergent has been used.</p> <ul style="list-style-type: none"> ▪ Increase the detergent quantity or use another one. <p>Stubborn stains have not been treated prior to washing.</p> <ul style="list-style-type: none"> ▪ Use commercial products to treat the stubborn stains. <p>The correct temperature was not selected.</p> <ul style="list-style-type: none"> ▪ Check if you have selected the correct temperature. <p>Excessive laundry load.</p> <ul style="list-style-type: none"> ▪ Reduce the laundry load. |
| <p>The appliance makes an unusual noise</p> | <p>The appliance is fitted with a type of motor which makes an unusual noise compared with other traditional motors. This new motor ensures a softer start and more even distribution of the laundry in the drum when spinning, as well as increased stability of the appliance.</p> |

After completing these checks, switch on the appliance and press the button **6** to restart the programme.

If the malfunction shows again, contact your Service Centre. The necessary data for the

service centre is on the rating plate. We recommend that you write the data here:

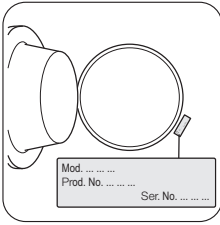

Model description
(MOD.)
Product number
(PNC)
Serial number
(S.N.)



www.zanussi.com/shop



192981381-A-362012