

EN

User Manual

USER MANUAL

Cooker

ZCV553MWC

ZANUSSI

Contents

| | | | |
|------------------------------|---|-------------------------------|----|
| Safety information..... | 2 | Oven - Daily use..... | 8 |
| Safety instructions..... | 3 | Oven - Clock functions..... | 10 |
| Product description..... | 6 | Oven - Hints and tips..... | 11 |
| Before first use..... | 7 | Oven - Care and cleaning..... | 16 |
| Hob - Daily use..... | 7 | Troubleshooting..... | 18 |
| Hob - Hints and tips..... | 8 | Installation..... | 19 |
| Hob - Care and cleaning..... | 8 | | |

Subject to change without notice.

Safety information

Before the installation and use of the appliance, carefully read the supplied instructions. The manufacturer is not responsible if an incorrect installation and use causes injuries and damages. Always keep the instructions with the appliance for future reference.

Children and vulnerable people safety



WARNING!

Risk of suffocation, injury or permanent disability.

- This appliance can be used by children aged from 8 years and above and persons with reduced physical, sensory or mental capabilities or lack of experience and knowledge if they have been given supervision or instruction concerning use of the appliance in a safe way and understand the hazards involved.
- Do not let children play with the appliance.
- Keep all packaging away from children.
- Keep children and pets away from the appliance when it operates or when it cools down. Accessible parts are hot.
- Cleaning and user maintenance shall not be made by children without supervision.

General Safety

- Only a qualified person must install this appliance and replace the cable.
- Do not operate the appliance by means of an external timer or separate remote-control system.

- Unattended cooking on a hob with fat or oil can be dangerous and may result in fire.
- Never try to extinguish a fire with water, but switch off the appliance and then cover flame e.g. with a lid or a fire blanket.
- Do not store items on the cooking surfaces.
- Do not use a steam cleaner to clean the appliance.
- Metallic objects such as knives, forks, spoons and lids should not be placed on the hob surface since they can get hot.
- If the glass ceramic surface/ glass surface is cracked, switch off the appliance to avoid the possibility of electric shock.
- Internally the appliance becomes hot when in operation. Do not touch the heating elements that are in the appliance. Always use oven gloves to remove or put in accessories or ovenware.
- Before maintenance cut the power supply.
- Ensure that the appliance is switched off before replacing the lamp to avoid the possibility of electric shock.
- Do not use harsh abrasive cleaners or sharp metal scrapers to clean the glass door since they can scratch the surface, which may result in shattering of the glass.
- If the supply cord is damaged, it must be replaced by the manufacturer, its Authorised Service Centre or similarly qualified persons in order to avoid a hazard.
- The means for disconnection must be incorporated in the fixed wiring in accordance with the wiring rules.

Safety instructions

Installation



WARNING!

Only a qualified person must install this appliance.

- Remove all the packaging.
- Do not install or use a damaged appliance.
- Obey the installation instruction supplied with the appliance.
- Always be careful when you move the appliance because it is heavy. Always wear safety gloves.
- Do not pull the appliance by the handle.
- The kitchen cabinet and the recess must have suitable dimensions.
- Keep the minimum distance from the other appliances and units.
- Make sure that the appliance is installed below and adjacent safe structures.
- Parts of the appliance carry current. Close the appliance with furniture to prevent touching the dangerous parts.
- The sides of the appliance must stay adjacent to appliances or to units with the same height.
- Do not install the appliance on a platform.
- Do not install the appliance adjacent to a door or under a window. This prevents hot cookware to fall from the appliance when the door or the window is opened.

- Make sure to install a stabilizing means in order to prevent tipping of the appliance. Refer to Installation chapter.

Electrical Connection



WARNING!

Risk of fire and electrical shock.

- All electrical connections should be made by a qualified electrician.
- The appliance must be earthed.
- Make sure that the electrical information on the rating plate agrees with the power supply. If not contact an electrician.
- Always use a correctly installed shockproof socket.
- Do not use multi-plug adapters and extension cables.
- Do not let mains cables to come in touch with the appliance door, specially when the door is hot.
- The shock protection of live and insulated parts must be fastened in such a way that it cannot be removed without tools.
- Connect the mains plug to the mains socket only at the end of the installation. Make sure that there is access to the mains plug after the installation.
- If the mains socket is loose, do not connect the mains plug.
- Do not pull the mains cable to disconnect the appliance. Always pull the mains plug.
- Use only correct isolation devices: line protecting cut-outs, fuses (screw type fuses removed from the holder), earth leakage trips and contactors.
- The electrical installation must have an isolation device which lets you disconnect the appliance from the mains at all poles. The isolation device must have a contact opening width of minimum 3 mm.
- Fully close the appliance door, before you connect the mains plug to the mains socket.

Use



WARNING!

Risk of injury and burns. Risk of electrical shock.

- Use this appliance in a household only.
- Do not change the specification of this appliance.
- Make sure that the ventilation openings are not blocked.

- Do not let the appliance stay unattended during operation.
- Deactivate the appliance after each use.
- Be careful when you open the appliance door while the appliance is in operation. Hot air can release.
- Do not operate the appliance with wet hands or when it has contact with water.
- Do not use the appliance as a work surface or as a storage surface.



WARNING!

Risk of fire and explosion

- Fats and oil when heated can release flammable vapours. Keep flames or heated objects away from fats and oils when you cook with them.
- The vapours that very hot oil releases can cause spontaneous combustion.
- Used oil, that can contain food remnants, can cause fire at a lower temperature than oil used for the first time.
- Do not put flammable products or items that are wet with flammable products in, near or on the appliance.
- Do not let sparks or open flames to come in contact with the appliance when you open the door.
- Open the appliance door carefully. The use of ingredients with alcohol can cause a mixture of alcohol and air.



WARNING!

Risk of damage to the appliance.

- To prevent damage or discoloration to the enamel:
 - do not put ovenware or other objects in the appliance directly on the bottom.
 - do not put water directly into the hot appliance.
 - do not keep moist dishes and food in the appliance after you finish the cooking.
 - be careful when you remove or install the accessories.
- Discoloration of the enamel has no effect on the performance of the appliance. It is not a defect in the sense of the warranty law.
- Use a deep pan for moist cakes. Fruit juices cause stains that can be permanent.
- Do not keep hot cookware on the control panel.
- Do not let cookware boil dry.
- Be careful not to let objects or cookware fall on the appliance. The surface can be damaged.

- Do not activate the cooking zones with empty cookware or without cookware.
- Do not put aluminium foil on the appliance or directly on the bottom of the appliance.
- Cookware made of cast iron, aluminium or with a damaged bottom can cause scratches. Always lift these objects up when you have to move them on the cooking surface.
- This appliance is for cooking purposes only. It must not be used for other purposes, for example room heating.

Care and Cleaning



WARNING!

Risk of injury, fire, or damage to the appliance.

- Before maintenance, deactivate the appliance. Disconnect the mains plug from the mains socket.
- Make sure the appliance is cold. There is the risk that the glass panels can break.
- Replace immediately the door glass panels when they are damaged. Contact the Service.
- Be careful when you remove the door from the appliance. The door is heavy!
- Clean regularly the appliance to prevent the deterioration of the surface material.
- Remaining fat or food in the appliance can cause fire.

- Clean the appliance with a moist soft cloth. Only use neutral detergents. Do not use abrasive products, abrasive cleaning pads, solvents or metal objects.
- If you use an oven spray, obey the safety instructions on the packaging.
- Do not clean the catalytic enamel (if applicable) with any kind of detergent.

Internal light

- The type of light bulb or halogen lamp used for this appliance is only for household appliances. Do not use it for house lighting.



WARNING!

Risk of electrical shock.

- Before replacing the lamp, disconnect the appliance from the power supply.
- Only use lamps with the same specifications.

Disposal



WARNING!

Risk of injury or suffocation.

- Disconnect the appliance from the mains supply.
- Cut off the mains cable and discard it.
- Remove the door catch to prevent children and pets to get closed in the appliance.

Product description

General overview

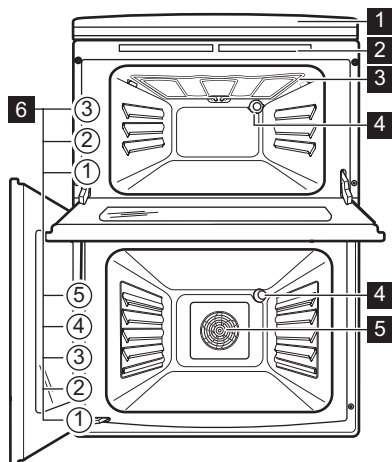

- 1 Control panel and hob
- 2 Air vents for the cooling fan
- 3 Heating element
- 4 Lamp
- 5 Fan
- 6 Shelf positions

Cooking surface layout

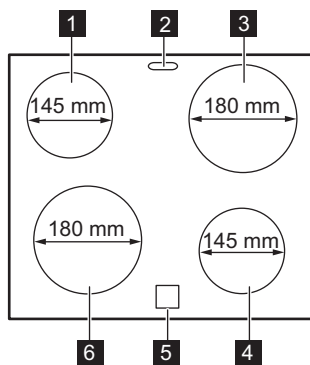

- 1 Cooking zone 1200 W
- 2 Steam outlet - number and position depends on the model
- 3 Cooking zone 1700 W
- 4 Cooking zone 1200 W
- 5 Residual heat indicator
- 6 Cooking zone 1700 W

Control panel

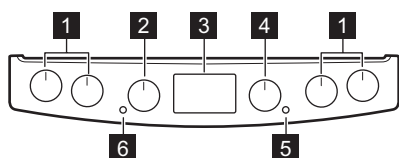

- 1 Knobs for the hob
- 2 Knob for the top oven functions
- 3 Electronic programmer
- 4 Knob for the main oven functions
- 5 Temperature lamp / symbol / indicator for the main oven
- 6 Temperature lamp / symbol / indicator for the top oven

Accessories

- **Wire shelf**
For cookware, cake tins, roasts.
- **Grill- / Roasting pan**
To bake and roast or as pan to collect fat.

Before first use



WARNING!

Refer to Safety chapters.

Initial Cleaning

Remove all accessories from the appliance.



Refer to "Care and cleaning" chapter.

Clean the appliance before first use.
Put the accessories back to their initial position.

Setting the time

You must set the time before you operate the oven.



Only the top oven works without the set time.

The indicator for the Time of day function flashes when you connect the appliance to the electrical supply, when there was a power cut or when the timer is not set.

Press the \oplus or \ominus button to set the correct time.

Hob - Daily use



WARNING!

Refer to Safety chapters.

Heat setting

| Symbols | Function |
|---------|---------------|
| 0 | Off position |
| 1 - 6 | Heat settings |

▪ Trivet

For roasting and grilling.



Use the trivet only with the Grill- / roasting pan.

After approximately five seconds, the flashing stops and the display shows the time of day you set.

Changing the time



You cannot change the time of day if the Duration $\rightarrow|$ or End $\rightarrow|$ function operates.

Press \odot again and again until the indicator for the Time of Day function flashes.
To set a new time, refer to "Setting the time".

Preheating

Preheat the empty appliance to burn off the remaining grease.



Preheat the two ovens. Heat up one oven at a time.

1. Set the maximum temperature.
2. Let the appliance operate for 1 hour. Accessories can become hotter than usual. The appliance can emit an odour and smoke. This is normal. Make sure that the airflow is sufficient.



Use the residual heat to decrease energy consumption. Deactivate the cooking zone approximately 5 - 10 minutes before the cooking process is completed.

Turn the knob to a necessary heat setting.
To complete the cooking process, turn the knob to the off position.

Residual heat indicator



WARNING!

There is a risk of burns from residual heat.

The indicator comes on when a cooking zone is hot.

Hob - Hints and tips



WARNING!

Refer to Safety chapters.

Cookware



The bottom of the cookware must be as thick and flat as possible.



Cookware made of enamelled steel and with aluminium or copper bottoms can cause the colour change on the glass-ceramic surface.

Energy saving

- If it is possible, always put the lids on the cookware.
- Put cookware on a cooking zone before you start it.
- Use the residual heat to keep the food warm or to melt it.

Hob - Care and cleaning



WARNING!

Refer to Safety chapters.

General information

- Clean the hob after each use.
- Always use cookware with clean bottom.
- Scratches or dark stains on the surface have no effect on how the hob operates.
- Use a special cleaner applicable for the surface of the hob.
- Use a special scraper for the glass.

Cleaning the hob

- **Remove immediately:** melted plastic, plastic foil, and food with sugar. If not, the

Oven - Daily use



WARNING!

Refer to Safety chapters.

- The bottom of the pans and cooking zones must have the same dimension.

Examples of cooking applications

| Heat setting: | Application: |
|---------------|---|
| 1 | Keeping warm |
| 2 | Gentle simmering |
| 3 | Simmering |
| 4 | Frying / browning |
| 5 | Bringing to the boil |
| 6 | Bringing to the boil / quick frying / deep-frying |

dirt can cause damage to the hob. Put the special scraper on the glass surface at an acute angle and move the blade on the surface.

- **Remove when the hob is sufficiently cool:** limescale rings, water rings, fat stains, shiny metallic discoloration. Clean the hob with a moist cloth and some detergent. After cleaning, rub the hob dry with a soft cloth.

Cooling fan

When the appliance operates, the cooling fan activates automatically to keep the surfaces of the appliance cool. If you deactivate the

appliance, the cooling fan can continue to operate until the appliance cools down.



Activating and deactivating the top / main oven

i It depends on the model if your appliance has knob symbols, indicators or lamps:



- The indicator comes on when the oven heats up.
- The lamp comes on when the oven operates.
- The symbol shows whether the knob controls one of the cooking zones, the oven functions or the temperature.

1. Turn the knob for the top / main oven functions to select an oven function.
2. To deactivate the oven turn the knob for the top / main oven functions to the off position.

Top oven functions

| Symbol | Oven function | Application |
|--|----------------------|--|
| 0 | Off position | The appliance is off. |
|  | Oven Lamp | To activate the lamp without a cooking function. |
| 100 - 250 | Conventional Cooking | To bake and roast food on 1 shelf position. |
|  | Dual Circuit Grill | To grill food items in medium quantities in the middle of the shelf. To make toasts. |
|  | Full Grill | To grill flat food and to toast bread. |

Main oven functions

| Symbol | Oven function | Application |
|--|---------------|--|
| 0 | Off position | The appliance is off. |
|  | Oven Lamp | To activate the lamp without a cooking function. |
|  | Defrost | To defrost frozen food. |
| 100 - 250 | Thermaflow® | To bake on up to 2 shelf positions at the same time and to dry food. |

Trivet and Grill- / Roasting pan



WARNING!

Be careful when you remove the accessories from a hot appliance. There is a risk of burns.

You can use the trivet to roast larger pieces of meat or poultry on one shelf position.

1. Put the trivet into the deep pan so that the supports of the wire shelf point up.

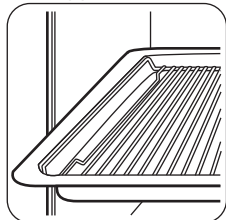

2. Put the deep pan into the oven on the necessary shelf position. You can use the trivet to grill flat dishes in large quantities and to toast.

1. Put the trivet into the deep pan so that the supports of the wire shelf point down.

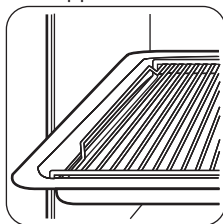

2. Put the deep pan into the oven on the necessary shelf position.

Oven - Clock functions

Display



The electronic programmer works only with the main oven.

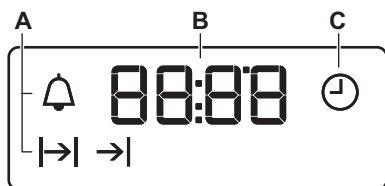









- A) Function indicators
- B) Time display
- C) Function indicator

Buttons



| Button | Function | Description |
|--------|----------|--------------------------|
| — | MINUS | To set the time. |
| ⌚ | CLOCK | To set a clock function. |
| + | PLUS | To set the time. |



Clock functions table

| Clock function | | Application |
|---|---------------|---|
|  | Time of day | To set, change or check the time of day. |
|  | Minute Minder | To set countdown time. This function has no effect on the operation of the appliance. |
|  | Duration | To set the cooking time of the oven. |
|  | End | To set the time of day when the oven should deactivate. |

 You can use the functions Duration  and End  at the same time to set the time for how long the appliance should operate and when the appliance should deactivate. This lets you activate the appliance with a delay in time. First set the Duration  and then the End .

Setting the clock functions

For Duration  and End , set an oven function and temperature of cooking. This is not necessary for the Minute Minder .

1. Press  again and again until the indicator for the necessary clock function starts to flash.
2. Press  or  to set the time for the necessary clock function.

The clock function operates. The display shows the indicator for the clock function you set.

Oven - Hints and tips

 **WARNING!**
Refer to Safety chapters.



 The temperature and baking times in the tables are guidelines only. They depend on the recipes and the quality and quantity of the ingredients used.

Top oven



The top oven is the smaller of the two ovens. It has 3 shelf positions. Use it to cook smaller quantities of food. It gives especially good

 For the Minute Minder function the display shows the time left.

3. When the time ends the indicator of the clock function flashes and an acoustic signal sounds. Press a button to stop the signal.
4. Turn the knob for the oven functions and the knob for the temperature to the off position.

 With the Duration  and End  functions, the appliance deactivates automatically. The functions work only for the main oven.

Cancelling the clock functions

1. Press the  again and again until the necessary function indicator flashes.
 2. Press and hold .
- The clock function goes out after some seconds.

results when used to cook fruitcakes, sweets and savoury flants or quiche.

Main oven

The main oven is particularly suitable for cooking larger quantities of food.

Baking

- Your oven can bake or roast differently to the appliance you had before. Adapt your usual settings (temperature, cooking times) and shelf positions to the values in the tables.

- The manufacturer recommends that you use the lower temperature the first time.
- If you cannot find the settings for a special recipe, look for the one that is almost the same.
- You can extend baking times by 10 – 15 minutes if you bake cakes on more than one level.
- Cakes and pastries at different heights do not always brown equally at first. If this occurs, do not change the temperature

- setting. The differences equalize during the baking procedure.
- With longer baking times, you can deactivate the oven approximately 10 minutes before the end of the baking time and then use the residual heat.

When you cook frozen food, the trays in the oven can twist during baking. When the trays become cold again, the distortions are gone.

Tips on baking

| Baking results | Possible cause | Remedy |
|---|--|---|
| The bottom of the cake is not browned sufficiently. | The shelf position is incorrect. | Put the cake on a lower shelf. |
| The cake sinks and becomes soggy, lumpy or streaky. | The oven temperature is too high. | The next time you bake, set a slightly lower oven temperature. |
| The cake sinks and becomes soggy, lumpy or streaky. | The baking time is too short. | Set a longer baking time. You cannot decrease baking times by setting higher temperatures. |
| The cake sinks and becomes soggy, lumpy or streaky. | There is too much liquid in the mixture. | Use less liquid. Be careful with mixing times, especially if you use a mixing machine. |
| The cake is too dry. | The oven temperature is too low. | The next time you bake, set a higher oven temperature. |
| The cake is too dry. | The baking time is too long. | The next time you bake, set a shorter baking time. |
| The cake browns unevenly. | The oven temperature is too high and the baking time is too short. | Set a lower oven temperature and a longer baking time. |
| The cake browns unevenly. | The mixture is unevenly distributed. | Spread the mixture evenly on the baking tray. |
| The cake is not ready in the baking time given. | The oven temperature is too low. | The next time you bake, set a slightly higher oven temperature. |

Conventional Baking - Top Oven

| Food | Temperature (°C) | Time (min) | Shelf position |
|--------------------|------------------|------------|----------------|
| Biscuits | 170 - 190 | 10 - 20 | 2 |
| Bread | 200 - 220 | 30 - 35 | 2 |
| Bread rolls / buns | 200 - 220 | 10 - 15 | 2 |

| Food | Temperature (°C) | Time (min) | Shelf position |
|-----------------------------------|------------------------------------|------------|----------------|
| Cakes: Small & Queen | 160 - 180 | 18 - 25 | 2 |
| Cakes: Sponges | 160 - 175 | 20 - 30 | 2 |
| Cakes: Victoria Sandwich | 160 -170 | 18 - 25 | 2 |
| Cakes: Madeira | 140 - 150 | 75 - 90 | 2 |
| Cakes: Rich Fruit | 140 - 150 | 120 - 150 | 2 |
| Cakes: Gingerbread | 140 - 150 | 80 - 90 | 2 |
| Cakes: Meringues | 90 - 100 | 150 - 180 | 2 |
| Cakes: Flapjack | 160 - 170 | 25 -30 | 2 |
| Cakes: Shortbread | 130 - 150 | 45 - 60 | 2 |
| Cakes: Apple Pie | 170 - 180 | 50 - 60 | 2 |
| Casseroles: Beef / Lamb | 160 -170 | 150 - 180 | 2 |
| Casseroles: Chicken | 160 - 180 | 80 - 90 | 2 |
| Convenience Foods | Follow manufacturer's instructions | | 2 |
| Fish | 170 - 190 | 20 - 30 | 2 |
| Fish Pie (Potato Topped) | 190 - 200 | 20 - 30 | 2 |
| Fruit Pies, Crumbles | 190 - 200 | 30 - 50 | 2 |
| Milk Puddings | 150 - 170 | 90 -120 | 2 |
| Pasta Lasagne etc. | 170 - 180 | 40 -50 | 2 |
| Pastry: Choux | 180 - 190 | 30 - 40 | 2 |
| Pastry: Eclairs, Profiteroles | 180 - 190 | 30 - 40 | 2 |
| Pastry: Flaky / Puff Pies | 210 - 220 | 30 - 40 | 2 |
| Shortcrusts: Mince Pies | 190 - 200 | 15 - 20 | 2 |
| Shortcrusts: Meat Pies | 190 - 210 | 25 - 35 | 2 |
| Shortcrusts: Quiche, Tarts, Flans | 180 - 200 | 25 - 50 | 2 |
| Scones | 220 - 230 | 8 - 12 | 3 |
| Shepard's Pie | 190 - 200 | 30 - 40 | 2 |
| Souffles | 170 - 180 | 20 - 30 | 2 |
| Vegetables: Baked Jacket Potatos | 180 - 190 | 60 - 90 | 2 |
| Vegetables: Roast Potatos | 180 - 190 | 60 - 90 | 2 |
| Yorkshire Pudding Large | 220 - 210 | 25 - 40 | 2 |

| Food | Temperature (°C) | Time (min) | Shelf position |
|------------------------------|-----------------------------|------------|----------------|
| Yorkshire Pudding Individual | 210 - 220 | 15 - 25 | 2 |
| Roasting Meat, Poultry | Refer to the Roasting table | | 2 |

Thermaflow® Baking - Main Oven

i Shelf positions are not critical but ensure that the oven accessories are evenly spaced when more than one is used.

| Food | Temperature (°C) | Time (min) | Shelf position |
|-------------------------|---|-----------------------------|----------------|
| Biscuits | 180 - 190 | 10 - 20 | 1 - 3 |
| Bread | 190 - 210 | 30 - 35 | 2 |
| Cakes: Small & Queen | 150 - 170 | 18 - 25 | 1 - 3 |
| Cakes: Sponges | 160 - 170 | 20 - 25 | 3 |
| Cakes: Madeira | 140 - 160 | 60 - 80 | 3 |
| Cakes: Rich Fruit | 130 - 140 | 120 - 150 | 3 |
| Cakes: Christmas | 130 - 140 | 180 - 270 | 3 |
| Cakes: Apple Pie | 160 - 170 | 50 - 60 | 3 |
| - Shortbread | 130 - 150 | 45 - 60 | 1 - 3 |
| Fish | 160 - 180 | 30 - 40 | 3 |
| Fruit Pies, Crumbles | 170 - 180 | 30 - 50 | 3 |
| Milk Puddings | 140 - 160 | 60 - 90 | 3 |
| Pastry: Choux | 180 - 190 | 30 - 40 | 3 |
| Pastry: Shortcrust | 180 - 190 | 25 - 35 | 3 |
| Pastry: Flaky | 180 - 190 | 30 - 40 | 3 |
| Pastry: Puff | Follow manufacturer's instructions. Reduce the temperature for Fan oven by 20°C | | 3 |
| Plate Tarts | 180 - 190 | 25 - 45 | 3 |
| Quiches/Flans | 170 - 180 | 25 - 45 | 3 |
| Scones | 210 - 230 | 8 - 12 | 1 - 3 |
| Roasting: Meat, Poultry | 160 - 180 | Refer to the Roasting table | 2 |

Roasting

- Use heat-resistant ovenware to roast (refer to the instructions of the manufacturer).
 - You can roast large roasting joints directly in the deep pan (if present) or on the wire shelf above the deep pan.
 - Roast lean meats in the roasting tin with the lid. This keeps the meat more succulent.
 - All types of meat that can be browned or have crackling can be roasted in the roasting tin without the lid.
 - We recommend that you cook meat and fish weighing 1 kg and above in the appliance.
- To prevent the meat juices or fat from burning onto the pan, put some liquid into the deep pan.
 - If necessary, turn the roast (after 1/2 - 2/3 of the cooking time).
 - Baste large roasts and poultry with their juices several times during roasting. This gives better roasting results.
 - You can deactivate the appliance approximately 10 minutes before the end of the roasting time, and use the residual heat.

Thermaflow® - Main Oven

Roasting

| Food | Temperature (°C) | Time (min) |
|-------------------|------------------|--|
| Beef / Beef boned | 170 - 190 | 20 - 35 minutes per 0.5 kb (1 lb) and 20-30 minutes over |
| Mutton / Lamb | 170 - 190 | 20 - 35 minutes per 0.5 kb (1 lb) and 25-35 minutes over |
| Pork / Veal / Ham | 170 - 190 | 30 - 40 minutes per 0.5 kb (1 lb) and 30-40 minutes over |
| Chicken | 180 - 200 | 20 - 25 minutes per 0.5 kb (1 lb) and 20 minutes over |
| Turkey / Goose | 170 - 190 | 15 - 20 minutes per 0.5 kg (1 lb) up to 3.5 kg (7 lb) then 10 minutes per 0.5 kg (1 lb) over 3.5 kg (7 lb) |
| Duck | 180 - 200 | 25 - 35 minutes per 0.5 kb (1 lb) and 25-30 minutes over |
| Pheasant | 170 -190 | 35 - 40 minutes per 0.5 kb (1 lb) and 35-40 minutes over |
| Rabbit | 170 - 190 | 20 minutes per 0.5 kb (1 lb) and 20minutes over |

Grilling in general



WARNING!

Always grill with the oven door closed.

- **Always grill with the maximum temperature setting.**
- Set the shelf into the shelf position as recommended in the grilling table.
- Always set the deep pan to collect the fat into the first shelf position.
- Set the deep pan and the trivet as recommended in the grilling table
- Grill only flat pieces of meat or fish.

- **Always preheat an empty oven with the grill functions for 5 minutes.**

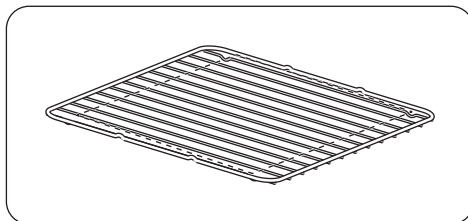

The grilling area is set in centre of the shelf.

Dual Grill - Top Oven

| Food | Time (min) | Shelf position |
|--------------------------------|------------|----------------|
| Bacon Rashers | 5 - 6 | 3 |
| Beefburgers | 10 - 20 | 3 |
| Chicken Joints | 20 - 40 | 2 |
| Chops - Lamb | 15 - 25 | 2 - 3 |
| Chops - Pork | 20 - 25 | 2 - 3 |
| Fish - Whole / Trout / Makarel | 10 - 12 | 2 |
| Fillets - Plaice/Cod | 4 - 6 | 2 |
| Kebabs | 12 - 18 | 2 - 3 |
| Kidneys - Lamb / Pig | 6 - 10 | 2 - 3 |
| Sausages | 20 - 30 | 3 |
| Steaks: Rare | 4 - 6 | 3 |
| Steaks: Medium | 6 - 8 | 3 |
| Steaks: Well Done | 12 - 15 | 3 |
| Toasted Sandwiches | 3 - 4 | 3 |

Defrosting

- Remove the food packaging. Put the food on a plate.
- Do not cover it with a bowl or a plate. This can extend the defrost time.

- Use the first oven shelf level. The one on the bottom.

Oven - Care and cleaning



WARNING!

Refer to Safety chapters.

Notes on cleaning

- Clean the front of the appliance with a soft cloth with warm water and a cleaning agent.
- To clean metal surfaces, use a usual cleaning agent.
- Clean the appliance interior after each use. Fat accumulation or other food remains may result in a fire. The risk is higher for the grill pan.
- Clean stubborn dirt with a special oven cleaner.
- Clean all accessories after each use and let them dry. Use a soft cloth with warm water and a cleaning agent.

- If you have nonstick accessories, do not clean them using aggressive agents, sharp-edged objects or a dishwasher. It can cause damage to the nonstick coating.

Stainless steel or aluminium appliances



Clean the oven door with a wet sponge only. Dry it with a soft cloth. Do not use steel wool, acids or abrasive materials as they can damage the oven surface. Clean the oven control panel with the same precautions.

Catalytic cleaning



CAUTION!

Do not clean the catalytic surface with oven sprays, abrasive cleaning agents, soap or other cleaning agents. This will damage the catalytic surface.



Spots or discolouration of the catalytic surface have no effect on catalytic properties.



WARNING!

Keep children away when you clean the oven at a high temperature. The oven surface becomes very hot and there is a risk of burns.



CAUTION!

Always turn the oven light on while using the catalytic cleaning (if applicable).



Before activating the catalytic cleaning remove all the accessories from the oven.

The walls with a catalytic coating are self-cleaning. They absorb fat which collects on the walls while the appliance operates.

To support the self-cleaning procedure, heat the empty oven on a regular basis.

Catalytic cleaning works only in the main oven.

1. Clean the oven floor with warm water and washing up liquid, then dry it.
2. Set the oven temperature to 250 °C and let the oven operate for 1 hour.
3. When the appliance is cool, clean it with a soft and moist sponge.

Removing and cleaning the door glasses - top oven



The door glass on your product can be different in type and shape from the examples you see in the graphic. The number of glasses can also be different.

1. Open the door.
2. Hold the door trim on the top edge of the door at the two sides and push inwards to release the clip seal.

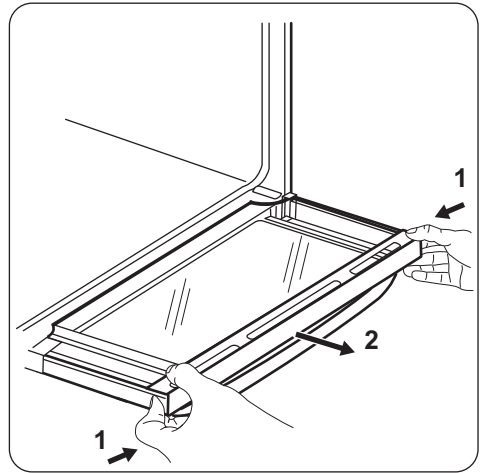

3. Pull the door trim to the front to remove it.
 4. Remove the glass panels.
- To install the panels, do the same steps in reverse.

Removing and cleaning the door glasses - main oven



The door glass on your product can be different in type and shape from the example you see in the graphic. The number of glasses can also be different.

1. Push the door trim at one side to remove it.

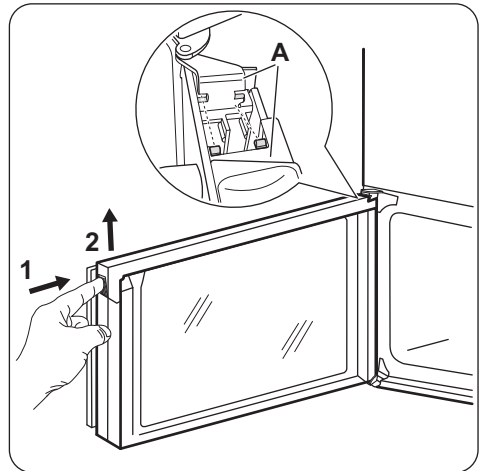

2. Pull up the trim.
3. Remove the glass panels.

 To replace the glass panels, do the same steps in reverse. Before you lower the trim, attach the A trim part to the door. Refer to the graphic.

Replacing the lamp

Put a cloth on the bottom of the interior of the appliance. It prevents damage to the lamp glass cover and the cavity.

 **WARNING!**
Danger of electrocution! Disconnect the fuse before you replace the lamp. The lamp and the lamp glass cover can be hot.

1. Deactivate the appliance.
2. Remove the fuses from the fuse box or deactivate the circuit breaker.

The back lamp

 The lamp glass cover is at the back of the cavity.

1. Turn the lamp glass cover counterclockwise to remove it.
2. Clean the glass cover.
3. Replace the oven lamp with a suitable 300 °C heat-resistant oven lamp. Use the same oven lamp type.
4. Install the glass cover.

Troubleshooting

 **WARNING!**
Refer to Safety chapters.

What to do if...

| Problem | Possible cause | Remedy |
|--|--|---|
| You cannot activate the appliance. | The appliance is not connected to an electrical supply or it is connected incorrectly. | Check if the appliance is correctly connected to the electrical supply. |
| You cannot activate the appliance. | The fuse is released. | Make sure that the fuse is the cause of the malfunction. If the fuse releases again and again, contact a qualified electrician. |
| Residual heat indicator does not come on. | The zone is not hot because it operated only for a short time. | If the zone operated sufficiently long to be hot, speak to an Authorised Service Centre. |
| The oven does not heat up. | The oven is deactivated. | Activate the oven. |
| The oven does not heat up. | The clock is not set. | Set the clock. |
| The oven does not heat up. | The necessary settings are not set. | Make sure that the settings are correct. |
| The lamp does not operate. | The lamp is defective. | Replace the lamp. |
| The display shows "12.00". | There was a power cut. | Reset the clock. |
| Steam and condensation settle on the food and in the cavity of the oven. | You left the dish in the oven for too long. | Do not leave the dishes in the oven for longer than 15 - 20 minutes after the cooking process ends. |

Service data

If you cannot find a solution to the problem yourself, contact your dealer or an Authorised Service Centre.

The necessary data for the service centre is on the rating plate. The rating plate is on the front frame of the appliance cavity. Do not remove the rating plate from the appliance cavity.

We recommend that you write the data here:

| | |
|----------------------|-------|
| Model (MOD.) | |
| Product number (PNC) | |
| Serial number (S.N.) | |

Installation



WARNING!

Refer to Safety chapters.

Technical data

| Dimensions | |
|--------------------|--------------|
| Height | 894 - 912 mm |
| Width | 550 mm |
| Depth | 600 mm |
| Top oven capacity | 37 l |
| Main oven capacity | 74 l |

Location of the appliance

You can install your freestanding appliance with cabinets on one or two sides and in the corner.

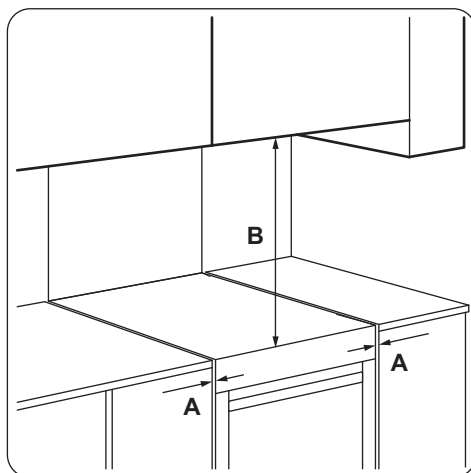

Minimum distances

| Dimension | mm |
|-----------|-----|
| A | 2 |
| B | 685 |

Levelling of the appliance

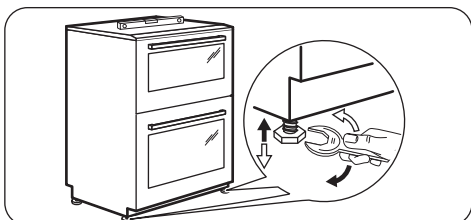

Use small feet on the bottom of appliance to set the appliance top surface level with other surfaces.

Electrical installation



WARNING!

The manufacturer is not responsible if you do not follow the safety precautions from Safety chapters.

This appliance is supplied without a main plug or a main cable.

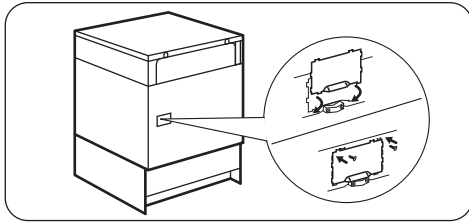

Applicable cable types: H07 RN-F, H05 RN-F, H05 RR-F, H05 VV-F, H05 V2V2-F (T90), H05 BB-F.

Covering terminal board



- The recommended cross-section area is six square millimetres (6 mm²).

ENVIRONMENTAL CONCERNS

Recycle the materials with the symbol . Put the packaging in applicable containers to recycle it. Help protect the environment and human health and to recycle waste of electrical and electronic appliances. Do not dispose appliances marked with the symbol  with the household waste. Return the product to your local recycling facility or contact your municipal office.

- When you refit the mains terminal cover, make sure that the lower tabs are located inside the bottom edge of the aperture, before you fix the two screws into the top edge of the mains terminal cover.
- Make sure that the cover is securely fastened.



To open the cover of terminal board obey the procedure in opposite sequence.

Terminal board



Do not remove blanking plates.

Make sure that the links are fitted as shown.

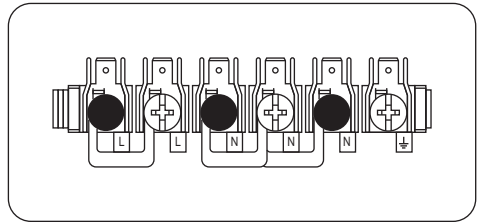



www.zanussi.com/shop



867307041-A-122014