



Digital Video Recorder

User Manual

UD.6L0202D1336A01

Hikvision® Network Digital Video Recorder User Manual

This manual, as well as the software described in it, is furnished under license and may be used or copied only in accordance with the terms of such license. The content of this manual is furnished for informational use only, is subject to change without notice, and should not be construed as a commitment by Hangzhou Hikvision Digital Technology Co., Ltd. (Hikvision). Hikvision assumes no responsibility or liability for any errors or inaccuracies that may appear in the book.

Except as permitted by such license, no part of this publication may be reproduced, stored in a retrieval system, or transmitted, in any form or by any means, electronic, mechanical, recording, or otherwise, without the prior written permission of Hikvision.

HIKVISION MAKES NO WARRANTIES, EXPRESS OR IMPLIED, INCLUDING WITHOUT LIMITATION THE IMPLIED WARRANTIES OF MERCHANTABILITY AND FITNESS FOR A PARTICULAR PURPOSE, REGARDING THE HIKVISION SOFTWARE. HIKVISION DOES NOT WARRANT, GUARANTEE, OR MAKE ANY REPRESENTATIONS REGARDING THE USE OR THE RESULTS OF THE USE OF THE HIKVISION SOFTWARE IN TERMS OF ITS CORRECTNESS, ACCURACY, RELIABILITY, CURRENTNESS, OR OTHERWISE. THE ENTIRE RISK AS TO THE RESULTS AND PERFORMANCE OF THE HIKVISION SOFTWARE IS ASSUMED BY YOU. THE EXCLUSION OF IMPLIED WARRANTIES IS NOT PERMITTED BY SOME STATES. THE ABOVE EXCLUSION MAY NOT APPLY TO YOU.

IN NO EVENT WILL HIKVISION, ITS DIRECTORS, OFFICERS, EMPLOYEES, OR AGENTS BE LIABLE TO YOU FOR ANY CONSEQUENTIAL, INCIDENTAL, OR INDIRECT DAMAGES (INCLUDING DAMAGES FOR LOSS OF BUSINESS PROFITS, BUSINESS INTERRUPTION, LOSS OF BUSINESS INFORMATION, AND THE LIKE) ARISING OUT OF THE USE OR INABILITY TO USE THE HIKVISION SOFTWARE EVEN IF HIKVISION HAS BEEN ADVISED OF THE POSSIBILITY OF SUCH DAMAGES. BECAUSE SOME STATES DO NOT ALLOW THE EXCLUSION OR LIMITATION OF LIABILITY FOR CONSEQUENTIAL OR INCIDENTAL DAMAGES, THE ABOVE LIMITATIONS MAY NOT APPLY TO YOU.

Thank you for purchasing our product. If there is any question or request, please do not hesitate to contact dealer. This manual is applicable to following embedded network DVR series.

Series	Model	Type
9200HWI-ST Series	DS-9204/08/16HWI-ST	Network DVR
9100HFI-ST Series	DS-9104/08/16HFI-ST	Network DVR
9100HWI-ST Series	DS-9104/08/16HWI-ST	Network DVR
9100HFI-RT Series	DS-9104/08/16HFI-RT	Network DVR
9100HFI-XT Series	DS-9116HFI-XT	Network DVR
9000HFI-ST Series	DS-9004/08/16HFI-ST	Network HDVR
9000HWI-ST Series	DS-9004/08/16HWI-ST	Network HDVR
9000HFI-RT Series	DS-9004/08/16HFI-RT	Network HDVR
9000HFI-XT Series	DS-9016HFI-XT	Network HDVR
8100HFI-ST Series	DS-8104/08/16HFI-ST	Network DVR
8100HWI-ST Series	DS-8104/08/16HWI-ST	Network DVR
8000HFI-ST Series	DS-8004/08/16HFI-ST	Network HDVR
8000HWI-ST Series	DS-8004/08/16HWI-ST	Network HDVR
7200HWI-SV Series	DS-7208/16HWI-SV	Network DVR

This manual may contain several technically incorrect places or printing errors, and the content is subject to change without notice. The updates will be added into the new version of this manual. We will readily improve or update the products or procedures described in the manual.

In order to simplify the description, we make the following conventions (unless otherwise stated):

We define DS-9200HWI-ST, DS-9100HFI-ST, 9100HWI-ST, 9100HFI-RT, 9100HFI-XT, 8100HFI-ST, 8100HWI-ST, and 7200HWI-SV series as **DVR**, and 9000HFI-ST, 9000HWI-ST, 9000HFI-RT, 9000HFI-XT, 8000HFI-ST and 8000HWI-ST series as **HDVR** (Hybrid DVR) in this manual.

The front panel operation is not supported by 7200HWI-SV series.

The figures shown in this manual are for reference only. The appearance and interface of the device are subject to the actual model.

Regulatory information

FCC information

FCC compliance: This equipment has been tested and found to comply with the limits for a digital device, pursuant to part 15 of the FCC Rules. These limits are designed to provide reasonable protection against harmful interference when the equipment is operated in a commercial environment. This equipment generates, uses, and can radiate radio frequency energy and, if not installed and used in accordance with the instruction manual, may cause harmful interference to radio communications. Operation of this equipment in a residential area is likely to cause harmful interference in which case the user will be required to correct the interference at his own expense.

FCC conditions

This device complies with part 15 of the FCC Rules. Operation is subject to the following two conditions:

1. This device may not cause harmful interference.
2. This device must accept any interference received, including interference that may cause undesired operation.

EU Conformity Statement



This product and - if applicable - the supplied accessories too are marked with "CE" and comply therefore with the applicable harmonized European standards listed under the Low Voltage Directive 2006/95/EC, the EMC Directive 2004/108/EC, the RoHS Directive 2011/65/EU.



2012/19/EU (WEEE directive): Products marked with this symbol cannot be disposed of as unsorted municipal waste in the European Union. For proper recycling, return this product to your local supplier upon the purchase of equivalent new equipment, or dispose of it at designated collection points. For more information see: www.recyclethis.info.



2006/66/EC (battery directive): This product contains a battery that cannot be disposed of as unsorted municipal waste in the European Union. See the product documentation for specific battery information. The battery is marked with this symbol, which may include lettering to indicate cadmium (Cd), lead (Pb), or mercury (Hg). For proper recycling, return the battery to your supplier or to a designated collection point. For more information see: www.recyclethis.info.

Preventive and Cautionary Tips

Before connecting and operating your device, please be advised of the following tips:

- Ensure unit is installed in a well-ventilated, dust-free environment.
- Unit is designed for indoor use only.
- Keep all liquids away from the device.
- Ensure environmental conditions meet factory specifications.
- Ensure unit is properly secured to a rack or shelf. Major shocks or jolts to the unit as a result of dropping it may cause damage to the sensitive electronics within the unit.
- Use the device in conjunction with an UPS if possible.
- Power down the unit before connecting and disconnecting accessories and peripherals.
- A factory recommended HDD should be used for this device.
- Improper use or replacement of the battery may result in hazard of explosion. Replace with the same or equivalent type only. Dispose of used batteries according to the instructions provided by the battery manufacturer.

Product Key Features

General

- Connectable to the network cameras, network dome and encoders (this feature is supported by HDVR series).
- Connectable to the third-party network cameras like ACTI, Arecont, AXIS, Brickcom, Bosch, Canon, PANASONIC, Pelco, SAMSUNG, SANYO, SONY, Vivotek and ZAVIO (this feature is supported by HDVR series).
- Connectable to the third-party network cameras that support ONVIF or PSIA protocol (this feature is supported by HDVR series).
- Connectable to Hikvision smart IP cameras.
- PAL/NTSC adaptive video inputs.
- H.264 video compression with high reliability and superior definition.
- Each channel supports dual-stream.
- Up to 32 network cameras can be added (this feature is supported by HDVR series).
- Independent configuration for each channel, including resolution, frame rate, bitrate, image quality, etc.
- The quality of the input and output video is configurable.
- Each channel supports two kinds of compression parameters, the normal continuous and event. Sub-stream can be configured locally.
- Encoding for both audio/video composite stream and video stream; audio and video synchronization during composite stream encoding.
- Support CABAC (this feature is supported by analog cameras only).
- Watermark technology.
- Defog technology providing correct and natural image (this feature is only supported by DS-9200 series DVR).

Local Monitoring

- Simultaneous HDMI, VGA and CVBS outputs.
- HDMI output and VGA output at up to 1920×1080P resolution.
- Multi-screen display in live view is supported, and the display sequence of screens is adjustable.
- Live view screen can be switched in group, and manual switch and automatic cycle review is also provided, the interval of automatic cycle can be adjusted.
- Quick setting menu is provided for live view.
- The selected live view channel can be shielded.
- Motion detection, video tampering detection, video exception alarm and video loss alarm functions.
- VCA alarm function (this feature is only supported by HDVR series)
- Privacy mask.
- Several PTZ protocols supported; PTZ preset, patrol and pattern.
- Zooming in by clicking the mouse and PTZ tracing by dragging mouse.

HDD Management

- For DS-9100/9000HFI-XT series, up to 16 SATA hard disks and 2 eSATA disks can be connected; for DS-7200HWI-SV series, up to 2 SATA hard disks can be connected; and for other models, up to 8 SATA hard disks and 1 eSATA disk can be connected, each disk with a maximum of 4TB

storage capacity.

- 8 network disks (8 NAS disks, or 7 NAS disks+1 IP SAN disk) can be connected.
- Support eSATA disk for recording or backup.
- Hot-swappable HDD supporting RAID0, RAID1, RAID5 and RAID10 storage schemes. And 8 virtual disks can be configurable (this feature is supported by DS-9100/9000HFI-RT series only).
- HDD hot swap function (the feature is supported by DS-9100/9000HFI-RT series only).
- HDD group management.
- Support HDD standby function.
- HDD property: redundancy, read-only, read/write (R/W).
- HDD quota management; different capacity can be assigned to different channel.
- HDD frame-extracting management to extend the record time (this feature is supported by DVR series).
- Support S.M.A.R.T. and bad sector detection (this feature is not supported by DS-9100/9000HFI-RT series).
- Disk clone function (this feature is not supported by 9100HFI-RT/9000HFI-RT/7200HWI-SV series)

Recording, Capture and Playback

- Provide new playback interface with easy and flexible operation.
- Holiday recording schedule configuration.
- Normal and event video encoding parameters.
- Multiple recording types: manual, normal, alarm, motion, motion | alarm, motion & alarm, VCA.
- 8 recording time periods with separated recording types.
- Pre-record and post-record for alarm, motion detection recording, and pre-record time for schedule and manual recording.
- Searching record files and captured pictures by events (alarm input/motion detection/VCA).
- Customization of tags, searching and playing back by tags.
- Locking and unlocking record files.
- Local redundant recording and capture.
- Searching and playing back record files by camera No., recording type, start time, end time, etc.
- Smart search for the selected area in the video.
- Smart playback to go through less effective information;
- Zooming in when playback.
- Reverse playback for multi-channel.
- Supports pause, fast forward, slow forward, skip forward, and skip backward when playback, locating by dragging the mouse.
- For DS-9200/9100/9000/8100HWI-ST & DS-7200HWI-SV, up to 16-ch synchronous playback at WD1 real time; for other models, up to 16-ch synchronous playback at 4CIF real time.
- Manual capture, continuous capture of video images and playback of captured pictures.

Backup

- Export video data by USB, SATA or eSATA device.
- Export video clips when playback.
- Management and maintenance of backup devices.
- Support NTFS and FAT32 formatted backup devices.

Alarm and Exception

- Configurable arming time of alarm input/output.
- Alarm for video loss, motion detection, tampering, abnormal signal, video input/output standard

mismatch, illegal login, network disconnected, IP confliction, abnormal record/capture, HDD error, and HDD full, etc.

- Alarm triggers full screen monitoring, audio alarm, notifying surveillance center, sending email and alarm output.
- Automatic restore when system is abnormal.

Other Local Functions

- Users can operate by front panel, mouse, remote control, and control keyboard.
- Three-level user management; admin user is allowed to create many operating accounts and define their operating permission, which includes the limit to access any camera.
- Operation, alarm, exceptions and log recording and searching.
- Manually triggering and clearing alarms.
- Importing and exporting of device configuration file.
- Manual video quality diagnostics for analog channels.
- Either normal or hot spare working mode is configurable to constitute an N+1 hot spare system (this function is supported by HDVR series only).

Network Functions

- 2 self-adaptive 10M/100M/1000M network interfaces, and three working modes are configurable: multi-address, load balance and network fault tolerance.
- IPv6 is supported.
- TCP/IP protocol, PPPoE, DHCP, DNS, DDNS, NTP, SADP, SMTP, SNMP, NFS, and iSCSI are supported.
- TCP, UDP and RTP for unicast.
- Auto/Manual port mapping and automatically discovered by NAT.
- Remote web browser access by HTTPS ensures high security.
- Remote reverse playback by RTSP.
- Support accessing by the platform by ONVIF.
- Remote search, playback, download, locking and unlocking the record files, and downloading files broken transfer resume.
- Remote parameters setup; remote import/export of device parameters.
- Remote viewing of the device status, system logs and alarm status.
- Remote keyboard operation.
- Remote locking and unlocking of control panel and mouse.
- Remote HDD formatting and program upgrading.
- Remote system restart.
- RS-232, RS-485 transparent channel transmission.
- Alarm and exception information can be sent to the remote host
- Remotely start/stop recording.
- Remotely start/stop alarm output.
- Captured pictures can be sent to the FTP server which supports FTP and SFTP protocol, and two FTP servers can be configured (this feature is supported by DVR series).
- Upgraded by remote FTP server is supported.
- Remote PTZ control.
- Remote JPEG capture.
- Two-way voice talk and voice broadcasting.
- Embedded WEB server.

Development Scalability:

- SDK for Windows and Linux system.
- Source code of application software for demo.
- Development support and training for application system.

TABLE OF CONTENTS

<i>Product Key Features</i>	5
Chapter 1 Introduction	14
1.1 Front Panel	15
1.2 IR Remote Control Operations.....	19
1.3 USB Mouse Operation	22
1.4 Input Method Description.....	23
1.5 Rear Panel	24
1.6 Starting Up and Shutting Down the Device	27
Chapter 2 Getting Started	29
2.1 Using the Wizard for Basic Configuration	30
2.2 Adding and Connecting the IP Cameras.....	34
2.2.1 Adding the IP Cameras.....	34
2.2.2 Configuring the Connected IP Cameras	38
Chapter 3 Live View	41
3.1 Introduction of Live View	42
3.2 Operations in Live View Mode.....	43
3.2.1 Front Panel Operation	43
3.2.2 Using the Mouse in Live View	44
3.2.3 Using an Auxiliary Monitor	45
3.2.4 Quick Setting Toolbar in Live View Mode	46
3.3 Adjusting Live View Settings	50
3.4 Channel-zero Encoding.....	52
3.5 Manual Video Quality Diagnostics	53
3.6 User Logout	54
Chapter 4 PTZ Control	55
4.1 Configuring PTZ Settings	56
4.2 Setting PTZ Presets, Patrols & Patterns.....	57
4.2.1 Customizing Presets	57
4.2.2 Calling Presets.....	58
4.2.3 Customizing Patrols	59
4.2.4 Calling Patrols	60
4.2.5 Customizing Patterns	61

4.2.6	Calling Patterns	62
4.3	PTZ Control Panel.....	63
Chapter 5	Record and Capture Settings.....	65
5.1	Configuring Encoding Parameters	66
5.2	Configuring Record/Capture Schedule	70
5.3	Configuring Motion Detection Recording and Capture.....	74
5.4	Configuring Alarm Triggered Recording and Capture	76
5.5	Configuring Manual Recording and Continuous Capture	79
5.6	Configuring Holiday Recording and Capture.....	81
5.7	Configuring Redundant Recording and Capture	83
5.8	Configuring HDD Group for Recording and Capture	85
5.9	Files Protection.....	87
5.9.1	Locking the Record Files	87
5.9.2	Setting HDD property to Read-only.....	89
Chapter 6	Playback	91
6.1	Playing Back Record Files.....	92
6.1.1	Playing Back by Channel	92
6.1.2	Playing Back by Time	94
6.1.3	Playing Back by Event Search	96
6.1.4	Playing Back by Tag	100
6.1.5	Smart Playback.....	104
6.1.6	Playing Back by Searching System Log	106
6.1.7	Playing Back External Files	107
6.1.8	Playing Back Frame Extracting Record	108
6.2	Auxiliary Functions of Playback.....	110
6.2.1	Playing Back Frame by Frame	110
6.2.2	Smart Search	110
6.2.3	Digital Zoom	112
6.2.4	Reverse Playback of Multi-channel	112
6.3	Picture Playback.....	114
Chapter 7	Backup.....	116
7.1	Backing up Record Files.....	117
7.1.1	Quick Export	117
7.1.2	Backing up by Normal Video Search	118
7.1.3	Backing up by Event Search	121
7.1.4	Backing up Video Clips.....	123

7.2	<i>Backing up Pictures</i>	126
7.3	<i>Managing Backup Devices</i>	129
7.4	<i>Hot Spare Backup</i>	131
7.4.1	Setting the Hot Spare Device	131
7.4.2	Setting the Working Device	132
7.4.3	Hot Spare Management	133
Chapter 8 Alarm Settings		135
8.1	<i>Setting Motion Detection</i>	136
8.2	<i>Setting Sensor Alarm</i>	139
8.3	<i>Setting VCA Alarm</i>	142
8.4	<i>Detecting Video Loss</i>	144
8.5	<i>Detecting Video Tampering</i>	146
8.6	<i>Handling Exceptions</i>	148
8.7	<i>Setting Alarm Linkage Actions</i>	150
8.8	<i>Triggering or Clearing Alarm Output Manually</i>	153
Chapter 9 Network Settings		154
9.1	<i>Configuring General Settings</i>	155
9.2	<i>Configuring Advanced Settings</i>	158
9.2.1	Configuring PPPoE Settings	158
9.2.2	Configuring DDNS Settings.....	158
9.2.3	Configuring NTP Server Settings.....	162
9.2.4	Configuring FTP Server Settings	163
9.2.5	Configuring SNMP Settings.....	164
9.2.6	Configuring NAT Settings.....	165
9.2.7	Configuring Remote Alarm Host Settings.....	167
9.2.8	Configuring Multicast Settings	168
9.2.9	Configuring RTSP Settings	169
9.2.10	Configuring Server and HTTP Ports Settings	169
9.2.11	Configuring HTTPS Settings	170
9.2.12	Configuring High-speed Download Settings.....	171
9.2.13	Configuring Email Settings.....	172
9.2.14	Virtual Host Settings	174
9.2.15	Telnet Settings.....	175
9.3	<i>Checking Network Traffic</i>	176
9.4	<i>Network Detection</i>	177
9.4.1	Testing Network Delay and Packet Loss.....	177
9.4.2	Exporting Network Packet	178

9.4.3	Checking Network Status	179
9.4.4	Checking Network Statistics	180
Chapter 10	RAID Configuration.....	181
10.1	<i>Configuring Array and Virtual Disk.....</i>	<i>182</i>
10.1.1	One-touch Configuration.....	183
10.1.2	Manually Creating Array and Virtual Disk.....	184
10.2	<i>Rebuilding Array.....</i>	<i>189</i>
10.2.1	Automatically Rebuilding Array	189
10.2.2	Manually Rebuilding Array.....	190
10.3	<i>Repairing Virtual Disk</i>	<i>191</i>
10.4	<i>Deleting Array / Virtual Disk</i>	<i>192</i>
10.4.1	Deleting the Virtual Disk.....	192
10.4.2	Deleting the Array	192
10.5	<i>Upgrading Firmware</i>	<i>194</i>
Chapter 11	HDD Management.....	196
11.1	<i>Initializing HDDs.....</i>	<i>197</i>
11.2	<i>Managing Network HDD</i>	<i>199</i>
11.3	<i>Managing eSATA.....</i>	<i>202</i>
11.4	<i>Managing HDD Group</i>	<i>203</i>
11.4.1	Setting HDD Groups	203
11.4.2	Setting HDD Property	204
11.5	<i>Configuring Quota Mode.....</i>	<i>206</i>
11.6	<i>Configuring Frame Extracting Mode</i>	<i>208</i>
11.7	<i>Configuring Disk Clone</i>	<i>210</i>
11.8	<i>Checking HDD Status</i>	<i>212</i>
11.9	<i>Checking S.M.A.R.T. Information</i>	<i>213</i>
11.10	<i>Detecting Bad Sector</i>	<i>214</i>
11.11	<i>Configuring HDD Error Alarms.....</i>	<i>215</i>
Chapter 12	Camera Settings.....	216
12.1	<i>Configuring OSD Settings.....</i>	<i>217</i>
12.2	<i>Configuring Privacy Mask.....</i>	<i>219</i>
12.3	<i>Configuring Video Parameters</i>	<i>220</i>
Chapter 13	Device Management and Maintenance	222
13.1	<i>Viewing System Information.....</i>	<i>223</i>

13.1.1	Viewing Device Information	223
13.1.2	Viewing Camera Information	223
13.1.3	Viewing Record Information	224
13.1.4	Viewing Alarm Information	225
13.1.5	Viewing Network Information	225
13.1.6	Viewing HDD Information	226
13.2	<i>Searching & Exporting Log Files</i>	227
13.3	<i>Importing/Exporting Configuration Files</i>	230
13.4	<i>Upgrading System</i>	231
13.4.1	Upgrading by Local Backup Device	231
13.4.2	Upgrading by FTP	231
13.5	<i>Restoring Default Settings</i>	232
Chapter 14	Others	233
14.1	<i>Configuring RS-232 Serial Port</i>	234
14.2	<i>Configuring General Settings</i>	235
14.3	<i>Configuring DST Settings</i>	237
14.4	<i>Configuring More Settings</i>	238
14.5	<i>Managing User Accounts</i>	239
14.5.1	Adding a User	239
14.5.2	Deleting a User	241
14.5.3	Editing a User	242
14.5.4	Changing Password of Admin	243
14.6	<i>Logging out / Shutting down / Rebooting Device</i>	245
Chapter 15	Appendix	246
	<i>Glossary</i>	247
	<i>Troubleshooting</i>	248
	<i>Summary of Changes</i>	253
	<i>List of Compatible IP Cameras</i>	254
	List of Hikvision IP Cameras	254
	List of Third-party IP Cameras	260

Chapter 1 Introduction

1.1 Front Panel

The front panels of the devices are shown in Figure 1.1.

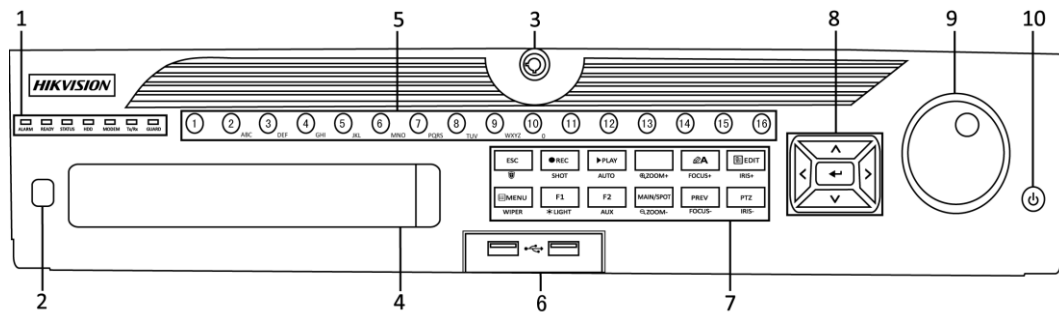

DS-9100/9000HFI-ST & DS-9100/9000HFI-RT & DS-9200HWI-ST

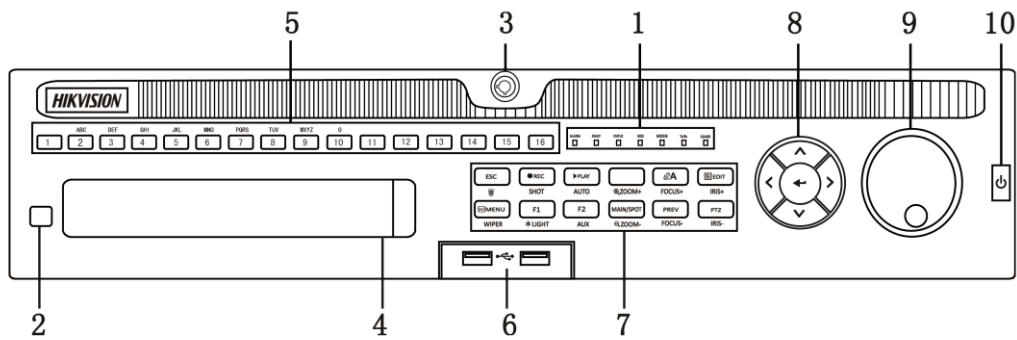

DS-9100/9000HWI-ST

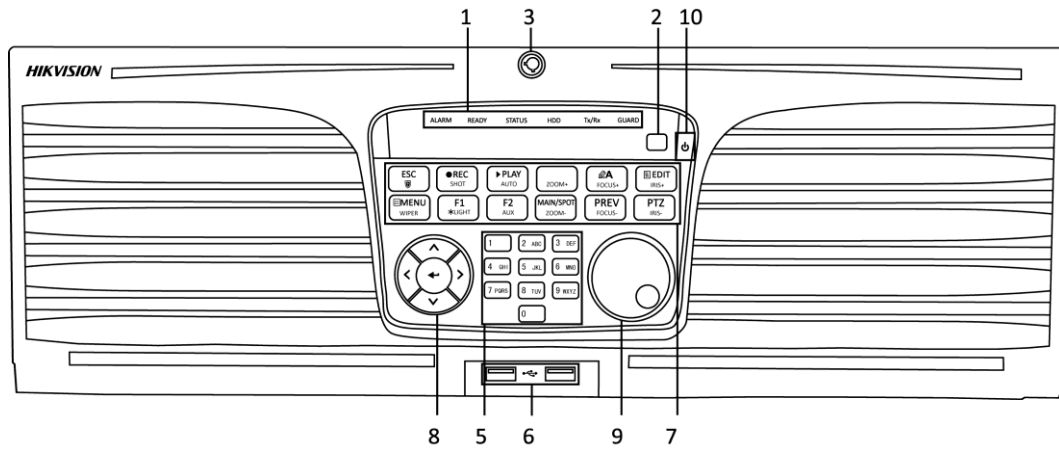

DS-9100/9000HFI-XT

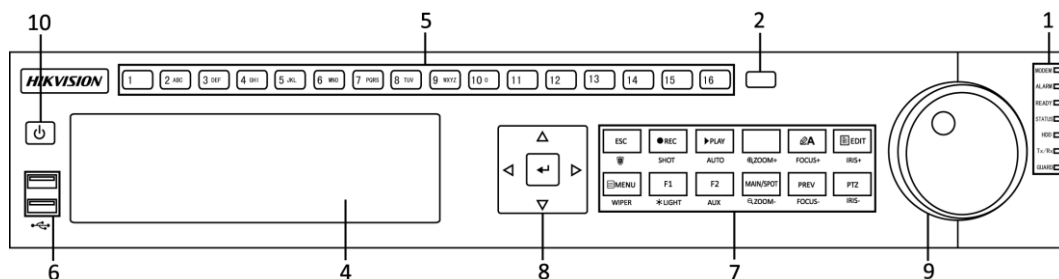

DS-8100/8000HFI-ST & DS-8100/8000HWI-ST

Figure 1. 1 Front Panel (1)

Table 1. 1 Description of Control Panel Buttons (1)

No.	Name	Function Description
1	ALARM	Alarm indicator turns red when a sensor alarm is detected.
	READY	Ready indicator is normally blue, indicating that the device is functioning properly.
	STATUS	Status indicator turns blue when device is controlled by an IR remote (if the device ID# is 255, the indicator is off when the device is controlled by an IR remote).
		Indicator turns red when controlled by a keyboard and purple when IR remote and keyboard is used at the same time.
	HDD	HDD indicator blinks red when data is being read from or written to HDD.
	MODEM (Not supported by 9100/9000HFI-XT)	Reserved for future usage.
	TX/RX	TX/RX indicator blinks blue when network connection is functioning properly.
	GUARD	Guard indicator turns blue when the device is in armed status; at this time, an alarm is enabled when an event is detected.
The indicator turns off when the device is unarmed. The arm/disarm status can be changed by pressing and holding on the ESC button for more than 3 seconds in live view mode.		
2	IR Receiver	Receiver for IR remote
3	Front Panel Lock (for DS-9200/9100/9000 series)	You can lock or unlock the panel by the key.
4	DVD-R/W	Slot for DVD-R/W. (Optional for DS-9100/9000HFI-RT)
5	Alphanumeric Buttons	Switch to the corresponding channel in Live view or PTZ Control mode.
		Input numbers and characters in Edit mode.
		Switch channels in Playback mode.
		The light of the button is blue when the corresponding channel is recording; it is red when the channel is in network transmission status; it is pink when the channel is recording and transmitting.
6	USB Interfaces	Universal Serial Bus (USB) ports for additional devices such as USB mouse and USB Hard Disk Drive (HDD).
7	ESC	Back to the previous menu.
		Press for arming/disarming the device in Live View mode.
	REC/SHOT	Enter the Manual Record setting menu.
		In PTZ control settings, press the button and then you can call a PTZ preset by pressing Numeric button.
		It is also used to turn audio on/off in the Playback mode.
	PLAY/AUTO	The button is used to enter the Playback mode.
		It is also used to auto scan in the PTZ Control menu.
	ZOOM+	Zoom in the PTZ camera in the PTZ Control setting.
	A/FOCUS+	Adjust focus in the PTZ Control menu.
		It is also used to switch input methods (upper and lowercase alphabet, symbols and numeric input).
EDIT/IRIS+	Edit text fields. When editing text fields, it will also function as a Backspace button to delete the character in front of the cursor.	

		On checkbox fields, pressing the button will tick the checkbox.
		In PTZ Control mode, the button adjusts the iris of the camera.
		In Playback mode, it can be used to generate video clips for backup.
		Enter/exit the folder of USB device and eSATA HDD.
	MAIN/SPOT/ZOOM-	Switch main and spot output.
		In PTZ Control mode, it can be used to zoom out the image.
	F1/ LIGHT	Select all items on the list when used in a list field.
		In PTZ Control mode, it will turn on/off PTZ light (if applicable).
		In Playback mode, it is used to switch play and reverse play.
	F2/ AUX	Cycle through tab pages.
		In synchronous playback mode, it is used to switch channels.
	MENU/WIPER	Press the button will help you return to the Main menu (after successful login).
		Press and hold the button for 5 seconds will turn off audible key beep.
		In PTZ Control mode, the MENU/WIPER button will start wiper (if applicable).
		In Playback mode, it is used to show/hide the control toolbar.
	PREV/FOCUS-	Switch single screen and multi-screen mode.
In PTZ Control mode, it is used to adjust the focus in conjunction with the A/FOCUS+ button.		
PTZ/IRIS-	Enter the PTZ Control mode.	
	In the PTZ Control mode, it is used to adjust the iris of the PTZ camera.	
8	DIRECTION	The DIRECTION buttons are used to navigate between different fields and items in menus.
		In the Playback mode, the Up and Down button is used to speed up and slow down recorded video. The Left and Right button will select the next and previous record files.
		In Live View mode, these buttons can be used to cycle through channels.
		In PTZ control mode, it can control the movement of the PTZ camera.
	ENTER	The ENTER button is used to confirm selection in any of the menu modes.
		It can also be used to <i>tick</i> checkbox fields.
		In Playback mode, it can be used to play or pause the video.
		In single-frame Playback mode, pressing the button will advance the video by a single frame.
9	JOG SHUTTLE Control	In Auto-switch mode, it can be used to stop /start auto switch.
		Move the active selection in a menu. It will move the selection up and down.
		In Live View mode, it can be used to cycle through different channels.
		In the Playback mode: For DS-9200/9100/9000 series, the ring is used to jump 30s forward/backward in video files. For DS-8100/8000 series, the outer ring is used to speed up or slow down the record files and the inner ring is used to jump 30s forward/backward in records files.
10	POWER ON/OFF	In PTZ control mode, it can control the movement of the PTZ camera.
		Power on/off switch.



If GUARD indicator is blue (default), all the alarm event and exception settings are valid. Otherwise, alarm event and exception settings are invalid, but normal recording is still available.



It is important to note that you must press the EDIT button on either the remote or front panel on a text field before you're able to edit its content. After you're done entering text, you must hit the ENTER button to be able to move on to the next field.

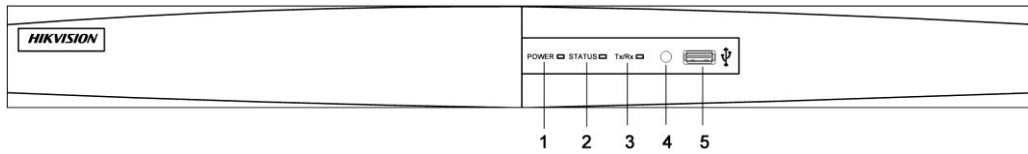

DS-7200HWI-SV

Figure 1. 2 Front Panel (2)

Table 1. 2 Description of Control Panel Buttons (2)

No.	Name	Function Description
1	POWER	POWER indicator turns green when DVR is powered up.
2	STATUS	STATUS indicator lights in red when data is being read from or written to HDD.
3	Tx/Rx	Tx/Rx indicator blinks green when network connection is functioning properly.
4	IR Receiver	Receiver for IR remote.
5	USB Interface	Connects USB mouse or USB flash memory devices.

1.2 IR Remote Control Operations

The device may also be controlled with the included IR remote control, shown in Figure 1.3.



Batteries (2×AAA) must be installed before operation.

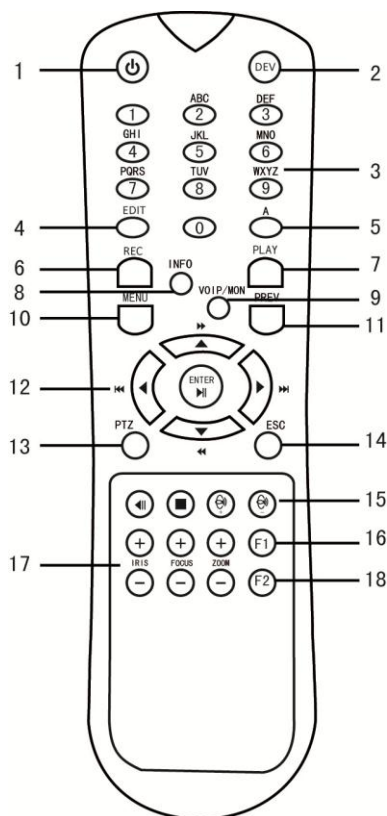

Figure 1.3 Remote Control

The keys on the remote control closely resemble the ones on the front panel. See Table 1.3.

Table 1.3 Description of the IR Remote Control Buttons

No.	Name	Description
1	POWER	Power on/off the device.
2	DEV	Enables/Disables Remote Control.
3	Alphanumeric Buttons:	Switch to the corresponding channel in Live view or PTZ Control mode.
		Input numbers and characters in Edit mode.
		Switch channels in Playback mode.
4	EDIT Button	Edit text fields. When editing text fields, it will also function as a Backspace button to delete the character in front of the cursor.
		On checkbox fields, pressing the button will tick the checkbox.
		In PTZ Control mode, the button adjusts the iris of the camera.
		In Playback mode, it can be used to generate video clips for backup.
		Enter/exit the folder of USB device and eSATA HDD.

5	A Button	Adjust focus in the PTZ Control menu. It is also used to switch input methods (upper and lowercase alphabet, symbols and numeric input).
6	REC Button	Enter the Manual Record setting menu. In PTZ control settings, press the button and then you can call a PTZ preset by pressing Numeric button. It is also used to turn audio on/off in the Playback mode.
7	PLAY Button	The button is used to enter the Playback mode. It is also used to auto scan in the PTZ Control menu.
8	INFO Button	Reserved for future usage.
9	VOIP/MON Button	Switch main and spot output. In PTZ Control mode, it can be used to zoom out the image.
10	MENU Button	Press the button will help you return to the Main menu (after successful login). Press and hold the button for 5 seconds will turn off audible key beep. In PTZ Control mode, the MENU/WIPER button will start wiper (if applicable). In Playback mode, it is used to show/hide the control toolbar.
11	PREV Button	Switch single screen and multi-screen mode. In PTZ Control mode, it is used to adjust the focus in conjunction with the A/FOCUS+ button.
12	DIRECTION/ENTER Buttons	The DIRECTION buttons are used to navigate between different fields and items in menus. In the Playback mode, the Up and Down button is used to speed up and slow down recorded video. The Left and Right button will select the next and previous record files. In Live View mode, these buttons can be used to cycle through channels. In PTZ control mode, it can control the movement of the PTZ camera. The ENTER button is used to confirm selection in any of the menu modes. It can also be used to <i>tick</i> checkbox fields. In Playback mode, it can be used to play or pause the video. In single-frame Playback mode, pressing the button will advance the video by a single frame. In Auto-switch mode, it can be used to stop /start auto switch.
13	PTZ Button	Enter the PTZ Control mode. In the PTZ Control mode, it is used to adjust the iris of the PTZ camera.
14	ESC Button	Back to the previous menu. Press for arming/disarming the device in Live View mode.
15	RESERVED	Reserved for future usage.
16	F1 Button	Select all items on the list when used in a list field. In PTZ Control mode, it will turn on/off PTZ light (if applicable). In Playback mode, it is used to switch play and reverse play.
17	PTZ Control Buttons	Buttons to adjust the iris, focus and zoom of a PTZ camera.
18	F2 Button	Cycle through tab pages. In synchronous playback mode, it is used to switch channels.

Remote Control Troubleshooting:



Make sure you have installed batteries properly in the remote control. And you have to aim the remote control at the IR receiver in the front panel.

If there is no response after you press any button on the remote, follow the procedure below to troubleshoot.

Steps:

1. Go to Menu > Settings > General > More Settings by operating the front control panel or the mouse.
2. Check and remember device ID#. The default ID# is 255. This ID# is valid for all the IR remote controls.
3. Press the DEV button on the remote control.
4. Enter the device ID# in step 2.
5. Press the ENTER button on the remote.

If the Status indicator on the front panel turns blue, the remote control is operating properly. If the Status indicator does not turn blue and there is still no response from the remote, please check the following:



When the device ID# is 255, the Status indicator is off when device is controlled by an IR remote control.

1. Batteries are installed correctly and the polarities of the batteries are not reversed.
2. Batteries are fresh and not out of charge.
3. IR receiver is not obstructed.

If the remote still can't function properly, please change a remote and try again, or contact the device provider.

1.3 USB Mouse Operation

A regular 3-button (Left/Right/Scroll-wheel) USB mouse can also be used with this device. To use a USB mouse:

1. Plug USB mouse into one of the USB interfaces on the front panel of the device.
2. The mouse should automatically be detected. If in a rare case that the mouse is not detected, the possible reason may be that the two devices are not compatible, please refer to the recommended device list from your provider.

The operation of the mouse:

Table 1. 4 Description of the Mouse Control

Name	Action	Description
Left-Click	Single-Click	Live view: Select channel and show the quick set menu. Menu: Select and enter.
	Double-Click	Live view: Switch single-screen and multi-screen.
	Click and Drag	PTZ control: pan, tilt and zoom. Tamper-proof, privacy mask and motion detection: Select target area. Digital zoom-in: Drag and select target area. Live view: Drag channel/time bar.
Right-Click	Single-Click	Live view: Show menu. Menu: Exit current menu to upper level menu.
Scroll-Wheel	Scrolling up	Live view: Previous screen. Right-click Menu: Previous item.
	Scrolling down	Live view: Next screen. Right-click Menu: Next item.

1.4 Input Method Description



Figure 1.4 Soft Keyboard (1)



Figure 1.5 Soft Keyboard (2)

Description of the buttons on the soft keyboard:

Table 1.5 Description of the Soft Keyboard Icons

Icon	Description	Icon	Description
	Number		English letter
	Lowercase/Uppercase		Backspace
	Switch the keyboard		Space
	Positioning the cursor		Exit
	Symbols		Reserved

1.5 Rear Panel

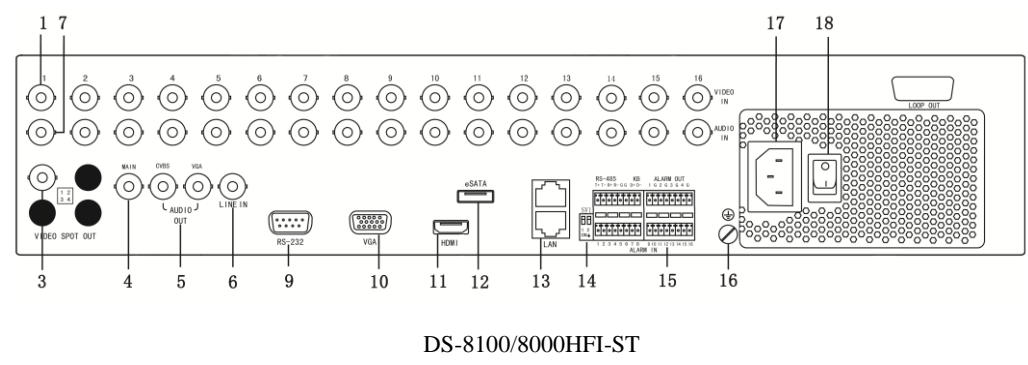
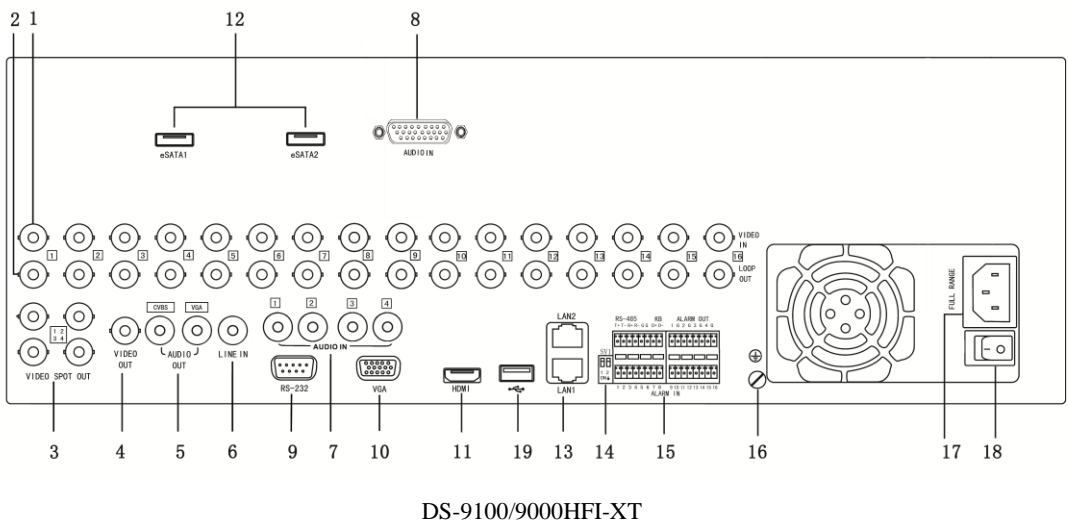
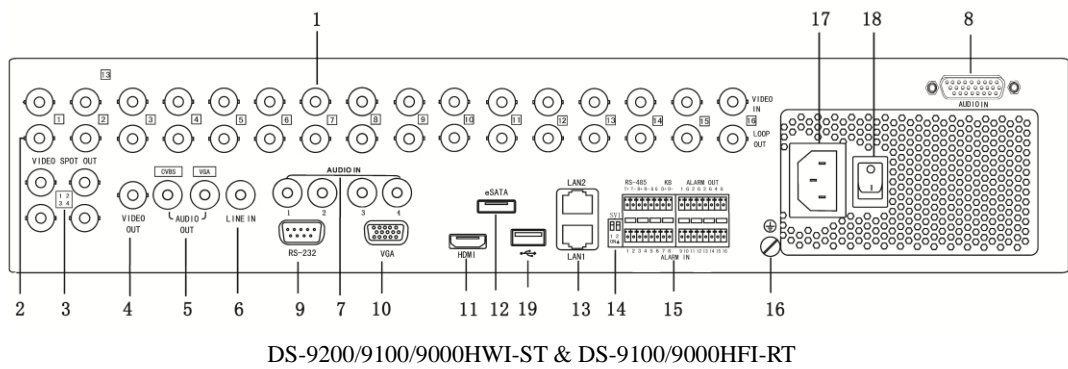
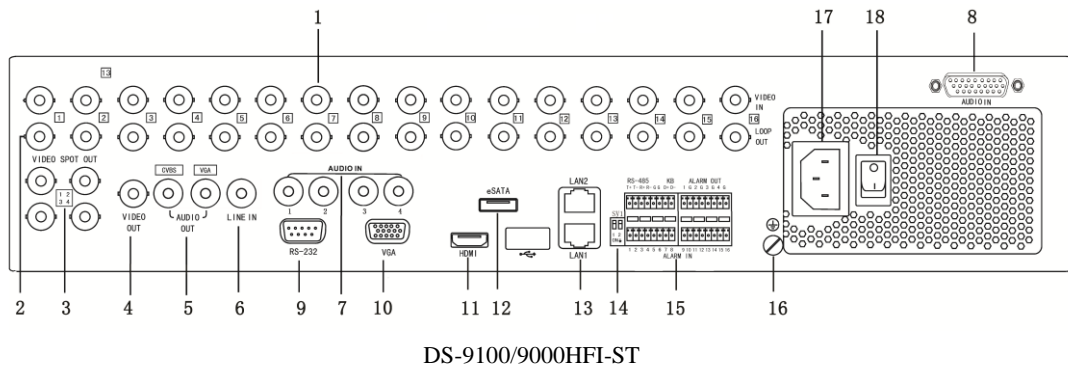

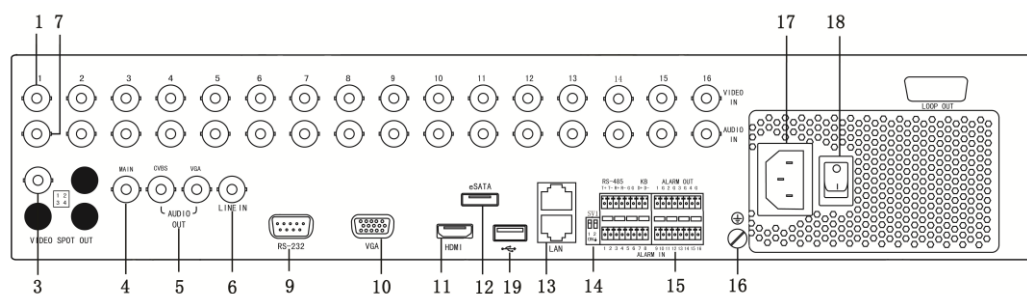

DS-8100/8000HWI-ST

Figure 1. 6 Rear Panel (1)

Table 1. 6 Description of Rear Panel (1)

No.	Item	Description
1	VIDEO IN	BNC connector for analog video input.
2	LOOP OUT (for DS-9100/9000HFI-ST/RT/XT & 9200/9100/9000HWI-ST series)	BNC connector for video loop output.
3	VIDEO SPOT OUT	BNC connector for video output.
4	VIDEO OUT	BNC connector for video output.
5	AUDIO OUT	RCA (for DS-9200/9100/9000 series) / BNC (for DS-8100/8000 series) connector for audio output. This connector is synchronized with VIDEO OUT.
6	LINE IN	RCA (for DS-9200/9100/9000 series) / BNC (for DS-8100/8000 series) connector for two-way audio.
7	AUDIO IN	RCA (for DS-9200/9100/9000 series) / BNC (for DS-8100/8000 series) connector for audio input.
8	AUDIO IN (for DS-9100/9000HFI-ST/RT/XT & 9200/9100/9000HWI-ST series)	DB26 connector for audio input.
9	RS-232 Interface	Connector for RS-232 devices.
10	VGA	DB9 connector for VGA output. Display local video output and menu.
11	HDMI	HDMI video output connector.
12	eSATA	Connects external SATA HDD, DVD-R/W.
13	LAN Interface	Network interface.
14	Termination Switch	RS-485 termination switch. Up position is not terminated. Down position is terminated with 120Ω resistance.
15	RS-485 Interface	Connector for RS-485 devices. T+ and T- pin connects to R+ and R- pin of PTZ receiver respectively.
	Controller Port	D+, D- pin connects to Ta, Tb pin of controller. For cascading devices, the first DVR's D+, D- pin should be connected with the D+, D- pin of the next DVR.

	ALARM IN	Connector for alarm input.
	ALARM OUT	Connector for alarm output.
16	GND	Ground (needs to be connected when DVR starts up).
17	AC 100V ~ 240V	AC 100V ~ 240V power supply.
18	POWER	Switch for turning on/off the device.
19	USB	Universal Serial Bus (USB) ports for additional devices such as USB Hard Disk Drive (HDD).

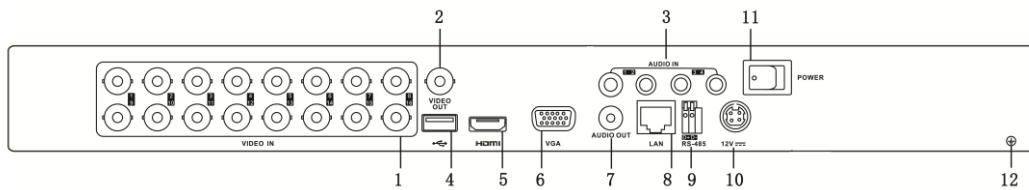

DS-7200HWI-SV

Figure 1. 7 Rear Panel (2)

Table 1. 7 Description of Rear Panel (2)

No.	Item	Description
1	VIDEO IN	BNC connector for analog video input.
2	VIDEO OUT	BNC connector for video output.
3	AUDIO IN	RCA connector for audio input.
4	USB Interface	Connects USB mouse or USB flash memory devices.
5	HDMI	HDMI video output.
6	VGA	DB15 connector for VGA output. Display local video output and menu.
7	AUDIO OUT	RCA connector for audio output.
8	LAN Interface	Network interface.
9	RS-485 Interface	Connector for RS-485 devices. Connect the D+ and D- terminals to R+ and R- of PTZ receiver respectively.
10	12V	12 VDC power supply.
11	POWER	Switch for turning on/off the device.
12	GND	Ground (needs to be connected when DVR starts up).

1.6 Starting Up and Shutting Down the Device

Purpose:

Proper startup and shutdown procedures are crucial to expanding the life of the device.

Before you start:

Check that the voltage of the extra power supply is the same with the device's requirement, and the ground connection is working properly.

Starting up the device:

Steps (for 7200 series):

1. Check the power supply is plugged into an electrical outlet. It is **HIGHLY** recommended that an Uninterruptible Power Supply (UPS) be used in conjunction with the device.
2. Press the **POWER** button on the rear panel. The Power indicator LED should turn green indicating that the device begins to start up.
3. After startup, the Power indicator LED is solid green. A splash screen with the status of the HDD appears on the monitor. The row of icons at the bottom of the screen shows the HDD status. 'X' means that the HDD is not installed or cannot be detected.

Steps (for other series):

1. Check the power supply is plugged into an electrical outlet. It is **HIGHLY** recommended that an Uninterruptible Power Supply (UPS) be used in conjunction with the device.
2. Turn on the Power Switch on the rear panel and press the **POWER** button on the front panel. The Power indicator LED should turn blue indicating that the device begins to start up.
3. After startup, the Power indicator LED is solid blue. A splash screen with the status of the HDD appears on the monitor. The row of icons at the bottom of the screen shows the HDD status. 'X' means that the HDD is not installed or cannot be detected.

Shutting down the device:

Steps:

There are two proper ways to shut down the device.

• **Task 1: Standard shutdown**

1. Enter the Shutdown menu.
Menu > Shutdown

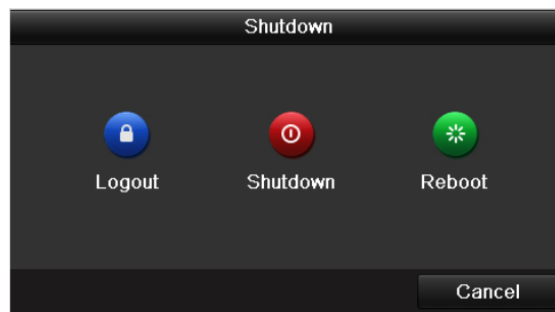

Figure 1. 8 Shutdown Menu

2. Click the **Shutdown** button.
3. Click the **Yes** button.

• **Take 2: By operating the front panel (not available for 7200 series)**

1. Press and hold the POWER button on the front panel for 3 seconds.
2. Enter the administrator's username and password in the dialog box for authentication.
3. Click the **Yes** button.



- Do not press the POWER button again when the system is shutting down.
- If you disable the ID Authentication in General Settings interface (Chapter 14.2), the dialog box for authentication does not pop up.

Rebooting the device

In the Shutdown menu (Figure 1.7), you can also reboot the device.

Steps:

1. Enter the **Shutdown** menu by clicking Menu > Shutdown.
2. Click the **Logout** button to logout the device or the **Reboot** button to reboot the device.

Chapter 2 Getting Started

2.1 Using the Wizard for Basic Configuration

By default, the Setup Wizard starts once the device has loaded.

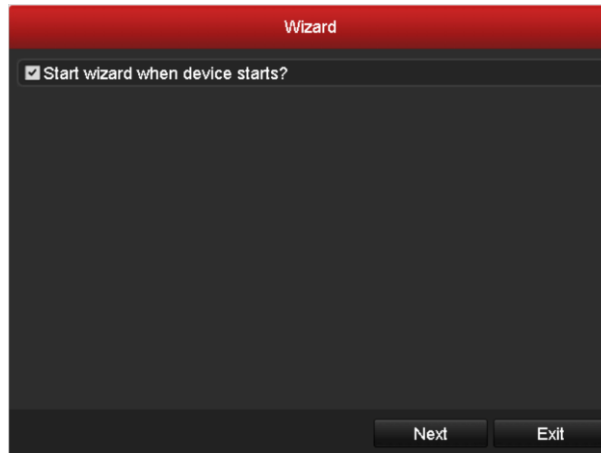

Figure 2. 1 Start Wizard Interface

Operating the Setup Wizard:

1. The Start Wizard can walk you through some important settings of the device. If you don't want to use the Start Wizard at that moment, click **Exit**. You can also choose to use the Start Wizard next time by leaving the "Start wizard when device starts?" checkbox checked.
2. Click **Next** on the Wizard window to enter the **Login** window.



Figure 2. 2 Login Window

3. Enter the admin password. By default, the password is 12345.
4. Optionally, to change the admin password, check the **New Admin Password** checkbox. Enter the new password and confirm the password in the given fields.
5. Click **Next** to enter the date and time settings window.

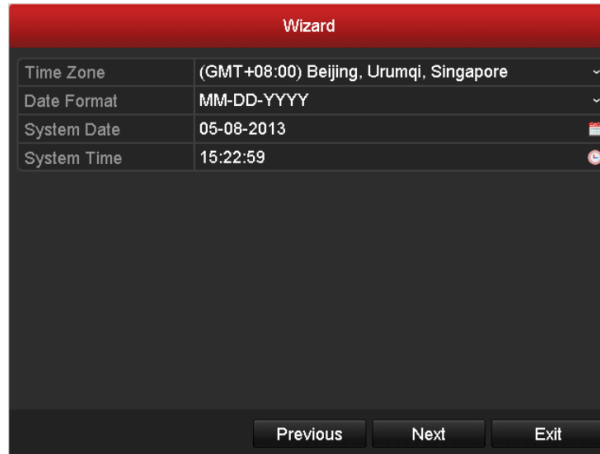
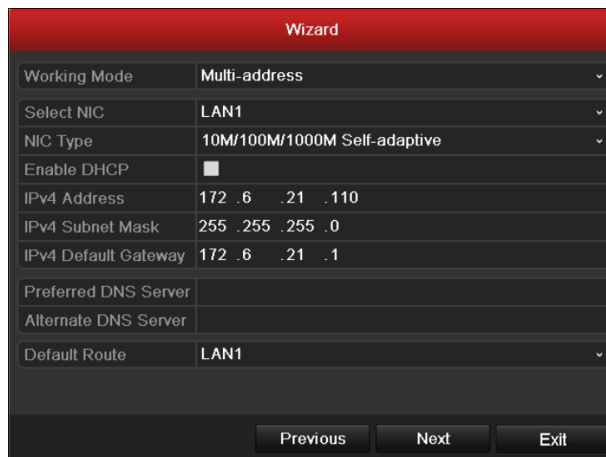

Figure 2. 3 Date and Time Settings

- After the time settings, click **Next** which takes you to the Network Start Wizard window.



Dual NIC is not supported by DS-7200HWI-SV series.



DS-9100/9000HFI-ST/RT/XT & DS-9200/9100/9000HWI-ST & DS-8100/8000HFI (HWI)-ST



DS-7200HWI-ST

Figure 2. 4 Network Configuration

- Click **Next** after you configured the network parameters, which takes you to the Array Management

window (supported by DS-9100/9000HFI-RT series only).

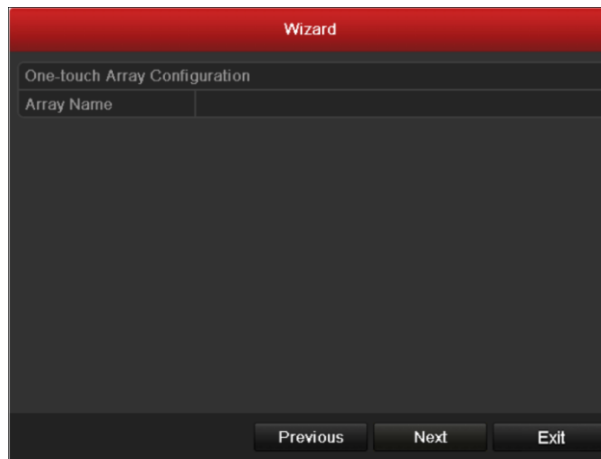

Figure 2. 5 Array Management

8. After configuring array settings, click **Next** to enter the **HDD Management** window.

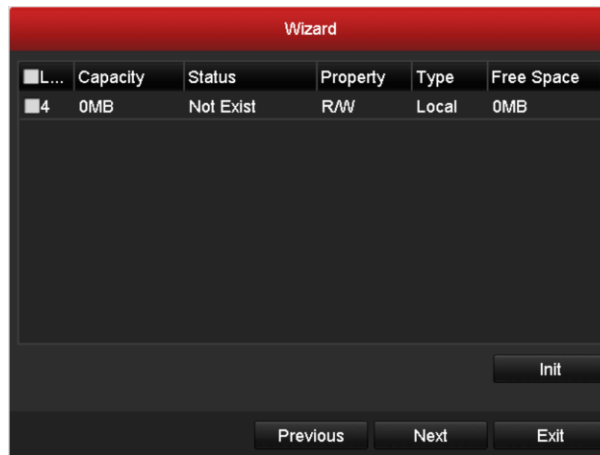

Figure 2. 6 HDD Management

9. To initialize the HDD, click **Init**. Initialization removes all the data saved in the HDD.

10. Click **Next** to enter the **IP Camera Management** window (only supported by HDVR series).

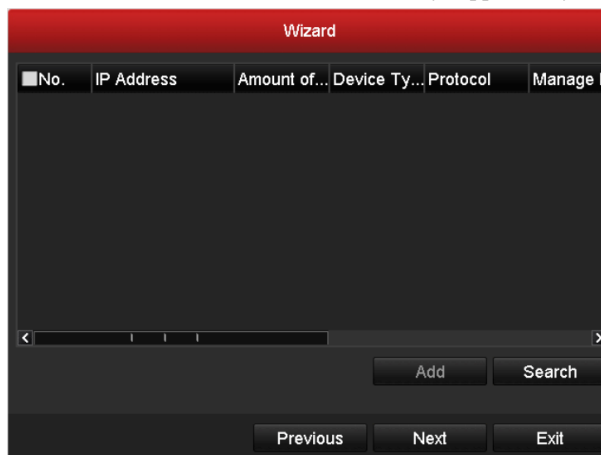



Figure 2. 7 IP Camera Management

11. Click **Search** to search IP Camera. Click **Add** to add IP Camera (only supported by HDVR series).

12. After finishing IP Camera settings, click **Next** to enter the **Record Settings** window.

Click the icon , and you can enable the continuous recording or motion Detection recording for all channels of the device.

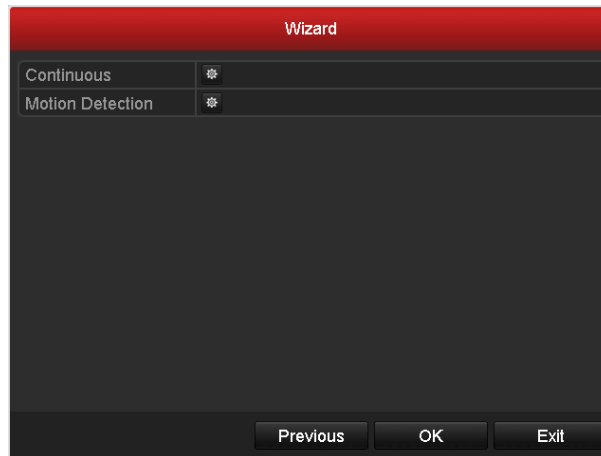

Figure 2. 8 Record Settings

-
13. Click **OK** to complete the wizard settings.

2.2 Adding and Connecting the IP Cameras



This Chapter is available for HDVR series only.

2.2.1 Adding the IP Cameras

Purpose:

HDVR can connect the network cameras and record the video got from them. So before you can get a live view or record of the video, you should add the network cameras to the connection list of the device.

Before you start:

Ensure the network connection is valid and correct. For detailed checking and configuring of the network, please see *Chapter 9.1 Configuring General Settings*, *Chapter 9.3 Checking Network Traffic* and *Chapter 9.4 Network Detection*.

Steps:

1. Enter the Camera Management interface.

Menu > Camera > Camera

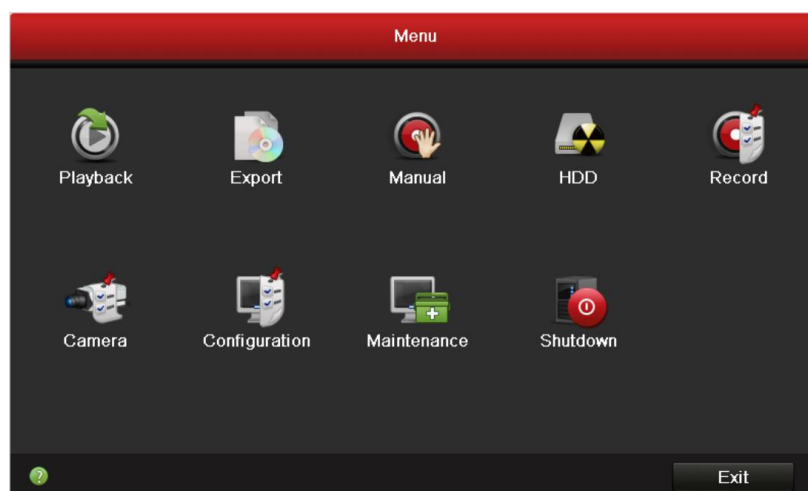

Figure 2. 9 Main Menu



In Analog Camera Management interface, the status of analog cameras is displayed. Clear the checkboxes, and you can disable the corresponding analog cameras. One more network camera can be added by disabling one analog camera. 16 /8 /4 network cameras can be added to DS-9016&8016 HFI-ST&9016HFI-RT&9016HFI-XT&9016HWI-ST/9008&8008HFI-ST&9008HFI-RT&9008HWI-ST/9004&8004HFI-ST&DS-9004HFI-RT&9004HWI-ST series at most when all the analog cameras are enabled. 32 /16 /8 network cameras can be added to DS-9016&8016 HFI-ST&9016HFI-RT&9016HFI-XT&9016HWI-ST/9008&8008HFI-ST&9008HFI-RT&9008HWI-ST/9

004&8004HFI-ST&DS-9004HFI-RT&9004HWI-ST series at most when all the analog cameras are disabled.



Figure 2. 10 Analog Camera Management

2. To add the online cameras:

- 1) Select the **IP Camera** tab, and the online cameras in the same network segment with the device will be displayed on the list. You can click the button **Refresh** to refresh the information of the online cameras.

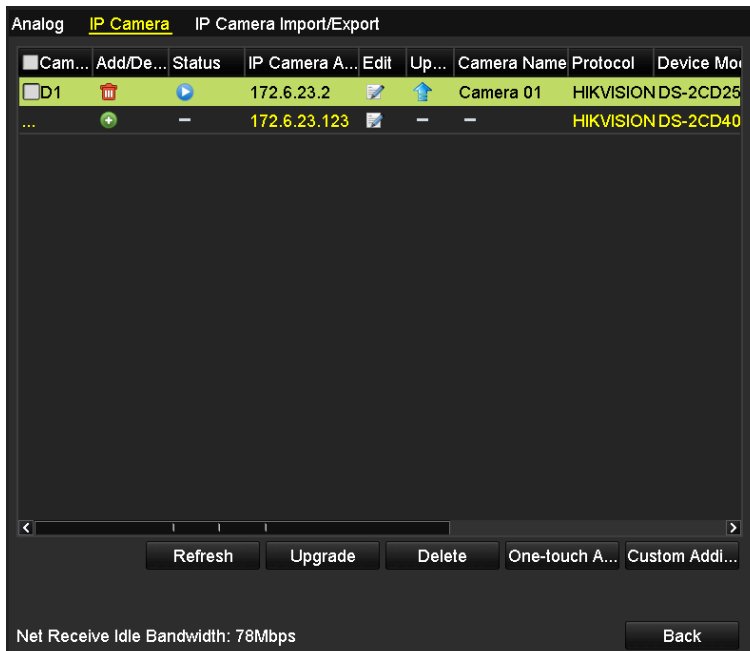



Figure 2. 11 IP Camera Management

- 2) Click the icon  on the list, and the corresponding camera will be added automatically;

Or click the button **Add All** to add all the online cameras automatically. The user name and password are *admin* and *12345* by default.

- 3) Optionally, you can click the button **Custom Adding** to enter the Custom Adding interface.

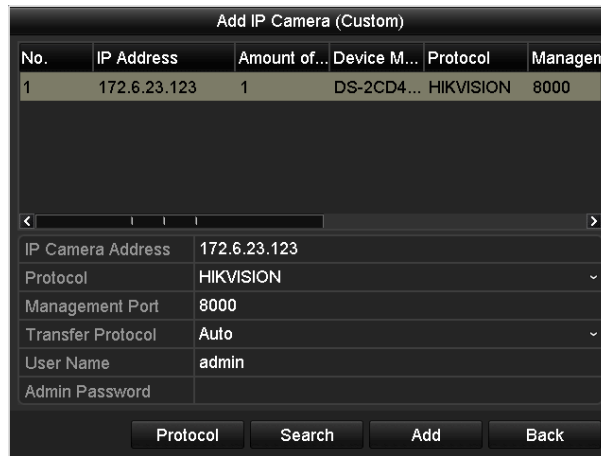

Figure 2. 12 Custom Adding

Input the required information, including the IP address, protocol, management port, user name and admin password, and then click the button **Add** to add the camera manually.



The cameras added and not added are differently color coded.

When adding encoding device with multiple channels, check the checkbox in the pop-up window to select the channels to be added and click **OK**.

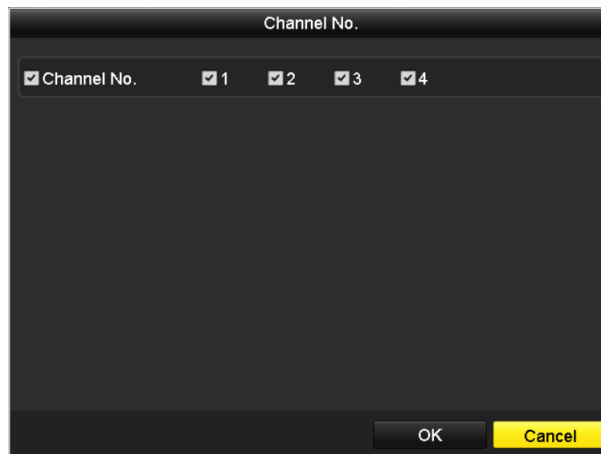

Figure 2. 13 Selecting Multiple Channels

3. Import/Export the configuration file of the IP cameras.

Import the configuration file of IP cameras to the device:

Connect the backup device on which the configuration file is stored to the device.

- 1) Click the **IP Camera Import/Export** tab.

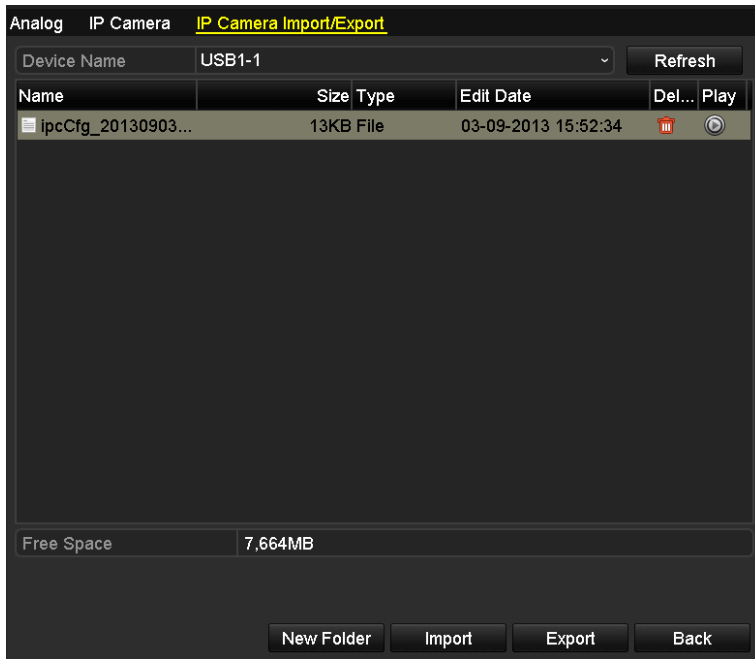

Figure 2. 14 Import IP Camera Configuration File

- 2) Select the backup device from the drop-down list and you can click the **Refresh** button to get the latest information of the backup device.
- 3) Select the configuration file of IP camera from the list.
- 4) Click the **Import** button to import the IP cameras to the device.
- 5) Click **OK** on the pop-up message box after the importing process is complete. The imported IP cameras will be displayed on the IP Camera Management interface.

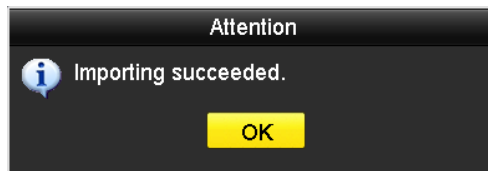

Figure 2. 15 Attention-Importing Succeeded

Export the configuration file of IP cameras to backup device:

Connect the backup device on which the configuration file is stored to the device.

- 1) Click the **IP Camera Import/Export** tab.

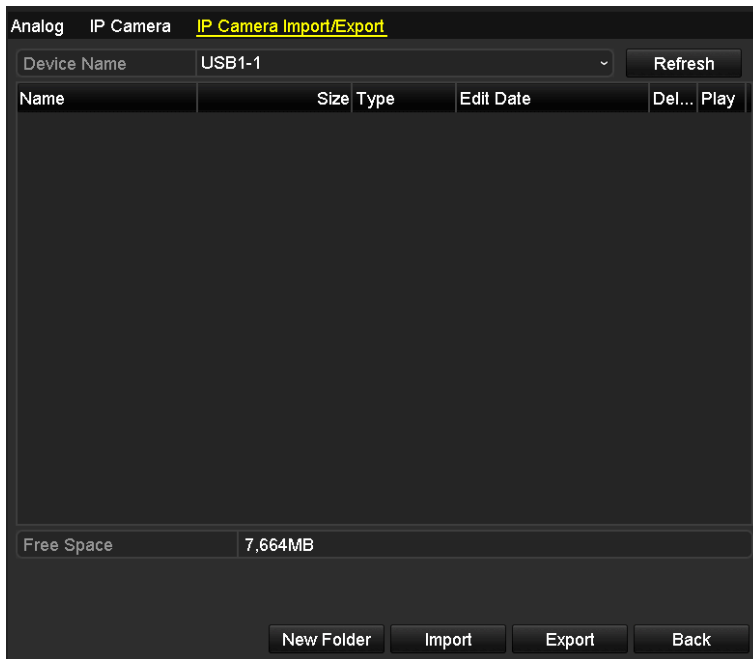

Figure 2. 16 Export IP Camera Configuration File

- 2) Select the backup device from the drop-down list and you can click the **Refresh** button to get the latest information of the backup device.
- 3) Click the **Export** button to export the configuration file of IP cameras to the backup device.
- 4) Click **OK** on the pop-up message box after the exporting process is complete. The configuration file of IP cameras will be displayed on a list.

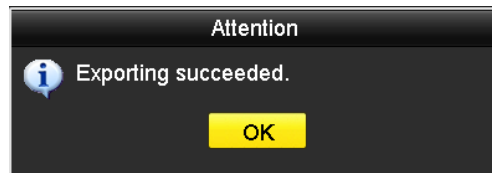

Figure 2. 17 Attention-Exporting Succeeded

2.2.2 Configuring the Connected IP Cameras

Editing the connected IP cameras

Purpose:

The detailed information of the added IP cameras will be displayed on a list, and you can configure the basic setting of the cameras if needed.

Steps:

1. Click the icon  on the camera list to enter the Edit IP Camera interface.

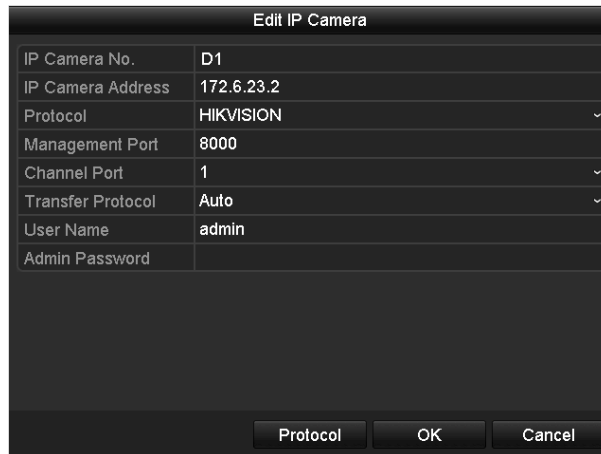







Figure 2. 18 Edit IP Camera

2. Edit the camera information, such as the IP address, protocol, port, etc.
3. Click the button **OK** to save the new settings.
4. To delete the added camera, click the icon ; Or check the corresponding checkbox and click the button **Delete**.

Description of the icons:

	Add the online IP camera automatically.
	Edit the basic parameters of the added IP camera.
	Delete the added IP camera.
	Get the live view of the added IP camera.
	Upgrade the added IP camera.

Configuring the custom protocols

Purpose:

Custom protocols can be set for the network cameras which are not configured with the standard protocols.

Steps:

1. Click the button **Protocol** on the Custom Adding interface to open the Protocol Management page.

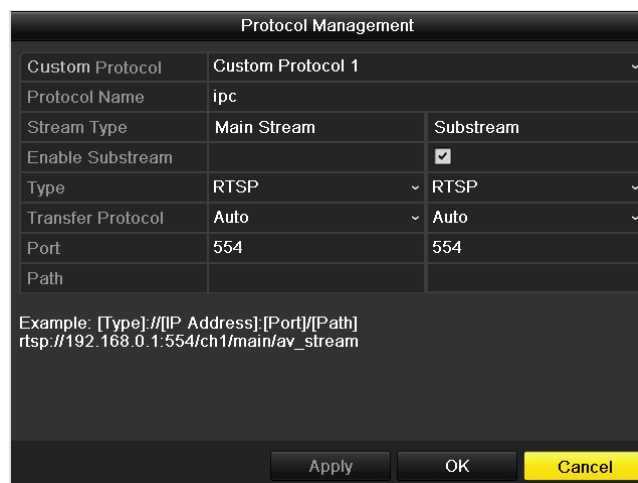

Figure 2. 19 Protocol Management Interface

2. There are 16 custom protocols provided in the system. Select a custom protocol from the drop-down list, and configure its corresponding parameters.



Before customizing the protocol for the network camera, you have to contact the manufacturer of the network camera to consult the URL (uniform resource locator) for getting main stream and sub-stream.

The format of the URL is: [Type]://[IP Address of the network camera]:[Port]/[Path].

Example: rtsp://192.168.1.55:554/ch1/main/av_stream.

- **Protocol Name:** Edit the name for the custom protocol.
 - **Enable Sub-stream:** If the network camera does not support sub-stream or the sub-stream is not needed, leave the checkbox empty.
 - **Type:** The network camera adopting custom protocol must support getting stream through standard RTSP.
 - **Transfer Protocol:** Select the transfer protocol for the custom protocol.
 - **Port:** Set the port No. for the custom protocol.
 - **Path:** Set the resource path for the custom protocol. E.g., ch1/main/av_stream.
3. Click **Apply** to save the settings and click **OK** exit.
After added successfully, the custom protocol will be displayed in the drop-down list of protocol on the Custom Adding interface.

Chapter 3 Live View





3.1 Introduction of Live View

Live view shows you the video image getting from each camera in real time. The device automatically enters Live View mode when powered on. It is also at the very top of the menu hierarchy, thus right-clicking the mouse repeatedly (depending on which menu you're on) brings you to the Live View mode.

Live View Icons

In the live view mode, there are icons in the upper-right corner of the live view window, or in the lower-left corner of the screen for each channel, showing the status of the record and alarm in the channel, so that you can know whether the channel is recorded, or whether there are alarms occur as soon as possible.

Table 3.1 Description of Live View Icons

Icons	Description
	Alarm (video loss, tampering, motion detection or sensor alarm)
	Record (manual recording, continuous recording, motion detection or sensor alarm triggered recording)
	Alarm & Record
	Event/Exception (motion detection, sensor alarm or exception information. For details, see <i>Chapter 8.5 Handling Exceptions.</i>)



Sensor alarm is not supported by DS-7200HWI-SV series.

3.2 Operations in Live View Mode

In live view mode, there are many functions provided. Some of the functions are listed below.

- **Single Screen:** showing only one screen on the monitor.
- **Multi-screen:** showing multiple screens on the monitor simultaneously.
- **Auto-switch:** the screen is auto switched to the next one. And you must set the dwell time for each screen on the configuration menu before enabling the auto-switch.

Menu>Configuration>Live View>Dwell Time.

- **Start Recording:** start all-day normal recording or motion detection recording for all channels.
- **Add IP Camera:** the shortcut to the IP camera management interface (only supported by HDVR series)
- **Playback:** play back the recorded videos for current day.
- **Output Mode:** select the output mode to Standard, Bright, Gentle or Vivid.
- **Aux Monitor:** the device checks the connection of the output interfaces to define the main and auxiliary output interfaces. See the table below for the priority level of the main and aux outputs.

Table 3. 2 Priorities of Outputs for DS-9200/9100/9000/8100/8000HWI-ST & DS-7200 Series

	HDMI/VGA	CVBS	Main output	Auxiliary output
1	√	√	HDMI/VGA	CVBS
2	√	×	HDMI/VGA	
3	×	√	CVBS	

Table 3. 3 Priorities of Outputs for Other Models

	HDMI	VGA	CVBS	Main output	Auxiliary output
1	√	√	√	HDMI	VGA
2	√	×	√	HDMI	CVBS
3	×	√	√	VGA	CVBS
4	×	×	√	CVBS	

√ means the interface is in use, × means the interface is out of use or the connection is invalid. And the HDMI, VGA and CVBS can be used at the same time.

When the aux output is enabled, you can do some basic operation in the live view mode for the Aux output, while no operation is allowed for the main output.

3.2.1 Front Panel Operation



Front panel operation is not supported by 7200HWI-SV series.

Table 3. 4 Front Panel Operation in Live View

Functions	Front Panel Operation
Show single screen	Press the corresponding Alphanumeric button. E.g. Press 2 to display only the screen

	for channel 2.
Show multi-screen	Press the PREV/FOCUS- button.
Manually switch screens	Next screen: right direction button. Previous screen: left direction button.
Auto-switch	Press Enter button.
Playback	Press Play button.
Switch main and aux output	Press Main/Aux button and Enter button.

3.2.2 Using the Mouse in Live View

Table 3.5 Mouse Operation in Live View

Name	Description
Menu	Enter the main menu of the system by right clicking the mouse.
Single Screen	Switch to the single full screen by choosing channel number from the drop-down list.
Multi-screen	Adjust the screen layout by choosing from the drop-down list.
Previous Screen	Switch to the previous screen.
Next Screen	Switch to the next screen.
Start/Stop Auto-switch	Enable/disable the auto-switch of the screens.
Start Recording	Start all-day normal recording or motion detection recording for all channels.
Playback	Play back the video of the selected channel.
Output Mode	Set the video output mode to Standard, Bright, Gentle or Vivid.
Aux Monitor	Switch to the auxiliary output mode.



- The *dwell time* of the live view configuration must be set before using **Start Auto-switch**. Refer to *Chapter 3.3* for dwell time settings.
- If you enter Aux monitor mode and the Aux monitor is not connected, the mouse operation is disabled; you need to switch back to the Main output with the **MAIN/AUX** button and **Enter** button on the front panel or remote.

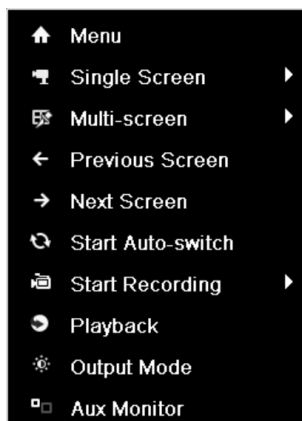

Figure 3. 1 Right-click Menu-DVR Series

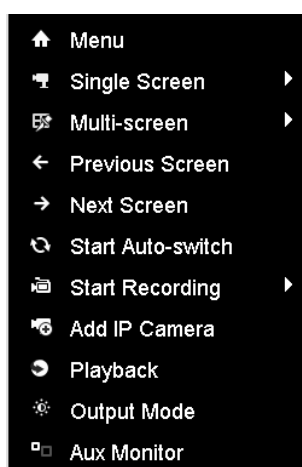

Figure 3. 2 Right-click Menu-HDVR Series

3.2.3 Using an Auxiliary Monitor

Certain features of the Live View are also available while in an Aux monitor. These features include:

- **Single Screen:** Switch to a full screen display of the selected camera. Camera can be selected from a drop-down list.
- **Multi-screen:** Switch different display layout options. Layout options can be selected from a drop-down list.
- **Next Screen:** When displaying less than the maximum number of cameras in Live View, clicking this feature will switch to the next set of displays.
- **Playback:** Enter into Playback mode.
- **Output Mode:** Set the video output mode to Standard, Bright, Gentle or Vivid.
- **Main Monitor:** Enter Main operation mode.





In the live view mode of the main output monitor, the menu operation is not available when Aux output mode is enabled.

3.2.4 Quick Setting Toolbar in Live View Mode

Click on the live view window, a quick setting toolbar will be shown on the bottom as follows:



The Live View Strategy icon  and Information icon  are only available for network cameras.

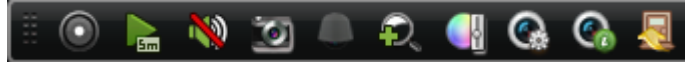











Figure 3.3 Quick Setting Toolbar

Table 3.6 Description of Quick Setting Toolbar Icons

Icons	Description	Icons	Description	Icons	Description
	Enable/Disable Record		Instant Playback		Mute/Audio on
	Capture		PTZ Control		Digital Zoom
	Image Settings		Live View Strategy		Information
	Close				

 Instant Playback only shows the record in last five minutes. If no record is found, it means there is no record file during the last five minutes.



 Digital Zoom function makes the camera zoom in on selected area, thus to get a close view of the picture. You can click-and-drag the mouse to select the area for zooming in.



Figure 3.4 Digital Zoom

 Image Settings icon can be selected to enter the Image Settings menu.

For Analog Cameras:

Four modes are selectable according to the real situation:

- **Standard:** for general lighting conditions (default).
- **Indoor:** the image is relatively smoother.

- **Dim Light:** the image is smoother than the other two modes.
- **Outdoor:** the image is relatively clearer and sharper. The degree of contrast and saturation is high.

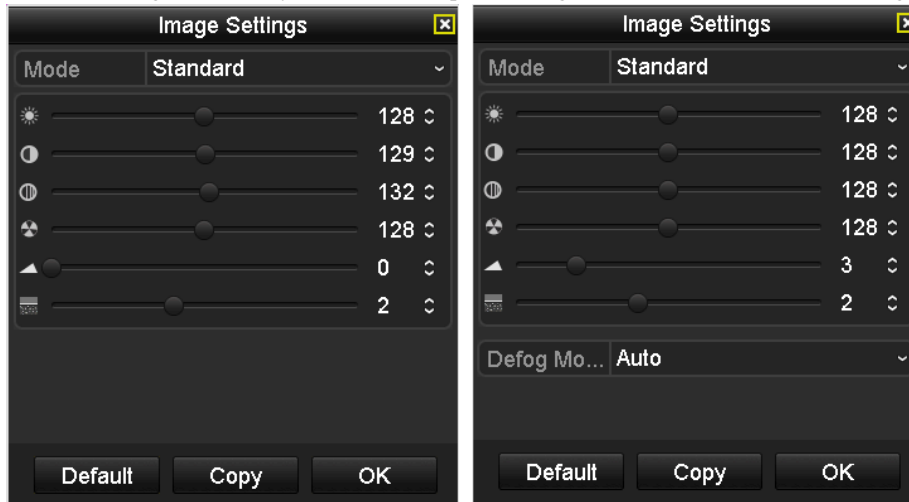

Figure 3. 5 Image Settings for Analog Camera

You can adjust the image parameters, including brightness, contrast, saturation, hue, sharpness and denoising. You can also click **Default** to restore the default settings and click **Copy** to copy the image settings to other analog channels.



For analog cameras connected to DS-9200 HWI-ST series device, the defog mode is available. The defog function is useful in foggy environment and 3 types of defog modes are selectable: Auto (default), Manual and Disable. A correct and natural image will be provided with the defog function enabled.



Figure 3. 6 A Comparison of the Details Before and After Defogging

For Network Cameras:

You can customize the brightness, contrast, saturation and hue of network cameras.

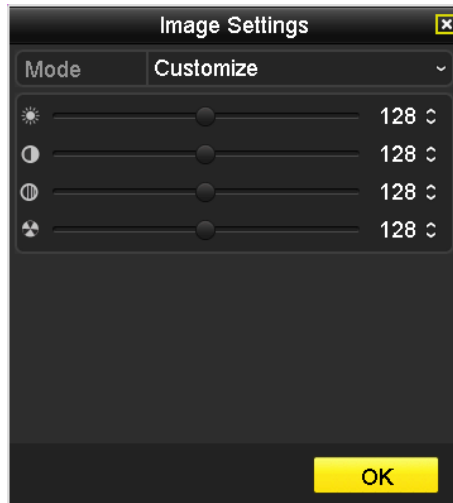



Figure 3. 7 Image Settings- Customize for Network Camera

 Live View Strategy icon can be selected to enter the Live View Strategy menu. You can set the live view performance to real-time, balanced or fluency.



This feature is only available for network cameras.

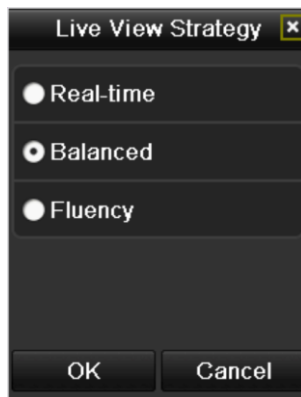

Figure 3. 8 Live View Strategy

 Information icon can be selected to show the real-time status of the network camera, including the frame rate, bitrate and resolution.



Figure 3. 9 Information

3.3 Adjusting Live View Settings

Purpose:

Live View settings can be customized to meet different needs. You can configure the output interface, number of display window, dwell time for screen display, audio output settings, etc.



We use the interface of DS-9100HFI-ST series (unless otherwise stated) as the example to describe the following settings.

Steps:

1. Enter the Live View Settings interface.

Menu> Configuration> Live View

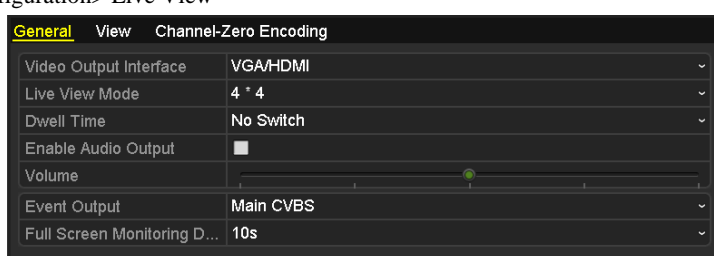

Figure 3. 10 Live View-General

The settings available in this menu include:

- **Video Output Interface:** Designates the output to configure the settings for. The interfaces include HDMI (depends on the model), VGA, Main CVBS and Spot Output.
- **Live View Mode:** Designates the display mode to be used for Live View.
- **Dwell Time:** The time in seconds to dwell between switching of channels when enabling auto-switch in Live View.
- **Enable Audio Output:** Enables/disables audio output for the selected video output.
- **Volume:** Adjust the volume of live view, playback and two-way audio for the selected output interface.
- **Event Output:** Designates the output to show event video.
- **Full Screen Monitoring Dwell Time:** The time in seconds to show alarm event screen.

2. Setting Camera Order

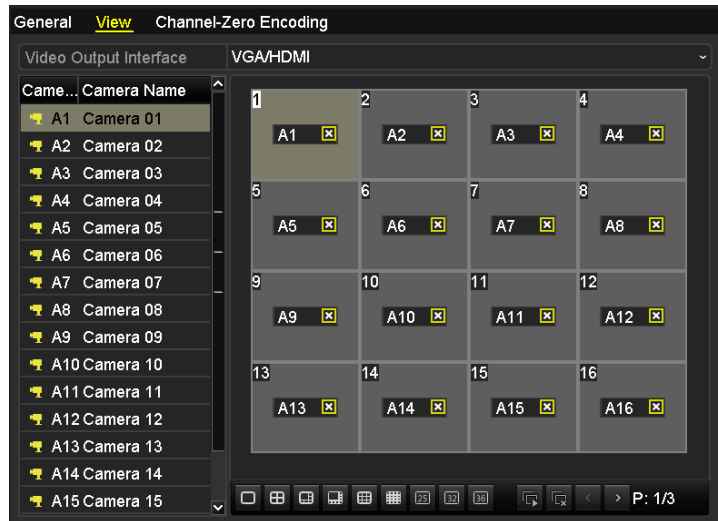







Figure 3. 11 Live View- Camera Order

To set the camera order:

- 1) Click the **View** tab.
- 2) Select a **Video Output Interface** and select a screen layout .
- 3) Select the small window, and double-click on the channel number to display the channel on the window.



 means the channel will not be displayed.

You can also click  to start live view of all channels in order and click  to stop live view of all channels. Click  or  to go to the previous or next page.

- 4) Click **Apply** to save the setting.

You can also click-and-drag the camera to the desired window on the live view interface to set the camera order.

3.4 Channel-zero Encoding

Purpose:

Sometimes you need to get a remote view of many channels in real time from web browser or CMS (Client Management System) software, in order to decrease the bandwidth requirement without affecting the image quality, channel-zero encoding is provided as an option for you.

Steps:

1. Enter the Live View Settings interface.

Menu> Configuration> Live View

2. Click the **Channel-Zero Encoding** tab.

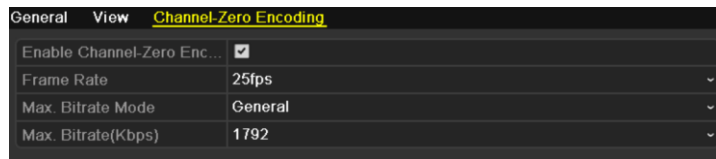

Figure 3. 12 Live View- Channel-Zero Encoding

3. Check checkbox to enable channel-zero encoding.
4. Configure the Frame Rate, Max. Bitrate Mode and Max. Bitrate.

After you set the channel-zero encoding, you can get a view in the remote client or web browser of all the channels in one screen.

3.5 Manual Video Quality Diagnostics

Purpose:

The video quality of the analog channels can be diagnosed manually and you can view the diagnostic results from a list.

Steps:

1. Enter the Manual Video Quality Diagnostics interface.
Menu> Manual >Manual Video Quality Diagnostics



Figure 3. 13 Video Quality Diagnostics

2. Check the checkboxes to select the channels for diagnostics.
3. Click the button **Diagnose**, and the results will be displayed on a list. You can view the video status and diagnostics time of the selected channels.

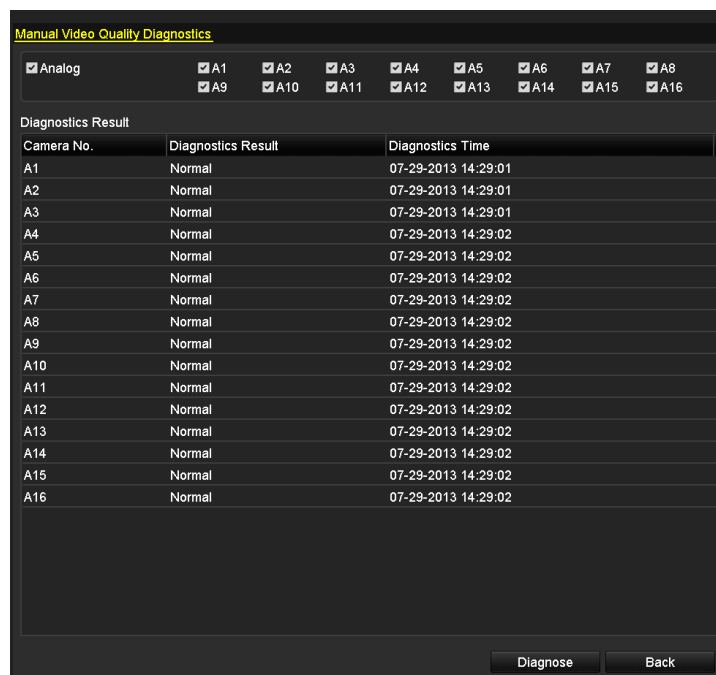

Figure 3. 14 Diagnostics Result



- Connect the analog signal to the device for the video quality diagnostics.
- Three exception types can be diagnosed: Blurred Image, Abnormal Brightness and Color Cast.

3.6 User Logout

Purpose:

After logging out, the monitor turns to the live view mode and if you want to do some operation, you need to enter user name and password to log in again.

Steps:

1. Enter the Shutdown menu.

Menu > Shutdown

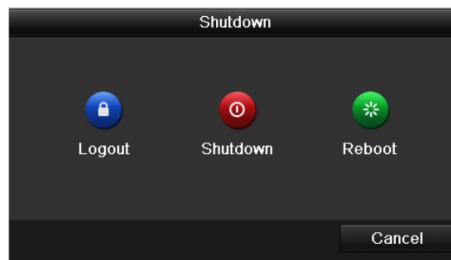

Figure 3. 15 Shutdown

2. Click **Logout**.



After you have logged out the system, menu operation on the screen is invalid. It is required a user name and password to login the system.

Chapter 4 PTZ Control

4.1 Configuring PTZ Settings

Purpose:

Follow the procedure to set the parameters for PTZ. The configuring of the PTZ parameters should be done before you control the PTZ camera.

Before you start:

Make sure that the PTZ camera and the device are connected properly via RS-485 interface.

Steps:

1. Enter the PTZ Settings interface.

Menu >Camera> PTZ

General	More Settings
Camera	Analog 1
Baud Rate	9600
Data Bit	8
Stop Bit	1
Parity	None
Flow Ctrl	None
PTZ Protocol	
Address	0
Address range: 0~255	

Figure 4. 1 PTZ- General

2. Choose the camera for PTZ setting in the **Camera** drop-down list.
3. Enter the parameters of the PTZ camera.



All the parameters should be exactly the same as the PTZ camera parameters. Only PTZ Protocol can be configured for network cameras.

Example: If the PTZ camera has a Baud rate as 115200, you should input 115200 in the Baud Rate field.

4. Click **Copy** if you want to configure same settings to other analog PTZ cameras.
5. Click **Apply** to save the settings.

4.2 Setting PTZ Presets, Patrols & Patterns

Before you start:

Make sure that the presets, patrols and patterns should be supported by PTZ protocols.



We use the interface of DS-9100HFI-ST series (unless otherwise stated) as the example to describe the following settings.

4.2.1 Customizing Presets

Purpose:

A preset is a predefined image position which contains information of pan, tilt, focus and other parameters. You can customize the presets and the presets can be used with the event triggered action.

Steps:

1. Enter the PTZ Control interface.
Menu> Camera >PTZ >More Settings

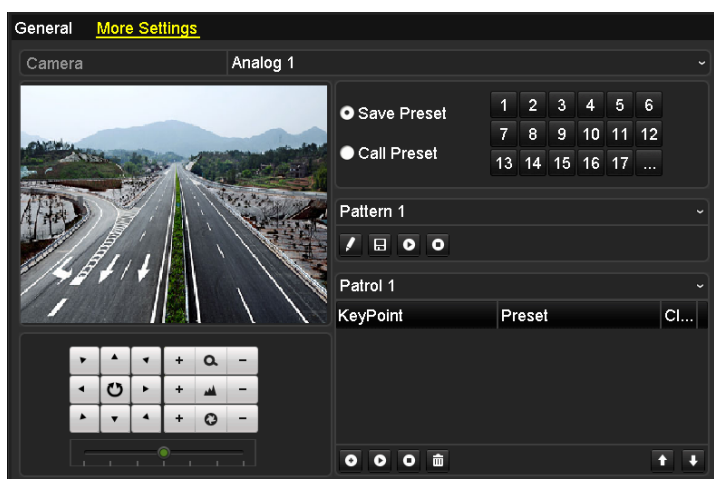

Figure 4. 2 PTZ- More Settings

2. Use the directional buttons on the PTZ control panel to steer the camera to the desired view.
3. Check Save Preset.
4. Click the preset number to save the preset.
5. Repeat the steps 2-4 to save more presets. If the number of the presets you want to save is more than 17, you can click and choose the available numbers.

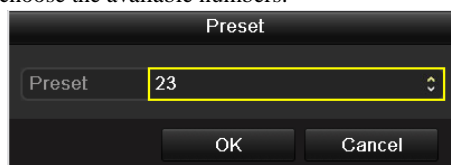

Figure 4. 3 More Presets

4.2.2 Calling Presets

Purpose:

The view angle of the PTZ camera will be moved to the predefined position when you call a preset.

Call a preset on the PTZ setting interface:

Steps:

1. Enter the PTZ Control interface.
Menu> Camera> PTZ> More Settings
2. Check Call Preset

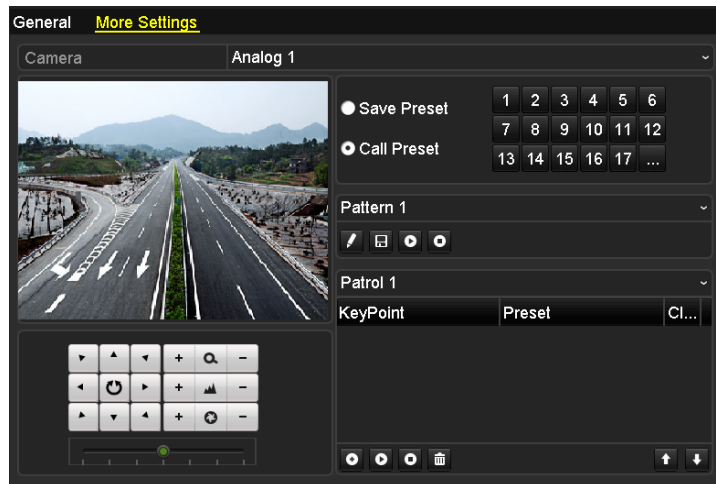

Figure 4. 4 PTZ- Call Preset

3. Choose the preset number.

Call a preset in live view mode:

Steps:

1. Click the button **PTZ** in the lower-right corner of the PTZ setting interface; or press the PTZ button on the front panel or click the PTZ Control icon  in the quick setting toolbar during the live view process, to open the PTZ control panel in live view mode.



Figure 4. 5 PTZ Toolbar

2. Click the **Camera** tab on the panel, and select the channel for control on the camera list.
3. Click the **Preset** tab on the panel, and double-click the preset you want to call on the preset list.

4.2.3 Customizing Patrols

Purpose:

A patrol is a scanning track specified by a group of user-defined key points, with the scanning speed between two key points and the duration time at each key point separately programmable. The key points are corresponding to the presets.

Steps:

1. Enter the PTZ Control interface.
Menu>Camera>PTZ>More Settings
2. Select patrol number.
3. Click  under Patrol option box to add key points for the patrol.

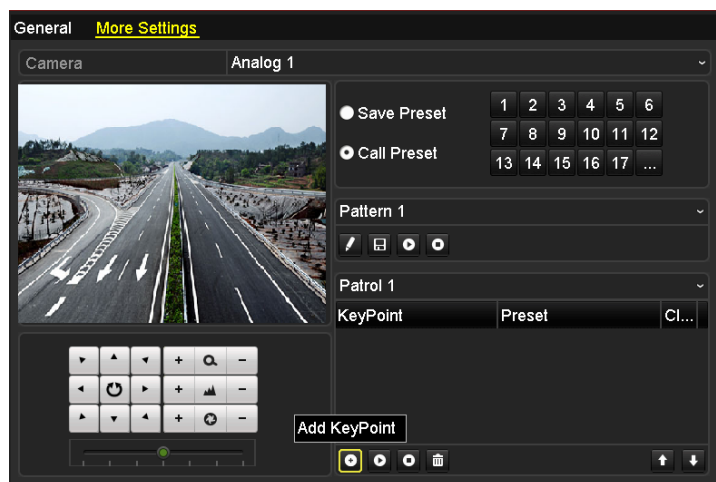

Figure 4. 6 PTZ- Add Key Point

4. Configure key point parameters, such as the preset No., duration of staying for one key point and speed of patrol. The key point is corresponding to the preset. The **Preset** determines the order at which the PTZ will follow while cycling through the patrol. The **Duration** refers to the time span to stay at the corresponding key point. The **Speed** defines the speed at which the PTZ will move from one key point to the next.

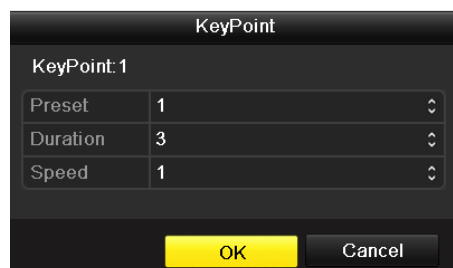



Figure 4. 7 Key point Configuration

5. Click **OK** to save the key point to the patrol.
- Repeat the above steps to add more key points.

You can also click  to delete the corresponding key point and click  to delete all the key points.

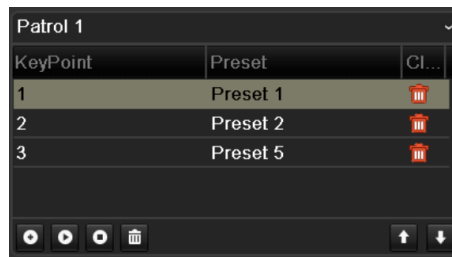

Figure 4. 8 KeyPoints Deletion



4.2.4 Calling Patrols

Purpose:

The PTZ camera will move according to the predefined patrol path when you call a patrol.

Call a patrol in the PTZ setting interface:

Steps:

1. In the PTZ setting interface.
Menu> Camera> PTZ> More Settings
2. Select the patrol number, and then click  to call the patrol.
3. Click  to stop it.

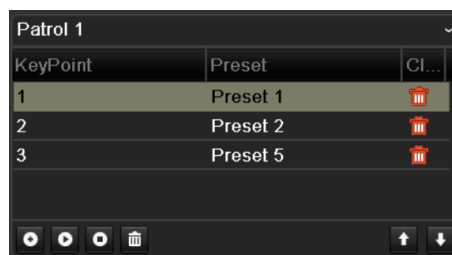

Figure 4. 9 Calling Patrol

Call a patrol in live view mode:

Steps:

1. Open the PTZ control panel in live view mode.
2. Click the **Camera** tab on the panel, and select the channel for control on the camera list.
3. Click the **Patrol** tab on the panel, and then double-click the patrol, or click to select the patrol and click  to call the patrol.



Figure 4.10 PTZ Panel- Patrol

4.2.5 Customizing Patterns

Purpose:

A pattern is a memorized, repeating series of pan, tilt, zoom, and preset functions.

Steps:

1. Enter the PTZ Control interface.
Menu>Camera>PTZ>More Settings
2. Choose pattern number in the option box.

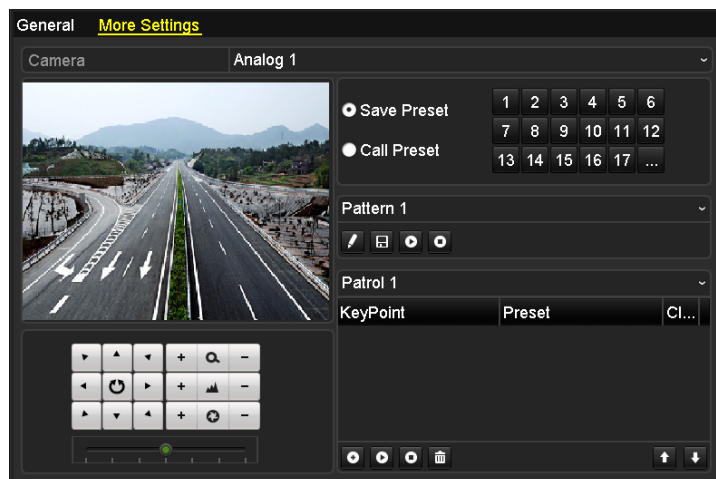



Figure 4.11 PTZ- Pattern

3. Click , and use your mouse to drag the image or click the eight directional buttons in the control box under the image to move the PTZ camera. The movement of the PTZ is recorded as the pattern.
4. Click  to save the pattern.
Repeat the above steps to save more patterns.



4.2.6 Calling Patterns

Purpose:

The PTZ camera will move according to the predefined pattern path when you call a pattern.

Call a pattern in the PTZ setting interface

Steps:

1. Enter the PTZ Control interface.
Menu> Camera> PTZ> More Settings
2. Select the pattern number.
3. Click , then the PTZ moves according to the pattern. Click  to stop it.

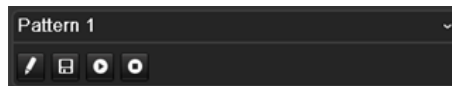

Figure 4. 12 PTZ- Calling Pattern

Call a pattern in live view mode.

Steps:

1. Open the PTZ control panel in live view mode.
2. Click the **Camera** tab on the panel, and select the channel for control on the camera list.
3. Click the **Pattern** tab on the panel, and then double-click the pattern, or click to select the patrol and click  to call the pattern.



Figure 4. 13 PTZ Panel- Pattern

4.3 PTZ Control Panel

To enter the PTZ control Panel, there are 2 ways supported:

Option1:

In the PTZ settings interface, click the **PTZ** button on the lower-right corner.

Option2:

In the Live View mode, you can press the PTZ Control button on the front panel or on the remote control, or click the PTZ Control icon  in the quick setting toolbar to enter the PTZ control panel;

Click the **Configuration** button on the panel, and you can enter the PTZ Settings interface.



In PTZ control mode, the PTZ panel will be displayed when a mouse is connected with the device. If no mouse is connected, the  icon appears in the lower-left corner of the window, indicating that this camera is in PTZ control mode.

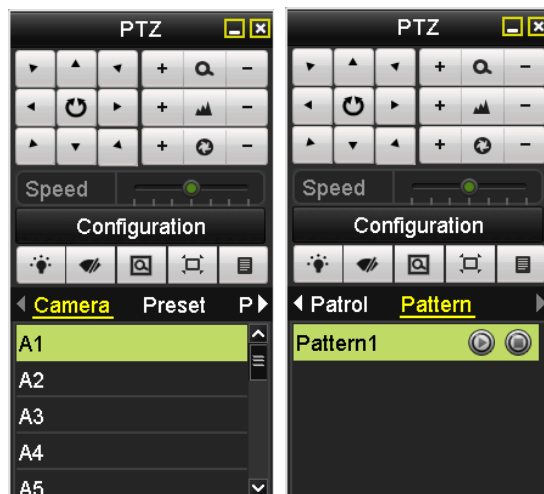

















Figure 4.14 PTZ Panel

Table 4.1 Description of the PTZ panel icons

Icon	Description	Icon	Description	Icon	Description
	Direction button and the auto-cycle button		Zoom+, Focus+, Iris+		Zoom-, Focus-, Iris-
	The speed of the PTZ movement		Light on/off		Wiper on/off
	3D-Zoom		Image Centralization		Preset
	Patrol		Pattern		Menu
	Previous item		Next item		Start pattern/patrol

	Stop the patrol or pattern movement		Minimize windows		Exit
---	--	---	---------------------	---	------

Chapter 5 Record and Capture Settings



Sensor alarm is not supported by DS-7200HWI-SV series. The interfaces of the device are subject to the actual model.

5.1 Configuring Encoding Parameters

Purpose:

By configuring the encoding parameters you can define the parameters which affect the image quality, such as transmission stream type, the resolution, etc.

Before you start:

1. Make sure that the HDD has already been installed. If not, please install a HDD and click **Init** to initialize it. (Menu > HDD > General)

HDD Information							
...	Capacity	Status	Property	Type	Free Space	Gr...	Edit D...
1	931.51GB	Normal	R/W	Local	928GB	1	- -

Figure 5. 1 HDD- General

2. Check the storage mode of the HDD
 - 1) Click **Advanced** to check the storage mode of the HDD.
 - 2) If the HDD mode is *Quota*, please set the maximum record capacity and maximum picture capacity. For detailed information, see *Chapter 11.5 Configuring Quota Mode*.
 - 3) If the HDD mode is *Group*, you should set the HDD group. For detailed information, see *Chapter 5.8 Configuring HDD Group for Recording and Capture*.

Steps:

1. Enter the Record settings interface to configure the encoding parameters:

Menu > Record > Parameters

Record	Substream	Capture
Camera	Analog 1	
Encoding Parameters	Main Stream(Continuous)	Main Stream(Event)
Stream Type	Video & Audio	Video & Audio
Resolution	704*576(4CIF)	704*576(4CIF)
Bitrate Type	Variable	Variable
Video Quality	Medium	Medium
Frame Rate	Full Frame	Full Frame
Max. Bitrate Mode	General	General
Max. Bitrate(Kbps)	1792	1792
Max. Bitrate Range Reco...	1152~1920(Kbps)	1152~1920(Kbps)
Pre-record	5s	
Post-record	5s	
Expired Time (day)	0	
Redundant Record/Capt...	<input type="checkbox"/>	
Record Audio	<input checked="" type="checkbox"/>	
Video Stream	Main Stream	

Figure 5. 2 Record Parameters

2. Encoding Parameters for Recording

- 1) Click the **Record** tab to configure the record parameters, such as stream type, resolution, bitrate type, video quality, frame rate, etc.
 - **Pre-record:** The time you set to record before the scheduled time or event. For example, when an alarm triggered the recording at 10:00, if you set the pre-record time as 5 seconds, the camera records it at 9:59:55.
 - **Post-record:** The time you set to record after the event or the scheduled time. For example, when an alarm triggered the recording ends at 11:00, if you set the post-record time as 5 seconds, it records till 11:00:05.
 - **Expired Time:** The time for keeping the record files in the HDDs, once exceeded, the files will be deleted. The files will be saved permanently if the value is set as 0. The actual keeping time for the files should be determined by the capacity of the HDDs.
 - **Redundant Record/ Capture:** Enabling redundant record or capture means you save the record and captured picture in the redundant HDD. See *Chapter 5.7 Configuring Redundant Recording/Capture*.
 - **Record Audio:** Enable this feature to record the sound and disable it to record the video without sound.
 - **Video Stream:** Main stream and sub-stream are selectable for recording. When you select sub-stream, you can record for a longer time with the same storage space

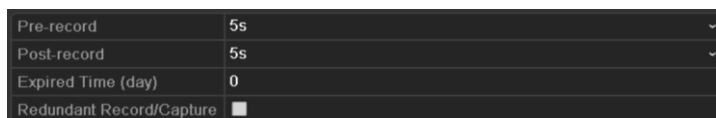

Figure 5.3 Record Encoding (when HDD Mode is Group)

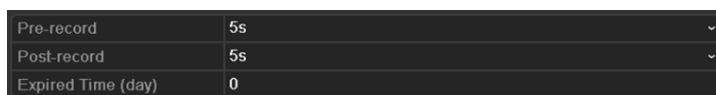

Figure 5.4 Recording Encoding (when HDD Mode is Quota or Frame Extracting)



The **Redundant Record/Capture** option is only available when the HDD mode is *Group*.

Redundant HDD is required for the redundant record/capture function. For detailed information, see *Chapter 11.4.2 Setting HDD Property*.

For network cameras, the parameters of Main Stream (Event) are not editable.

For DS-9100/9000/8100/8000HWI-ST & DS-7200HWI-SV series, you can enable/disable the WD1 mode.

- 2) Click **Apply** to save the settings.
- 3) Optionally, you can click **Copy** to copy the settings to other analog channels if needed.



Figure 5.5 Copy Camera Settings

3. Encoding Parameters for Sub-stream

- 1) Click the **Substream** tab to configure the parameters of sub-stream, such as stream type, resolution, frame rate, etc.

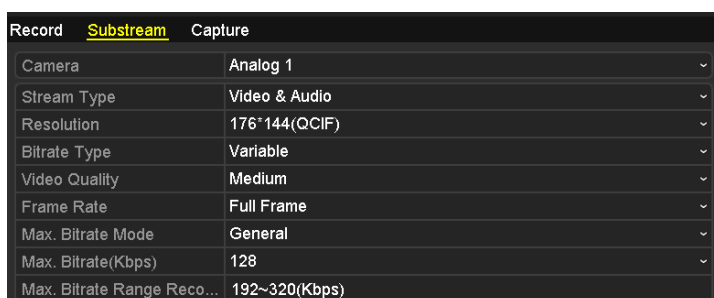

Figure 5. 6 Sub-stream Encoding

- 2) Click **Apply** to save the settings.
- 3) Optionally, you can click **Copy** to copy the settings to other analog channels if needed.

4. Encoding Parameters for Capture

- 1) Click the **Capture** tab to configure the capture parameters, such as resolution, picture quality, etc.

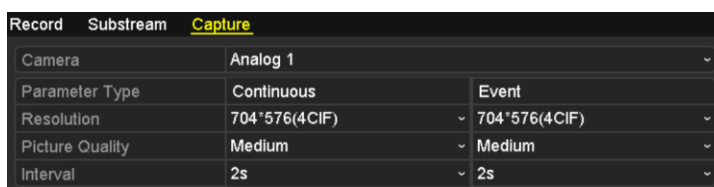

Figure 5. 7 Capture Encoding

- 2) You can configure the continuous and event parameters separately.
- 3) Click **Apply** to save the settings.
- 4) Optionally, you can click **Copy** to copy the settings to other analog channels if needed.



The interval is the time period between two capturing actions and the interval can be set as 1s, 2s, 3s, 4s, 5s, 10min, 30min, 1h, 12h and 24h. You can configure all the parameters on this menu on your demand.

5. Configure the overwrite mode of the HDD (Menu>Record>Advanced>Advanced). Check checkbox to enable the overwrite mode, and then the record files will be overwritten when the HDD becomes full. Otherwise, the recording will stop when the HDD becomes full.

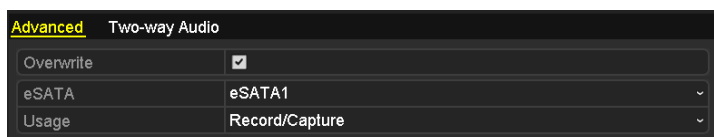

Figure 5. 8 Overwrite Mode

6. Configure the two-way audio record (Menu>Record>Advanced>Two-way Audio). Check checkbox to enable the two-way audio record and select the camera from the drop-down list. Then, the two-way audio record will be bound to the selected camera as the audio input.



- The two-way audio record can only be bound to the analog cameras.
- The bound two-way audio record will overlap the original audio input during the two-way audio.

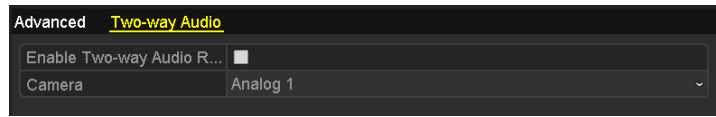

Figure 5. 9 Two-way Audio Record

5.2 Configuring Record/Capture Schedule

Purpose:

Set the record schedule, and then the camera automatically starts/stops recording according to the configured schedule.



In this chapter, we take the record schedule procedure as an example, and the same procedure can be applied to configure schedule for both continuous recording and capture. To schedule the automatic capture, you need to choose the **Capture** tab in the Schedule interface.

We use the interface of DS-9000HFI-ST series (unless otherwise stated) as example to describe the following settings.

Steps:

1. Enter the Record Schedule interface.
Menu > Record > Schedule
2. Configure Record Schedule
 - 1) Select Record / Capture Schedule.

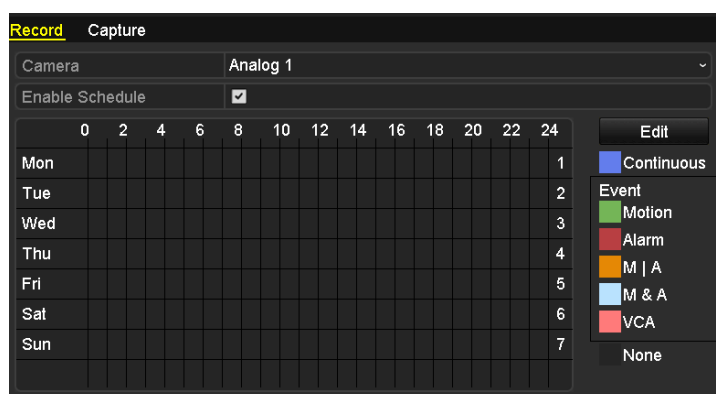

Figure 5.10 Record Schedule

- 2) Choose the camera you want to configure.
- 3) Check checkbox to enable record schedule.

There are two ways to configure the record schedule.

Task 1: Edit the Schedule

Steps:

- 1) Click **Edit**.
- 2) In the message box, you can choose the day which you want to set schedule.
- 3) To schedule an all-day recording, check checkbox to enable all-day recording.
- 4) Set the Type in the drop-down list, including Continuous, Motion, Alarm, Motion | Alarm and Motion & Alarm.



To enable Motion, Alarm, Motion | Alarm (motion or alarm) and Motion & Alarm (motion and alarm) triggered recording and capture, you must configure the motion detection settings or alarm input settings

as well. For detailed information, refer to *Chapter 8.1* and *Chapter 8.2*.

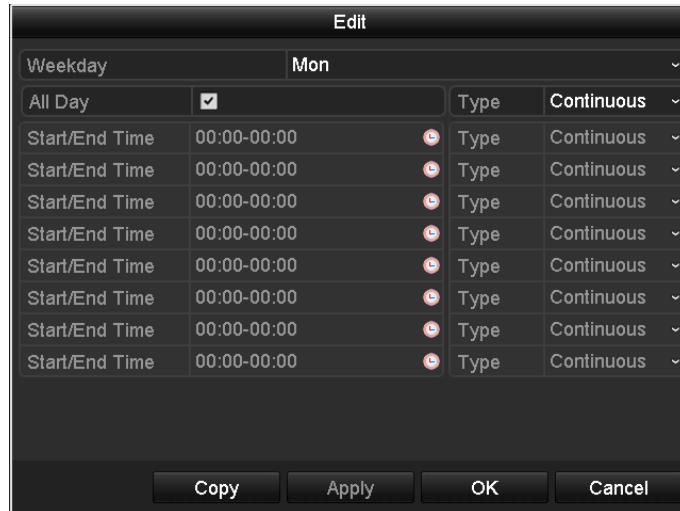

Figure 5. 11 Edit Schedule

5) To arrange other schedule, leave the **All Day** checkbox blank and set the Start/End time and Type.



Up to 8 periods can be configured for each day. And the time periods cannot be overlapped each other. Repeat the above steps2)-5) to schedule recording/capture for other days in the week. If the schedule can also be set to other days, click **Copy**.

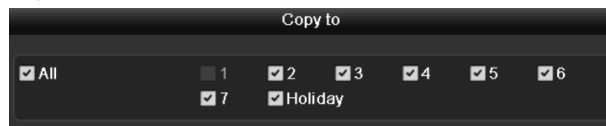

Figure 5. 12 Copy Schedule to Other Days



The **Holiday** option is available when you enable holiday schedule in **Holiday settings**. Refer to *Chapter 5.6 Configuring Holiday Record and Capture*.

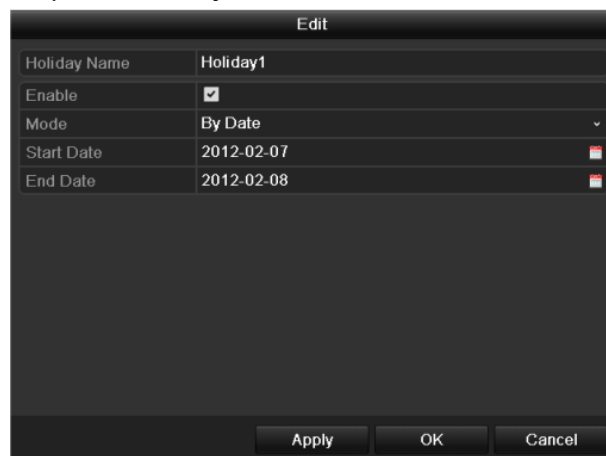

Figure 5. 13 Holiday Settings

6) Click **OK** to save setting and back to upper level menu.

Task 2: Draw the Schedule

Steps:

1) Click to select a record type, including Continuous, Motion, Alarm, M | A, M & A, VCA and None.



- To enable Motion, Alarm, M | A (motion or alarm), M & A (motion and alarm) and VCA (Video Content Analysis) triggered recording and capture, you must configure the motion detection settings, alarm input settings or VCA settings as well. For detailed information, refer to *Chapter 8.1, Chapter 8.2 and Chapter 8.3.*
- The VCA settings are only available to the smart cameras supporting the VCA function.

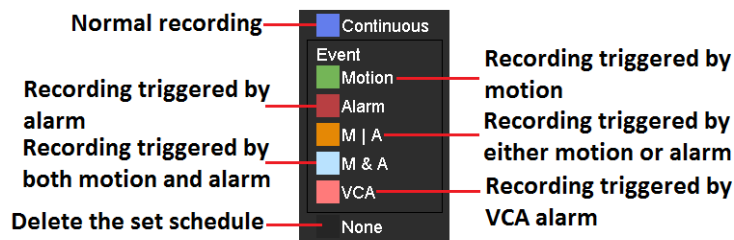
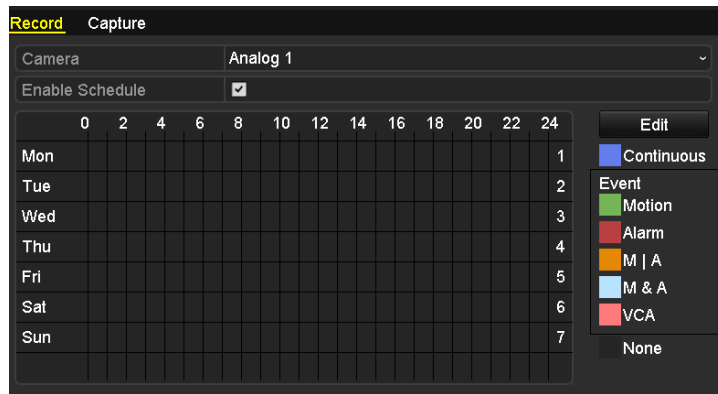

Figure 5. 14 Draw the Schedule (1)

2) Use the mouse to drag and draw time periods.



Up to 8 periods can be configured for each day.

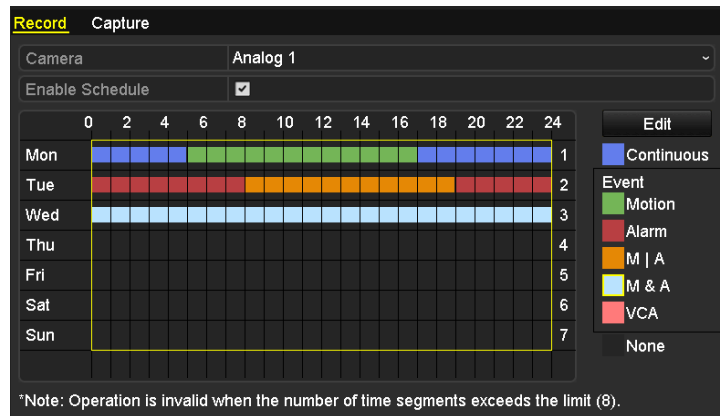

Figure 5.15 Draw the Schedule (2)

You can repeat the above steps to set schedule for other channels. If the settings can also be used to other channels, click **Copy**, and then choose the channel to which you want to copy. Click **Apply** in the Record/Capture Schedule interface to save the settings.

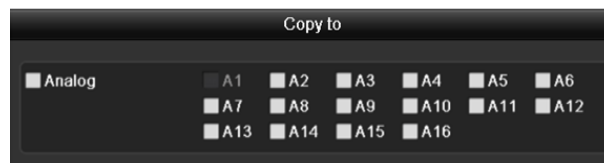

Figure 5.16 Copy Schedule to Other Channels for DVR Series

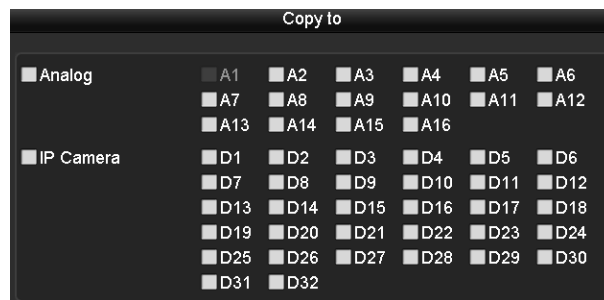

Figure 5.17 Copy Schedule to Other Channels for HDVR Series



IP Camera is supported by HDVR series only.

5.3 Configuring Motion Detection Recording and Capture

Purpose:

Follow the steps to set the motion detection parameters. In the live view mode, once a motion detection event takes place, the device can analyze it and do many actions to handle it. Enabling motion detection function can trigger certain channels to start recording/capture, or trigger full screen monitoring, audible warning, notify the surveillance center and so on. In this chapter, you can follow the steps to schedule a record which triggered by the detected motion.

Steps:

1. Enter the Motion Detection interface.

Menu > Camera > Motion



Figure 5.18 Motion Detection

2. Configure Motion Detection:

- 1) Choose camera you want to configure.
- 2) Check checkbox to enable motion detection.
- 3) Drag and draw the area for motion detection by mouse. If you want to set the motion detection for all the area shot by the camera, click **Full Screen**. To clear the motion detection area, click **Clear**.
- 4) Click  to configure the motion detection settings in the pop-up message box.

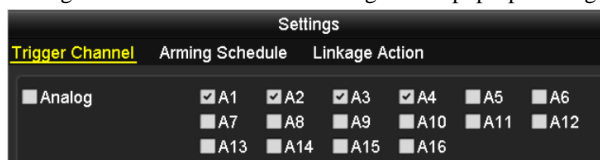

Figure 5.19 Motion Detection Settings for DVR Series

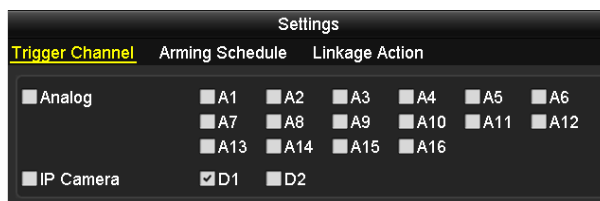

Figure 5.20 Motion Detection Settings for HDVR Series



IP Camera is supported by HDVR series only.

- 5) Select the channels which you want the motion detection event to trigger recording or capture.
 - 6) Click **Apply** to save the settings.
 - 7) Click **OK** to back to the upper level menu.
 - 8) Click **Apply** in the Motion Detection interface to save the settings. Exit the Motion Detection interface.
3. Enter Record/Capture Schedule settings interface (Menu> Record> Schedule>Record/Capture Schedule).
For detailed information about record schedule settings, refer to step 2 in *Chapter 5.2 Configuring Record/Capture Schedule*.



You need to select the **Type** as Motion in record schedule settings.

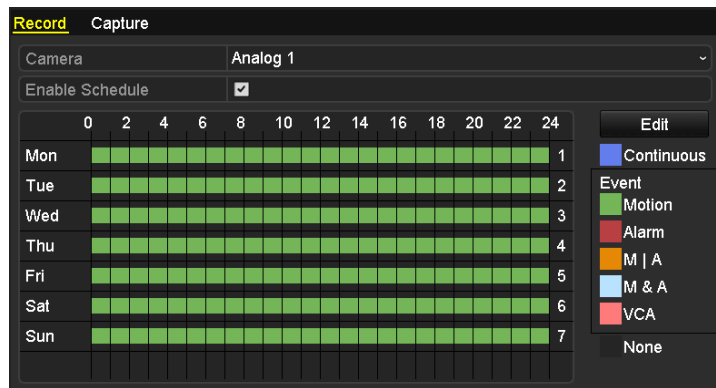

Figure 5. 21 Record Schedule

5.4 Configuring Alarm Triggered Recording and Capture

Purpose:

Follow the procedure to configure alarm triggered recording or capture.



Sensor alarm is not supported by DS-7200HWI-SV series. We use the interface of DS-9100HFI-ST series (unless otherwise stated) as example to describe the following settings.

Steps:

1. Enter the Alarm setting interface.

Menu > Configuration > Alarm

Alarm Status			Alarm Input	Alarm Output
Alarm Input List				
Alarm Input No.	Alarm Name	Alarm Type		
Local<-1	1	N.C		
Local<-2		N.O		
Local<-3		N.O		
Local<-4		N.O		
Local<-5		N.O		
Local<-6		N.O		
Local<-7		N.O		
Alarm Output List				
Alarm Output No.	Alarm Name	Dwell Time		
Local->1		5s		
Local->2		5s		
Local->3		5s		
Local->4		5s		

Figure 5.22 Alarm Settings

2. Click **Alarm Input** tab.

Alarm Status		Alarm Input	Alarm Output
Alarm Input No.		Local<-1	
Alarm Name		1	
Type		N.C	
Enable		<input checked="" type="checkbox"/>	
Settings			

Figure 5.23 Alarm Settings- Alarm Input

- 1) Select Alarm Input No. and configure alarm parameters.
- 2) Edit the alarm name as desired and choose N.O (normally open) or N.C (normally closed) for alarm type.
- 3) Check checkbox to enable the alarm input.
- 4) Click to configure the alarm settings.

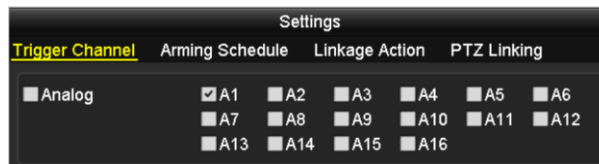

Figure 5. 24 Alarm Settings for DVR Series

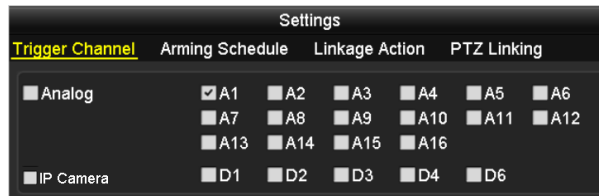

Figure 5. 25 Alarm Settings for HDVR Series



IP Camera is supported by HDVR series only.

- 5) Check the checkbox to choose the alarm triggered recording/capture channel.
- 6) Click **Apply** to save settings.
- 7) Click **OK** to back to the upper level menu.
- 8) Click **Apply** in the Alarm Input interface to save the settings.

Repeat the above steps to configure other alarm input parameters.

If the setting can also be applied to other alarm inputs, click **Copy** and choose the alarm input number.

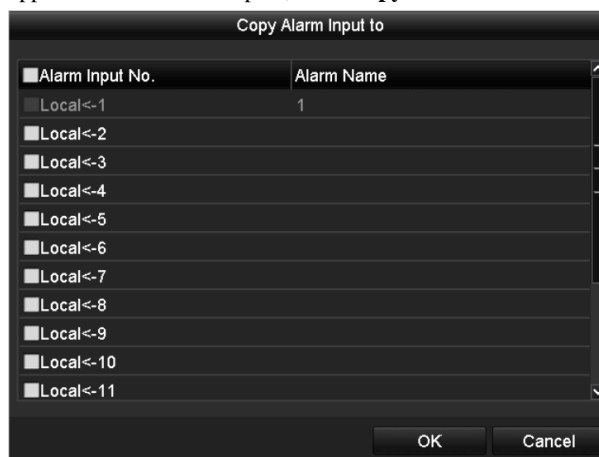

Figure 5. 26 Copy Alarm Input

3. Enter Record/Capture Schedule settings interface (Menu> Record> Schedule>Record/Capture Schedule). For detailed information about record schedule settings, refer to step 2 in *Chapter 5.2 Configuring Record/Capture Schedule*.



You need to select the **Type** as Alarm in record schedule settings.

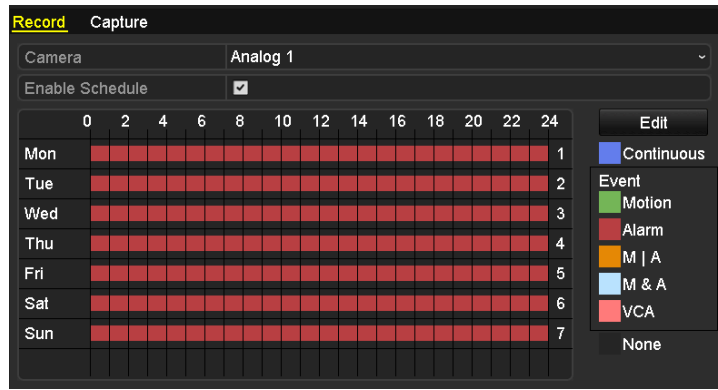

Figure 5.27 Record Schedule

5.5 Configuring Manual Recording and Continuous Capture

Purpose:

Follow the steps to set parameters for the manual recording and continuous capture. Using manual recording and continuous capture, you need to manually cancel the record and capture. The manual recording and manual continuous capture is prior to the scheduled recording and capture.

Steps:

1. Enter the Manual settings interface.

Menu> Manual

Or press the **REC/SHOT** button on the front panel.



Figure 5. 28 Manual Record for DVR Series

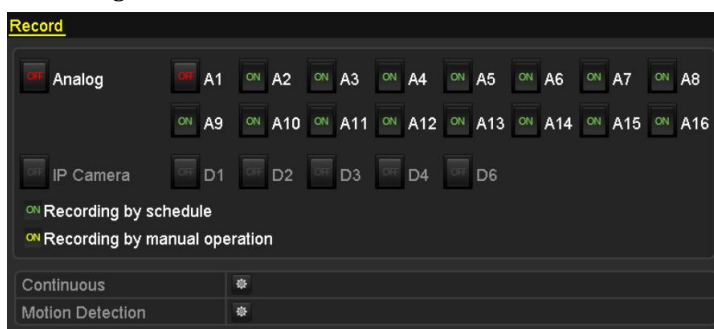

Figure 5. 29 Manual Record for HDVR Series



IP Camera is supported by HDVR series only.

2. Enable manual record

- 1) Select **Record** tab on the left bar.
- 2) Click the status button before camera No. to change **OFF** to **ON**.

3. Disable manual record.

Click the status button to change **ON** to **OFF**.



After rebooting, all the manual records enabled will be canceled.

4. Start all-day normal recording or all-day motion detection recording of all channels.

- 1) Click for **Continuous** or **Motion Detection**.



Figure 5. 30 Continuous Recording



Figure 5. 31 Motion Detection Recording

- 2) Click **Yes** to enable all-day continuous recording or all-day motion detection recording of all channels.
5. Enabling and disabling the continuous capture.
 - 1) Select **Continuous Capture** tab on the left bar.

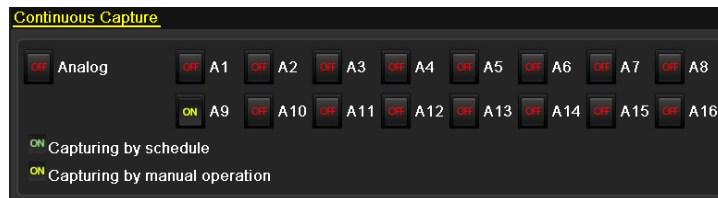

Figure 5. 32 Continuous Capture for DVR Series

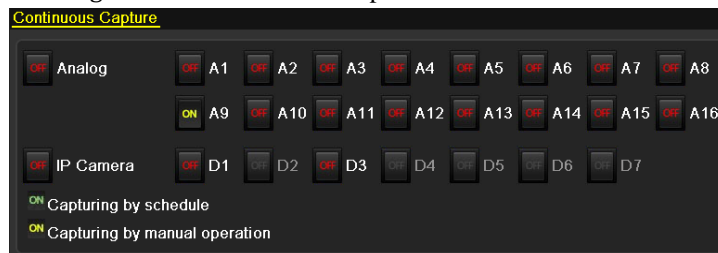

Figure 5. 33 Continuous Capture for HDVR Series



IP Camera is supported by HDVR series only.

- 2) Click the status button before camera number to change **OFF** to **ON** to enable continuous capture.
- 3) Or click the status button to change **ON** to **OFF** to disable continuous capture.



After rebooting, all the continuous capture will be canceled.

5.6 Configuring Holiday Recording and Capture

Purpose:

You may want to have different plan for recording and capture on holiday. Follow the steps to configure the record or capture schedule on holiday for that year.



The priority of holiday schedule is higher than any other schedule.

Steps:

1. Enter the Record setting interface.
Menu > Record
2. Choose **Holiday** on the left bar.

No.	Holiday Name	Status	Start Date	End Date	Edit
1	Holiday1	Enabled	1.Jan	1.Jan	
2	Holiday2	Disabled	1.Jan	1.Jan	
3	Holiday3	Disabled	1.Jan	1.Jan	
4	Holiday4	Disabled	1.Jan	1.Jan	
5	Holiday5	Disabled	1.Jan	1.Jan	
6	Holiday6	Disabled	1.Jan	1.Jan	
7	Holiday7	Disabled	1.Jan	1.Jan	
8	Holiday8	Disabled	1.Jan	1.Jan	
9	Holiday9	Disabled	1.Jan	1.Jan	
10	Holiday10	Disabled	1.Jan	1.Jan	
11	Holiday11	Disabled	1.Jan	1.Jan	
12	Holiday12	Disabled	1.Jan	1.Jan	

Figure 5. 34 Holiday Settings

3. Enable editing holiday schedule.
 - 1) Click to enter the Edit interface.

Edit	
Holiday Name	Holiday1
Enable	<input checked="" type="checkbox"/>
Mode	By Date
Start Date	02-07-2012
End Date	02-08-2012
<input type="button" value="Apply"/> <input type="button" value="OK"/> <input type="button" value="Cancel"/>	

Figure 5. 35 Edit Holiday Settings

- 2) Check checkbox to enable the holiday schedule.
- 3) Select Mode from the drop-down list.

There are three different modes for the date format to configure holiday schedule, including Date, Week and Month.

- 4) Set the start and end date.
 - 5) Click **Apply** to save settings.
 - 6) Click **OK** to exit the Edit interface.
4. Enter Record/Capture Schedule settings interface (Menu>Record>Schedule>Record/Capture Schedule).
For detailed information about record schedule settings, refer to step 2 in *Chapter 5.2 Configuring Record/Capture Schedule*.



You need to select schedule type as Holiday or draw the schedule for the Holiday.

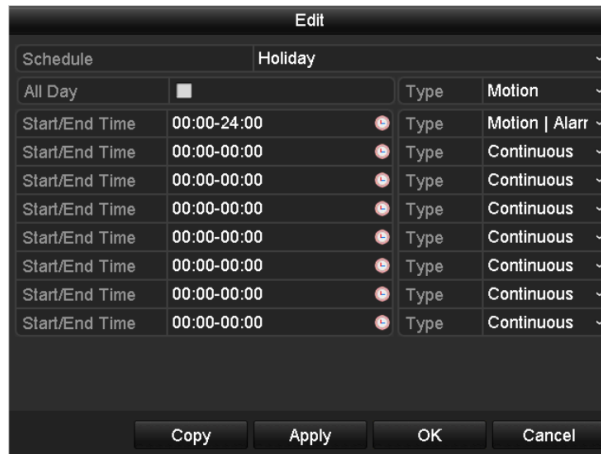

Figure 5.36 Edit Schedule- Holiday

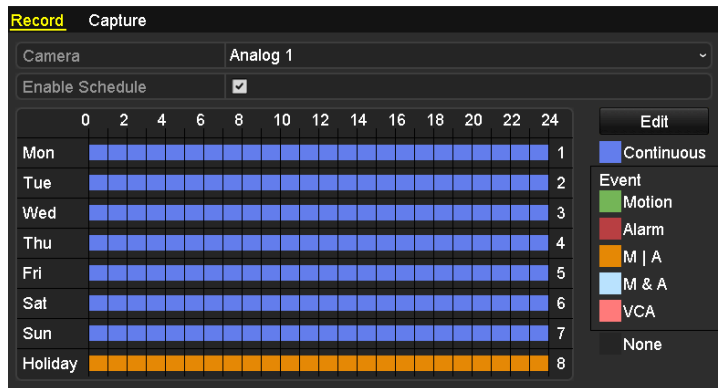

Figure 5.37 Draw Schedule- Holiday

5.7 Configuring Redundant Recording and Capture

Purpose:

The record files and captured pictures are stored not only in the R/W (read/write) HDD but also in the redundant HDD when the Redundant Record/Capture function is enabled, thus enhancing the data safety and reliability effectively.



The storage mode of the HDD needs to be set as Group. For details, see *Chapter 11.4 Managing HDD Group*. There should be at least another HDD which is in R/W mode.

Steps:

1. Enter HDD Information interface.

Menu > HDD > General

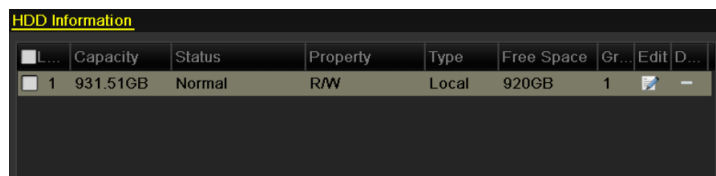

Figure 5.38 HDD General

2. Select the **HDD** and click to enter the Local HDD Settings interface.

- 1) Set the HDD property to Redundancy.



Figure 5.39 HDD General-Editing

- 2) Click **Apply** to save the settings.
- 3) Click **OK** to back to the upper level menu.
3. Enter the Record setting interface.
Menu > Record > Parameters

- 1) Select **Record**.

Record		
Camera	Analog 1	
Encoding Parameters	Main Stream(Continuous)	Main Stream(Event)
Stream Type	Video & Audio	Video & Audio
Resolution	704*576(4CIF)	704*576(4CIF)
Bitrate Type	Variable	Variable
Video Quality	Medium	Medium
Frame Rate	Full Frame	Full Frame
Max. Bitrate Mode	General	General
Max. Bitrate(Kbps)	1792	1792
Max. Bitrate Range Reco...	1152~1920(Kbps)	1152~1920(Kbps)
Pre-record	5s	
Post-record	5s	
Expired Time (day)	0	
Redundant Record/Capt...	<input type="checkbox"/>	
Record Audio	<input checked="" type="checkbox"/>	
Video Stream	Main Stream	

Figure 5. 40 Record Parameters

- 2) Select Camera you want to configure.
- 3) Check **Redundant Record/Capture** checkbox to enable redundant recording and capture.
- 4) Click **Apply** to save settings.

Repeat the above steps2)-4) for configuring other channels. If the setting can also be applied to other analog channels, click **Copy** and then choose the channel(s).

5.8 Configuring HDD Group for Recording and Capture

Purpose:

You can group the HDDs and save the record files and captured pictures in certain HDD group.

Steps:

1. Enter HDD setting interface.

Menu > HDD

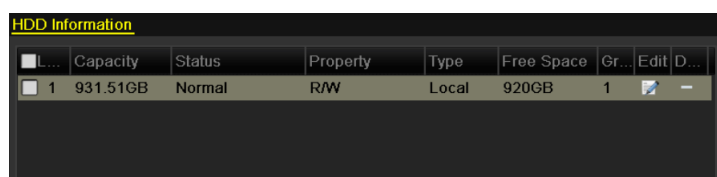

Figure 5. 41 HDD General

2. Select **Advanced** on the left bar.

Check whether the storage mode of the HDD is Group. If not, set it to Group. For detailed information, please refer to *Chapter 11.4 Managing HDD Group*.

3. Select **General** in the left bar and click to enter editing interface.

4. Configuring HDD group.

- 1) Choose a group number for the HDD group.
- 2) Click **Apply** and then in the pop-up message box, click **Yes** to save your settings.
- 3) Click **OK** to back to the upper level menu.

Repeat the above steps3-4 to configure more HDD groups.

5. Choose the channels of which you want to save the record files and captured pictures in the HDD group.

- 1) Select **Advanced** on the left bar.

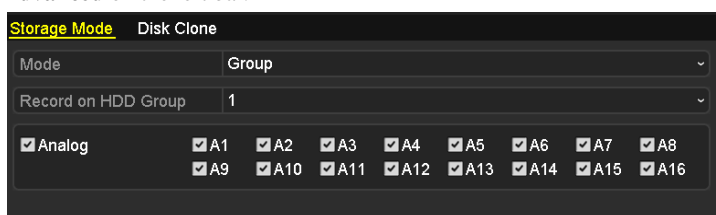

Figure 5. 42 HDD Advanced for DVR Series

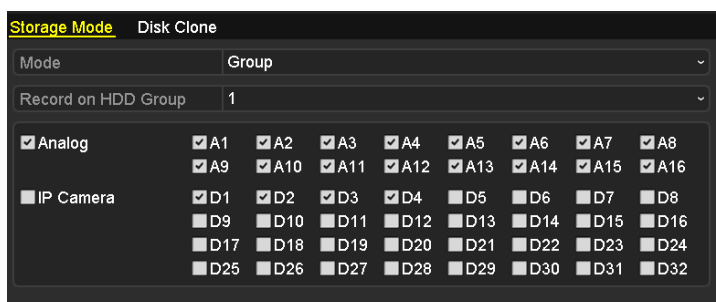

Figure 5. 43 HDD Advanced for HDVR Series



IP Camera is supported by HDVR series only.

- 2) Choose Group number in the drop-down list of **Record on HDD Group**.
- 3) Check the channels you want to save in this group.
- 4) Click **Apply** to save settings.



After having configured the HDD groups, you can configure the Recording and Capture settings by following the procedure provided in *Chapter 5.2-5.7*.

5.9 Files Protection

Purpose:

You can lock the recorded files or set the HDD property to Read-only to protect the record files from being overwritten.



We use the interface of DS-9000HFI-RT series (unless otherwise stated) as example to describe the following settings.

5.9.1 Locking the Record Files

Task 1: Lock File when Playback

Steps:

1. Enter the Normal Playback/Event Playback/Tag Playback interface. For details, see *Chapter 6.1.2~Chapter 6.1.4*.



Figure 5.44 Playback

2. Click the button on the toolbar, and the current record file in playback will be locked.



In multi-channel playback mode, click the button and all the record files related to the playback channels will be locked.

3. Click the button on the toolbar, select **Locked File** tab, and you can view and export the locked files.



Figure 5. 45 Locked File Management

- You can click the icon on the Locked File Management interface to unlock the selected record file.

Task 2: Lock File when Export

Steps:

- Enter Export setting interface.

Menu> Export

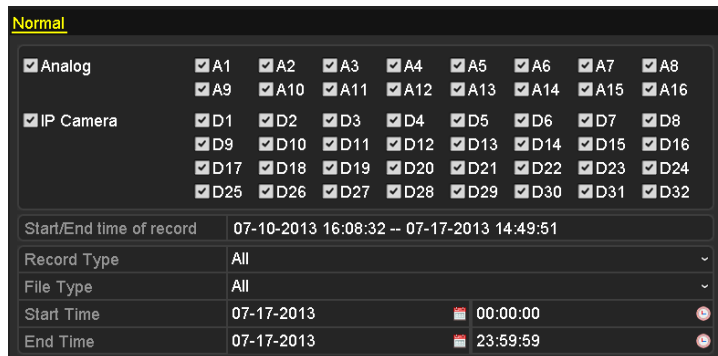

Figure 5. 46 Export Interface

- Check the checkbox to select the channels.
- Select the record type, file type and then specify the start/end time for search.
- Click **Search** to show the results.

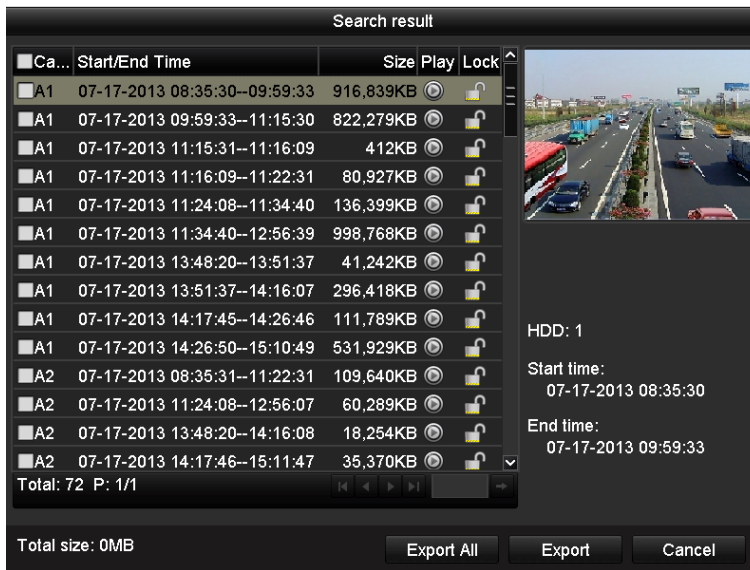

Figure 5. 47 Export- Search Result

5. Protect the record files.

- 1) Select the record file to be protected, and then click the icon. The icon turns to , indicating that the file is locked.
- 2) Click the icon to unlock the file and the file is not protected.



Figure 5. 48 Unlocking Attention

5.9.2 Setting HDD property to Read-only



To edit HDD property, you need to set the storage mode of the HDD to Group. See *Chapter 11.4 Managing HDD Group*.

Steps:

1. Enter HDD setting interface.
Menu> HDD

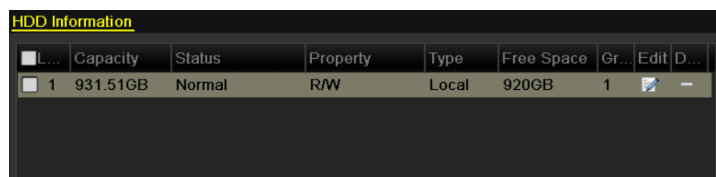

Figure 5. 49 HDD General

2. Click to edit the HDD you want to protect.



Figure 5. 50 HDD General- Editing

3. Set the HDD to Read-only.
4. Click **OK** to save settings and back to the upper level menu.



- You can't save any files in a Read-only HDD. If you want to save files in the HDD, change the property to R/W.
- If there is only one HDD and is set to Read-only, the device can't record any files. Only live view mode is available.
- If you set the HDD to Read-only when the device is saving files in it, then the file will be saved in next R/W HDD. If there is only one HDD, the recording will be stopped.

Chapter 6 Playback

6.1 Playing Back Record Files



- We use the interface of DS-9000HFI-ST series (unless otherwise stated) as the example to describe the following settings.
- Frame extracting mode is only supported by DVR series.

6.1.1 Playing Back by Channel

Purpose:

Play back the recorded video files of a specific channel in the live view mode. Channel switch is supported.

Instant playback by channel:

Choose a channel in live view mode using the mouse and click the  button in the quick setting toolbar.



Only record files recorded during the last five minutes on this channel will be played back.



Figure 6. 1 Instant Playback Interface

Playback by channel

Steps:

1. Enter the Playback interface.

Mouse: Right-click a live view window and click **Playback** on the pop-up menu to enter the playback interface.

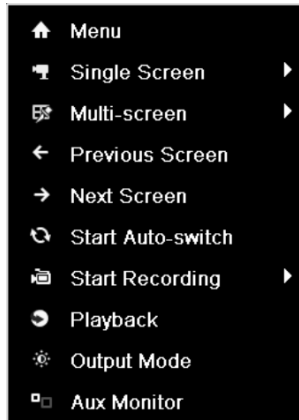

Figure 6. 2 Right-click Menu-DVR Series

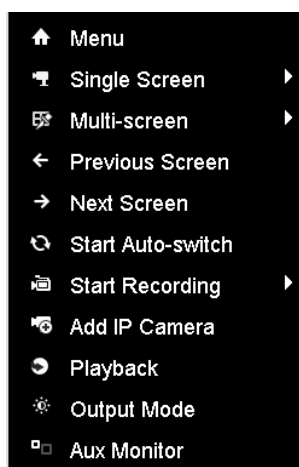

Figure 6. 3 Right-click Menu-HDVR Series

Front Panel: Press **PLAY** button to play back record files of the channel under single-screen live view mode.



Pressing numerical buttons will switch playback to the corresponding channels during playback process. Front panel operation is not supported by 7200HWI-SV series.

2. The playback starts from 5 minutes before by default.



Figure 6. 4 Playback Interface



- The **27-11-2013 15:13:57 -- 12-12-2013 15:26:56** indicates the start time and end time of the record files.
 - ■ represents normal recording (manual or schedule); ■ represents event recording (motion, alarm, motion | alarm, motion & alarm, VCA).
 - Playback progress bar: use the mouse to click any point of the progress bar to locate special frames, and a thumbnail of the specified frame will be displayed.
3. Check the checkboxes to select the channel(s), and then the video from the selected channels will be played back synchronously. Up to 16 channels can be set for synchronous playback.
- Click the **Max. Camera for Playback** tab, and you can play back the video from 16 channels at a time.
- Click the **Min. Camera for Playback** tab, and you can play back the video from only one channel.

6.1.2 Playing Back by Time

Purpose:

The time bar indicates the time duration for the record file. Click on the time bar to play back the video of the specified time.

Steps:

1. Enter Playback interface.
Menu>Playback
2. Check checkbox of channel(s) in the channel list.
3. Double-click to select a date on the calendar to play back the record file.





- If there are normal recordings (manual or schedule) for that camera in that day, on the calendar, the icon for that day is displayed as ; If there are event triggered recordings (motion, alarm, motion | alarm, motion & alarm VCA) for that camera in that day, in the calendar, the icon for that day is displayed as ; Otherwise it is displayed as .
- The event triggered recordings will be displayed prior to the normal recordings on the calendar when both the two types of recordings are available in that day.



Figure 6.5 Playback Calendar

In the Playback interface:

The toolbar in the bottom part of Playback interface can be used to control playing process.



Figure 6.6 Interface of Playback by Time



Figure 6.7 Toolbar of Playback by Time



- The **30-12-2013 16:41:32 -- 30-12-2013 18:56:04** indicates the start time and end time of the record files.

























-  represents normal recording (manual or schedule);  represents event recording (motion, alarm, motion | alarm, motion & alarm, VCA).
- Playback progress bar: use the mouse to click any point of the progress bar to locate special frames, and a thumbnail of the specified frame will be displayed.

Table 6. 1 Detailed Explanation of Playback-by-time Interface

Button	Operation	Button	Operation	Button	Operation	Button	Operation
	Audio on/ Mute		Adjust volume		Start/Stop clipping		Capture
	Lock file		Add default tag		Add customized tag		File management
	Digital Zoom		Pause/Play Reverse		Stop		Pause/Play
	30s backward		30s forward		Slow forward		Fast forward
	Previous day		Next day		Scaling up/down time bar		Process bar
	Full Screen		Exit		Frame extracting mode		Normal playback

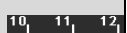
6.1.3 Playing Back by Event Search



Before you start:

The event (motion and alarm input) triggered record schedule needs to be configured. For details, see *Chapter 5.3* and *Chapter 5.4*.

Purpose:

The recordings triggered by different types of event (e.g. alarm input and motion detection) can be searched and played back if needed.

Steps:

1. Enter the playback interface.
Menu>Playback
2. Click  and select  to enter the Event Playback interface.
3. Select **Alarm Input, Motion or VCA** as the event type, and specify the start time and end time for search.

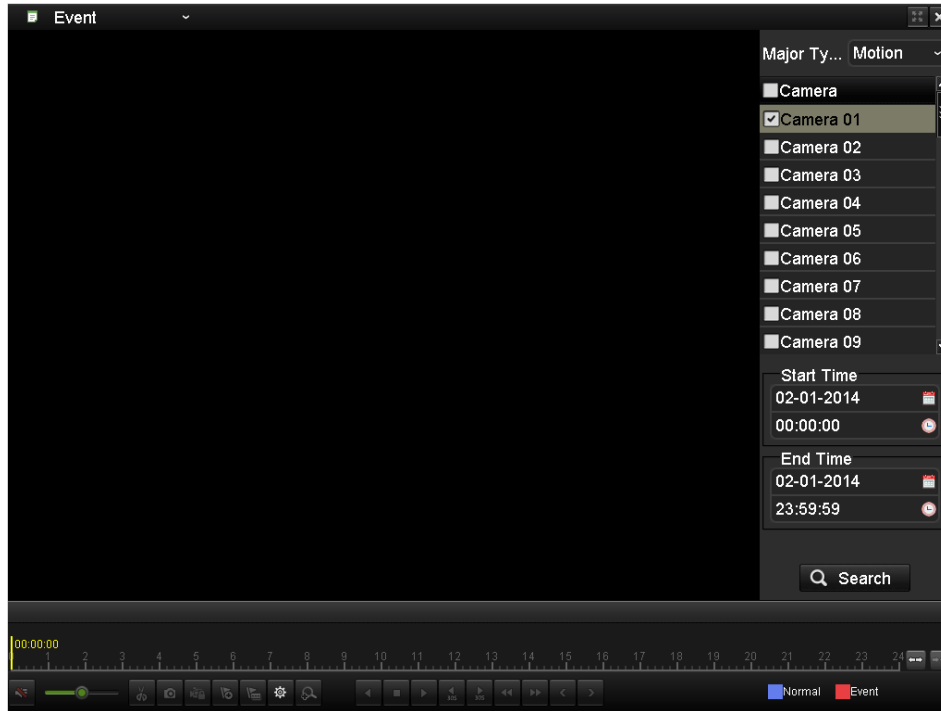

Figure 6. 8 Event Playback Interface-Motion



The VCA event search is only available to the HDVR series.

4. Click **Search**, and the record files matching the search conditions will be displayed on a list.

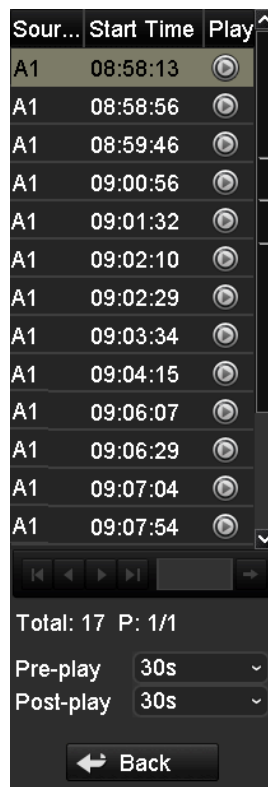



Figure 6. 9 Result of Video Search by Alarm Input

- Click  button to play back the record files.

You can click **Back** to return to the search interface.



Pre-play and post-play can be configured for the playback of event triggered record files.

Pre-play: The time you set to play back before the event. For example, when an alarm triggered the recording at 10:00, if you set the pre-play time as 5 seconds, the video plays back from 9:59:55.

Post-play: The time you set to play back after the event. For example, when an alarm triggered the recording ends at 11:00, if you set the post-play time as 5 seconds, the video plays back till 11:00:05.

If there is only one channel is triggered by an alarm input, clicking  button takes you to Full-screen Playback interface of this channel.

If several channels are triggered, clicking  button takes you to the interface. Check checkbox to select one channel for playback or select multiple channels for synchronous playback.



For DVR series, 4-ch, 8-ch and 16-ch devices support 4-ch, 8-ch and 16-ch synchronous playback respectively. While for HDVR series, 4-ch, 8-ch, 16-ch devices support 8-ch, 16-ch and 16-ch synchronous playback respectively.



Figure 6. 10 Select Channels for Synchronous Playback

- Event playback interface.

The toolbar in the bottom part of Playback interface can be used to control playing process.



Figure 6. 11 Interface of Playback by Event



Figure 6. 12 Toolbar of Playback by Event

Table 6. 2 Detailed Explanation of Playback-by-event Interface

Button	Operation	Button	Operation	Button	Operation	Button	Operation
	Audio on/ Mute		Adjust volume		Start/Stop clipping		Capture
	Lock file		Add default tag		Add customized tag		File management
	Digital Zoom		Pause/Play Reverse		Stop		Pause/Play
	30s backward		30s forward		Slow forward		Fast forward
	Previous event		Next event		Scaling up/down time bar		Process bar
	Full Screen		Exit		Frame extracting mode		Event playback

6.1.4 Playing Back by Tag

Purpose:



Default tags and customized tags can be added to mark the record files, and you can search the added tags and play back the marked record files through tag playback.

Before you start:

1. Enter the Normal Playback or Event Playback interface. For details, see *Chapter 6.1.2* and *Chapter 6.1.3*.



Figure 6. 13 Interface of Playback by Time

2. Click the icon  at the bottom of the interface to add the default tag.
Click the icon  and input the tag name to add the customized tag.
Click the icon  select the **Tag** tab, and you can view, edit and delete the added tag(s).



Up to 64 tags can be added to a single video file.



Figure 6. 14 Tag Management Interface

Steps:

1. Enter Playback interface.
Menu>Playback
2. Click **Normal** and select **Tag** to enter the Tag Playback interface.

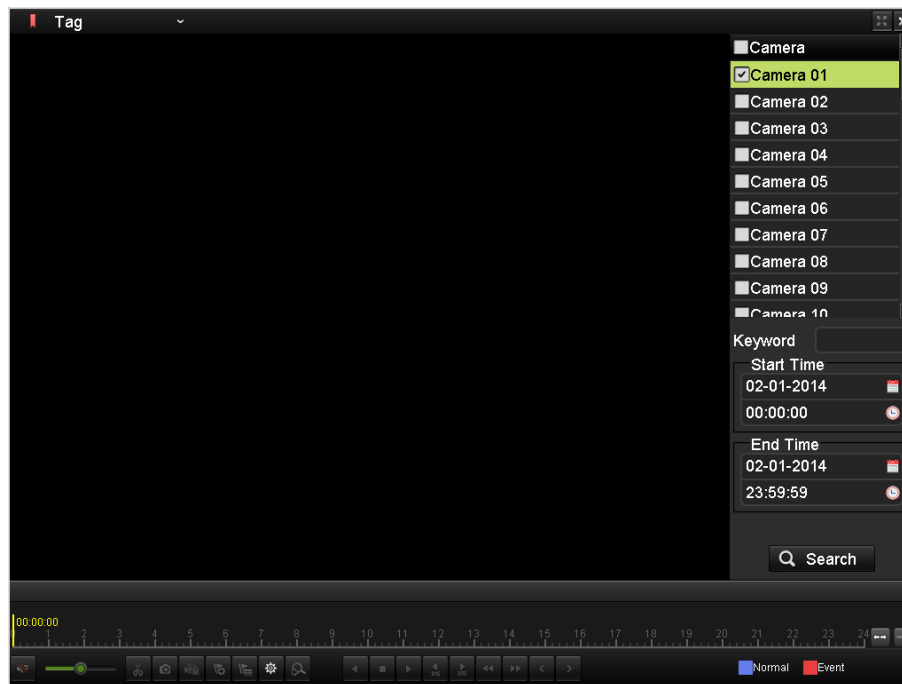

Figure 6. 15 Video Search by Tag

3. Select the channels from the list, and specify the start time and end time for search.
4. Optionally, you can input the keyword of the tag name in the Keyword text field to narrow the search.
5. Click **Search**, and the tags matching the search conditions will be displayed on a list.
6. Click **Play** button to play back the file.
You can click the **Back** button to back to the search interface.

Pre-play and post-play time can be set according to actual needs.



Pre-play time and post-play time is added to the time point of the tag.



Figure 6.16 Interface of Playback by Tag



Figure 6.17 Toolbar of Playback by Tag

Figure 6.18

Table 6.3 Detailed Explanation of Playback-by-tag Interface

Button	Operation	Button	Operation	Button	Operation	Button	Operation
	Audio on/ Mute		Adjust volume		Start/Stop clipping		Capture
	Lock file		File management		Digital Zoom		Pause/Play Reverse
	Stop		Pause/Play		30s backward		30s forward
	Slow forward		Fast forward		Previous tag		Next tag
	Scaling up/down time bar		Process bar		Full Screen		Exit
	Frame extracting		Tag playback				

	mode						
--	------	--	--	--	--	--	--

6.1.5 Smart Playback

Purpose:

The smart playback function provides an easy way to get through the less effective information. When you select the smart playback mode, the system will analyze the video containing the motion or VCA information, mark it with green color and play it in the normal speed while the video without motion will be played in the 16-time speed.

Steps:

1. Enter Playback interface.
Menu>Playback
2. Select the **Smart** in the drop-down list on the top-left side.
3. Select a date in the calendar and select a camera in the camera list.
4. Click the  button to play.



Figure 6. 19 Smart Playback Interface











- The **30-12-2013 16:41:32 -- 02-01-2014 13:35:04** indicates the start/end time of the record.
-  represents normal recording (manual or schedule);  represents event recording (motion, alarm, motion | alarm, motion & alarm, VCA); and  represents the smart search result.
- Playback progress bar: use the mouse to click any point of the progress bar or drag the progress bar to locate special frames.
- The smart search area is set as full screen by default. Click the  button to enter the search area editing interface. For details, see *Chapter 6.2.2*.

Table 6. 4 Detailed Explanation of Smart Playback

Button	Operation	Button	Operation	Button	Operation
	Smart search		Stop		Pause play/ Play
	Process bar		Scaling up/down the time line		Video type / picture

6.1.6 Playing Back by Searching System Log

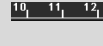
Purpose:

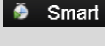
You can also play back record file(s) after searching system logs.

Steps:

1. Enter Log Information interface.

Menu>Maintenance>Log Information>Log Search



Figure 6. 20 Log Search Interface

2. Specify the start time and end time for search.
3. Select the major type of the log from the drop-down list. 4 major types are selectable: Alarm, Exception, Operation and Information.
4. Check the checkboxes to select the minor type of the log for search.
5. Click **Search**, and the logs matching the search conditions will be displayed on a list.

No.	Major Type	Time	Minor Type	Parameter	Play	Details
187	Alarm	12-26-2013 11:25:54	Video Tamperin...	N/A	▶	✓
188	Alarm	12-26-2013 11:26:01	Video Tamperin...	N/A	▶	✓
189	Alarm	12-26-2013 11:26:12	Video Tamperin...	N/A	▶	✓
190	Alarm	12-26-2013 11:26:17	Video Tamperin...	N/A	▶	✓
191	Alarm	12-26-2013 11:26:23	Video Tamperin...	N/A	▶	✓
192	Information	12-26-2013 11:26:51	System Running...	N/A	—	✓
193	Information	12-26-2013 11:27:02	System Running...	N/A	—	✓
194	Operation	12-26-2013 11:27:12	Remote Operati...	IP Camera	—	✓
195	Operation	12-26-2013 11:27:12	Remote Operati...	N/A	—	✓
196	Operation	12-26-2013 11:27:12	Remote Operati...	Device	—	✓
197	Operation	12-26-2013 11:30:12	Remote Operati...	IP Camera	—	✓
198	Operation	12-26-2013 11:30:12	Remote Operati...	N/A	—	✓
199	Operation	12-26-2013 11:30:12	Remote Operati...	Device	—	✓
200	Operation	12-26-2013 11:33:11	Remote Operati...	IP Camera	—	✓

Total: 1067 P: 2/11

Export Back

Figure 6. 21 Result of System Log Search

6. Select a log with record file and click  button to enter Playback interface.



If there is no record file at the time point of the log, the message box “No result found” will pop up.



Figure 6. 22 Interface of Playback by Log

6.1.7 Playing Back External Files

Purpose:

The record files stored in the external storage devices, e.g., USB flash drives, USB HDDs, can be searched and played back.

Before you start:

Insert the external device(s) with available record files into the device.

Steps:

1. Enter the Playback interface.
Menu > Playback
2. Click  and select  External File to enter the External File Playback interface.

The files stored in the external device are listed in the right-side list.

You can click the **Refresh** button to refresh the file list.

3. Select a record file and click  to play it.

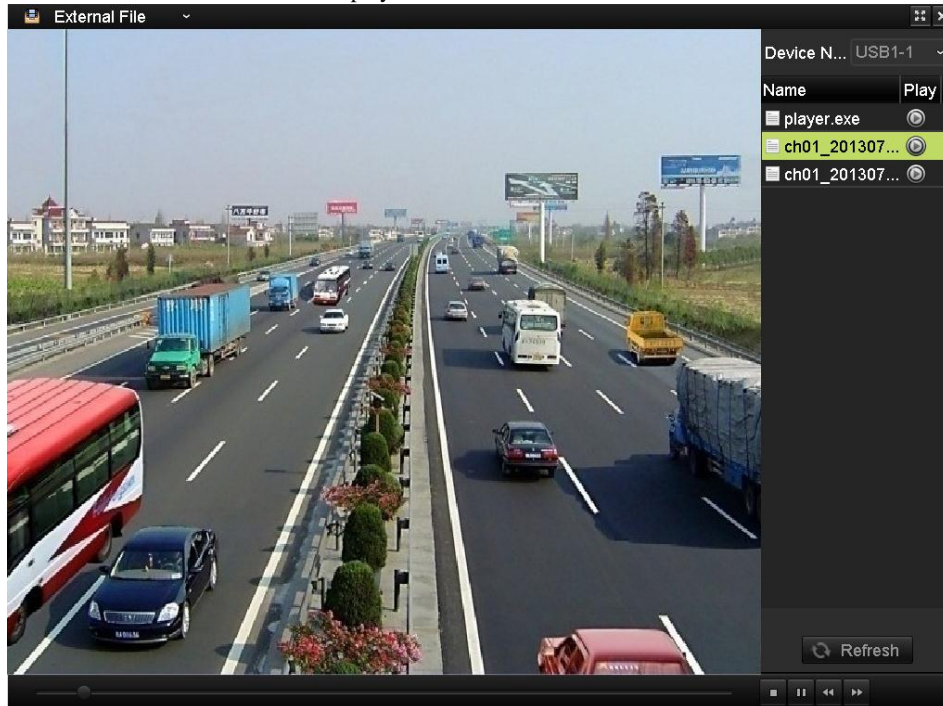

Figure 6. 23 Interface of External File Playback

6.1.8 Playing Back Frame Extracting Record

Purpose:

If there are frame extracting record files existing in the HDD, you can search and play back them. In this section, we use the interface of DS-9100HFI-RT series as example to describe the following settings.



- Frame extracting record is supported by DVR series only.
- The frame extracting record is with low bitrate and the frame rate is 1 fps.

Steps:

1. Enter the Playback interface, and check checkbox to select the frame extracting mode.
Menu>Playback

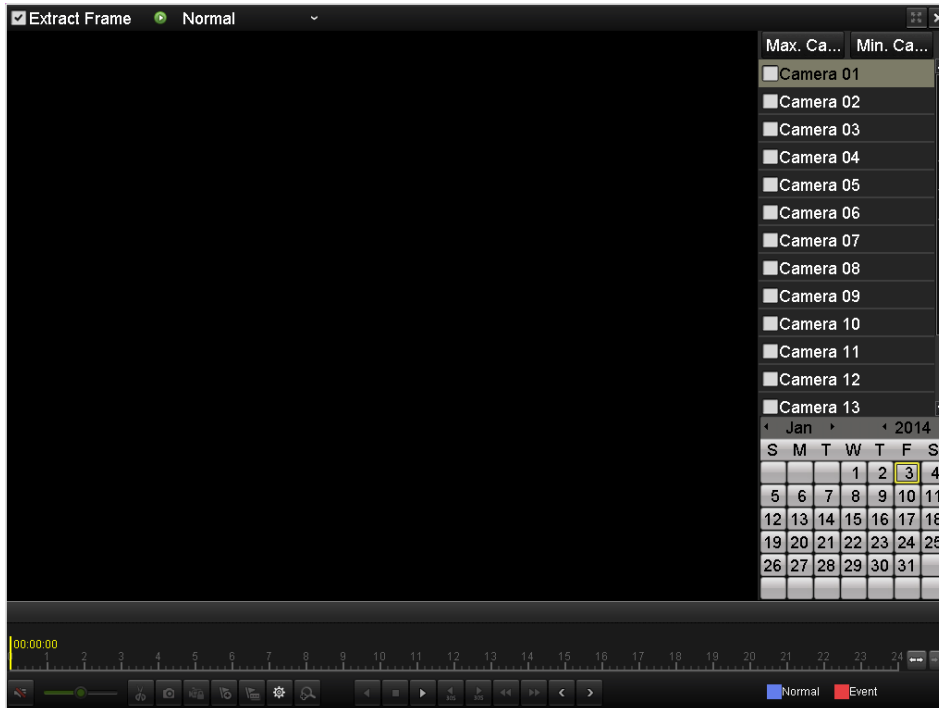

Figure 6. 24 Frame Extracting Record Playback Interface

2. Select the record type (Normal, Event and Tag) from the drop-down list and search the corresponding files. For details, see *Chapter 6.1.2*, *Chapter 6.1.3* or *Chapter 6.1.4*.
3. Play back the record files if available.



Figure 6. 25 Frame Extracting Record Playback

6.2 Auxiliary Functions of Playback





6.2.1 Playing Back Frame by Frame

Purpose:



Play video files frame by frame, in order to view the image details of the video when abnormal events occur.

Steps:

- **Using a Mouse:**

Go to Playback interface. If you choose playback of the record file: click button  and  until the speed changes to *Single* frame and one click on the playback screen represents playback of one frame. If you choose reverse playback of the record file: click button  and  until the speed changes to *Single* frame and one click on the playback screen represents reverse playback of one frame. It is also feasible to use button  in toolbar.

- **Using the Front Panel:**

Rotate and hold the outer ring on Jog Shuttle counterclockwise (for DS-8100/8000-ST series only) or click the  button to set the speed to *Single* frame. One click on button , one click on the playback screen or **Enter** button on the front panel represents playback or reverse playback of one frame.

6.2.2 Smart Search

Purpose:

In order to locate motion detection or VCA events easily and accurately in the playback progress bar, you can analyze a certain area (scene) dynamically, and get all of the related motion detection or VCA events that occurred in this area.

Before you start (for network cameras only):

1. Log in the IP camera via the web browser, and enable the intrusion detection by checking the checkbox of it. You may enter the intrusion detection configuration interface by Configuration> Advanced Configuration> Events> Intrusion Detection.



Figure 6. 26 Setting Intrusion Detection on IP Camera

2. Configure the required parameters of intrusion detection, including area, arming schedule and linkage methods. Refer to the user manual of smart IP camera for detailed instructions.

Steps:

1. Enter the Normal Playback interface, and start the playback. For details, see *Chapter 6.1.2*.



Figure 6. 27 Interface of Smart Playback

2. Click the icon  on the toolbar to enter Smart Search mode. The smart search toolbar appears at the bottom of the screen.

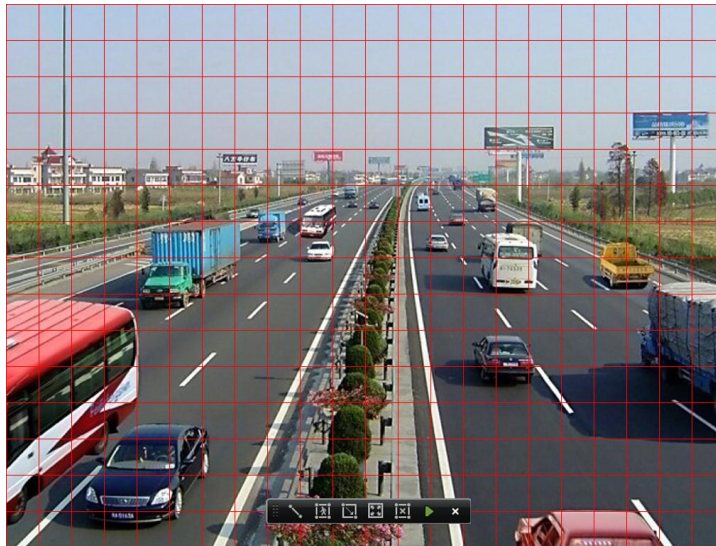







Figure 6. 28 Draw Area for Smart Search

3. Click-and-drag the mouse to draw area(s) for smart search.
 - **Intrusion Detection**
Click the  button, and then specify 4 points to set a quadrilateral region for intrusion detection. Only one region can be set.
 - **Motion Detection**
Click the  button and then click-and-draw the mouse to set the detection area manually. You can also

click the  button to set the full screen as the detection area.

4. Click the icon  to start the smart search, and the events occurred in the defined area will be marked as  on the time bar.

6.2.3 Digital Zoom



We use the interface of DS-9000HFI-RT series (unless otherwise stated) as example to describe the following settings.

Steps:

1. Enter the Playback interface and start the playback. For details, see *Chapter 6.1*.
2. Click the icon  on the playback control toolbar to enter Digital Zoom mode.
3. Click-and-drag the mouse to draw a red rectangle on the window in the lower-right corner of the interface. And then the image within it will be enlarged up to 16 times.
4. Right-click to exit the Digital Zoom mode.



Figure 6.29 Draw Area for Digital Zoom

6.2.4 Reverse Playback of Multi-channel

Purpose:

You can play back record files of multi-channel reversely. We use the interface of DS-9000 HFI-RT series (unless otherwise stated) as example to describe the following settings.

Steps:

1. Enter the Playback interface.
Menu>Playback
2. Check checkbox to select the channel(s) and double-click to select a date on the calendar.



Figure 6. 30 4-ch Synchronous Playback Interface



- If more than one channel is optional, the synchronous playback will be activated.
- The record files will be marked by two lines on the process bar. The upper one indicates the record files of the selected channel; and the lower one indicates the record files of all the selected channels.

3. Click the icon  on the playback control toolbar, and the record files will be played back reversely.



For DVR series, up to 16-ch simultaneous reverse playback is supported. While for Hybrid DVR series, up to 16-ch (with 704*576 resolution) simultaneous reverse playback is supported; up to 8-ch (with 1280*720 resolution) simultaneous reverse playback is supported; up to 4-ch (with 1920*1080P resolution) simultaneous reverse playback is supported and up to 1-ch (with 2560*1920 resolution) reverse playback is supported.

6.3 Picture Playback

Purpose:

The captured pictures stored in the HDDs of the device can be searched and viewed.

Steps:

1. Enter Playback interface.

Menu>Playback

2. Click  and select  to enter the Picture Playback interface.

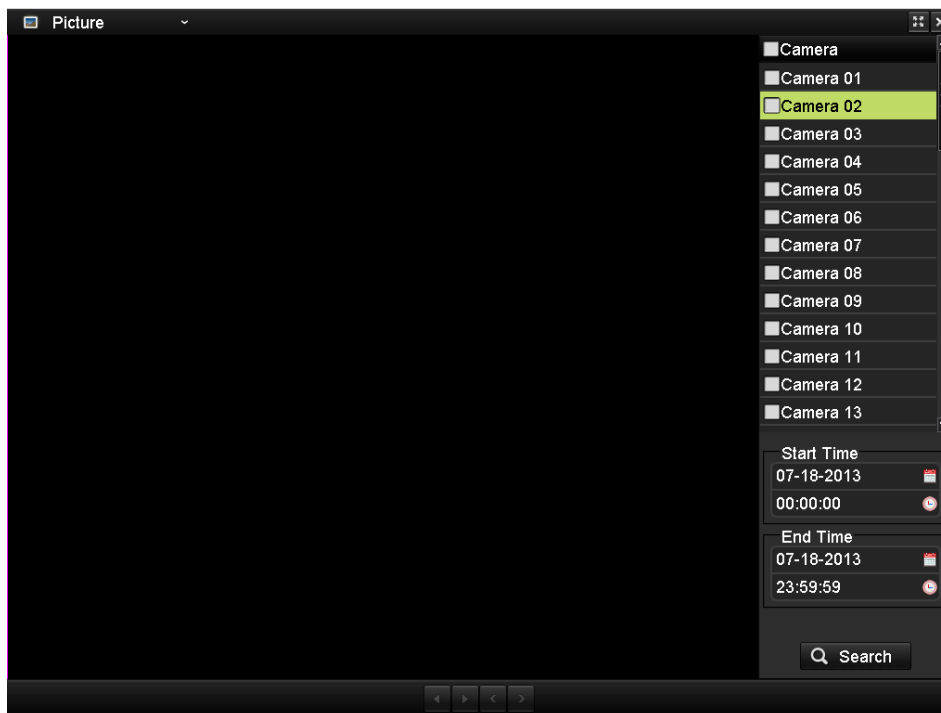

Figure 6. 31 Picture Playback Interface

3. Check checkbox to select the channel(s) and specify the start time and end time for search.
4. Click **Search** to enter Search Result interface.



Up to 4000 pictures can be displayed each time.

5. Choose a picture you want to view and click  button.
You can click **Back** to return to the search interface.







Figure 6. 32 Result of Picture Playback

6. The toolbar in the bottom part of Playback interface can be used to control playing process.



Figure 6. 33 Picture Playback Toolbar

Table 6. 5 Detailed Explanation of Picture-playback Toolbar

Button	Function	Button	Function	Button	Function	Button	Function
	Play reverse		Play		Previous picture		Next picture

Chapter 7 Backup

7.1 Backing up Record Files

Before you start:

Please insert the backup device(s) into the device.

7.1.1 Quick Export

Purpose:

Export record files to backup device(s) quickly.



We use the interface of DS-9000HFI-RT series (unless otherwise stated) as example to describe the following settings.

Steps:

1. Enter Normal Export interface.
Menu>Export>Normal
2. Select the channel(s) you want to back up and set the search conditions.



The start time and end time for search should be within the same day.

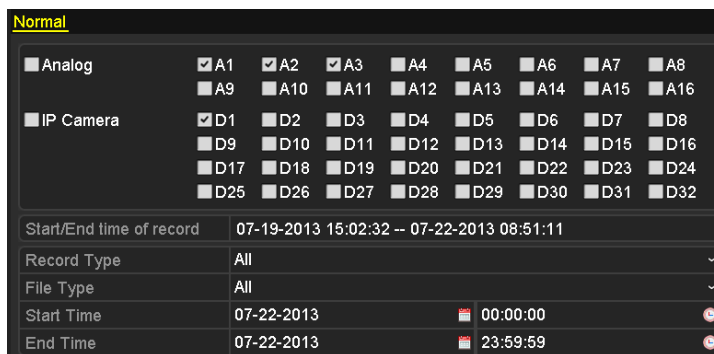

Figure 7.1 Quick Export Interface for DVR Series

3. Click the button **Quick Export**, and the Export interface pops up.



Figure 7.2 Quick Export using USB1-1

4. Select the backup device from the drop-down list and click the button **Export**.

The record files within the start time and end time will be exported to the external storage device (e.g., USB Flash Drive) after the backup process is complete.



The Player program *player.exe* will be exported automatically during record file export.



Figure 7.3 Checkup of Quick Export Result Using USB1-1

Click the button  on the Export interface, and you can view the video.

Click the button  on the Export interface, and you can delete the record file.

7.1.2 Backing up by Normal Video Search

Purpose:

The record files can be backed up to various devices, such as USB devices (USB flash drives, USB HDDs, USB writer), DVD-R/W and eSATA HDD. We use the interface of DS-9000HFI-RT series (unless otherwise stated) as example to describe the following settings.

Before you start:

When the backup device is the eSATA HDD, click Menu>Record>Advanced, select eSATA1 from the eSATA drop-down list, and set the usage as Export. Click **Apply** to save the settings and click **Yes** to confirm it.

Backup using USB flash drives, USB HDDs, USB writer and DVD-R/W

Steps:

1. Enter Normal Export interface.

Menu>Export>Normal

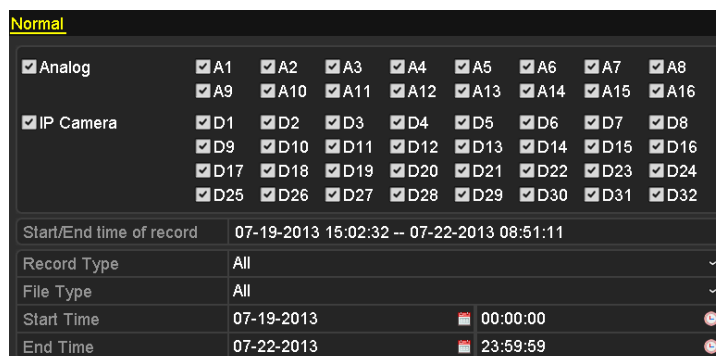



Figure 7. 4 Normal Video Search for Backup

2. Set the search conditions and click the button **Search** to enter the search result interface. You can click the button  to play the record file if you want to view it.



- Frame Extracting record mode is supported by the DVR series only.
- Six different Record types are selectable: Continuous, Motion, Alarm, Motion | Alarm, Motion & Alarm, Command Triggered and Manual. The command triggered record is configured by the platform when the device accessed via the platform.
- Two different File types are selectable: Unlocked and Locked.



Figure 7. 5 Result of Normal Video Search for Backup

3. Check the checkboxes to select the record files, and click the button **Export** to enter the Export interface. You can also click **Export All** to select all the record files for backup and enter the Export interface.



The size of the currently selected files is displayed in the lower-left corner of the window.



Figure 7.6 Export by Normal Video Search using USB Flash Drive

4. Click the button **Export** on the Export interface to start the backup process. A prompt message will pop up after the backup process is complete.

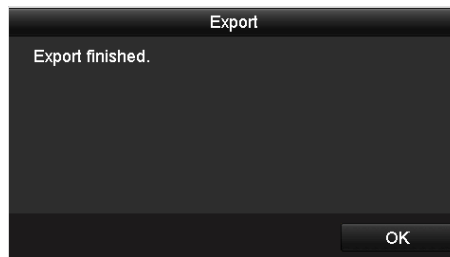



Figure 7.7 Export Finished

5. The exported record files will be displayed in a list on the Export interface. You can click  to view the video, or click  to delete the record file.



The Player program player.exe will be exported automatically during record file export.

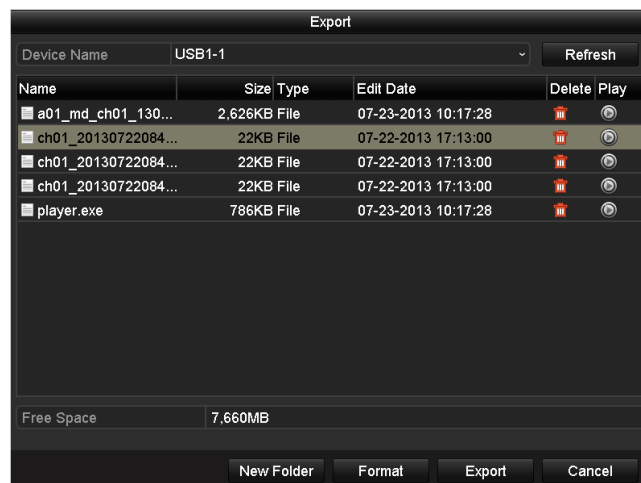

Figure 7.8 Checkup of Export Result using USB Flash Drive

7.1.3 Backing up by Event Search

Purpose:

The event triggered recordings can be backed up on USB devices (USB flash drives, USB HDDs, USB writer), DVD-R/W or eSATA HDD. Quick Backup and Normal Backup are supported.

Steps:

1. Enter Event Export interface.

Menu>Export>Event



Figure 7.9 Event Search for Backup

2. Select Alarm Input, Motion or VCA from the drop-down list as the event type, select the channel and specify the start time and end time for search, and then click the button **Search** to enter the Search Result interface.

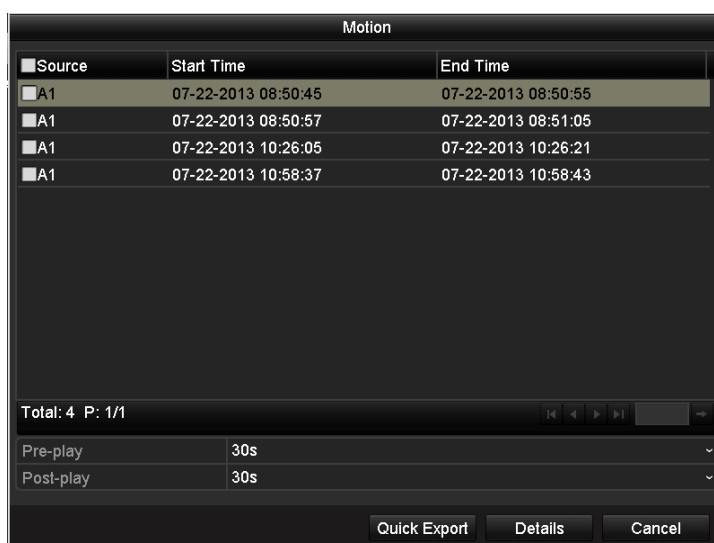

Figure 7.10 Result of Event Search

3. Select the record file from the list and click the button **Quick Export** to enter the Export interface.

Click the button **Details**, and you can view the detailed information of selected events. Then, select the record files, click the button **Export** or click the button **Export All** to select all the record files directly to enter the Export interface.



The size of the currently selected files is displayed in the lower-left corner of the window.



Figure 7.11 Event Details Interface



Figure 7.12 Export by Event Using USB Flash Drive

4. Click the button **Export** on the export interface to start the backup process. A prompt message will pop up after the backup process is complete.

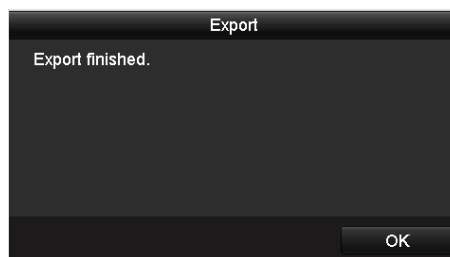



Figure 7.13 Export Finished

5. The exported record files will be displayed in a list on the Export interface.

You can click  to view the video, or click  to delete the record file.



The Player program player.exe will be exported automatically during record file export.



Figure 7. 14 Checkup of Event Export Result Using USB Flash Drive

7.1.4 Backing up Video Clips

Purpose:

You can also export the video clips directly during Playback, using USB devices (USB flash drives, USB HDDs, USB writer), DVD-R/W or eSATA HDD.

Steps:

1. Enter Playback interface and start the playback. For details, see *Chapter 6.1*.



Figure 7.15 Interface of Playback by Time



2. In the playback process, click the icon  in the playback toolbar to start/stop clipping record file(s).
3. Click the  button on the toolbar, select **Video Clip** tab, and you can view and export the video clips.



Figure 7.16 Clips Export



Up to 30 items of video clips can be selected for backup at one time.

4. Click the button **Export** to export the selected video clips to the backup device.
 You can also click the button **Export All** to export all the video clips to the backup device.



Figure 7. 17 Export Video Clips Using USB Flash Drive

Stay in the Exporting interface until all record files are exported with pop-up message “Export finished”.

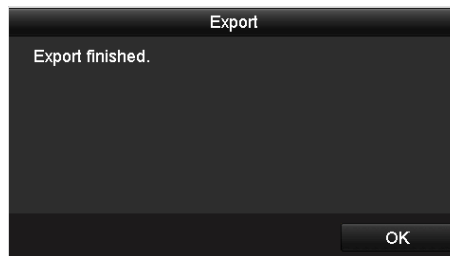

Figure 7. 18 Export Finished

5. After the backup is complete, the exported record files will be displayed in a list on the Export interface.



The Player program player.exe will be exported automatically during record file export.

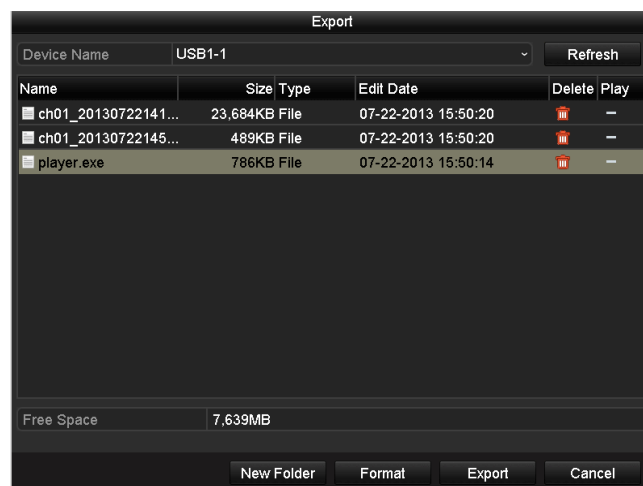

Figure 7. 19 Checkup of Video Clips Export Result Using USB Flash Drive

7.2 Backing up Pictures

Task 1: Back up Captured Pictures when Playback

Purpose:

Back up the pictures captured during playback.

Steps:

1. Enter Playback interface and start the playback. For details, see *Chapter 6.1*.



Figure 7.20 Interface of Playback by Time



2. In the playback process, click the icon  in the playback toolbar to capture the pictures.
3. Click the  button on the toolbar, select **Playback Capture** tab, and you can view and export the pictures captured when playback.



Figure 7.21 Captured Picture Export Interface

4. Refer to the steps 4~5 in Chapter 7.1.4 to export the pictures.

Task 2: Back up All Types of Captured Pictures

Purpose:

Back up pictures using USB devices (USB flash drives, USB HDDs, USB writer), DVD-R/W or eSATA HDD.

Steps:

1. Enter Picture Export interface.

Menu>Export>Picture

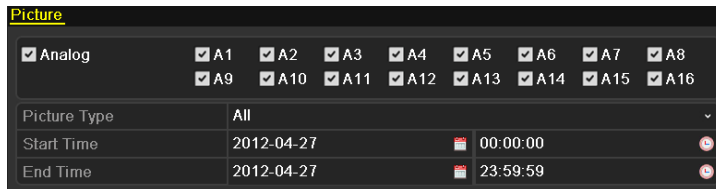

Figure 7.22 Picture Search for Backup in DVR Series

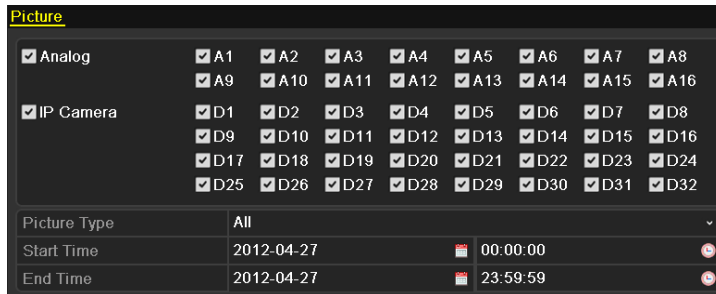

Figure 7.23 Picture Search for Backup in HDVR Series



Picture search for backup of **IP Camera** is supported by HDVR series only.

2. Set the search conditions and click the button **Search** to enter the search result interface.

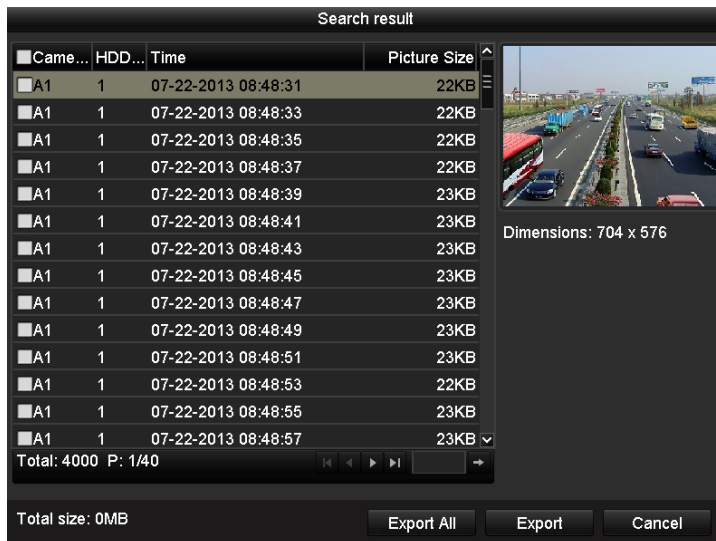

Figure 7.24 Result of Picture Search

3. Check the checkboxes to select pictures and click the button **Export** to enter the Export interface; or click

the button **Export All** to select all the pictures and enter the Export interface.



Here we take USB flash drive as an example. For more backup devices, see *Chapter 7.1.2*.



Figure 7.25 Export Pictures Using USB Flash Drive

4. Click the button **Export** on the Export interface to start the backup process. A prompt message will pop up after the backup process is complete

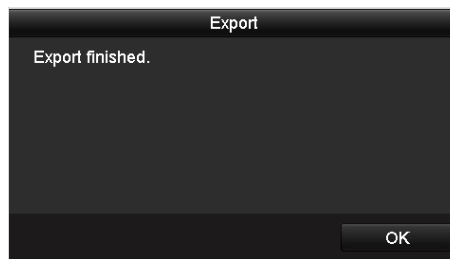

Figure 7.26 Export Finished

5. The exported pictures will be displayed in a list on the Export interface.

You can click to view the picture, or click to delete the picture.



Figure 7.27 Checkup of Picture Export Using USB Flash Drive

7.3 Managing Backup Devices



We use the interface of DS-9000HFI-RT series (unless otherwise stated) as example to describe the following settings.

Steps:

1. Enter the Export interface of backup device. For details, see *Chapter 7.1-7.2*.



Figure 7. 28 Management of USB Flash Drives, USB HDDs and eSATA HDDs

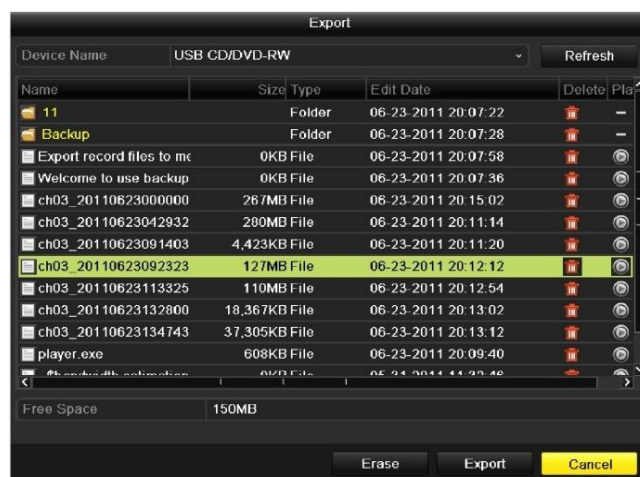

Figure 7. 29 Management of USB Writers and DVD-R/W

2. Select a record file/folder/picture in the backup device, click the icon and you can delete it. Select a record file/picture, click the icon , and then you can play and view the video/picture.

For USB Flash Drives, USB HDDs and eSATA HDDs:

Click the button **New Folder**, and you can create a new folder in the backup device.

Click the button **Format**, and you can format the backup device. Two kinds of file system can be configurable, including FAT32 and NTFS.

For USB Writers and DVD-R/W:

Click the button **Erase**, and you can erase the files from a re-writable CD/DVD.



If the inserted device is not recognized, you can perform the following steps:

- Click the button **Refresh**.
- Reconnect device.
- Check for compatibility from vendor.

7.4 Hot Spare Backup



This section is only applicable to the devices of HDVR series.

Before you start:

At least 2 devices are required to be online.

Purpose:

Several devices can form an N+1 hot spare system. The system consists of several working devices and a hot spare device; when the working device fails, the hot spare device is switched into operation, thus increasing the reliability of the system.

A bidirectional connection should be built for the working device and hot spare device.

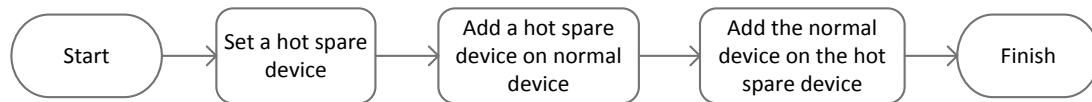

Figure 7. 30 Building Hot Spare System

7.4.1 Setting the Hot Spare Device



- The camera connection will be disabled when the device works in the hot spare mode.
- After switching the working mode of the hot spare device to normal mode, restore the defaults of the device to ensure the normal operation afterwards.

Steps:

1. Enter the Hot Spare Settings interface of the hot spare device.
Menu>Configuration>Hot Spare
2. Select **Hot Spare Mode** as the working mode.
3. Click the button **Apply** and reboot the device to activate the settings.

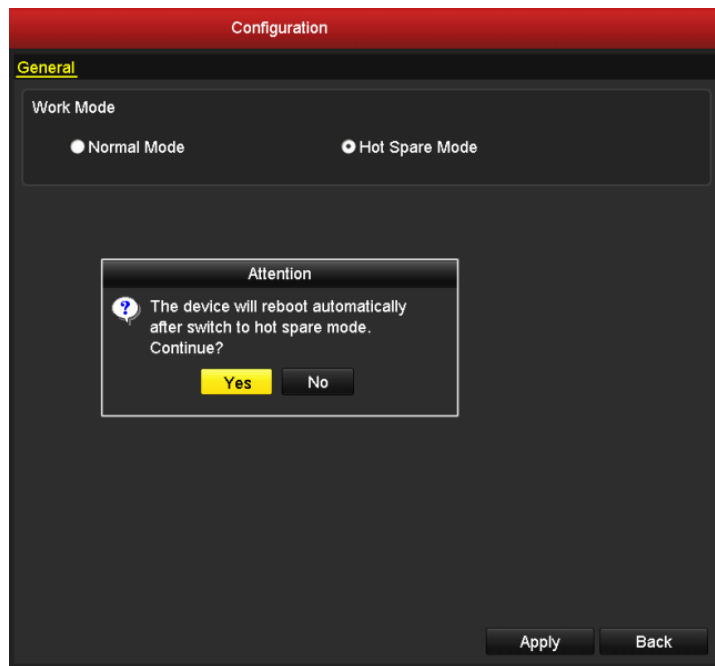

Figure 7. 31 Hot Spare Mode Settings

7.4.2 Setting the Working Device

Steps:

1. Enter the Hot Spare Settings interface of the working device.
Menu>Configuration>Hot Spare
2. Set the working mode of the device as Normal Mode (default).
3. Check the checkbox of **Enable**, input the IP address and administrator password of the hot spare device.
4. Click the button **Apply** to connect the hot spare device to the working device.

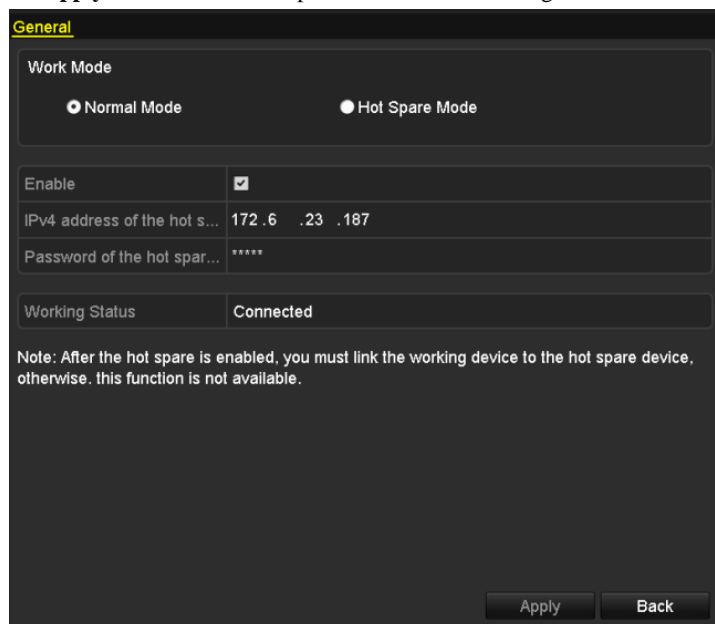

Figure 7. 32 Normal Mode Settings

7.4.3 Hot Spare Management

Steps:

1. Enter the Hot Spare Settings interface of the hot spare device again.
The connected working device is displayed on the device list. Check the checkbox to select the working device from the list, and click the button **Add** to link the working device to the hot spare device.



Up to 32 working devices can be linked to one hot spare device

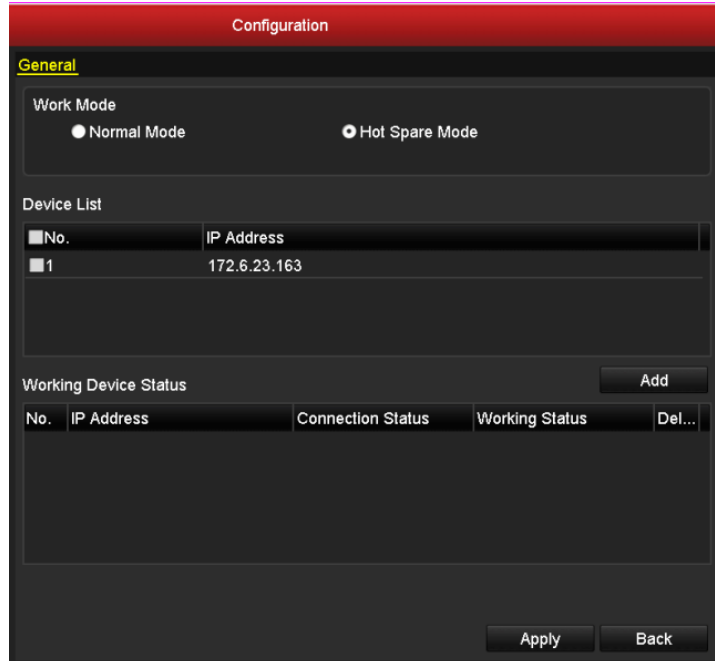

Figure 7.33 Link Working Device to Hot Spare Device

2. You can view the working status of the hot spare device on the Working Device Status list.
When the working device works properly, the working status of the hot spare is displayed as *No record*.

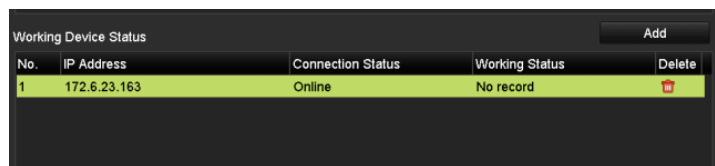

Figure 7.34 Working Status of Hot Spare Device-1

When the working device gets offline, the hot spare device will record the video of the IPCs connected to the working device for backup.

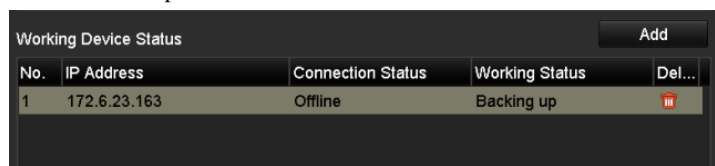

Figure 7.35 Working Status of Hot Spare Device-2

When the working device comes online, the lost video files will be restored by the record synchronization

function.

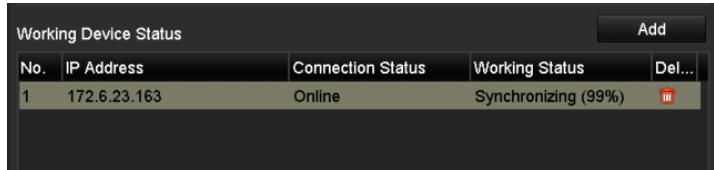

The record synchronization function can be enabled for up to 1 working device at a time.

A screenshot of a software window titled "Working Device Status". The window has a dark background and a light-colored header bar. In the top right corner of the header bar, there is a button labeled "Add". Below the header bar is a table with five columns: "No.", "IP Address", "Connection Status", "Working Status", and "Del...". The table contains one row of data.

No.	IP Address	Connection Status	Working Status	Del...
1	172.6.23.163	Online	Synchronizing (99%)	

Figure 7.36 Working Status of Hot Spare Device-3

Chapter 8 Alarm Settings

8.1 Setting Motion Detection



We use the interface of DS-9100HFI-ST series (unless otherwise stated) as example to describe the following settings.

Steps:

1. Enter Motion Detection interface and choose a camera you want to set motion detection.

Menu> Camera> Motion

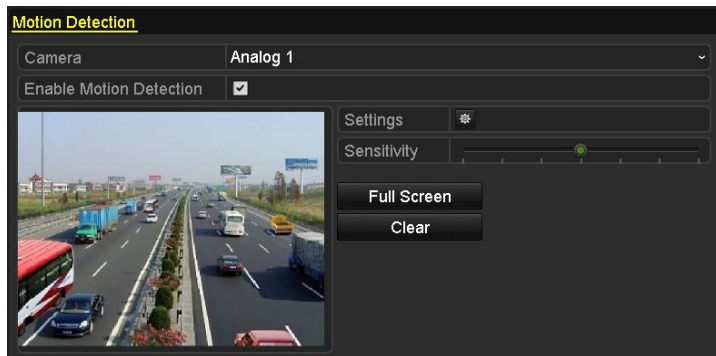

Figure 8. 1 Motion Detection Settings Interface

2. Set detection area and sensitivity.

Check checkbox to enable motion detection, use the mouse to draw detection area(s) and drag the sensitivity bar to set sensitivity.

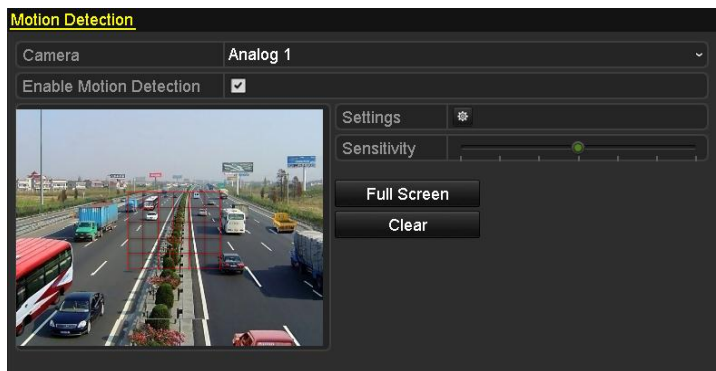

Figure 8. 2 Set Detection Area and Sensitivity

3. Click to configure the motion detection settings. Click **Trigger Channel** tab and select one or more channels which will start to record/capture or become full-screen monitoring when motion alarm is triggered. Click **Apply** to save the settings.

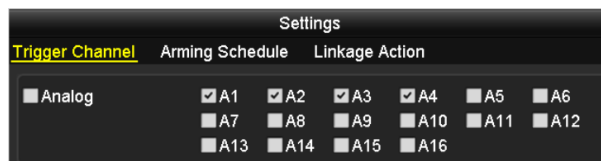

Figure 8. 3 Set Trigger Camera of Motion Detection for DVR Series

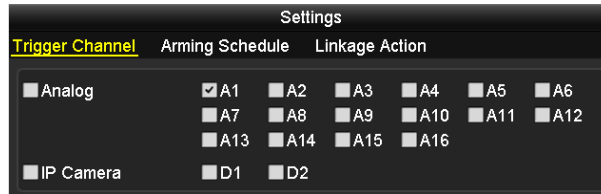

Figure 8. 4 Set Trigger Camera of Motion Detection for HDVR Series



Triggering **IP Camera** is supported by HDVR series only.

4. Set arming schedule of the channel.

Select **Arming Schedule** tab and set arming schedule of the channel.

Choose one day of a week and up to eight time periods can be set within each day. Set up arming schedule of other days of a week. You can also click the button **Copy** to copy an arming schedule to other days. Click **Apply** to save the settings.



Time periods cannot be repeated or overlapped.

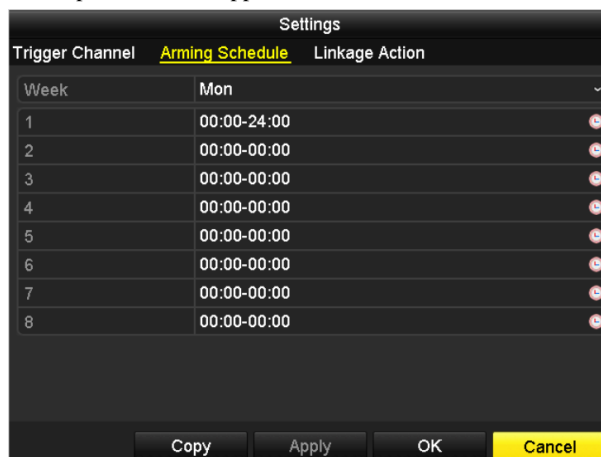

Figure 8. 5 Set Arming Schedule of Motion Detection

5. Click **Linkage Action** tab to set alarm linkage actions of motion detection (please refer to *Chapter 8.7*).

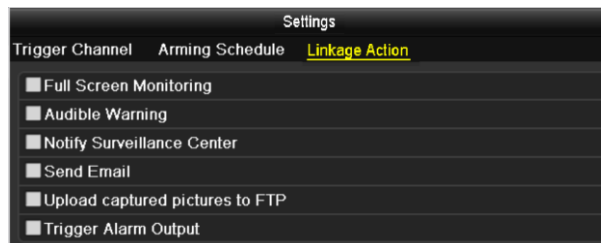

Figure 8. 6 Set Alarm Linkage Actions of Motion Detection



Upload captured pictures to FTP is only supported by DVR series.

Click **Apply** to save the settings. Click **OK** to complete the motion detection settings of the channel.

6. If you want to set motion detection for another channel, repeat the above steps or just click **Copy** in the Motion Detection interface to copy the above settings to it.



You are not allowed to copy the “Trigger Channel” action and motion detection settings to IP camera.

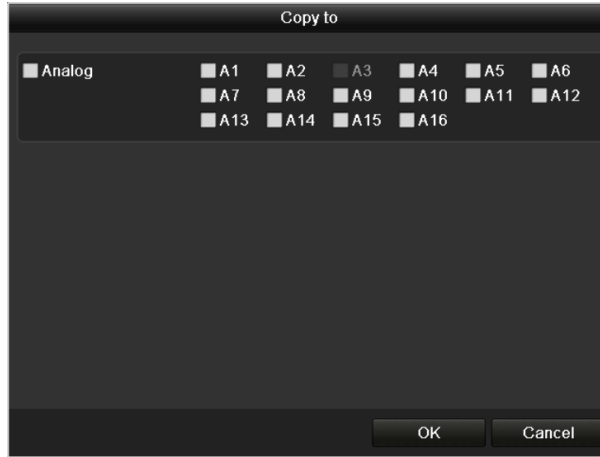

Figure 8. 7 Copy Settings of Motion Detection

8.2 Setting Sensor Alarm

Purpose:

You can set handling method of an external sensor alarm.



Sensor alarm is not supported by DS-7200HWI-SV series.

Steps:

1. Enter Alarm Settings interface and select an alarm input.

Menu> Configuration> Alarm

Alarm Status		
Alarm Input	Alarm Output	
Alarm Input List		
Alarm Input No.	Alarm Name	Alarm Type
Local-<1	1	N.C
Local-<2		N.O
Local-<3		N.O
Local-<4		N.O
Local-<5		N.O
Local-<6		N.O
Local-<7		N.O
Alarm Output List		
Alarm Output No.	Alarm Name	Dwell Time
Local->1		5s
Local->2		5s
Local->3		5s
Local->4		5s

Figure 8. 8 Alarm Status Interface

2. Select **Alarm Input** tab to enter Alarm Input Settings interface, edit the name for the alarm input and set the handling method of the selected alarm input.

Check checkbox to enable the alarm input and click to configure the alarm settings..

Alarm Status	
Alarm Input	Alarm Output
Alarm Input No.	Local-<1
Alarm Name	1
Type	N.C
Enable	<input checked="" type="checkbox"/>
Settings	

Figure 8. 9 Alarm Input Settings Interface

3. Select **Trigger Channel** tab and select one or more channels which will start to record/capture or become full-screen monitoring when an external alarm is input. Click **Apply** to save the settings.
4. Select **Arming Schedule** tab to set the channel's arming schedule.
Choose one day of a week and up to eight time periods can be set within each day. Set up arming schedule of other days of a week. You can also click **Copy** to copy an arming schedule to other days. Click **Apply** to save the settings.



Time periods cannot be repeated or overlapped.

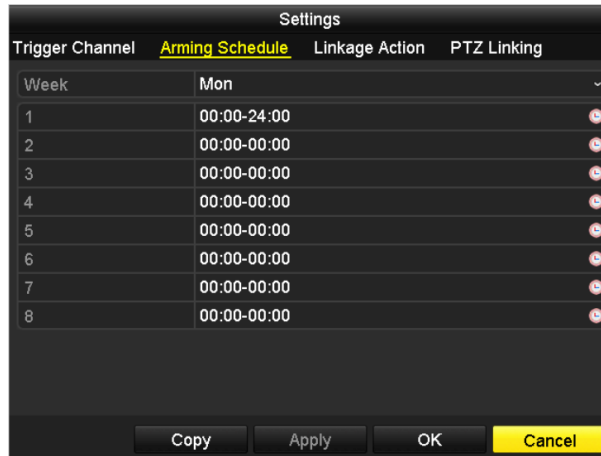

Figure 8. 10 Set Arming Schedule of Alarm Input

5. Select **Linkage Action** tab to set alarm linkage actions of the alarm input (please refer to *Chapter 8.7*).
6. If necessary, select **PTZ Linking** tab and set PTZ linkage of the alarm input.

Set PTZ linking parameters and click **Apply** to save the settings. Click **OK** to complete the settings of the alarm input.



Please check whether the PTZ or speed dome supports PTZ linkage.

One alarm input can trigger presets, patrol or pattern of more than one channel. But presets, patrols and patterns are exclusive.

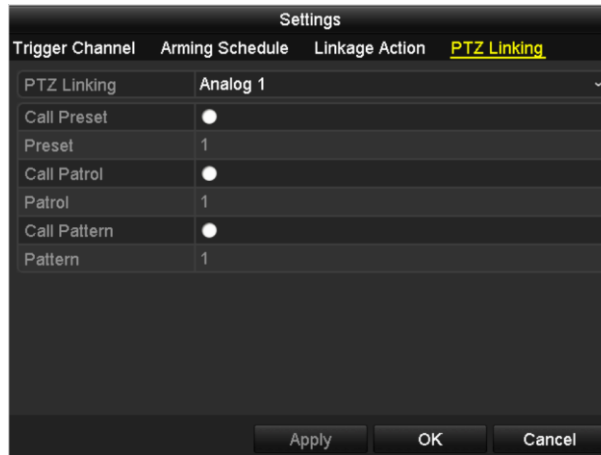

Figure 8. 11 Set PTZ Linking of Alarm Input

7. If you want to set alarm settings of another alarm input, repeat the above steps or just copy the above settings to it by clicking **Copy** in Alarm Input Settings interface.



Figure 8. 12 Copy Settings of Alarm Input

8.3 Setting VCA Alarm

Before you start:

Enable the VCA (Video Content Analysis) function and set the detection rules on the IP camera side. For details, see the user manual of IP camera.

Purpose:

The HDVR can receive the VCA alarm sent by smart IP cameras.



The VCA alarm settings are only supported by the HDVR series.

Steps:

1. Enter the VCA Alarm interface and choose a camera for the VCA settings.



The connected IP camera should support the VCA function.

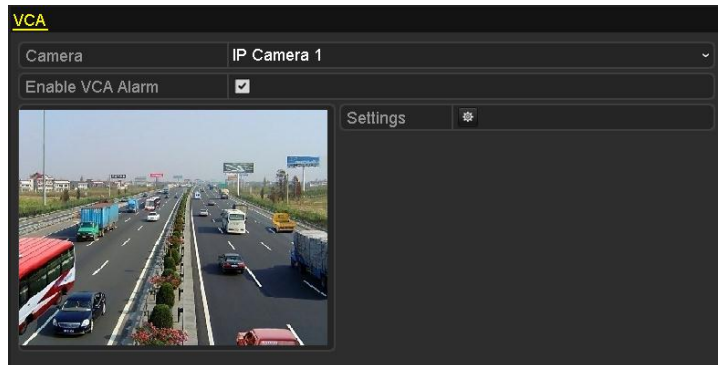



Figure 8. 13 VCA Alarm Settings Interface

2. Check the checkbox of **Enable VCA Alarm** to enable the VCA alarm function.
3. Click the icon  to configure the VCA settings.
Select **Trigger Channel** tab and select one or more channels which will start to record/capture or become full-screen monitoring when VCA alarm is triggered. Click **Apply** to save the settings.

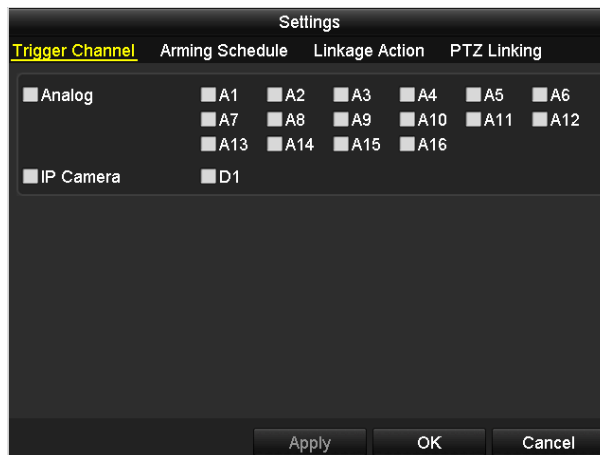

Figure 8. 14 Set Trigger Camera of VCA Alarm

4. Set arming schedule of the channel.

Select **Arming Schedule** tab and set arming schedule of the channel.

Choose one day of a week and up to eight time periods can be set within each day. Set up arming schedule of other days of a week. You can also click the button **Copy** to copy an arming schedule to other days. Click **Apply** to save the settings.



Time periods cannot be repeated or overlapped.

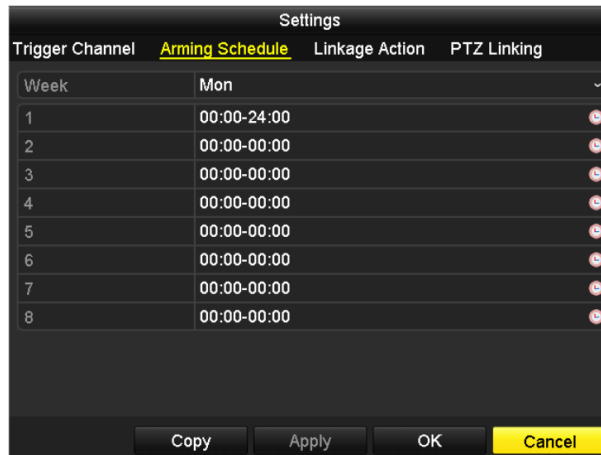

Figure 8. 15 Set Arming Schedule of VCA Alarm

5. Select **Linkage Action** tab to set alarm linkage actions of the VCA alarm (please refer to *Chapter 8.7*).

6. Select **PTZ Linking** tab, set PTZ linkage of the VCA alarm, and click **Apply** to save the settings.



Please check whether the PTZ or speed dome supports PTZ linkage.

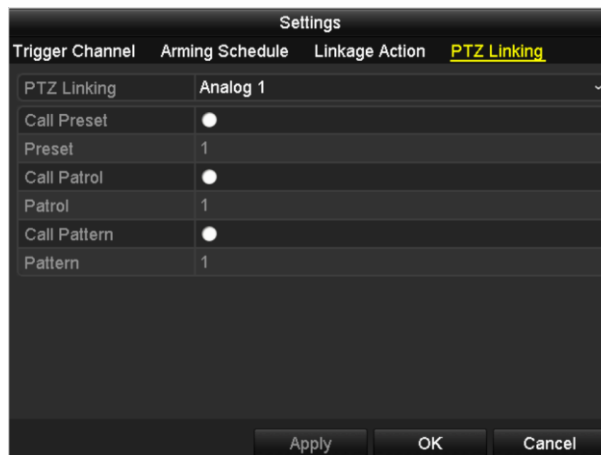

Figure 8. 16 Set PTZ Linking of VCA Alarm

7. Click **OK** to complete the settings of the VCA alarm.

8.4 Detecting Video Loss

Purpose:

Detect video loss of a channel and take alarm response action(s).

Steps:

1. Enter Video Loss interface and select a channel you want to detect.

Menu> Camera> Video Loss

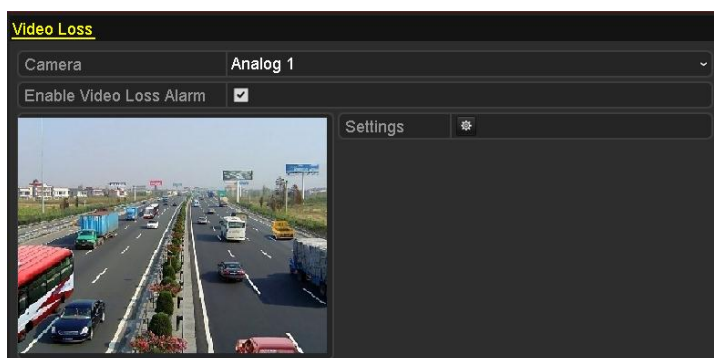



Figure 8.17 Video Loss Settings Interface

2. Set handling method of video loss.

Check checkbox to enable video loss alarm, and click  to set handling method of video loss.

3. Set arming schedule of the channel.

Select **Arming Schedule** tab to set the channel's arming schedule.

Choose one day of a week and up to eight time periods can be set within each day. Set up arming schedule of other days of a week. You can also use **Copy** to copy an arming schedule to other days. Click **Apply** to save the settings.



Time periods cannot be repeated or overlapped.

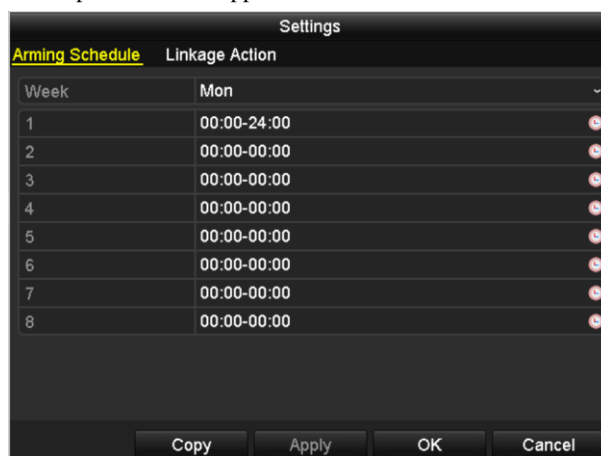

Figure 8.18 Set Arming Schedule of Video Loss

4. Select **Linkage Action** tab to set up alarm response action of video loss (please refer to *Chapter 8.7*). Click **Apply** to save the settings and click **OK** to complete the video loss settings of the channel.

5. If you want to set video loss handling method for another channel, repeat the above steps or just click **Copy** in Video Loss interface to copy the above settings to it.



Copying video loss settings to IP camera is not supported.



Figure 8. 19 Copy Settings of Video Loss

8.5 Detecting Video Tampering

Purpose:

Trigger alarm and take alarm response action(s) when the lens is covered.

Steps:

1. Enter Video Tampering interface and select a channel you want to detect video tampering.
Menu> Camera> Video Tampering

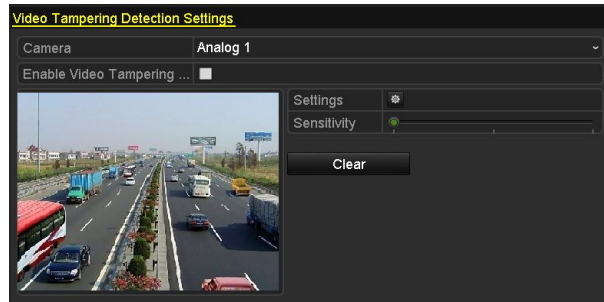



Figure 8.20 Video Tampering Detection Settings Interface

2. Set the video tampering handling method of the channel.
Check checkbox to enable detecting video tampering.
Drag the sensitivity bar and choose a proper sensitivity level. Use the mouse to draw an area you want to detect video tampering.
3. Click  to configure the video tampering settings. Set arming schedule and alarm linkage actions of the channel.
 - 1) Click **Arming Schedule** tab to set the channel's arming schedule.
 - 2) Choose one day of a week and up to eight time periods can be set within each day. Set up arming schedule of other days of a week. You can also click **Copy** to copy an arming schedule to other days. Click **Apply** to save the settings.



Time periods cannot be repeated or overlapped.

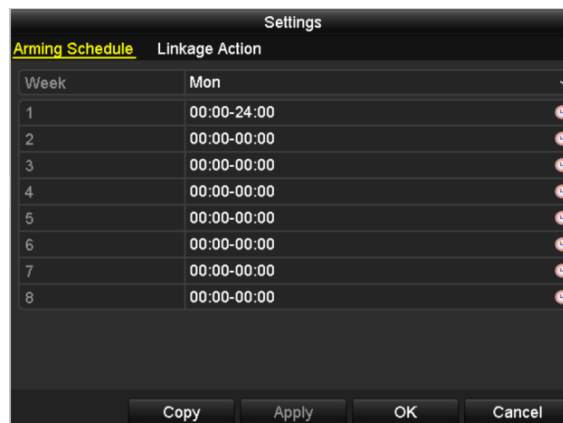

Figure 8.21 Set Arming Schedule of Video Tampering

4. Select **Linkage Action** tab to set alarm linkage actions of video tampering alarm. For details, see *Chapter 8.7*.

Click **Apply** to save the settings and click **OK** to complete the video tampering settings of the channel.

5. If you want to set up linkage actions of video tampering detection alarm for another channel, repeat step two and three, or just click **Copy** on Video Tampering Detection Settings interface to copy the above settings to it.



You cannot copy the video tampering settings to IP channels.



Figure 8. 22 Copy Settings of Video Tampering

8.6 Handling Exceptions

Purpose:



Exception settings refer to the handling method of various exceptions, e.g.

- **HDD Full:** The HDD is full.
- **HDD Error:** Writing HDD error, unformatted HDD, etc.
- **Network Disconnected:** Disconnected network cable.
- **IP Conflicted:** Duplicated IP address.
- **Illegal Login:** Incorrect user ID or password.
- **Video Signal Exception:** Unstable video signal.
- **Input / Output Video Standard Mismatch:** I/O video standards do not match.
- **Record / Capture Exception:** No space for saving recorded files or captured images.
- **Array Exception:** Abnormal virtual disks under array.
- **Hot Spare Exception:** For the working device, the exception occurs when the hot spare device is disconnected; for the hot spare device, the exception occurs when the working device is offline.



- Input / Output Video Standard Mismatch and Video Signal Exception are not supported by IP cameras of HDVR series.
- Array Exception is only supported by DS-9100/9000HFI-RT series.
- Hot Spare Exception is only supported by HDVR series.

Steps:

1. Enter Exceptions interface and handle various exceptions.
Menu> Configuration> Exceptions
2. Check the checkbox of **Enable Event Hint** to display the Event/Exception icon  when the exceptional event occurs. And click the icon  to select the detailed event hint for display.



Click the icon  appears in the live view interface, and you can view the detailed information of the exceptional event. Click the button **Set**, and then you can select the detailed event hint for display.

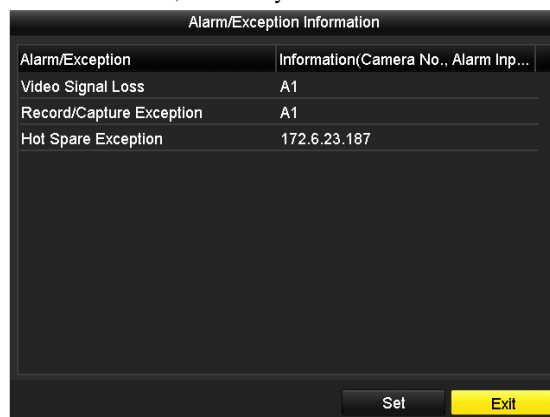

Figure 8. 23 Detailed Event

3. Set the alarm linkage actions. For details, see *Chapter 8.7*.
4. Click **Apply** to save the settings.



Figure 8. 24 Exception Settings Interface

8.7 Setting Alarm Linkage Actions

Purpose:

Alarm linkage actions will be activated when an alarm or exception occurs, including Full Screen Monitoring, Audible Warning (buzzer), Notify Surveillance Center, Send Email, Upload Captured Pictures to FTP (this function is supported by DVR series only) and Trigger Alarm Output (not supported by the DS-7200 series).

Full Screen Monitoring

When an alarm is triggered, the local monitor (HDMI, VGA or BNC monitor) display in full screen the video image from the alarming channel configured for full screen monitoring.

If alarms are triggered simultaneously in several channels, their full-screen images will be switched at an interval of 10 seconds (default dwell time). A different dwell time can be set by going to Menu > Configuration > Live View > Full Screen Monitoring Dwell Time.

Auto-switch will terminate once the alarm stops and you will be taken back to the Live View interface.



You must select during “Trigger Channel” settings the channel(s) you want to make full screen monitoring.

Audible Warning

Trigger an audible *beep* when an alarm is detected.

Notify Surveillance Center

Sends an exception or alarm signal to remote alarm host when an event occurs. The alarm host refers to the PC installed with Remote Client.



The alarm signal will be transmitted automatically at detection mode when remote alarm host is configured. Please refer to *Chapter 9.2.7* for details of alarm host configuration.

Send Email

Send an email with alarm information to a user or users when an alarm is detected.

Please refer to *Chapter 9.2.13* for details of Email configuration.

Upload Captured Pictures to FTP

Capture the image when an alarm is triggered and upload the picture to a FTP server.



This function is supported by DVR series only. Please set FTP address and configure the remote FTP server first. Refer to *Chapter 9.2.4* for FTP settings.

Trigger Alarm Output (not supported by DS-7200 series)

Trigger an alarm output when an alarm is triggered.

Steps:

1. Enter Alarm Output interface.

Menu> Configuration> Alarm> Alarm Output

Select an alarm output and set alarm name and dwell time.



If “Manually Clear” is selected in the drop-down list of Dwell Time, you can clear it only by going to Menu> Manual> Alarm and clicking **Clear All**.

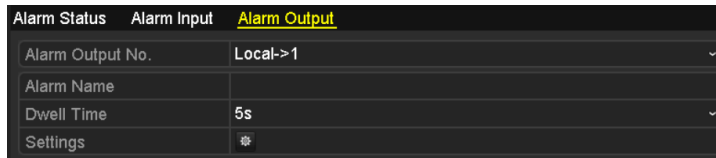

Figure 8. 25 Alarm Output Settings Interface

2. Set arming schedule of the alarm output.

Click to set the arming schedule of alarm output. Choose one day of a week and up to 8 time periods can be set within each day.



Time periods cannot be repeated or overlapped.

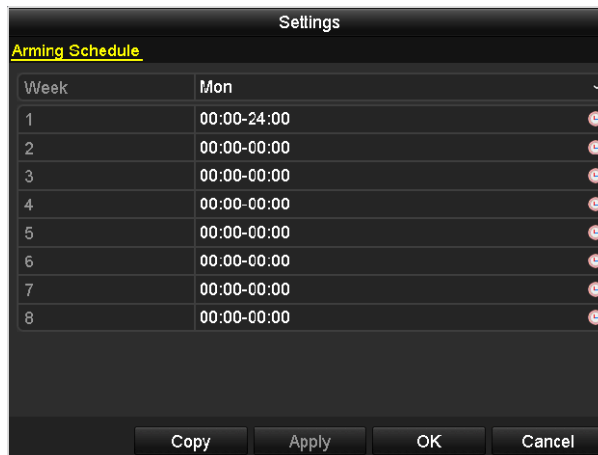

Figure 8. 26 Set Arming Schedule of Alarm Output

3. Repeat the above steps to set up arming schedule of other days of a week. You can also click **Copy** to copy an arming schedule to other days. Click **OK** to complete the settings of the alarm output.
4. You can also click **Copy** in Alarm Output interface to copy the above settings to another channel.

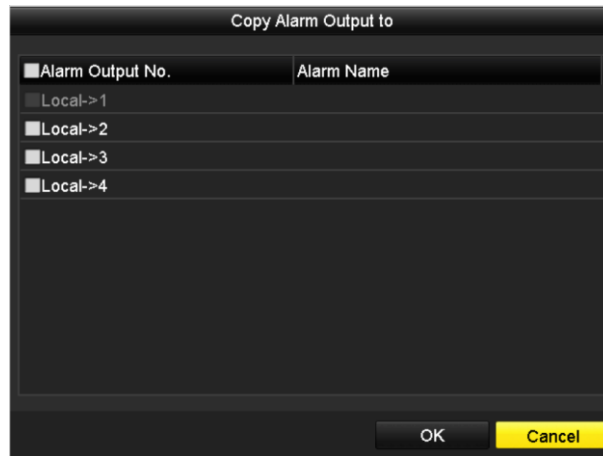

Figure 8. 27 Copy Settings of Alarm Output

8.8 Triggering or Clearing Alarm Output Manually

Purpose:

Sensor alarm can be triggered or cleared manually. If “Manually Clear” is selected in the drop-down list of dwell time of an alarm output, the alarm can be cleared only by clicking **Clear** button in the following interface.

Steps:

Select the alarm output you want to trigger or clear and make related operations.

Menu> Manual> Alarm

Click **Trigger** / **Clear** button if you want to trigger or clear an alarm output.

Click **Trigger All** button if you want to trigger all alarm outputs.

Click **Clear All** button if you want to clear all alarm output.

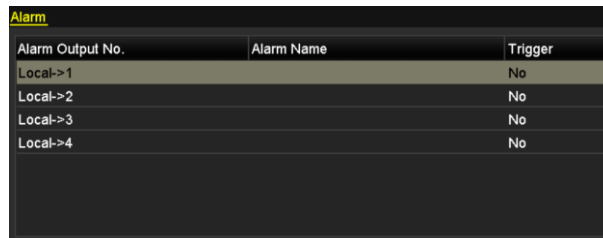

Alarm Output No.	Alarm Name	Trigger
Local->1		No
Local->2		No
Local->3		No
Local->4		No

Figure 8. 28 Clear or Trigger Alarm Output Manually

Chapter 9 Network Settings

9.1 Configuring General Settings

Purpose:

Network settings must be properly configured before you operate device over network.

Steps:

1. Enter the Network Settings interface.

Menu > Configuration > Network

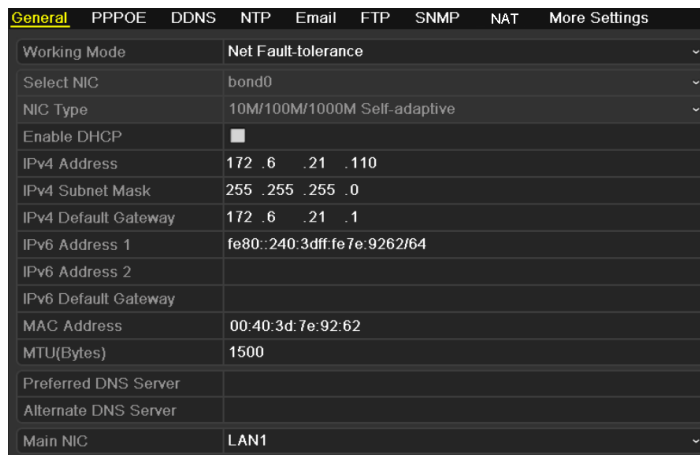

Figure 9.1 Network Settings Interface for DS-9200HWI-ST & DS-9100HFI-ST/RT/XT (HWI-ST) & DS-8100HFI(HWI)-ST

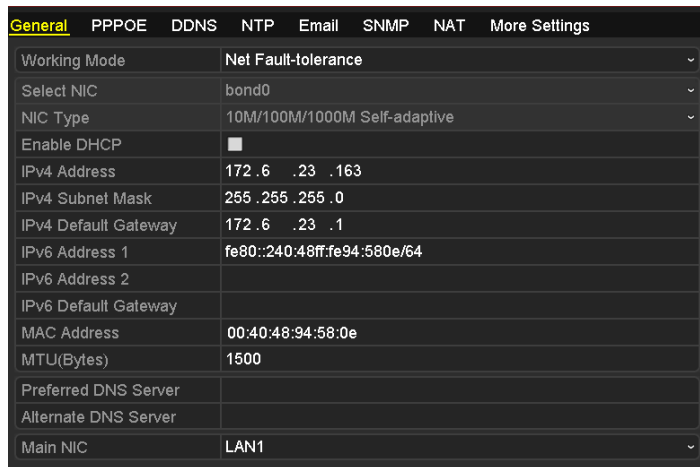

Figure 9.2 Network Settings Interface for DS-9000HFI-ST/RT/XT (HWI-ST) & DS-8000HFI(HWI)-ST

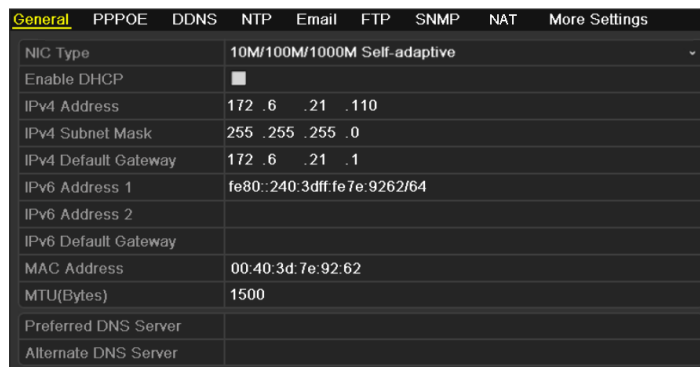

Figure 9.3 Network Settings Interface for DS-7200HWI-SV



In network settings interface: The FTP setting is supported by DVR series only. The Dual NIC (network interface card) is not supported by DS-7200HWI-SV series. We use the interface of DS-9100HFI-ST series (unless otherwise stated) as example to describe the following settings.

2. Select the **General** tab.

3. In the **General Settings** interface:

For DS-7200HWI-SV series, you can configure the following settings: NIC Type, IPv4 Address, IPv4 Subnet Mask, IPv4 Gateway, MTU and DNS Server.

For other series, you can configure the following settings: Working Mode, NIC Type, IPv4 Address, IPv4 Subnet Mask, IPv4 Gateway, MTU and DNS Server.

If the DHCP server is available, you can check the checkbox of **Enable DHCP** to automatically obtain an IP address and other network settings from that server.



The valid value range of MTU is 500 ~ 9676.

4. After having configured the general settings, click **Apply** to save the settings.

Working Mode: There are two 10M/100M/1000M NIC cards provided by the device, and it allows the device to work in the Multi-address, Load Balance and Net Fault-tolerance modes.

Multi-address Mode: The parameters of the two NIC cards can be configured independently. You can select LAN1 or LAN2 in Select NIC text field for parameter settings.

You can select one NIC card as default route. And when the system is connecting with the extranet the data will be forwarded through the default route.

Working Mode	Multi-address
Select NIC	LAN1
NIC Type	10M/100M/1000M Self-adaptive
Enable DHCP	<input type="checkbox"/>
IPv4 Address	172 .6 .21 .110
IPv4 Subnet Mask	255 .255 .255 .0
IPv4 Default Gateway	172 .6 .21 .1
IPv6 Address 1	fe80::240:48ff:fe72:cc85/64
IPv6 Address 2	
IPv6 Default Gateway	
MAC Address	00:40:48:72:cc:85
MTU(Bytes)	1500
Preferred DNS Server	
Alternate DNS Server	
Default Route	LAN1

Figure 9. 4 Multi-address Working Mode

Load Balance Mode: By using the same IP address, and two NIC cards share the load of the total bandwidth, which enables the system to provide two Gigabit network capacity.

Working Mode	Load Balance
Select NIC	bond0
NIC Type	10M/100M/1000M Self-adaptive
Enable DHCP	<input type="checkbox"/>
IPv4 Address	172 .6 .21 .110
IPv4 Subnet Mask	255 .255 .255 .0
IPv4 Default Gateway	172 .6 .21 .1
IPv6 Address 1	
IPv6 Address 2	
IPv6 Default Gateway	
MAC Address	00:40:48:72:cc:85
MTU(Bytes)	1500
Preferred DNS Server	
Alternate DNS Server	

Figure 9. 5 Load Balance Working Mode

Net Fault-tolerance Mode: The two NIC cards use the same IP address, and you can select the Main NIC to LAN1 or LAN2. By this way, in case of one NIC card failure, the device will automatically enable the other standby NIC card so as to ensure the normal running of the whole system.

Working Mode	Net Fault-tolerance
Select NIC	bond0
NIC Type	10M/100M/1000M Self-adaptive
Enable DHCP	<input type="checkbox"/>
IPv4 Address	172 .6 .21 .110
IPv4 Subnet Mask	255 .255 .255 .0
IPv4 Default Gateway	172 .6 .21 .1
IPv6 Address 1	fe80::240:3dff:fe7e:9262/64
IPv6 Address 2	
IPv6 Default Gateway	
MAC Address	00:40:3d:7e:92:62
MTU(Bytes)	1500
Preferred DNS Server	
Alternate DNS Server	
Main NIC	LAN1

Figure 9. 6 Net Fault-tolerance Working Mode

9.2 Configuring Advanced Settings



We use the interface of DS-9100HFI-ST series (unless otherwise stated) as example to describe the following settings.

9.2.1 Configuring PPPoE Settings

Purpose:

Your device also allows access by Point-to-Point Protocol over Ethernet (PPPoE).

Steps:

1. Enter the **Network Settings** interface.
Menu > Configuration > Network
2. Select the **PPPoE** tab to enter the PPPoE Settings interface.

Enable PPPOE	<input type="checkbox"/>
User Name	
Password	

Figure 9.7 PPPoE Settings Interface

3. Check checkbox to enable PPPoE.
4. Enter **User Name** and **Password** for PPPoE access.



The User Name and Password should be assigned by your ISP.

Enable PPPOE	<input checked="" type="checkbox"/>
User Name	test
Password	*****

Figure 9.8 PPPoE Settings Interface

5. Click **Apply** to save and exit the interface.
6. After successful settings, the system asks you to reboot the device to activate the new settings, and the PPPoE dial-up is automatically connected after reboot.
You can go to Menu > Maintenance > System Info > Network interface to view the status of PPPoE connection. Please refer to *Chapter 13.1.5 Viewing Network Information* for PPPoE status.

9.2.2 Configuring DDNS Settings

Purpose:

If your device is set to use PPPoE as its default network connection, you may set Dynamic DNS (DDNS) to be used for network access.

Prior registration with your ISP is required before configuring the system to use DDNS.

Steps:

1. Enter the Network Settings interface.
Menu > Configuration > Network
2. Select the **DDNS** tab to enter the DDNS Settings interface.

Enable DDNS	<input checked="" type="checkbox"/>
DDNS Type	IPServer
Server Address	
Device Domain Name	
User Name	
Password	
Confirm	

Figure 9.9 DDNS Settings Interface

3. Check checkbox to enable DDNS.
4. Select **DDNS Type**. Five different DDNS types are selectable: IPSEver, DynDNS, PeanutHull, NO-IP and HiDDNS.
 - **IPSEver:** Enter **Server Address** for IPSEver, and other fields are read only.



The **Server Address** should be the IP address of the PC that runs IPSEver.

Enable DDNS	<input checked="" type="checkbox"/>
DDNS Type	IPSEver
Server Address	172.5.22.122
Device Domain Name	
User Name	
Password	
Confirm	

Figure 9.10 IPSEver Settings Interface

- **DynDNS:**
 - 1) Enter **Server Address** for DynDNS (e.g. members.dyndns.org).
 - 2) In the **Device Domain Name** text field, enter the domain obtained from the DynDNS website.
 - 3) Enter the **User Name** and **Password** registered in the DynDNS website.

Enable DDNS	<input checked="" type="checkbox"/>
DDNS Type	DynDNS
Server Address	members.dyndns.org
Device Domain Name	123.dyndns.com
User Name	test
Password	*****
Confirm	*****

Figure 9.11 DynDNS Settings Interface

- **PeanutHull:** Enter **User Name** and **Password** obtained from the PeanutHull website, and other fields are read only.

Enable DDNS	<input checked="" type="checkbox"/>
DDNS Type	PeanutHull
Server Address	
Device Domain Name	
User Name	123_gicp.net
Password	*****
Confirm	*****

Figure 9.12 Peanut Hull Settings Interface

- **NO-IP:**

Enter the account information in the corresponding fields.

- 1) Enter **Server Address** for NO-IP.
- 2) In the **Device Domain Name** text field, enter the domain obtained from the NO-IP website (www.no-ip.com).
- 3) Enter the **User Name** and **Password** registered in the NO-IP website.

Enable DDNS	<input checked="" type="checkbox"/>
DDNS Type	NO-IP
Server Address	no-ip.org
Device Domain Name	123.no-ip.org
User Name	test
Password	*****
Confirm	*****

Figure 9.13 NO-IP Settings Interface

- **HiDDNS:** You need to enter the **Server Address** and **Device Domain Name** for HiDDNS, and other fields are read only.

- 1) Edit the **Server Address** of the HiDDNS server. By default, www.hik-online.com will be automatically available in the **Server Address** field when **HiDDNS** is selected.
- 2) Enter the **Device Domain Name**. You can register the device domain name in the HiDDNS server first and then enter the name to the **Device Domain Name** in the device; you can also enter the domain name directly on the device to create a new one.



If a new device domain name is defined in the device, it will replace the old one registered on the server.

Enable DDNS	<input checked="" type="checkbox"/>
DDNS Type	HiDDNS
Server Address	www.hik-online.com
Device Domain Name	intelligent
User Name	
Password	
Confirm	

Figure 9.14 HiDDNS Settings Interface

Register the device on the HiDDNS server.

- 1) Go to the HiDDNS website: www.hik-online.com.
- 2) Click [Register new user](#) to register an account if you do not have one and use the account to log in.

Figure 9.15 Register an Account

- 3) In the Device Management interface, click  to register the device.

Figure 9.16 Register the Device



The device name can only contain the lower-case English letter, numeric and '-'; and it must start with the lower-case English letter and cannot end with '-'.

Access the Device via Web Browser or Client Software

After having successfully registered the device on the HiDDNS server, you can access your device via web browser or Client Software with the **Device Domain Name (Device Name)**.

Task 1: Access the Device via Web Browser

Open a web browser, and enter `http://www.hik-online.com/alias` in the address bar. Alias refers to the **Device Domain Name** on the device or the **Device Name** on the HiDDNS server.

Example: `http://www.hik-online.com/dvr`



If you mapped the HTTP port on your router and changed it to port No. except 80, you have to enter `http://www.hik-online.com/alias:HTTP port` in the address bar to access the device. You can refer to *Chapter 9.2.6* for the mapped HTTP port No.

Task 2: Access the Devices via iVMS-4200

For iVMS-4200, in the Add Device window, select  **HIDDNS** and then edit the device information.

Nickname: Edit a name for the device as you want.

Server Address: `www.hik-online.com`

Device Domain Name: It refers to the **Device Domain Name** on the device or the **Device Name** on the HiDDNS server you created.

User Name: Enter the user name of the device. By default it is admin.

Password: Enter the password of the device. By default it is 12345.

Figure 9.17 Access Device via iVMS4200

5. Click **Apply** to save and exit the interface.

9.2.3 Configuring NTP Server Settings

Purpose:

A Network Time Protocol (NTP) Server can be configured on your device to ensure the accuracy of system date/time.

Steps:

1. Enter the Network Settings interface.
Menu > Configuration > Network
2. Select the **NTP** tab to enter the NTP Settings interface.

Enable NTP	<input checked="" type="checkbox"/>
Interval (min)	60
NTP Server	210.72.145.44
NTP Port	123

Figure 9.18 NTP Settings Interface

3. Check checkbox to enable NTP.
4. Configure the following NTP settings:
 - Interval:** Time interval between the two synchronizing actions with NTP server. The unit is minute.
 - NTP Server:** IP address of NTP server.
 - NTP Port:** Port of NTP server.
5. Click **Apply** to save and exit the interface.



The time synchronization interval can be set from 1 to 10080min, and the default value is 60min. If the device is connected to a public network, you should use a NTP server that has a time synchronization function, such as the server at the National Time Center (IP Address: 210.72.145.44). If the device is setup in a more customized

network, NTP software can be used to establish a NTP server used for time synchronization.

9.2.4 Configuring FTP Server Settings



FTP configuration is supported by DVR series only.

Purpose:

The FTP (File Transfer Protocol) can be configured on your device to realize dual-directional transmission of control files over Internet. And the captured pictures of device can be uploaded to FTP server as well.

Steps:

1. Enter the Network Settings interface.
Menu > Configuration > Network
2. Select the **FTP** tab to enter the FTP Settings interface.

FTP Server	Preferred FTP Server
Enable FTP	<input type="checkbox"/>
FTP Protocol	FTP
Server Address	
FTP Port	21
User Name	
Password	
Directory	Use Root Directory
Parent Directory	
Parent Directory Name	
Secondary Directory	
Secondary Directory Name	

Figure 9. 19 FTP Settings Interface

3. Select a FTP server. Preferred FTP Server and Alternate FTP Server are selectable.
4. Check checkbox to enable the FTP server.



When both two FTP servers are enabled and configured properly, once the preferred FTP server fails, the alternate FTP server will be used until the preferred FTP server resumes work.

5. Configure the FTP settings for preferred and alternate FTP server, including FTP protocol, server address, port, user name, password and the directory.

FTP Server	Preferred FTP Server
Enable FTP	<input checked="" type="checkbox"/>
FTP Protocol	FTP
Server Address	172.5.10.220
FTP Port	21
User Name	test
Password	*****
Directory	Use Parent Directory
Parent Directory	Use Device Name
Parent Directory Name	Embedded Net DVR
Secondary Directory	
Secondary Directory Name	

Figure 9. 20 Configure FTP Settings

FTP Protocol: Select the protocol for the FTP server. FTP and SFTP (Secure File Transfer Protocol) are available. For SFTP, the remote FTP server should support the SFTP protocol. It is a more secure way for file transmission by adopting the secure encryption method. However, due to the secure encryption method, the speed of the file transmission with SFTP protocol is much lower than that with FTP protocol.

Directory: In the **Directory** field, you can select the Root directory, Parent directory and secondary directory. When the Parent Directory is selected, you have the option to use the Device Name, Device No. or Device IP for the name of the directory, or you can customize the directory name; and the when the Secondary Directory is selected, you can use the Camera Name or Camera No. as the name of the directory, or you can customize the directory name.



If you want to modify the Device Name, Device No., Device IP or Camera Name, please enter the corresponding interface to modify.

6. Click **Apply** to save and exit the interface.



Please make sure the remote FTP server has been started up before setting the FTP parameters.

9.2.5 Configuring SNMP Settings

Purpose:

You can use SNMP protocol to get device status and parameters related information.

Steps:

1. Enter the Network Settings interface.
Menu > Configuration > Network
2. Select the **SNMP** tab to enter the SNMP Settings interface.

Enable SNMP	<input type="checkbox"/>
SNMP Version	V2
SNMP Port	161
Read Community	public
Write Community	private
Trap Address	
Trap Port	162

Figure 9. 21 SNMP Settings Interface

3. Check checkbox to enable SNMP.
4. Configure the SNMP settings.

Enable SNMP	<input checked="" type="checkbox"/>
SNMP Version	V2
SNMP Port	161
Read Community	public
Write Community	private
Trap Address	
Trap Port	162

Figure 9. 22 Configure SNMP Settings

5. Click **Apply** to save and exit the interface.



Before setting the SNMP, please download the SNMP software and manage to receive the device information via SNMP port. By setting the Trap Address, the device is allowed to send the alarm event and exception message to the surveillance center.

9.2.6 Configuring NAT Settings

Two ways are provided for port mapping to realize the remote access via the cross-segment network, UPnP™ and manual mapping.

- **UPnP™**

Purpose:

Universal Plug and Play (UPnP™) permits the device to discover the presence of other network devices on the network seamlessly and establish functional network services for data sharing, communications, etc. You can use the UPnP™ function to enable the fast connection of the device to the WAN via a router without port mapping.

Before you start:

Enable the UPnP™ function of the router to which your device is connected. When the network working mode of the device is set as multi-address, the Default Route of the device should be in the same network segment as that of the LAN IP address of the router.

Steps:

1. Enter the Network Settings interface.
Menu > Configuration > Network
2. Select the **NAT** tab to enter the UPnP™ interface.

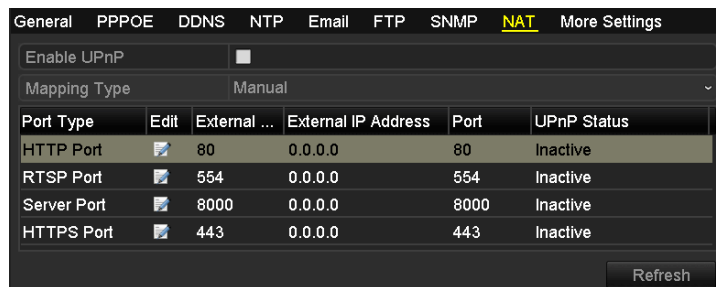

Figure 9.23 UPnP™ Settings Interface

3. Check checkbox to enable UPnP™.
4. Select the Mapped Type as Manual or Auto in the drop-down list.

Task1: Auto

If you select Auto, the Port Mapping items are read-only, and the external ports are set by the router automatically.

Steps:

- 1) Click **Apply** to save the settings.
- 2) You can click **Refresh** to get the latest status of the port mapping.

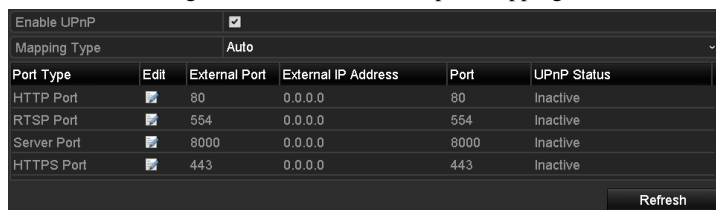



Figure 9.24 UPnP™ Settings Finished-Auto

Task2: Manual

If you select Manual as the mapping type, you can edit the external port on your demand by clicking  to activate the External Port Settings dialog box.

Steps:

- 1) Click  to activate the External Port Settings dialog box. Configure the external port No. for server port, http port, RTSP port and https port respectively.



- You can use the default port No., or change it according to actual requirements.
- External Port indicates the port No. for port mapping in the router.
- The value of the port No. should be between 1 and 65535 and the value must be different from each other. If multiple devices are configured for the UPnP™ settings under the same router, the value of the port No. for each device should be unique.

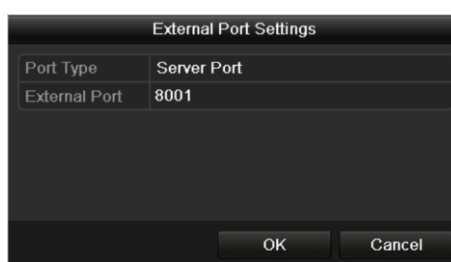

Figure 9.25 External Port Settings Dialog Box

- 2) Click **Apply** to save the settings.
- 3) You can click **Refresh** to get the latest status of the port mapping.

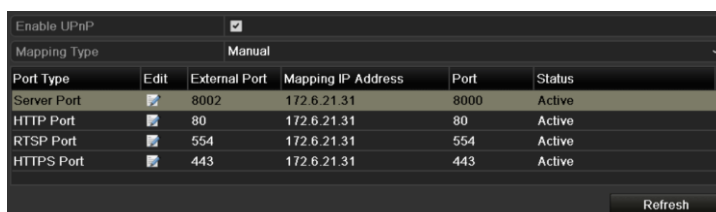

Figure 9.26 UPnP™ Settings Finished-Manual

- **Manual Mapping**

If your router does not support the UPnP™ function, perform the following steps to map the port manually in an easy way.

Before you start:

Make sure the router support the configuration of internal port and external port in the interface of Forwarding.

Steps:

1. Enter the Network Settings interface.
Menu > Configuration > Network
2. Select the NAT tab to enter the port mapping interface.
3. Leave the Enable UPnP checkbox unchecked.
4. Click  to activate the External Port Settings dialog box. Configure the external port No. for server port, http port, RTSP port and https port respectively.



The value of the RTSP port No. should be 554 or between 1024 and 65535, while the value of the other ports should be between 1 and 65535 and the value must be different from each other. If multiple devices are configured for the UPnP™ settings under the same router, the value of the port No. for each device should be unique.

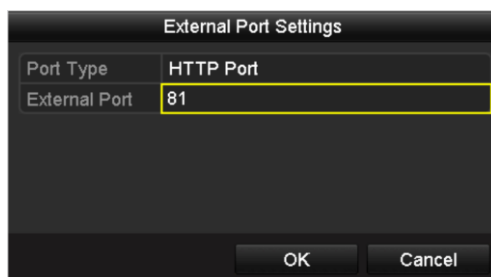

Figure 9. 27 External Port Settings Dialog Box

5. Click **OK** to save the setting for the current port and return to the upper-level menu.
6. Click **Apply** button to save the settings.
7. Enter the virtual server setting page of router. Input the internal port value in the Internal Source Port textfield, the external port value in the External Source Port textfield, and other required information.



Each item should be corresponding with the internal or external device port, including server port, http port, RTSP port and https port.

Delete	External Source Port	Protocol	Internal Source IP	Internal Source Port	Application
<input type="checkbox"/>	81	TCP	192.168.251.101	80	HTTP

Figure 9. 28 Setting Virtual Server Item



The above virtual server setting interface is for reference only, it may be different due to different router manufactures. Please contact the manufacturer of router if you have any problems with setting virtual server.

9.2.7 Configuring Remote Alarm Host Settings

Purpose:

With a remote alarm host configured, the device will send the alarm event or exception message to the host when an alarm is triggered. The remote alarm host must have the CMS (Client Management System) software installed.

Steps:

1. Enter the Network Settings interface.
Menu > Configuration > Network
2. Select the **More Settings** tab to enter the More Settings interface.

Alarm Host IP	
Alarm Host Port	0
Server Port	8000
HTTP Port	80
Multicast IP	
RTSP Port	554
Enable HTTPS	<input checked="" type="checkbox"/>
HTTPS Port	443
Enable High-speed Download	<input type="checkbox"/>

Figure 9.29 More Settings Interface

3. Enter **Alarm Host IP** and **Alarm Host Port** in the text fields.

The **Alarm Host IP** refers to the IP address of the remote PC on which the CMS (Client Management System) software (e.g., iVMS-4200) is installed, and the **Alarm Host Port** must be the same as the alarm monitoring port configured in the software.

Alarm Host IP	172.6.21.58
Alarm Host Port	7200
Server Port	8000
HTTP Port	80
Multicast IP	
RTSP Port	554
Enable HTTPS	<input checked="" type="checkbox"/>
HTTPS Port	443
Enable High-speed Download	<input type="checkbox"/>

Figure 9.30 Configure Alarm Host

4. Click **Apply** to save and exit the interface.

9.2.8 Configuring Multicast Settings

Purpose:

The multicast can be configured to realize live view for more than 128 cameras through network.

A multicast address spans the Class-D IP range of 224.0.0.0 to 239.255.255.255. It is recommended to use the IP address ranging from 239.252.0.0 to 239.255.255.255.

Steps:

1. Enter the Network Settings interface.
Menu > Configuration > Network
2. Select the **More Settings** tab to enter the More Settings interface.
3. Set **Multicast IP**. When adding a device to the CMS (Client Management System) software, the multicast address must be the same as the device's multicast IP.

Alarm Host IP	172.6.21.58
Alarm Host Port	7200
Server Port	8000
HTTP Port	80
Multicast IP	239.255.235.112
RTSP Port	554
Enable HTTPS	<input checked="" type="checkbox"/>
HTTPS Port	443
Enable High-speed Download	<input type="checkbox"/>

Figure 9.31 Configure Multicast

4. Click **Apply** to save and exit the interface.

9.2.9 Configuring RTSP Settings

Purpose:

The RTSP (Real Time Streaming Protocol) is a network control protocol designed for use in entertainment and communications systems to control streaming media servers.

Steps:

1. Enter the Network Settings interface.
Menu > Configuration > Network
2. Select the **More Settings** tab to enter the More Settings menu.

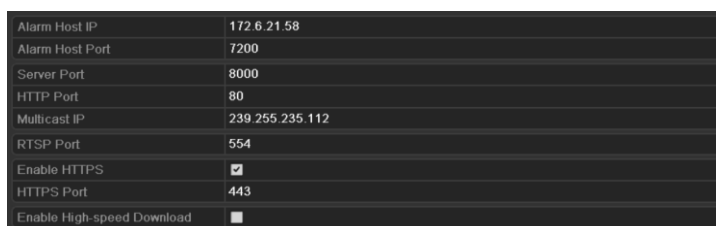

Figure 9.32 RTSP Settings Interface

3. Enter the RTSP port in the text field of **RTSP Service Port**. The default RTSP port is 554, and you can change it according to different requirements.
4. Click **Apply** to save and exit the menu.

9.2.10 Configuring Server and HTTP Ports Settings

Purpose:

You can change the server and HTTP ports in the Network Settings menu. The default server port is 8000 and the default HTTP port is 80.

Steps:

1. Enter the Network Settings interface.
Menu > Configuration > Network
2. Select the **More Settings** tab to enter the More Settings interface.
3. Enter new **Server Port** and **HTTP Port**.

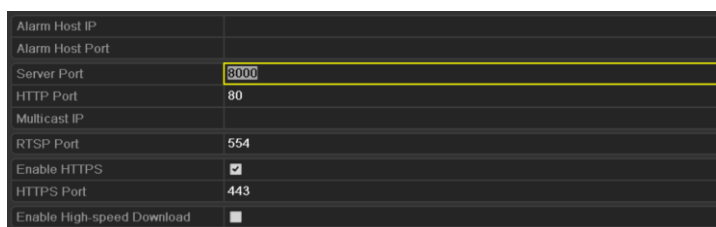

Figure 9.33 HTTP & Server Port Settings Interface

4. Enter the **Server Port** and **HTTP Port** in the text fields. The default Server Port is 8000 and the HTTP Port is 80, and you can change them according to different requirements.
5. Click **Apply** to save and exit the interface.



The Server Port should be set to the range of 2000-65535 and it is used for remote client software access. The HTTP port is used for remote IE access.

9.2.11 Configuring HTTPS Settings

Purpose:

HTTPS (Hyper Text Transfer Protocol Secure) ensures the data transferred is encrypted using Secure Socket Layer (SSL) or Transport Layer Security (TLS). HTTPS provides authentication of the web site and associated web server that one is communicating with and creates a secure channel over an insecure network.

HTTPS URLs begin with *https://* and use port 443 by default. You can modify the port No. as desired.

Example:

If you set the port No. as 445 and the IP address of the device is 192.0.0.64, you can access the device by inputting *https://192.0.0.64:445* in the web browser.

Steps:

1. Access the device via the web browser and enter the HTTPS settings interface.
Configuration > Remote Configuration > Network Settings > HTTPS
2. Create the self-signed certificate or authorized certificate.

Figure 9. 34 HTTPS Settings

OPTION 1: Create the self-signed certificate

- 1) Click the **Create** button and a dialog box pops up as follows:

Figure 9. 35 Create Self-signed Certificate

- 2) Enter the country, host name/IP, validity and other information.
- 3) Click **OK** to save the settings.

OPTION 2: Create the authorized certificate

- 1) Click the **Create** button to create the certificate request.
 - 2) Download the certificate request and submit it to the trusted certificate authority for signature.
 - 3) After receiving the signed valid certificate, import the certificate to the device.
3. The certificate information will be displayed after you successfully created and installed the certificate.

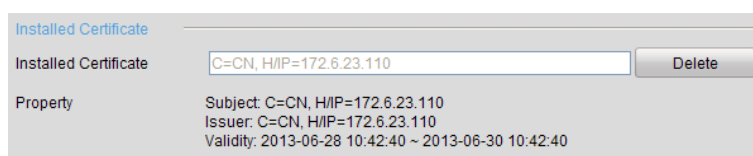

Figure 9.36 Installed Certificate Property

4. Check the checkbox to enable the HTTPS function.



The HTTPS Port should be set to the range of 1-65535.

9.2.12 Configuring High-speed Download Settings

Purpose:

You can enable the High-speed Download function to widen the outgoing bandwidth of the device. In this way you can speed up the download of record files through web browser or CMS software.



If you enable the high-speed download function, the local menu operation will be affected. It is recommended to disable this function after finishing the remote download of record files.

Steps:

1. Enter the Network Settings interface.
Menu > Configuration > Network
2. Select the **More Settings** tab to enter the More Settings interface.

Alarm Host IP	
Alarm Host Port	0
Server Port	8000
HTTP Port	80
Multicast IP	
RTSP Port	554
Enable HTTPS	<input checked="" type="checkbox"/>
HTTPS Port	443
Enable High-speed Download	<input type="checkbox"/>

Figure 9.37 High-speed Download Settings

3. Check checkbox to enable the High-speed Download and the following message box pops up. Click **OK** to confirm the settings



If you enable the high-speed download function, the local menu operation will be affected. It is recommended to disable this function after finishing the remote download of record files.

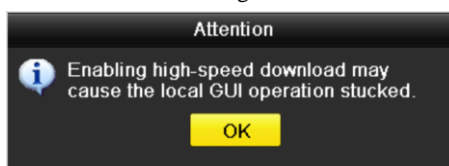

Figure 9.38 Message Box for High-speed Download

4. Click **Apply** to save the settings.

9.2.13 Configuring Email Settings

Purpose:

The system can be configured to send an Email notification to all designated users if an alarm event is detected, a motion detection event is detected, etc.

Before you start:

The device must be connected to a local area network (LAN) that maintains an SMTP mail server. The network must also be connected to either an intranet or the Internet depending on the location of the email accounts to which you want to send notification.

Steps:

1. Enter the Network Settings interface.
Menu > Configuration > Network
2. Set the IPv4 Address, IPv4 Subnet Mask, IPv4 Gateway and the Preferred DNS Server in the Network Settings interface.

Working Mode	Net Fault-tolerance
Select NIC	bond0
NIC Type	10M/100M/1000M Self-adaptive
Enable DHCP	<input type="checkbox"/>
IPv4 Address	172 .6 .21 .110
IPv4 Subnet Mask	255 .255 .255 .0
IPv4 Default Gateway	172 .6 .21 .1
IPv6 Address 1	fe80::240:3dff:fe7e:9262/64
IPv6 Address 2	
IPv6 Default Gateway	
MAC Address	00:40:3d:7e:92:62
MTU(Bytes)	1500
Preferred DNS Server	192.0.0.200
Alternate DNS Server	
Main NIC	LAN1

Figure 9.39 Network Settings Interface

3. Click **Apply** to save the settings.
4. Select the **Email** tab to enter the Email Settings interface.

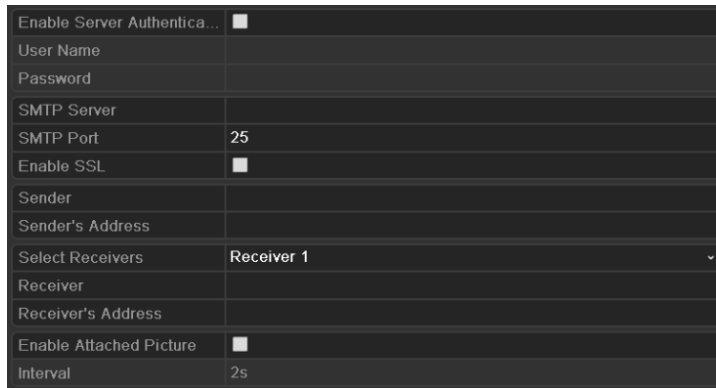

Figure 9. 40 Email Settings Interface

5. Configure the following Email settings:

Enable Server Authentication (optional): If your mail server requires authentication, check this checkbox to use authentication to log in to this server and enter the login User Name and Password.

User Name: The user account of sender's Email for SMTP server authentication.

Password: The password of sender's Email for SMTP server authentication.

SMTP Server: The SMTP Server IP address or host name (e.g., smtp.263xmail.com).

SMTP Port: The SMTP port. The default TCP/IP port used for SMTP is 25.

Enable SSL (optional): Check the checkbox to enable SSL if required by the SMTP server.

Sender: The name of sender.

Sender's Address: The Email address of sender.

Select Receivers: Select the receiver. Up to 3 receivers can be configured.

Receiver: The name of user to be notified.

Receiver's Address: The Email address of user to be notified.

Enable Attached Pictures: Check the checkbox of **Enable Attached Picture** if you want to send email with attached alarm images.

Interval: The interval refers to the time between two actions of sending attached pictures.

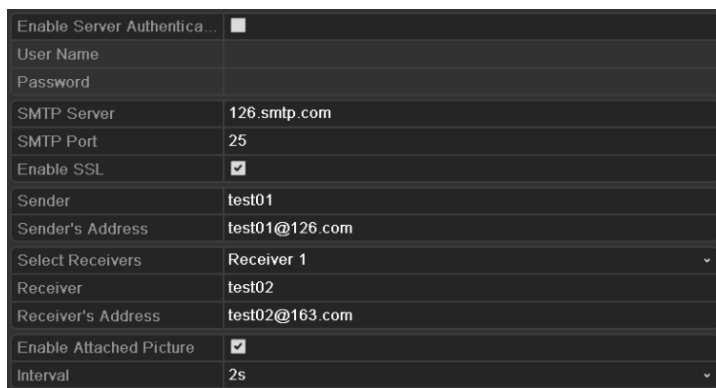

Figure 9. 41 Configure Email Settings

6. Click **Apply** to save the Email settings.

7. You can click **Test** to test whether your Email settings work. The corresponding Attention message box will pop up.

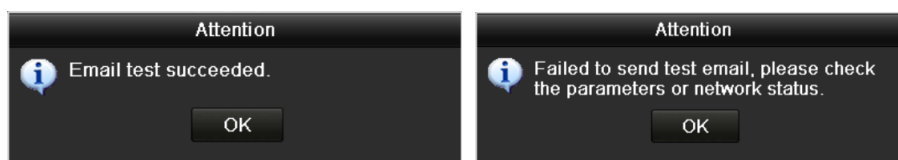

Figure 9.42 Email Testing Attention

9.2.14 Virtual Host Settings

Purpose:

You can directly get access to the IP camera management interface from the HDVR management interface.



- The Virtual host function is only supported by the HDVR series.
- You can only configure the virtual host settings through the web browser.

Steps:

1. Enter the Advanced settings interface.

Configuration > Remote Configuration > Network Settings > Advanced

Figure 9.43 Advanced Settings Interface

2. Check the checkbox of the **Enable Virtual Host**.
3. Click the **Save** button to save the setting.
4. Enter the IP camera management interface of HDVR. The Connect column appears on the right-most side of the camera list.

Configuration > Remote Configuration > Camera Management > IP Camera

Channel No.	IP Camera Address	Channel No.	Management Port	Status	Protocol	Connect
<input type="checkbox"/> D01	172.6.23.123	1	8000	Online	HIKVISION	http://172.6.23.123:80

Figure 9.44 Accessing IP Camera

5. Click the link to go to the management page of the selected IP camera.

9.2.15 Telnet Settings

Purpose:

Telnet function provides an easy way to get access to the DVR/HDVR. You can see the advanced information about the device by inputting command; as well the configuration can also be realized through telnet connection.

Steps:

1. Enter the Advanced settings interface.

Configuration > Remote Configuration > Network Settings > Advanced

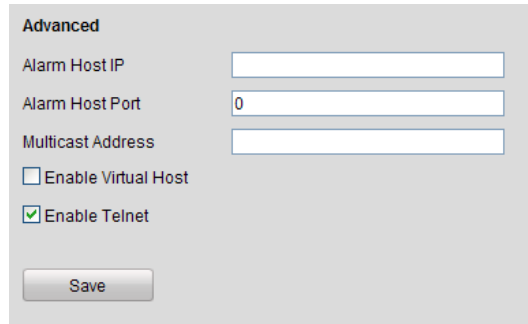

Figure 9. 45 Advanced Settings Interface

2. Check the checkbox of the **Enable Telnet**.
3. Click the **Save** button to save the setting.
4. You can open the Command Prompt window in your PC, and input “telnet IP Address” to connect with the DVR, as shown in the figure below.

Example:

The IP address of the DVR is 192.0.0.64, you can input “telnet 192.0.0.64” and then press Enter to connect to the DVR.

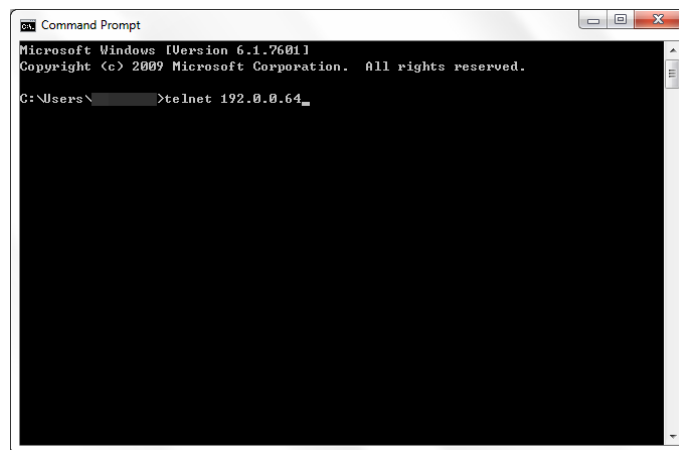

Figure 9. 46 Connect to DVR

9.3 Checking Network Traffic

Purpose:

You can check the network traffic to obtain real-time information of device such as linking status, MTU, sending/receiving rate, etc.

Steps:

1. Enter the Network Traffic interface.

Menu > Maintenance > Net Detect

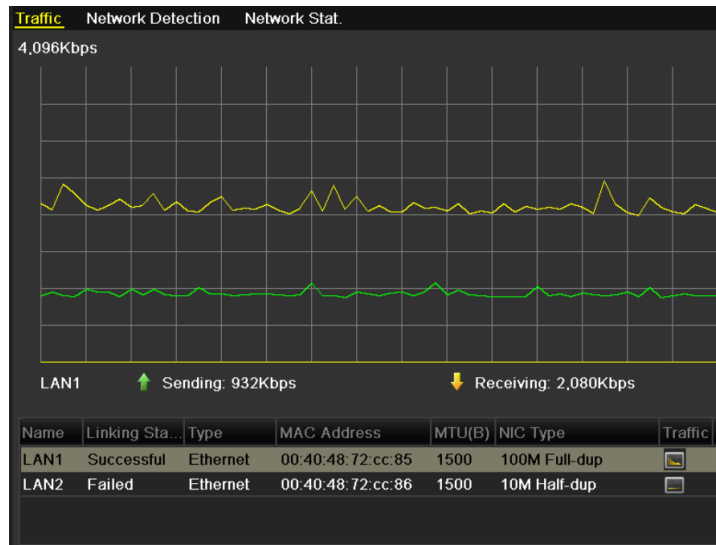

Figure 9.47 Network Traffic Interface

2. You can view the sending rate and receiving rate information on the interface. The traffic data is refreshed every 1 second.

9.4 Network Detection

Purpose:

You can obtain network connecting status of device through the network detection function, including network delay, packet loss, etc.

9.4.1 Testing Network Delay and Packet Loss

Steps:

1. Enter the Network Detection interface.
Menu > Maintenance > Net Detect
2. Click the **Network Detection** tab to enter the Network Detection menu.

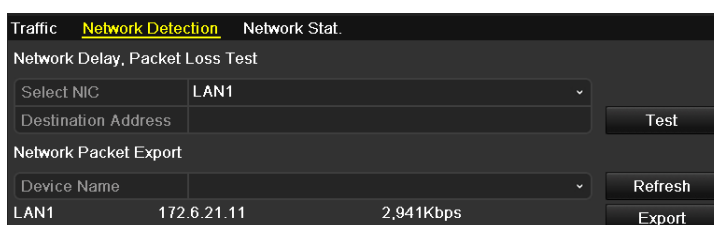

Figure 9. 48 Network Detection Interface for DS-7200HWI-SV Series

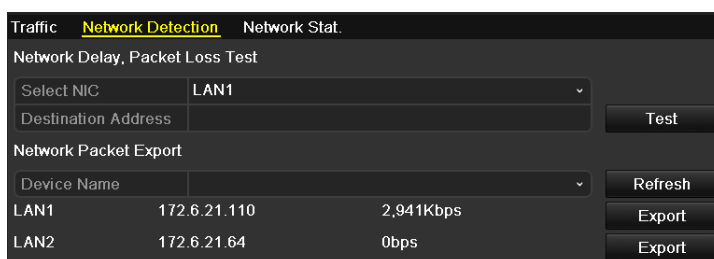

Figure 9. 49 Network Detection Interface for Other Series



Dual NIC is not supported by DS-7200HWI-SV series. We use the interface of DS-9100HFI-ST series (unless otherwise stated) as example to describe the following settings.

3. Select a NIC to test network delay and packet loss.
4. Enter the destination address in the text field of **Destination Address**.
5. Click **Test** to start testing network delay and packet loss. The testing result pops up on the window. If the testing is failed, the error message box will pop up as well.

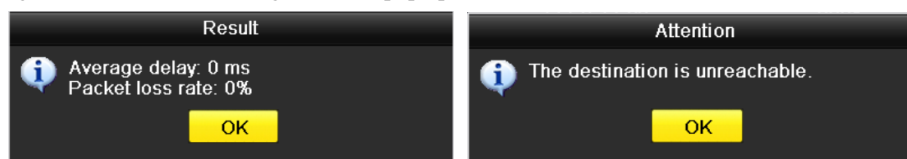

Figure 9. 50 Testing Result of Network Delay and Packet Loss

9.4.2 Exporting Network Packet

Purpose:

By connecting the device to network, the captured network data packet can be exported to USB-flash disk, SATA/eSATA DVD-R/W and other local backup devices.



Dual NIC is not supported by DS-7200HWI-SV series. We use the interface of DS-9100HFI-ST series (unless otherwise stated) as example to describe the following settings.

Steps:

1. Enter the Network Traffic interface.
Menu > Maintenance > Net Detect
2. Click the **Network Detection** tab to enter the Network Detection interface.
3. Select the backup device from the drop-down list of Device Name.



Click **Refresh** if the connected local backup device cannot be displayed. When it fails to detect the backup device, please check whether it is compatible with the device. You can format the backup device if the format is incorrect.

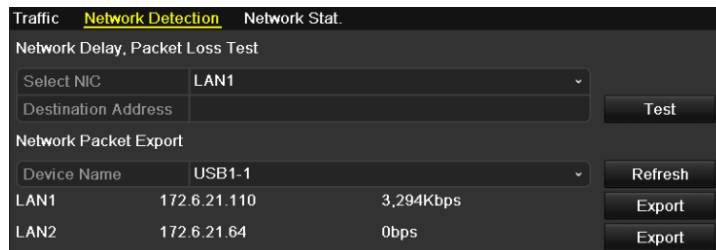

Figure 9.51 Export Network Packet

4. Click **Export** to start exporting.
5. After the exporting is complete, click **OK** to finish the packet export.



Figure 9.52 Packet Export Attention



Up to 1M data can be exported each time.

9.4.3 Checking Network Status

Purpose:

You can also check the network status and quick set the network parameters in this interface.



Dual NIC is not supported by DS-7200HWI-SV series. We use the interface of DS-9100HFI-ST series (unless otherwise stated) as example to describe the following settings.

Steps:

1. Enter the Network Traffic interface.
Menu > Maintenance > Net Detect
2. Click the **Network Detection** tab to enter the Network Detection interface.
3. Click **Status** to get the network status.

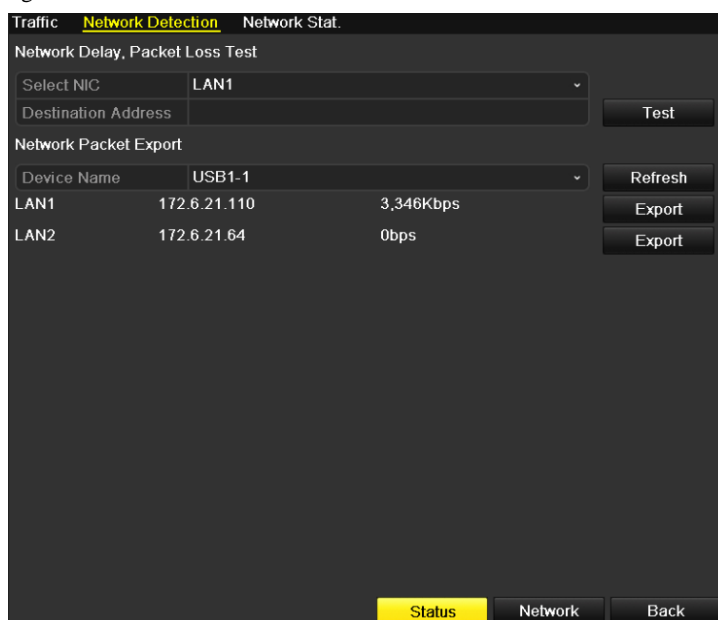

Figure 9.53 Checking Network Status

If the network is normal the following message box pops out.

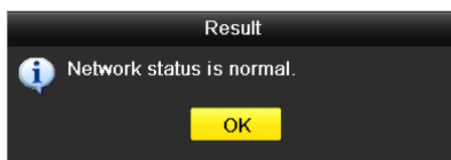

Figure 9.54 Network Status Checking Result

If the message box pops out with other information instead of this one, you can click **Network** to show the quick setting interface of the network parameters.

Network	
Working Mode	Multi-address
Select NIC	LAN1
NIC Type	10M/100M/1000M Self-adaptive
Enable DHCP	<input type="checkbox"/>
IPv4 Address	172 .6 .21 .110
IPv4 Subnet Mask	255 .255 .255 .0
IPv4 Default Gateway	172 .6 .21 .1
Preferred DNS Server	
Alternate DNS Server	
Default Route	LAN1
<input type="button" value="Apply"/> <input type="button" value="OK"/> <input type="button" value="Cancel"/>	

Figure 9.55 Network Parameters Configuration

9.4.4 Checking Network Statistics

Purpose:

You can check the network statistics to obtain the real-time information of the device.

Steps:

1. Enter the Network Statistics interface.
Menu > Maintenance > Net Detect
2. Click the **Network Stat.** tab to enter the Network Statistics interface.

Type	Bandwidth
IP Camera	5,120Kbps
Remote Live View	11Mbps
Remote Playback	0bps
Net Receive Idle	75Mbps
Net Send Idle	149Mbps

Figure 9.56 Network Stat. Interface

3. View the bandwidth of IP Camera, bandwidth of Remote Live View, bandwidth of Remote Playback, bandwidth of Net Receive Idle and bandwidth of Net Send Idle.



- The bandwidth of IP Camera is only displayed in HDVR series.
 - The value of the bandwidth is subject to the actual model.
4. Click **Refresh** to get the latest bandwidth statistics.

Chapter 10 RAID Configuration



This chapter is available for DS-9100/9000HFI-RT series only. For the configuration for alarm linkage actions of array exception, please refer to *Chapter 8.6* and *Chapter 8.7*.

10.1 Configuring Array and Virtual Disk

Purpose:

RAID (redundant array of independent disks) is a storage technology that combines multiple disk drive components into a logical unit. A RAID setup stores data over multiple hard disk drives to provide enough redundancy so that data can be recovered if one disk fails. Data is distributed across the drives in one of several ways called "RAID levels", depending on what level of redundancy and performance is required. The DS-9000/9100HFI-RT is capable of realizing RAID settings, supporting RAID 0, RAID 1, RAID 5 and RAID 10.

Before you start:

Please install the HDD(s) properly and it is recommended to use the same enterprise-level HDDs (including model and capacity) for array creation and configuration so as to maintain reliable and stable running of the disks.

Introduction:

The DS-9000/9100HFI-RT series can store the data (such as record, picture, log information) in the HDD only after you have created the virtual disk or you have configured network HDD (refer to *Chapter 11.2 Managing Network HDD*). Our device provides two ways for creating the virtual disk, including one-touch configuration and manual configuration. The following flow chart shows the process of creating virtual disk.

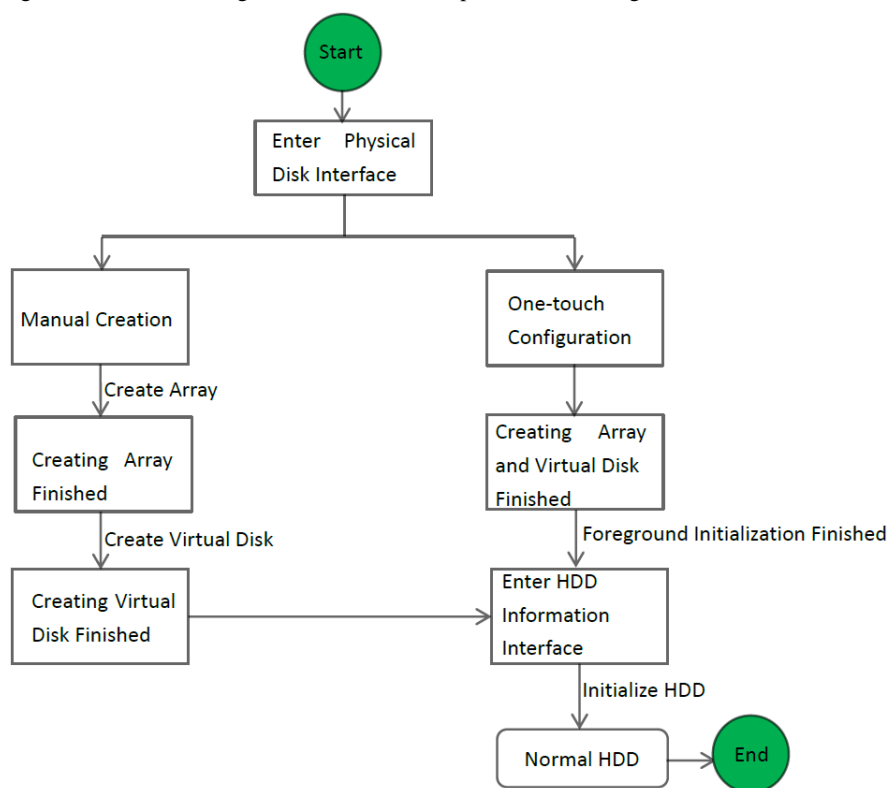

Figure 10. 1 RAID Working Flow

10.1.1 One-touch Configuration

Purpose:

Through one-touch configuration, you can quickly create the disk array and virtual disk. By default, the array type to be created is RAID 5.

Steps:

1. Enter the Physical Disk Settings interface.

Menu > HDD > RAID > Physical Disk

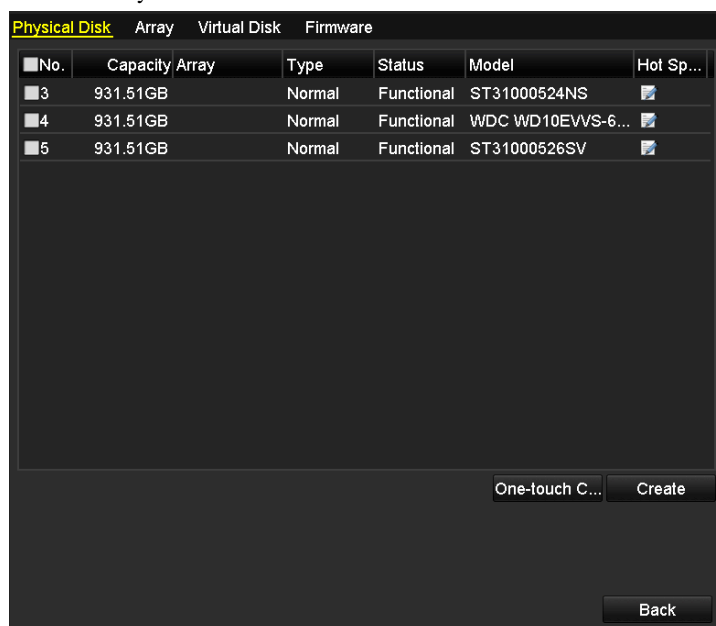

Figure 10.2 Physical Disk Settings Interface

2. Click **One-touch Config** to enter the One-touch Array Configuration interface.



As the default array type is RAID 5, at least 3 HDDs must be installed in you device.

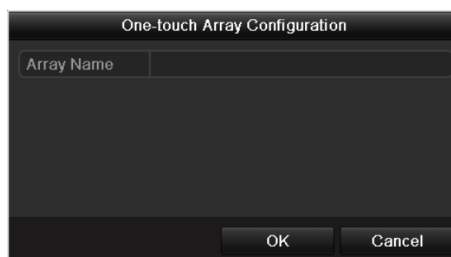

Figure 10.3 One-touch Array Configuration

3. Edit the array name in the **Array Name** text filed and click **OK** start array configuration.



If you install 4 HDDs or above for one-touch configuration, a hot spare disk will be set by default. It is recommended to set hot spare disk for automatically rebuilding the array when the array is abnormal.

4. When the array configuration is complete, click **OK** in the pop-up message box to finish the settings.

5. You can click **Array** tab to view the information of the successfully created array.



By default, one-touch configuration creates an array and a virtual disk.

Physical Disk Array Virtual Disk Firmware									
No.	Name	Free Space	Physic...	Hot ...	Status	Level	Re...	Del...	Task
1	array1_1	0/1862G	3	4 5	Funci...	RAID 5			None

Figure 10. 4 Array Settings Interface

6. Click **Virtual Disk** tab to view the automatically created virtual disk.



By default, one-touch configuration adopts background initialization to initialize the virtual disk.

Physical Disk Array Virtual Disk Firmware									
No.	Name	Cap...	Array	Status	Type	Repair	Delete	Task	
1	vd1_array1	1862G	array1_1	Funci...	RAID 5	-		Initialize (Background)	

Figure 10. 5 Virtual Disk Settings Interface

7. After the initialization of the virtual disk is complete, the virtual disk will be displayed in the HDD Information interface (Menu>HDD>General). For operation guide of initializing the virtual disk, please refer to *Chapter 11.1 Initializing HDDs*.



For configuring hot spare disk manually, please refer to steps 12-15 of *Chapter 10.1.2*.

10.1.2 Manually Creating Array and Virtual Disk

Purpose:

You can manually create the array of RAID 0, RAID 1, RAID 5 and RAID 10.



In this section, we take RAID 5 as an example to describe the manual configuration of array and virtual disk.

Steps:

1. Enter the Physical Disk Settings interface.
Menu > HDD > RAID > Physical Disk

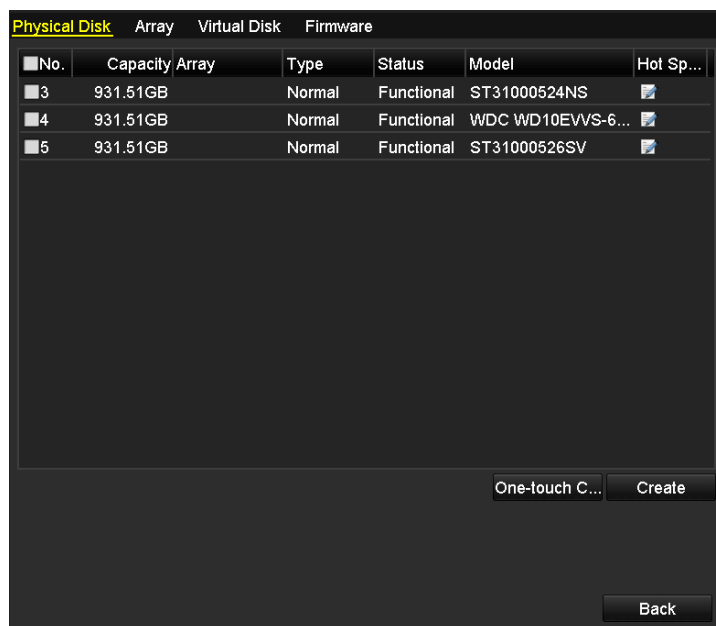

Figure 10. 6 Physical Disk Settings Interface

2. Click **Create** to enter the Create Array interface.

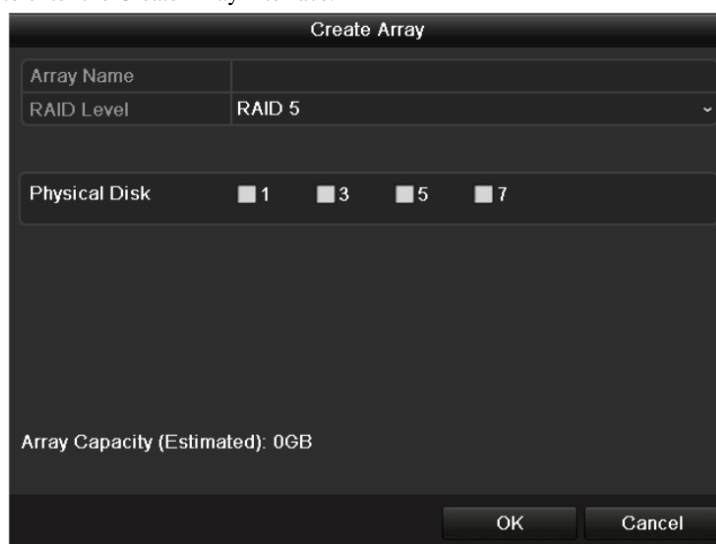

Figure 10. 7 Create Array Interface

3. Edit the Array Name; set the RAID Level to RAID 0, RAID 1, RAID 5 or RAID 10; select the Physical Disk that you want to configure array.



- If you choose RAID 0, at least 2 HDDs must be installed.
- If you choose RAID 1, 2 HDDs need to be configured for RAID 1.
- If you choose RAID 5, at least 3 HDDs must be installed.
- If you choose RAID 10, 4/6/8 HDDs need to be configured for RAID 10.

4. Click **OK** to create array.



If the number of HDDs you select is not compatible with the requirement of the RAID level, the error message box will pop up.



Figure 10. 8 Error Message Box

5. You can click **Array** tab to view the successfully created array.

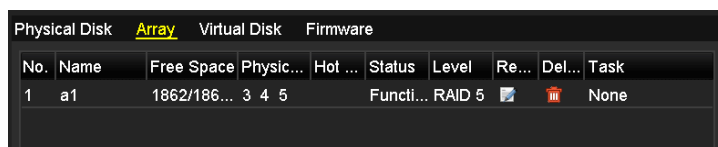

Figure 10. 9 Array Settings Interface

6. Click to select an array and click **Create Vd** to enter the Create Virtual Disk interface.



The device supports creating at most 8 virtual disks.

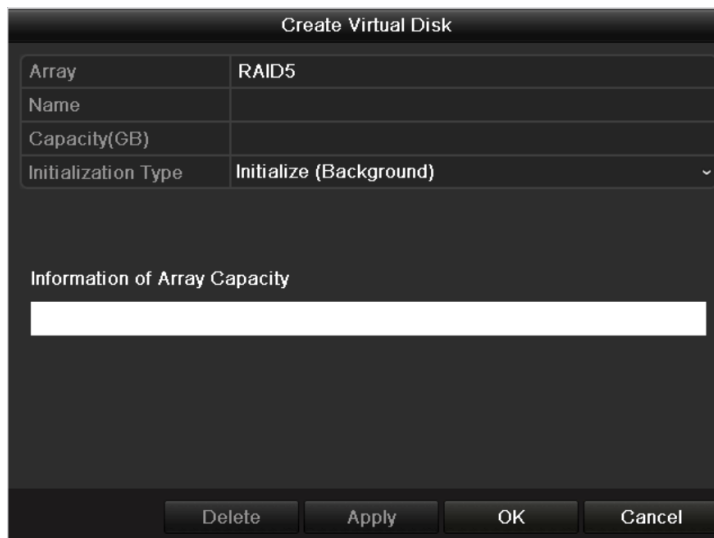

Figure 10. 10 Create Virtual Disk Interface

7. Edit the name of the virtual disk, set the capacity for the virtual disk and select the initialization type for the virtual disk.



- You can also click the **Information of Array Capacity** area to set the remaining capacity of the array for the disk.
- It is recommended to create one virtual disk of an array.
- At least 100GB capacity must be configured for each virtual disk.
- There are three initialization types, including Background, Foreground and Fast.

Fast (Not Recommended): The fast initialization usually takes short time and only initializes part of

the RAID, and cannot detect the bad sector.

Foreground (Recommended): By using foreground initialization, the RAID will be initialized totally and the bad sector of the hard disks can be detected and repaired. The virtual disk can be used only after the initialization is complete.

Background: The background initialization can synchronize the disks, and detect and repair the bad sector of the disks. During the background initialization, the virtual disk is allowed to be used.

8. Click **Apply** to save the settings and click **OK** to return to Array Settings interface.
9. Click **Virtual Disk** tab to enter the Virtual Disk interface. The successfully created virtual disk will be listed on the interface.

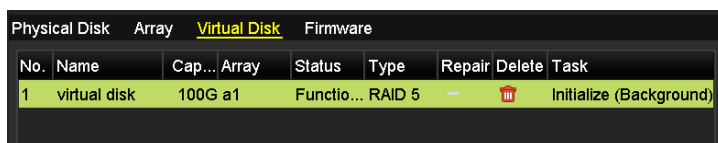

Figure 10. 11 Virtual Disk Interface

10. Enter the HDD Information interface (Menu>HDD>General) and the virtual disk will be displayed. For operation guide of initializing the virtual disk, please refer to *Chapter 11.1 Initializing HDDs*.



If you adopt foreground initialization, the virtual disk will be displayed in the HDD Information interface after the initialization is complete.

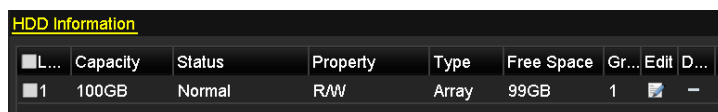

Figure 10. 12 HDD Information Interface

11. Enter the Physical Disk Settings interface to configure the hot spare disk.

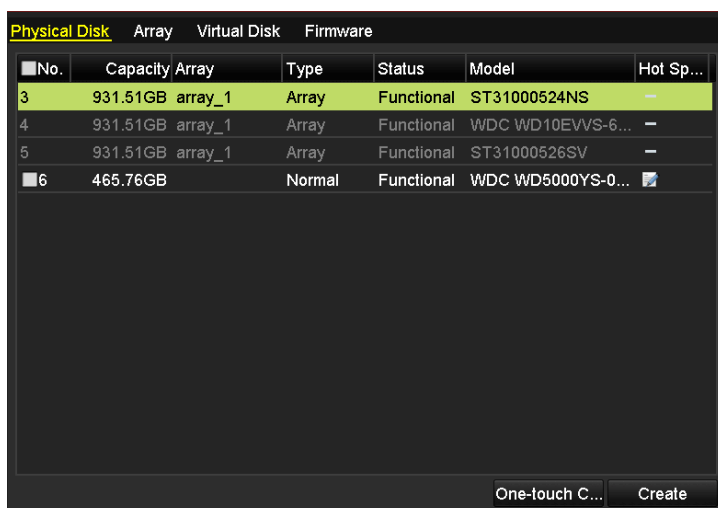

Figure 10. 13 Physical Disk Settings Interface

12. Select a free disk and click the icon . Then the free disk will be set as the global hot spare disk.

You can click the icon to delete the hot spare disk.

Physical Disk						
No.	Capacity	Array	Type	Status	Model	Hot Sp...
3	931.51GB	array_1	Array	Functional	ST31000524NS	—
4	931.51GB	array_1	Array	Functional	WDC WD10EVVS-6...	—
5	931.51GB	array_1	Array	Functional	ST31000526SV	—
6	465.76GB	Global	Hot Spare	Functional	WDC WD5000YS-0...	

Figure 10.14 Hot Spare Disk

10.2 Rebuilding Array

Purpose:

The working status of array includes Functional, Disk Loss and Offline. By viewing the array status, you can take immediate and proper maintenance for the disks so as to ensure the high security and reliability of the data stored in the disk array.

When there is no disk loss in the array, the working status of array will change to Functional; when the number of lost disks has exceeded the limit, the working status of array will change to Offline; in other conditions, the working status is Disk Loss.

When the virtual disk is in Degraded status, you can restore it to Functional by array rebuilding.

10.2.1 Automatically Rebuilding Array

Purpose:

When the virtual disk is in Degraded status, the device can start rebuilding the array automatically with the hot spare disk to ensure the high security and reliability of the data.

Before you start:

The hot spare disk needs to be configured.

Steps:

1. Enter the Array Settings interface. When the status of the array is Disk Loss, the hot spare disk will be automatically used for array rebuilding.

Menu > HDD > RAID > Array

No.	Name	Free Space	Physic...	Hot ...	Status	Level	Re...	Del...	Task
1	array	831/931G	7 3 6		Disk L...	RAID 5			Rebuild(Running)

Figure 10.15 Array Settings Interface

2. Enter the Virtual Disk interface to view the rebuilding status of the virtual disk.

Menu>HDD>RAID>Virtual Disk

No.	Name	Cap...	Array	Status	Type	Repair	Delete	Task
1	vd	100G	array	Degrad...	RAID 5	-		Rebuild(Running) 8%

Figure 10.16 Virtual Disk Settings Interface



If there is no hot spare disk after rebuilding, it is recommended to install a HDD into the device and set it as a hot spare disk to ensure the high security and reliability of the array.

10.2.2 Manually Rebuilding Array

Purpose:

If there is no hot spare disk available, you can rebuild the array manually to restore the array when the virtual disk is in Degraded status.

Steps:

1. Enter the Array Settings interface. The status of the array is displayed as Disk Loss, and the status of the virtual disk is displayed as Degraded.

Menu > HDD > RAID > Array;

Menu > HDD > RAID > Virtual Disk

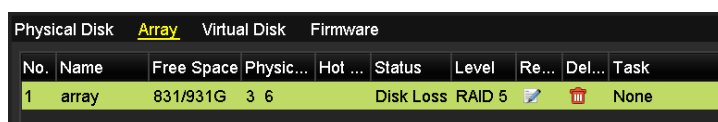

No.	Name	Free Space	Physic...	Hot ...	Status	Level	Re...	Del...	Task
1	array	831/931G	3 6		Disk Loss	RAID 5			None

Figure 10.17 Array Settings Interface

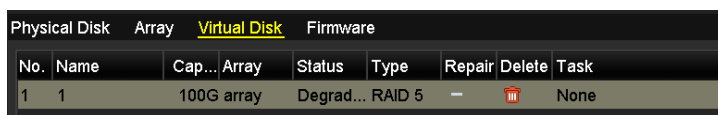

No.	Name	Cap...	Array	Status	Type	Repair	Delete	Task
1	1	100G	array	Degrad...	RAID 5	-		None

Figure 10.18 Virtual Disk Interface

2. Click the icon  on the Array Settings interface to rebuild the array.



At least one available physical disk should exist for rebuilding the array.

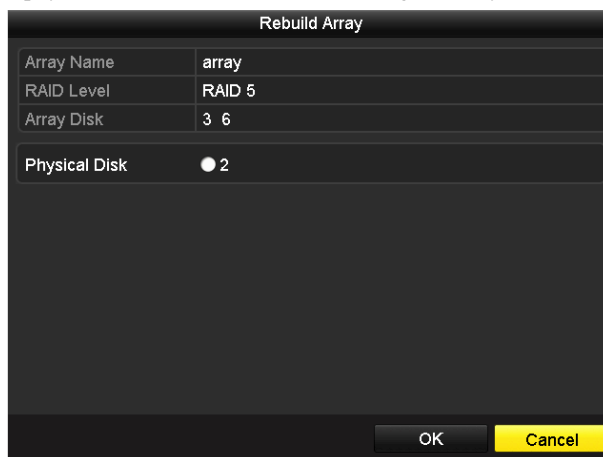

Rebuild Array	
Array Name	array
RAID Level	RAID 5
Array Disk	3 6
Physical Disk	<input checked="" type="radio"/> 2
<input type="button" value="OK"/> <input type="button" value="Cancel"/>	

Figure 10.19 Rebuild Array Interface

3. Select the available free physical disk and click **OK** to confirm to rebuild the array.
4. The “Do not unplug the physical disk when it is under rebuilding” message box pops up. Click **OK** to start rebuilding.
5. After rebuilding successfully, the array and virtual disk will restore to Functional. You can enter the Array Settings interface and Virtual Disk interface to view the rebuilding status.

10.3 Repairing Virtual Disk

Purpose:

When the disk cannot be displayed on the HDD Information interface while the virtual disk can still show in the Array Settings interface, you have to repair the virtual disk.



If the virtual disk is under foreground initialization, the repairing cannot be done.

Steps:

1. Enter the Virtual Disk interface.
Menu > HDD > RAID > Virtual Disk

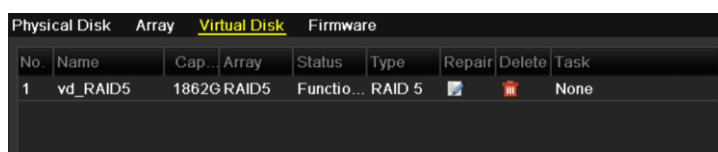

Figure 10. 20 Virtual Disk Interface

2. Click to repair the virtual disk. After successfully repairing, the following message box will pop up. Click **OK** to finish the settings.



Figure 10. 21 Repairing Virtual Disk Successfully

The disk shows again in the HDD Information interface (Menu>HDD>General).

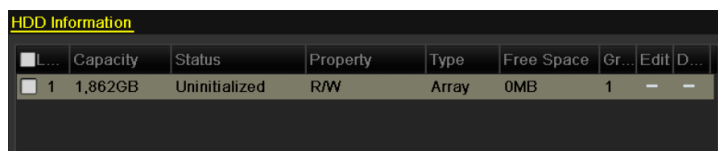

Figure 10. 22 HDD Information Interface

10.4 Deleting Array / Virtual Disk



Before deleting the array, the virtual disk(s) under this array must be deleted first. Deleting array and virtual disk will delete all the data saved in the disk.

10.4.1 Deleting the Virtual Disk

Steps:

1. Enter the Virtual Disk interface.
Menu > HDD > RAID > Virtual Disk

No.	Name	Cap...	Array	Status	Type	Repair	Delete	Task
1	vd1	100G raid	Funcio...	RAID 5	-	[Delete icon]	Initialize (Background)	

Figure 10. 23 Virtual Disk Interface

2. Select a virtual disk and click to delete the virtual disk.



Figure 10. 24 Confirm Virtual Disk Deletion

3. In the pop-up message box, click **Yes** to confirm the virtual disk deletion.



Deleting virtual disk will cause to delete all the data saved in the disk.

10.4.2 Deleting the Array



If all the virtual disks under an array have been deleted, then you can delete that array.

Steps:

1. Enter the Array Settings interface.
Menu>HDD>RAID>Array

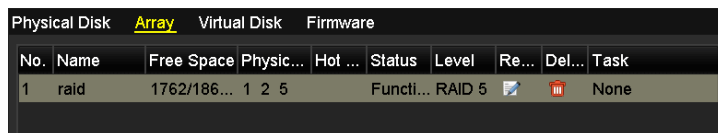

Figure 10. 25 Array Settings Interface

2. Select an array and click  to delete the array.



Figure 10. 26 Confirm Array Deletion

3. In the pop-up message box, click **Yes** to confirm the array deletion.



Deleting array will cause to delete all the data in the array.

10.5 Upgrading Firmware

Purpose:

You can view the information of the firmware and upgrade the firmware by local backup device or remote FTP server.

Steps:

1. Enter the Firmware interface to view the information of the firmware, including the version, maximum physical disk quantity, maximum array quantity, auto-rebuild status, etc.

Menu > HDD > RAID > Firmware

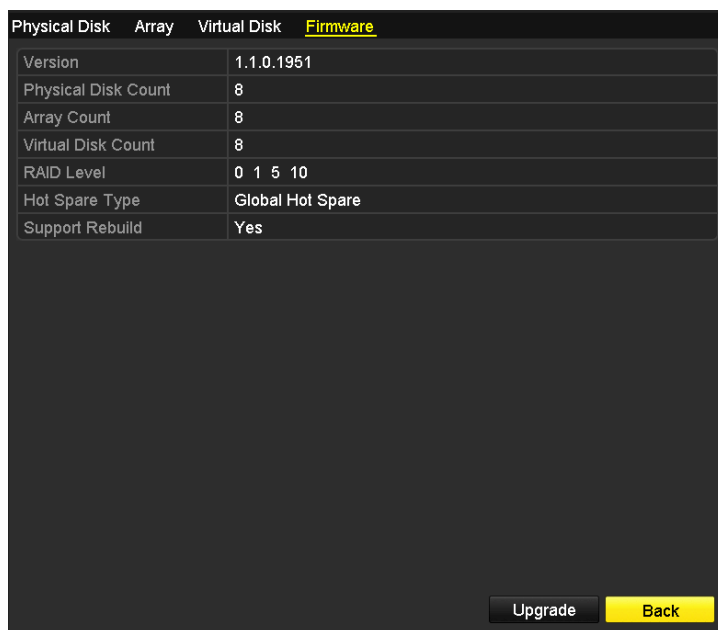

Physical Disk	Array	Virtual Disk	Firmware
Version			1.1.0.1951
Physical Disk Count			8
Array Count			8
Virtual Disk Count			8
RAID Level			0 1 5 10
Hot Spare Type			Global Hot Spare
Support Rebuild			Yes

Upgrade Back

Figure 10. 27 Firmware Interface

2. You can click **Upgrade** to upgrade the firmware. Local upgrade and FTP upgrade are available. Since the upgrading process of the firmware is the same as that of the device firmware, you can refer to *Chapter 13.4* for detailed information.



Please contact the dealer immediately if the device cannot work properly after upgrading.



Figure 10. 28 Upgrade the Firmware

Chapter 11 HDD Management



In this chapter, we use the interface of DS-9100HFI-ST series (unless otherwise stated) as example to describe the following settings.

11.1 Initializing HDDs

Purpose:

A newly installed hard disk drive (HDD) must be initialized before it can be used with your device.



If there is uninitialized HDD existed in the device, the following message box pops up when the device starts up.

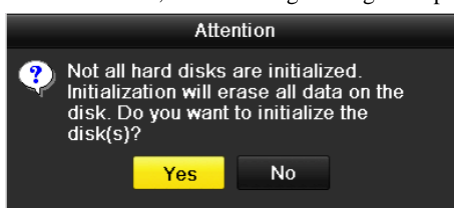

Figure 11. 1 Message Box of Uninitialized HDD

Click **Yes** to initialize it immediately or you can perform the following steps to initialize the HDD(s).

Steps:

1. Enter the HDD Information interface.

Menu > HDD > General

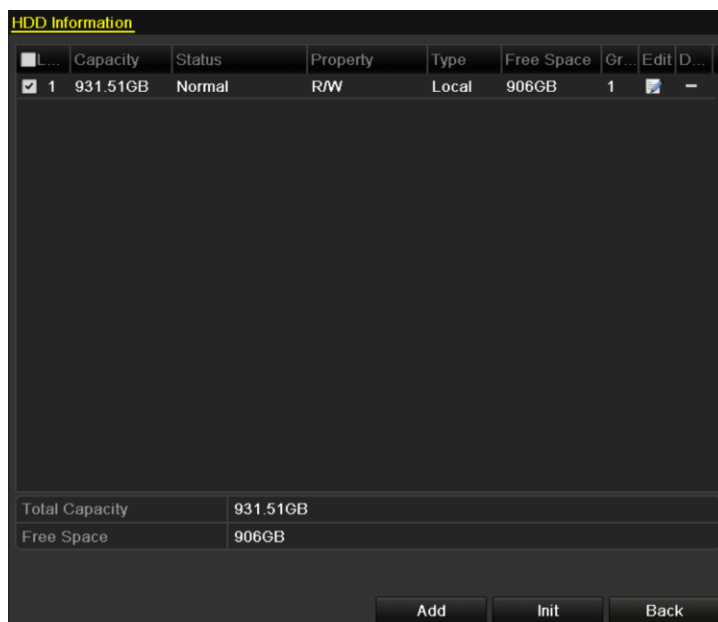

Figure 11. 2 HDD Information Interface

2. Select HDD to be initialized.
3. Click **Init**.

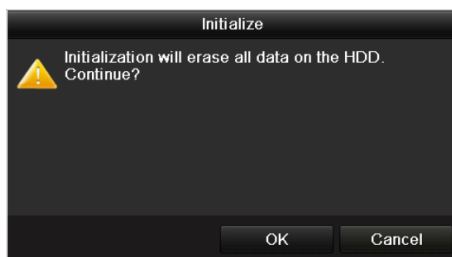

Figure 11. 3 Confirm Initialization

-
4. Select **OK** to start initialization.

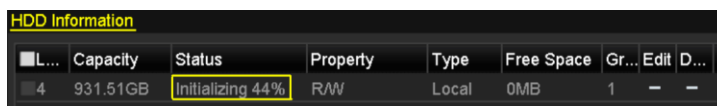

Figure 11. 4 Start Initialization

-
5. After the HDD has been initialized, the status of the HDD will change from *Uninitialized* to *Normal*.

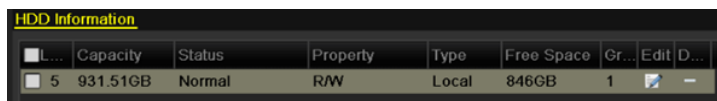

Figure 11. 5 HDD Status Changes to Normal



Initializing the HDD will erase all data on it.

The HDDs which are free of working for a long time can be enabled to sleep, thus to decrease the power consumption of the device and extend the life of the HDDs.

Click Menu > HDD > Advanced.

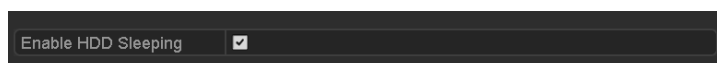

Figure 11. 6 Enable HDD Sleeping

Check the checkbox of **Enable HDD Sleeping** (by default), and the HDDs which are free of working for a long time will be set to sleep.

Uncheck the checkbox of **Enable HDD Sleeping**, and the HDDs will be set to work for all time.

11.2 Managing Network HDD

Purpose:

You can add the allocated NAS or disk of IP SAN to device, and use it as network HDD.

Steps:

1. Enter the HDD Information interface.

Menu > HDD > General

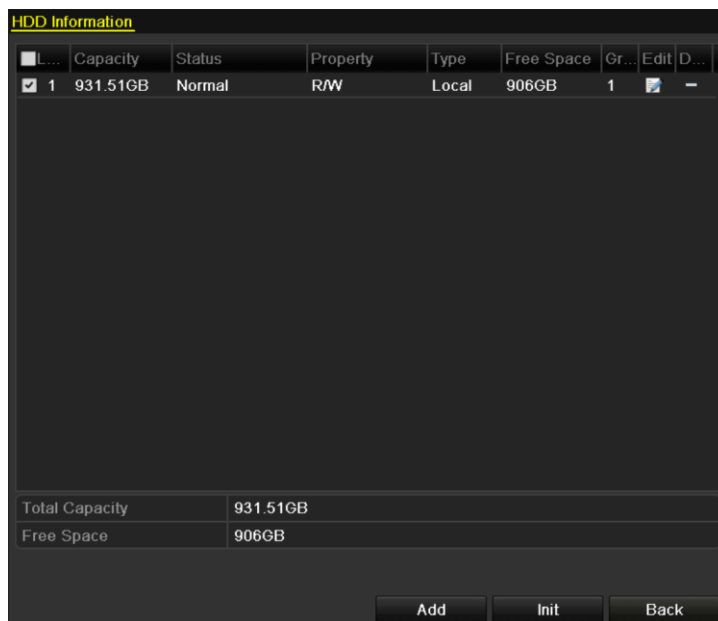

Figure 11.7 HDD Information Interface

2. Click **Add** to enter the Add NetHDD interface.

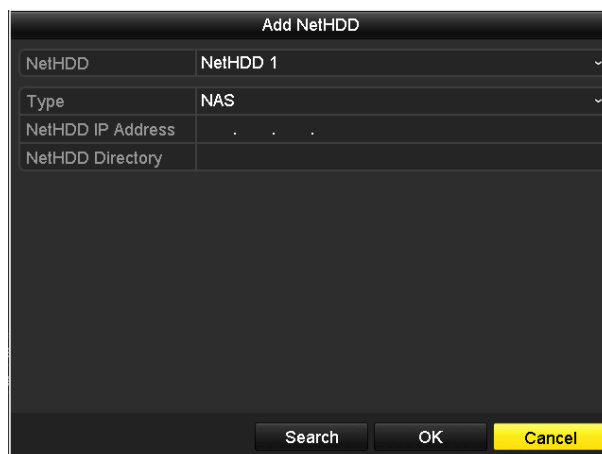

Figure 11.8 Adding NetHDD Interface

3. Add the allocated NetHDD.
4. Select the type to NAS or IP SAN.
5. Configure the NAS or IP SAN settings.

Add NAS disk:

- 1) Enter the NetHDD IP address in the text field.

- 2) Click **Search** to search the available NAS disks.
- 3) Select the NAS disk from the list shown below.
Or you can just manually enter the directory in the text field of NetHDD Directory.
- 4) Click **OK** to add the configured NAS disk.



Up to 8 NAS disks can be added.

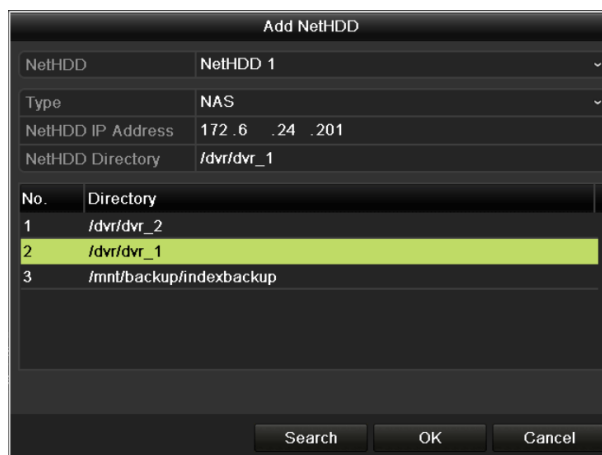

Figure 11. 9 Add NAS Disk

Add IP SAN:

- 1) Enter the NetHDD IP address in the text field.
- 2) Click **Search** to search the available IP SAN disks.
- 3) Select the IP SAN disk from the list shown below.
- 4) Click **OK** to add the selected IP SAN disk.



Up to 1 IP SAN disk can be added.

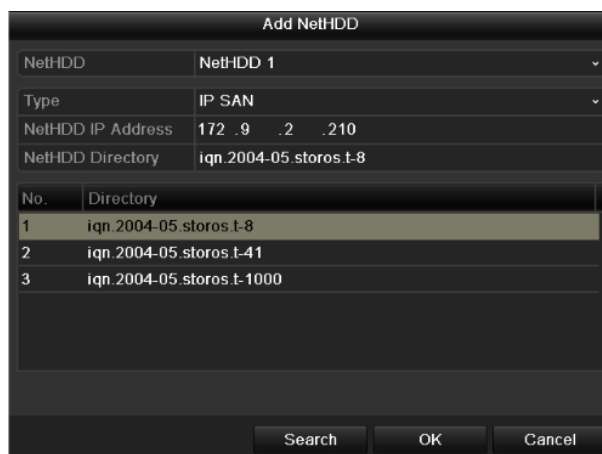
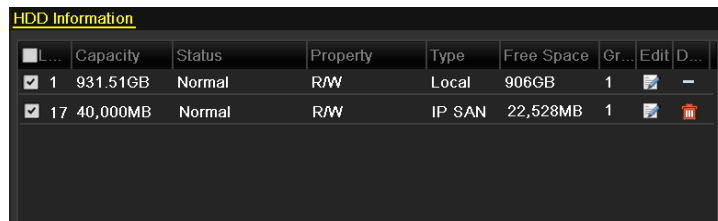

Figure 11. 10 Add IP SAN Disk

6. After having successfully added the NAS or IP SAN disk, return to the HDD Information menu. The added NetHDD will be displayed in the list.



If the added NetHDD is uninitialized, please select it and click **Init** for initialization.



The screenshot shows a table titled "HDD Information" with the following columns: L..., Capacity, Status, Property, Type, Free Space, Gr..., Edit, and D... The table contains two rows of data, both with checked checkboxes in the "L..." column.

<input type="checkbox"/> L...	Capacity	Status	Property	Type	Free Space	Gr...	Edit	D...
<input checked="" type="checkbox"/> 1	931.51GB	Normal	R/W	Local	906GB	1		-
<input checked="" type="checkbox"/> 17	40,000MB	Normal	R/W	IP SAN	22,528MB	1		

Figure 11. 11 Initialize Added NetHDD

11.3 Managing eSATA

Purpose:

When there is an external eSATA device connected to device, you can configure eSATA for the use of Record/Capture or Export, and you can manage the eSATA in the device.

Steps:

1. Enter the Advanced Record Settings interface.

Menu > Record>Advanced

2. Select the eSATA type to eSATA1.

3. Set the Usage as Record/Capture or Export.

Export: Use the eSATA for backup. Refer to *Backup using eSATA HDDs in Chapter 7.1.2 Backing up by Normal Video Search* for operating instructions.

Record/Capture: Use the eSATA for record/capture. Refer to the following steps for operating instructions.



Figure 11. 12 Set eSATA Usage

4. When the eSATA usage is selected to Record/Capture, enter the HDD Information interface.

Menu > HDD > General

5. Edit the property of the selected eSATA, or initialize it is required.



Three storage modes can be configured for the eSATA when it is used for Record/Capture. Please refer to *Chapter 11.4, Chapter 11.5 and Chapter 11.6* for details.

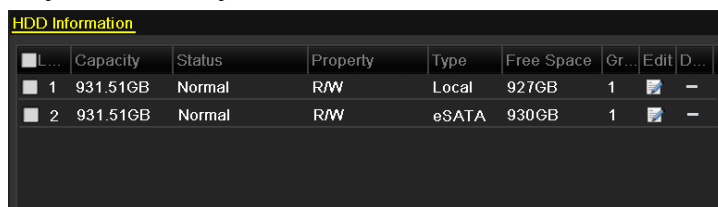

Figure 11. 13 Initialize Added eSATA

11.4 Managing HDD Group

11.4.1 Setting HDD Groups

Purpose:

Multiple HDDs can be managed in groups. Video from specified channels can be recorded onto a particular HDD group through HDD settings.

Steps:

1. Enter the Storage Mode interface.
Menu > HDD > Advanced > Storage Mode
2. Set the **Mode** to Group, as shown below.



Reboot the device to activate the new settings.

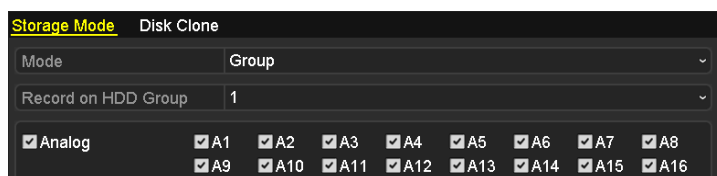

Figure 11. 14 Storage Mode Interface for DVR Series

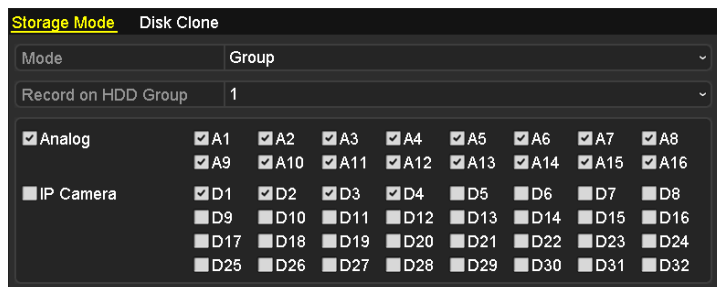

Figure 11. 15 Storage Mode Interface for HDVR Series



IP Camera is supported by HDVR series only.

3. Click **Apply** and the following Attention box will pop up.

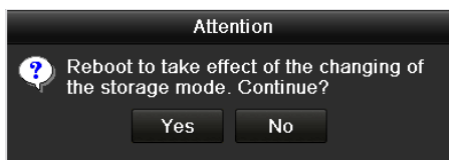



Figure 11. 16 Attention for Reboot

4. Click **Yes** to reboot the device to activate the changes.
5. After reboot of device, enter the HDD Information interface.
Menu > HDD > General

6. Select a HDD from the list and click  to enter the Local HDD Settings interface.

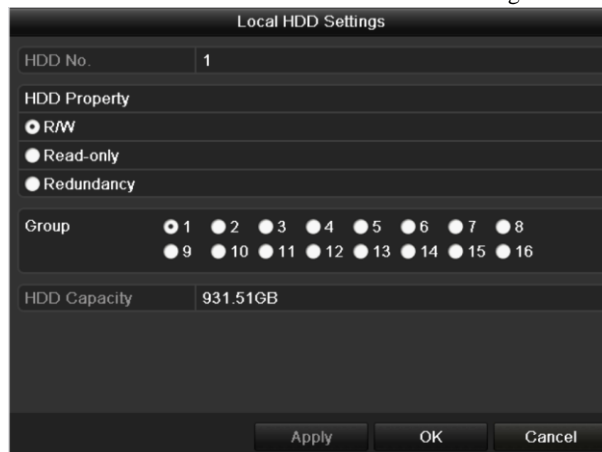

Figure 11. 17 Local HDD Settings Interface

7. Select the Group number for the current HDD.



The default group No. for each HDD is 1.

8. Click **OK** to confirm the settings.



Figure 11. 18 Confirm HDD Group Settings

9. In the pop-up Attention box, click **Yes** to finish the settings.

11.4.2 Setting HDD Property

Purpose:

The HDD property can be set to redundancy, read-only or read/write (R/W). Before setting the HDD property, please set the storage mode to Group (refer to step1-4 of *Chapter 11.4.1 Setting HDD Groups*).

A HDD can be set to read-only to prevent important recorded files from being overwritten when the HDD becomes full in overwrite recording mode.

When the HDD property is set to redundancy, the video can be recorded both onto the redundancy HDD and the R/W HDD simultaneously so as to ensure high security and reliability of video data.

Steps:

1. Enter the HDD Information interface.

Menu > HDD > General

2. Select a HDD from the list and click  to enter the Local HDD Settings interface.



Figure 11. 19 Set HDD Property

3. Set the HDD property to R/W, Read-only or Redundancy.
4. Click **OK** to save the settings and exit the interface.
5. In the HDD Information menu, the HDD property will be displayed in the list.



At least 2 hard disks must be installed on your device when you want to set a HDD to Redundancy, and there is one HDD with R/W property.

11.5 Configuring Quota Mode

Purpose

Each camera can be configured with allocated quota for the storage of recorded files or captured pictures.

Steps

1. Enter the Storage Mode interface.

Menu > HDD > Advanced

2. Set the **Mode** to Quota.

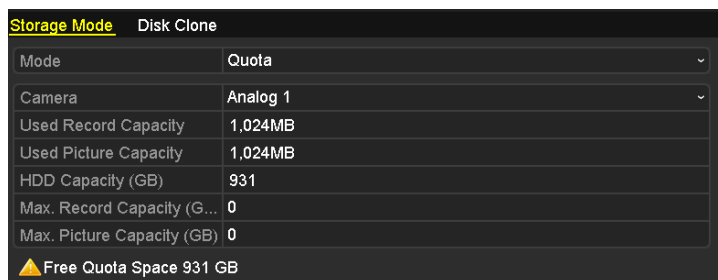

Figure 11. 20 Storage Mode Settings Interface

3. Select a camera for which you want to configure quota. In HDVR series device you can select **IP Camera**.
4. Enter the storage capacity in the text fields of **Max. Record Capacity (GB)** and **Max. Picture Capacity (GB)**.

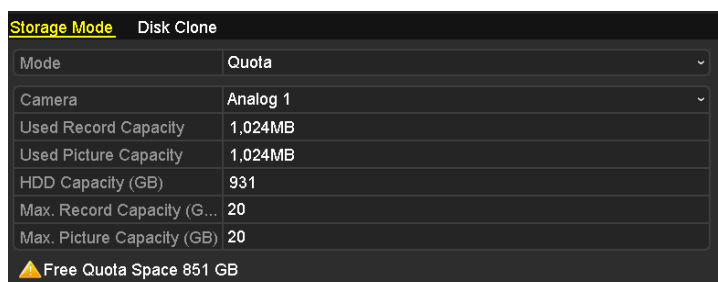

Figure 11. 21 Configure Record/Picture Quota

5. You can copy the quota settings of the current camera to other cameras if required. Click **Copy** to enter the Copy Camera menu, as shown below.



Figure 11. 22 Copy Settings to Other Camera(s) for DVR Series



Figure 11. 23 Copy Settings to Other Camera(s) for HDVR Series



IP Camera is supported by HDVR series only.

6. Select the camera (s) to be configured with the same quota settings. You can also click the checkbox of **Analog** or **IP Camera** to select all cameras.
7. Click **OK** to finish the Copy settings and back to the Storage Mode interface.
8. Click **Apply** to save the settings.



- The device must be rebooted to activate the changes.
- If the quota capacity is set to 0, then all cameras will use the total capacity of HDD for record and picture capture.

11.6 Configuring Frame Extracting Mode

Purpose:

If you want to extend the record time of the HDD, you can set the storage mode of the HDD to Frame Extracting. In this mode, the bitrate of frame extracting record is less than 1/8 of that of normal record and the frame rate of frame extracting record is 1 fps so as to maintain longer storage time of the record files.



- This chapter is only available for DVR series.
- If you set the storage mode as Frame Extracting, you may only find the frame extracting record of low bitrate and frame rate at certain time period.

Steps:

1. Enter the Storage Mode interface.
Menu>HDD>Advanced
2. Set the **Mode** to Frame Extracting.



The device must be rebooted to activate the change.

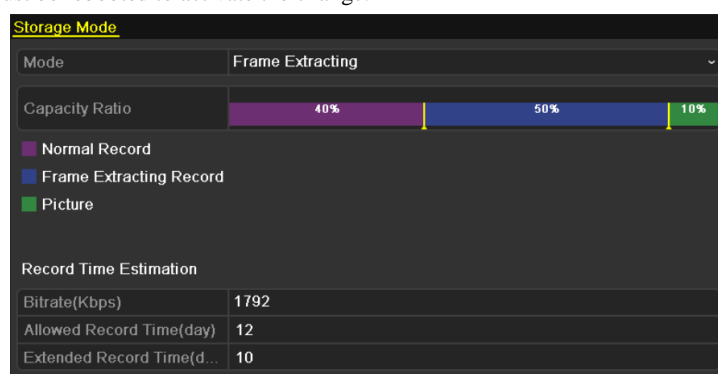



Figure 11. 24 Storage Mode Settings Interface

3. Drag  to adjust the storage percentages of normal record, frame extracting record and picture according to actual requirements.
4. You can edit the bitrate of the camera and the Allowed Record Time and Extended Record Time will change accordingly.

Allowed Record Time: The total recording time that is allowed when using the frame-extracting recording mode.

Extended Record Time: The recording time that is extended when using the frame-extracting recording mode.

Example: With the frame extracting mode configured, the Allowed Record Time is estimated as 12 and the Extended Record Time as 10, it means the HDD capacity allows the frame extracting record to last 12 days and the record time is extended for about 10 days. If you have not configured the frame extracting mode, the HDD capacity allows the record to last 2 days only.



- The estimation of the record time is only for reference.
- If you change the storage capacity of the device, e.g., a new HDD is connected or a HDD is removed, you have to configure the frame extracting mode again.

11.7 Configuring Disk Clone

Before you start:

Connect a HDD to the device via the eSATA interface.

Purpose:

You can clone all the data stored on the HDD, which is installed on the device, to a connected eSATA disk according to the actual needs or when the S.M.A.R.T. detection result declares the HDD is abnormal. For details of S.M.A.R.T. detection, see *Chapter 11.9*.



- The disk clone function is not supported by 9100HFI-RT/9000HFI-RT/7200HWI-SV Series.
- For 9100HFI-XT/9000HFI-XT Series, the disk clone is only available when the RAID function is disabled.

Steps:

1. Enter the HDD Advanced Setting interface:
Menu > HDD > Advanced
2. Click the **Disk Clone** tab to enter the Disk Clone Settings interface.

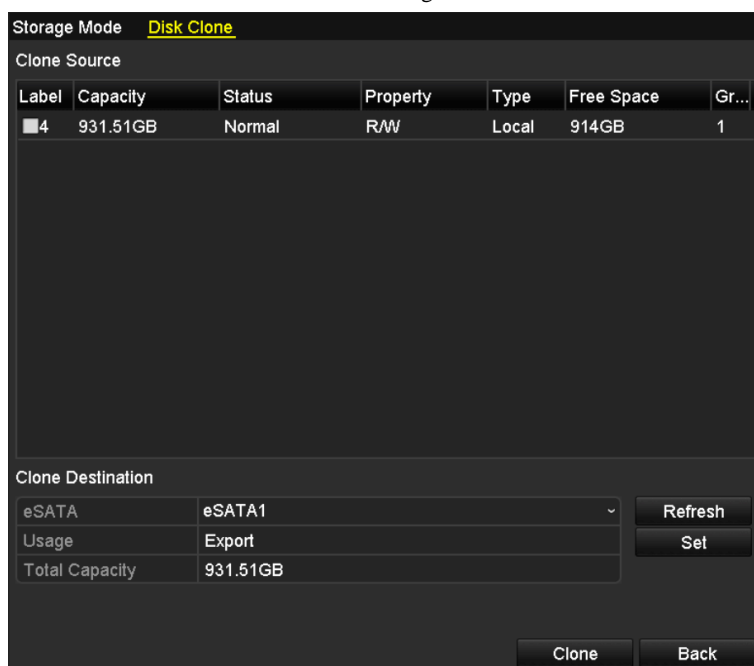

Figure 11. 25 Disk Clone Settings Interface

3. Make sure the usage of the eSATA disk is set as Export.
If not, click the **Set** button to set it. Choose Export and click the **OK** button.



Figure 11. 26 Setting eSATA Usage



The capacity of destination disk must be the same as that of the clone source disk.

4. Check the checkbox of the HDD to be cloned in the Clone Source list.
5. Click the **Clone** button and a message box pops up.

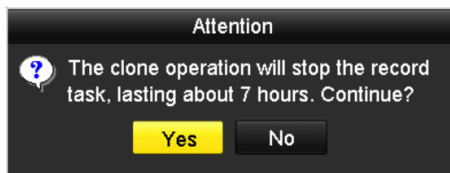

Figure 11. 27 Message Box for Disk Clone

6. Click the **Yes** button to continue.

You can check the clone progress in the HDD status.

Label	Capacity	Status	Property	Type	Free Space	Gr...
4	931.51GB	Cloning 01%	R/W	Local	0MB	1

Figure 11. 28 Check Disk Clone Progress

11.8 Checking HDD Status

Purpose:

You may check the status of the installed HDDs on device so as to take immediate check and maintenance in case of HDD failure.

Checking HDD Status in HDD Information Interface

Steps:

1. Enter the HDD Information interface.
Menu > HDD>General
2. Check the status of each HDD which is displayed on the list.

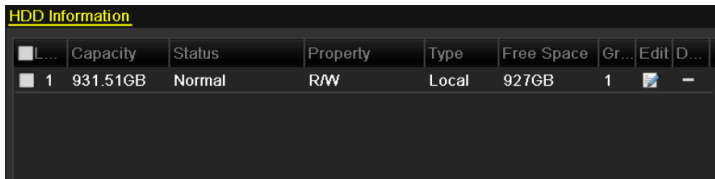

Capacity	Status	Property	Type	Free Space	Gr...	Edit	D...
1 931.51GB	Normal	R/W	Local	927GB	1		-

Figure 11. 29 View HDD Status (1)



If the status of HDD is *Normal* or *Sleeping*, it works normally. If the status is *Uninitialized* or *Abnormal*, please initialize the HDD before use. And if the HDD initialization is failed, please replace it with a new one.

Checking HDD Status in HDD Information Interface

Steps:

1. Enter the System Information interface.
Menu > Maintenance > System Info
2. Click the **HDD** tab to view the status of each HDD displayed on the list.

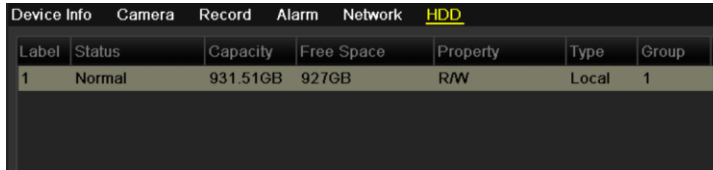

Label	Status	Capacity	Free Space	Property	Type	Group
1	Normal	931.51GB	927GB	R/W	Local	1

Figure 11. 30 View HDD Status (2)

11.9 Checking S.M.A.R.T. Information

Purpose:

The S.M.A.R.T. (Self-Monitoring, Analysis and Reporting Technology) is a monitoring system for HDD to detect and report on various indicators of reliability in the hopes of anticipating failures.



This chapter is not available for DS-9100/9000HFI-RT series.

Steps:

1. Enter the S.M.A.R.T. Settings interface.
Menu > Maintenance > HDD Detect > S.M.A.R.T. Settings
2. Select a HDD to view its S.M.A.R.T. information list.



If you want to use the HDD even when the S.M.A.R.T. checking is failed, you can check the checkbox before the **Continue to use this disk when self-evaluation is failed** item.

3. Three self-tests of S.M.A.R.T are provided, including Short Test, Expanded Test and Conveyance Test. You can select a self-test type and click to start self-test.

ID	Attribute Name	Status	Flags	Thresh...	Value	Worst	Raw Value
0x1	Raw Read Error Rate	OK	2f	51	200	200	418
0x3	Spin Up Time	OK	27	21	132	107	6366
0x4	Start/Stop Count	OK	32	0	100	100	294
0x5	Reallocated Sector Co...	OK	33	140	200	200	0
0x7	Seek Error Rate	OK	2e	0	200	200	0
0x9	Power-on Hours Count	OK	32	0	94	94	4452
0xa	Spin Up Retry Count	OK	32	0	100	100	0

Figure 11. 31 S.M.A.R.T. Settings Interface

11.10 Detecting Bad Sector

Purpose:

You can detect the bad sector of the HDD to check the status of the HDD.



This chapter is not available for DS-9100/9000HFI-RT series.

Steps:

1. Enter the Bad Sector Detection interface.
Menu > Maintenance > HDD Detect > Bad Sector Detection

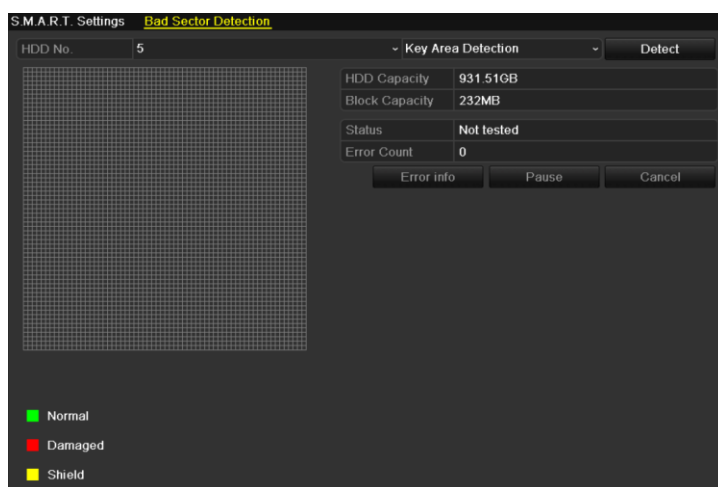

Figure 11. 32 Bad Sector Detection

2. Select a HDD and choose Full Detection or Key Area Detection as the detection type.
3. Click **Detect** to start detecting.

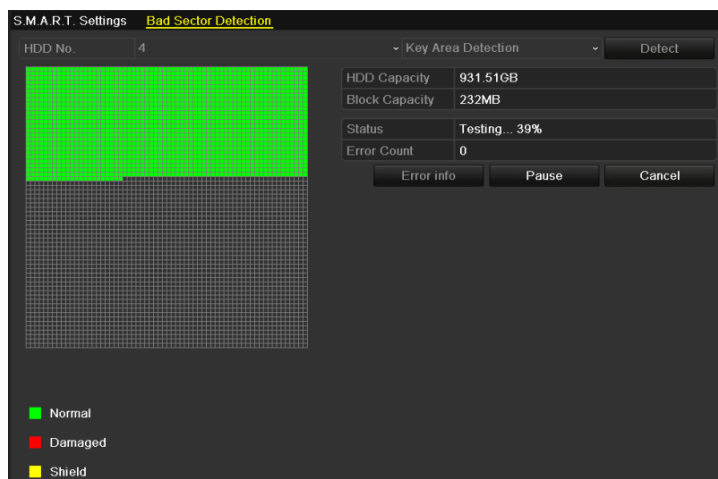

Figure 11. 33 Bad Sector Detecting

4. You can click **Pause** to pause the detection and click **Resume** to resume the detection.
5. If there is error information about the HDD, you can click **Error info** to view the information.

11.11 Configuring HDD Error Alarms

Purpose:

You can configure the HDD error alarms when the HDD status is *Uninitialized* or *Abnormal*.

Steps:

1. Enter the Exception interface.
Menu > Configuration > Exceptions
2. Select the Exception Type to **HDD Error** from the drop-down list.
3. Click the checkbox(s) below to select the HDD error alarm type (s).



The alarm type can be selected to: Audible Warning, Notify Surveillance Center, Send Email and Trigger Alarm Output. Please refer to *Chapter 8.7 Setting Alarm Linkage Actions*.

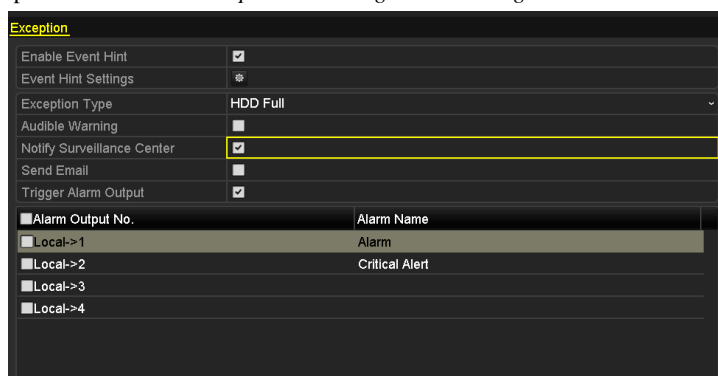

Figure 11. 34 Configure HDD Error Alarm

4. When the Trigger Alarm Output (not supported by DS-7200 series) is selected, you can also select the alarm output to be triggered from the list below.
5. Click **Apply** to save the settings.

Chapter 12 Camera Settings

12.1 Configuring OSD Settings

Purpose:

You can configure the OSD (On-screen Display) settings for the camera, including date /time, camera name, etc.



We use the interface of DS-9100HFI-ST series (unless otherwise stated) as example to describe the following settings.

Steps:

1. Enter the OSD Configuration interface.
Menu > Camera > OSD
2. Select the camera to configure OSD settings.
3. Edit the Camera Name in the text field.
4. Configure the Display Name, Display Date and Display Week by checking the checkbox.
5. Select the Date Format, Time Format and Display Mode.

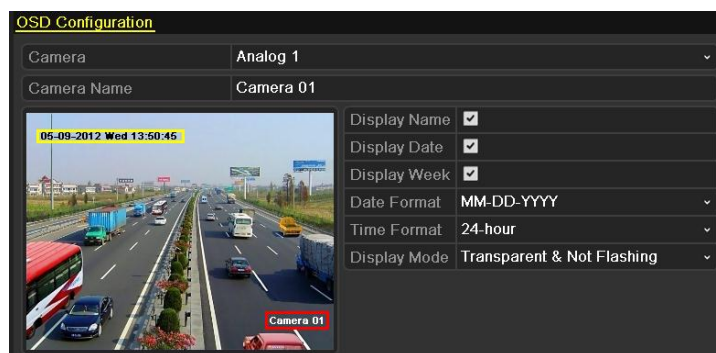

Figure 12. 1 OSD Configuration Interface

6. You can use the mouse to click and drag the text frame on the preview window to adjust the OSD position.
7. Copy Camera Settings
 - 1) If you want to copy the OSD settings of the current camera to other cameras, click **Copy** to enter the Copy Camera interface.



Figure 12. 2 Copy Settings to Other Cameras



Copying the OSD settings to network cameras is not available.

- 2) Select the camera (s) to be configured with the same OSD settings. You can also check Analog checkbox to select all cameras.
 - 3) Click **OK** to finish the Copy settings and back to the OSD Configuration interface.
- 8.** Click **Apply** to apply the settings.

12.2 Configuring Privacy Mask

Purpose:

Privacy mask enables you to cover certain areas on the live video to prevent certain spots in the surveillance area from being live viewed and recorded.

Steps:

1. Enter the Privacy Mask Settings interface.
Menu > Camera > Privacy Mask
2. Select the camera to set privacy mask.
3. Check checkbox to enable privacy mask.



Figure 12.3 Privacy Mask Settings Interface

4. Use the mouse to draw a zone on the window. The zones will be marked with different frame colors.



Up to 4 privacy mask zones can be configured, and the size of each area can be adjusted.

5. The configured privacy mask zones on the window can be cleared by clicking the corresponding Clear Zone1-4 icons on the right side of the window, or click **Clear All** to clear all zones.



Figure 12.4 Set Privacy Mask Area

6. You can click **Copy** to copy the privacy mask settings of the current camera to other cameras. Please refer to step 7 of *Chapter 12.1 Configuring OSD Settings*.



Copying the privacy mask settings to network cameras is not available.

7. Click **Apply** to save the settings.

12.3 Configuring Video Parameters

Steps:

1. Enter the Image Settings interface.

Menu > Camera > Image



Figure 12. 5 Image Settings Interface for Analog Camera Connected to DS-9200 HWI-ST Series

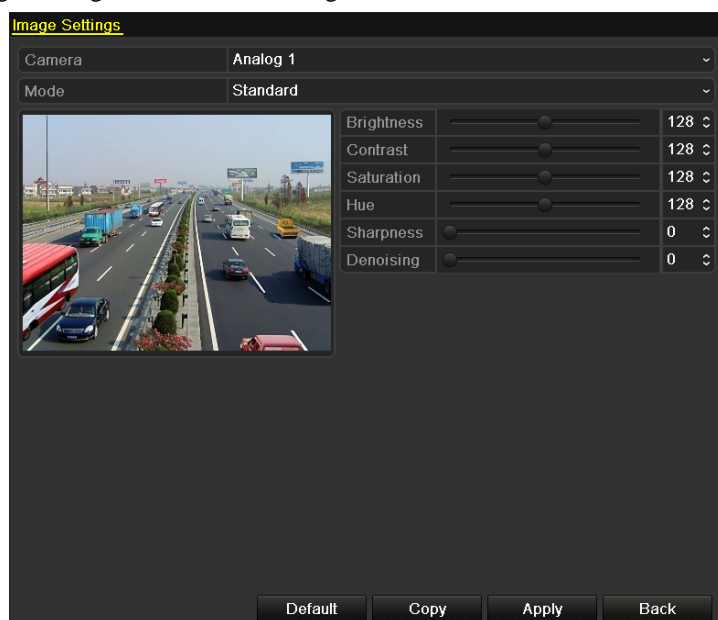

Figure 12. 6 Image Settings Interface for Analog Camera Connected to Other Series

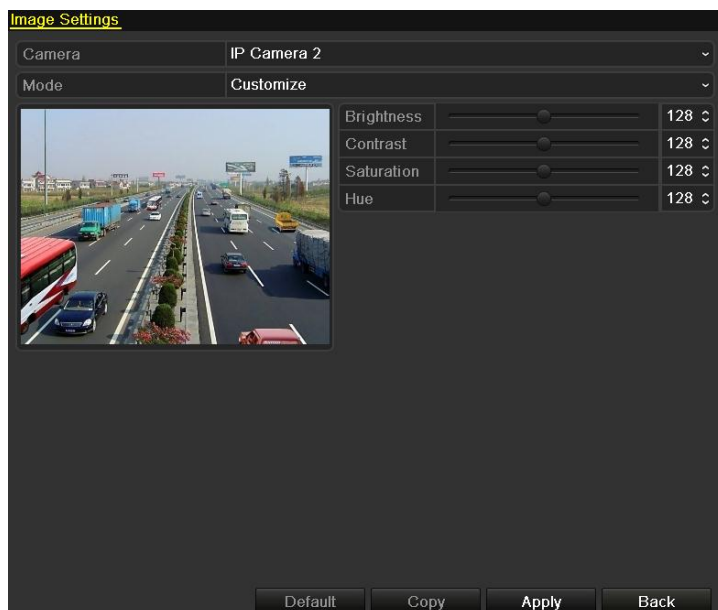

Figure 12. 7 Image Settings Interface for IP Camera



- The defog mode is only available for analog cameras connected to DS-9200 HWI-ST series device. 3 types of defog modes are available: Auto (default), Manual and Disable.
 - IP Camera is supported by the HDVR series.
2. Select the camera to set image parameters.
 3. Select the mode from the drop-down list of **Mode**. For analog cameras, four modes are selectable: Standard, Indoor, Dim Light and Outdoor. While for IP cameras, only Customize is supported.
 4. Adjust the image parameters according to actual needs. The parameters are including Brightness, Contrast, Saturation, Hue, Sharpness and Denoising. You can also click **Default** to restore the default settings.



Sharpness, Denoising and restoring default settings are not supported by IP cameras.

5. You can click **Copy** to copy the image settings of the current camera to other analog cameras.



Copying the image settings to IP cameras is not available.

6. Click **Apply** to save the settings.

Chapter 13 Device Management and Maintenance

13.1 Viewing System Information

13.1.1 Viewing Device Information

Steps:

1. Enter the System Information interface.
Menu > Maintenance > System Info
2. Click the **Device Info** tab to enter the Device Information interface to view the device name, model, serial No. , firmware version and encoding version.

Device Info	Camera	Record	Alarm	Network	HDD
Device Name	9116				
Model	XXXXXXXXXX				
Serial No.	XXXXXXXXXXXXXXXXXXXX				
Firmware Version	VX.X.X				
Encoding Version	VX.X.X				

Figure 13. 1 Device Information Interface

13.1.2 Viewing Camera Information

Steps:

1. Enter the System Information interface.
Menu > Maintenance > System Info
2. Click the **Camera** tab to enter the Camera Information interface to view the status of each camera.



IP Camera is supported by HDVR series.

Device Info	Camera	Record	Alarm	Network	HDD
Camera...	Camera Name	Status	Motion Det...	Video Tampering...	Video Loss
A1	Camera 01	Enabled	Used	Used	Occur
A2	Camera 02	Enabled	Used	Not used	Not used
A3	Camera 03	Enabled	Used	Not used	Not used
A4	Camera 04	Enabled	Used	Not used	Not used
A5	Camera 05	Enabled	Used	Not used	Not used
A6	Camera 06	Enabled	Used	Not used	Not used
A7	Camera 07	Enabled	Used	Not used	Not used
A8	Camera 08	Enabled	Used	Not used	Not used
A9	Camera 09	Enabled	Used	Not used	Not used
A10	Camera 10	Enabled	Used	Not used	Not used
A11	Camera 11	Enabled	Used	Not used	Not used
A12	Camera 12	Enabled	Used	Not used	Not used
A13	Camera 13	Enabled	Used	Not used	Not used
A14	Camera 14	Enabled	Used	Not used	Not used
A15	Camera 15	Enabled	Used	Not used	Not used

Figure 13. 2 Camera Information Interface for DVR Series

Device Info						Camera	Record	Alarm	Network	HDD
Camera...	Camera Name	Status	Motion Det...	Video Tampering...	Video Loss					
A5	Camera 05	Enabled	Used	Not used	Not used					
A6	Camera 06	Enabled	Used	Not used	Not used					
A7	Camera 07	Enabled	Used	Not used	Not used					
A8	Camera 08	Enabled	Used	Not used	Not used					
A9	Camera 09	Enabled	Used	Not used	Not used					
A10	Camera 10	Enabled	Used	Not used	Not used					
A11	Camera 11	Enabled	Used	Not used	Not used					
A12	Camera 12	Enabled	Used	Not used	Not used					
A13	Camera 13	Enabled	Used	Not used	Not used					
A14	Camera 14	Enabled	Used	Not used	Not used					
A15	Camera 15	Enabled	Used	Not used	Not used					
A16	Camera 16	Enabled	Used	Not used	Not used					
D1	IPCamera 08	Conne...	Used	Not used	Not used					
D2	Camera05	Discon...	Not support...	Not supported	Not support...					

Figure 13. 3 Camera Information Interface for HDVR Series

13.1.3 Viewing Record Information

Steps:

1. Enter the System Information interface.
Menu > Maintenance > System Info
2. Click the **Record** tab to enter the Record Information interface to view the recording status and encoding parameters of each camera.



IP Camera is supported by HDVR series.

Device Info										Camera	Record	Alarm	Network	HDD
Camera...	Recor...	Stream...	Frame ...	Bitrate(Kbps)	Resolution	Recor...	Encodi...	Redun...						
A1	Used	Video ...	25fps	61/1792	704*576(4...	Manual	Contin...	Yes						
A2	Used	Video ...	25fps	83/1792	704*576(4...	Manual	Contin...	No						
A3	Not used	Video ...	25fps	83/1792	704*576(4...		Contin...	No						
A4	Not used	Video ...	25fps	82/1792	704*576(4...		Contin...	No						
A5	Not used	Video ...	25fps	83/1792	704*576(4...		Contin...	No						
A6	Not used	Video ...	25fps	83/1792	704*576(4...		Contin...	No						
A7	Not used	Video ...	25fps	82/1792	704*576(4...		Contin...	No						
A8	Not used	Video ...	25fps	83/1792	704*576(4...		Contin...	No						
A9	Not used	Video ...	25fps	80/1792	704*576(4...		Contin...	No						
A10	Not used	Video ...	25fps	83/1792	704*576(4...		Contin...	No						
A11	Not used	Video ...	25fps	82/1792	704*576(4...		Contin...	No						
A12	Not used	Video ...	25fps	82/1792	704*576(4...		Contin...	No						
A13	Not used	Video ...	25fps	82/1792	704*576(4...		Contin...	No						
A14	Not used	Video ...	25fps	81/1792	704*576(4...		Contin...	No						
A15	Not used	Video ...	25fps	81/1792	704*576(4...		Contin...	No						

Figure 13. 4 Record Information Interface for DVR Series

Device Info	Camera	Record	Alarm	Network	HDD			
Camer...	Recor...	Stream...	Frame ...	Bitrate(Kbps)	Resolution	Recor...	Encodi...	Redun...
A4	Not used	Video ...	25fps	132/1792	704*576(4...	Contin...	No	
A5	Not used	Video ...	25fps	81/1792	704*576(4...	Contin...	No	
A6	Not used	Video ...	25fps	81/1792	704*576(4...	Contin...	No	
A7	Not used	Video ...	25fps	82/1792	704*576(4...	Contin...	No	
A8	Not used	Video ...	25fps	83/1792	704*576(4...	Contin...	No	
A9	Not used	Video ...	25fps	81/1792	704*576(4...	Contin...	No	
A10	Not used	Video ...	25fps	82/1792	704*576(4...	Contin...	No	
A11	Not used	Video ...	25fps	81/1792	704*576(4...	Contin...	No	
A12	Not used	Video ...	25fps	81/1792	704*576(4...	Contin...	No	
A13	Not used	Video ...	25fps	81/1792	704*576(4...	Contin...	No	
A14	Not used	Video ...	25fps	81/1792	704*576(4...	Contin...	No	
A15	Not used	Video ...	25fps	82/1792	704*576(4...	Contin...	No	
A16	Not used	Video & Audio	25fps	82/1792	704*576(4...	Contin...	No	
D1	Used	Video ...	25fps	2048	704*576(4...	Manual	Contin...	No
D2	Not used	Video ...	25fps	2048	Unknown ...	Contin...	No	

Figure 13. 5 Record Information Interface for HDVR Series

13.1.4 Viewing Alarm Information



This function is not available for DS-7200 series.

Steps:

1. Enter the System Information interface.
Menu > Maintenance > System Info
2. Click the **Alarm** tab to enter the Alarm Information interface to view the alarm information.

Device Info	Camera	Record	Alarm	Network	HDD
No.	Alarm Name	Alarm Type	Alarm Status	Triggered	Camera
Local<-1		N.C	Occur	D3~D4	D7
Local<-2		N.O	Used		
Local<-3		N.O	Used		
Local<-4		N.O	Used		
Local<-5		N.O	Used		
Local<-6		N.C	Occur	D3~D4	D7
Local<-7		N.O	Used		
Local<-8		N.O	Used		
Local<-9		N.O	Used		
Local<-10		N.C	Occur		
Local<-11		N.C	Occur		
Local<-12		N.O	Used		
Local<-13		N.O	Used		
Local<-14		N.O	Used		
Local<-15		N.O	Used		

Figure 13. 6 Alarm Information Interface

13.1.5 Viewing Network Information

Steps:

1. Enter the System Information interface.

Menu > Maintenance > System Info

2. Click the **Network** tab to enter the Network Information interface to view the network information.

Device Info		Camera	Record	Alarm	<u>Network</u>	HDD
NIC	bond0					
IPv4 Address	172.6.23.163					
IPv4 Subnet Mask	255.255.255.0					
IPv4 Default Gateway	172.6.23.1					
IPv6 Address 1	fe80::240:48ff:fe94:580e/64					
IPv6 Address 2						
IPv6 Default Gateway						
Preferred DNS Server	0.0.0.0					
Alternate DNS Server	0.0.0.0					
Enable DHCP	Disabled					
Enable PPPOE	Disabled					
PPPOE Address						
PPPOE Subnet Mask						
PPPOE Default Gateway						
Main NIC	LAN1					

Figure 13.7 Network Information Interface

13.1.6 Viewing HDD Information

Steps:

1. Enter the System Information interface.
Menu > Maintenance > System Info
2. Click the **HDD** tab to enter the HDD Information menu to view the HDD status, free space, property, etc.

Device Info		Camera	Record	Alarm	Network	<u>HDD</u>
Label	Status	Capacity	Free Space	Property	Type	Group
1	Normal	1,862GB	1,842GB	RAW	Array	1

Figure 13.8 HDD Information Interface

13.2 Searching & Exporting Log Files

Purpose:

The operation, alarm, exception, information and running status of the device can be stored in log files, which can be viewed and exported at any time.

Steps:

1. Enter the Log Search interface.

Menu > Maintenance > Log Information > Log Search

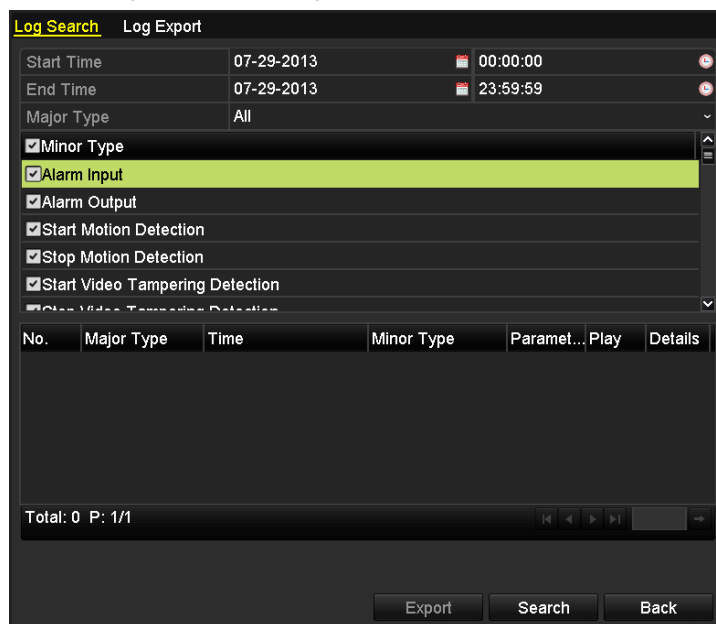

Figure 13. 9 Log Search Interface

2. Specify the search conditions for the log search, including the Start Time, End Time, Major Type and Minor Type.
3. Click **Search** to start searching log files.
4. The matched log files will be displayed on the list shown below.



Up to 2000 log files can be displayed each time.

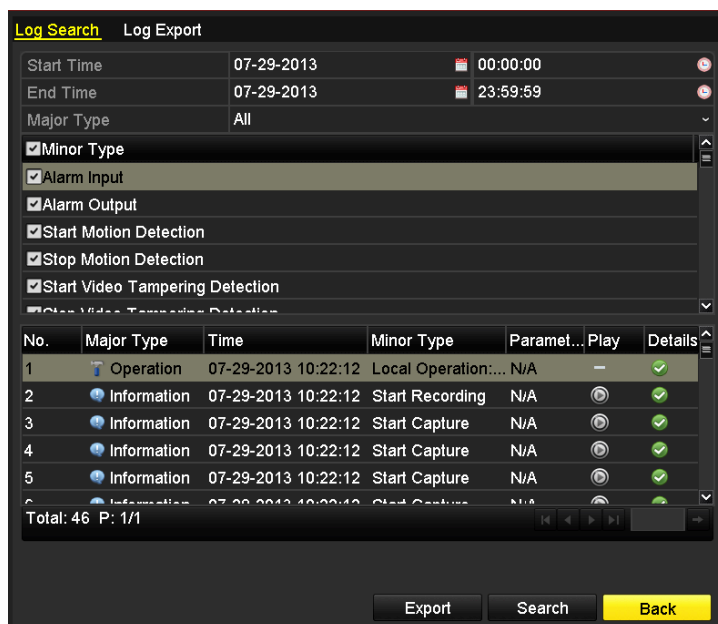

Figure 13. 10 Log Search Results

5. You can click of each log or double-click the log to view its detailed information. And you can also click the button to view the related video files if available.

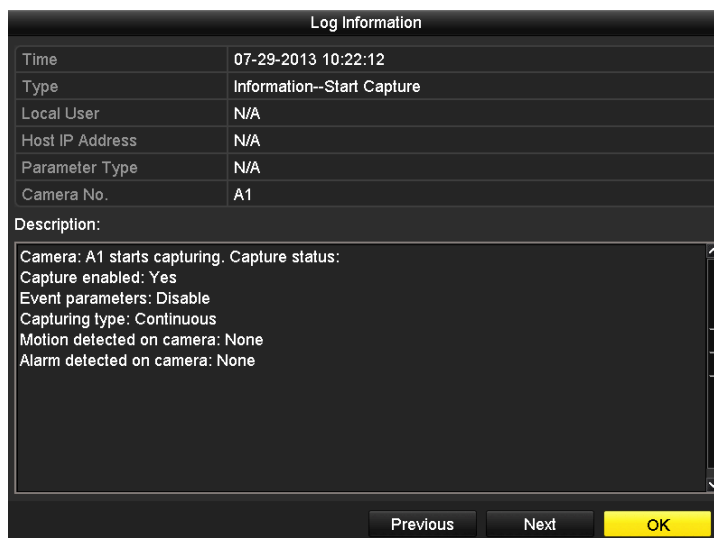

Figure 13. 11 Log Details

6. If you want to export the log files, select the log and click **Export** to enter the Export interface.
7. You can also export all the log files stored in the HDD. Enter the Log Export interface.
 Menu > Maintenance > Log Information > Log Export

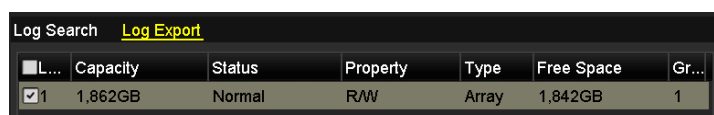

Figure 13. 12 Log Export Interface

- Check checkbox to select the disk and click **Export** to enter the export interface.



Figure 13. 13 Export Log Files

8. Select the backup device from the drop-down list of **Device Name**.

9. Click **Export** to export the log files to the selected backup device.

You can click **New Folder** to create new folder in the backup device, or click **Format** to format the backup device before log export.



Please connect the backup device to device before operating log export.

The log files exported to the backup device are named by exporting time, e.g., *201307291054411logBack.txt*.

13.3 Importing/Exporting Configuration Files

Purpose:

The configuration files of the device can be exported to local device for backup; and the configuration files of one device can be imported to multiple devices if they are to be configured with the same parameters.

Steps:

1. Enter the Import/Export Configuration File interface.

Menu > Maintenance > Import/Export



Figure 13. 14 Import/Export Config File

2. Click **Export** to export configuration files to the selected local backup device.
3. To import a configuration file, select the file from the selected backup device and click **Import**. After the import process is completed, you must reboot the device.



After having finished the import of configuration files, the device will reboot automatically.

13.4 Upgrading System

Purpose:

The firmware on your device can be upgraded by local backup device or remote FTP server.

13.4.1 Upgrading by Local Backup Device

Steps:

1. Connect your device with a local backup device where the update firmware file is located.
2. Enter the Upgrade interface.
Menu > Maintenance > Upgrade
3. Click the **Local Upgrade** tab to enter the local upgrade menu.

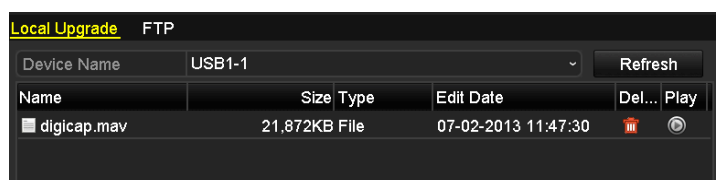

Figure 13. 15 Local Upgrade Interface

4. Select the update file from the backup device.
5. Click **Upgrade** to start upgrading.
6. After the upgrading is complete, reboot the device to activate the new firmware.

13.4.2 Upgrading by FTP

Before you start:

Configure PC (running FTP server) and device to the same Local Area Network. Run the 3rd-party TFTP software on the PC and copy the firmware into the root directory of TFTP.

Steps:

1. Enter the Upgrade interface.
Menu > Maintenance > Upgrade
2. Click the **FTP** tab to enter the local upgrade interface.

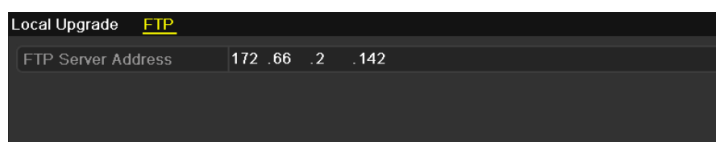

Figure 13. 16 FTP Upgrade Interface

3. Enter the FTP Server Address in the text field.
4. Click **Upgrade** to start upgrading.
5. After the upgrading is complete, reboot the device to activate the new firmware.

13.5 Restoring Default Settings

Steps:

1. Enter the Default interface.
Menu > Maintenance > Default

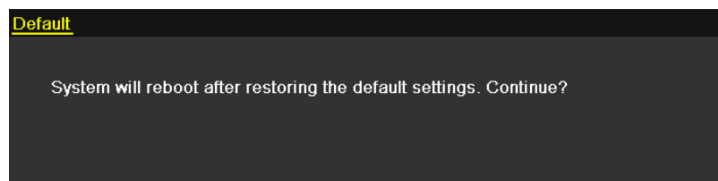

Figure 13. 17 Restore Default Settings

2. Click **OK** to restore the default settings.



Except the network parameters (including IP address, subnet mask, gateway, MTU, NIC working mode, default route and server port), all other parameters of the device will be restored to factory default settings.

Chapter 14 Others

14.1 Configuring RS-232 Serial Port

Purpose:

The RS-232 port can be used in two ways:

Parameters Configuration: Connect a PC to the device through the PC serial port. Device parameters can be configured by using software such as HyperTerminal. The serial port parameters must be the same as the device's when connecting with the PC serial port.

Transparent Channel: Connect a serial device directly to the device. The serial device will be controlled remotely by the PC through the network.



RS-232 serial port is not available for DS-7200HWI-SV series.

Steps:

1. Enter the RS-232 Settings interface.

Menu > Configuration > RS-232

A screenshot of the RS-232 Settings interface. The title is "RS-232 Settings" in yellow. Below it is a table with two columns: the parameter name and its current value. Each row has a small downward arrow on the right side, indicating it's a dropdown menu.

RS-232 Settings	
Baud Rate	115200
Data Bit	8
Stop Bit	1
Parity	None
Flow Ctrl	None
Usage	Console

Figure 14. 1 RS-232 Settings Interface

2. Configure RS-232 parameters, including baud rate, data bit, stop bit, parity, flow control and usage.
3. Click **Apply** to save the settings.

14.2 Configuring General Settings

Purpose:

You can configure the BNC output standard, VGA output resolution, mouse pointer speed, etc.

Steps:

1. Enter the General Settings interface.
Menu > Configuration > General
2. Select the **General** tab.

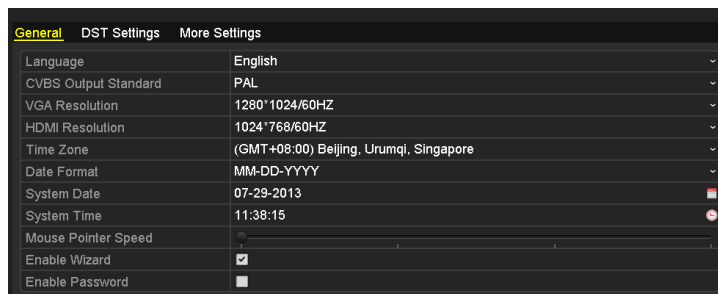

Figure 14. 2 General Settings Interface When HDMI/VGA Simultaneous Output Disabled

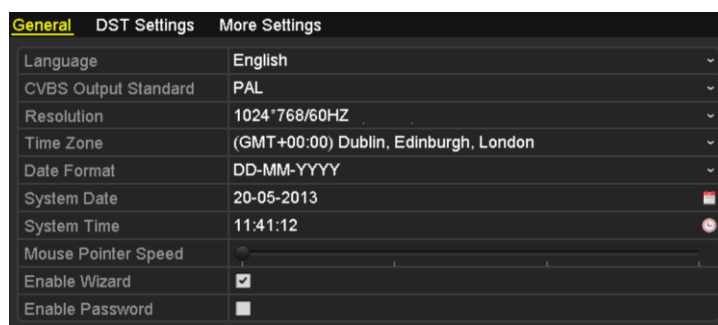

Figure 14. 3 General Settings Interface When HDMI/VGA Simultaneous Output Enabled

3. Configure the following settings:

- **Language:** The default language used is *English*.
- **CVBS Output Standard:** Select the CVBS output standard to NTSC or PAL, which must be the same with the video input standard.
- **VGA Resolution:** Select the VGA output resolution, which must be the same with the resolution of the monitor screen.
- **HDMI Resolution:** Select the HDMI resolution, which must be the same with the resolution of the monitor screen.
- **Resolution:** Select the resolution for the VGA and HDMI output, which must be the same with the resolution of the monitor screen.



When HDMI/VGA Simultaneous Output is disabled (Menu >Configuration >More Settings), individual operation and settings can be achieved on VGA output and HDMI output.

- **Time Zone:** Select the time zone.
- **Date Format:** Select the date format.
- **System Date:** Select the system date.

- **System Time:** Select the system time.
 - **Mouse Pointer Speed:** Set the speed of mouse pointer; 4 levels are configurable.
 - **Enable Wizard:** Enable/disable the Wizard when the device starts up.
 - **Enable Password:** Enable/disable the use of the login password.
4. Click **Apply** to save the settings.

14.3 Configuring DST Settings

Steps:

1. Enter the General Settings interface.

Menu >Configuration>General

2. Choose **DST Settings** tab.

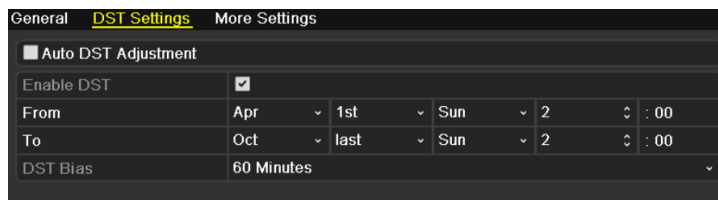

Figure 14. 4 DST *Settings* Interface

You can check checkbox before the **Auto DST Adjustment** item.

Or you can manually check the **Enable DST** checkbox, and then you choose the date of the DST period.

14.4 Configuring More Settings

Steps:

1. Enter the General Settings interface.
Menu > Configuration > General
2. Click the **More Settings** tab to enter the More Settings interface.

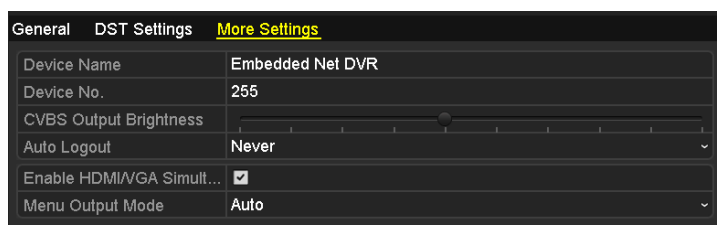

Figure 14. 5 More *Settings* Interface

3. Configure the following settings:
 - **Device Name:** Edit the name of device.
 - **Device No.:** Edit the serial number of device. The Device No. can be set in the range of 1~255, and the default No. is 255.
 - **CVBS Output Brightness:** Adjust the video output brightness.
 - **Auto Logout:** Set timeout time for menu inactivity. E.g., when the time is set to *5 Minutes*, then the system will exit from the current operation menu to live view screen after 5 minutes of menu inactivity.
 - **Enable HDMI/VGA Simultaneous Output:** The operation and settings on VGA output and HDMI output cannot be achieved respectively when this function is enabled.



This function is not available for 9100/9000/8100/8000HWI-ST & 7200HWI-SV series.

- **Menu Output Mode:** Set the menu output mode as Auto, HDMI, VGA or Main CVBS. E.g., when VGA is selected and VGA output interface is connected, then the menu will be displayed on VGA monitor.



When HDMI/VGA Simultaneous Output is enabled, Auto, HDMI/VGA and Main CVBS are selectable for Menu Output Mode.

4. Click **Apply** to save the settings.

14.5 Managing User Accounts

Purpose:

There is a default account in the device: *Administrator*. The *Administrator* user name is *admin* and the password is *12345*. The *Administrator* has the permission to add and delete user and configure user parameters.

14.5.1 Adding a User

Steps:

1. Enter the User Management interface.

Menu > Configuration > User

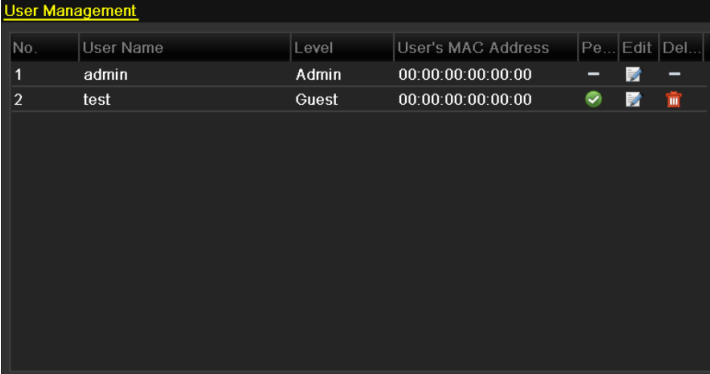

No.	User Name	Level	User's MAC Address	Pe...	Edit	Del...
1	admin	Admin	00:00:00:00:00:00	—	✎	✖
2	test	Guest	00:00:00:00:00:00	✓	✎	✖

Figure 14. 6 User Management Interface

2. Click **Add** to enter the Add User interface.



Add User	
User Name	test02
Password	*****
Confirm	*****
Level	Guest
User's MAC Address	00 :00 :00 :00 :00 :00
OK Cancel	

Figure 14. 7 Add User Menu

3. Enter the information for new user, including **User Name**, **Password**, **Level** and **User's MAC Address**.

Level: Set the user level to Operator or Guest. Different user levels have different operating permission.

- **Operator:** The *Operator* user level has permission of Local Log Search in Local Configuration, Remote Log Search and Two-way Audio in Remote Configuration and all operating permission in Camera Configuration.

- **Guest:** The *Guest* user has permission of Local Log Search in Local Configuration, Remote Log Search in Remote Configuration and only has the local/remote playback in the Camera Configuration.
- User's MAC Address:** The MAC address of the remote PC which logs onto the device. If it is configured and enabled, it only allows the remote user with this MAC address to access the device.
4. Click **OK** to save the settings and go back to the User Management interface. The added new user will be displayed on the list.

No.	User Name	Level	User's MAC Address	Pe...	Edit	Del...
1	admin	Admin	00:00:00:00:00:00	—	✎	✖
2	test	Guest	00:00:00:00:00:00	✓	✎	✖
3	test02	Operator	00:00:00:00:00:00	✓	✎	✖

Figure 14. 8 Added User Listed in User Management Interface

5. Select the user from the list and then click the  button to enter the Permission Settings interface.

Permission

Local Configuration Remote Configuration Camera Configuration

Local Log Search

Local Parameters Settings

Local Advanced Operation

Local Shutdown / Reboot

Apply OK Cancel

Figure 14. 9 User Permission Settings Interface for DVR Series

Permission

Local Configuration Remote Configuration Camera Configuration

Local Log Search

Local Parameters Settings

Local Camera Management

Local Advanced Operation

Local Shutdown / Reboot

Apply OK Cancel

Figure 14. 10 User Permission Settings Interface for HDVR Series



Local Camera Management is supported by HDVR series.

6. Set the operating permission of Local Configuration, Remote Configuration and Camera Configuration for the user.

Local Configuration

- Local Log Search: Searching and viewing logs and system information of device.
- Local Parameters Settings: Configuring parameters, restoring factory default parameters and importing/exporting configuration files.
- Local Camera Management: Enabling and disabling analog camera (s). Adding, deleting and editing of network camera (s). This function is supported by HDVR series.
- Local Advanced Operation: Operating HDD management (initializing HDD, setting HDD property), upgrading system firmware, clearing I/O alarm output.
- Local Shutdown /Reboot: Shutting down or rebooting the device.

Remote Configuration

- Remote Log Search: Remotely viewing logs that are saved on the device.
- Remote Parameters Settings: Remotely configuring parameters, restoring factory default parameters and importing/exporting configuration files.
- Remote Camera Management: Remotely enabling and disabling analog camera (s), and adding, deleting and editing of network camera (s). This function is supported by HDVR series.
- Remote Serial Port Control: Configuring settings for RS-232 and RS-485 ports.
- Remote Video Output Control: Sending remote control panel signal.
- Two-way Audio: Realizing two-way radio between the remote client and the device.
- Remote Alarm Control: Remotely arming (notify alarm and exception message to the remote client) and controlling the alarm output.
- Remote Advanced Operation: Remotely operating HDD management (initializing HDD, setting HDD property), upgrading system firmware, clearing I/O alarm output.
- Remote Shutdown/Reboot: Remotely shutting down or rebooting the device.

Camera Configuration

- Remote Live View: Remotely viewing live video of the selected camera (s).
- Local Manual Operation: Locally starting/stopping manual recording, picture capturing and alarm output of the selected camera (s).
- Remote Manual Operation: Remotely starting/stopping manual recording, picture capturing and alarm output of the selected camera (s).
- Local Playback: Locally playing back recorded files of the selected camera (s).
- Remote Playback: Remotely playing back recorded files of the selected camera (s).
- Local PTZ Control: Locally controlling PTZ movement of the selected camera (s).
- Remote PTZ Control: Remotely controlling PTZ movement of the selected camera (s).
- Local Video Export: Locally exporting recorded files of the selected camera (s).

7. Click **OK** to save the settings and exit interface.



Only the *admin* user account has the permission of restoring factory default parameters.

14.5.2 Deleting a User

Steps:

1. Enter the User Management interface.
Menu > Configuration > User
2. Select the user to be deleted from the list.

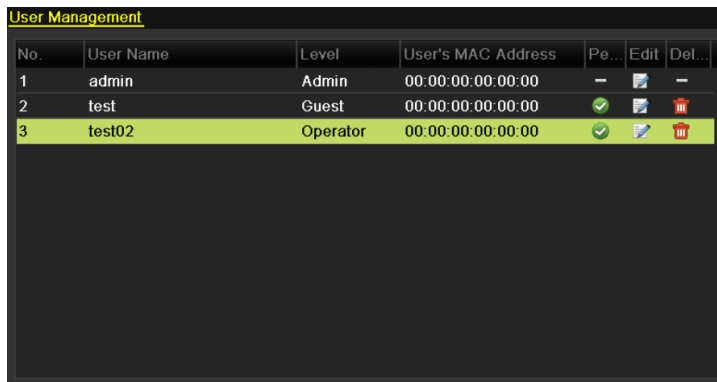

Figure 14. 11 Delete a User

3. Click to delete the selected user.

14.5.3 Editing a User

Steps:

1. Enter the User Management interface.
Menu > Configuration > User
2. Select the user to be edited from the list.

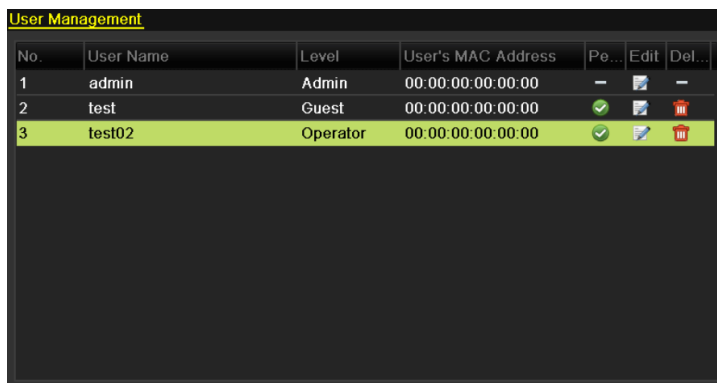

Figure 14. 12 Edit a User

3. Click to enter the Edit User interface.



Figure 14. 13 Edit User Interface

4. Edit the user information, including user name, password, level and MAC address.



If you want to change the password of the user, check checkbox to enable changing the password.

5. Click **OK** to save the settings and exit the menu.

14.5.4 Changing Password of Admin

Steps:

1. Enter the User Management interface.

Menu > Configuration > User

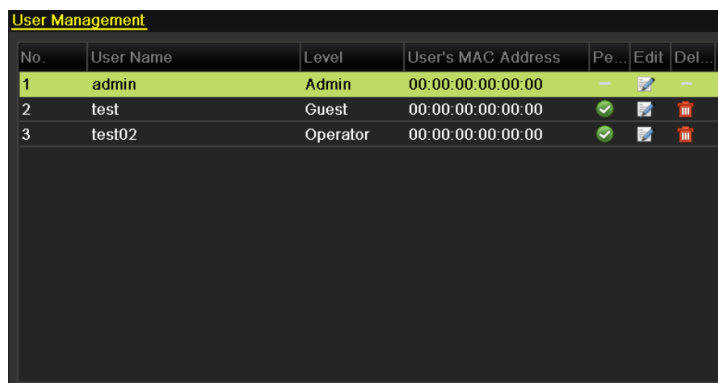

Figure 14. 14 Change Password

2. Select the *admin* user and click to change the password.

Edit User	
User Name	admin
Old Password	
Change Password	<input checked="" type="checkbox"/>
Password	
Confirm	
User's MAC Address	00 :00 :00 :00 :00 :00

Apply OK Cancel

Figure 14. 15 Change Password

-
3. Enter the old password, check checkbox, enter new password and confirm password on the menu.
 4. Click **OK** to save the settings and exit the menu.

14.6 Logging out / Shutting down / Rebooting Device

Steps:

1. Enter the Shutdown interface.

Menu > Shutdown

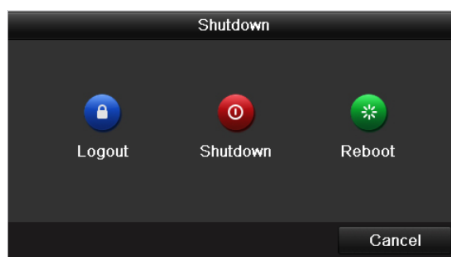





Figure 14. 16 Shutdown Menu

2. Click  to log out, or
Click  to shut down the device, or
Click  to reboot the device.



After you have logged out the system, menu operation on the screen is invalid. It is required a user name and password to log in to the system.

Chapter 15 Appendix

Glossary

- **Dual Stream:** Dual stream is a technology used to record high resolution video locally while transmitting a lower resolution stream over the network. The two streams are generated by the device, with the main stream having a maximum resolution of 4CIF and the sub-stream having a maximum resolution of CIF.
- **DVR:** Acronym for Digital Video Recorder. A DVR is device that is able to accept video signals from analog cameras, compress the signal and store it on its hard drives.
- **HDD:** Acronym for Hard Disk Drive. A storage medium which stores digitally encoded data on platters with magnetic surfaces.
- **DHCP:** Dynamic Host Configuration Protocol (DHCP) is a network application protocol used by devices (DHCP clients) to obtain configuration information for operation in an Internet Protocol network.
- **HTTP:** Acronym for Hypertext Transfer Protocol. A protocol to transfer hypertext request and information between servers and browsers over a network
- **PPPoE:** PPPoE, Point-to-Point Protocol over Ethernet, is a network protocol for encapsulating Point-to-Point Protocol (PPP) frames inside Ethernet frames. It is used mainly with ADSL services where individual users connect to the ADSL transceiver (modem) over Ethernet and in plain Metro Ethernet networks.
- **DDNS:** Dynamic DNS is a method, protocol, or network service that provides the capability for a networked device, such as a router or computer system using the Internet Protocol Suite, to notify a domain name server to change, in real time (ad-hoc) the active DNS configuration of its configured hostnames, addresses or other information stored in DNS.
- **Hybrid DVR:** A hybrid DVR is a combination of a DVR and NVR.
- **NTP:** Acronym for Network Time Protocol. A protocol designed to synchronize the clocks of computers over a network.
- **NTSC:** Acronym for National Television System Committee. NTSC is an analog television standard used in such countries as the United States and Japan. Each frame of an NTSC signal contains 525 scan lines at 60Hz.
- **NVR:** Acronym for Network Video Recorder. An NVR can be a PC-based or embedded system used for centralized management and storage for IP cameras, IP Domes and other DVRs.
- **PAL:** Acronym for Phase Alternating Line. PAL is also another video standard used in broadcast televisions systems in large parts of the world. PAL signal contains 625 scan lines at 50Hz.
- **PTZ:** Acronym for Pan, Tilt, Zoom. PTZ cameras are motor driven systems that allow the camera to pan left and right, tilt up and down and zoom in and out.
- **USB:** Acronym for Universal Serial Bus. USB is a plug-and-play serial bus standard to interface devices to a host computer.

Troubleshooting

No image displayed on the monitor after the device is starting up normally.

Possible Reasons

- a) No VGA or HDMI connections.
- b) Connection cable is damaged.
- c) Input mode of the monitor is incorrect.

Steps

1. Verify the device is connected with the monitor via HDMI or VGA cable.
If not, please connect the device with the monitor and reboot.
2. Verify the connection cable is good.
If there is still no image display on the monitor after rebooting, please check if the connection cable is good, and change a cable to connect again.
3. Verify Input mode of the monitor is correct.
Please check the input mode of the monitor matches with the output mode of the device (e.g. if the output mode of DVR is HDMI output, then the input mode of monitor must be the HDMI input). And if not, please modify the input mode of monitor.
4. Check if the fault is solved by the step 1 to step 3.
If it is solved, finish the process.
If not, please contact the engineer from our company to do the further process.

● **There is an audible warning sound “Di-Di-Di-Didi” after a new bought device starts up.**

Possible Reasons

- a) No HDD is installed in the device.
- b) The installed HDD has not been initialized.
- c) The installed HDD is not compatible with the device or is broken-down.

Steps

1. Verify at least one HDD is installed in the device.
 - 1) If not, please install the compatible HDD.



Please refer to the “Quick Operation Guide” for the HDD installation steps.

- 2) If you don't want to install a HDD, select “Menu>Configuration > Exceptions”, and uncheck the Audible Warning checkbox of “HDD Error”.
2. Verify the HDD is initialized.
 - 1) Select “Menu>HDD>General”.
 - 2) If the status of the HDD is “Uninitialized”, please check the checkbox of corresponding HDD and click the “Init” button.
3. Verify the HDD is detected or is in good condition.
 - 1) Select “Menu>HDD>General”.
 - 2) If the HDD is not detected or the status is “Abnormal”, please replace the dedicated HDD according to the requirement.

4. Check if the fault is solved by the step 1 to step 3.
 - 1) If it is solved, finish the process.
 - 2) If not, please contact the engineer from our company to do the further process.

- **The status of the added IPC displays as “Disconnected” when it is connected through the protocol of our company. Select “Menu>Camera>Camera>IP Camera” to get the camera status.**

Possible Reasons

- a) Network failure, and the DVR and IPC lost connections.
- b) The configured parameters are incorrect when adding the IPC.
- c) Insufficient bandwidth.

Steps

1. Verify the network is connected.
 - 1) Connect the HDVR and PC with the RS-232 cable.
 - 2) Open the Super Terminal software, and execute the ping command. Input “ping IP” (e.g. ping 172.6.22.131).



Simultaneously press **Ctrl** and **C** to exit the ping command.

If there exists return information and the time value is little, the network is normal.

2. Verify the configuration parameters are correct.
 - 1) Select “Menu>Camera>Camera>IP Camera”.
 - 2) Verify the following parameters are the same with those of the connected IP devices, including IP address, protocol, management port, user name and password.
3. Verify the whether the bandwidth is enough.
 - 1) Select “Menu >Maintenance > Net Detect > Network Stat.”.
 - 2) Check the usage of the access bandwidth, and see if the total bandwidth has reached its limit.
4. Check if the fault is solved by the step 1 to step 3.

If it is solved, finish the process.

If not, please contact the engineer from our company to do the further process.

- **The IPC frequently goes online and offline and the status of it displays as “Disconnected”.**

Possible Reasons

- a) The IPC and the HDVR versions are not compatible.
- b) Unstable power supply of IPC.
- c) Unstable network between IPC and HDVR.
- d) Limited flow by the switch connected with IPC and HDVR.

Steps

1. Verify the IPC and the HDVR versions are compatible.
 - 1) Enter the IPC Management interface “Menu > Camera > Camera>IP Camera”, and view the firmware version of connected IPC.
 - 2) Enter the System Info interface “Menu>Maintenance>System Info>Device Info”, and view the firmware version of HDVR.
2. Verify power supply of IPC is stable.

- 1) Verify the power indicator is normal.
- 2) When the IPC is offline, please try the ping command on PC to check if the PC connects with the IPC.
3. Verify the network between IPC and HDVR is stable.
 - 1) When the IPC is offline, connect PC and HDVR with the RS-232 cable.
 - 2) Open the Super Terminal, use the ping command and keep sending large data packages to the connected IPC, and check if there exists packet loss.



Simultaneously press **Ctrl** and **C** to exit the ping command.

Example: Input ping 172.6.22.131 -l 1472 -f.

4. Verify the switch is not flow control.

Check the brand, model of the switch connecting IPC and HDVR, and contact with the manufacturer of the switch to check if it has the function of flow control. If so, please turn it down.
5. Check if the fault is solved by the step 1 to step 4.

If it is solved, finish the process.

If not, please contact the engineer from our company to do the further process.

- **When there is no monitor connected to the HDVR and you add the IPC via web browser, the IPC status shows as Connected; and then you connect the HDVR with the monitor via VGA or HDMI interface and reboot the device, there is black screen with the mouse cursor.**

Connect the HDVR with the monitor before startup via VGA or HDMI interface, and manage the IPC to connect with the device locally or remotely, the status of IPC displays as Connected. And then connect the device with the CVBS, and there is black screen either.

Possible Reasons:

After connecting the IPC to the HDVR, the image is output via the main spot interface by default.

Steps:

1. Enable the output channel.
2. Select "Menu > Configuration > Live View > View", and select video output interface in the drop-down list and configure the window you want to view.



- The view settings can only be configured by the local operation of HDVR.
 - Different camera orders and window-division modes can be set for different output interfaces separately, and digits like "D1" and "D2" stands for the channel number, and "X" means the selected window has no image output.
3. Check if the fault is solved by the above steps.

If it is solved, finish the process.

If not, please contact the engineer from our company to do the further process.

Live view stuck when video outputs locally.

Possible Reasons:

- a) Poor network between device and IPC, and there exists packet loss during the transmission.
- b) The frame rate has not reached the real-time frame rate.

Steps:

1. Verify the network between device and IPC is connected.

- 1) When image is stuck, connect the RS-232 ports on PC and the rear panel of device with the RS-232 cable.
- 2) Open the Super Terminal, and execute the command of “**ping 192.168.0.0 -l 1472 -f**” (the IP address may change according to the real condition), and check if there exists packet loss.



Simultaneously press **Ctrl** and **C** to exit the ping command.

2. Check the parameters of Main Stream (Continuous) and Main Stream (Event).
Select “Menu > Record > Parameters > Record”, and set the resolution of Main Stream (Event) the same as the one of Main Stream (Continuous).
3. Verify the frame rate is real-time frame rate.
Select “Menu > Record > Parameters > Record”, and set the Frame rate to Full Frame.
4. Check if the fault is solved by the above steps.
If it is solved, finish the process.
If not, please contact the engineer from our company to do the further process.

When using the device to get the live view audio, there is no sound or there is too much noise, or the volume is too low.

Possible Reasons:

- a) Cable between the pickup and camera is not connected well; impedance mismatches or incompatible.
- b) The stream type is not set as “Video & Audio”.
- c) The encoding standard is not supported with device.

Steps:

1. Verify the cable between the pickup and camera is connected well; impedance matches and compatible.
2. Verify the setting parameters are correct.
Select “Menu > Record > Parameters > Record”, and set the Stream Type as “Audio & Video”.
3. Verify the audio encoding standard of the camera is supported by the HDVR.
HDVR supports G722.1 and G711 standards, and if the encoding parameter of the input audio is not one of the previous two standards, you can log in the IPC to configure it to the supported standard.
4. Check if the fault is solved by the above steps.
If it is solved, finish the process.
If not, please contact the engineer from our company to do the further process.

The image gets stuck when HDVR is playing back by single or multi-channel IPC.

Possible Reasons:

- a) Poor network between HDVR and IPC, and there exists packet loss during the transmission.
- b) The frame rate is not the real-time frame rate.
- c) The HDVR supports up to 16-channel synchronize playback at the resolution of 4CIF, if you want a 16-channel synchronize playback at the resolution of 720p, the frame extracting may occur, which leads to a slight stuck.

Steps:

1. Verify the network between HDVR and IPC is connected.
 - 1) When image is stuck, connect the RS-232 ports on PC and the rear panel of HDVR with the RS-232 cable.
 - 2) Open the Super Terminal, and execute the command of “**ping 192.168.0.0 -l 1472 -f**” (the IP address may change according to the real condition), and check if there exists packet loss.



Simultaneously press the **Ctrl** and **C** to exit the ping command.

2. Verify the frame rate is real-time frame rate.

Select “Menu > Record > Parameters > Record”, and set the Frame Rate to “Full Frame”.

3. Verify the hardware can afford the playback.

Reduce the channel number of playback.

Select “Menu > Record > Encoding > Record”, and set the resolution and bitrate to a lower level.

4. Reduce the number of local playback channel.

Select “Menu > Playback”, and uncheck the checkbox of unnecessary channels.

5. Check if the fault is solved by the above steps.

If it is solved, finish the process.

If not, please contact the engineer from our company to do the further process.

No record file found in the device local HDD, and the prompt “No record file found” pops up when you search the record files.

Possible Reasons:

- a) The time setting of system is incorrect.
- b) The search condition is incorrect.
- c) The HDD is error or not detected.

Steps:

1. Verify the system time setting is correct.

Select “Menu > Configuration > General > General”, and verify the “Device Time” is correct.

2. Verify the search condition is correct.

Select “Playback”, and verify the channel and time are correct.

3. Verify the HDD status is normal.

Select “Menu > HDD > General” to view the HDD status, and verify the HDD is detected and can be read and written normally.

4. Check if the fault is solved by the above steps.

If it is solved, finish the process.

If not, please contact the engineer from our company to do the further process.

Summary of Changes

Version 3.1.0

Added

1. Support smart IP camera connection, VCA alarm and VCA triggered recording. (Chapter 5.2; Chapter 8.3)
2. Support transfer protocol settings when adding/editing IP cameras. (Chapter 2.2)
3. Support viewing the real-time frame rate, bitrate, and resolution of added IP camera on the live view interface. (Chapter 3.2.4)
4. Support volume adjusting of live view, playback and two-way audio. (Chapter 3.3)
5. Support camera order adjusting on the live view interface. (Chapter 3.3)
6. Support two-way audio record. (Chapter 5.1)
7. Support locking record file when playback. (Chapter 5.9.1)
8. Support marking of normal recording and event recording on the playback process bar. (Chapter 6.1)
9. Support marking of normal recording and event recording on the calendar when playback. (Chapter 6.1.2)
10. Support thumbnail display on the process bar when playback. (Chapter 6.1.1; Chapter 6.1.2)
11. Support volume adjusting of selected camera when playback. (Chapter 6.1.1~Chapter 6.1.4)
12. Support searching and playing back of record files triggered by VCA alarm. (Chapter 6.1.3)
13. Support smart playback of VCA event in 16-time speed. (Chapter 6.1.5)
14. Support smart search of VCA event on the specified area. (Chapter 6.2.2)
15. Support marking record files of multiple channels in two lines when synchronous playback. (Chapter 6.2.4)
16. Support capturing and exporting pictures when playback. (Chapter 7.2)
17. Support remote virtual host and telnet function. (Chapter 9.2.14; Chapter 9.2.15)
18. Support the disk clone function. (Chapter 11.7)

Updated

1. Optimize the layout of soft keyboard. (Chapter 1.4)
2. Optimize the control panel of PTZ, adding the configuration shortcut button on the panel. (Chapter 4.3)

List of Compatible IP Cameras

List of Hikvision IP Cameras



For the list, our company holds right to interpret.

Type	Model	Version	Max. Resolution	Sub-stream	Audio
HD Network Camera	DS-2CD883F-E	V5.1.0 build 131202	2560×1920	√	√
	DS-2CD783F-E(I) DS-2CD783F-E(I)(Z)	V5.1.0 build 131202	2560×1920	√	√
	DS-2CD8283F-E(I)	V5.1.0 build 131202	2560×1920	√	√
	DS-2CD886BF-E	V4.0.3 build 120913	2560×1920	√	√
	DS-2CD886MF-E	V4.0.3 build 120913	2560×1920	√	√
	DS-2CD854F-E	V5.1.0 build 131202	2048×1536	√	√
	DS-2CD754F-E(I) DS-2CD754FWD-EIZ	V5.1.0 build 131202	2048×1536	√	√
	DS-2CD8254F-E(I)	V5.1.0 build 131202	2048×1536	√	√
	DS-2CD7254F-EZH	V5.1.0 build 131202	2048×1536	√	√
	DS-2CD8254FWD-EIZ	V5.1.0 build 131202	1920×1080	√	√
	DS-2CD754FWD-E(I)	V5.1.0 build 131202	1920×1080	√	√
	DS-2CD7254FWD-EIZH	V5.1.0 build 131202	1920×1080	√	√
	DS-2CD7253F-EZH DS-2CD753F-E(I)	V5.1.0 build 131202	1600×1200	√	√
	DS-2CD853F-E	V5.1.0 build 131202	1600×1200	√	√
	DS-2CD8153F-E DS-2CD8253F-E(I)	V5.1.0 build 131202	1600×1200	√	√
	DS-2CD7153-E	V5.1.0 build 131202	1600×1200	√	×
	DS-2CD876BF-E	V4.0.3 build 120913	1600×1200	√	√
	DS-2CD876MF-E	V4.0.3 build 120913	1600×1200	√	√
	DS-2CD877BF	V4.0.3 build 120913	1920×1080	√	√
	DS-2CD855F-E	V5.1.0 build 131202	1920×1080	√	√
	DS-2CD8255F-EIZ	V5.1.0 build 131202	1920×1080	√	√
	DS-2CD752MF-E DS-2CD852MF-E DS-2CD852F-E	V2.0 build 110614	1600×1200	√	√
		V2.0 build 110426			
		V2.0 build 100521			
	DS-2CD862MF-E	V2.0 build 110614	1280×960	√	√
		V2.0 build 110426			
V2.0 build 100521					

Type	Model	Version	Max. Resolution	Sub-stream	Audio
	DS-2CD8464F-EI	V5.1.0 build 131202	1280×960	√	√
	DS-2CD863PF/NF-E	V5.1.0 build 131202	1280×960	√	√
	DS-2CD763PF/NF-E	V5.1.0 build 131202	1280×960	√	√
	DS-2CD763PF/NF-EI	V5.1.0 build 131202	1280×960	√	√
	DS-2CD7263PF/NF-EZH	V5.1.0 build 131202	1280×960	√	√
	DS-2CD7164-E	V5.1.0 build 131202	1280×720	√	×
	DS-2CD864FWD-E	V5.1.0 build 131202	1280×720	√	√
	DS-2CD764FWD-E(I)	V5.1.0 build 131202	1280×720	√	√
	DS-2CD8264FWD-E(I)	V5.1.0 build 131202	1280×720	√	√
	DS-2CD8264FWD-EZ	V5.1.0 build 131202	1280×720	√	√
	DS-2CD2012-I	V5.1.0 build 131202	1280×960	√	×
	DS-2CD2112-I	V5.1.0 build 131202	1280×960	√	×
	DS-2CD2212-I	V5.1.0 build 131202	1280×960	√	×
	DS-2CD2312-I	V5.1.0 build 131202	1280×960	√	×
	DS-2CD2612-I	V5.1.0 build 131202	1280×960	√	×
	DS-2CD2712-I	V5.1.0 build 131202	1280×960	√	×
	DS-2CD2412-I	V5.1.0 build 131202	1280×960	√	√
	DS-2CD2512-I	V5.1.0 build 131202	1280×960	√	√
	DS-2CD2612-IS	V5.1.0 build 131202	1280×960	√	√
	DS-2CD2712-IS	V5.1.0 build 131202	1280×960	√	√
	DS-2CD2010-I	V5.1.0 build 131202	1280×960	√	√
	DS-2CD2110-I	V5.1.0 build 131202	1280×960	√	√
	DS-2CD2210-I	V5.1.0 build 131202	1280×960	√	√
	DS-2CD2310-I	V5.1.0 build 131202	1280×960	√	√
	DS-2CD2410-I	V5.1.0 build 131202	1280×720	√	√
	DS-2CD2810F	V5.1.0 build 131202	1280×960	√	√
	DS-2CD2032-I	V5.1.0 build 131202	2048×1536	√	×
	DS-2CD2132-I	V5.1.0 build 131202	2048×1536	√	×
	DS-2CD2232-I	V5.1.0 build 131202	2048×1536	√	×
	DS-2CD2332-I	V5.1.0 build 131202	2048×1536	√	×
	DS-2CD2632-I	V5.1.0 build 131202	2048×1536	√	×
	DS-2CD2732-I	V5.1.0 build 131202	2048×1536	√	×
	DS-2CD2432-I	V5.1.0 build 131202	2048×1536	√	√
	DS-2CD2532-I	V5.1.0 build 131202	2048×1536	√	√
	DS-2CD2632-IS	V5.1.0 build 131202	2048×1536	√	√
	DS-2CD2732-IS	V5.1.0 build 131202	2048×1536	√	√
	DS-2CD4012F DS-2CD4212F-IS(2.8-12mm) DS-2CD4112F-I(2.8-12mm) DS-2CD4312F-IS	V5.1.0 build 131202	1280×960	√	√

Type	Model	Version	Max. Resolution	Sub-stream	Audio	
	DS-2CD4212F-I(2.8-12mm)	V5.1.0 build 131202	1280×960	√	×	
	DS-2CD6213F	V5.1.0 build 131202	1280×960	√	×	
	DS-2CD6223F	V5.1.0 build 131202	1920×1080	√	×	
	DS-2CD4024F DS-2CD4124F-I(2.8-12mm) DS-2CD4224F-IS DS-2CD4324F-IS	V5.1.0 build 131202	1920×1080	√	√	
	DS-2CD4224F-I	V5.1.0 build 131202	1920×1080	√	×	
	DS-2CD4026FWD	V5.1.0 build 131202	1920×1080	√	√	
	DS-2CD6026FHWD	V5.1.0 build 131202	1920×1080	√	√	
	DS-2CD4032FWD DS-2CD4132FWD-I(2.8-12mm) DS-2CD4232FWD-IS(2.8-12mm) DS-2CD4332FWD-IS	V5.1.0 build 131202	2048×1536	√	√	
	DS-2CD4232FWD-I(2.8-12mm)	V5.1.0 build 131202	2048×1536	√	×	
	DS-2CD4032FHWD DS-2CD4132FHWD-I DS-2CD4332FHWD-IS	V5.1.0 build 131202	2048×1536	√	√	
	DS-2CD4332FHWD-I	V5.1.0 build 131202	2048×1536	√	×	
	DS-2CD4012FWD DS-2CD4112FWD-I DS-2CD4212FWD-IS DS-2CD4312FWD-IS	V5.1.0 build 131202	2048×1536	√	√	
	DS-2CD4026FWD-SDI	V5.1.0 build 131202	2048×1536	√	√	
	DS-2CD4212FWD-I	V5.1.0 build 131202	2048×1536	√	×	
	DS-2CD6412FWD	V5.1.0 build 131202	2048×1536	√	√	
	DS-2CD6233F	V5.1.0 build 131202	2048×1536	√	×	
	DS-2CD6233F-SDI	V5.1.0 build 131202	2048×1536	√	×	
	SD Network Camera	DS-2CD7133F-E	V5.1.0 build 131202	640×480	√	×
		DS-2CD733F-E(I) DS-2CD7233F-EZH	V5.1.0 build 131202	640×480	√	√
		DS-2CD8133F-E DS-2CD8233F-EI DS-2CD8233F-E DS-2CD833F-E DS-2CD8433F-EI	V5.1.0 build 131202	640×480	√	√
DS-2CD802NF DS-2CD812PF DS-2CD832F DS-2CD892PF/NF		V2.0 build 090522 V2.0 build 090715 V2.0 build 110301	704×576	√	√	
DS-2CD893PF(WD)-E		V5.1.0 build 131202	704×576	√	√	

Type	Model	Version	Max. Resolution	Sub-stream	Audio
	DS-2CD793PF(WD)-E(I)	V5.1.0 build 131202	704×576	√	√
	DS-2CD893NF(WD)-E	V5.1.0 build 131202	704×576	√	√
	DS-2CD793NF(WD)-E(I)	V5.1.0 build 131202	704×576	√	√
Intelligent Traffic Camera	DS-2CD9121	V3.4.2 build 130718	1600×1200	×	×
	iDS-2CD9121	V3.4.2 build 130718	1600×1200	×	×
	DS-2CD9121A	V3.5.0 build130906	1600×1200	×	×
	iDS-2CD9121A	V3.5.0 build130906	1600×1200	×	×
	DS-2CD9122	V3.5.0 build131012	1920×1080	×	×
	DS-2CD9122-H	V3.5.0 build131018	1920×1080	×	×
	DS-2CD9131	V3.5.0 build130906	2048×1536	×	×
	iDS-2CD9131	V3.5.0 build130906	2048×1536	×	×
	DS-2CD9111(B)	V3.5.0 build130906	1360×1024	×	×
	DS-2CD9151A iDS-2CD9151A	V3.5.0 build130906	2448×2048	×	×
	DS-2CD9182	V3.3.1 build 130321	3296×2472	×	×
	DS-2CD9152 iDS-2CD9152	V3.5.0 build131012	2560×1920	×	×
	DS-2CD9152-H	V3.5.0 build130814	2592×2048	×	×
	iDS-2CD9152-H	V3.5.0 build130814	2592×2048	×	×
	iDS-2CD9282	V3.5.0 build130810	3296*2472	×	×
	DS-2CD9131-K	V3.5.1 build130905	2048*1536	×	×
	DS-2CD9152-HK	V3.5.1 build130905	2592*2048	×	×
	DS-2CD966 (B) DS-2CD966-V(B)	V3.1.0 build120423	1360×1024	×	×
	DS-2CD976(B) DS-2CD976-V(B)	V3.1.0 build120423	1600×1200	×	×
	DS-2CD976(C) DS-2CD976-V(C)	V3.1.0 build120423	1600×1200	×	×
	DS-2CD977(B) DS-2CD977(C)	V3.1.0 build 120423	1920×1080	×	×
DS-2CD986A(B) DS-2CD986A(C)	V3.1.0 build120423	2448×2048	×	×	
DS-2CD986C(B)	V2.3.6 build 120401	2560×1920	×	×	
Network Speed Dome	DS-2DF7274-A/D/AF	V5.1.4 build 131219	1280×960	√	√
	DS-2DM7274-A	V5.1.4 build 131219	1280×960	√	√
	DS-2DF5274-A/D/A3/D3/AF/A3F	V5.1.4 build 131219	1280×960	√	√
	DS-2DM5274-A/A3	V5.1.4 build 131219	1280×960	√	√
	DS-2DF7284-A/D/AF DS-2DF7286-A/D/AF	V5.1.4 build 131219	1920×1080	√	√
	DS-2DF5284-A/D/A3/D3/AF/A3F	V5.1.4 build 131219	1920×1080	√	√

Type	Model	Version	Max. Resolution	Sub-stream	Audio
	DS-2DF5286-A/D/A3/D3/AF/A3F				
	DS-2DE5172-A/A3 DS-2DE5174-A/AE/AE3/A3/D/D3 DS-2DE5176-A/AE	V5.1.0 build 131203	1280×960	√	√
	DS-2DE7172-A DS-2DE7174-A/AE/D DS-2DE7176-A/AE	V5.1.0 build 131203	1280×960	√	√
	DS-2DE5182-A/A3 DS-2DE5184-A/AE/AE3/A3/D/D3 DS-2DE5186-A/AE	V5.1.0 build 131203	1920×1080	√	√
	DS-2DE7182-A DS-2DE7184-A/AE/D DS-2DE7186-A/AE	V5.1.0 build 131203	1920×1080	√	√
	DS-2DF1-5702 DS-2DF1-572	V4.1.6 build 130422	1280×720	√	√
	DS-2DM1-5702 DS-2DM1-572 DS-2DM1-5732	V4.1.6 build 130422	1280×720	√	√
	DS-2DF1-772 DS-2DM1-772	V4.1.6 build 130422	1280×720	√	√
	DS-2DF1-77A DS-2DF1-570A DS-2DF1-573A DS-2DF1-57A	V4.1.6 build 130422	1280×720	√	√
	DS-2DF1-5734D DS-2DF1-574D	V4.1.6 build 130422	1280×960	√	√
	DS-2DM1-574D DS-2DM1-5734D	V4.1.6 build 130422	1280×960	√	√
	DS-2DF1-774D	V4.1.6 build 130422	1280×960	√	√
	DS-2DM1-774D	V4.1.6 build 130422	1280×960	√	√
	DS-2DF1-584D	V4.1.6 build 130422	1920×1080	√	√
	DS-2DF1-784D	V4.1.6 build 130422	1920×1080	√	√
	DS-2DF1-518	V3.1.6 build20130322	704×576	√	√
	DS-2DM1-718	V3.1.6 build20130322	704×576	√	√
	DS-2DM1-518	V3.1.6 build20130322	704×576	√	√
	DS-2DF1-718	V3.1.6 build20130322	704×576	√	√
	DS-2DF1-514	V3.1.6 build20130322	704×576	√	√
	DS-2DF1-714	V3.1.6 build20130322	704×576	√	√
	DS-2DF1-402	V3.1.6 build20130322	704×576	√	√
	DS-2DF1-402N	V3.1.6 build20130322	704×576	√	√
Zoom Camera	DS-2ZCN2006	V5.0.2 build130926	1280×960	√	√

Type	Model	Version	Max. Resolution	Sub-stream	Audio	
	DS-2ZCN3006					
	DS-2ZMN2006 DS-2ZMN3006	V5.0.2 build130926	1280×960	√	√	
	DS-2ZCN2007 DS-2ZCN3007	V5.0.2 build130926	1920×1080	√	√	
	DS-2ZMN2007 DS-2ZMN3007 DS-2ZMN0407	V5.0.2 build130926	1920×1080	√	√	
	SD Encoder	DS-6501HFI DS-6502HFI DS-6504HFI	V1.0.1 build130607	704×576	√	√
		DS-6501HFI-SATA DS-6502HFI-SATA DS-6504HFI-SATA	V1.0.1 build130607	704×576	√	√
		DS-6508HFI DS-6516HFI	V1.0.1 build130607	704×576	√	√
		DS-6508HFI-SATA DS-6516HFI-SATA	V1.0.1 build130607	704×576	√	√
		DS-6501HCI DS-6502HCI DS-6504HCI	V1.0.1 build130607	704×576	√	√
		DS-6501HCI-SATA DS-6502HCI-SATA DS-6504HCI-SATA	V1.0.1 build130607	704×576	√	√
		DS-6508HCI DS-6508HCI-SATA	V1.0.1 build130607	704×576	√	√
		DS-6516HCI DS-6516HCI-SATA	V1.0.1 build130607	704×576	√	√
DS-6601HCI DS-6602HCI DS-6604HCI		V1.2.1 build131202	704×576	√	√	
DS-6601HFI DS-6602HFI DS-6604HFI		V1.2.1 build131202	704×576	√	√	
DS-6601HFHI DS-6601HFHI/L		V1.2.1 build131202	1920×1080	√	√	

List of Third-party IP Cameras



ONVIF compatibility refers to the camera can be supported both when it uses the ONVIF protocol and its private protocols. **Only ONVIF is supported** refers to the camera can only be supported when it uses the ONVIF protocol.

Only AXIS is supported refers to the function can only be supported when it uses the AXIS protocol.

IP Camera Manufacturer or Protocol	Model	Version	Max. Resolution	Sub-stream	Audio
ACTI	TCM4301-10D-X-00083	A1D-310-V4.12.09-AC	1280×1024	×	√
	TCM5311-11D-X-00023	A1D-310-V4.12.09-AC	1280×960	×	√
	TCM3401-09L-X-00227	A1D-220-V3.13.16-AC	1280×1024	×	×
ARECONT	AV8185DN	65172	1600×1200	×	×
	AV1305M	65175	1280×1024	√	×
	AV2155	65143	1600×1200	√	×
	AV2815	65220	1920×1080	√	×
	AV3105M	65175	1920×1080	√	×
	AV5105	65175	1920×1080	√	×
AXIS	M1114	5.09.1	1024×640	√	×
	M3011(ONVIF compatibility)	5.21	704×576	√(Only AXIS is supported)	×
	M3014(ONVIF compatibility)	5.21.1	1280×800	√	×
	P3301(ONVIF compatibility)	5.11.2	768×576	√	√(Only AXIS is supported)
	P3304(ONVIF compatibility)	5.20	1440×900	√	√(Only AXIS is supported)
	P3343(ONVIF compatibility)	5.20.1	800×600	√	√(Only AXIS is supported)
	P3344(ONVIF compatibility)	5.20.1	1440×900	√	√(Only AXIS is supported)
	P5532	5.15	720×576	√	×
	Q7404	5.02	720×576	√	√
	P1346	5.40.9.2	2048×1536	√	√
M3014	5.21.1	1280×800	√	×	
Bosch (ONVIF compatibility)	AutoDome Jr 800HD	39500450	1920×1080	×	√
	NBC 265 P	07500452	1280×720	×	√
	Dinion NBN-921-P	10500453	1280×720	×	√
Brickcom	CB-500Ap (ONVIF compatibility)	V3.2.1.3	1920×1080	×	√

IP Camera Manufacturer or Protocol	Model	Version	Max. Resolution	Sub-stream	Audio
	WFB-100Ap	V3.1.0.9	1280×800	×	√
Canon	VB-H410 (ONVIF compatibility)	Ver.+1.0.0	1280×960	×	√
HUNT	HLC_79AD	V1.0.40	1600×1200	√	×
Panasonic	WV-SW559(ONVIF compatibility)	Application:1.30 Image data:2.21	1920×1080	√	√
	WV-SP306H(ONVIF compatibility)	Application:1.34 Image data:1.06	1280×960	√	√
	WV-SP336H	Application:1.06 Image data:1.06	1280×960	√	√
PELCO (ONVIF compatibility)	D5118	1.8.2-20120327- 2.9310-A1.7852	1280×960	√	×
	IXE20DN-AAXVUU2	1.8.2-20120327- 2.9081-A1.7852	1920×1080	√	×
	IX30DN-ACFZHB3	1.8.2-20120327- 2.9080-A1.7852	2048×1536	√	×
SAMSUNG (ONVIF compatibility)	SNB-5000P	V3.10_130416	1280×1024	√	√
SANYO	VCC-HD2300P	2.03-02(110318-00)	1920×1080	×	×
	VCC-HD2500P	2.02-02(110208-00)	1920×1080	×	√
	VCC-HD4600P	2.03-02(110315-00)	1920×1080	×	√
SONY	SNC-CH220	1.50.00	1920×1080	×	×
	SNC-RH124(ONVIF compatibility)	1.79.00	1280×720	√	√
	SNC-EP580(ONVIF compatibility)	1.53.00	1920×1080	√	√
	SNC-DH220T(Only ONVIF is supported)	1.50.00	2048×1536	×	×
Vivotek	IP7133	0203a	640×480	×	×
	FD8134(ONVIF compatibility)	0107a	1280×800	×	×
	IP8161(ONVIF compatibility)	0104a	1600×1200	×	√
	IP8331(ONVIF compatibility)	0102a	640×480	×	×
	IP8332(ONVIF compatibility)	0105b	1280×800	×	×
ZAVIO (ONVIF compatibility)	D5110	MG1.6.03P8	1280×1024	√	×
	F3106	M2.1.6.03P8	1280×1024	√	√
	F3110	M2.1.6.01	1280×720	√	√

IP Camera Manufacturer or Protocol	Model	Version	Max. Resolution	Sub-stream	Audio
	F3206	MG.1.6.02c045	1920×1080	√	√
	F531E	LM.1.6.18P10	640×480	√	√

0301001031218



First Choice for Security Professionals