



User's Guide

Dell B1165nfw

BASIC

This guide provides information concerning installation, basic operation and troubleshooting on windows.

ADVANCED

This guide provides information about installation, advanced configuration, operation and troubleshooting on various OS environments.

Some features may not be available depending on models or countries.



1. Introduction

Key benefits	5
Features by models	7
Useful to know	10
About this user's guide	11
Safety information	12
Machine overview	17
Control panel overview	21
Turning on the machine	23
Installing the driver locally	24
Reinstalling the driver	27



2. Menu Overview and Basic Setup

Menu overview	29
Machine's basic settings	35
Media and tray	37
Basic printing	49
Basic copying	54
Basic scanning	59
Basic faxing	60



3. Maintenance

Ordering supplies and accessories	66
Available supplies	67
Available maintenance parts	68
Installing accessories	69
Storing the toner cartridge	70
Redistributing toner	72
Replacing the toner cartridge	74
Monitoring the supplies life	76
Setting the toner low alert	77
Cleaning the machine	78
Tips for moving & storing your machine	84



4. Troubleshooting

Tips for avoiding paper jams	86
Clearing original document jams	87
Clearing paper jams	92
Understanding the status LED	96
Understanding display messages	98



5. Appendix

Specifications	104
Regulatory information	113
Copyright	126



1. Introduction

This chapter provides information you need to know before using the machine.

- **Key benefits** 5
- **Features by models** 7
- **Useful to know** 10
- **About this user's guide** 11
- **Safety information** 12
- **Machine overview** 17
- **Control panel overview** 21
- **Turning on the machine** 23
- **Installing the driver locally** 24
- **Reinstalling the driver** 27



Key benefits

Environmentally friendly



- To save toner and paper, this machine supports Eco feature (see "Eco printing" on page 52).
- To save paper, you can print multiple pages on one single sheet of paper (see "Using advanced print features" on page 213).
- To save paper, you can print on both sides of the paper (double-sided printing) (Manual) (see "Using advanced print features" on page 213).
- To save electricity, this machine automatically conserves electricity by substantially reducing power consumption when not in use.
- We recommend using recycled paper for saving energy.

Fast high resolution printing



- You can print with a resolution of up to 1,200 x 1,200 dpi effective output.
- Fast, on-demand printing.
 - For single-side printing, 20 ppm (A4) or 21 ppm (Letter).

Convenience



- Easy Capture Manager allows you to easily edit and print whatever you captured using the Print Screen key on the keyboard (see "Accessing management tools" on page 246).
- Dell Easy Printer Manager and Printing Status or (Smart Panel) is a program that monitors and informs you of the machine's status and allows you to customize the machine's settings (see "Using Dell Printer Status" on page 254).
- Dell Easy Document Creator is an application to help users scan, compile, and save documents in multiple formats, including .epub format. These documents can be shared via social networking sites or fax.
- AnyWeb Print helps you screen-capture, preview, scrap, and print the screen of Windows Internet Explorer more easily, than when you use the ordinary program.
- Smart Update allows you to check for the latest software and install the latest version during the printer driver installation process. This is available only for Windows.
- You can access Dell Support at **www.dell.com** or **www.dell.com/support**. Select your region on the WELCOME TO DELL SUPPORT page, and fill in the requested details to access help tools and information.

Key benefits

Wide range of functionality and application support



- Supports various paper sizes (see "Print media specifications" on page 106).
- Print watermark: You can customize your documents with words, such as "Confidential" (see "Using advanced print features" on page 213).
- Print posters: The text and pictures of each page of your document are magnified and printed across the multiple sheets of paper and can then be taped together to form a poster (see "Using advanced print features" on page 213).
- You can print in various operating systems (see "System requirements" on page 109).
- Your machine is equipped with a USB interface and/or a network interface.

AirPrint



- AirPrint allows you to wirelessly print directly from iPhone, iPad and iPod touch running iOS 4.2 or later.

Supports various wireless network setting method



- Using the WPS (Wi-Fi Protected Setup™) button
 - You can easily connect to a wireless network using the WPS button on the machine and the access point (a wireless router).
- Using the USB cable or a network cable
 - You can connect and set various wireless network settings using a USB cable or a network cable.
- Using the Wi-Fi Direct
 - You can conveniently print from your mobile device using the Wi-Fi or Wi-Fi Direct feature.



See "Introducing wireless set up methods" on page 150.

Features by models

Some features and optional goods may not be available depending on model or country.

Operating System

Operating System	B1165nfw
Windows	●
Mac	●
Linux	●

(●: Included, Blank: Not available)

Software

Software	B1165nfw
SPL printer driver	●
PCL printer driver	
PS printer driver	
XPS printer driver ^a	●
Direct Printing Utility	

Software		B1165nfw
Dell Easy Printer Manager	Scan to PC settings	●
	Fax to PC settings	●
	Device Settings	●
Dell Easy Document Creator		●
Dell Printer Status		●
Smart Panel		●
Easy Eco Driver		●
Fax	Dell Network PC Fax	●

a. For XPS driver, it is only supported for Windows through the Dell website (www.Dell.com)

(●: Included, Blank: Not available)

Variety feature

Features	B1165nfw
Hi-Speed USB 2.0	●
Network Interface Ethernet 10/100 Base TX wired LAN	●
Network Interface 802.11b/g/n wireless LAN ^a	●
Eco printing (Control panel)	●

Features by models

Features		B1165nfw
Duplex (2-sided) printing (Manual) ^b		•
USB memory interface		
Memory module		
Mass Storage Device (HDD)		
Duplex Automatic Document Feeder (DADF)		
Automatic Document Feeder (ADF)		•
Handset		•
Fax	Multi-send	•
	Delay send	•
	Priority send	•
	Duplex send	
	Secure receive	•
	Duplex print	
	Send/ Receive forward - fax	•

Features		B1165nfw
Scan	Scanning to email	
	Scanning to SMB server	
	Scanning to FTP server	
	Duplex scan	
	Scan to PC	•
	PaperPort	•
	14 (found in CD2)	

Features by models

Features		B1165nfw
Copy	ID card copying	●
	Reduced or enlarged copying	●
	Collation	●
	Poster	●
	Clone	●
	Book	
	2-up/4-up	●
	Adjust background	●
	Margin shift	
	Edge erase	
	Gray enhance	
	Duplex copy	

a. Depending on your country, wireless LAN card may not be available. For some counties, only 802.11 b/g can be applied. Contact your local Dell dealer or the retailer where you bought your machine.

b. Windows only.

(●: Included, Blank: Not available)

Useful to know



The machine does not print.

- Open the print queue list and remove the document from the list (see "Canceling a print job" on page 50).
- Remove the driver and install it again (see "Installing the driver locally" on page 24).
- Select your machine as your default machine in your Windows (see "Setting your machine as a default machine" on page 212).



Where can I purchase accessories or supplies?

- Inquire at a Dell distributor or your retailer.
- Visit www.Dell.com/supplies. Select your country/region to view product service information.



The status LED flashes or remains constantly on.

- Turn the product off and on again.
- Check the meanings of LED indications in this manual and troubleshoot accordingly (see "Understanding the status LED" on page 96).



A paper jam has occurred.

- Open and close the scan unit (see "Front view" on page 18).
- Check the instructions on removing jammed paper in this manual and troubleshoot accordingly (see "Clearing paper jams" on page 92).



Printouts are blurry.

- The toner level might be low or uneven. Shake the toner cartridge (see "Redistributing toner" on page 72).
- Try a different print resolution setting (see "Opening printing preferences" on page 50).
- Replace the toner cartridge (see "Replacing the toner cartridge" on page 74).



Where can I download the machine's driver?

- You can get help, support application, machine drivers, manuals, and order information from the Dell website, www.Dell.com > find your product > Support or Downloads.

About this user's guide

This user's guide provides information for your basic understanding of the machine as well as detailed steps to explain machine usage.



- Read the safety information before using the machine.
- If you have a problem using the machine, refer to the troubleshooting chapter.
- Terms used in this user's guide are explained in the glossary chapter.
- All illustrations in this user's guide may differ from your machine depending on its options or model you purchased.
- The screenshots in this administrator's guide may differ from your machine depending on the machine's firmware/driver version.
- The procedures in this user's guide are mainly based on Windows 7.

Conventions

Some terms in this guide are used interchangeably, as below:

- Document is synonymous with original.
- Paper is synonymous with media, or print media.
- Machine refers to printer or MFP.

General icons



Icon	Text	Description
	Caution	Gives users information to protect the machine from possible mechanical damage or malfunction.
	Note	Provides additional information or detailed specification of the machine function and feature.

Safety information

These warnings and precautions are included to prevent injury to you and others, and to prevent any potential damage to your machine. Be sure to read and understand all of these instructions before using the machine. After reading this section, keep it in a safe place for future reference.

Important safety symbols

Explanation of all icons and signs used in this chapter

	Warning	Hazards or unsafe practices that may result in severe personal injury or death.
	Caution	Hazards or unsafe practices that may result in minor personal injury or property damage.
		Do not attempt.

Operating environment

Warning



Do not use if the power cord is damaged or if the electrical outlet is not grounded.

This could result in electric shock or fire.



Do not place anything on top of the machine (water, small metal or heavy objects, candles, lit cigarettes, etc.).

This could result in electric shock or fire.

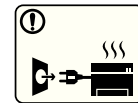

- If the machine gets overheated, it releases smoke, makes strange noises, or generates an odd odor. Immediately turn off the power switch and unplug the machine.

- The user should be able to access the power outlet in case of emergencies that might require the user to pull the plug out.

This could result in electric shock or fire.



Do not bend, or place heavy objects on the power cord.

Stepping on or allowing the power cord to be crushed by a heavy object could result in electric shock or fire.









Do not remove the plug by pulling on the cord; do not handle the plug with wet hands.

This could result in electric shock or fire.





Safety information

Caution

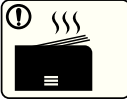
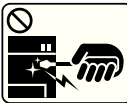

	<p>During an electrical storm or for a period of non-operation, remove the power plug from the electrical outlet.</p> <p>This could result in electric shock or fire.</p>
	<p>Be careful, the paper output area is hot.</p> <p>Burns could occur.</p>
	<p>If the machine has been dropped, or if the cabinet appears damaged, unplug the machine from all interface connections and request assistance from qualified service personnel.</p> <p>Otherwise, this could result in electric shock or fire.</p>
	<p>If the machine does not operate properly after these instructions have been followed, unplug the machine from all interface connections and request assistance from qualified service personnel.</p> <p>Otherwise, this could result in electric shock or fire.</p>
	<p>If the plug does not easily enter the electrical outlet, do not attempt to force it in.</p> <p>Call an electrician to change the electrical outlet, or this could result in electric shock.</p>
	<p>Do not allow pets to chew on the AC power, telephone or PC interface cords.</p> <p>This could result in electric shock or fire and/or injury to your pet.</p>

Operating method

Caution

	<p>Do not forcefully pull the paper out during printing.</p> <p>It can cause damage to the machine.</p>
	<p>Be careful not to put your hand between the machine and paper tray.</p> <p>You may get injured.</p>
	<p>Be care when replacing paper or removing jammed paper.</p> <p>New paper has sharp edges and can cause painful cuts.</p>
	<p>When printing large quantities, the bottom part of the paper output area may get hot. Do not allow children to touch.</p> <p>Burns can occur.</p>
	<p>When removing jammed paper, do not use tweezers or sharp metal objects.</p> <p>It can damage the machine.</p>
	<p>Do not allow too many papers to stack up in the paper output tray.</p> <p>It can damage the machine.</p>

Safety information



	Do not block or push objects into the ventilation opening. This could result in elevated component temperatures which can cause damage or fire.
	Use of controls or adjustments or performance of procedures other than those specified herein may result in hazardous radiation exposure.
	This machine's power reception device is the power cord. To switch off the power supply, remove the power cord from the electrical outlet.

Installation / Moving

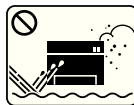



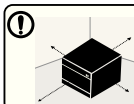

Warning

	Do not place the machine in an area with dust, humidity, or water leaks. This could result in electric shock or fire.
--	--

Caution

	Before moving the machine, turn the power off and disconnect all cords. The information below are only suggestions based on the units weight. If you have a medical condition that prevents you from lifting, do not lift the machine. Ask for help, and always use the appropriate amount of people to lift the device safety. Then lift the machine: <ul style="list-style-type: none">• If the machine weighs under 20 kg (44.09 lbs), lift with 1 person.• If the machine weighs 20 kg (44.09 lbs) - 40kg (88.18 lbs), lift with 2 people.• If the machine weighs more than 40 kg (88.18 lbs), lift with 4 or more people. The machine could fall, causing injury or machine damage.
	Choose a flat surface with enough space for ventilation to place the machine. Also consider the space required to open the cover and trays. The place should be well-ventilated and be far from direct light, heat, and humidity.
	When using the machine for a long period of time or printing a large number of pages in a non-ventilated space, it could pollute the air and be harmful to your health. Place the machine in a well-ventilated space or open a window to circulate the air periodically.
	Do not place the machine on an unstable surface. The machine could fall, causing injury or machine damage.





Safety information

	Use only No.26 AWG ^a or larger, telephone line cord, if necessary. Otherwise, it can cause damage to the machine.
	Make sure you plug the power cord into a grounded electrical outlet. Otherwise, this could result in electric shock or fire.
	Use the power cord supplied with your machine for safe operation. If you are using a cord which is longer than 2 meters (6 feet) with a 110V machine, then the gauge should be 16 AWG or larger. Otherwise, it can cause damage to the machine, and could result in electric shock or fire.
	Do not put a cover over the machine or place it in an airtight location, such as a closet. If the machine is not well-ventilated, this could result in fire.
	Do not overload wall outlets and extension cords. This can diminish performance, and could result in electric shock or fire.
	The machine should be connected to the power level which is specified on the label. If you are unsure and want to check the power level you are using, contact the electrical utility company.

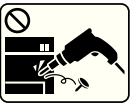

a. AWG: American Wire Gauge

Maintenance / Checking

Caution



	Unplug this product from the wall outlet before cleaning the inside of the machine. Do not clean the machine with benzene, paint thinner or alcohol; do not spray water directly into the machine. This could result in electric shock or fire.
	When you are working inside the machine replacing supplies or cleaning the inside, do not operate the machine. You could get injured.
	Keep cleaning supplies away from children. Children could get hurt.
	Do not disassemble, repair or rebuild the machine by yourself. It can damage the machine. Call a certified technician when the machine needs repairing.
	To clean and operate the machine, strictly follow the user's guide provided with the machine. Otherwise, you could damage the machine.





Safety information

	<p>Keep the power cable and the contact surface of the plug clean from dust or water.</p> <p>Otherwise, this could result in electric shock or fire.</p>
	<ul style="list-style-type: none">Do not remove any covers or guards that are fastened with screws.Fuser units should only be repaired by a certified service technician. Repair by non-certified technicians could result in fire or electric shock.The machine should only be repaired by a Dell service technician.

Supply usage

Caution

	<p>Do not disassemble the toner cartridge.</p> <p>Toner dust can be dangerous if inhaled or ingested.</p>
	<p>Do not burn any of the supplies such as toner cartridge or fuser unit.</p> <p>This could cause an explosion or uncontrollable fire.</p>

	<p>When storing supplies such as toner cartridges, keep them away from children.</p> <p>Toner dust can be dangerous if inhaled or ingested.</p>
	<p>Using recycled supplies, such as toner, can cause damage to the machine.</p> <p>In case of damage due to the use of recycled supplies, a service fee will be charged.</p>
	<p>For supplies that contain toner dust (toner cartridge, waste toner bottle, imaging unit, etc.) follow the instructions below.</p> <ul style="list-style-type: none">When disposing of the supplies, follow the instructions for disposal. Refer to the reseller for disposal instructions.Do not wash the supplies.For a waste toner bottle, do not reuse it after emptying the bottle. <p>If you do not follow the instructions above, it may cause machine malfunction and environmental pollution. The warranty does not cover damages caused by a user's carelessness.</p>
	<p>When toner gets on your clothing, do not use hot water to wash it.</p> <p>Hot water sets toner into fabric. Use cold water.</p>
	<p>When changing the toner cartridge or removing jammed paper, be careful not to let toner dust touch your body or clothes.</p> <p>Toner dust can be dangerous if inhaled or ingested.</p>

Machine overview

Accessories

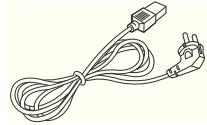

Power cord



Quick installation guide

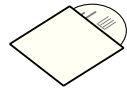

Software CD^a

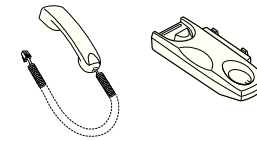

Handset^b

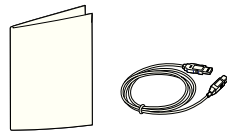

Misc. accessories^c

a. The software CD contains the print drivers, user's guide, and software applications.

b. Handset model only (see "Features by models" on page 7).

c. Miscellaneous accessories included with your machine may vary by country of purchase and specific model.

Machine overview

Front view



- This illustration may differ from your machine depending on your model. There are various types of machine.
- Some features and optional goods may not be available depending on model or country (see "Features by models" on page 7).

2	Control panel	8	Scanner glass
3	Handle	9	Scan unit ^{a b}
4	Tray	10	Inner cover
5	Tray handle	11	Toner cartridge
6	Output support		

- a. Close the scanner lid before opening the scan unit.
b. Be careful not to pinch your fingers.

Type A

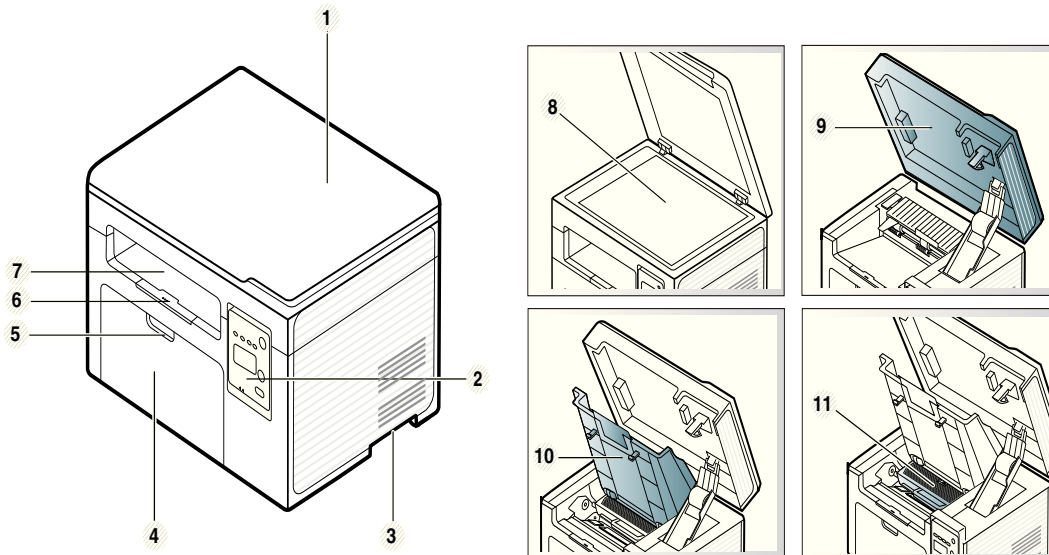

1	Scanner lid	7	Output tray
---	-------------	---	-------------

Machine overview

Type B

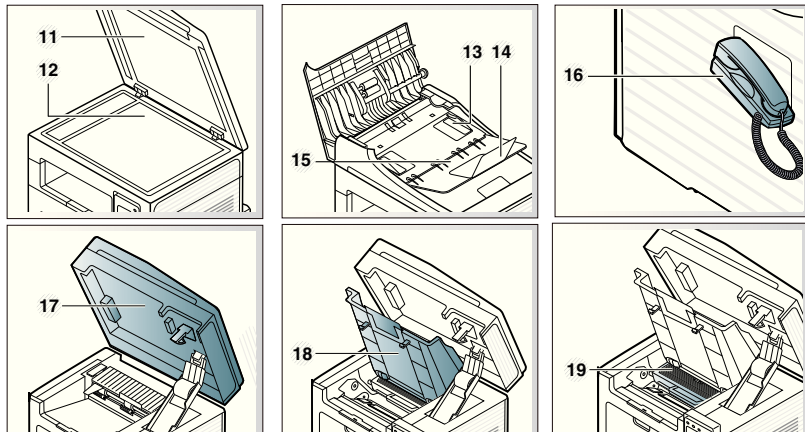
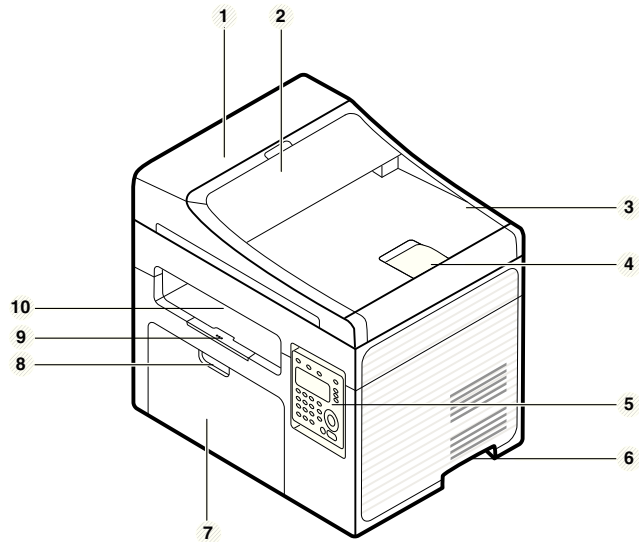

2	Document feeder guide cover	12	Scanner glass
3	Document feeder output tray	13	Paper width guide on a document feeder
4	Document feeder output support	14	Document feeder input support
5	Control panel	15	Document feeder input tray
6	Handle	16	Handset ^a
7	Tray	17	Scan unit ^{b c}
8	Tray handle	18	Inner cover
9	Output support	19	Toner cartridge
10	Output tray		

a. Handset model only (see "Features by models" on page 7).

b. Close the scanner lid before opening the scan unit.

c. Be careful not to pinch your fingers.

1	Document feeder cover	11	Scanner lid
---	-----------------------	----	-------------

Machine overview

Rear view



- This illustration may differ from your machine depending on your model. There are various types of machine.
- Some features and optional goods may not be available depending on model or country (see "Features by models" on page 7).

Type A

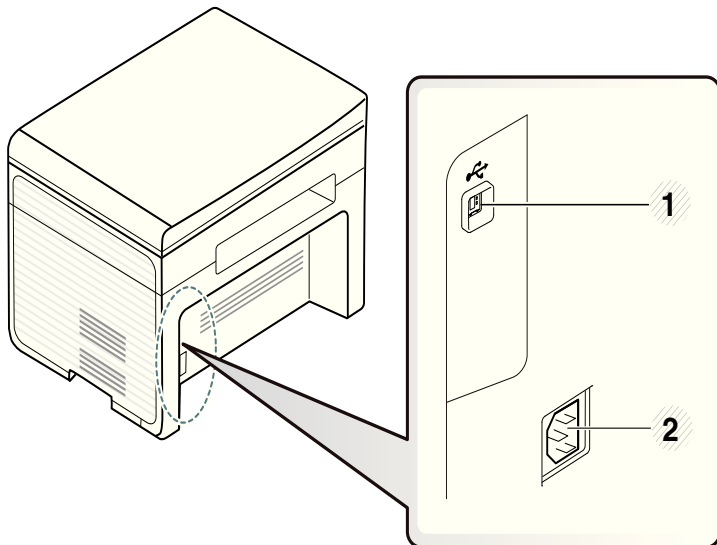

1 USB port

2 Power receptacle

Type B

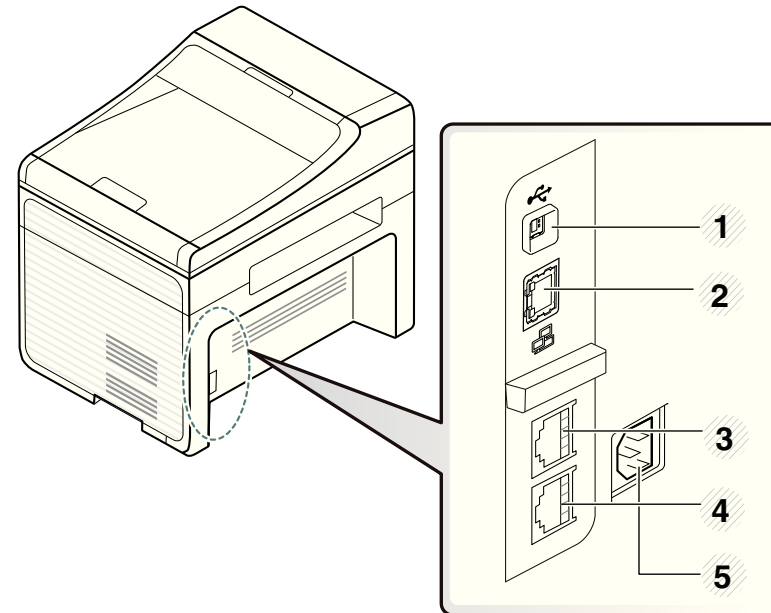

1 USB port

2 Network port

3 Extension telephone socket (**EXT.**)

4 Telephone line socket (**LINE**)

5 Power receptacle



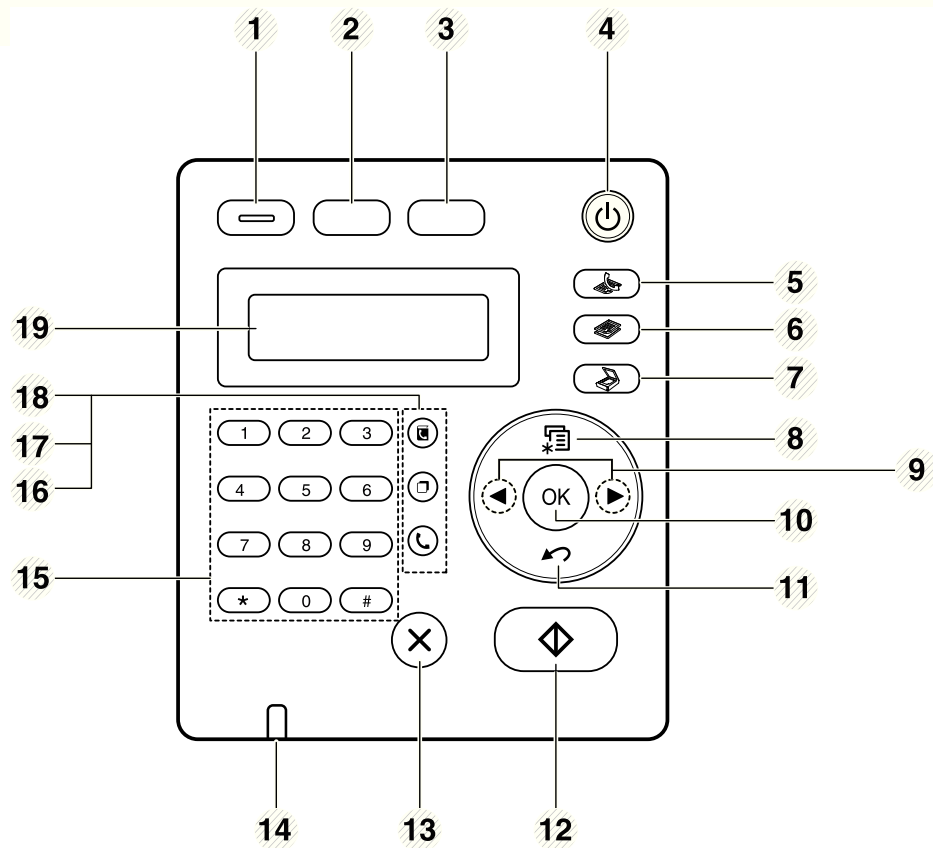

Control panel overview



1	Eco	Turn into eco mode to reduce toner consumption and paper usage when pc-printing and copying only (see "Eco printing" on page 52).
2	WPS	Configures the wireless network connection easily without a computer (see "Using the WPS button" on page 151).

3	ID Copy	Allows you to copy both sides of an ID card like a driver's license on a single side of paper (see "ID card copying" on page 57).
4	Power/Wakeup	Turns the power on or off, or wakes up the machine from the power save mode. If you need to turn the machine off, press this button for more than three seconds.
5	Fax	Switches to Fax mode.
6	Copy	Switches to Copy mode.
7	Scan	Switches to Scan mode.
8	Menu	Opens Menu mode and scrolls through the available menus (see "Menu overview" on page 29).
9	Left/Right Arrows	Scrolls through the options available in the selected menu and increases or decreases values.
10	OK	Confirms the selection on the screen.
11	Back	Sends you back to the upper menu level.
12	Start	Starts a job.

Control panel overview

13	Stop/ Clear		Stops an operations at any time.
14	Status LED		Indicates the status of your machine (see "Understanding the status LED" on page 96).
15	Numeric keypad		Dials a number or enters alphanumeric characters (see "Keypad letters and numbers" on page 207).
16	On Hook Dial		When you press this button, you can hear a dial tone. Then enter a fax number. It is similar to making a call using speaker phone (see "Receiving manually in Tel mode" on page 240).
17	Redial/ Pause		Redials the recently sent fax number or received caller ID in ready mode, or inserts a pause(-) into a fax number in edit mode (see "Redialing the fax number" on page 233).
18	Address Book		Allows you to store frequently used fax numbers or search for stored fax numbers (see "Setting up the fax address book" on page 208).
19	Display screen		Shows the current status and displays prompts during an operation.

Adjusting the control panel

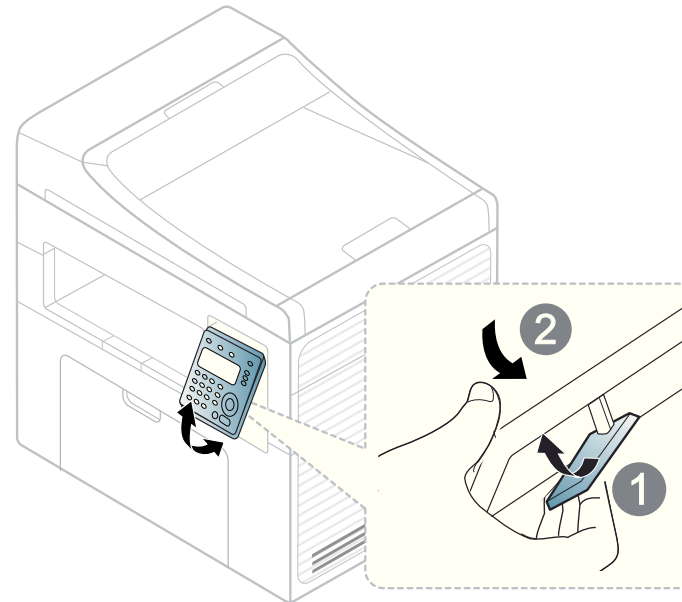

Illustrations on this user's guide may differ from your machine depending on its options or models. Check your machine type (see "Front view" on page 18).

Turning on the machine

- 1 Connect the machine to the electricity supply first.

Turn the switch on if the machine has a power switch.

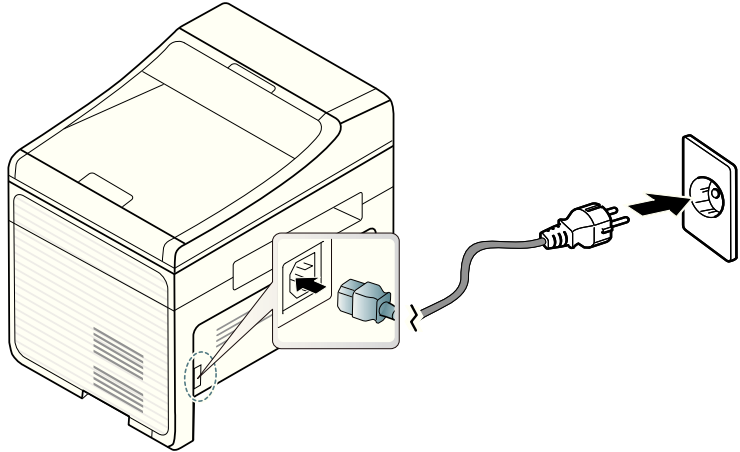

Illustrations on this user's guide may differ from your machine depending on its options or models. Check your machine type (see "Front view" on page 18).

- 2 Press  (**Power/Wakeup**) button on the control panel.



If you want to turn the power off, press and hold  (**Power/Wakeup**) button for about 3 seconds.

Installing the driver locally

A locally connected machine is a machine directly attached to your computer using the cable. If your machine is attached to a network, skip the following steps below and go on to installing a network connected machine's driver (see "Installing driver over the network" on page 141).



- If you are a Mac or Linux operating systems user, refer to the "Installation for Mac" on page 131 or "Installation for Linux" on page 133.
- The installation window in this User's Guide may differ depending on the machine and interface in use.
- Only use a USB cable no longer than 3 meters (118 inches).

Windows

- 1 Make sure that the machine is connected to your computer and powered on.



If the "**Found New Hardware Wizard**" appears during the installation procedure, click **Cancel** to close the window.

- 2 Insert the supplied software CD into your CD/DVD drive.
The software CD should automatically run and an installation window will appear.

If the installation window does not appear, click **Start > All programs > Accessories > Run**.

X:**Setup.exe** replacing "X" with the letter, which represents your CD/DVD drive and click **OK**.

- For Windows 8,

If the installation window does not appear, from **Charms**, select **Search > Apps** and search for **Run**. Type in X:\Setup.exe, replacing "X" with the letter that represents your CD/DVD drive and click **OK**.

If "**Tap to choose what happens with this disc.**" pop-up window appears, click the window and select **Run Setup.exe**.

- 3 Select **New Printer**.

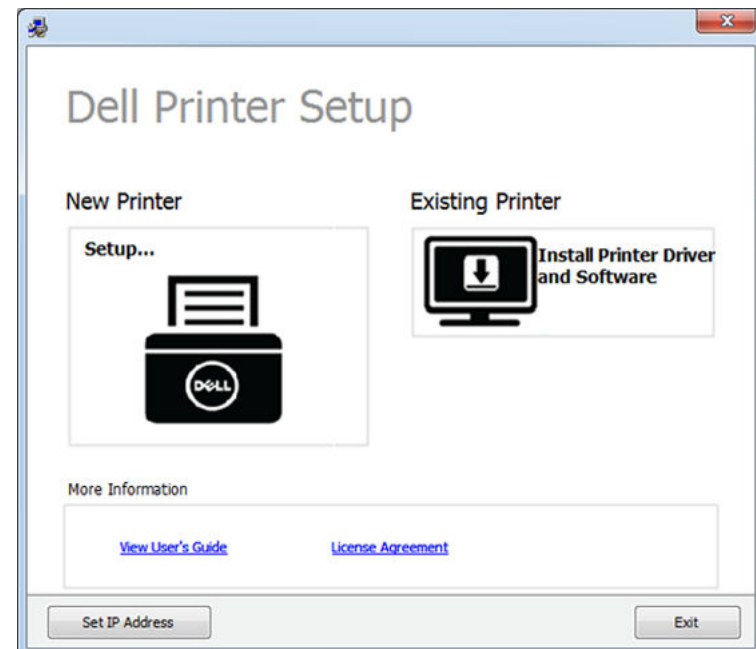

Installing the driver locally

4 Choose **USB**.

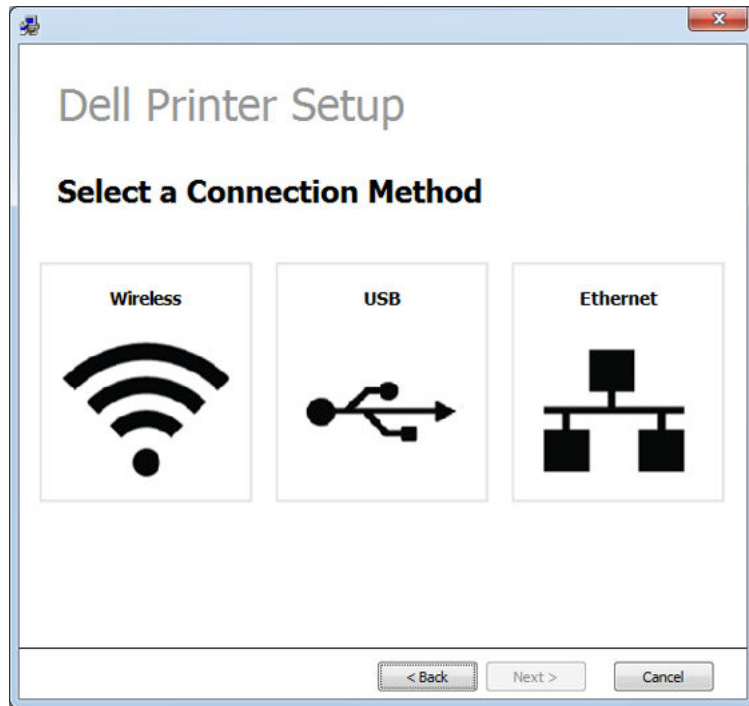

5 Follow the instructions in the installation window.

From the Windows 8 Start Screen



- **Dell Printer Experience** app can only be used in the **Start** screen when V4 driver is installed. The V4 driver is automatically downloaded from the Windows Update if your computer is connected to the Internet. If not, you can manually download the V4 driver from Dell website, www.Dell.com > find your product > Support or downloads.
- You can download Dell Printer Experience app from the **Windows Store**. You need have a Microsoft account to use the Windows **Store**.
 - 1 From **Charms**, select **Search**.
 - 2 Click **Store**.
 - 3 Search and click **Dell Printer Experience**.
 - 4 Click **Install**.
- If you install the driver using the supplied software CD, V4 driver is not installed. If you want to use the V4 driver in the **Desktop** screen, you can download from the Dell website, www.Dell.com > find your product > Support or downloads.
- If you want to install Dell's printer management tools, you need to install them using the supplied software CD.

- 1 Make sure that your computer is connected to the Internet and powered on.
- 2 Make sure that the machine is powered on.
- 3 Connect the computer and the machine with a USB cable.
The driver is automatically installed from the **Windows Update**.

Installing the driver locally



- If you want to install Dell's printer management tools, you need to install them using the supplied software CD.
- You can download Dell Printer Experience app from the **Windows Store**. You need have a Microsoft account to use the **Windows Store**.
 - 1 From **Charms**, select **Search**.
 - 2 Click **Store**.
 - 3 Search and click **Dell Printer Experience**.
 - 4 Click **Install**.

Reinstalling the driver

If the printer driver does not work properly, follow the steps below to reinstall the driver.

Windows

- 1 From the **Start** menu, select **Programs** or **All Programs > Dell Printers > your printer driver name > Uninstall**.
 - For Windows 8,
 - 1 From Charms, select **Search > Apps**.
 - 2 Search and click **Control Panel**.
 - 3 Click **Programs and Features**.
 - 4 Right-click the driver you want to uninstall and select **Uninstall**.
- 2 Follow the instructions in the installation window.
- 3 Insert the software CD into your CD/DVD drive and install the driver again (see "Installing the driver locally" on page 24).

From the Windows 8 Start Screen

- 1 Make sure that the machine is connected to your computer and powered on.
- 2 Click on the **Uninstall Dell Printer Software** tile in the **Start** screen.

- 3 Follow the instructions in the window.



- If you cannot find a Dell Printer Software tile, uninstall from the desktop screen mode.
- If you want to uninstall Dell's printer management tools, from the **Start** screen, right-click the app > **Uninstall** > right-click the program you want to delete > **Uninstall** and follow the instruction in the window.



2. Menu Overview and Basic Setup

This chapter provides information about the overall menu structure and the basic setup options.

- **Menu overview** 29
- **Machine's basic settings** 35
- **Media and tray** 37
- **Basic printing** 49
- **Basic copying** 54
- **Basic scanning** 59
- **Basic faxing** 60

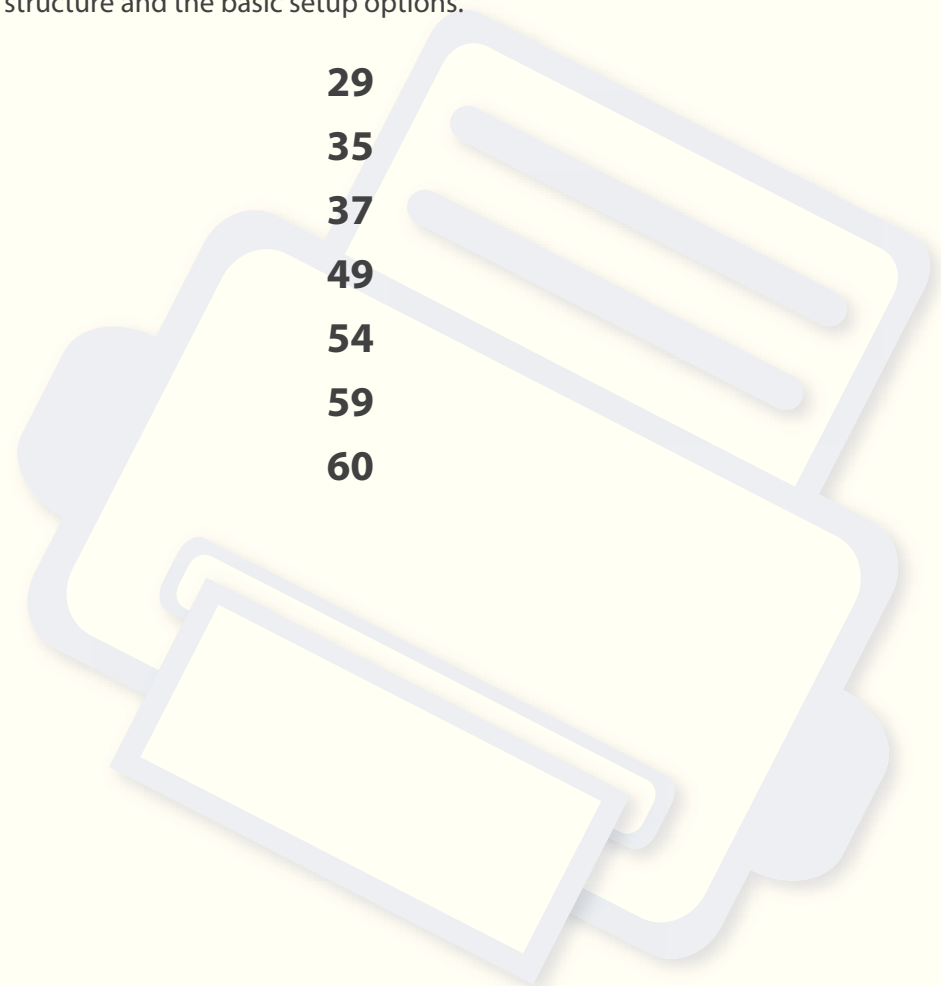



Menu overview

The control panel provides access to various menus to set up the machine or use the machine's functions.



- Some menus may not appear on the display depending on options or models. If so, it is not applicable to your machine.
- Some menu names may differ from your machine depending on its options or the models.
- The menus are described in the Advanced Guide (see "Useful Setting Menus" on page 177).

Accessing the menu

- 1 Select the Fax, Copy, or Scan button on the control panel depending on the feature to be used.
- 2 Select  (**Menu**) until the menu you want appears on the bottom line of the display and press **OK**.
- 3 Press the arrows until the needed menu item appears and press **OK**.
- 4 If the setting item has sub menus, repeat step 3.
- 5 Press **OK** to save the selection.
- 6 Press  (**Stop/Clear**) to return to the ready mode.

Items	Options	
Fax Feature	Darkness	Normal Dark+1- Dark+5 Light+5- Light+1
	Contrast	Normal Dark+1- Dark+5 Light+5- Light+1
	Resolution	Standard Fine Super Fine Photo Fax Color Fax
	Scan Size	
	Multi Send	
	Delay Send	

Menu overview

Items	Options	
Fax Feature (Continue)	Priority Send	
	Forward	Fax PC
	Secure Receive	Off On Print
	Add Page	
	Cancel Job	
Fax Setup	Sending	Redial Times Redial Term Prefix Dial ECM Mode Send Report Image TCR Dial Mode ^a

Items	Options		
Fax Setup (Continue)	Receiving	Receive Mode Ring To Answer Stamp RCV Name RCV Start Code Auto Reduction Discard Size Junk Fax Setup DRPD Mode ^a	
		Change Default	Resolution Darkness Contrast Scan Size
		Auto Report	On Off
		Manual TX/RX	On Off

Menu overview

Items	Options	
Copy Feature	Scan Size	
	Reduce/Enlarge	
	Darkness	Normal Dark+1- Dark+5 Light+5- Light+1

Items	Options	
Copy Feature (Continue)	Contrast	Normal Dark+1- Dark+5 Light+5- Light+1
	Original Type	Text Text/Photo Photo
	Layout	Normal 2-Up 4-Up ID Copy Poster Copy Clone Copy
	Adjust Bkgd.	Off Auto Enhance Lev.1 Enhance Lev.2 Erase Lev.1- Erase Lev.4

Menu overview

Items	Options	
Copy Setup	Change Default	Scan Size Copies Copy Collation Reduce/Enlarge Darkness Contrast Original Type Adjust Bkgd.

Items	Options	
System Setup	Machine Setup	Machine ID Fax Number Date & Time Clock Mode Language Power Save Wakeup Event System Timeout Altitude Adj. Auto Continue ^b Paper Mismatch Paper Substit. ^b Toner Save Eco Settings
	Paper Setup	Paper Size Paper Type Margin

Menu overview

Items	Options	
System Setup (Continue)	Sound/Volume	Key Sound Alarm Sound Speaker Ringer
	Report	All Report Configuration Supplies Info. Address Book Fax Send Fax Sent Fax Received Schedule Jobs Junk Fax Network Conf. Usage Counter Fax Options
	Maintenance	CLR Empty Msg. ^c Supplies Life Serial No. TonerLow Alert

Items	Options		
System Setup (Continue)	Clear Setting	All Settings Fax Setup Copy Setup System Setup Network Setup ^c Address Book Fax Sent Fax Received	
		TCP/IP (IPv4)	DHCP BOOTP Static
		TCP/IP (IPv6)	IPv6 Activate DHCPv6 Config
Network ^c	Ethernet Speed	Automatic 10Mbps Half 10Mbps Full 100Mbps Half 100Mbps Full	

Menu overview

Items	Options	
Network ^c (Continue)	Wireless	Wi-Fi ON/OFF Wi-Fi Direct WPS Setting WLAN Setting WLAN Default WLAN Signal
	Clear Setting	
	Network Conf.	

- a. This option may not be available depending on your country.
- b. This option only appears if **Paper Mismatch** is enabled.
- c. This option only appears when small amount of toner is left in the cartridge.

Machine's basic settings



You can set the machine's settings by using the **Device Settings** in Dell Printer Manager program or **Machine** section in Printer Settings Utility program.

- For Windows and Mac users, see "Device Settings" on page 253.

After installation is complete, you may want to set the machine's default settings.

To change the machine's default settings, follow these steps:



It may be necessary to press **OK** to navigate to lower-level menus for some models.

- 1 Select  (**Menu**) button on the control panel.
- 2 Press **System Setup > Machine Setup**.
- 3 Select the option you want, then press **OK**.
 - **Language:** change the language that is displayed on the control panel.
 - **Date & Time:** When you set the time and date, they are used in delay fax and delay print. They are printed on reports. If, however, they are not correct, you need to change it for the correct time being.



Enter the correct time and date using arrows or numeric keypad (see "Keypad letters and numbers" on page 207).

- Month = 01 to 12
- Day = 01 to 31
- Year = requires four digits
- Hour = 01 to 12
- Minute = 00 to 59

- **Clock Mode:** You can set your machine to display the current time using either a 12-hour or 24-hour format.
- **Toner Save:** Toner save mode allows your machine to use less toner on each page. Activating this mode extends the life of the toner cartridge beyond what one would experience in the normal mode, but it reduces print quality.



When PC-printing, you can also turn on or off toner save mode in the printer properties.

- **Power Save:** When you are not using the machine for a while, use this feature to save power.

Machine's basic settings



- When you press the power button, start printing, or a fax is received, the product will wake up from the power saving mode.
- Press  (**Menu**) > **System Setup** > **Machine Setup** > **Wakeup Event** > **Button Press** > **On** on the control panel. When you press any button except power button, the machine wake up from the power save mode.

- **Altitude Adjust:** Print quality is affected by atmospheric pressure, which atmospheric pressure is determined by the height of the machine above sea level. Before you set the altitude value, determine the altitude where you are (see "Altitude adjustment" on page 206).

4 Select the option you want, then press **OK**.

5 Press **OK** to save the selection.

6 Press  (**Stop/Clear**) to return to ready mode.



Refer to below links to set other settings useful for using the machine.

- See "Entering various characters" on page 207.
- See "Keypad letters and numbers" on page 207.
- See "Setting the paper size and type" on page 44.
- See "Setting up the fax address book" on page 208.

Media and tray

This chapter provides information on how to load print media into your machine.



- Using print media that does not meet these specifications may cause problems or require repairs. Such repairs are not covered by Dell's warranty or service agreements.
- Make sure not to use the inkjet photo paper with this machine. It could cause damage to the machine.
- Using inflammable print media can cause a fire.
- Use designated print media (see "Print media specifications" on page 106).



The use of inflammable media or foreign materials left in the printer may lead to overheating of the unit and, in rare cases may cause a fire.

Tray overview

To change the size, you need to adjust the paper guides.

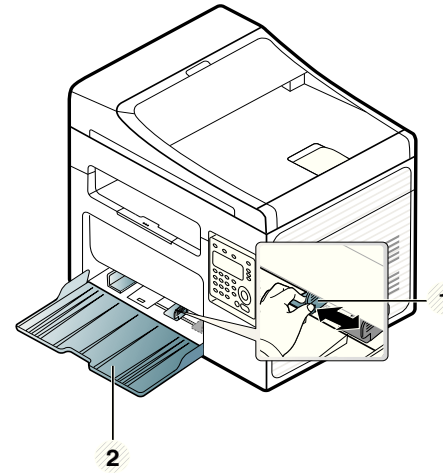

- 1 Paper width guide
- 2 Tray



Illustrations on this user's guide may differ from your machine depending on its options or models. Check your machine type (see "Front view" on page 18).



If you do not adjust the guide, it may cause paper registration, image skew, or jamming of the paper.

Media and tray

Loading paper in the tray



Illustrations on this user's guide may differ from your machine depending on its options or models. Check your machine type (see "Front view" on page 18).

- 1 Open the tray. Then, adjust the tray size to the media size you are loading (see "Tray overview" on page 37).

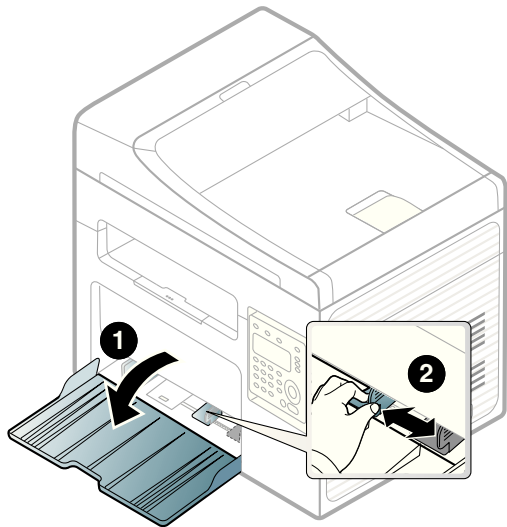

- 2 Flex or fan the edge of the paper stack to separate the pages before loading papers.

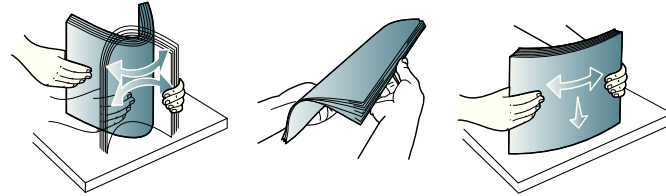

- 3 Place the paper with the side you want to print facing up.

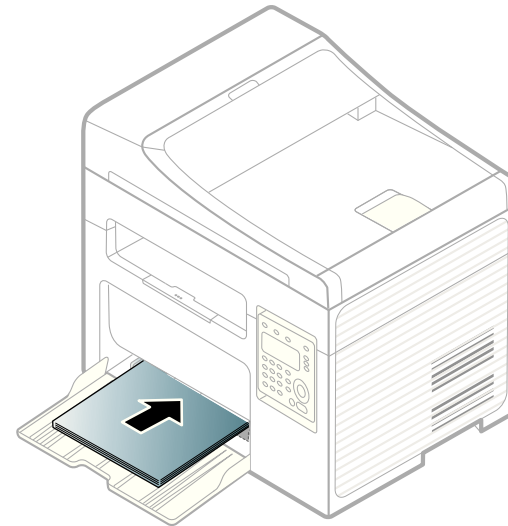

Media and tray



- Do not push the paper width guide too far causing the media to warp.
- Do not use a paper with a leading-edge curl, it may cause a paper jam or the paper can be wrinkled.
- If you do not adjust the paper width guide, it may cause paper jams.

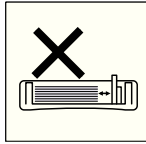
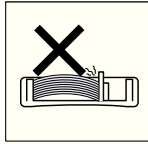
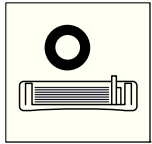

- 4 Squeeze the paper width guide and slide it to the edge of the paper stack without causing it to bend.

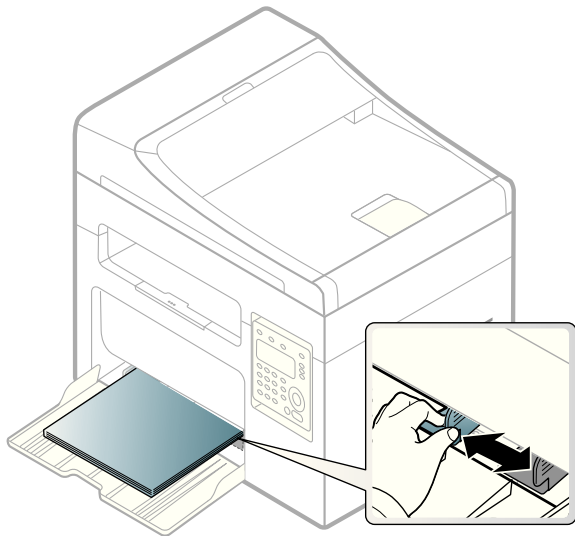

- 5 When you print a document, set the paper type and size for the tray (see "Setting the paper size and type" on page 44).



The settings made from the machine driver override the settings on the control panel.

- a To print in application, open an application and start the print menu.
- b Open **Printing Preferences** (see "Opening printing preferences" on page 50).
- c Press the **Paper** tab in **Printing Preferences**, and select an appropriate paper type.
For example, if you want to use a label, set the paper type to **Label**.
- d Select **Auto Select** (or **Manual Feeder**) in paper source, then press **OK**.
- e Start printing in application.

Media and tray

Manual feeding in the tray

The tray can hold special sizes and types of print material, such as postcards, note cards, and envelopes (see "Print media specifications" on page 106).

To feed manually in the tray, click the below:

See "Loading paper in the tray" on page 38.



Tips on using the manual feeding in tray

- If you select **Paper > Source > Manual Feeder** from your printer driver, you need to press **OK** each time you print a page.
- Load only one type, size and weight of print media at a time in the tray.
- To prevent paper jams, do not add paper while printing when there is still paper in the tray.
- Print media should be loaded face up with the top edge going into the tray first and be placed in the center of the tray.
- To ensure printing quality and to prevent paper jams, only load the available paper (see "Print media specifications" on page 106).
- Flatten any curl on postcards, envelopes, and labels before loading them into the in the tray.
- When printing on special media, you must follow the loading guidelines (see "Printing on special media" on page 40).

Printing on special media

The table below shows the special media usable in tray.

The media is also shown in the **Printing Preferences**. To get the highest printing quality, select the proper media type from the **Printing preferences** window > **Paper** tab > **Paper Type** (see "Opening printing preferences" on page 50).

For example, if you want to print on labels, select **Labels** for **Paper Type**.



- When using special media, we recommend you feed one sheet at a time (see "Print media specifications" on page 106).
- Illustrations on this user's guide may differ from your machine depending on its options or models. Check your machine type (see "Front view" on page 18).

To see for paper weights for each sheet, refer to "Print media specifications" on page 106.

Types	Tray ^a
Plain	•
Thick	•
Thin	•

Media and tray

Types	Tray ^a
Bond	●
Color	●
CardStock	●
Labels	●
Envelope	●
Preprinted	●
Cotton	●
Recycled	●
Archive	●

a. The paper types available manual feeding in tray.

(●: Supported, Blank: Not supported)

Envelope

Printing successfully on envelopes depends upon the quality of the envelopes.

To print an envelope, place it as shown in the following figure.

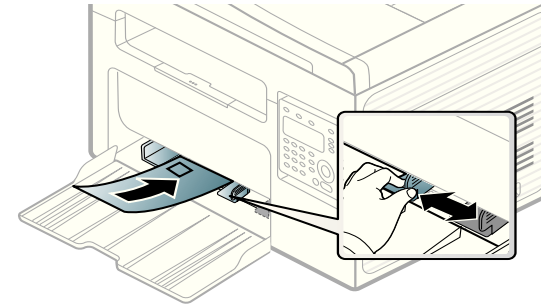

- When selecting envelopes, consider the following factors:
 - **Weight:** should not exceed 90 g/m² otherwise; jams may occur.
 - **Construction:** should lie flat with less than 6 mm curl and should not contain air.
 - **Condition:** should not be wrinkled, nicked, nor damaged.
 - **Temperature:** should resist the heat and pressure of the machine during operation.
- Use only well-constructed envelopes with sharp and well-creased folds.
- Do not use stamped envelopes.
- Do not use envelopes with clasps, snaps, windows, coated lining, self-adhesive seals, or other synthetic materials.

Media and tray

- Do not use damaged or poorly made envelopes.
- Be sure the seam at both ends of the envelope extends all the way to the corner of the envelope.

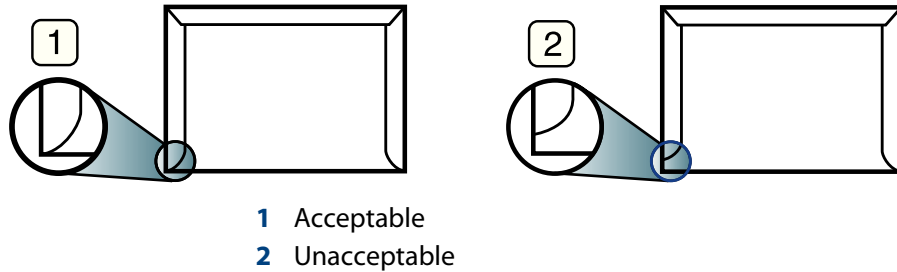

- Envelopes with a peel-off adhesive strip or with more than one flap that folds over to seal must use adhesives compatible with the machine's fusing temperature for 0.1 second about 170°C (338 °F). The extra flaps and strips might cause wrinkling, creasing, or jams, and may even damage the fuser.
- For the best print quality, position margins no closer than 15 mm from the edges of the envelope.
- Avoid printing over the area where the envelope's seams meet.

Labels

To avoid damaging the machine, use only labels designed for use in laser printers.

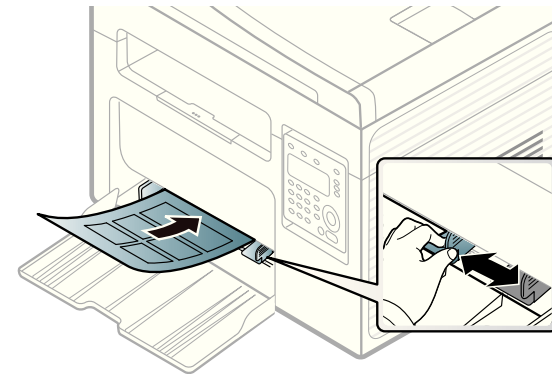

- When selecting labels, consider the following factors:
 - **Adhesives:** Should be stable at your machine's fusing temperature about 170°C (338°F).
 - **Arrangement:** Only use labels with no exposed backing between them. Labels can peel off sheets that have spaces between the labels, causing serious jams.
 - **Curl:** Must lie flat with no more than 13 mm of curl in any direction.
 - **Condition:** Do not use labels with wrinkles, bubbles, or other indications of separation.
- Make sure that there is no exposed adhesive material between labels. Exposed areas can cause labels to peel off during printing, which can cause paper jams. Exposed adhesive can also cause damage to machine components.

Media and tray

- Do not run a sheet of labels through the machine more than once. The adhesive backing is designed for only a single pass through the machine.
- Do not use labels that are separating from the backing sheet or are wrinkled, bubbled, or otherwise damaged.

Card stock/ Custom-sized paper

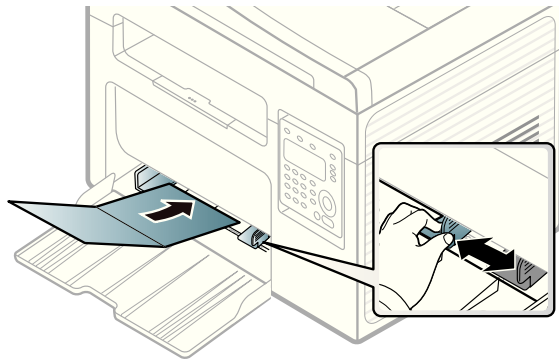

- In the software application, set the margins to at least 6.4 mm (0.25 inches) away from the edges of the material.

Preprinted paper

When loading preprinted paper, the printed side should be facing up with an uncurled edge at the front. If you experience problems with paper feeding, turn the paper around. Note that print quality is not guaranteed.

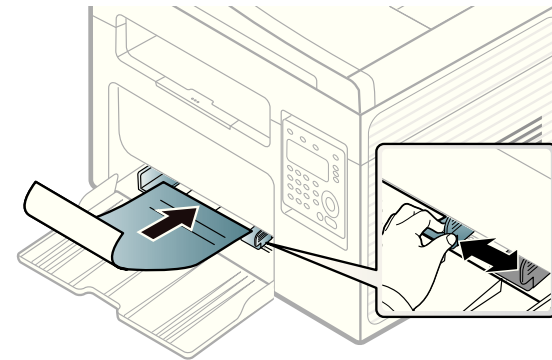

- Must be printed with heat-resistant ink that will not melt, vaporize, or release hazardous emissions when subjected to the machine's fusing temperature for 0.1 second (about 170°C (338°F)).
- Preprinted paper ink must be non-flammable and should not adversely affect machine rollers.
- Before you load preprinted paper, verify that the ink on the paper is dry. During the fusing process, wet ink can come off preprinted paper, reducing print quality.

Media and tray

Setting the paper size and type

After loading paper in the paper tray, set the paper size and type using the control panel buttons.





You can set the machine's settings by using the **Device Settings** in Dell Printer Manager program or **Machine** section in Printer Settings Utility program.

- For Windows and Mac users, see "Device Settings" on page 253.



It may be necessary to press **OK** to navigate to lower-level menus for some models.

- 1 Select  (**Menu**) button on the control panel.
- 2 Press **System Setup** > **Paper Setup** > **Paper Size** or **Paper Type**.
- 3 Select the tray and the option you want.
- 4 Press **OK** to save the selection.
- 5 Press  (**Stop/Clear**) to return to ready mode.



- The settings set from the machine driver override the settings on the control panel.
 - a To print from an application, open an application and start the print menu.
 - b Open **Printing Preferences** (see "Opening printing preferences" on page 50).
 - c Press the **Paper** tab and select an appropriate paper.
- If you want to use special-sized paper such as billing paper, select the **Paper** tab > **Size** > **Edit...** and set **Custom Paper Size Settings** in the **Printing Preferences** (see "Opening printing preferences" on page 50).

Media and tray

Using the output support



The surface of the output tray may become hot if you print a large number of pages at once. Make sure that you do not touch the surface, and do not allow children near it.

The printed pages stack on the output support, and the output support will help the printed pages to align. The printer sends output to the output tray by default.

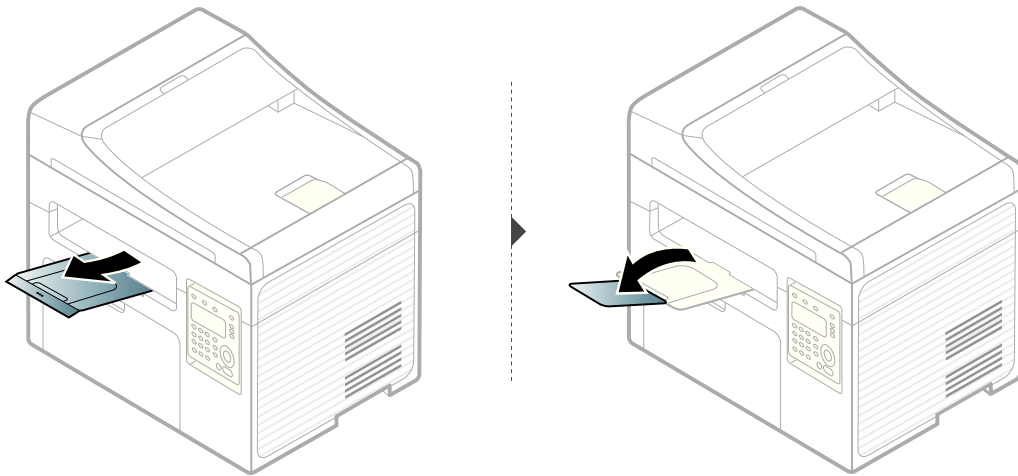

Illustrations on this user's guide may differ from your machine depending on its options or models. Check your machine type (see "Front view" on page 18).

Preparing originals

- Do not load paper smaller than 142 x 148 mm (5.6 x 5.8 inches) or larger than 216 x 356 mm (8.5 x 14 inches).
- Do not attempt to load the following paper in order to prevent paper jam, low print quality and machine damage.
 - Carbon-paper or carbon-backed paper
 - Coated paper
 - Onion skin or thin paper
 - Wrinkled or creased paper
 - Curled or rolled paper
 - Torn paper
- Remove all staples and paper clips before loading.
- Make sure any glue, ink, or correction fluid on the paper is completely dry before loading.
- Do not load originals that include different sizes or weights of paper.
- Do not load booklets, pamphlets, transparencies, or documents with other unusual characteristics.

Media and tray

Loading originals

You can use the scanner glass or the document feeder to load an original for copying, scanning, and sending a fax.



Illustrations on this user's guide may differ from your machine depending on its options or models. Check your machine type (see "Front view" on page 18).

On the scanner glass

Using the scanner glass, you can copy or scan originals. You can get the best scan quality, especially for colored or gray-scaled images. Make sure that no originals are in the document feeder. If an original is detected in the document feeder, the machine gives it priority over the original on the scanner glass.

- 1 Lift and open the scanner lid.

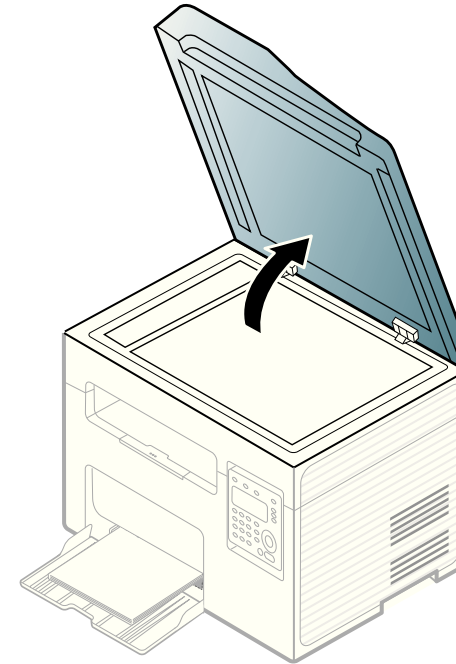

Media and tray

- 2 Place the original face down on the scanner glass. Align it with the registration guide at the top left corner of the glass.

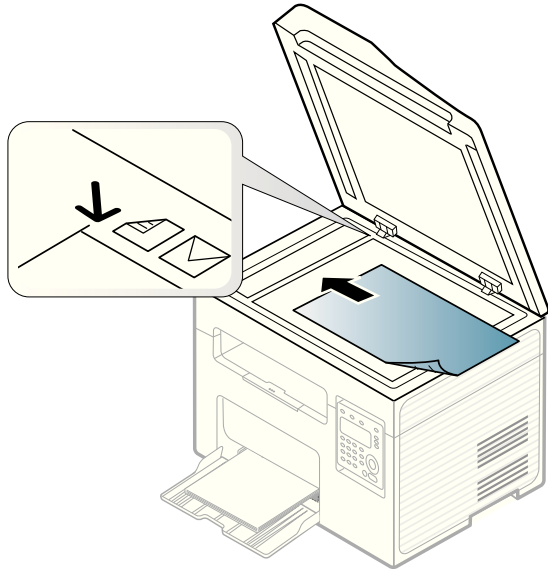

- 3 Close the scanner lid.



- Leaving the scanner lid open while copying may affect copy quality and toner consumption.
- Dust on the scanner glass may cause black spots on the printout. Always keep it clean (see "Cleaning the machine" on page 78).
- If you are copying a page from a book or magazine, lift the scanner lid until its hinges are caught by the stopper and then close the lid. If the book or magazine is thicker than 30 mm, start copying with the scanner lid open.



- Be careful not to break the scanner glass. You may get hurt.
- Do not put hands while closing the scanner lid. The scanner lid may fall on your hands and get hurt.
- Do not look the light from inside of the scanner while copying or scanning. It is harmful to eyes.

In the document feeder

Using the document feeder, you can load up to 40 sheets of paper (80 g/m², 20 lbs bond) for one job.

- 1 Open the document feeder guide cover.

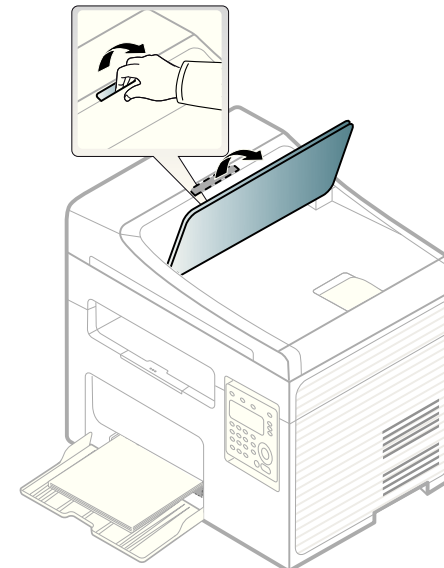

Media and tray

- 2** Flex or fan the edge of the paper stack to separate the pages before loading originals.

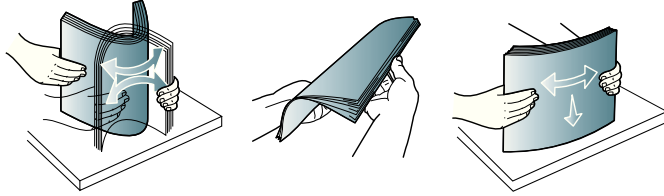

- 3** Load the original face up into the document feeder input tray. Make sure that the bottom of the original stack matches the paper size marked on the document input tray.

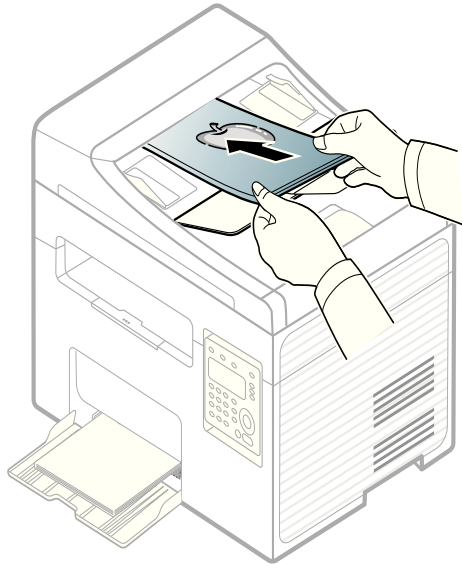

- 4** Adjust the document feeder width guides to the paper size.

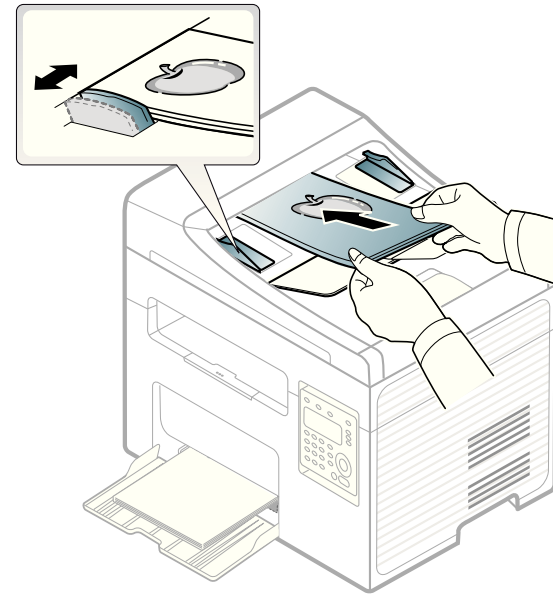

Dust on the document feeder glass may cause black lines on the printout. Always keep the glass clean (see "Cleaning the machine" on page 78).

Basic printing



For special printing features, refer to the Advanced Guide (see "Using advanced print features" on page 213).

Printing



- If you are a Mac or Linux operating systems user, refer to the Advanced Guide (see "Mac printing" on page 221 or "Linux printing" on page 223).
- For Windows 8 user, see "Basic printing" on page 257.

The following **Printing Preferences** window is for Notepad in Windows 7.

- 1 Open the document you want to print.
- 2 Select **Print** from the **File** menu.

- 3 Select your machine from the **Select Printer** list.

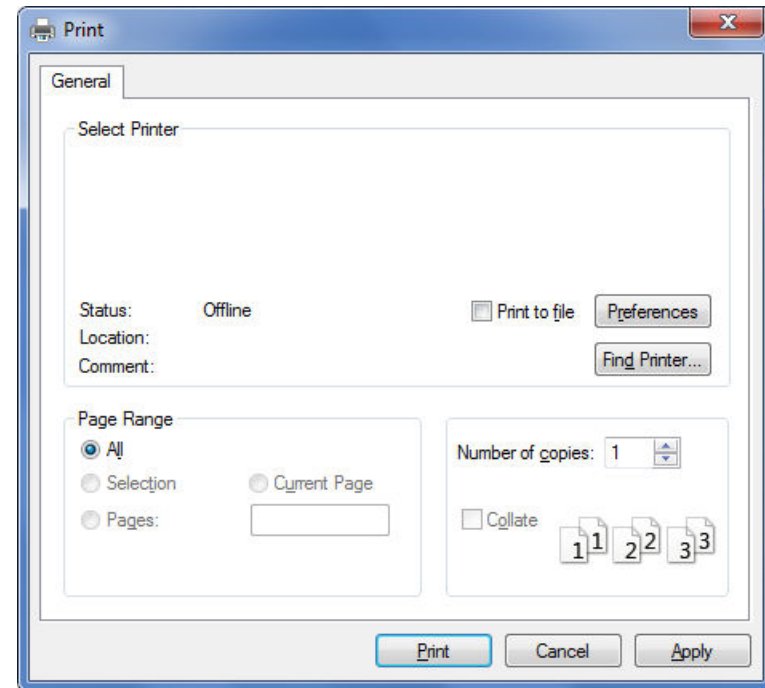

- 4 The basic print settings including the number of copies and print range are selected within the **Print** window.





To take advantage of the advanced printing features, click **Properties** or **Preferences** from the **Print** window (see "Opening printing preferences" on page 50).

- 5 To start the print job, click **OK** or **Print** in the **Print** window.

Basic printing





Canceling a print job

If the print job is waiting in the print queue or print spooler, cancel the job as follows:

- You can access this window by simply double-clicking the machine icon () in the Windows task bar.
- You can also cancel the current job by pressing  (**Stop/Clear**) on the control panel.

Opening printing preferences



- The **Printing Preferences** window that appears in this user's guide may differ depending on the machine in use.
- When you select an option in **Printing Preferences**, you may see a warning mark  or . An  mark means you can select that certain option but it is not recommended, and an  mark means you cannot select that option due to the machine's setting or environment.
- For Windows 8 user, see "Opening more settings" on page 258.

- 1 Open the document you want to print.
- 2 Select **Print** from the file menu. The **Print** window appears.
- 3 Select your machine from the **Select Printer**.

Basic printing

4 Click **Properties** or **Preferences**.

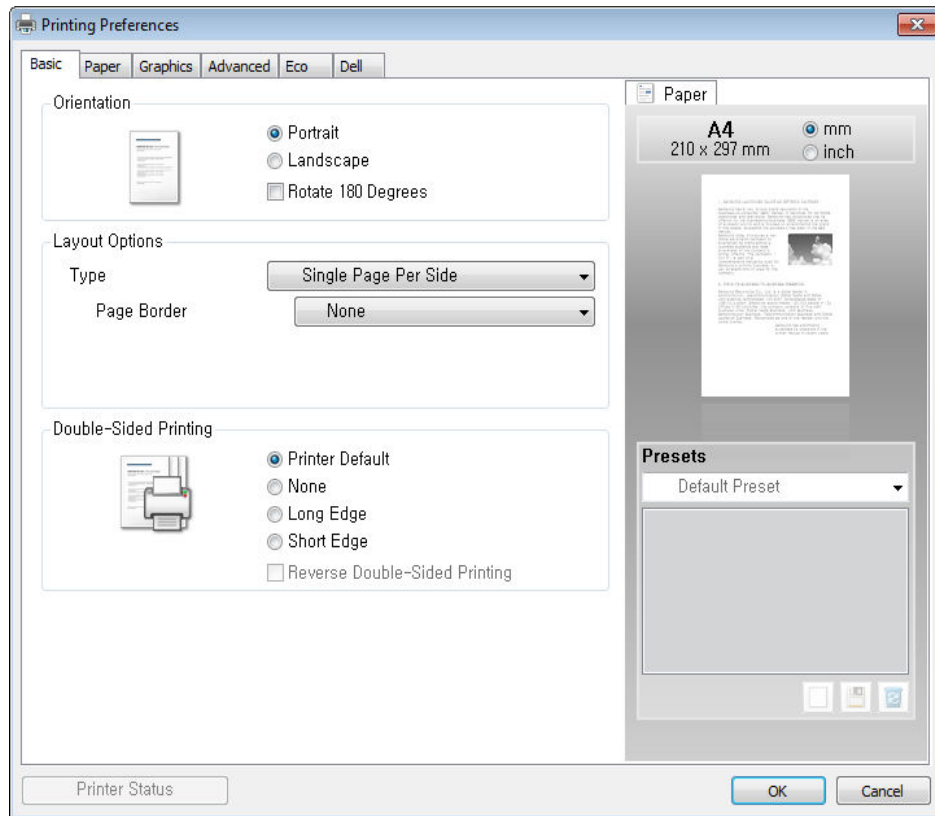

You can check the machine's current status pressing the **Printer Status** button (see "Using Dell Printer Status" on page 254).

Using a favorite setting

The **Presets** option, which is visible on each preferences tab except for the **Dell** tab, allows you to save the current preferences for future use.

To save a **Presets** item, follow these steps:

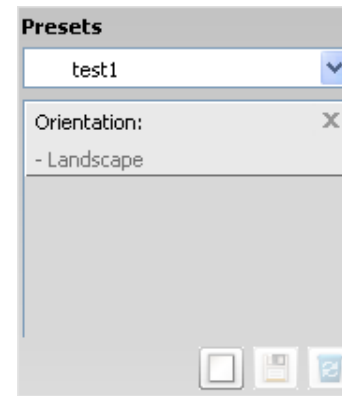

- 1 Change the settings as needed on each tab.
- 2 Enter a name for the item in the **Presets** input box.



- 3 Click (**Add**). When you save **Presets**, all current driver settings are saved.

Basic printing



Select more options and click  (**Update**), settings will be added to the Presets you made. To use a saved setting, select it from the **Presets** drop-down list. The machine is now set to print according to the settings you have selected. To delete saved settings, select it from the **Presets** drop-down list and click  (**Delete**).

You can also restore the printer driver's default settings by selecting **Default Preset** from the **Presets** drop-down list.

Using help

Click the option you want to know on the **Printing Preferences** window and press **F1** on your keyboard.

Eco printing

The **Eco** function cuts toner consumption and paper usage. The **Eco** function allows you to save print resources and lead you to eco-friendly printing.

If you press the **Eco** button from the control panel, eco mode is enabled. The default setting of Eco mode is **Multiple Pages per Side (2)** and **Toner Save**.

Setting Eco mode on the control panel



You can set the machine's settings by using the **Device Settings** in Dell Printer Manager program or **Machine** section in Printer Settings Utility program.

- For Windows and Mac users, see "Device Settings" on page 253.



- The settings set from the machine's driver override the settings on the control panel.
- Accessing menus may differ from model to model (see "Accessing the menu" on page 29).
- It may be necessary to press **OK** to navigate to lower-level menus for some models.

Basic printing

- 1 Select  (**Menu**) > **System Setup** > **Machine Setup** > **Eco Settings** on the control panel.
- 2 Select the option you want and press **OK**.
 - **Default Mode:** Select this to turn on or off the eco mode. (Toner save/2-up)
 - **Off:** Set the eco mode off.
 - **On:** Set the eco mode on.



If you set the eco mode on with a password from Dell Printer Manager (**Device Settings** > **Eco**), the **On force** message appears. You have to enter the password to change the eco mode status.

- **Select Temp.:** Follow the settings from Dell Printer Manager. Before you select this item, you must set the eco function in Dell Printer Manager (**Device Settings** > **Eco**).
 - **Default Eco:** The machine is set to **Default Eco** mode.
 - **Custom Eco:** Change any necessary values.
- 3 Press **OK** to save the selection.

Setting eco mode on the driver

Open the Eco tab to set Eco mode. When you see the eco image (), that means the eco mode is currently enabled.

Eco options

- **Printer Default:** Follows the settings from the machine's control panel.
- **None:** Disables Eco mode.
- **Eco Printing:** Enables eco mode. Activate the various Eco items you want to use.
- **Password:** If the administrator fixed to enable the Eco mode, you have to enter the password to change the status.

Result simulator

Result Simulator shows the results of reduced emission of carbon dioxide, used electricity, and the amount of saved paper in accordance with the settings you selected.



- The results are calculated on the basis that the total number of printed paper is one hundred without a blank page when the Eco mode is disabled.
- Refers to the calculation coefficient about CO₂, energy, and paper from **IEA**, the index of Ministry of Internal Affairs and Communication of Japan and www.remanufacturing.org.uk. Each model has a different index.
- The power consumption in printing mode refers to the average printing power consumption of this machine.
- The actual amount displayed is only an estimate as the actual amount may differ depending on the operating system used, computing performance, application software, connection method, media type [thickness], media size, job complexity, etc.

Basic copying



For special printing features, refer to the Advanced Guide (see "Copy menu" on page 180).

Basic copy

- 1 Select  (copy) on the control panel.
- 2 Place a single document face down on the document glass, or load the documents face up into the document feeder (see "Loading originals" on page 46).
- 3 If you want to customize the copy settings including **Reduce/Enlarge**, **Darkness**, **Contrast**, **Original Type**, and more by using the control panel buttons (see "Changing the settings for each copy" on page 54).
- 4 Enter the number of copies using the arrow or number keypad, if necessary.
- 5 Press  (**Start**).



If you need to cancel the copying job during the operation, press  (**Stop/Clear**) and the copying will stop.

Changing the settings for each copy

Your machine provides default settings for copying so that you can quickly and easily make a copy.





- If you press the  (**Stop/Clear**) button twice while setting the copy options, all of the options you have set for the current copy job will be canceled and returned to their default status. Or, they will automatically return to their default status after the machine completes the copy in progress.
- Accessing menus may differ from model to model (see "Accessing the menu" on page 29).
You can customize the copy settings such as darkness, original type and more by using the **Device Settings** in Dell Printer Manager program or the **Machine** section in Printer Settings Utility program.
 - For Windows and Mac users, see "Device Settings" on page 253.
- It may be necessary to press **OK** to navigate to lower-level menus for some models.

Basic copying



Darkness

If you have an original containing faint marking and dark images, you can adjust the brightness to make a copy that is easier to read.

- 1 Select  (copy) >  (**Menu**) > **Copy Feature** > **Darkness** on the control panel.
- 2 Select the option you want and press **OK**.
For example, the **Light+5** being the lightest, and the **Dark+5** being the darkest.
- 3 Press  (**Stop/Clear**) to return to ready mode.



Contrast

The **Contrast** menu lets you increase or decrease the difference between the bright and dark areas of an image.

- 1 Select  (copy) >  (**Menu**) > **Copy Feature** > **Contrast** on the control panel.
- 2 Select the option you want and press **OK**.
Select **Dark** to heighten the contrast and select **Light** to reduce it.
- 3 Press  (**Stop/Clear**) to return to ready mode.

Original

The original setting is used to improve the copy quality by selecting the document for the current copy job.

- 1 Select  (copy) >  (**Menu**) > **Copy Feature** > **Original Type** on the control panel.
- 2 Select the option you want and press **OK**.
 - **Text**: Use for originals containing mostly text.
 - **Text/Photo**: Use for originals with mixed text and photographs.



If texts in the printout is blurry, select **Text** to get the clear texts.

- **Photo**: Use when the originals are photographs.
- 3 Press  (**Stop/Clear**) to return to ready mode.

Basic copying

Reduced or enlarged copy

You can reduce or enlarge the size of a copied image from 25% to 400% from the document feeder or scanner glass.



- This feature may not be available depending on model or optional goods (see "Variety feature" on page 7).
- If the machine set to Eco mode, reduce and enlarge features are not available.



3 Press **OK** to save the selection.

4 Press  (**Stop/Clear**) to return to ready mode.





When you make a reduced copy, black lines may appear at the bottom of your copy.

To select from the predefined copy sizes

- 1** Select  (copy) >  (**Menu**) > **Copy Feature** > **Reduce/Enlarge** on the control panel.
- 2** Select the option you want and press **OK**.
- 3** Press  (**Stop/Clear**) to return to ready mode.

To scale the copy by directly entering the scale rate

- 1** Select  (copy) >  (**Menu**) > **Copy Feature** > **Reduce/Enlarge** > **Custom** on the control panel.
- 2** Enter the copy size you want using the numeric keypad.

Basic copying

ID card copying

Your machine can print 2-sided originals on one sheet.

The machine prints one side of the original on the upper half of the paper and the other side on the lower half without reducing the size of the original. This feature is helpful for copying a small-sized item such as business card.



- The original must be placed on the scanner glass to use this feature.
- If the machine set to Eco mode, this feature is not available.

Depending on the model, the operating procedure may differ.

- 1 Press **ID Copy** on the control panel.
- 2 Place the front side of an original facing down on the scanner glass where arrows indicate as shown. Then, close the scanner lid.

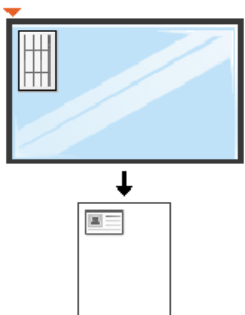

- 3 **Place Front Side and Press [Start]** appears on the display.

- 4 Press  (**Start**).

Your machine begins scanning the front side and shows **Place Back Side and Press [Start]**.

- 5 Turn the original over and place it on the scanner glass where arrows indicate as shown. Then, close the scanner lid.

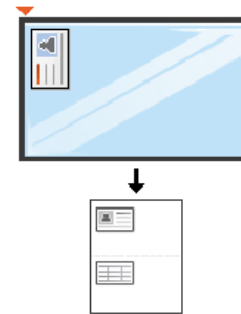

- 6 Press  (**Start**) button.

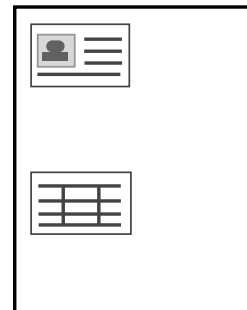

Basic copying



- If you do not press the  (**Start**) button, only the front side will be copied.
- If the original is larger than the printable area, some portions may not be printed.

Basic scanning



For special scanning features, refer to the Advanced Guide (see "Scan features" on page 225).

Basic Scanning

This is the normal and usual procedure for scanning originals.

This is a basic scanning method for USB-connected machine.



- It may be necessary to press **OK** to navigate to lower-level menus for some models.
- If you want to scan using the network, refer to the Advanced Guide (see "Scanning from network connected machine" on page 226).

- 1 Place a single document face down on the document glass, or load the documents face up into the document feeder (see "Loading originals" on page 46).
- 2 Select  (scan) > **Scan to PC** on the control panel.
OR
Press **Scan to** on the control panel.



If you see **Not Available** message, check the port connection, or select

Enable Scan from Device Panel in **Dell Printer Manager** >  Switch to advanced mode > **Scan to PC Settings**.

- 3 Select the scan destination you want and press **OK**.
Default setting is **My Documents**.



- You can create and save the frequently used settings as a profile list. Also you can add and delete the profile and save each profile to a different path.
- To change the **Dell Printer Manager** >  Switch to advanced mode > **Scan to PC Settings**.

- 4 Select the option you want and press **OK**.

- 5 Scanning begins.



Scanned image is saved in computer's **C:\Users\users name\My Documents**. The saved folder may differ, depending on your operating system or the application you are using.

Basic faxing



- For special faxing features, refer to the Advanced Guide (see "Fax features" on page 233).



- You cannot use this machine as a fax via the internet phone. For more information ask your internet service provider.
- We recommend using traditional analog phone services (PSTN: Public Switched Telephone Network) when connecting telephone lines to use a fax machine. If you use other Internet services (DSL, ISDN, VoIP), you can improve the connection quality by using the Micro-filter. The Micro-filter eliminates unnecessary noise signals and improves connection quality or Internet quality. Since the DSL Micro-filter is not provided with the machine, contact your Internet service provider for use on DSL Micro-filter.

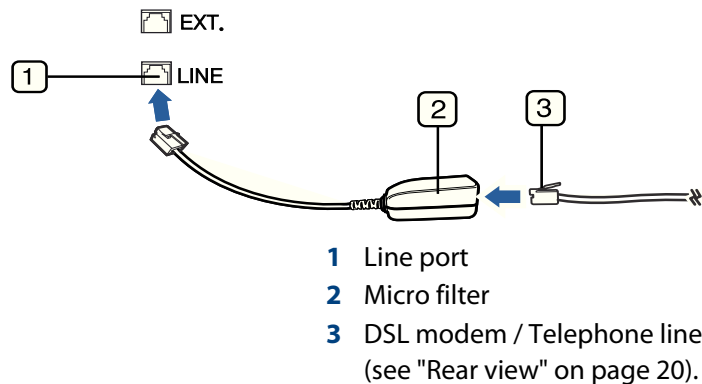

Preparing to fax

Before you send or receive a fax, you need to connect the supplied line cord to your telephone wall jack (see "Rear view" on page 20). Refer to the Quick Installation Guide how to make a connection. The method of making a telephone connection is different from one country to another.

Sending a fax



When you place the originals, you can use either the document feeder or the scanner glass. If the originals are placed on both the document feeder and the scanner glass, the machine will read the originals on the document feeder first, which has higher priority in scanning.

- 1 Place a single document face down on the document glass, or load the documents face up into the document feeder (see "Loading originals" on page 46).
- 2 Select  (fax) on the control panel.
- 3 Adjust the resolution and the darkness to suit your fax needs (see "Adjusting the document settings" on page 63).

Basic faxing

- 4 Enter the destination fax number (see "Keypad letters and numbers" on page 207).
- 5 Press  (**Start**) on the control panel. The machine starts to scan and send the fax to the destinations.





- If you want to send a fax directly from your computer, use Dell Network PC Fax (see "Sending a fax in the computer" on page 234).
- When you want to cancel a fax job, press  (**Stop/Clear**) before the machine starts transmission.
- If you used the scanner glass, the machine shows the message asking to place another page.

Sending a fax manually

Perform the following to send a fax using  (**On Hook Dial**) on the control panel.



If your machine is a handset model, you can send a fax using the handset (see "Variety feature" on page 7).

- 1 Place a single document face down on the document glass, or load the documents face up into the document feeder (see "Loading originals" on page 46).
- 2 Select  (fax) on the control panel.
- 3 Adjust the resolution and the darkness to suit your fax needs (see "Adjusting the document settings" on page 63).
- 4 Press  (**On Hook Dial**) on the control panel or lift the handset.
- 5 Enter a fax number using the number keypad on the control panel.
- 6 Press  (**Start**) on the control panel when you hear a high-pitched fax signal from the remote fax machine.



Basic faxing

Sending a fax to multiple destinations

You can use the multiple send feature, which allows you to send a fax to multiple locations. Originals are automatically stored in memory and sent to a remote station. After transmission, the originals are automatically erased from memory.



You cannot send faxes with this feature if you chosen super fine as an option or if the fax is in color.

- 1** Place a single document face down on the document glass, or load the documents face up into the document feeder (see "Loading originals" on page 46).
- 2** Select  (fax) on the control panel.
- 3** Adjust the resolution and the darkness to suit your fax needs (see "Adjusting the document settings" on page 63).
- 4** Select  (**Menu**) > **Fax Feature** > **Multi Send** on the control panel.
- 5** Enter the number of the first receiving fax machine and press **OK**.
You can press speed dial numbers or select a group dial number using the  (**Address book**) button.
- 6** Enter the second fax number and press **OK**.
The display asks you to enter another fax number to send the document.

- 7** To enter more fax numbers, press **OK** when **Yes** appears and repeat steps 5 and 6.



- You can add up to 10 destinations.
- Once you have entered a group dial number, you cannot enter another group dial number.

- 8** When you have finished entering fax numbers, select **No** at the **Another No.?** prompt and press **OK**.

The machine begins sending the fax to the numbers you entered in the order in which you entered them.

Multi send report is printed after sending faxes.

Basic faxing

Receiving a fax

Your machine is preset to Fax mode at the factory. When you receive a fax, the machine answers the call on a specified number of rings and automatically receives the fax.

Adjusting the document settings



Before starting a fax, change the following settings according to your original's status to get the best quality.



It may be necessary to press **OK** to navigate to lower-level menus for some models.

Resolution

The default document settings produce good results when using typical text-based originals. However, if you send originals that are of poor quality, or contain photographs, you can adjust the resolution to produce a higher quality fax.

- 1 Select  (fax) >  (**Menu**) > **Fax Feature** > **Resolution** on the control panel.
- 2 Select the option you want and press **OK**.
 - **Standard**: Originals with normal sized characters.
 - **Fine**: Originals containing small characters or thin lines or originals printed using a dot-matrix printer.
 - **Super Fine**: Originals containing extremely fine detail. **Super Fine** mode is enabled only if the machine with which you are communicating also supports the Super Fine resolution.



- For memory transmission, **Super Fine** mode is not available. The resolution setting is automatically changed to **Fine**.
- When your machine is set to **Super Fine** resolution and the fax machine with which you are communicating does not support **Super Fine** resolution, the machine transmits using the highest resolution mode supported by the other fax machine.

- **Photo Fax**: Originals containing shades of gray or photographs.
- **Color Fax**: Original with colors.



- Memory transmission is not available in this mode.
- You can only send a color fax if the machine you are communicating with supports color fax reception and you send the fax manually.

- 3 Press  (**Stop/Clear**) to return to ready mode.



Basic faxing

Darkness

You can select the degree of darkness of the original document.



The darkness setting is applied to the current fax job. To change the default setting (see "Fax menu" on page 187).

- 1 Select  (fax) >  (**Menu**) > **Fax Feature** > **Darkness** on the control panel.
- 2 Select a darkness level you want.
- 3 Press  (**Stop/Clear**) to return to ready mode.



3. Maintenance

This chapter provides information about purchasing supplies, accessories and maintenance parts available for your machine.

• Ordering supplies and accessories	66
• Available supplies	67
• Available maintenance parts	68
• Installing accessories	69
• Storing the toner cartridge	70
• Redistributing toner	72
• Replacing the toner cartridge	74
• Monitoring the supplies life	76
• Setting the toner low alert	77
• Cleaning the machine	78
• Tips for moving & storing your machine	84

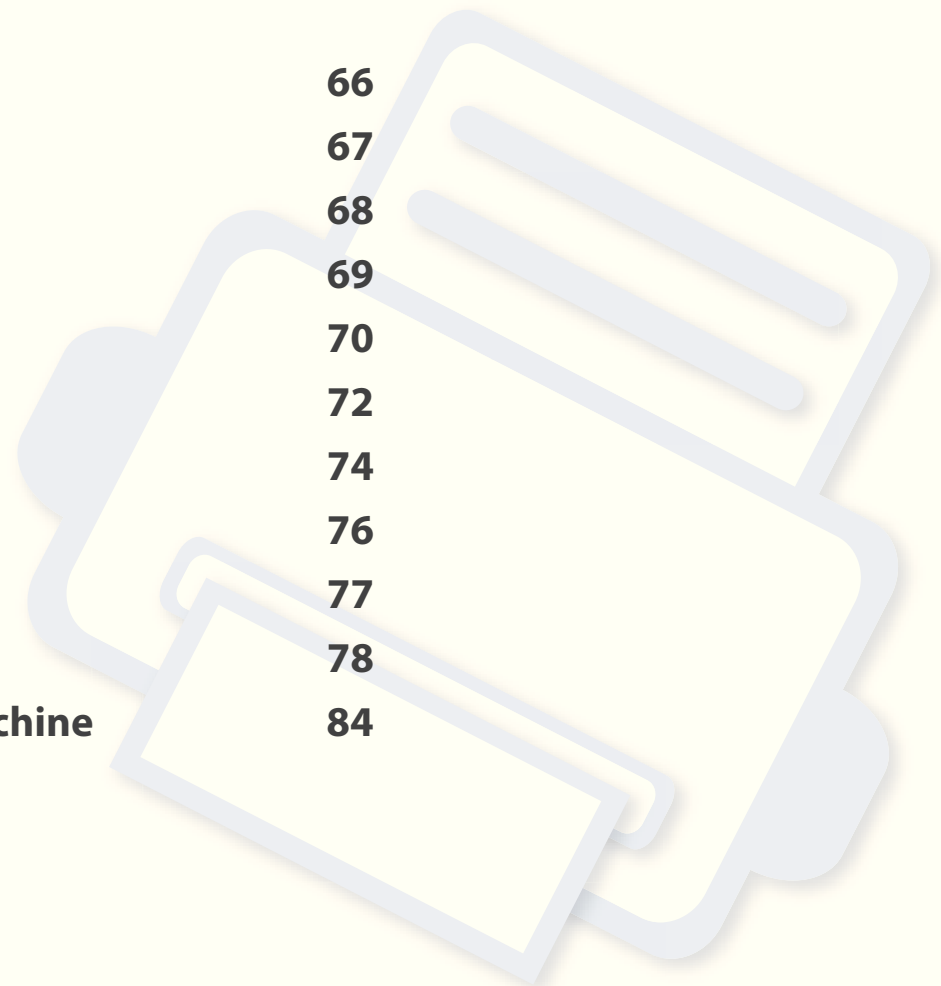

Ordering supplies and accessories



Available accessories may differ from country to country. Contact your sales representatives to obtain the list of available supplies, and maintenance parts.

To order Dell-authorized supplies, accessories, and maintenance parts, contact your local Dell dealer or the retailer where you purchased your machine. You can also visit www.Dell.com/supplies, and then select your country/region to obtain the contact information for service.

Available supplies

When supplies reach the end of their life spans, you can order the followings of supplies for your machine:

Type	Average yield ^a	Part name
Toner cartridge	Approx. 1,500 pages	YK1PM (All countries except China)
		15RRN (For China only)

a. Declared yield value in accordance with ISO/IEC 19752. The number of pages may be affected by operating environment, printing interval, graphics, media type and media size.



Depending on the options, percentage of image area and job mode used, the toner cartridge's lifespan may differ.



When purchasing new toner cartridges or other supplies, these must be purchased in the same country as the machine you are using. Otherwise, new toner cartridges or other supplies will be incompatible with your machine due to different configurations of toner cartridges and other supplies according to the specific country conditions.



Dell does not recommend using non-genuine Dell toner cartridge such as refilled or remanufactured toner. Dell cannot guarantee non-genuine Dell toner cartridge's quality. Service or repair required as a result of using non-genuine Dell toner cartridges will not be covered under the machine's warranty.

Available maintenance parts

To purchase maintenance parts, contact the source where you bought the machine. Replacing maintenance parts can be performed only by an authorized service provider, dealer, or the retailer where you bought the machine. The warranty does not cover the replacement of any maintenance parts once it has reached its "Average yield".

Maintenance parts are replaced at specific intervals to avoid print quality and paper feed problems resulting from worn parts, see table below. The purpose of which is to maintain your machine in top working condition. The maintenance parts below should be replaced when the life span of each item has been met.

Parts	Average yield ^a
Transfer Roller	Approx. 30,000 pages
Fuser Unit	Approx. 30,000 pages
Pick-Up Roller	Approx. 30,000 pages
Feed Roller	Approx. 30,000 pages
ADF Feed Roller^b	Approx. 20,000 pages
ADF Rubber Pad^b	Approx. 20,000 pages

a. It will be affected by the operating system used, computing performance, application software, connecting method, media, media size and job complexity.

b. This feature may not be available depending on model or optional goods (see "Variety feature" on page 7).

Installing accessories

When you install optional devices, such as optional tray, memory, etc, this machine automatically detects and sets the optional devices. If you cannot use the optional devices you installed in this driver, you can set the optional devices in **Device Settings** to use.

- 1 Click the Windows **Start** menu.
 - For Windows 8, from the **Charms**, select **Search > Settings**.
- 2 For Windows XP/2003, select **Printers and Faxes**.
 - For Windows 2008/Vista, select **Control Panel > Hardware and Sound>Printers**.
 - For Windows 7, select **Control Panel > Hardware and Sound>Device and Printers**.
 - For Windows Server 2008 R2, select **Control Panel > Hardware>Device and Printers**.
 - For Windows 8, search for **Device and Printers**.
- 3 Right-click your machine.
- 4 For Windows XP/2003/2008/Vista, press **Properties**.
 - For Windows 7, Windows Server 2008 R2, and Windows 8, from context menus, select **Printer properties**.



If **Printer properties** item has a ► mark, you can select other printer drivers connected with the selected printer.

- 5 Select **Device Options** or **Device Settings**.



The **Printer properties** window may differ depending on the driver or operating system you are using.

- 6 Select the appropriate option.



Some menus may not appear in the display depending on options or models. If so, it is not applicable to your machine.

- **Tray Options:** Select the optional tray you installed. You can select the tray.
- **Storage Options:** Select the optional memory you installed. If this feature is checked, you can select the **Print Mode**.
- **Printer Configuration:** Select the printer language for the print job.
- **Administrator Settings:** You can select the **Printer status** and **EMF Spooling**.
- **Custom Paper Size Settings:** You can specify custom paper size.

- 7 Click **OK** until you exit the **Printer properties** window.

Storing the toner cartridge

Toner cartridges contain components that are sensitive to light, temperature and humidity. Dell suggests users follow these recommendations to ensure optimal performance, highest quality, and longest life from your new Dell toner cartridge.

Store this cartridge in the same environment in which the printer will be used. This should be in controlled temperature and humidity conditions. The toner cartridge should remain in its original and unopened package until installation – if original packaging is not available, cover the top opening of the cartridge with paper and store in a dark cabinet.

Opening the cartridge package prior to use dramatically shortens its useful shelf and operating life. Do not store on the floor. If the toner cartridge is removed from the printer, follow the instructions below to store the toner cartridge properly.

- Store the cartridge inside the protective bag from the original package.
- Store lying flat (not standing on end) with the same side facing up as if it were installed in the machine.
- Do not store consumables in any of the following conditions:
 - Temperature greater than 40°C (104°F).
 - Humidity range less than 20% or greater than 80%.
 - An environment with extreme changes in humidity or temperature.
 - Direct sunlight or room light.
 - Dusty places.
 - A car for a long period of time.

- An environment where corrosive gases are present.
- An environment with salty air.

Handling instructions

- Do not touch the surface of the photoconductive drum in the cartridge.
- Do not expose the cartridge to unnecessary vibrations or shock.
- Never manually rotate the drum, especially in the reverse direction; this can cause internal damage and toner spillage.

Toner cartridge usage

Dell Inc. does not recommend or approve the use of non-Dell brand toner cartridges in your printer including generic, store brand, refilled, or remanufactured toner cartridges.



Dell's printer warranty does not cover damage to the machine caused by the use of a refilled, remanufactured, or non-Dell brand toner cartridges.

Storing the toner cartridge

Estimated cartridge life

Estimated cartridge life (the life of the toner cartridge yield) depends on the amount of toner that print jobs require. The actual print yield may vary depending on the print density of the pages you print on, operating environment, percentage of image area, printing interval, media type and/or media size. For example, if you print a lot of graphics, the consumption of the toner is higher and you may need to change the cartridge more often.

Redistributing toner

When the toner cartridge is near the end of its life:

- White streaks or light printing occurs and/or density variation side to side.
- The **Status** LED blinks red. In the case of machine with a **Toner** LED, it blinks orange.

If this happens, you can temporarily improve print quality by redistributing the remaining toner in the cartridge. In some cases, white streaks or light printing will still occur even after you have redistributed the toner.



Illustrations on this user's guide may differ from your machine depending on its options or models. Check your machine type (see "Front view" on page 18).



- To prevent damage to the toner cartridge, do not expose it to light for more than a few minutes. Cover it with a piece of paper, if necessary.
- Do not touch the green area of the toner cartridge. Use the handle on the cartridge to avoid touching this area.
- Do not use sharp objects such as a knife or scissors to open the toner cartridge package. They might scratch the drum of the cartridge.
- If toner gets on your clothing, wipe it off with a dry cloth and wash clothing in cold water. Hot water sets toner into fabric.
- When opening a scan unit, hold the document feeder and scan unit together.

Redistributing toner

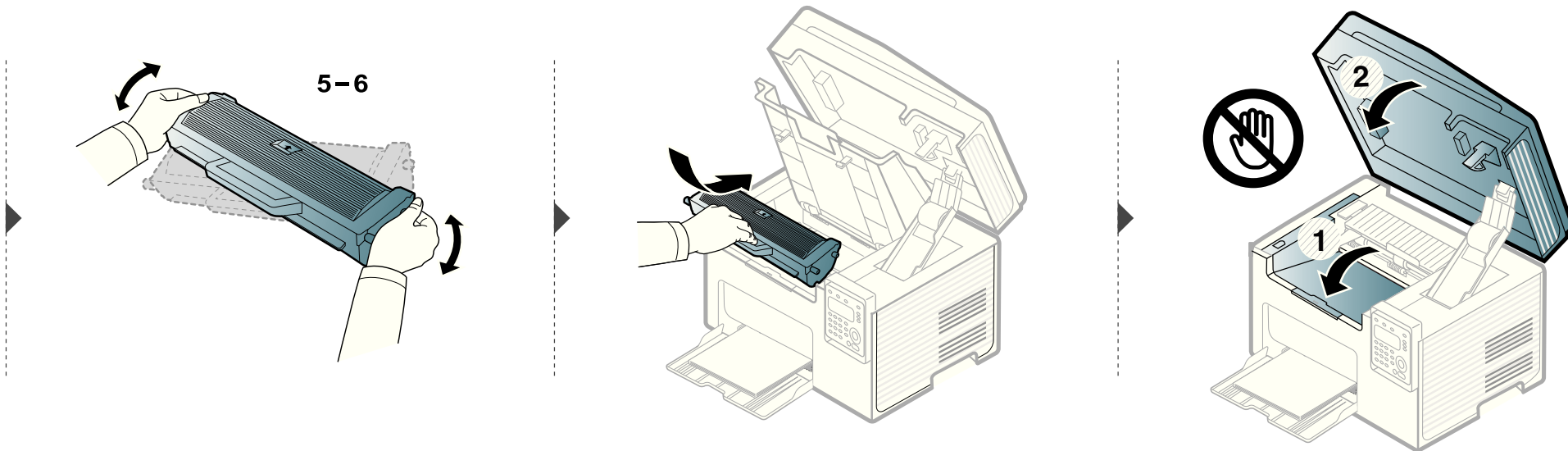
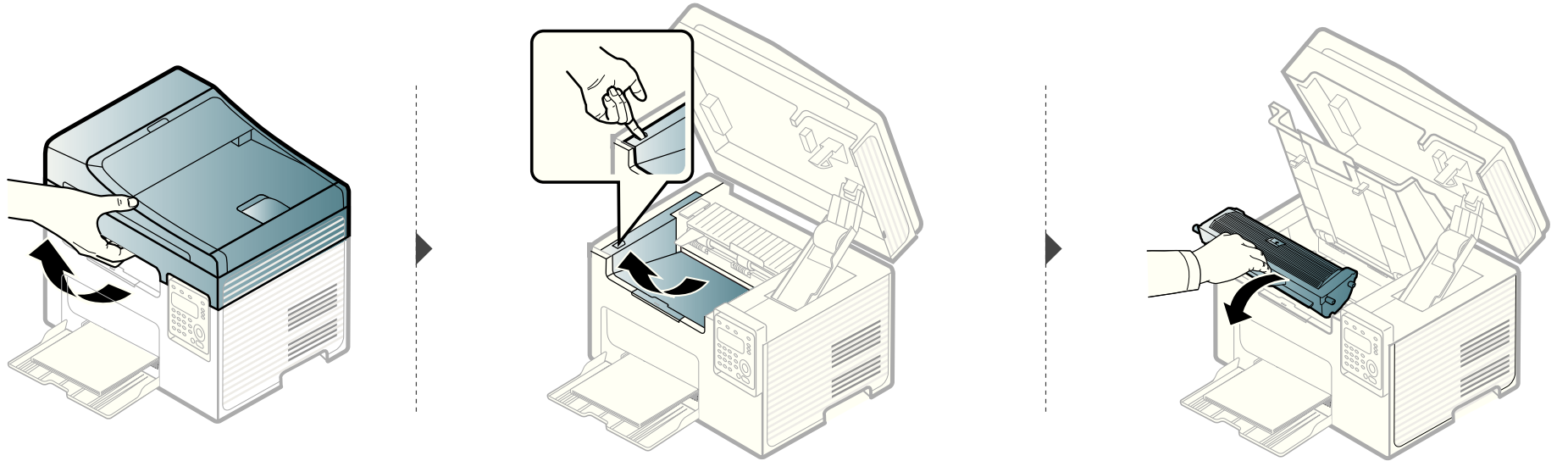

Replacing the toner cartridge



- Shake the toner cartridge thoroughly, it will increase the initial print quality.
- Illustrations on this user's guide may differ from your machine depending on its options or models. Check your machine type (see "Front view" on page 18).



- To prevent damage to the toner cartridge, do not expose it to light for more than a few minutes. Cover it with a piece of paper, if necessary.
- Do not touch the green area of the toner cartridge. Use the handle on the cartridge to avoid touching this area.
- Do not use sharp objects such as a knife or scissors to open the toner cartridge package. They might scratch the drum of the cartridge.
- If toner gets on your clothing, wipe it off with a dry cloth and wash clothing in cold water. Hot water sets toner into fabric.
- When opening a scan unit, hold the document feeder and scan unit together.

When a toner cartridge has reached the end of life, the machine will stop printing.

Replacing the toner cartridge

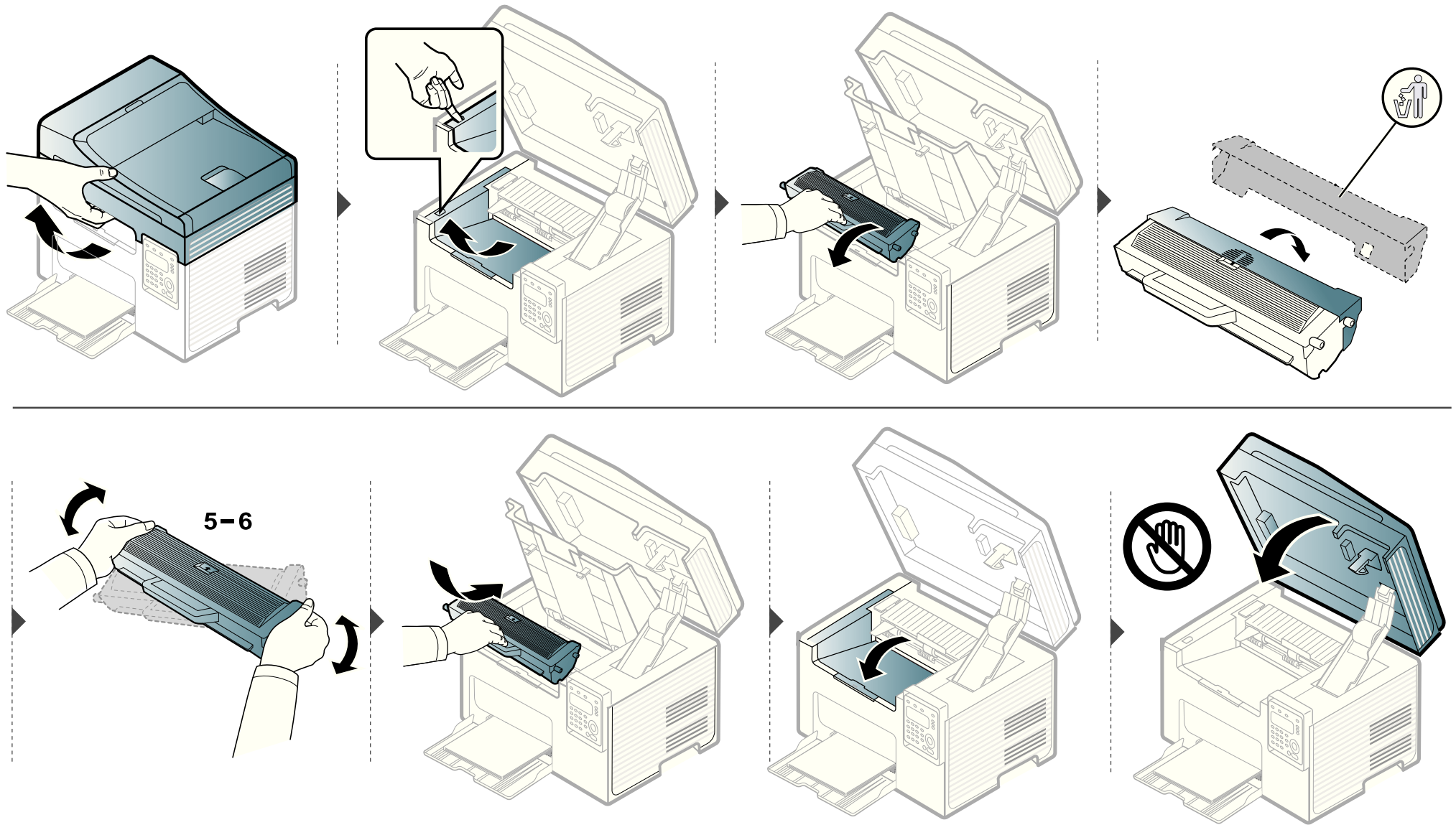



Monitoring the supplies life

If you experience frequent paper jams or printing problems, check the number of pages the machine has printed or scanned. Replace the corresponding parts, if necessary.



- In ready mode, press and hold  (**Stop/Clear**) button for about 6 seconds, then release. A supplied Information report prints out.
- It may be necessary to press **OK** to navigate to lower-level menus for some models.

- 1 Select  (**Menu**) > **System Setup** > **Maintenance** > **Supplies Life** on the control panel.
- 2 Select the option you want and press **OK**.
 - **Total:** Displays the total number of pages printed.
 - **ADF Scan:** Displays the number of pages printed by using the document feeder.
 - **Platen Scan:** Displays the number of pages scanned by using scanner glass.
 - **Supplies Info.:** Prints the supply information page.
- 3 Press  (**Stop/Clear**) to return to ready mode.

Setting the toner low alert

If the amount of toner in the cartridge is low, a message or LED informing the user to change the toner cartridge appears. You can set the option for whether or not this message or LED appears.



You can set the machine's settings by using the **Device Settings** in Dell Printer Manager program or **Machine** section in Printer Settings Utility program.

- For Windows and Mac users, see "Device Settings" on page 253.

- 1 Select  (**Menu**) > **System Setup** > **Maintenance** > **TonerLow Alert** on the control panel.
- 2 Select the option you want.
- 3 Press **OK** to save the selection.

Cleaning the machine

If printing quality problems occur or if you use your machine in a dusty environment, you need to clean your machine regularly to keep it in the best printing condition and use your machine longer.



- Cleaning the cabinet of the machine with cleaning materials containing large amounts of alcohol, solvents, or other strong substances can discolor or distort the cabinet.
- If your machine or the surrounding area is contaminated with toner, we recommend you use a cloth or tissue dampened with water to clean it. If you use a vacuum cleaner, toner blows in the air and might be harmful to you.

Cleaning the outside

Clean the machine cabinet with a soft, lint-free cloth. Dampen the cloth slightly with water, but be careful not to let any water drip onto or into the machine.

Cleaning the machine

Cleaning the inside

During the printing process, paper, toner, and dust particles can accumulate inside the machine. This buildup can cause print quality problems, such as toner specks or smearing. Cleaning the inside of the machine clears and reduces these problems.



- To prevent damage to the toner cartridge, do not expose it to light for more than a few minutes. Cover it with a piece of paper, if necessary.
- Do not touch the green area of the toner cartridge. Use the handle on the cartridge to avoid touching this area.
- Use a dry lint free cloth when cleaning the inside of the machine, be careful not to damage the transfer roller or any other inside parts. Do not use solvents such as benzene or thinner. Printing quality problems can occur and cause damage to the machine.



- Use a dry lint-free cloth to clean the machine.
- Turn the machine off and unplug the power cord. Wait for the machine to cool down. If your machine has a power switch, turn the power switch off before cleaning the machine.
- Illustrations on this user's guide may differ from your machine depending on its options or models. Check your machine type (see "Front view" on page 18).
- When opening a scan unit, hold the document feeder and scan unit together.

Cleaning the machine

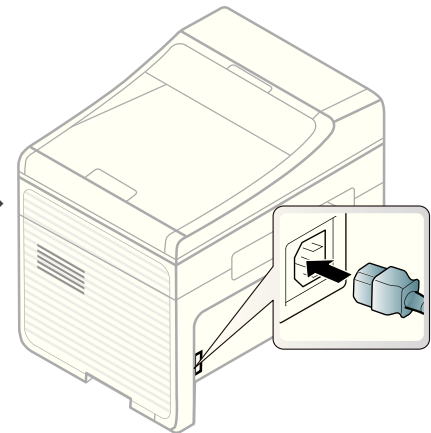
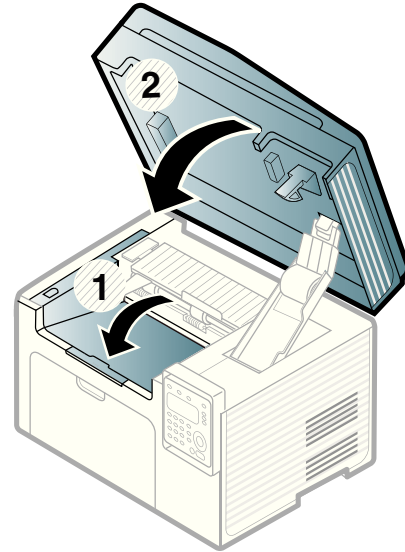
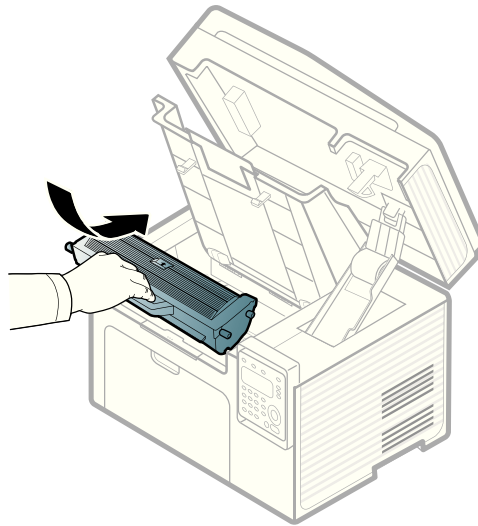
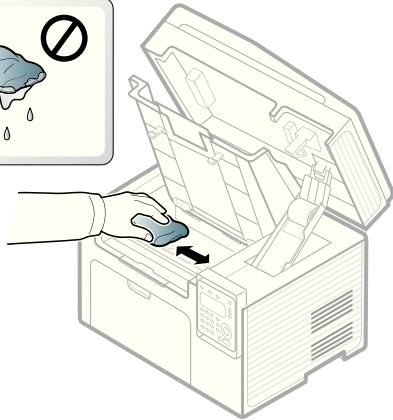
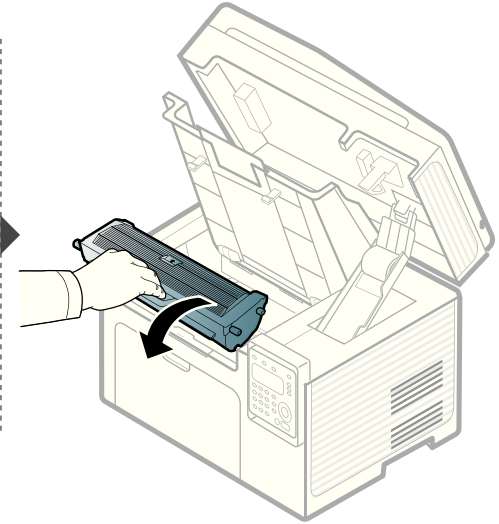
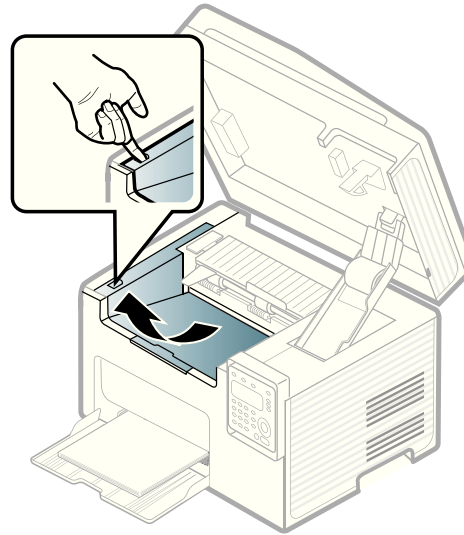
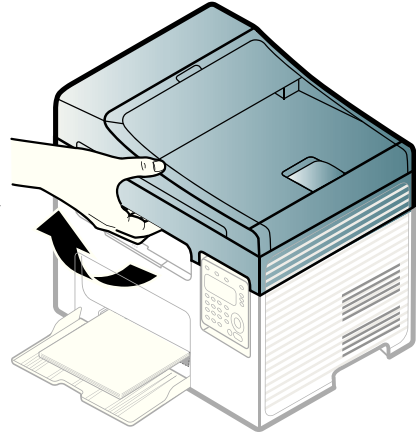
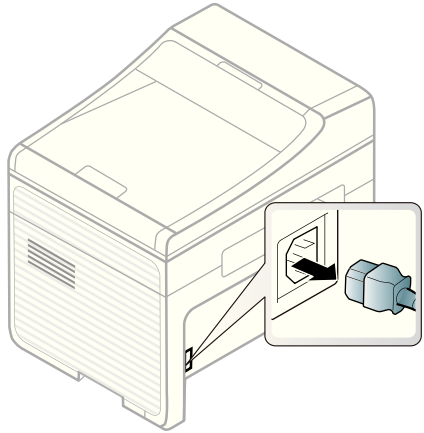

Cleaning the machine

Cleaning the pickup roller



- Turn the machine off and unplug the power cord. Wait for the machine to cool down. If your machine has a power switch, turn the power switch off before cleaning the machine.
- Illustrations on this user's guide may differ from your machine depending on its options or models. Check your machine type (see "Front view" on page 18).

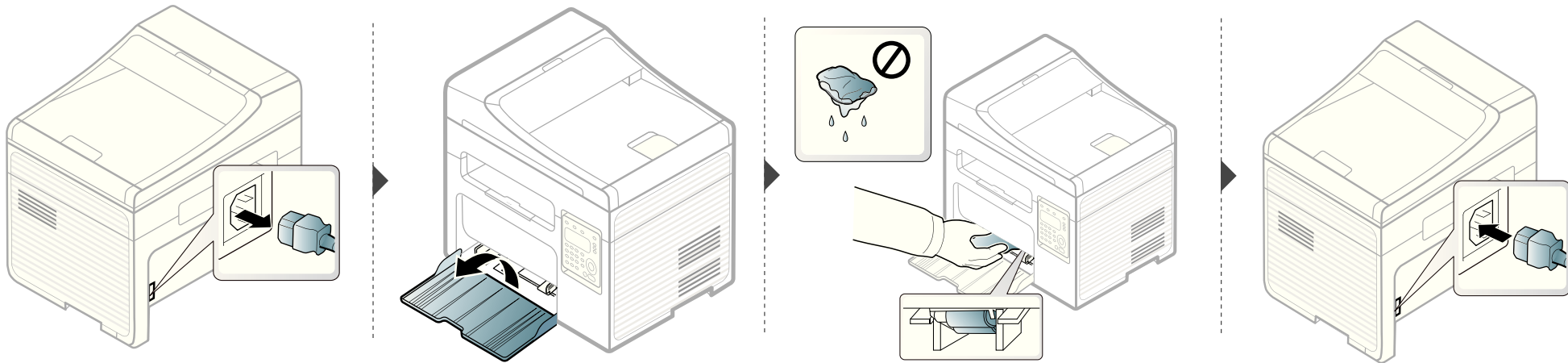

Cleaning the machine

Cleaning the scan unit

Keeping the scan unit clean helps ensure the best possible copies. We suggest that you clean the scan unit at the start of each day and during the day as needed.



- Turn the machine off and unplug the power cord. Wait for the machine to cool down. If your machine has a power switch, turn the power switch off before cleaning the machine.
- Illustrations on this user's guide may differ from your machine depending on its options or models. Check your machine type (see "Front view" on page 18).

- 1 Slightly dampen a soft, lint-free cloth or paper towel with water.
- 2 Lift and open the scanner lid.

Cleaning the machine

- 3** Wipe the surface of the scanner until it is clean and dry.

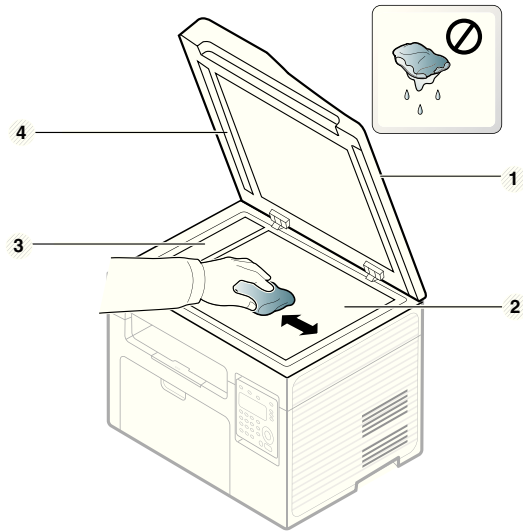

- 1** Scanner lid
- 2** Scanner glass
- 3** Document feeder glass
- 4** White bar

- 4** Close the scanner lid.

Tips for moving & storing your machine

- When moving the machine, do not tilt or turn it upside down. Otherwise, the inside of the machine may be contaminated by toner, which can cause damage to the machine or reduce print quality.
- When moving the machine, make sure at least two people are holding the machine securely.



4. Troubleshooting

This chapter gives helpful information for what to do if you encounter an error.

- **Tips for avoiding paper jams** 86
- **Clearing original document jams** 87
- **Clearing paper jams** 92
- **Understanding the status LED** 96
- **Understanding display messages** 98



This chapter gives helpful information for what to do if you encounter an error. If your machine has a display screen, check the message on the display screen first to solve the error. If you cannot find a solution to your problem in this chapter, refer to the **Troubleshooting** chapter in the Advanced Guide (see "Troubleshooting" on page 264). If you cannot find a solution in the User's Guide or the problem persists, call for service.

Tips for avoiding paper jams

By selecting the correct media s, most paper jams can be avoided. To avoid paper jams, refer to the following guidelines:

- Ensure that the adjustable guides are positioned correctly (see "Tray overview" on page 37).
- Do not remove paper from the tray while your machine is printing.
- Flex, fan, and straighten paper before loading.
- Do not use creased, damp, or highly curled paper.
- Do not mix papers in a tray.
- Use only recommended print media (see "Print media specifications" on page 106).

Clearing original document jams

When an original document jams in the document feeder, a warning message appears on the display.

 To avoid tearing the document, remove the jammed document slowly and carefully.

 To prevent document jams, use the scanner glass for thick, thin or mixed paper- originals.

Clearing original document jams

Original paper jam in front of scanner



- Illustrations on this user's guide may differ from your machine depending on its options or models. Check your machine type (see "Front view" on page 18).
- This troubleshooting may not be available depending on model or optional goods (see "Variety feature" on page 7).

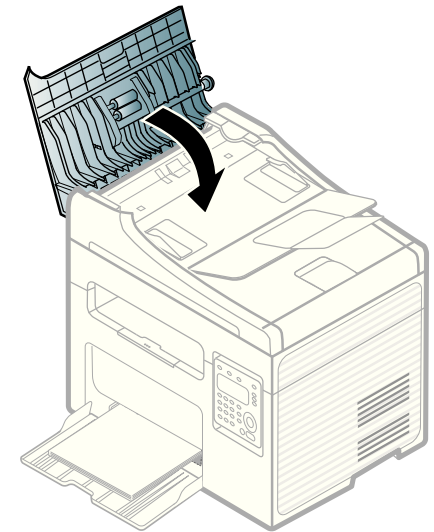
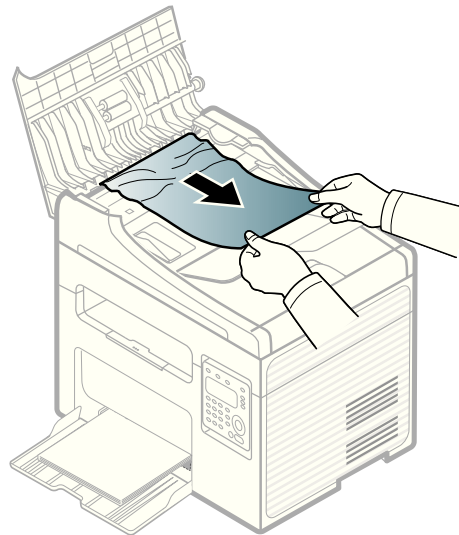
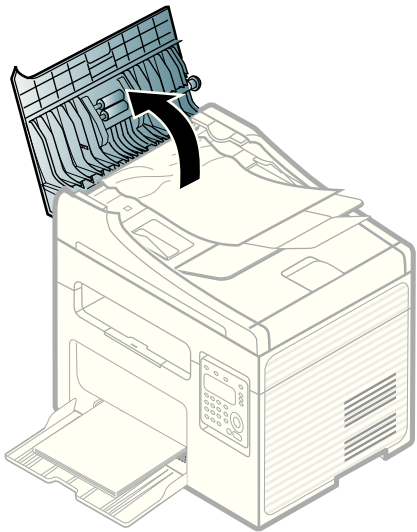

Clearing original document jams

Original paper jam inside of scanner



- Illustrations on this user's guide may differ from your machine depending on its options or models. Check your machine type (see "Front view" on page 18).
- This troubleshooting may not be available depending on model or optional goods (see "Variety feature" on page 7).

Clearing original document jams

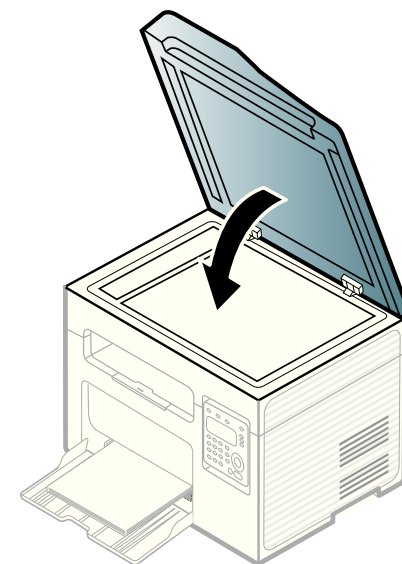
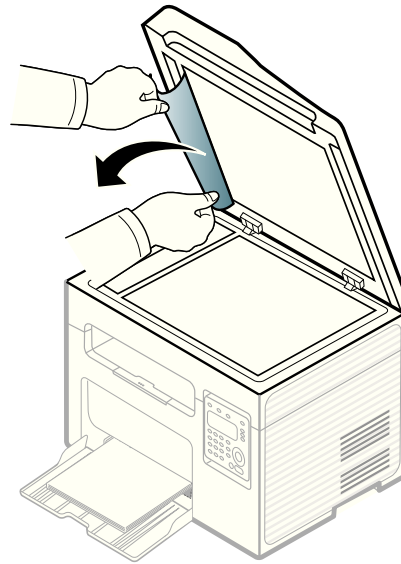
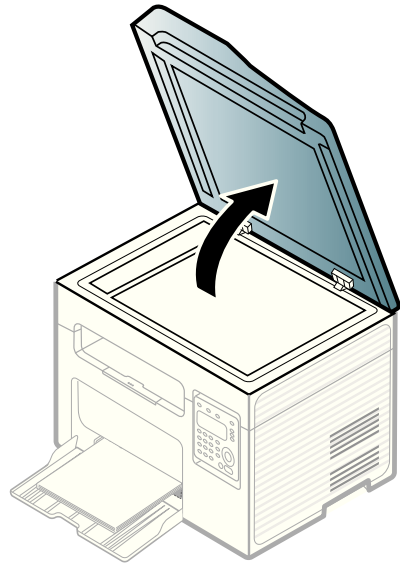
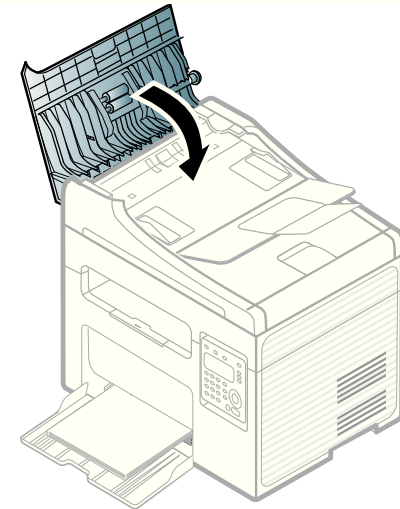
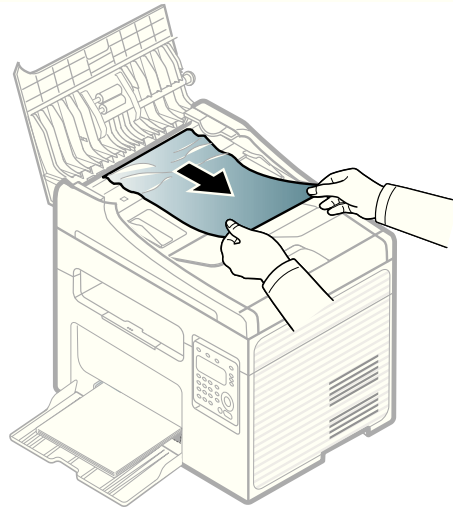
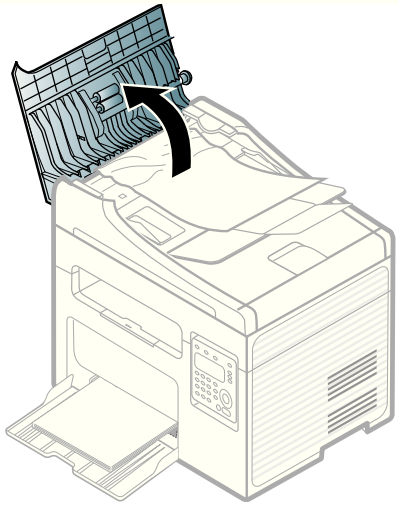

Clearing original document jams

Original paper jam in exit area of scanner



- Illustrations on this user's guide may differ from your machine depending on its options or models. Check your machine type (see "Front view" on page 18).
- This troubleshooting may not be available depending on model or optional goods (see "Front view" on page 18).

- 1 Remove any remaining pages from the document feeder.
- 2 Gently remove the jammed paper from the document feeder.

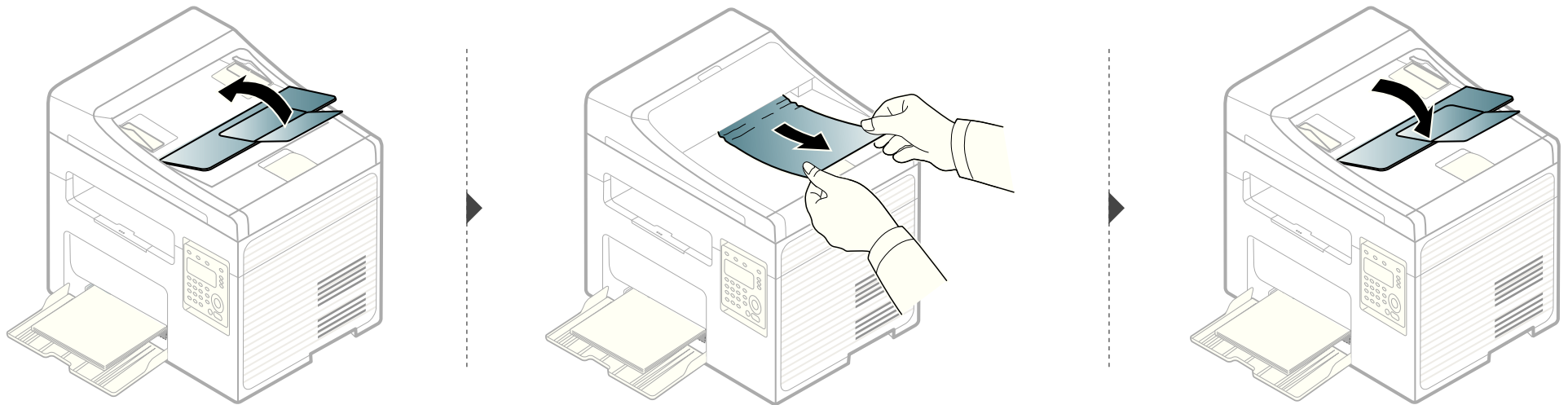

Clearing paper jams

 To avoid tearing the paper, pull the jammed paper out slowly and gently.

In tray

 Illustrations on this user's guide may differ from your machine depending on its options or models. Check your machine type (see "Front view" on page 18).

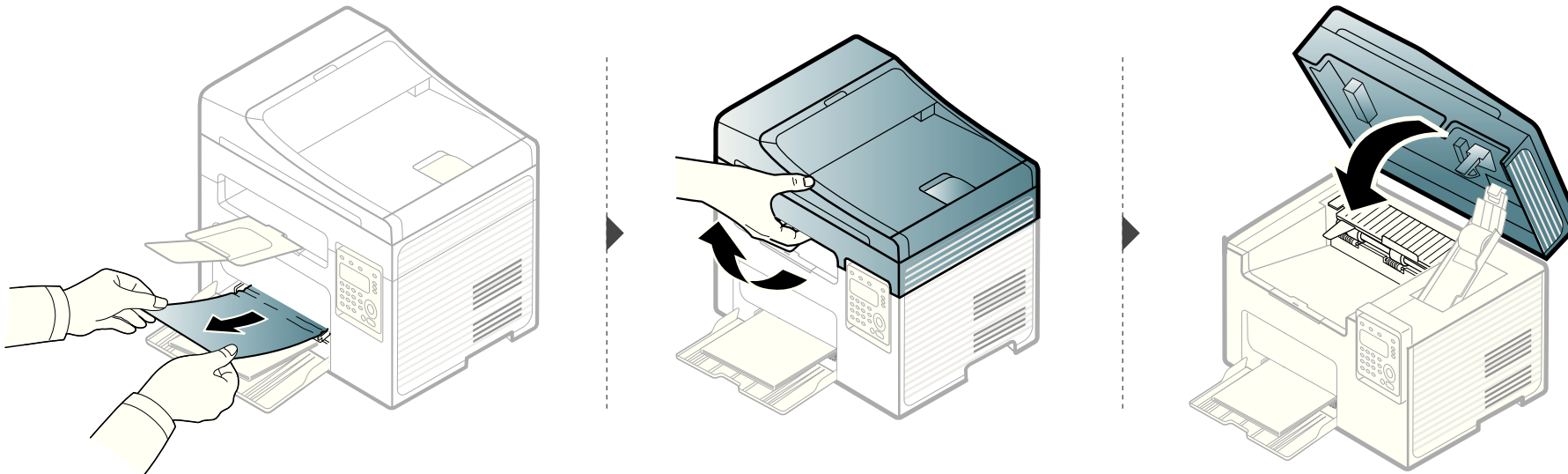

Clearing paper jams

Inside the machine



- The fuser area is hot. Take care when removing paper from the machine.
- Illustrations on this user's guide may differ from your machine depending on its options or models. Check your machine type (see "Front view" on page 18).

Clearing paper jams

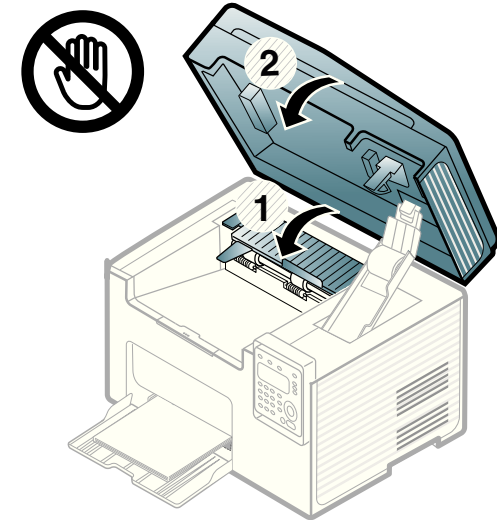
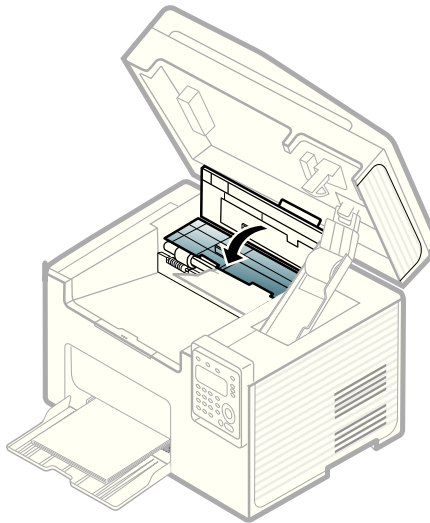
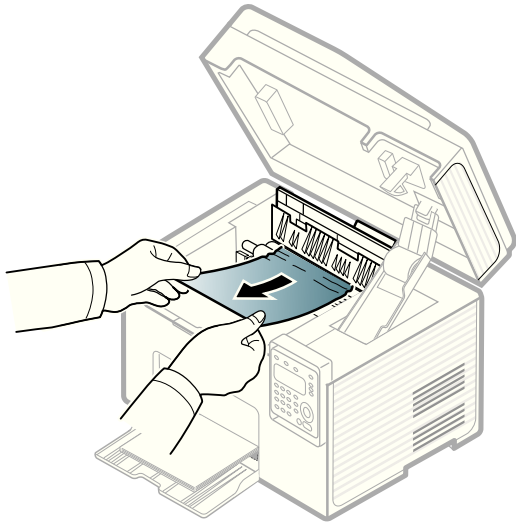
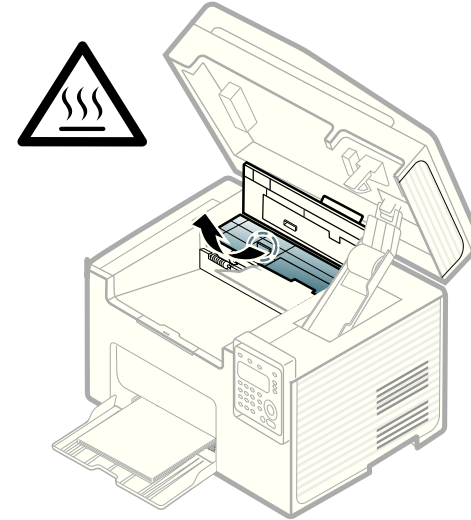
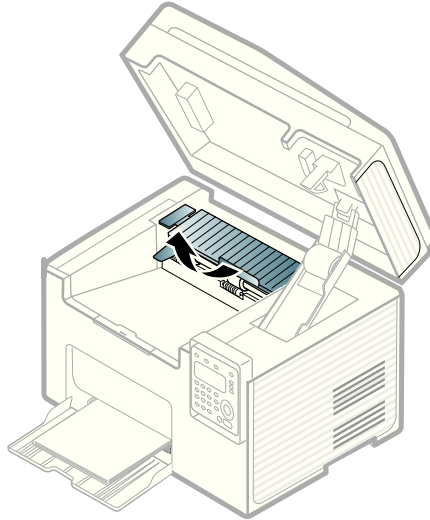
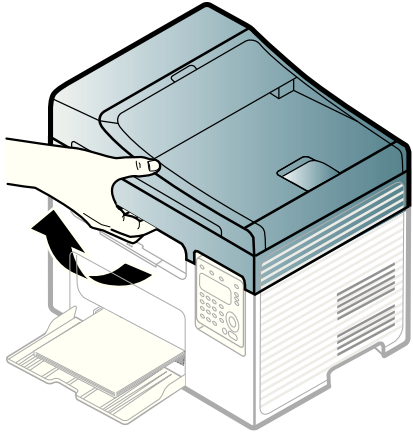

Clearing paper jams

If you do not see the paper in this area, stop and go to next step:

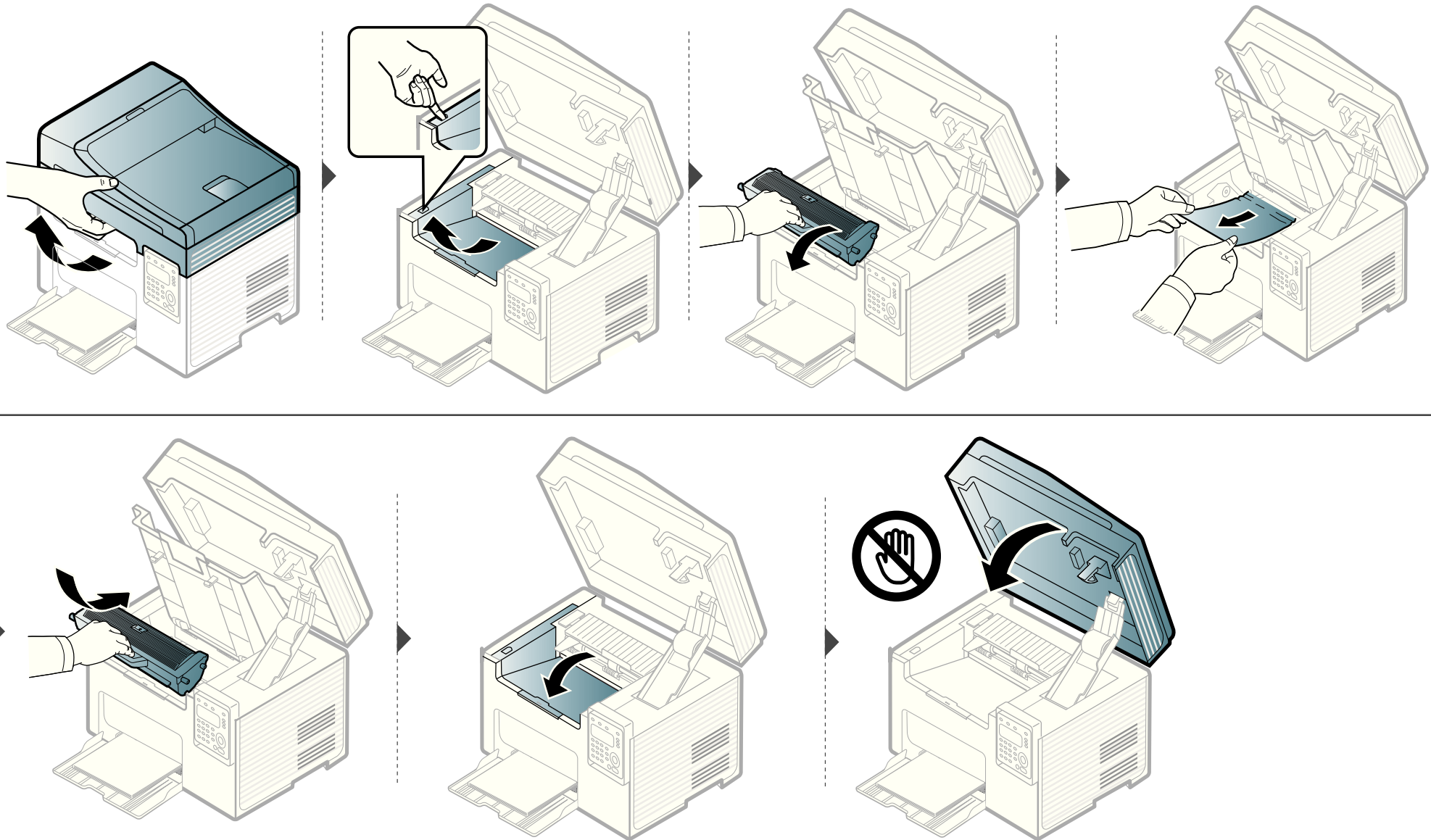

Understanding the status LED



The color of the LED indicates the machine's current status.



- Some LEDs may not be available depending on model or country (see "Control panel overview" on page 21).
- To resolve the error, look at the error message and its instructions from the troubleshooting part (see "Understanding display messages" on page 98).
- You also can resolve the error with the guideline from the computers's Dell Printing Status or Smart Panel program window (see "Using Dell Printer Status" on page 254).
- If the problem persists, call a service representative.

LED	Status	Description	
Status	Off	The machine is off-line.	
	Green	Blinking	When the backlight blinks, the machine is receiving or printing data.
		On	<ul style="list-style-type: none">• The machine is on-line and can be used.
	Red	Blinking	<ul style="list-style-type: none">• A minor error has occurred and the machine is waiting for the error to be cleared. Check the display message. When the problem is cleared, the machine resumes.• Small amount of toner is left in the cartridge. The estimated cartridge life^a of toner is close. Prepare a new cartridge for replacement. You may temporarily increase the printing quality by redistributing the toner (see "Redistributing toner" on page 72).^b
			On

Understanding the status LED

LED	Status	Description
 WPS^b	Blue	Blinking The machine is connecting to a wireless network.
		On The machine is connected to a wireless network (see "Wireless network setup" on page 149).
		Off The machine is disconnected from a wireless network.
 Power/ Wakeup	Blue	On The machine is in power save mode.
		Off The machine is in ready mode or machine's power is off.
Eco	Green	On Eco mode is on. The default setting of Eco mode is 2-up and toner save.
		Off Eco mode is off.
Toner^b	Orange	Blinking Small amount of toner is left in the cartridge. The estimated cartridge life ^a of toner is close. Prepare a new cartridge for replacement. You may temporarily increase the printing quality by redistributing the toner (see "Redistributing toner" on page 72).
		On A toner cartridge has almost reached its estimated cartridge life ^a . It is recommended to replace the toner cartridge (see "Replacing the toner cartridge" on page 74).
		Off All toner cartridges are at normal capacity.

a. Estimated cartridge life means the expected or estimated toner cartridge life, which indicates the average capacity of print-outs and is designed pursuant to ISO/IEC 19752. The number of pages may be affected by operating environment, percentage of image area, printing interval, graphics, media and media size. Some amount of toner may remain in the cartridge even when red LED is on and the printer stops printing.

b. Some LEDs may not be available depending on model or country (see "Control panel overview" on page 21).

Understanding display messages

Messages appear on the control panel display to indicate the machine's status or errors. Refer to the tables below to understand the messages' and their meaning, and correct the problem, if necessary.



- You can resolve the error with the guideline from the computers's Printing Status or Smart Panel program window (see "Using Dell Printer Status" on page 254).
- If a message is not in the table, reboot the power and try the printing job again. If the problem persists, call a service representative.
- When you call for service, provide the service representative with the contents of display message.
- Some messages may not appear on the display depending on the options or models.
- [error number] indicates the error number.

Paper Jam-related messages



Message	Meaning	Suggested solutions
Document jam. Remove jam	The loaded original document has jammed in the document feeder.	Clear the jam (see "Clearing original document jams" on page 87).
Jam or empty Door open&close	<ul style="list-style-type: none">• Paper has jammed in the paper feed area.• There is no paper in tray.	<ul style="list-style-type: none">• Clear the jam (see "In tray" on page 92).• Load paper in tray (see "Loading paper in the tray" on page 38).
Paper Jam inside machine	Paper has jammed in the inside machine.	Clear the jam (see "Inside the machine" on page 93).

Understanding display messages

Toner-related messages

Message	Meaning	Suggested solutions
Install Toner Cartridge	A toner cartridge is not installed.	Install a toner cartridge.
Not Compatible Toner cartridge	The toner cartridge you have installed is not for your machine.	Install a Dell-genuine toner cartridge, designed for your machine.
Prepare new cartridge	Small amount of toner is left in the indicated cartridge. The estimated cartridge life of toner is close.	Prepare a new cartridge for a replacement. You may temporarily increase the printing quality by redistributing the toner (see "Redistributing toner" on page 72).

Understanding display messages

Message	Meaning	Suggested solutions
Replace new cartridge	<p>The indicated toner cartridge has almost reached its estimated cartridge life.</p> <div data-bbox="492 395 1294 884"><p>Estimated cartridge life means the expected or estimated toner cartridge life, which indicates the average capacity of print-outs and is designed pursuant to ISO/IEC 19752 (see "Available supplies" on page 67). The number of pages may be affected by operating environment, percentage of image area, printing interval, media, percentage of image area, and media size. Some amount of toner may remain in the cartridge even when replace new cartridge appears and the machine stops printing.</p></div>	<ul style="list-style-type: none">You can choose Stop or Continue as shown on the control panel. If you select Stop, the printer stops printing and you cannot print any more without changing the cartridge. If you select Continue, the printer keeps printing but the printing quality cannot be guaranteed.Replace the toner cartridge for the best print quality when this message appears. Using a cartridge beyond this stage can result in printing quality issues (see "Replacing the toner cartridge" on page 74). <div data-bbox="1321 676 2195 995"><p>Dell does not recommend using a non-genuine Dell toner cartridge such as refilled or remanufactured. Dell cannot guarantee a non-genuine Dell toner cartridge's quality. Service or repair required as a result of using non-genuine Dell toner cartridges will not be covered under the machine warranty.</p></div>
	<p>The indicated toner cartridge has reached its estimated cartridge life. The machine might stop printing.</p>	<p>Replace the toner cartridge (see "Replacing the toner cartridge" on page 74).</p>

Understanding display messages

Tray-related messages

Message	Meaning	Suggested solutions
Jam or empty Door open&close	<ul style="list-style-type: none">• Paper has jammed in the paper feed area.• There is no paper in tray.	<ul style="list-style-type: none">• Clear the jam (see "In tray" on page 92).• Load paper in tray (see "Loading paper in the tray" on page 38).

Network-related messages

Message	Meaning	Suggested solutions
Network Problem: IP Conflict	The network IP address you have set is being used by someone else.	Check the IP address and reset it if necessary (see "Printing a network configuration report" on page 138).
Wireless Network Error	Wireless module is not installed.	Call for service.

Understanding display messages

Misc. messages

Message	Meaning	Suggested solutions
Door Open Close it	The cover is not securely latched.	Close the cover until it locks into place.
Door of scanner is open.	The document feeder cover is not securely latched.	Close the cover until it locks into place.
Error [error number] Turn off then on	The machine unit cannot be controlled.	Reboot the power and try the printing job again. If the problem persists, please call for service.
Error [error number] Call for service		
Scanner Locked	The scanner is locked.	Reboot the power. If the problem persists, please call for service.



5. Appendix

This chapter provides product specifications and information concerning applicable regulations.

- **Specifications** 104
- **Regulatory information** 113
- **Copyright** 126

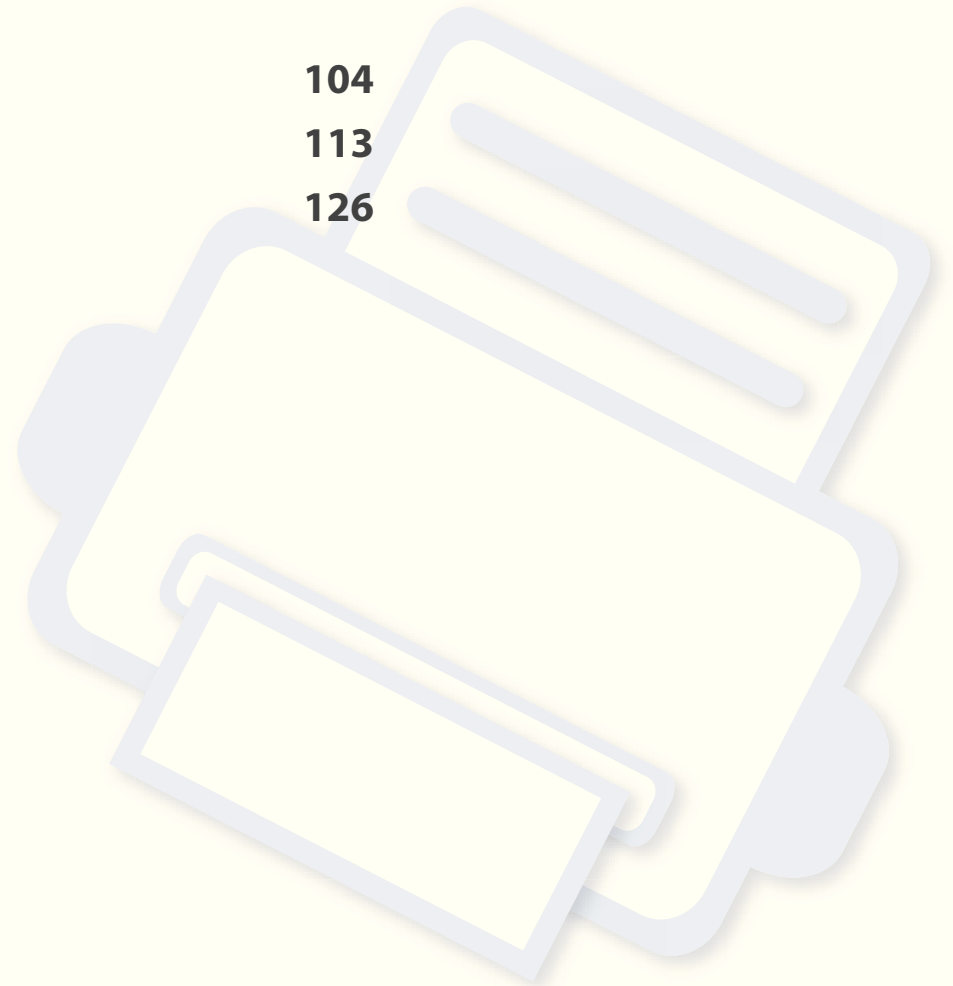

Specifications

General specifications



The specification values listed below are subject to change without notice. See www.Dell.com for possible changes in information.

Items		Description		
Dimension	Width x Length x Height	B1165nfw Series	402 x 293 x 296 mm (15.83 x 11.54x 11.65 inches)	
Weight	Machine with consumables	B1165nfw Series	8 Kg (17.64lbs)	
Noise Level^a	Ready mode	Less than 26 dB (A)		
	Print mode	Less than 50 dB (A)		
	Copy mode	Scanner glass	Less than 50 dB (A)	
		Document feeder	Less than 52 dB (A)	
	Scan mode	Scanner glass	Less than 52 dB (A)	
		Document feeder	Less than 54 dB (A)	
Temperature	Operation	10 to 32°C (50 to 89.6°F)		
	Storage (packed)	-20 to 40°C (-4 to 104°F)		
Humidity	Operation	20 to 80% RH		
	Storage (packed)	10 to 90% RH		

Specifications

	Items	Description
Power rating^b	110 volt models	AC 110 - 127 V
	220 volt models	AC 220 - 240 V
Power consumption	Average operating mode	Less than 310 W
	Ready mode	Less than 30 W
	Power save mode^c	• B1165nfw Series: Less than 1.6 W (Wi-Fi Direct on: Less than 2.3W)
	Power off mode^d	Less than 0.45 W
Wireless	Module	SPW-B4319S

a. Sound Pressure Level, ISO 7779. Configuration tested: basic machine installation, A4 paper, simplex printing.

b. See the rating label on the machine for the correct voltage (V), frequency (hertz) and of current (A) for your machine.

c. The power consumption of power save mode may be affected by machine's status, setting conditions, operating environment.

d. Power consumption can be completely avoided only when the power cable is not connected.

Specifications

Print media specifications

Type	Size	Dimensions	Print media weight/Capacity ^a	
			Tray	Manual feeding in tray ^b
Plain paper	Letter	216 x 279 mm (8.5 x 11 inches)	71 to 85 g/m ² (19 to 23 lbs bond) • 150 sheets of 80 g/m ² (21 lbs bond)	71 to 85 g/m ² (19 to 23 lbs bond) • 1 sheet
	Legal	216 x 356 mm (8.5 x 14 inches)		
	US Folio	216 x 330 mm (8.5 x 13 inches)		
	A4	210 x 297 mm (8.27 x 11.69 inches)		
	Oficio	216 x 343 mm (8.5 x 13.5 inches)		
	JIS B5	182 x 257 mm (7.17 x 10.12 inches)		
	ISO B5	176 x 250 mm (6.93 x 9.84 inches)		
	Executive	184 x 267 mm (7.25 x 10.5 inches)		
	A5	148 x 210 mm (5.83 x 8.27 inches)		
Envelope	Envelope Monarch	98 x 191 mm (3.87 x 7.5 inches)	75 to 90 g/m ² (20 to 24 lbs bond) • 10 sheets	75 to 90 g/m ² (20 to 24 lbs bond) • 1 sheet
	Envelope No. 10	105 x 241 mm (4.12 x 9.5 inches)		
	Envelope DL	110 x 220 mm (4.33 x 8.66 inches)		
	Envelope C5	162 x 229 mm (6.38 x 9.02 inches)		

Specifications

Type	Size	Dimensions	Print media weight/Capacity ^a	
			Tray	Manual feeding in tray ^b
Thick paper	Refer to the Plain paper section	Refer to the Plain paper section	86 to 120 g/m ² (23 to 32 lbs bond) • 50 sheets of 120 g/m ² (32 lbs bond)	86 to 120 g/m ² (23 to 32 lbs bond) • 1 sheet
Thin paper	Refer to the Plain paper section	Refer to the Plain paper section	60 to 70 g/m ² (16 to 19 lbs bond) • 160 sheets of 60 g/m ² (16 lbs bond)	60 to 70 g/m ² (16 to 19 lbs bond) • 1 sheet
Cotton	Refer to the Plain paper section	Refer to the Plain paper section	75 to 90 g/m ² (20 to 24 lbs bond) • 150 sheets of 80 g/m ² (21 lbs bond)	75 to 90 g/m ² (20 to 24 lbs bond) • 1 sheet
Colored	Refer to the Plain paper section	Refer to the Plain paper section	75 to 90 g/m ² (20 to 24 lbs bond) • 150 sheets of 80 g/m ² (21 lbs bond)	75 to 90 g/m ² (20 to 24 lbs bond) • 1 sheet
Pre-printed	Refer to the Plain paper section	Refer to the Plain paper section	75 to 90 g/m ² (20 to 24 lbs bond) • 150 sheets of 80 g/m ² (21 lbs bond)	75 to 90 g/m ² (20 to 24 lbs bond) • 1 sheet
Recycled	Refer to the Plain paper section	Refer to the Plain paper section	60 to 90 g/m ² (16 to 24 lbs bond) • 150 sheets of 80 g/m ² (21 lbs bond)	60 to 90 g/m ² (16 to 24 lbs bond) • 1 sheet

Specifications

Type	Size	Dimensions	Print media weight/Capacity ^a	
			Tray	Manual feeding in tray ^b
Labels ^c	Letter, Legal, US Folio, A4, JIS B5, ISO B5, Executive, A5	Refer to the Plain paper section	120 to 150 g/m ² (32 to 40 lbs bond) • 10 sheets	120 to 150 g/m ² (32 to 40 lbs bond) • 1 sheet
Card stock	Letter, Legal, US Folio, A4, JIS B5, ISO B5, Executive, A5, Postcard 4x6	Refer to the Plain paper section	121 to 163 g/m ² (32 to 43 lbs bond) • 10 sheets	121 to 163 g/m ² (32 to 43 lbs bond) • 1 sheet
Bond paper	Refer to the Plain paper section	Refer to the Plain paper section	• 10 sheets	• 1 sheet
Archive	Refer to the Plain paper section	Refer to the Plain paper section	• 100 sheets	• 1 sheet
Minimum size (custom)		76 x 127 mm (3 x 5 inches)	60 to 163 g/m ² (16 to 43 lbs bond)	
Maximum size (custom)		216 x 356 mm (8.5 x 14 inches)		

a. Maximum capacity may differ depending on media weight, thickness, and environmental conditions.

b. 1 sheet for manual feeding.

c. The smoothness of the labels used in this machine is 100 to 250 (sheffield). This means the numeric level of smoothness.

Specifications

System requirements

Microsoft® Windows®

Operating system	Requirement (recommended)		
	CPU	RAM	free HDD space
Windows® 2000	Intel® Pentium® II 400 MHz (Pentium III 933 MHz)	64 MB (128 MB)	600 MB
Windows® XP	Intel® Pentium® III 933 MHz (Pentium IV 1 GHz)	128 MB (256 MB)	1.5 GB
Windows Server® 2003	Intel® Pentium® III 933 MHz (Pentium IV 1 GHz)	128 MB (512 MB)	1.25 GB to 2 GB
Windows Server® 2008	Intel® Pentium® IV 1 GHz (Pentium IV 2 GHz)	512 MB (2 GB)	10 GB
Windows Vista®	Intel® Pentium® IV 3 GHz	512 MB (1 GB)	15 GB
Windows® 7	Intel® Pentium® IV 1 GHz 32-bit or 64-bit processor or higher	1 GB (2 GB)	16 GB
	<ul style="list-style-type: none">• Support for DirectX® 9 graphics with 128 MB memory (to enable the Aero theme).• DVD-R/W Drive		
Windows Server® 2008 R2	Intel® Pentium® IV 1 GHz (x86) or 1.4 GHz (x64) processors (2 GHz or faster)	512 MB (2 GB)	10 GB
Windows® 8	Intel® Pentium® IV 1 GHz 32-bit or 64-bit processor or higher	1 GB (2 GB)	16 GB

Specifications



- Internet Explorer 6.0 or higher is the minimum requirement for all Windows operating systems.
- Users who have administrator rights can install the software.
- **Windows Terminal Services** is compatible with your machine.
- For **Windows 2000, Services Pack 4** or higher is required.

Mac

Operating system	Requirements (Recommended)		
	CPU	RAM	Free HDD space
Mac OS X 10.5	<ul style="list-style-type: none">• Intel® processors• 867 MHz or faster Power PC G4/G5	512 MB (1 GB)	1 GB
Mac OS X 10.6	<ul style="list-style-type: none">• Intel® processors	1 GB (2 GB)	1 GB
Mac OS X 10.7	<ul style="list-style-type: none">• Intel® processors	2 GB	4 GB

Specifications

Linux

Items	Requirements
Operating system	Redhat® Enterprise Linux WS 4, 5, 6(32/64 bit) Fedora 5 ~ 15 (32/64 bit) OpenSuSE® 10.2, 10.3, 11.0, 11.1, 11.2, 11.3, 11.4 (32/64 bit) Mandriva 2007, 2008, 2009, 2009.1, 2010 (32/64 bit) Ubuntu 6.06, 6.10, 7.04, 7.10, 8.04, 8.10, 9.04, 9.10, 10.04, 10.10, 11.04 (32/64 bit) SuSE Linux Enterprise Desktop 10, 11 (32/64 bit) Debian 4.0, 5.0, 6.0 (32/64 bit)
CPU	Pentium IV 2.4GHz (Intel Core™2)
RAM	512 MB (1 GB)
Free HDD space	1 GB (2 GB)

Specifications

Network environment



Network and wireless models only (see "Features by models" on page 7).

You need to set up the network protocols on the machine to use it as your network machine. The following table shows the network environments supported by the machine.

Items	Specifications
Network interface	<ul style="list-style-type: none">• Ethernet 10/100 Base-TX Wired Lan• 802.11b/g/n Wireless LAN
Network operating system	<ul style="list-style-type: none">• Windows 2000/Server 2003 /Server 2008/XP/Vista/7/Server 2008 R2• Various Linux OS• Mac OS X 10.4 ~10.7
Network protocols	<ul style="list-style-type: none">• TCP/IPv4• DHCP, BOOTP• DNS, WINS, Bonjour, SLP, UPnP• Standard TCP/IP Printing (RAW), LPR, IPP, WSD• SNMPv 1/2/3, HTTP, IPSec• TCP/IPv6 (DHCP, DNS, RAW, LPR, SNMPv 1/2/3, HTTP, IPSec)
Wireless security	<ul style="list-style-type: none">• Authentication: Open System, Shared Key, WPA Personal, WPA2 Personal (PSK)• Encryption: WEP64, WEP128, TKIP, AES

Regulatory information

This machine is designed for a normal work environment and certified with several regulatory statements.

Laser safety statement

The printer is certified in the U.S. to conform to the requirements of DHHS 21 CFR, chapter 1 Subchapter J for Class I(1) laser products, and elsewhere is certified as a Class I laser product conforming to the requirements of IEC 60825-1 :2007.

Class I laser products are not considered to be hazardous. The laser system and printer are designed so there is never any human access to laser radiation above a Class I level during normal operation, user maintenance or prescribed service condition.

Warning

Never operate or service the printer with the protective cover removed from laser/scanner assembly. The reflected beam, although invisible, can damage your eyes.

When using this product, these basic safety precautions should always be followed to reduce risk of fire, electric shock, and injury to persons:



CAUTION - CLASS 3B LASER RADIATION WHEN OPEN
AVOID EXPOSURE TO THE BEAM.

DANGER - LASER RADIATION AVOID DIRECT
EXPOSURE TO BEAM.

DANGER - RADIATIONS INVISIBLES DU LASER EN CAS
D'OUVERTURE. EVITER TOUTE EXPOSITION
DIRECTE AU FAISCEAU.

VORSICHT - UNSICHTBARE LASERSTRAHLUNG, WENN
ABDECKUNG GEÖFFNET.
NICHT DEM STRAHL AUSSETZEN.

ATTENZIONE - RADIAZIONE LASER INVISIBILE IN CASO DI
APERTURA. EVITARE L'ESPOSIZIONE AL FASCIO.

PRECAUCIÓN - RADIACIÓN LASER INVISIBLE CUANDO SE ABRE.
EVITAR EXPONERSE AL RAYO.

PERIGO - RÁDIAÇÃO LASER INVISÍVEL AO ABRIR. EVITE
EXPOSIÇÃO DIRECTA AO FEIXE.

GEVAAR - ONZICHTBARE LASERSTRALEN BIJ GEOPENDE
KLEP. DEZE KLEP NIET OPENEN.

ADVARSEL - USYNLIG LASERSTRÅLNING VED ÅBNING.
UNDGÅ UDSAETTEELSE FOR STRÅLNING.

ADVARSEL - USYNLIG LASERSTRÅLNING NÅR DEKSEL
ÅPNES. UNNGÅ EKSPONERING FOR STRÅLEN.

VARNING - OSYNLIG LASERSTRÅLNING NÅR DENNA DEL
ÄR ÖPPEN. STRÅLEN ÄR FARLIG.

VAROITUS - NÄKYMÄTÖNTÄ LASERSÄTEILYÄ AVATTAESSA.
VARO SUORAA ALTISTUMISTA SÄTEELLE.

注 意 - 严禁揭开此盖, 以免激光泄露灼伤

주 의 - 이 덮개를 열면 레이저광에 노출될 수 있으므로
주의하십시오.

Regulatory information

Ozone safety



This product's ozone emission rate is under 0.1 ppm. Because ozone is heavier than air, keep the product in a place with good ventilation.

Mercury Safety



Contains Mercury, Dispose According to Local, State or Federal Laws.(U.S.A. only)

Power saver



This printer contains advanced energy conservation technology that reduces power consumption when it is not in active use.

When the printer does not receive data for an extended period of time, power consumption is automatically lowered.

ENERGY STAR and the ENERGY STAR mark are registered U.S. marks.

For more information on the ENERGY STAR program see <http://www.energystar.gov>

For ENERGY STAR certified models, the ENERGY STAR label will be on your machine. Check if your machine is ENERGY STAR certified.

Recycling

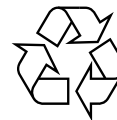

Recycle or dispose of the packaging material for this product in an environmentally responsible manner.

Regulatory information

China only

回收和再循环

为了保护环境，我们公司已经为废弃的产品建立了回收和再循环系统。我们会为您无偿提供回收同类废旧产品的服务。当您要废弃您正在使用的产品时，请您及时与授权耗材更换中心取得联系，我们会及时为您提供服务。

中国能效标识

型号	能效等级	典型能耗 (kW·h)
SCX-3401	1	0.85
SCX-3406	1	0.85
SCX-3406W	1	0.97
SCX-3406HW	1	1.06
SCX-3401FH	1	0.95

依据国家标准 GB 25956-2010



仅适用于海拔2000m以下地区安全使用。

《2000m 以下 9000 英尺以下 海拔 2000 米 以下 地区 安全 使用 的 警告 标志》

“此标志适用于海拔2000米以下地区安全使用。
دېگىز يۈزىدىن 2000 مېتىر تۆۋەن رايونلاردا بىخەتەر ئىشلەتكىلى بولىدۇ

Dan hab yungh youq gij digih haijbaz 2000 m doxroengz haenx ancienz sawjyungh.

Correct disposal of this product (Waste electrical & electronic equipment)

(Applicable in countries with separate collection systems)



This marking on the product, accessories or literature indicates that the product and its electronic accessories (e.g. charger, headset, USB cable) should not be disposed of with other household waste at the end of their working life. To prevent possible harm to the environment or human health from uncontrolled waste disposal, please separate these items from other s of waste and recycle them responsibly to promote the sustainable reuse of material resources.

Household users should contact either the retailer where they purchased this product, or their local government office, for details of where and how they can take these items for environmentally safe recycling.

Business users should contact their supplier and check the terms and conditions of the purchase contract. This product and its electronic accessories should not be mixed with other commercial wastes for disposal.

Regulatory information

(The United States of America only)

Dispose unwanted electronics through an approved recycler. To find the nearest recycling location, go to our website: www.Dell.com/recyclingdirect Or call, (877) 278 - 0799

State of California Proposition 65 Warning (US Only)

The California Safe Drinking Water and Toxic Enforcement Act requires the Governor of California to publish a list of chemicals known to the State of California to cause cancer or reproductive toxicity and requires businesses to warn of potential exposure to such chemicals.

WARNING: This product contains chemicals known to the State of California to cause cancer, birth defects or other reproductive harm.
This appliance can cause low-level exposure to the chemicals, which can be minimized by operating the appliance in a well ventilated area.

Taiwan only

警告

本電池如果更換不正確會有爆炸的危險
請依製造商說明書處理用過之電池

Radio frequency emissions

FCC information to the user

This device complies with Part 15 of the FCC Rules. Operation is subject to the following two conditions:

- This device may not cause harmful interference, and
- This device must accept any interference received, including interference that may cause undesired operation.

This equipment has been tested and found to comply with the limits for a Class B digital device, pursuant to Part 15 of the FCC Rules. These limits are designed to provide reasonable protection against harmful interference in a residential installation. This equipment generates, uses and can radiate radio frequency energy and, if not installed and used in accordance with the instructions, may cause harmful interference to radio communications. However, there is no guarantee that interference will not occur in a particular installation. If this equipment does cause harmful interference to radio or television reception, which can be determined by turning the equipment off and on, the user is encouraged to try to correct the interference by one or more of the following measures:

- Reorient or relocate the receiving antenna.
- Increase the separation between the equipment and receiver.
- Connect the equipment into an outlet on a circuit different from that to which the receiver is connected.

Regulatory information

- Consult the dealer or experienced radio TV technician for help.



Change or modifications not expressly approved by the manufacturer responsible for compliance could void the user's authority to operate the equipment.

Canadian radio interference regulations

This digital apparatus does not exceed the Class B limits for radio noise emissions from digital apparatus as set out in the interference-causing equipment standard entitled "Digital Apparatus", ICES-003 of the Industry and Science Canada.

Cet appareil numérique respecte les limites de bruits radioélectriques applicables aux appareils numériques de Classe B prescrites dans la norme sur le matériel brouilleur: "Appareils Numériques", ICES-003 édictée par l'Industrie et Sciences Canada.

United States of America

Federal Communications Commission (FCC)

Intentional emitter per FCC Part 15

Low power, Radio LAN devices (radio frequency (RF) wireless communication devices), operating in the 2.4 GHz/5 GHz Band, may be present (embedded) in your printer system. This section is only applicable if these devices are present. Refer to the system label to verify the presence of wireless devices.

Wireless devices that may be in your system are only qualified for use in the United States of America if an FCC ID number is on the system label.

The FCC has set a general guideline of 20 cm (8 inches) separation between the device and the body, for use of a wireless device near the body (this does not include extremities). This device should be used more than 20 cm (8 inches) from the body when wireless devices are on. The power output of the wireless device (or devices), which may be embedded in your printer, is well below the RF exposure limits as set by the FCC.

This transmitter must not be collocated or operation in conjunction with any other antenna or transmitter.

Operation of this device is subject to the following two conditions: (1) This device may not cause harmful interference, and (2) this device must accept any interference received, including interference that may cause undesired operation of the device.

Regulatory information



Wireless devices are not user serviceable. Do not modify them in any way. Modification to a wireless device will void the authorization to use it. Contact manufacturer for service.

FCC Statement for Wireless LAN use:



While installing and operating this transmitter and antenna combination the radio frequency exposure limit of 1m W/cm² may be exceeded at distances close to the antenna installed. Therefore, the user must maintain a minimum distance of 20cm from the antenna at all times. This device cannot be colocated with another transmitter and transmitting antenna.

Russia only

AB57



Минсвязи России



Germany only

Das Gerät ist nicht für die Benutzung am Bildschirmarbeitsplatz gemäß BildscharbV vorgesehen.

Turkey only

- RoHS
EEE Yönetmeliğine Uygundur.
This EEE is compliant with RoHS.
- Bu ürünün ortalama yaşam süresi 7 yıl, garanti süresi 2 yıldır.

Regulatory information

Thailand only

This telecommunication equipment conforms to NTC technical requirement.

Canada only

This product meets the applicable Industry Canada technical specifications. / Le present materiel est conforme aux specifications techniques applicables d'Industrie Canada.

The Ringer Equivalence Number (REN) is an indication of the maximum number of devices allowed to be connected to a telephone interface. The termination of an interface may consist of any combination of devices subject only to the requirement that the sum of the RENs of all the devices not exceed five. / L'indice d'equivalence de la sonnerie (IES) sert a indiquer le nombre maximal de terminaux qui peuvent etre raccordes a une interface telephonique. La terminaison d'une interface peut consister en une combinaison quelconque de dispositifs, a la seule condition que la somme d'indices d'equivalence de la sonnerie de tous les dispositifs n'excede pas cinq.

Fax Branding

The Telephone Consumer Protection Act of 1991 makes it unlawful for any person to use a computer or other electronic device to send any message via a telephone facsimile machine unless such message clearly contains in a margin at the top or bottom of each transmitted page or on the first page of the transmission the following information:

- 1 the date and time of transmission
- 2 identification of either business, business entity or individual sending the message; and
- 3 telephone number of either the sending machine, business, business entity or individual.

The Telephone Company may make changes in its communications facilities, equipment operations or procedures where such action is reasonably required in the operation of its business and is not inconsistent with the rules and regulations in FCC Part 68. If such changes can be reasonably expected to render any customer terminal equipment incompatible with telephone company communications facilities, or require modification or alteration of such terminal equipment, or otherwise materially affect its use or performance, the customer shall be given adequate notice in writing, to allow the customer an opportunity to maintain uninterrupted service

Regulatory information

Ringer Equivalence Number

The Ringer Equivalence Number and FCC Registration Number for this machine may be found on the label located on the bottom or rear of the machine. In some instances you may need to provide these numbers to the telephone company.

The Ringer Equivalence Number (REN) is a measure of the electrical load placed on the telephone line, and is useful for determining whether you have “overloaded” the line. Installing several s of equipment on the same telephone line may result in problems making and receiving telephone calls, especially ringing when your line is called. The sum of all Ringer Equivalence Numbers of the equipment on your telephone line should be less than five in order to assure proper service from the telephone company. In some cases, a sum of five may not be usable on your line. If any of your telephone equipment is not operating properly, you should immediately remove it from your telephone line, as it may cause harm to the telephone network.

The equipment complies with Part 68 of the FCC rules and the requirements adopted by the ACTA. On the rear of this equipment is a label that contains, among other information, a product identifier in the format US:AAAEQ##TXXXX. If requested, this number must be provided to the telephone company.



FCC Regulations state that changes or modifications to this equipment not expressly approved by the manufacturer could void the user’s authority to operate this equipment. In the event that terminal equipment causes harm to the telephone network, the telephone company should notify the customer that service may be stopped. However, where prior notice is impractical, the company may temporarily cease service, providing that they:

- a promptly notify the customer.
- b give the customer an opportunity to correct the equipment problem.
- c inform the customer of the right to bring a complaint to the Federal Communication Commission pursuant to procedures set out in FCC Rules and Regulations Subpart E of Part 68.

You should also know that:

- Your machine is not designed to be connected to a digital PBX system.
- If you intend to use a computer modem or fax modem on the same phone line as your machine, you may experience transmission and reception problems with all the equipment. It is recommended that no other equipment, except for a regular telephone, share the line with your machine.
- If your area experiences a high incidence of lightning or power surges, we recommend that you install surge protectors for both the power and the telephone lines. Surge protectors can be purchased from your dealer or telephone and electronic specialty stores.

Regulatory information

- When programming emergency numbers and/or making test calls to emergency numbers, use a non-emergency number to advise the emergency service dispatcher of your intentions. The dispatcher will give you further instructions on how to actually test the emergency number.
- This machine may not be used on coin service or party lines.
- This machine provides magnetic coupling to hearing aids.

You may safely connect this equipment to the telephone network by means of a standard modular jack, USOC RJ-11C.

Replacing the Fitted Plug (for UK Only)

Important

The mains lead for this machine is fitted with a standard (BS 1363) 13 amp plug and has a 13 amp fuse. When you change or examine the fuse, you must re-fit the correct 13 amp fuse. You then need to replace the fuse cover. If you have lost the fuse cover, do not use the plug until you have another fuse cover.

Contact the people from you purchased the machine.

The 13 amp plug is the most widely used in the UK and should be suitable. However, some buildings (mainly old ones) do not have normal 13 amp plug sockets. You need to buy a suitable plug adaptor. Do not remove the moulded plug.



If you cut off the moulded plug, get rid of it straight away. You cannot rewire the plug and you may receive an electric shock if you plug it into a socket.

Important warning:



You must earth this machine.

The wires in the mains lead have the following color code:

- **Green and Yellow:** Earth
- **Blue:** Neutral
- **Brown:** Live

If the wires in the mains lead do not match the colors marked in your plug, do the following:

You must connect the green and yellow wire to the pin marked by the letter “E” or by the safety ‘Earth symbol’ or colored green and yellow or green.

You must connect the blue wire to the pin which is marked with the letter “N” or colored black.

You must connect the brown wire to the pin which is marked with the letter “L” or colored red.

You must have a 13 amp fuse in the plug, adaptor, or at the distribution board.

Regulatory information

Declaration of conformity (European countries)

Approvals and Certifications

Hereby, Dell Inc. declares that this [B1165nfw Series] is in compliance with the essential requirements and other relevant provisions of Low Voltage Directive (2006/95/EC), EMC Directive (2004/108/EC).



Hereby, Dell Inc. declares that this [B1165nfw Series] is in compliance with the essential requirements and other relevant provisions of R&TTE Directive 1999/5/EC.

The declaration of conformity may be consulted at www.Dell.com, go to Support > Download center and enter your printer (MFP) name to browse the EuDoC.

January 1, 1995: Council Directive 2006/95/EC Approximation of the laws of the member states related to low voltage equipment.

January 1, 1996: Council Directive 2004/108/EC, approximation of the laws of the Member States related to electromagnetic compatibility.

March 9, 1999: Council Directive 1999/5/EC on radio equipment and telecommunications terminal equipment and the mutual recognition of their conformity. A full declaration, defining the relevant Directives and referenced standards can be obtained from your Dell Inc. representative.

EC Certification

Certification to 1999/5/EC Radio Equipment & Telecommunications Terminal Equipment Directive (FAX)

This Dell product has been self-certified by Dell for pan-European single terminal connection to the analogue public switched telephone network (PSTN) in accordance with Directive 1999/5/EC. The product has been designed to work with the national PSTNs and compatible PBXs of the European countries:

In the event of problems, you should contact the Euro QA Lab of Dell Inc. in the first instance.

The product has been tested against TBR21. To assist in the use and application of terminal equipment which complies with this standard, the European Telecommunication Standards Institute (ETSI) has issued an advisory document (EG 201 121) which contains notes and additional requirements to ensure network compatibility of TBR21 terminals. The product has been designed against, and is fully compliant with, all of the relevant advisory notes contained in this document.

European radio approval information (for products fitted with EU-approved radio devices)

Low power, Radio LAN type devices (radio frequency (RF) wireless communication devices), operating in the 2.4 GHz/5 GHz band, may be present (embedded) in your printer system which is intended for home or office use. This section is only applicable if these devices are present. Refer to the system label to verify the presence of wireless devices.

Regulatory information



Wireless devices that may be in your system are only qualified for use in the European Union or associated areas if a CE mark with a Notified Body Registration Number and the Alert Symbol is on the system label.

The power output of the wireless device or devices that may be embedded in your printer is well below the RF exposure limits as set by the European Commission through the R&TTE directive.

European states qualified under wireless approvals:

EU countries

European states with restrictions on use:

EU

In France, the frequency range is restricted to 2454-2483.5 MHz for devices above 10 mW transmitting power such as wireless

EEA/EFTA countries

No limitations at this time

Israel only

מס' אישור אלחוטי של משרד התקשורת הוא 51-28466, אסור להחליף את האנטנה המקורית של המכשיר, ולא לעשות בו כל שינוי טכני אחר.

Regulatory compliance statements

Wireless guidance

Low power, Radio LAN devices (radio frequency (RF) wireless communication devices), operating in the 2.4 GHz/5 GHz Band, may be present (embedded) in your printer system. The following section is a general overview of considerations while operating a wireless device.

Additional limitations, cautions, and concerns for specific countries are listed in the specific country sections (or country group sections). The wireless devices in your system are only qualified for use in the countries identified by the Radio Approval Marks on the system rating label. If the country you will be using the wireless device in, is not listed, contact your local Radio Approval agency for requirements. Wireless devices are closely regulated and use may not be allowed.

Regulatory information

The power output of the wireless device or devices that may be embedded in your printer is well below the RF exposure limits as known at this time. Because the wireless devices (which may be embedded into your printer) emit less energy than is allowed in radio frequency safety standards and recommendations, manufacturer believes these devices are safe for use. Regardless of the power levels, care should be taken to minimize human contact during normal operation.

As a general guideline, a separation of 20 cm (8 inches) between the wireless device and the body, for use of a wireless device near the body (this does not include extremities) is typical. This device should be used more than 20 cm (8 inches) from the body when wireless devices are on and transmitting.

This transmitter must not be collocated or operation in conjunction with any other antenna or transmitter.

Some circumstances require restrictions on wireless devices. Examples of common restrictions are listed below:



Radio frequency wireless communication can interfere with equipment on commercial aircraft. Current aviation regulations require wireless devices to be turned off while traveling in an airplane. IEEE 802.11 (also known as wireless Ethernet) and Bluetooth communication devices are examples of devices that provide wireless communication.



In environments where the risk of interference to other devices or services is harmful or perceived as harmful, the option to use a wireless device may be restricted or eliminated. Airports, Hospitals, and Oxygen or flammable gas laden atmospheres are limited examples where use of wireless devices may be restricted or eliminated. When in environments where you are uncertain of the sanction to use wireless devices, ask the applicable authority for authorization prior to use or turning on the wireless device.



Every country has different restrictions on the use of wireless devices. Since your system is equipped with a wireless device, when traveling between countries with your system, check with the local Radio Approval authorities prior to any move or trip for any restrictions on the use of a wireless device in the destination country.



If your system came equipped with an internal embedded wireless device, do not operate the wireless device unless all covers and shields are in place and the system is fully assembled.



Wireless devices are not user serviceable. Do not modify them in any way. Modification to a wireless device will void the authorization to use it. Contact manufacturer for service.



Only use drivers approved for the country in which the device will be used. See the manufacturer System Restoration Kit, or contact manufacturer Technical Support for additional information.

Regulatory information

China only

产品中有害有毒物质或元素的名称及含量

部件名称	有害有毒物质或元素					
	铅 (Pb)	汞 (Hg)	镉 (Cd)	六价铬 (Cr ⁶⁺)	多溴联苯 (PBB)	多溴联苯醚 (PBDE)
塑料	○	○	○	○	○	○
金属 (机箱)	×	○	○	○	○	○
印刷电路部件 (PCA)	×	○	○	○	○	○
电缆 / 连接器	×	○	○	○	○	○
电源设备	×	○	○	○	○	○
电源线	×	○	○	○	○	○
机械部件	×	○	○	○	○	○
卡盒部件	×	○	○	○	○	○
定影部件	×	○	○	○	○	○
扫描仪部件 - CCD (如果有)	×	×	○	○	○	○
扫描仪部件 - 其它 (如果有)	×	○	○	○	○	○
印刷电路板部件 (PBA)	×	○	○	○	○	○
墨粉	○	○	○	○	○	○
滚筒	○	○	○	○	○	○

○：表示该有害有毒物质在该部件所有均质材料中的含量均在 SJ/T 11363-2006 标准规定的限量要求以下。

×：表示该有害有毒物质至少在该部件的某一均质材料中的含量超出 SJ/T 11363-2006 标准规定的限量要求。

以上表为目前本产品含有有害有毒物质的信息。本信息由本公司的配套厂家提供，经本公司审核后而做成，本产品的部分部件含有有害有毒物质，这些部件是在现有科学技术水平下暂时无可替代物质，但三星电子将会一直为满足 SJ/T 11363-2006 标准而做不懈的努力。

Copyright

Information in this document is subject to change without notice.

©2013 Dell Inc. All rights reserved.

Reproduction of these materials in any manner whatsoever without the written permission of Dell Inc. is strictly forbidden.

Trademarks used in this text: *Dell*, the *Dell* logo, and *Dell Toner Management System* are trademarks of Dell Inc.; *Microsoft*, *Windows*, *Windows Vista*, and *Windows Server* are registered trademarks of Microsoft Corporation in the United States and/or other countries; *Adobe* and *Acrobat Reader* are either registered trademarks or trademarks of Adobe Systems Incorporated in the United States and/or other countries.

iPad, iPhone, iPod touch, TrueType, Mac and Mac OS are trademarks of Apple Inc., registered in the U.S and other countries. AirPrint and the AirPrint logo are trademarks of Apple Inc.

Other trademarks and trade names may be used in this document to refer to the entities claiming the marks and names of their products.

Dell Inc. disclaims any proprietary interest in trademarks and trade names other than its own.

Google Cloud Print is a trademark of Google Inc.

Google, Picasa, Google Docs, Android and Gmail are either registered trademarks or trademarks of Google Inc.

Refer to the '**LICENSE.txt**' file in the provided CD/DVD for the open source license information.

REV. 1.00



User's Guide

Dell B1165nfw

ADVANCED

This guide provides information about installation, advanced configuration, operation and troubleshooting on various OS environments.

Some features may not be available depending on models or countries.

BASIC

This guide provides information concerning installation, basic operation and troubleshooting on windows.



1. Software Installation

Installation for Mac	131
Reinstallation for Mac	132
Installation for Linux	133
Reinstallation for Linux	135



2. Using a Network-Connected Machine

Useful network programs	137
Wired network setup	138
Installing driver over the network	141
IPv6 configuration	147
Wireless network setup	149



3. Useful Setting Menus

Before you begin reading a chapter	178
Print menu	179
Copy menu	180
Fax menu	187

Scan menu	191
System setup	193



4. Special Features

Altitude adjustment	206
Entering various characters	207
Setting up the fax address book	208
Printing features	212
Scan features	225
Fax features	233
Using memory/hard drive features	244



5. Useful Management Tools

Accessing management tools	246
Using Firmware update utility	247
Using Dell Supplies Ordering Utility	248
Using Embedded Web Service	249
Using Dell Printer Manager	251
Using Dell Printer Status	254
Using Dell Printer Experience	256
Using the Linux Unified Driver Configurator	261



6. Troubleshooting

Paper feeding problems	265
Power and cable connecting problems	266
Printing problems	267
Printing quality problems	271
Copying problems	279
Scanning problems	280
Faxing problems	281
Operating system problems	283



1. Software Installation

This chapter provides instructions for installing essential and helpful software for use in an environment where the machine is connected via a cable. A locally connected machine is a machine directly attached to your computer using the cable. If your machine is attached to a network, skip the following steps below and go on to installing a network connected machine's driver (see "Installing driver over the network" on page 141).

- **Installation for Mac** **131**
- **Reinstallation for Mac** **132**
- **Installation for Linux** **133**
- **Reinstallation for Linux** **135**



- If you are a Windows OS user, refer to the Basic Guide for installing the machine's driver (see "Installing the driver locally" on page 24).
- Only use a USB cable no longer than 3 meter (118 inches).

Installation for Mac

1 Make sure that the machine is connected to your computer and powered on.

2 Insert the supplied software CD into your CD/DVD drive.

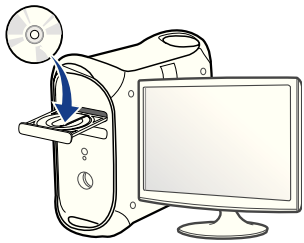

3 Double-click the CD/DVD icon that appears on your Mac desktop.

- For Mac OS X 10.8, double-click the CD/DVD that appears on **Finder**.

4 Double-click the **MAC_Installer** folder > **Installer OS X** icon.

5 Click **Continue**.

6 Read the license agreement and click **Continue**.

7 Click **Agree** to agree to the license agreement.

8 Click **Install**. All components necessary for machine operations will be installed.

If you click **Customize**, you can choose individual components to install.

9 Enter the password and click **OK**.

10 Select **Direct Connection using USB cable** on the **Printer Connection Type** and click **Continue**.

11 Click **Add Printer** button to select your printer and add it to your printer list.

- For MFP models, Click Add Fax button to select your fax and add it to your fax list.

12 After the installation is finished, click **Close** or **Restart**.



To install the fax driver:

- a Open the **Applications** folder > **Dell** > **Fax Queue Creator**.
- b Your machine appears on the **Printer List**
- c Select machine to use and click **Create** button

Reinstallation for Mac

If the printer driver does not work properly, uninstall the driver and reinstall it.

- 1 Open the **Applications** folder > **Dell** > **Printer Software Uninstaller**.
- 2 To uninstall printer software, click **Continue**.
- 3 Check the program you want to delete and click **Uninstall**.
- 4 Enter the password and click **OK**.
- 5 After the uninstallation is finished, click **Close**.



If a machine has already been added, delete it from the **Print Setup Utility** or **Print & Fax**.

Installation for Linux

You need to download Linux software packages from the Dell website to install the printer software (<http://www.Dell.com> > find your product > Support or Downloads).

Installing the Unified Linux Driver

- 1 Make sure that the machine is connected to your computer and powered on.
- 2 When the **Administrator Login** window appears, type "root" in the **Login** field and enter the system password.



You must log in as a super user (root) to install the machine software. If you are not a super user, ask your system administrator.

- 3 From the Dell website, download the Unified Linux Driver package to your computer.
- 4 Right-click the **Unified Linux Driver** package and extract the package.
- 5 Double click **cdroot > autorun**.
- 6 When the welcome screen appears, click **Next**.
- 7 When the installation is complete, click **Finish**.

The installation program added the Unified Driver Configurator desktop icon and the Unified Driver group to the system menu for your convenience. If you have any difficulties, consult the on-screen help that is available through your system menu or from the driver package Windows applications, such as **Unified Driver Configurator** or **Image Manager**.

Installing the Smart Panel

- 1 Make sure that the machine is connected to your computer and powered on.
- 2 When the **Administrator Login** window appears, type in root in the **Login** field and enter the system password.



You must log in as a super user (root) to install the machine software. If you are not a super user, ask your system administrator.

- 3 From the Dell website, download the **Smart Panel** package to your computer.
- 4 Right-click the Smart Panel package and extract the package.
- 5 Double click **cdroot > Linux > smartpanel > install.sh**.

Installation for Linux

Installing the Printer Settings Utility

- 1 Make sure that the machine is connected to your computer and powered on.
- 2 When the **Administrator Login** window appears, type "root" in the **Login** field and enter the system password.



You must log in as a super user (root) to install the machine software. If you are not a super user, ask your system administrator.

- 3 From the Dell website, download the Printer Settings Utility package to your computer.
- 4 Right-click the **Printer Settings Utility** package and extract the package.
- 5 Double click **cdroot > Linux > psu > install.sh**.

Reinstallation for Linux

If the printer driver does not work properly, uninstall the driver and reinstall it.

- 1** Make sure that the machine is connected to your computer and powered on.
- 2** When the **Administrator Login** window appears, type "root" in the **Login** field and enter the system password.

You must log in as a super user (root) to uninstall the printer driver. If you are not a super user, ask your system administrator.
- 3** Open **Terminal** program. When the Terminal screen appears, type in the following.

```
[root@localhost root]#cd /opt/Dell/mfp/uninstall/[root@localhost  
uninstall]#./uninstall.sh
```
- 4** Click **Next**.
- 5** Click **Finish**.



2. Using a Network-Connected Machine

This chapter gives you step-by-step instructions for setting up a network connected machine and software.

- **Useful network programs** 137
- **Wired network setup** 138
- **Installing driver over the network** 141
- **IPv6 configuration** 147
- **Wireless network setup** 149



Supported optional devices and features may differ according to your model (see "Features by models" on page 7).

Useful network programs

There are several programs available to setup the network settings easily in a network environment. For the network administrator especially, managing several machines on the network is possible.



- Before using the programs below, set the IP address first.
- Some features and optional goods may not be available depending on model or country (see "Features by models" on page 7).

SetIP wired network setup

This utility program allows you to select a network interface and manually configure the IP addresses for use with the TCP/IP protocol.

- See "IPv4 configuration using SetIP (Windows)" on page 138.
- See "IPv4 configuration using SetIP (Mac)" on page 139.
- See "IPv4 configuration using SetIP (Linux)" on page 140.





- The machine that does not support the network port, it will not be able to use this feature (see "Rear view" on page 20).
- TCP/IPv6 is not supported by this program.

Wired network setup

Printing a network configuration report

You can print **Network Configuration Report** from the machine's control panel that will show the current machine's network settings. This will help you to set up a network.

- **The machine has the display screen:** Press the  (**Menu**) button on the control panel and select **Network > Network Conf. (Network Configuration)**.
- **The machine does not have the display screen:** Press the  (**Cancel** or **Stop/Clear**) button for more than 4~5 seconds on the control panel.

Using this **Network Configuration Report**, you can find your machine's MAC address and IP address.

For example:

- MAC Address: 00:15:99:41:A2:78
- IP Address: 169.254.192.192

Setting IP address



- The machine that does not support the network interface, it will not be able to use this feature (see "Rear view" on page 20).
- TCP/IPv6 is not supported by this program.

First, you have to set up an IP address for network printing and managements. In most cases a new IP address will be automatically assigned by a DHCP (Dynamic Host Configuration Protocol) server located on the network.

IPv4 configuration using SetIP (Windows)

Before using the SetIP program, disable the computer firewall from **Control Panel > Security Center > Windows Firewall**.

- 1 Install this program from the supplied CD/DVD by double-click **Application > SetIP > Setup.exe**.
- 2 Follow the instructions in the installation window.
- 3 Connect your machine to the network with a network cable.
- 4 Turn on the machine.
- 5 From the Windows **Start** menu, select **All Programs > Dell Printers > SetIP > SetIP**.

Wired network setup

6 Click the  icon (third from left) in the SetIP window to open the TCP/IP configuration window.

7 Enter the machine's new information into the configuration window as follows. In a corporate intranet, you may need to have this information assigned by a network manager before proceeding.

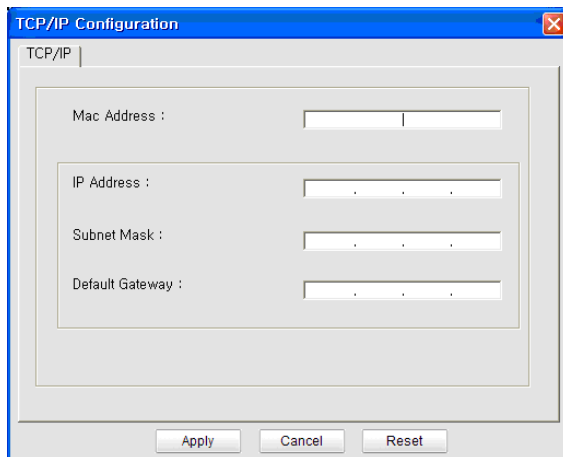

 Find the machine's MAC address from the **Network Configuration Report** (see "Printing a network configuration report" on page 138) and enter it without the colons. For example, 00:15:99:29:51:A8 becomes 0015992951A8.

8 Click **Apply**, and then click **OK**. The machine will automatically print the **Network Configuration Report**. Confirm that all the settings are correct.

IPv4 configuration using SetIP (Mac)

Before using the SetIP program, disable the computer firewall from **System Preferences > Security > Firewall**.



The following instructions may vary from your model.

- 1 Connect your machine to the network with a network cable.
- 2 Insert the supplied software CD into your CD/DVD drive.
- 3 Double-click the CD/DVD icon that appears on your Mac desktop.
 - For Mac OS X 10.8, Double-click the CD/DVD icon that appears on your Finder.
- 4 Double-click the **MAC_Installer** folder > **Installer OS X** icon.
- 5 Click **Continue**.
- 6 Read the license agreement and click **Continue**.
- 7 Click **Agree** to agree to the license agreement.
- 8 Click **Install**. All components necessary for machine operations will be installed.
If you click **Customize**, you can choose individual components to install.

Wired network setup

- 9 Enter the password and click **OK**.
- 10 Select **Network Connection** on the **Printer Connection Type** and click **Set IP Address** button.
- 11 Click the  icon (third from the left) in the SetIP window to open the TCP/IP configuration window.
- 12 Enter the machine's new information into the configuration window. In a corporate intranet, you may need to have this information assigned by a network manager before proceeding.



Find the machine's MAC address from the **Network Configuration Report** (see "Printing a network configuration report" on page 138) and enter it without the colons. For example, 00:15:99:29:51:A8 becomes 0015992951A8.

- 13 Click **Apply**, and then click **OK**. The machine will automatically print the **Network Configuration Report**. Confirm that all the settings are correct.

IPv4 configuration using SetIP (Linux)

Before using the SetIP program, disable the computer firewall from **System Preferences** or **Administrator**.



The following instructions may vary from your model or operating systems.

- 1 Open `/opt/Dell/mfp/share/utils/`.
- 2 Double-click the **SetIPApplet.html** file.
- 3 Click to open the TCP/IP configuration window.
- 4 Enter the machine's new information into the configuration window. In a corporate intranet, you may need to have this information assigned by a network manager before proceeding.



Find the machine's MAC address from the **Network Configuration Report** (see "Printing a network configuration report" on page 138) and enter it without the colons. For example, 00:15:99:29:51:A8 becomes 0015992951A8.

- 5 The machine will automatically print the **Network Configuration Report**.

Installing driver over the network



- Some features and optional goods may not be available depending on model or country (see "Features by models" on page 7).
- The machine that does not support the network interface, it will not be able to use this feature (see "Rear view" on page 20).

Windows

- 1 Insert the supplied software CD into your CD/DVD drive.
The software CD should automatically run and an installation window will appear.
If the installation window does not appear, click **Start > All programs > Accessories > Run**.
X:\Setup.exe replacing "X" with the letter, which represents your CD/DVD drive and click **OK**.
 - For Windows 8,
If the installation window does not appear, from **Charms**, select **Search > Apps** and search for **Run**. Type in X:\Setup.exe, replacing "X" with the letter that represents your CD/DVD drive and click **OK**.
If "**Tap to choose what happens with this disc.**" pop-up window appears, click the window and select **Run Setup.exe**.

- 2 Click **New Printer**.

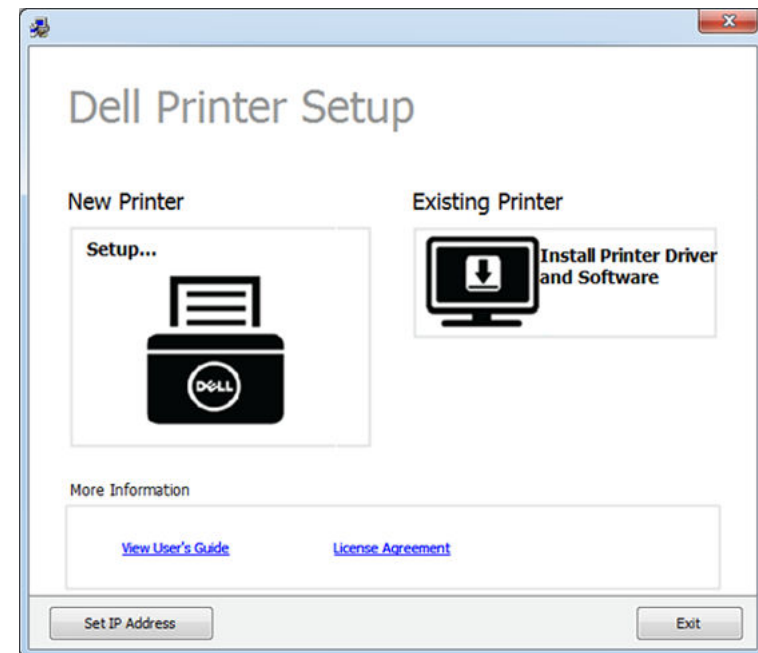

Installing driver over the network

3 Choose **Ethernet**.

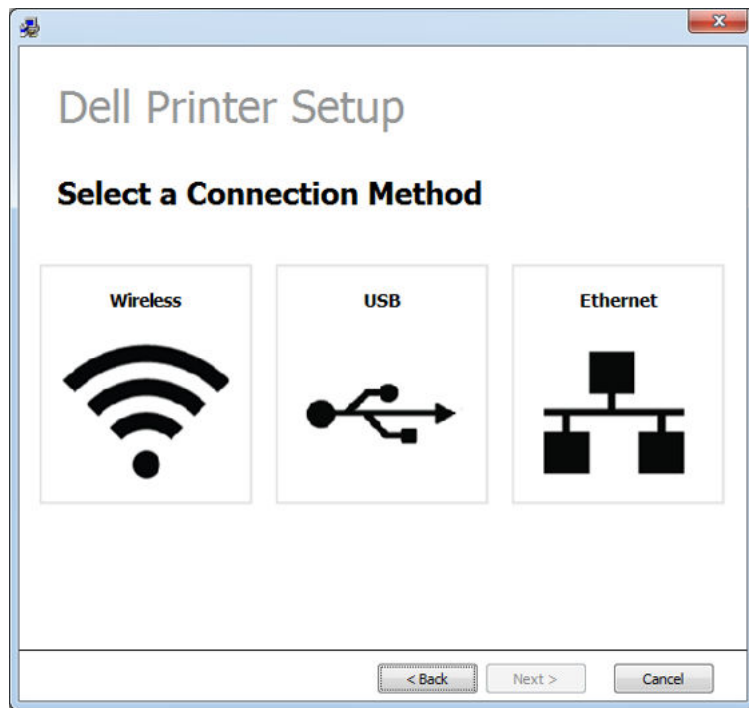

4 Make sure that the machine is connected to the network and powered on. Also, your machine's IP address should have been set.

Click **Next**.

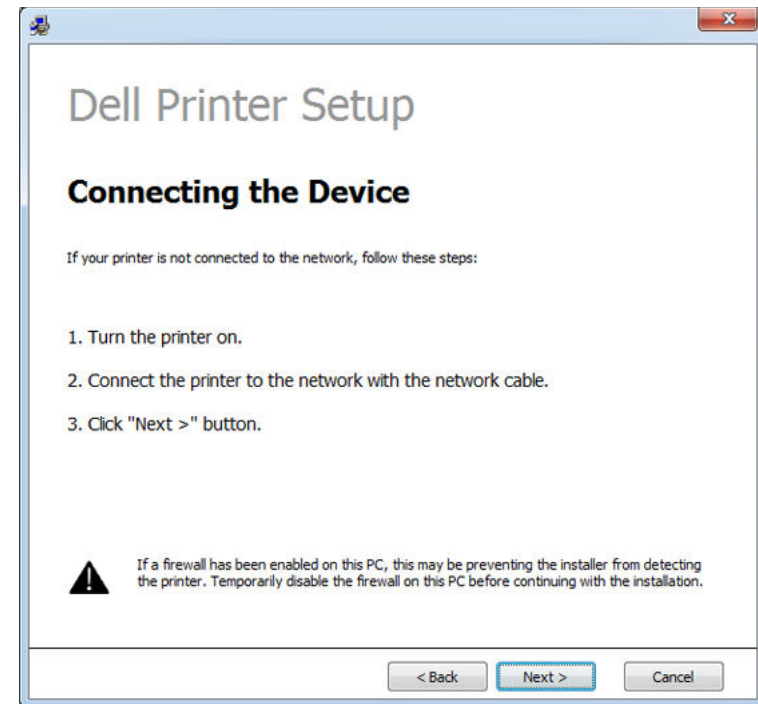

Installing driver over the network

- 5 The searched machines will be shown on the screen. Select the one you wish to use and click **Next**.



If you cannot find your machine in network, turn off the firewall and click **Update**. For Windows operating system, **Start > Control Panel** and start windows firewall, and set this option unactivated. For other operating system, refer to its on-line guide.

- 6 Follow the instructions in the installation window.

From the Windows 8 Start Screen



- **Dell Printer Experience** app can only be used in the **Start** screen when V4 driver is installed. The V4 driver is automatically downloaded from the Windows Update if your computer is connected to the Internet. If not, you can manually download the V4 driver from Dell website, www.Dell.com > find your product > Support or downloads.
- You can download **Dell Printer Experience** app from the **Windows Store**. You need have a Microsoft account to use the Windows **Store**.
 - a From **Charms**, select **Search**.
 - b Click **Store**.
 - c Search and click **Dell Printer Experience**.
 - d Click **Install**.

- If you install the driver using the supplied software CD, V4 driver is not installed. If you want to use the V4 driver in the **Desktop** screen, you can download from the Dell website, www.Dell.com > find your product > Support or downloads.
- If you want to install Dell's printer management tools, you need to install them using the supplied software CD.

- 1 Make sure that the machine is connected to the network and powered on. Also, your machine's IP address should have been set (see "Setting IP address" on page 138).
- 2 From **Charms**, select **Settings > Change PC settings > Devices**.
- 3 Click **Add a device**.

Discovered machines will be shown on the screen.
- 4 Click the model name or host name you wish to use.



You can print a Network Configuration Report from the machine's control panel that will show the current machine's host name.

- 5 The driver is automatically installed from the **Windows Update**.

Installing driver over the network

Mac

- 1 Make sure that the machine is connected to your network and powered on.
- 2 Insert the supplied software CD into your CD/DVD drive.

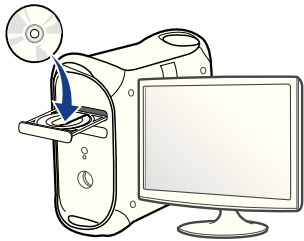

- 3 Double-click the CD/DVD icon that appears on your Mac desktop.
 - For Mac OS X 10.8, double-click the CD/DVD that appears on **Finder**.
- 4 Double-click the **MAC_Installer** folder > **Installer OS X** icon.
- 5 Click **Continue**.
- 6 Read the license agreement and click **Continue**.
- 7 Click **Agree** to agree to the license agreement.
- 8 Click **Install**. All components necessary for machine operations will be installed.

If you click **Customize**, you can choose individual components to install.

- 9 Enter the password and click **OK**.
- 10 Select **Network connection** on the **Printer Connection Type** and click **Continue**.
- 11 Click **Add Printer** button to select your printer and add it to your printer list.
- 12 Click **IP** and select **HP Jetdirect - Socket** in **Protocol**.
- 13 Enter the machine's IP address in the **Address** input field.
- 14 Enter the queue name in the **Queue** input field. If you cannot determine the queue name for your machine server, try using the default queue first.
- 15 If Auto Select does not work properly, choose **Select Printer Software** and your machine name in **Print Using**.
- 16 Click **Add**.
- 17 After the installation is finished, click **Close** or **Restart**.



Install the fax driver:

- a Open the **Applications** folder > **Dell** > **Fax Queue Creator**.
- b Your machine appears on the **Printer List**.
- c Select machine to use and Click **Create** button.

Installing driver over the network

Linux

You need to download Linux software packages from the Dell website to install the printer software (<http://www.Dell.com> > find your product > Support or Downloads).



To install other software:

- See "Installing the Smart Panel" on page 133.
- See "Installing the Printer Settings Utility" on page 134.

Install the Linux driver and add network printer

- 1 Make sure that the machine is connected to your network and powered on. Also, your machine's IP address should have been set.
- 2 Download the Unified Linux Driver package from the Dell website.
- 3 Extract the UnifiedLinuxDriver.tar.gz file and open the new directory.
- 4 Double-click the **Linux** folder > **install.sh** icon.
- 5 The Dell installer window opens. Click **Continue**.
- 6 The add printer wizard window opens. Click **Next**.
- 7 Select network printer and click **Search** button.
- 8 The machine's IP address and model name appears on list field.
- 9 Select your machine and click **Next**.
- 10 Input the printer description and **Next**.
- 11 After the machine is added, click **Finish**.
- 12 When installation is done, click **Finish**.

Installing driver over the network

Add a network printer

- 1 Double-click the **Unified Driver Configurator**.
- 2 Click **Add Printer**.
- 3 The **Add printer wizard** window opens. Click **Next**.
- 4 Select **Network printer** and click the **Search** button.
- 5 The printer's IP address and model name appears on list field.
- 6 Select your machine and click **Next**.
- 7 Enter the printer description and click **Next**.
- 8 After the machine is added, click **Finish**.

IPv6 configuration



IPv6 is supported properly only in Windows Vista or higher.



- Some features and optional goods may not be available depending on model or country (see "Features by models" on page 7 or "Menu overview" on page 29).
- If the IPv6 network seems to not be working, set all the network setting to the factory defaults and try again using **Clear Setting**.

In the IPv6 network environment, follow the next procedure to use the IPv6 address.

From the control panel

- 1 Connect your machine to the network with a network cable.
- 2 Turn on the machine.
- 3 Print a **Network Configuration Report** that will check IPv6 addresses (see "Printing a network configuration report" on page 138).
- 4 Select **Start > Control Panel > Printers and Faxes**.
- 5 Click **Add a printer** in the left pane of the **Printers and Faxes** windows.

6

Click **Add a local printer** in the **Add Printer** windows.

7

The **Add Printer Wizard** window appears. Follow the instructions in the window.



If the machine does not work in the network environment, activate IPv6. Refer to the next section followed by.

Activating IPv6

- 1 Press the  (**Menu**) button on the control panel.
- 2 Press **Network > TCP/IP (IPv6) > IPv6 Activate**.
- 3 Select **On** and press **OK**.
- 4 Turn the machine off and turn it on again.
- 5 Reinstall your printer driver.

IPv6 configuration

Setting IPv6 addresses

The machine supports the following IPv6 addresses for network printing and managements.

- **Link-local Address:** Self-configured local IPv6 address (Address starts with FE80).
- **Stateless Address:** Automatically configured IPv6 address by a network router.
- **Stateful Address:** IPv6 address configured by a DHCPv6 server.
- **Manual Address:** Manually configured IPv6 address by a user.

DHCPv6 address configuration (Stateful)

If you have a DHCPv6 server on your network, you can set one of the following options for default dynamic host configuration.

- 1 Press the  (**Menu**) button on the control panel.
- 2 Press **Network > TCP/IP (IPv6) > DHCPv6 Config**.
- 3 Press **OK** to select the required value you want.
 - **DHCPv6 Addr.:** Always use DHCPv6 regardless of router request.
 - **DHCPv6 Off:** Never use DHCPv6 regardless of router request.
 - **Router:** Use DHCPv6 only when requested by a router.

Wireless network setup



- Make sure your machine supports wireless networking. Wireless networking may not be available depending on the model (see "Features by models" on page 7).
- If the IPv6 network seems to not be working, set all the network settings to the factory defaults and try again using **Clear Setting**.

Getting started

Understanding your network type

Typically, you can only have one connection between your computer and the machine at a time.

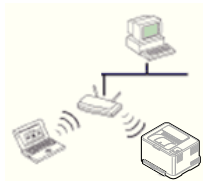

Infrastructure mode

This is an environment generally used for homes and SOHOs (Small Office/ Home Office). This mode uses an access point to communicate with the wireless machine.



Ad hoc mode

This mode does not use an access point. The wireless computer and wireless machine communicate directly.

Wireless network name and Network Password

Wireless networks require higher security, so when an access point is first set up, a network name (SSID), the type of security used, and a Network Password are created for the network. Ask your network administrator about this information before proceeding with the machine installation.

Wireless network setup

Introducing wireless set up methods

You can set wireless settings either from the machine or the computer. Choose the setting method from the below table.



Some wireless network installation types may not be available depending on the model or country.

Set up method	Connecting method	Description & Reference
With Access Point	From the computer	Windows User, see "Dell Printer Easy Wi-Fi Install" on page 156.
		Windows User, see "Access point via USB cable in Windows" on page 159.
		Mac User, see "Access point via USB cable" on page 167.
	See "Using a network cable" on page 170.	
From the machine's control panel	See "Using the WPS button" on page 151.	
	See "Using the menu button" on page 155.	
Without Access Point	From the computer	Windows User, see "Ad hoc via USB cable" on page 168.
		Mac User, see "Ad hoc via USB cable" on page 168.



- If problems occur during wireless set up or driver installation, refer to the troubleshooting chapter (see "Troubleshooting" on page 174).
- It is strongly recommended that you set the password on Access Points. If you do not set the password on Access Points, they might be exposed to illegal access from unknown machines including PCs, smart phones and printers. Refer to the Access Point user' guide for password settings.

Wireless network setup

Using the WPS button

If your machine and an access point (or wireless router) support Wi-Fi Protected Setup™ (WPS), you can easily configure the wireless network settings by pressing the  (WPS) button on the control panel without a computer.





- If you want to use the wireless network using the infrastructure mode, make sure that the network cable is disconnected from the machine. Using the **WPS (PBC)** button or entering the PIN from the computer to connect to the access point (or wireless router) varies depending on the access point (or wireless router) you are using. Refer to the user's guide of the access point (or wireless router) you are using.
- When using the WPS button to set the wireless network, security settings may change. To prevent this, lock the WPS option for the current wireless security settings. The option name may differ depending on the access point (or wireless router) you are using.

Items to prepare

- Check if the access point (or wireless router) supports Wi-Fi Protected Setup™ (WPS).
- Check if your machine supports Wi-Fi Protected Setup™ (WPS).
- Networked computer (PIN mode only)

Choosing your type

There are two methods available to connect your machine to a wireless network using the  (WPS) button on the control panel.

The **Push Button Configuration (PBC)** method allows you to connect your machine to a wireless network by pressing both the  (WPS) button on the control panel of your machine and the WPS (PBC) button on a Wi-Fi Protected Setup™ WPS-enabled access point (or wireless router) respectively.

The **Personal Identification Number (PIN)** method helps you connect your machine to a wireless network by entering the supplied PIN information on a Wi-Fi Protected Setup™ WPS-enabled access point (or wireless router).

Factory default in your machine is **PBC** mode, which is recommended for a typical wireless network environment.



You can change the WPS mode in control panel ( **(Menu)** > **Network** > **Wireless** > **OK** > **WPS Setting**).

Wireless network setup

Machines with a display screen

Connecting in PBC mode

- 1 Press and hold the  (WPS) button on the control panel for more than 2 seconds.

The machine starts waiting for up to two minutes until you press the WPS (PBC) button on the access point (or wireless router).
- 2 Press the **WPS (PBC)** button on the access point (or wireless router).

The messages are displayed on the display screen in the order below:

 - Connecting:** The machine is connecting to the access point (or wireless router).
 - Connected:** When the machine is successfully connected to the wireless network, the WPS LED light stays on.
 - AP SSID:** After completing the wireless network connection process, the AP's SSID information appears on the display.
- 3 Insert the supplied CD into the CD/DVD drive and proceed to install the software following the directions on the screen. When the "Connect Printer" screen appears, select the Network (Ethernet/Wireless) connection.

Connecting in PIN mode

- 1 Press and hold the  (WPS) button on the control panel for more than 2 seconds.
- 2 The eight-digit PIN appears on the display.

You need to enter the eight-digit PIN within two minutes on the computer that is connected to the access point (or wireless router).

The messages are displayed on the display screen in the order below:

 - Connecting:** The machine is connecting to the wireless network.
 - Connected:** When the machine is successfully connected to the wireless network, the WPS LED light stays on.
 - SSID Type:** After completing the wireless network connection process, the AP's SSID information is displayed on the LCD display.
- 3 Insert the supplied CD into the CD/DVD drive and proceed to install the software following the directions on the screen. When the "Connect Printer" screen appears, select Network (Ethernet/Wireless) connection.

Wireless network setup

Machines without a display screen

Connecting in PBC mode

- 1 Press and hold the  (WPS) button on the control panel for about 2 - 4 seconds until the status LED blinks quickly.

The machine starts connecting to the wireless network. The LED blinks slowly for up to two minutes until you press the PBC button on the access point (or wireless router).

- 2 Press the **WPS (PBC)** button on the access point (or wireless router).
 - a The light blinks fast on the WPS LED. The machine is connecting to the access point (or wireless router).
 - b When the machine is successfully connected to the wireless network, the WPS LED light stays on.

- 3 Insert the supplied CD into the CD/DVD drive and proceed to install the software following the directions on the screen. When the "Connect Printer" screen appears, select the Network (Ethernet/Wireless) connection.

Connecting in PIN mode

- 1 The network configuration report, including PIN, must be printed (see "Printing a network configuration report" on page 138).

In ready mode, press and hold the  (**Cancel or Stop/Clear**) button on the control panel for about 5 seconds. You can find your machine's PIN.

- 2 Press and hold the  (WPS) button on the control panel for more than 4 seconds until the status LED stays on.

The machine starts connecting to the access point (or wireless router).

- 3 You need to enter the eight-digit PIN within two minutes on the computer that is connected to the access point (or wireless router).

The LED blinks slowly for up to two minutes until you enter the eight-digit PIN.

The WPS LED blinks in the order below:

- a The light blinks fast on the WPS LED. The machine is connecting to the access point (or wireless router).
- b When the machine is successfully connected to the wireless network, the WPS LED light stays on.

- 4 Insert the supplied CD into the CD/DVD drive and proceed to install the software following the directions on the screen. When the "Connect Printer" screen appears, select the Network (Ethernet/Wireless) connection.

Wireless network setup

Re-connecting to a network

When the wireless function is off, the machine automatically tries to re-connect to the access point (or wireless router) with the previously used wireless connection settings and address.



In the following cases, the machine automatically re-connects to the wireless network:

- The machine is turned off and on again.
- The access point (or wireless router) is turned off and on again.

Canceling the connection process

To cancel the wireless network connection when the machine is connecting to the wireless network, press and release the  (**Cancel** or **Stop/Clear**) on the control panel. **You need to wait 2 minutes to re-connect to the wireless network.**

Disconnecting from a network

To disconnect the wireless network connection, press the  (WPS) button on the control panel for more than two seconds.

- **When the Wi-Fi network is in idle mode:** The machine is immediately disconnected from the wireless network and the WPS LED turns off.
- **When the Wi-Fi network is being used:** While the machine waits until the current job is finished, the light blinks fast on the WPS LED. Then, the wireless network connection is automatically disconnected and the WPS LED turns off.

Wireless network setup

Using the menu button



Some menus may not appear in the display depending on options or models. If so, it is not applicable to your machine (see "Menu overview" on page 29).

Before starting, you will need to know the network name (SSID) of your wireless network and the Network Password if it is encrypted. This information was set when the access point (or wireless router) was installed. If you do not know about your wireless environment, please ask the person who set up your network.



After completing the wireless network connection, you need to install a machine driver to print from an application (see "Installing driver over the network" on page 141).

- 1 Press the  (**Menu**) button on the control panel.
- 2 Press **Network > Wireless > WLAN Settings**.

- 3 Press the **OK** to select the setup method you want.

- **Wizard** (recommended): In this mode, the setup is automatic. The machine will display a list of available networks from which to choose. After a network is chosen then printer will prompt for the corresponding security key.
- **Custom**: In this mode, users can give or edit manually their own SSID , or choose the security option in detail.

Wireless network setup

Setup using Windows

Dell Printer Easy Wi-Fi Install

Before Using Dell Printer Easy Wi-Fi Install, please ensure that OS of your computer should be Windows 7 and above.

- Items to prepare

- Access point
- Wireless network-connected computer
- Software CD that was provided with your machine

1 Turn on your computer, access point and machine.

2 Connect your computer to the wireless network.

3 Insert the supplied software CD into your CD/DVD drive.

The software CD should automatically run and an installation window will appear.

If the installation window does not appear, click **Start > All programs > Accessories > Run**.

X:\Setup.exe replacing "X" with the letter, which represents your CD/DVD drive and click **OK**.

- For Windows 8,

If the installation window does not appear, from **Charms**, select **Search > Apps** and search for **Run**. Type in X:\Setup.exe, replacing "X" with the letter that represents your CD/DVD drive and click **OK**.

If "**Tap to choose what happens with this disc.**" pop-up window appears, click the window and select **Run Setup.exe**.

4 Click **New Printer**.

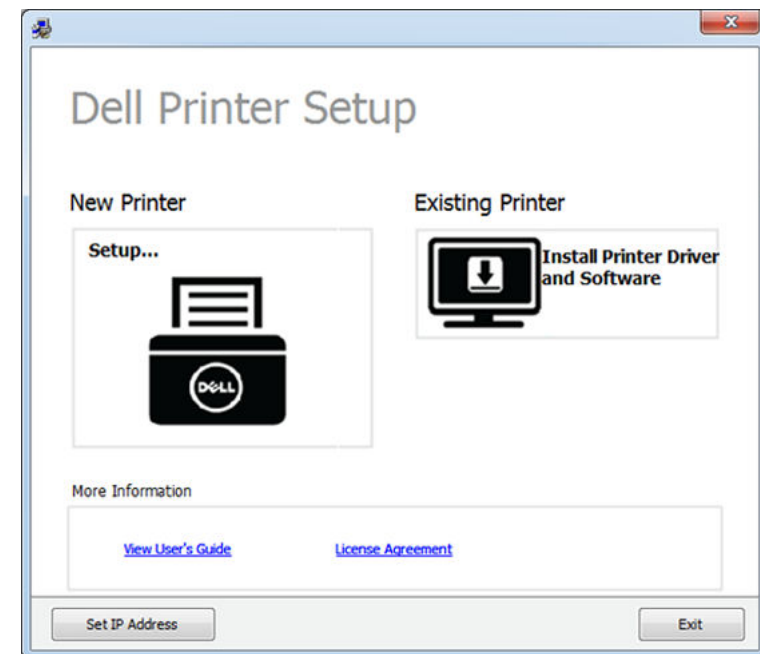

Wireless network setup

5 Choose **Wireless**.

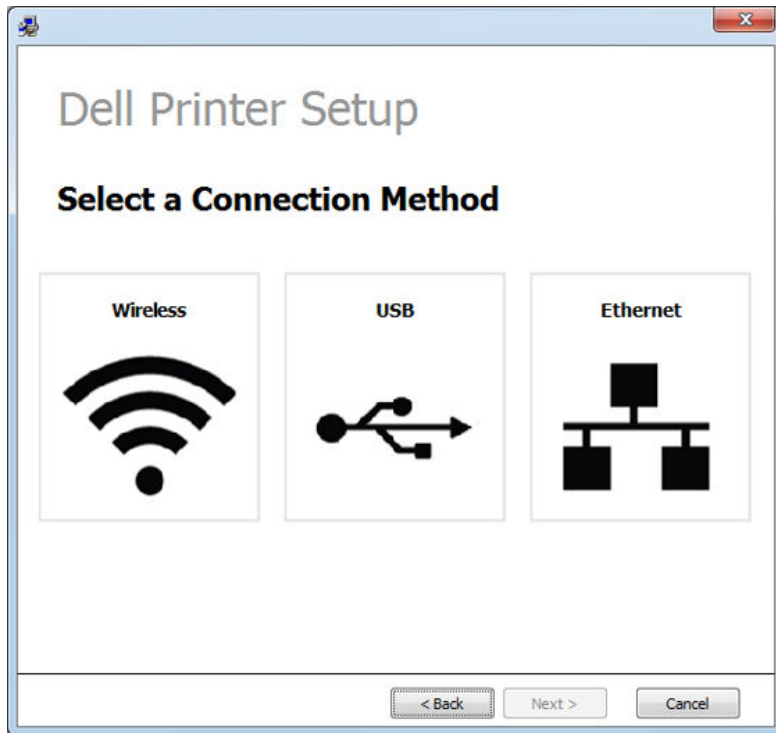

6 The software searches for printers.

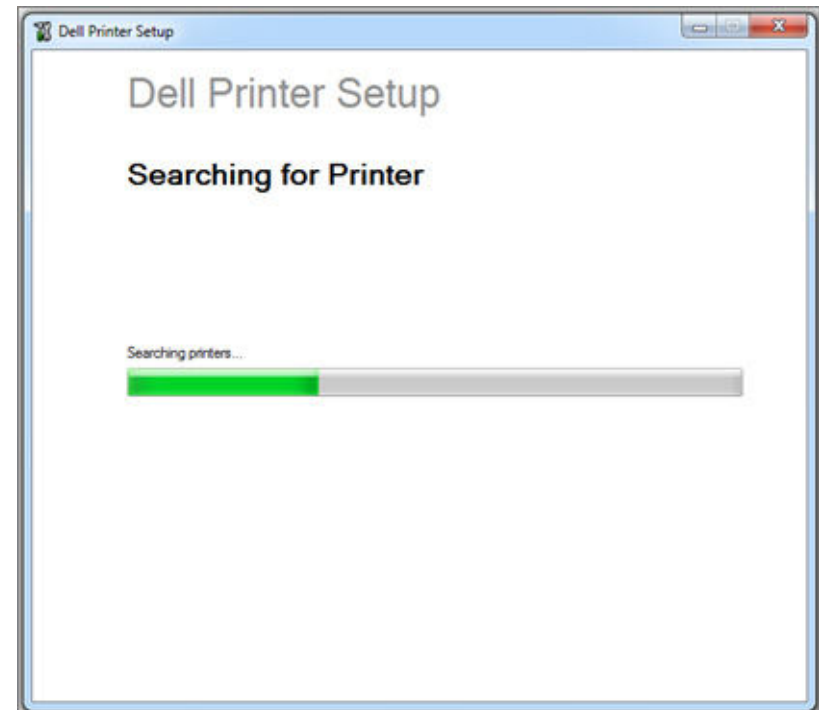

Wireless network setup

7 Set your printer name and click **Next**.

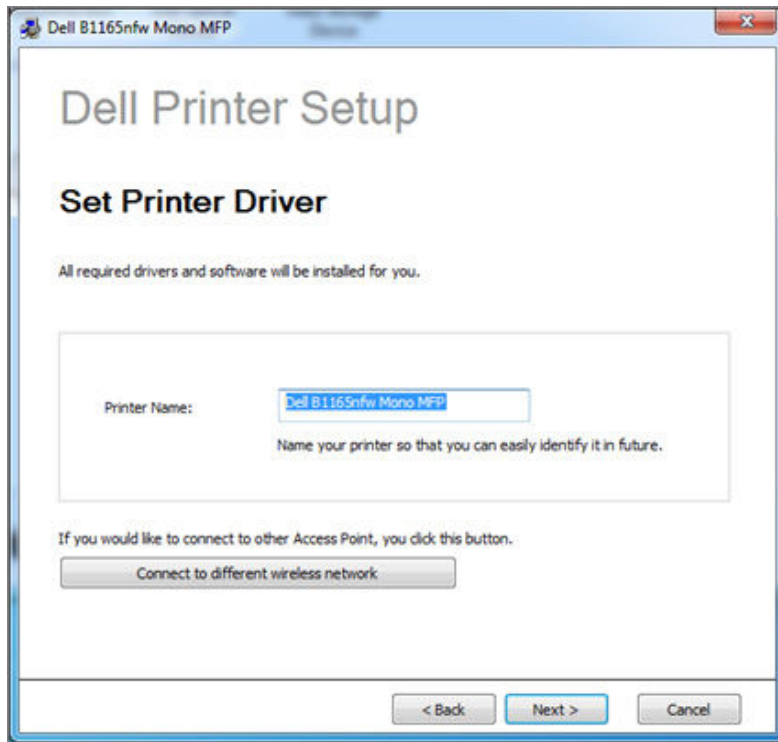

8 Setup installing printer software.

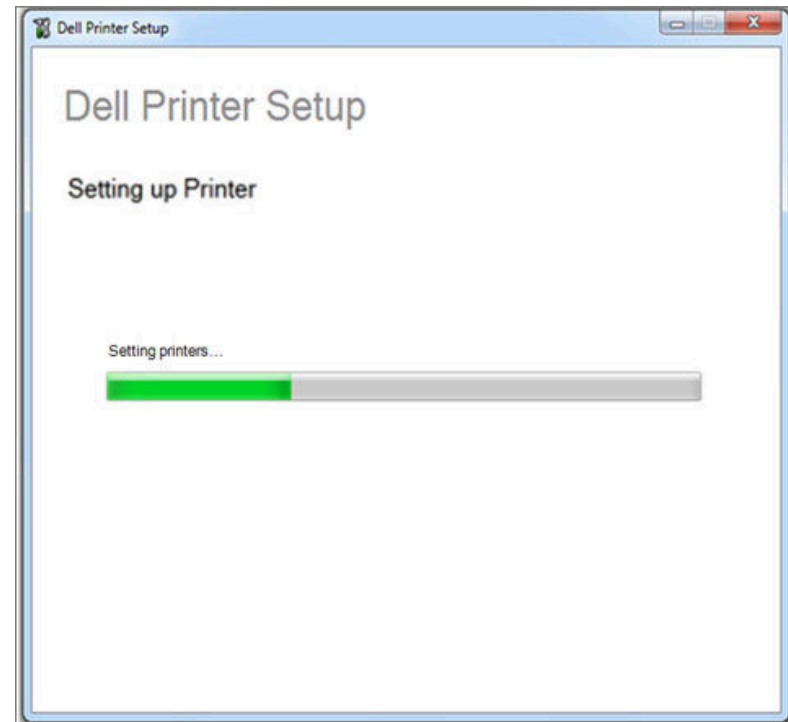

Wireless network setup

- 9 After the installation is finished, a window asking you to print a test page appears. If you want to print a test page, click **Print a test page**.

Otherwise, just click Next and go to step 10.

- 10 Click **Finish**.

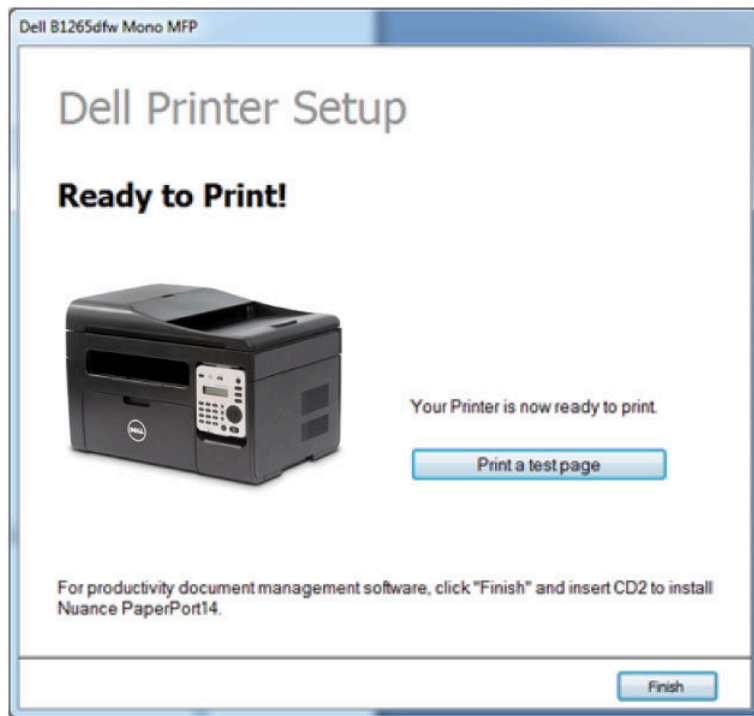

Access point via USB cable in Windows

- Items to prepare
 - Access point
 - Network-connected computer
 - Software CD that was provided with your machine
 - The machine installed with a wireless network interface
 - USB cable

- 1 Check whether the USB cable is connected to the machine.

- 2 Turn on your computer, access point, and machine.



If the "**Found New Hardware Wizard**" appears during the installation procedure, click **Cancel** to close the window.

- 3 Insert the supplied software CD into your CD/DVD drive.

The software CD should automatically run and an installation window will appear.

If the installation window does not appear, click **Start > All programs > Accessories > Run**.

X:**Setup.exe** replacing "X" with the letter, which represents your CD/DVD drive and click **OK**.

Wireless network setup

- For Windows 8,

If the installation window does not appear, from **Charms**, select **Search** > **Apps** and search for **Run**. Type in X:\Setup.exe, replacing "X" with the letter that represents your CD/DVD drive and click **OK**.

If "**Tap to choose what happens with this disc.**" pop-up window appears, click the window and select **Run Setup.exe**.

- 4 Click **New Printer**.

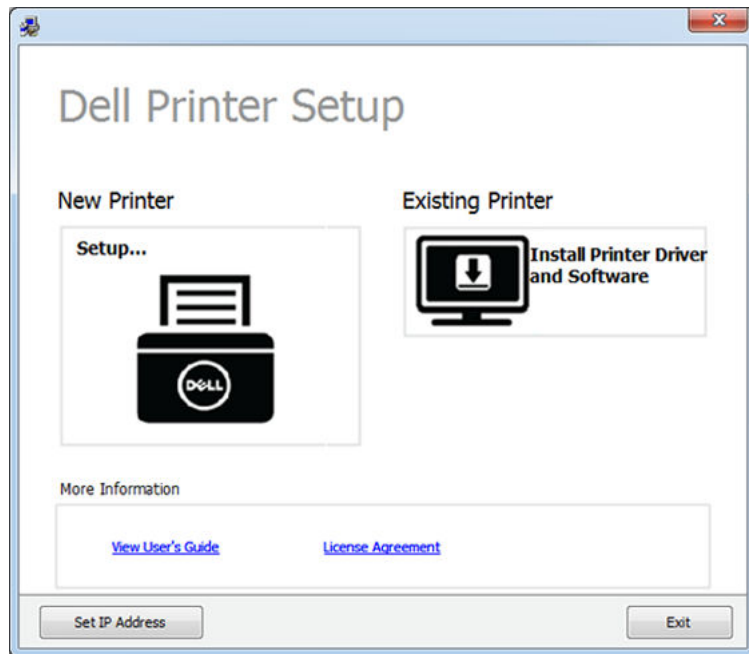

- 5 Choose **Wireless**.

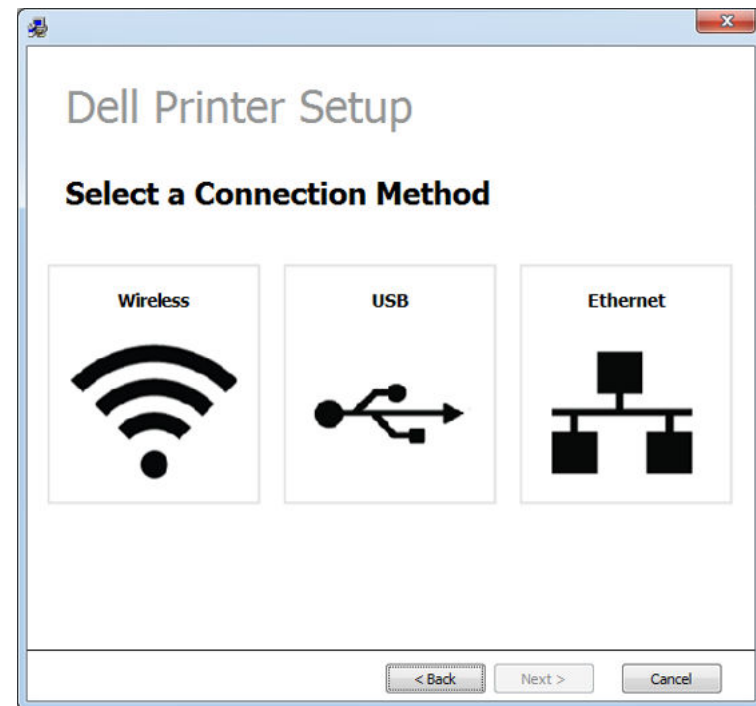

Wireless network setup

6 Click **Next**.

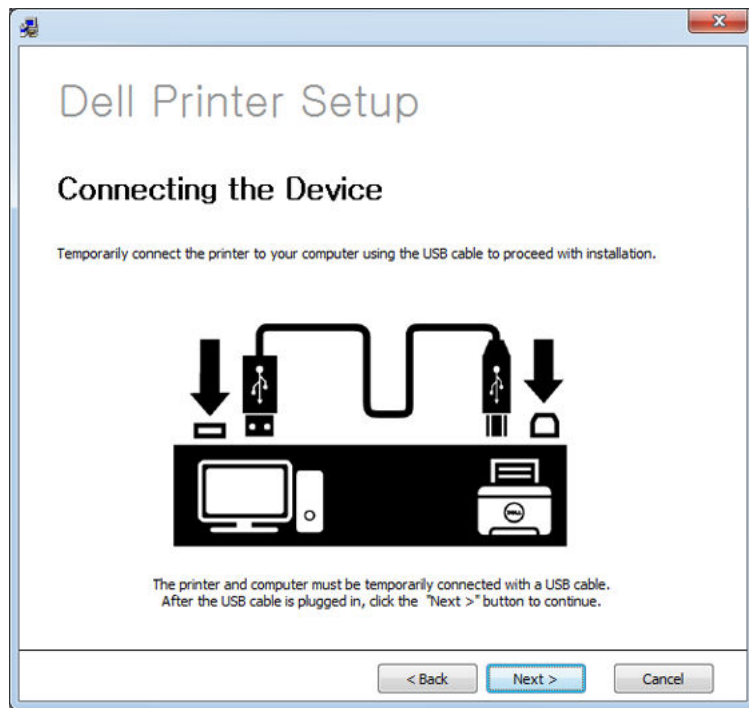

7 The software searches the wireless network.



If the search has failed, you may check if the USB cable is properly connected between the computer and machine, and follow the instructions on the window.

8 After searching, the window shows the wireless network devices. Select the name (SSID) of the access point you are using and click **Next**.



If you cannot find the network name you want to choose, or if you want to set the wireless configuration manually, click **Advanced Setting**.

- **Enter the wireless Network Name:** Enter the SSID of access point you want (SSID is case-sensitive).
- **Operation Mode:** Select **Infrastructure**.
- **Authentication:** Select an authentication type.
 - Open System:** Authentication is not used, and encryption may or may not be used, depending on the need for data security.
 - Shared Key:** Authentication is used. A device that has a proper WEP key can access the network.
 - WPA Personal or WPA2 Personal:** Select this option to authenticate the print server based on WPA Pre-Shared Key. This uses a shared secret key (generally called Pre- Shared Key pass phrase) which is manually configured on the access point and each of its clients.
- **Encryption:** Select the encryption (None, WEP64, WEP128, TKIP, AES, TKIP AES).
- **Network Key:** Enter the encryption network key value.
- **Confirm Network Key:** Confirm the encryption network key value.
- **WEP Key Index:** If you are using WEP Encryption, select the appropriate **WEP Key Index**.

Wireless network setup



The wireless network security window appears when the access point has security settings.

The wireless network security window appears. The window may differ according to its security mode: WEP, or WPA.

- **WEP**

Select **Open System** or **Shared Key** for the authentication and enter the WEP security key. Click **Next**.

WEP (Wired Equivalent Privacy) is a security protocol preventing unauthorized access to your wireless network. WEP encrypts the data portion of each packet exchanged on a wireless network using a 64-bit or 128-bit WEP encryption key.

- **WPA**

Enter the WPA shared key and click **Next**.

WPA authorizes and identifies users based on a secret key that changes automatically at regular intervals. WPA also uses TKIP (Temporal Key Integrity Protocol) and AES (Advanced Encryption Standard) for data encryption.

9

The window shows the wireless network settings and checks if the settings are correct. Click **Next**.

- For the DHCP method

If the IP address assignment method is DHCP, check if DHCP is shown in the window. If it shows Static, click **Change TCP/IP** to change the assignment method to DHCP.

- For the Static method

If the IP address assignment method is Static, check if Static is shown in the window. If it shows DHCP, click **Change TCP/IP** to enter the IP address and other network configuration values for the machine. Before entering the IP address for the machine, you must know the computer's network configuration information. If the computer is set to DHCP, you must contact the network administrator to get the static IP address.

For example:

If the computer's network information is as shown below:

- IP address: 169.254.133.42
- Subnet Mask: 255.255.0.0

Then, the machine's network information should be as follows:

- IP address: 169.254.133.**43**
- Subnet Mask: 255.255.0.0 (Use the computer's subnet mask.)
- Gateway: 169.254.133.**1**

Wireless network setup

- 10 When the wireless network setting is completed, disconnect the USB cable between the computer and machine. Click **Next**.
- 11 The **Wireless Network Setting Complete** window appears.
Select **Yes** if you accept the current settings and continue the setup procedure.
Select **No** if you want to return to the beginning screen.
Then, click **Next**.
- 12 Click **Next** when the **Confirm Printer Connection** window appears.
- 13 Select the components to be installed. Click **Next**.
- 14 After selecting the components, you can also change the machine name, set the machine to be shared on the network, set the machine as the default machine, and change the port name of each machine. Click **Next**.
- 15 After the installation is finished, a window asking you to print a test page appears. If you want to print a test page, click **Print a test page**.
Otherwise, just click **Next** and go to step 16.
- 16 If the test page prints out correctly, click **Yes**.
If not, click **No** to reprint it.
- 17 Click **Finish**.

Ad hoc via USB cable in Windows

If you do not have an access point (AP), you may still connect the machine wirelessly to your computer by setting up an ad-hoc wireless network by following the simple steps below.

- Items to prepare
 - Network-connected computer
 - Software CD that was provided with your machine
 - The machine installed with a wireless network interface
 - USB cable
- 1 Check whether the USB cable is connected to the machine.
 - 2 Turn on your computer and the wireless network machine.
 - 3 Insert the supplied software CD into your CD/DVD drive.
The software CD should automatically run and an installation window will appear.
If the installation window does not appear, click **Start > All programs > Accessories > Run**.
X:**Setup.exe** replacing "X" with the letter, which represents your CD/DVD drive and click **OK**.

Wireless network setup

4 Select **New Printer**.

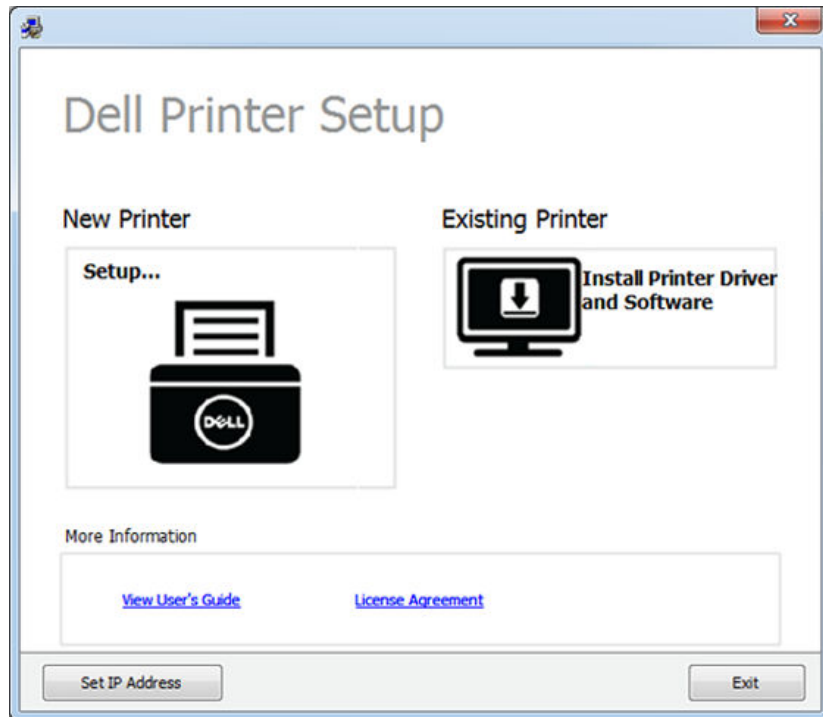

5 Select **Wireless**.

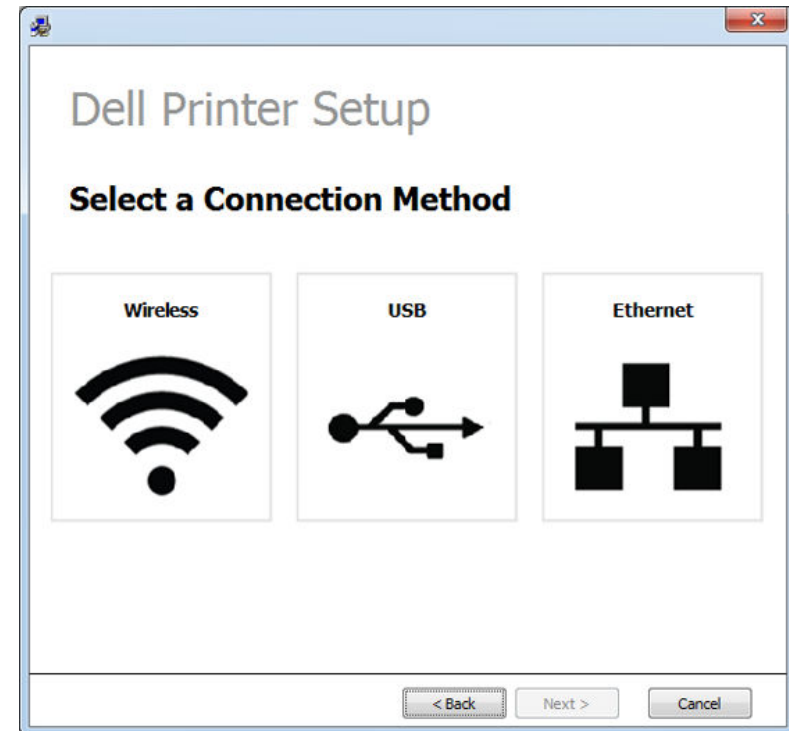

6 The software searches the wireless network.



If the software has failed to search the network, check if the USB cable is connected properly between the computer and machine, and follow the instruction in the window.

Wireless network setup

7 After searching the wireless networks, a list of wireless networks your machine has searched appears.

If you want to use the Dell default ad hoc setting, select the last wireless network on the list, **Network Name(SSID)** is **Dell_device** and **Signal** is **Printer Self Network**.

Then, click **Next**.

If you want to use other ad hoc settings, select another wireless network from the list.



If you want to change ad hoc settings click the **Advanced Setting** button.

- **Enter the wireless Network Name:** Enter the SSID name you want (SSID is case-sensitive).
- **Operation Mode:** Select ad hoc.
- **Channel:** Select the channel. (**Auto Setting** or 2412 MHz to 2467 MHz).
- **Authentication:** Select an authentication type.
 - Open System:** Authentication is not used, and encryption may or may not be used, depending on the need for data security.
 - Shared Key:** Authentication is used. A device that has a proper WEP key can access the network.
- **Encryption:** Select the encryption (None, WEP64, WEP128).
- **Network Key:** Enter the encryption network key value.
- **Confirm Network Key:** Confirm the encryption network key value.
- **WEP Key Index:** If you are using WEP Encryption, select the appropriate **WEP Key Index**.

The wireless network security window appears when the ad hoc network has security setting.

The wireless network security window appears. Select **Open System** or **Shared Key** for the authentication and click **Next**.

- WEP (Wired Equivalent Privacy) is a security protocol preventing unauthorized access to your wireless network. WEP encrypts the data portion of each packet exchanged on a wireless network using a 64-bit or 128-bit WEP encryption key.

8

The window showing the wireless network setting appears. Check the settings and click **Next**.



Before entering the IP address for the machine, you must know the computer's network configuration information. If the computer's network configuration is set to DHCP, the wireless network setting should also be DHCP. Likewise, if the computer's network configuration is set to Static, the wireless network setting should also be Static.

If your computer is set to DHCP and you want to use the Static wireless network setting, you must contact the network administrator to get the static IP address.

- **For the DHCP method**

If the IP address assignment method is DHCP, check if DHCP is shown in the **Wireless Network Setting Confirm** window. If it shows Static, click **Change TCP/IP** to change the assignment method to **Receive IP address automatically (DHCP)**.

Wireless network setup

- **For the Static method**

If the IP address assignment method is Static, check if Static is shown in the **Wireless Network Setting Confirm** window. If it shows DHCP, click **Change TCP/IP** to enter the IP address and other network configuration values for the machine.

For example:

If the computer's network information is as shown follows:

- IP address: 169.254.133.42
- Subnet Mask: 255.255.0.0

Then, the machine's network information should be as below:

- IP address: 169.254.133.**43**
- Subnet Mask: 255.255.0.0 (Use the computer's subnet mask.)
- Gateway: 169.254.133.1

- 9 When the wireless network settings are completed, disconnect the USB cable between the computer and machine. Click **Next**.



If the **Change PC Network Setting** window appears, follow the steps in the window.

Click **Next** if you are finished with the computer's wireless network settings.

If you set the computer's wireless network on DHCP, it will take several minutes to receive the IP address.

- 10 The **Wireless Network Setting Complete** window appears. To print from a Wi-Fi Direct supported mobile device, set the Wi-Fi Direct Option (see "Setting up Wi-Fi Direct" on page 172).



Wi-Fi Direct Option:

- Wi-Fi Direct option appears on the screen only if your printer supports this feature.
- Can start to build Wi-Fi Direct by using Dell Printer Manager (see "Setting up Wi-Fi Direct" on page 172).
- **Network Name(SSID)**: The default Network Name is the model name and the maximum length is 22 characters (not including "Direct-xx-").
- **Network Key** is the numeric string, and the size is 8 ~ 64 characters.

- 11 Click **Next** when the **Confirm Printer Connection** window appears.
- 12 Select the components to be installed. Click **Next**.
- 13 After selecting the components, you can also change the machine name, set the machine to be shared on the network, set the machine as the default machine, and change the port name of each machine. Click **Next**.
- 14 After the installation is finished, a window asking you to print a test page appears. If you want to print a test page, click **Print a test page**.
Otherwise, just click **Next** and go to step 16.
- 15 If the test page prints out correctly, click **Yes**.
If not, click **No** to reprint it.
- 16 Click **Finish**.

Wireless network setup

Setup using Mac

Items to prepare

- Access point
- Network-connected computer
- Software CD that was provided with your machine
- A machine installed with a wireless network interface
- USB cable

Access point via USB cable

- 1 Check whether the USB cable is connected to the machine.
- 2 Turn on your computer, access point, and machine.
- 3 Insert the supplied software CD into your CD/DVD drive.
- 4 Double-click the CD/DVD icon that appears on your Mac desktop.
- 5 Double-click the **MAC_Installer** folder > **Installer OS X** icon.
- 6 Click **Continue**.
- 7 Read the license agreement and click **Continue**.

- 8 Click **Agree** to agree to the license agreement.
- 9 When the message that warns that all applications will close on your computer appears, click **Continue**.
- 10 Click **Wireless Network Setting** button on the **User Options Pane**.
- 11 After searching, the window shows the wireless network devices. Select the name (SSID) of the access point you are using and click **Next**.



When you set the wireless configuration manually, click **Advanced Setting**.

- **Enter the wireless Network Name:** Enter the SSID of the access point (SSID is case-sensitive).
- **Operation Mode:** Select **Infrastructure**.
- **Authentication:** Select an authentication type.
 - Open System:** Authentication is not used, and encryption may or may not be used, depending on the need for data security.
 - Shared Key:** Authentication is used. A device that has a proper WEP key can access the network.
 - WPA Personal or WPA2 Personal:** Select this option to authenticate the print server based on the WPA Pre-Shared Key. This uses a shared secret key (generally called Pre Shared Key pass phrase) that is manually configured on the access point and each of its clients.
- **Encryption:** Select the encryption. (None, WEP64, WEP128, TKIP, AES, TKIP, AES)

Wireless network setup

- **Network Password:** Enter the encryption Network Password value.
- **Confirm Network Password:** Confirm the encryption Network Password value.
- **WEP Key Index:** If you are using WEP Encryption, select the appropriate **WEP Key Index**.

The wireless network security window appears when the access point has security enabled.



- Can start to build Wi-Fi Direct by using Dell Printer Manager (see "Setting up Wi-Fi Direct" on page 172).
- **Network Name(SSID):** The default Network Name is the model name and the maximum length is 22 characters (not including "Direct-xx-").
- **Network Password** is the numeric string, and the size is 8 ~ 64 characters.

12 When the wireless network settings are completed, disconnect the USB cable between the computer and machine.

13 Wireless network set up is completed. After the installation is finished, click **Quit**.



After completing the wireless network connection, you need to install a machine driver to print from an application (see "Installation for Mac" on page 131).

Ad hoc via USB cable

If you do not have an access point (AP), you may still connect the machine wirelessly to your computer by setting up an ad hoc wireless network by following these simple directions.

Items to prepare

- Network-connected computer
- Software CD that was provided with your machine
- A machine installed with a wireless network interface
- USB cable

Creating the ad hoc network in Mac

- 1** Make sure that the machine is connected to your network and powered on.
- 2** Insert the supplied software CD into your CD/DVD drive.
- 3** Double-click the CD/DVD icon that appears on your Mac desktop.
 - For Mac OS X 10.8, Double-click the CD/DVD icon that appears on your Finder.
- 4** Double-click the **MAC_Installer** folder > **Installer OS X** icon.
- 5** Click **Continue**.

Wireless network setup

- 6 Read the license agreement and click **Continue**.
- 7 Click **Agree** to agree to the license agreement.
- 8 Click **Install**. All components necessary for machine operations will be installed.
If you click **Customize**, you can choose individual components to install.
- 9 Enter the password and click **OK**.
- 10 Select **Wireless connection** on the **Printer Connection Type** and click **Continue**.
- 11 After searching the wireless networks, a list of wireless networks your machine has searched appears. Click the **Advanced Settings** button.



- **Enter the wireless Network Name:** Enter the SSID name (SSID is case-sensitive).
- **Operation Mode:** Select ad hoc.
- **Channel:** Select the channel (**Auto Setting** or 2412 MHz to 2467 MHz).
- **Authentication:** Select an authentication type.
Open System: Authentication is not used, and encryption may or may not be used, depending on the need for data security.
Shared Key: Authentication is used. A device that has a proper WEP key can access the network.
- **Encryption:** Select the encryption (None, WEP64, WEP128).
- **Network Password:** Enter the encryption Network Password value.

- **Confirm Network Password:** Confirm the encryption Network Password value.
- **WEP Key Index:** If you are using WEP Encryption, select the appropriate **WEP Key Index**.

The wireless network security window appears when the ad hoc network has security setting.

Select **Open System** or **Shared Key** for the authentication and click **Next**.

- WEP (Wired Equivalent Privacy) is a security protocol preventing unauthorized access to your wireless network. WEP encrypts the data portion of each packet exchanged on a wireless network using a 64-bit or 128-bit WEP encryption key.

- 12 The window showing the wireless network settings appears. Check the settings and click **Next**.



Before entering the IP address for the machine, you must know the computer's network configuration information. If the computer's network configuration is set to DHCP, the wireless network setting should also be DHCP. Likewise, if the computer's network configuration is set to Static, the wireless network setting should also be Static.

If your computer is set to DHCP and you want to use Static wireless network setting, you must contact the network administrator to get the static IP address.

Wireless network setup

- **For the DHCP method**

If the IP address assignment method is DHCP, check if DHCP is shown in the **Wireless Network Setting Confirm** window. If it shows Static, click **Change TCP/IP** to change the assignment method to **Receive IP address automatically (DHCP)**.

- **For the Static method**

If the IP address assignment method is Static, check if Static is shown in the **Wireless Network Setting Confirm** window. If it shows DHCP, click **Change TCP/IP** to enter the IP address and other network configuration values for the machine.

For example,

If the computer's network information is shown as follows:

- IP address: 169.254.133.42
- Subnet Mask: 255.255.0.0

Then, the machine's network information should be as shown below:

- IP address: 169.254.133.**43**
- Subnet Mask: 255.255.0.0 (Use the computer's subnet mask.)
- Gateway: 169.254.133.**1**

13 When the window that tells you that the network cable connection is confirmed appears, disconnect the network cable and click **Next**.

If the network cable is connected, it may have trouble finding the machine when configuring the wireless network.

14 The wireless network connects according to the network configuration.

15 Wireless network set up is completed. After installation is finished, click **Quit**.



After completing the wireless network connection, you need to install a machine driver to print from an application (see "Installation for Mac" on page 131).

Using a network cable



Machines that do not support the network port will not be able to use this feature (see "Rear view" on page 20).

Your machine is a network compatible machine. To enable your machine to work with your network, you will need to perform some configuration procedures.



- After completing the wireless network connection, you need to install a machine driver to print from an application (see "Installing driver over the network" on page 141).
- See your network administrator, or the person that set up your wireless network, for information about your network configuration.

Wireless network setup

Items to prepare

- Access point
- Network-connected computer
- Software CD that was provided with your machine
- A machine installed with a wireless network interface
- Network cable

Printing a network configuration report

You can identify the network settings of your machine by printing a network configuration report.

See "Printing a network configuration report" on page 138.

IP setting using SetIP Program (Windows)

This program is used to manually set the network IP address of your machine using its MAC address to communicate with the machine. The MAC address is the hardware serial number of the network interface and can be found in the **Network Configuration Report**.

See "Setting IP address" on page 138.

Configuring the machine's wireless network

Before starting you will need to know the network name (SSID) of your wireless network and the Network Password if it is encrypted. This information was set when the access point (or wireless router) was installed. If you do not know about your wireless environment, please ask the person who set up your network.

Setting the Wi-Fi Direct for mobile printing

Wi-Fi Direct is an easy-to-setup peer-to-peer connecting between method for your between a printer and mobile device that supports Wi-Fi Direct that provides a secure connection and better throughput than ad hoc mode.

With Wi-Fi Direct, you can connect your printer to a Wi-Fi Direct network while concurrently connecting to an access point, You can also use a wired network and a Wi-Fi Direct network simultaneously so multiple users can access and print documents both from Wi-Fi Direct and from a wired network.



- You cannot connect to the internet through the mobile device in use Wi-Fi Direct.
- The supported protocol list may differ from your model, Wi-Fi Direct networks do NOT support IPv6, network filtering, IPSec, WINS, and SLP services.
- Up to four mobile devices can connect to Wi-Fi Direct at one time.

Wireless network setup

Setting up Wi-Fi Direct

You can enable Wi-Fi Direct feature by one of the following methods.

From the USB cable-connected computer(recommended)

- After the driver installation is complete, Dell Printer Manager can be set and changes in the Wi-Fi Direct can be made.



Dell Printer Manager is Available for Windows and Mac OS users only.

- From the **Start** menu, select **Programs** or **All Programs > Dell Printers > Dell Printer Manager > Device Settings > Network**.
 - **Wi-Fi Direct On/Off:** Select **On** to enable.
 - **Device Name:** Enter the printer's name for searching for your printer on a wireless network. By default, the device name is the model name.
 - **IP Address:** Enter the IP address of the printer. This IP address is used only for the local network and not for the infrastructure wired or wireless network. We recommend using the default local IP address (the default local IP address of the printer for Wi-Fi Direct is 192.168.3.1)
 - **Group Owner:** Activate this option to assign the printer the Wi-Fi Direct group's owner. The **Group Owner** acts similar to a wireless access point. We recommend activating this option.

- **Network Password:** If your printer is a **Group Owner**, a **Network Password** is required for other mobile devices to connect to your printer. You can configure a Network Password yourself, or can remember the given Network Password that is randomly generated by default.

From the machine (Machines with a display screen)

- Select **Network > Wireless > Wi-Fi Direct** from the control panel.
- Enable **Wi-Fi Direct**.

Setting up the mobile device

- After setting up Wi-Fi Direct from the printer, refer to the user manual of the mobile device you are using to set its Wi-Fi Direct.
- After setting up Wi-Fi Direct, you need to download the mobile printing application (For example: Dell Mobile printer) to print from your smartphone.



- When you have found the printer you want to connect to from your mobile device, select the printer and the printer's LED will blink. Press the WPS button on the printer and it will be connected to your mobile device.
- If your mobile device does not support WPS, you need to enter the "Network Password" of a printer instead of pushing the WPS button.

Wireless network setup

What is Dell MobilePrint?

Dell MobilePrint is a free application that enables users to print photos, documents, and web pages directly from your smartphone or tablet. **Dell MobilePrint** is not only compatible with your Android, Windows and iOS smart phones but also with your iPod Touch and tablet PC. It connects your mobile device to a network connected Dell printer or to a wireless printer through a Wi-Fi access point. Installing a new driver or configuring network settings isn't necessary – just simply install the **Dell MobilePrint** application, and it will automatically detect compatible Dell printers. Besides printing photos, web pages, and PDFs, scanning is also supported. If you have Dell multifunction printer, scan any document into a JPG, PDF, or PNG format for quick and easy viewing on your mobile device.

Downloading Dell MobilePrint

To download **Dell MobilePrint**, go to the application store (Dell Apps, Android Market, Play Store, Marketplace) on your mobile device, and just search for "**Dell MobilePrint**." You can also visit iTunes for Apple devices or Marketplace for Windows devices on your computer.



Supported Mobile OS

- Android OS 2.1 or higher
- iOS 4.0 or higher
- Windows Phone 7 or higher

Supported devices

- **iOS 4.0 or higher:** iPod Touch, iPhone, iPad
- **Android 2.1 or higher:** Galaxy S, Galaxy S2, Galaxy Tab, and Android mobile devices
- **Windows Phone 7 or higher:** Dell Focus, Omnia7, and OmniaW, and Windows mobile devices

Wireless network setup

Troubleshooting

Problems during setup or driver installation

Printers Not Found

- Your machine may not be turned on. Turn on your computer and the machine.
- USB cable is not connected between your computer and machine. Connect the machine to your computer using the USB cable.
- The machine does not support wireless networking. Check the machine's user's guide included on the software CD supplied with your machine and prepare a wireless network machine.

Connecting Failure - SSID Not Found

- The machine is unable to find the network name (SSID) you have selected or entered. Check the network name (SSID) on your access point and try connecting again.
- Your access point is not turned on. Turn on your access point.

Connecting Failure - Invalid Security

- Security is not configured correctly. Check the configured security on your access point and machine.

Connecting Failure - General Connection Error

- Your computer is not receiving a signal from your machine. Check the USB cable and your machine's power.

Connecting Failure - Connected Wired Network

- Your machine is connected with a wired network cable. Remove the wired network cable from your machine.

PC Connection Error

- The configured network address is unable to connect between your computer and machine.
 - For a DHCP network environment
The receives the IP address automatically (DHCP) when computer is configured to DHCP.
 - For a Static network environment
The machine uses the static address when the computer is configured to static address.
For example,
If the computer's network information is as shown below:

Wireless network setup

- IP address: 169.254.133.42
- Subnet Mask: 255.255.0.0

Then the machine's network information should be as below:

- IP address: 169.254.133.**43**
- Subnet Mask: 255.255.0.0 (Use the computer's subnet mask.)
- Gateway: 169.254.133.**1**

Other problems

If problems occur while using the machine on a network, check the following:



For information on the access point (or wireless router), refer to its own user's guide.

- Your computer, access point (or wireless router), or machine may not be turned on.
- Check the wireless reception around the machine. If the router is far from the machine or there is an obstacle, you might have difficulty receiving the signal.
- Cycle the power for the access point (or wireless router), machine, and computer. Sometimes cycling the power can recover network communication.

- Check whether firewall software (V3 or Norton) is blocking the communication.

If the computer and the machine are connected on the same network and it cannot be found when searching, firewall software might be blocking the communication. Refer to the user's guide for the software to turn it off and try searching for the machine again.

- Check whether the machine's IP address is allocated correctly. You can check the IP address by printing the network configuration report.
- Check whether the access point (or wireless router) has a configured security (password). If it has a password, refer to the access point (or wireless router) administrator.
- Check the machine's IP address. Reinstall the machine driver and change the settings to connect to the machine on the network. Due to the characteristics of DHCP, the allocated IP address could change if the machine is not used for a long time or if the access point has been reset.

Register the product's MAC address when you configure the DHCP server on the access point (or wireless router). Then you can always use the IP address that is set with the MAC address. You can identify the Mac address of your machine by printing a network configuration report (see "Printing a network configuration report" on page 138).

- Check the wireless environment. You might not be able to connect to the network in the infrastructure environment where you need to type in a user's information before connecting to the access point (or wireless router).
- This machine only supports IEEE 802.11 b/g/n and Wi-Fi. Other wireless communication types (e.g., Bluetooth) are not supported.

Wireless network setup

- When using the ad hoc mode, in operating systems such as Windows Vista, you might need to set the wireless connection setting every time you use the wireless machine.
- You cannot use infrastructure mode and ad hoc mode at the same time for Dell wireless network machines.
- The machine is within the range of the wireless network.
- The machine is located away from obstacles that could block the wireless signal.

Remove any large metal objects between the access point (or wireless router) and the machine.

Make sure the machine and wireless access point (or wireless router) are not separated by poles, walls, or support columns containing metal or concrete.

- The machine is located away from other electronic devices that may interfere with the wireless signal.

Many devices can interfere with the wireless signal, including a microwave oven and some Bluetooth devices.

- Whenever the configuration of your access point (or wireless router) changes, you must do the product's wireless network setup again.
- If Wi-Fi Direct is ON, this machine only supports IEEE 802.11 b/g.
- If the access point is set to work with the 802.11n standard only, it may not connect to your machine.



3. Useful Setting Menus

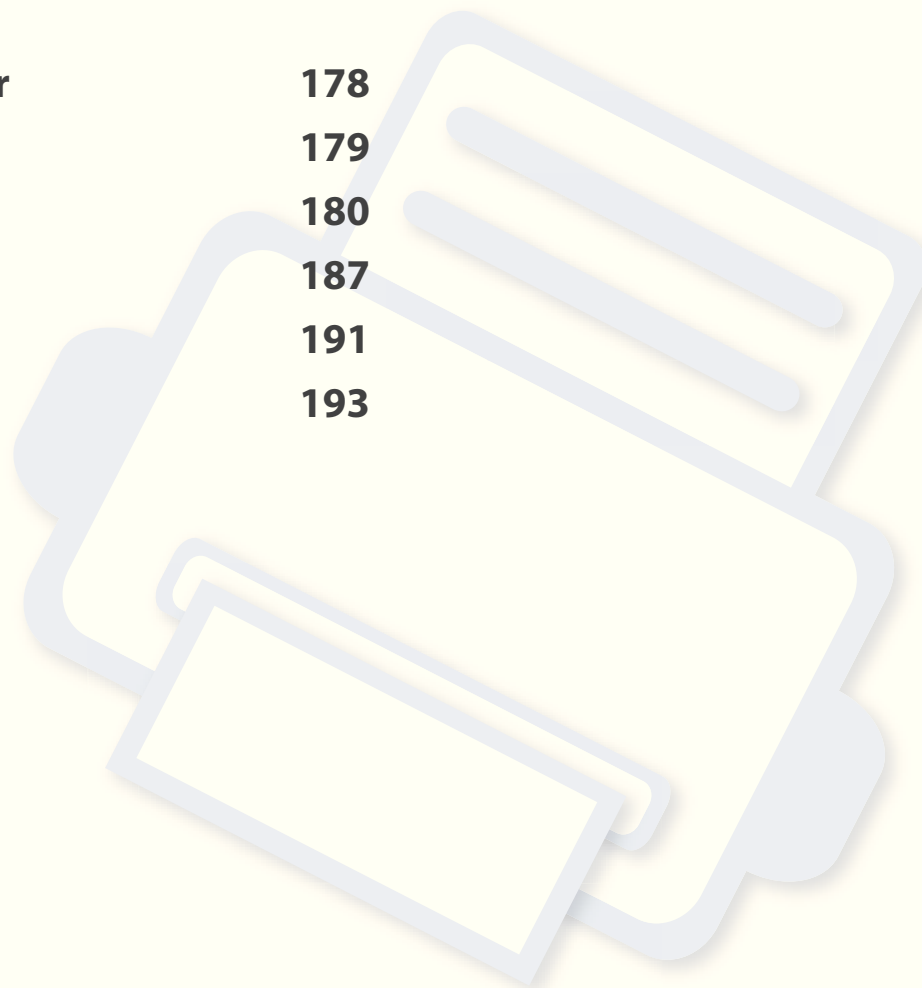

This chapter explains how to browse the current status of your machine, and the method of setting for advanced machine setup.

- **Before you begin reading a chapter** 178
- **Print menu** 179
- **Copy menu** 180
- **Fax menu** 187
- **Scan menu** 191
- **System setup** 193



Before you begin reading a chapter

This chapter explains all the features available for this series' models to help users easily understand the features. You can check the features available for each model in the Basic Guide (see "Menu overview" on page 29). The following are tips for using this chapter

- The control panel provides access to various menus to set up the machine or use the machine's functions. These menus can be accessed by pressing  (**Menu**).
- Some menus may not appear on the display depending on options or models. If so, it is not applicable to your machine.
- For models that do not have the  (**Menu**) on the control panel, this feature is not applicable (see "Control panel overview" on page 21).
- Some menu names may differ from your machine depending on its options or the models.

Print menu



Some menus may not appear in the display depending on options or models. If so, it is not applicable to your machine (see "Menu overview" on page 29).

To change the menu options:

- Press  (**Menu**) > **Print Setup** on the control panel.
- Or press **Setup** > **Machine Setup** > **Print Setup**.

Item	Description
Orientation	Selects the direction in which information is printed on a page.
Copies	You can enter the number of copies using the number keypad.
Resolution	Specifies the number of dots printed per inch (dpi). The higher the setting, the sharper printed characters and graphics.
Darkness	Lightens or darkens the print on the page. The Normal setting usually produces the best result. Use the Light toner density setting to save toner.
Darken Text	Prints text darker than on a normal document.
Emulation	Sets the emulation type and option.



Copy menu

Copy feature



Some menus may not appear in the display depending on options or models. If so, it is not applicable to your machine (see "Menu overview" on page 29).

To change the menu options:



- Press  (copy) >  (**Menu**) > **Copy Feature** on the control panel.
- Or press **Setup** > **Machine Setup** > **Default Setting** > **Copy Default**.
- Or press **Copy** > select the menu item.

Item	Description
<ul style="list-style-type: none">• Scan Size• Original Size	Sets the image size.
Copies	You can enter the number of copies using the number keypad.

Item	Description
Reduce/Enlarge	Reduces or enlarges the size of a copied image (see "Reduced or enlarged copy" on page 56).  If the machine is set Eco mode, reduce and enlarge features are not available.
Darkness	Adjusts the brightness level to make a copy that is easier to read, when the original contains faint markings and dark images (see "Darkness" on page 55)
Contrast	Adjusts the contrast level to scan an original that is easier to read, when the original contains too faint or too dark contents (see "Contrast" on page 55)
Original Type	Improves the copy quality by selecting the document type for the current copy job (see "Original" on page 55)
Orientation	Sets the original image's orientation.
Layout	Adjusts the layout format such as poster, clone, ID copy, 2/4-up, booklet, etc.

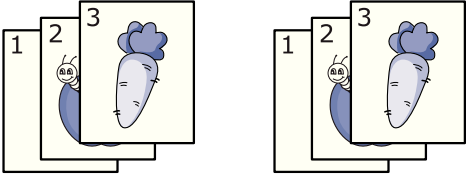
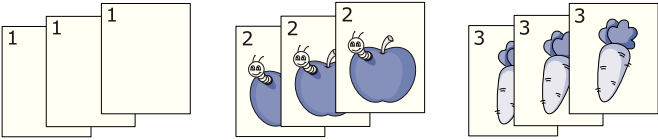
Copy menu

Item	Description
<ul style="list-style-type: none">• Copy Collation• Collate Copy	<p>Set the machine to sort the copy job. For example, if you make 2 copies of a 3 page original, one complete 3 page document will print followed by a second complete document.</p> <ul style="list-style-type: none">• On: Prints output in sets to match the sequence of originals.  <ul style="list-style-type: none">• Off: Prints output sorted into stacks of individual pages. 

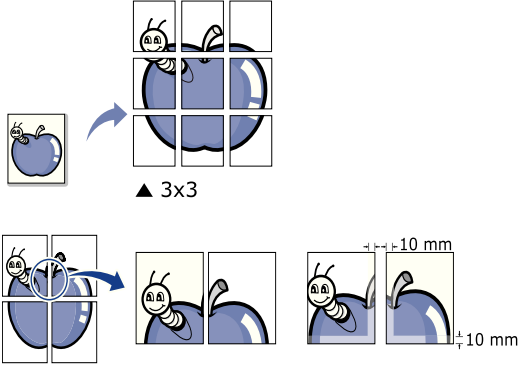

Item	Description
<ul style="list-style-type: none">• 2-up or 4-up• N-up Copy	<p>Reduces the size of the original images and prints 2 or 4 pages onto one sheet of paper.</p>  <div data-bbox="1496 608 2195 762"><p>This copy feature is available only when you load originals into the document feeder.</p></div>

Copy menu

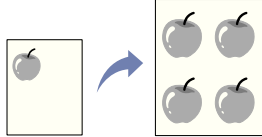
Item	Description									
<p>Poster Copy</p>	<p>Prints a single-page document onto 4 (Poster 2x2), 9 (Poster 3x3), or 16 (Poster 4x4) sheets of paper, for the purpose of pasting the sheets together to form one poster-size document.</p>  <p>▲ 3x3</p> <p>+10 mm</p> <p>+10 mm</p> <p>• This copy feature is available only when you place originals on the scanner glass.</p> <p>• Your original is divided into 9 portions. Each portion is scanned and printed one by one in the following order:</p> <table border="1" data-bbox="517 1150 712 1382"> <tbody> <tr> <td>1</td> <td>2</td> <td>3</td> </tr> <tr> <td>4</td> <td>5</td> <td>6</td> </tr> <tr> <td>7</td> <td>8</td> <td>9</td> </tr> </tbody> </table>	1	2	3	4	5	6	7	8	9
1	2	3								
4	5	6								
7	8	9								

Item	Description
<p>Clone Copy</p>	<p>Prints multiple original images on a single page. The number of images is automatically determined by the original image and the paper size.</p>  <p>• This copy feature is available only when you place originals on the scanner glass.</p> <p>• You cannot adjust the copy size using Reduce/Enlarge for the Clone Copy feature.</p>

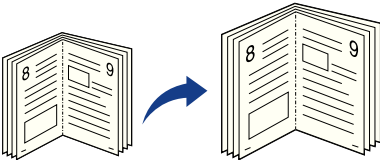
Copy menu

Item	Description
Book Copy	<p>The Book Copy feature allows you to copy an entire book. If the book is too thick, lift the cover until its hinges are caught by the stopper and then close the cover. If the book or magazine is thicker than 30 mm, start copying with the cover open.</p>  <ul style="list-style-type: none"> • Off: Does not use this feature. • Left Page: Use this option to print left page of the book. • Right Page: Use this option to print right page of the book. • Both Page: Use this option to print both pages of the book. <div style="border: 1px solid gray; padding: 5px; margin-top: 10px;">  This copy feature is available only when you place originals on the scanner glass. </div>

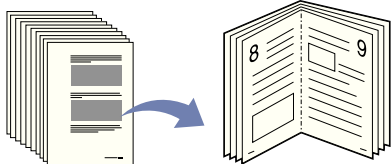
Item	Description
Booklet	<p>The machine automatically prints on one or both sides of the paper, which are then folded to produce a booklet with all of the pages in the correct sequence.</p> <p>The machine will reduce and correctly adjust the position of each image to fit on the selected paper.</p> 
Adjust Bkgd	<p>Prints an image without its background. This copy feature removes the background color and can be helpful when copying an original containing color in the background, such as a newspaper or a catalog.</p> <ul style="list-style-type: none"> • Off: Does not use this feature. • Auto: Optimizes the background. • Enhance Lev.1~2: The higher the number is, the more vivid the background is. • Erase Lev.1~4: The higher the number is, the lighter the background is.

Copy menu

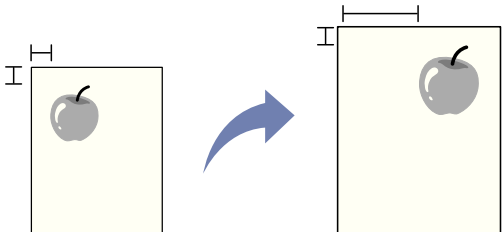
Item	Description
Margin Shift copying	<p>Allows you to create a binding edge for the document. The image can be adjusted up or down on the page and/or shifted to the right or left.</p>  <ul style="list-style-type: none">• Off: Does not use this feature.• Auto Center: Automatically copy in the center of the paper. This feature is available only when you place originals on the scanner glass.• Custom Margin: Enter the left, right, top, bottom margin using Number keypad.

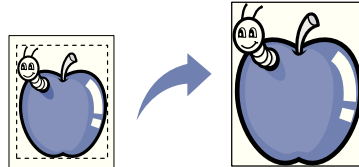
Item	Description
Edge Erase copying	<p>Allows you to erase spots, drill holes, fold creases and staple marks along any of the four edges of a document.</p>  <ul style="list-style-type: none">• Off: Does not use this feature.• SmallOriginal: rases the edge of the original if it is small. This feature is available only when you place originals on the scanner glass.• Hole Punch: Erases the marks of bookbinding holes.• Book Center: Erases the middle part of the paper which is black and horizontal, when you copy a book. This feature is available only when you place originals on the scanner glass.• Border Erase: Enter the left, right, top, bottom margin using Number keypad.
Gray Enhance copying	<p>When you make a copy in gray scale, use this feature to get better quality of copy-output.</p>

Copy menu

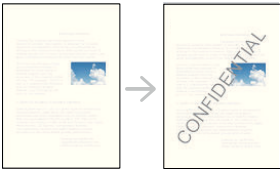
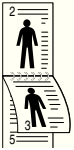
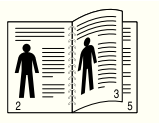
Item	Description
Watermark copying	<p>The watermark option allows you to print text over an existing document. For example, you use it when you want to have large gray letters reading “DRAFT” or “CONFIDENTIAL” printed diagonally across the first page or all pages of a document.</p> 
Duplex	<p>You can set the machine to print copies on both sides of paper.</p> <ul style="list-style-type: none"> • Off: Prints in normal mode. • 1->2Side Short  <ul style="list-style-type: none"> • 1->2Side Long 

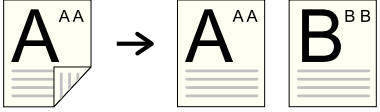
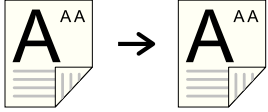
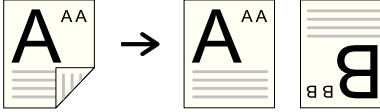
Item	Description
Duplex (continue)	<ul style="list-style-type: none"> • 2->1Side  <ul style="list-style-type: none"> • 2->2Side  <ul style="list-style-type: none"> • 2->1Side ROT2 



Copy menu

Copy Setup



Some menus may not appear in the display depending on options or models. If so, it is not applicable to your machine (see "Menu overview" on page 29).

To change the menu options:

Press  (copy) >  (**Menu**) > **Copy Setup** on the control panel.

Item	Description
Change Default	Resets the value or setting to the printer's out-of-box state.

Fax menu

Fax Feature



Some menus may not appear in the display depending on options or models. If so, it is not applicable to your machine (see "Menu overview" on page 29).

To change the menu options:

- Press (fax) > (Menu) > **Fax Feature** on the control panel.
- Or press **Setup** > **Machine Setup** > **Default Setting** > **Fax Default**.
- Or press **Fax** > select the menu item.

Item	Description
<ul style="list-style-type: none"> • Scan Size • Original Size 	Sets the image size.
Contrast	Adjusts the contrast level to scan an original that is easier to read, when the original contains too faint or too dark contents.
Darkness	Adjusts the brightness level to scan an original that is easier to read, when the original contains faint markings and dark images (see "Darkness" on page 64).

Item	Description
Resolution	The default document settings produce good results when using typical text-based originals. However, if you send originals that are of poor quality, or contain photographs, you can adjust the resolution to produce a higher quality fax (see "Resolution" on page 63).
Duplex	prints the received fax on both sides of paper.
Multi Send	Sends a fax to multiple destinations (see "Sending a fax to multiple destinations" on page 62). You cannot send a color fax using this feature.
Delay Send	Sets your machine to send a fax at a later time when you will not be present (see "Delaying a fax transmission" on page 235). You cannot send a color fax using this feature.
Priority Send	Scans the original into memory and immediately transmits it when the current operation is finished. Priority transmission will interrupt a sending to multiple destinations between stations (example, when the transmission to station A ends, before transmission to station B begins) or between redial attempts (see "Sending a priority fax" on page 236).

Fax menu

Item	Description
Forward	<p>Forwards the received or sent fax to other destination by a fax or PC. If you are out of office but have to receive the fax, this feature may be useful.</p> <ul style="list-style-type: none">• See "Forwarding a sent fax to another destination" on page 237.• See "Forwarding a received fax" on page 237.
Secure Receive	<p>Stores the received fax in memory without printing out. To print received documents, you need to enter the password. You can prevent your received faxes from being accessed by unauthorized people (see "Receiving in secure receiving mode" on page 241).</p>
Add Page	<p>Adds additional documents to a reserved delay fax job (see "Adding documents to a reserved fax" on page 236).</p>
Cancel Job	<p>Cancels the delayed fax job which is saved in memory (see "Canceling a reserved fax job" on page 236).</p>

Sending setup



Some menus may not appear in the display depending on options or models. If so, it is not applicable to your machine (see "Menu overview" on page 29).

To change the menu options:

- Press (fax) > (**Menu**) > **Fax Setup** > **Sending** on the control panel.
- Or press **Setup** > **Machine Setup** > **Default Setting** > **Fax Default**.

Item	Description
Redial Times	Sets the number of redial attempts. If you enter 0, the machine will not redial.
Redial Term	Sets the time interval before automatic redialling.
Prefix Dial	Sets a prefix of up to five digits. This number dials before any automatic dial number is started. It is useful for accessing a PABX exchange.
ECM Mode	Sends faxes using error correction mode (ECM) to make sure the faxes are sent smoothly without any error. It may take more time.

Fax menu

Item	Description
Send Report	Sets the machine to print a report whether a fax transmission was successfully completed or not. If you select On-Error , the machine prints a report only when a transmission is not successful.
Image TCR	Prints a transmission report with a minimized image of the first page of the fax sent.
Dial Mode	Sets the dialing mode to either tone or pulse. This setting may not be available depending on your country.
Toll Save	Sends faxes at a preset toll-saving time to save on call costs. This setting may not be available depending on your country.
Setup Wizard	Makes it easy to configure the necessary fax options such as machine ID, fax number, etc.

Receiving setup



Some menus may not appear in the display depending on options or models. If so, it is not applicable to your machine (see "Menu overview" on page 29).

To change the menu options:

- Press  (fax) >  (**Menu**) > **Fax Setup** > **Receiving** on the control panel.
- Or press **Setup** > **Machine Setup** > **Default Setting** > **Fax Default**.

Item	Description
Receive Mode	Selects the default fax receiving mode.
Ring To Answer	Specifies the number of times the machine rings before answering an incoming call.
Stamp RCV Name	Automatically prints the page number, and the date and time of reception at the bottom of each page of a received fax.
Rcv Start Code	Initiates fax reception from an extension phone plugged into the EXT socket on the back of the machine. If you pick up the extension phone and hear fax tones, enter the code. It is preset to *9* at the factory.

Fax menu

Item	Description
Auto Reduction	Automatically reduces an incoming fax page to fit the size of the paper loaded in the machine.
Discard Size	Discards a specific length from the end of the received fax.
Junk Fax Setup	Blocks any unwanted faxes that you stored in the memory as junk fax numbers. This setting may not be available depending on your country.
DRPD Mode	Enables a user to use a single telephone line to answer several different telephone numbers. You can set the machine to recognize different ring patterns for each number. This setting may not be available depending on your country (see "Receiving faxes using DRPD mode" on page 240).
Duplex Print	Prints the received fax data on both sides of the paper. You can save the paper usage.
<ul style="list-style-type: none">• Doc Box Saving• Document Box Saving	Stores received faxes in the common box. This menu only appears when an optional mass storage device (HDD) drive has been installed (see "Variety feature" on page 7).



Scan menu

Scan feature



Some menus may not appear in the display depending on options or models. If so, it is not applicable to your machine (see "Menu overview" on page 29).

To change the menu options:

- Press  (scan) >  (**Menu**) > **Scan Feature** on the control panel.
- Or press **Setup** > **Machine Setup** > **Default Setting** > **Scan Default**.
- Or press **Scan** > select the menu item.

Item	Description
<ul style="list-style-type: none">• USB Default• USB	Sets scan destination to a USB. You scan the originals and save the scanned image to a USB device.
<ul style="list-style-type: none">• E-mail Default• Send Email• Custom Email	Sets scan destination to an email. You scan the originals and email the scanned image to destinations.
<ul style="list-style-type: none">• FTP Default• FTP	Sets scan destination to an FTP server. You scan the originals and send the scanned image to an FTP server.

Item	Description
<ul style="list-style-type: none">• SMB Default• SMB	Sets scan destination to an SMB server. You scan the originals and send the scanned image to an SMB server.
Send Report	Prints a confirmation report showing whether the scanned image sending was successful.
Local PC	Sets scan destination to a usb-connected computer. You scan the originals and save the scanned image to a directory such as My Documents (see "Basic Scanning" on page 59).
Network PC	Sets scan destination to a network-connected computer. You scan the originals and save the scanned image to a directory such as My Documents (see "Scanning from network connected machine" on page 226).
Document Box	Sets scan destination to a Document Box . You scan the originals and send the scanned image to the storage which called Document Box in the machine.



Scan menu

Scan setup



Some menus may not appear in the display depending on options or models. If so, it is not applicable to your machine (see "Menu overview" on page 29).

To change the menu options:

- Press  (scan) >  (**Menu**) > **Scan Setup** on the control panel.
- Or press **Setup** > **Machine Setup** > **Default Setting** > **Scan Default**.

Item	Description
<ul style="list-style-type: none">• Scan Size• Original Size	Sets the image size.
Original Type	Sets the original document's type.
Resolution	Sets the image resolution.
Color Mode	Sets the color mode.
File Format	Sets the file format in which the image is to be saved. If you select BMP, JPEG, TIFF, or PDF, you can select to scan multiple pages.
Darkness	Adjusts the brightness level to scan.

Item	Description
Contrast	Adjust the contrast level to scan lighter or darker than the original.

System setup

Machine setup



Some menus may not appear in the display depending on options or models. If so, it is not applicable to your machine (see "Menu overview" on page 29).

To change the menu options:

- Press  (**Menu**) > **System Setup** > **Machine Setup** on the control panel.
- Or press **Setup** > **Machine Setup** > **Initial Setup**.

Item	Description
Machine ID	Sets the machine ID which will be printed at the top of each fax page that you send.
Fax Number	Sets the fax number which will be printed at the top of each fax page that you send.
Date & Time	Sets the date and time.
Clock Mode	Selects the format for displaying time between 12 hr. and 24 hr.
Language	Sets the language of the text that appears on the control panel display.

Item	Description
Power Save	Sets how long the machine waits before going to power save mode. When the machine does not receive data for an extended period of time, power consumption is automatically lowered.
System Timeout	Sets the time that the machine remembers previously used copy settings. After the timeout, the machine restores the default copy settings.
Wakeup Event	You can set the condition to wake up from power-save mode. Set the item on. <ul style="list-style-type: none">• Button Press: When you press any button except power button, the machine wake up from the power save mode.• Scanner: When you insert paper in the document feeder, the machine wake up from the power save mode.• Printer: When you open or close the paper tray, the machine wake up from the power save mode.

System setup

Item	Description
Auto Continue	Determine whether or not the machine continues printing when it detects the paper does not match the paper settings. <ul style="list-style-type: none">• Off: If a paper mismatch occurs, the machine waits until you insert the correct paper.• On: If a paper mismatch occurs, an error message will display. The machine waits for about 30 second, then automatically clear the message and continue printing.
<ul style="list-style-type: none">• Altitude Adj.• Altitude Adjustment	Optimize print quality according to the machine's altitude.
Paper Substit. Paper Substitution	Automatically substitutes the printer driver's paper size to prevent the paper mismatch between Letter and A4. For example, if you have A4 paper in the tray but you set the paper size to Letter in the printer driver, the machine prints on A4 paper and vice versa.
Paper Mismatch	Determine whether to disregard the paper mismatch error or not. Select Off , then the machine does not stop printing even if the paper mismatches.
Toner Save	Activating this mode extends the life of your toner cartridge and reduces your cost per page beyond what one would experience in the normal mode, but it reduces print quality.

Item	Description
Eco Settings	Allows you to save print resources and enables eco-friendly printing. <ul style="list-style-type: none">• Default Mode: Select whether to turn the Eco mode on or off. <div style="border: 1px solid gray; padding: 5px;"> On force (On-Forced): Sets the Eco mode on with password. If a user wants to turn the Eco mode on/off, the user needs to enter the password.</div>

System setup

Paper setup



Some menus may not appear in the display depending on options or models. If so, it is not applicable to your machine (see "Menu overview" on page 29).

To change the menu options:

- Press  (**Menu**) > **System Setup** > **Paper Setup** on the control panel.
- Or press **Setup** > **Machine Setup** > **Paper Setup**.

Item	Description
Paper Size	Sets the paper size as A4, Letter, or other paper sizes, according to your requirements.
Paper Type	Chooses the type of the paper for each tray.
Paper Source	Selects from which tray the paper is used.
Margin	Sets the margins for the document.
Tray Confirm	Activates the tray confirmation message. If you open and close a tray, a window asking you whether to set the paper size and type for the tray just opened appears.

Sound / Volume





Some menus may not appear in the display depending on options or models. If so, it is not applicable to your machine (see "Menu overview" on page 29).

To change the menu options:

- Press  (**Menu**) > **System Setup** > **Sound/Volume** on the control panel.
- Or press **Setup** > **Machine Setup** > **Initial Setup** > **Sound/Volume**.

Item	Description
Key Sound	Turns the key sound on or off. With this option set to on, a tone sounds each time a key is pressed.
Alarm Sound	Turns the alarm sound on or off. With this option set to on, an alarm tone sounds when an error occurs or fax communication ends.

System setup

Item	Description
Speaker	<p>Turns on or off the sounds from the telephone line through the speaker, such as a dial tone or a fax tone. With this option set to Comm. which means the speaker is on until the remote machine answers.</p> <p> You can adjust the volume level using On Hook Dial. You can adjust the speaker volume only when the telephone line is connected.</p> <ol style="list-style-type: none">Press  (fax) on the control panel.Press On Hook Dial. A dial tone sounds from the speaker.Press the arrows until you hear the volume you want.Press On Hook Dial to save the change and return to ready mode.
Ringer	<p>Adjusts the ringer volume. For the ringer volume, you can select off, low, middle, and high level.</p>

Report



Some menus may not appear in the display depending on options or models. If so, it is not applicable to your machine (see "Menu overview" on page 29).

To change the menu options:

- Press  (**Menu**) > **System Setup** > **Report** on the control panel.
- Or press **Setup** > **Machine Setup** > **Reports**.

Item	Description
Menu Map	Prints the menu map which shows the layout and current settings of this machine.
All Reports	Prints all kinds of reports that this machine provides.
Configuration	Prints a report on the machine's overall configuration.
<ul style="list-style-type: none">• Supplies Info.• Supplies Information	Prints supplies' information page.
Address Book	Prints all of the email addresses currently stored in the machine's memory.

System setup

Item	Description
Demo Page	Prints the demo page to check whether your machine is printing properly or not.
Fax Send	Prints a transmission report including the fax number, the number of pages, the elapsed time of the job, the communication mode, and the communication results for fax job. You can set up your machine to automatically print a transmission confirmation report after each fax job.
Fax Sent	Prints information on the faxes you have recently sent.
Fax Received	Prints information on the faxes you have recently received.
Email Sent	Prints information on the emails you have recently sent.
<ul style="list-style-type: none"> • Schedule Jobs • Fax Scheduled Jobs 	Prints the document list currently stored for delayed faxes along with the starting time and type of each operation.
JunkFax	Prints the fax numbers specified as junk fax numbers.
<ul style="list-style-type: none"> • Network Conf. • Network Configuration 	Prints information on your machine's network connection and configuration.

Item	Description
<ul style="list-style-type: none"> • User Auth • Local User Authentication 	Prints the authorized users who are allowed to use the email function.
PCL Font	Prints the PCL font list.
<ul style="list-style-type: none"> • PS Font • PS3 Font List 	Prints the PS/PS3 font list.
EPSON Font	Prints the EPSON font list.
KSC5843 Font	Prints the KSC5843 font list.
KSC5895 Font	Prints the KSC5895 font list.
KSSM Font List	Prints the KSSM font list.
<ul style="list-style-type: none"> • Net User Auth • Network User Authentication 	Prints the users and their IDs who logged in the domain.
Usage Counter	Prints a usage page. The usage page contains the total number of pages printed.
Fax Options	Prints the information of a fax reports.
<ul style="list-style-type: none"> • Stored Job List • Stored Jobs 	Prints jobs currently stored in the optional memory or on a mass storage device (HDD).
<ul style="list-style-type: none"> • Completed Job • Completed Jobs 	Prints list of completed jobs.

System setup

Maintenance



Some menus may not appear in the display depending on options or models. If so, it is not applicable to your machine (see "Menu overview" on page 29).

To change the menu options:

- Press  (**Menu**) > **System Setup** > **Maintenance** on the control panel.
- Or press **Setup** > **Machine Setup** > **Initial Setup**.

Item	Description
CLR Empty Msg.	When toner cartridge is empty, this option appears. You can clear the empty message.
Ignore Toner	You can set the machine to ignore the toner empty message and continue printing except incoming faxes.
Supplies Life	Shows the supply life indicators (see "Monitoring the supplies life" on page 76.)
TonerLow Alert	Customizes the level to alert toner low or toner empty (see "Setting the toner low alert" on page 77).
<ul style="list-style-type: none">• Serial Number• Serial No.	Shows the machine's serial number. When you call for service or register as a user on the Dell website, you can find this.

Item	Description
Paper Stacking	Enables the automatic linking feature for trays. When one tray is not available for paper empty or mismatch, this option allows your printer to feed paper from another available tray.
Color	Allows you to adjust the color setting such as contrast level, color registration, color density, etc.
Ram Disk	Sets some part of ram disk to the job storage area. Using the storage area activates the job manage menu (see "Job manage" on page 200). This allows the data from your computer to be sent to the print queue of the ram disk.

System setup

Clear setting



Some menus may not appear in the display depending on options or models. If so, it is not applicable to your machine (see "Menu overview" on page 29).

To change the menu options:

- Press  (**Menu**) > **System Setup** > **Clear Setting** on the control panel.
- Or press **Setup** > **Machine Setup** > **Restore Options**.

Item	Description
All Settings	Clears all of the data stored in memory and resets all of your settings to the factory default.
Printer Setup	Restores all of the printer options to the factory default.
Paper Setup	Restores all of the paper options to the factory default.
<ul style="list-style-type: none">• Fax Setup• Fax Default	Restores all of the fax options to the factory default.
<ul style="list-style-type: none">• Copy Setup• Copy Default	Restores all of the copy options to the factory default.

Item	Description
<ul style="list-style-type: none">• Scan Setup• Scan Default	Restores all of the scan options to the factory default.
System Setup	Restores all of the system options to the factory default.
Network Setup	Restores all of the network options to the factory default. (Reboot required.)
Address Book	Clears all of the email address entries stored in memory.
<ul style="list-style-type: none">• Fax Sent• Sent Report	Clears all records of sent faxes.
Email Sent	Clears all records of sent emails.
<ul style="list-style-type: none">• Fax Received• Fax RCV Report• Rcvd Report	Clears all records of received faxes.

System setup

Job manage



Some menus may not appear in the display depending on options or models. If so, it is not applicable to your machine (see "Menu overview" on page 29).

To change the menu options:

- Press  (**Menu**) > **System Setup** > **Job Manage** on the control panel.

Item	Description
Active Job	Shows the print job lists that are waiting to be printed.
Store Job	Shows the print job lists that are stored on the disk.
File Policy	If the memory already has the same name when you entered a new file name, you can rename or overwrite it.

Image overwrite



Some menus may not appear in the display depending on options or models. If so, it is not applicable to your machine (see "Menu overview" on page 29).

- Press  (**Menu**) > **System Setup** > **ImageOverwrite** on the control panel.

Item	Description
Manual	You can overwrite the embedded USB memory to clear all of the data stored in.

System setup

USB setup



Some menus may not appear in the display depending on options or models. If so, it is not applicable to your machine (see "Menu overview" on page 29).

- Press **USB** .

Option	Description
Print From	Views the file list from the File Navigation . Select a file to print.
Scan to USB	Sets scan destination to a USB. You scan the originals and save the scanned image to a USB device.
File Manage	Views the file list from the File Navigation . Select a file to delete. You can format the USB device.
Show Space	Shows the remaining space.

Emulation setup



Some menus may not appear in the display depending on options or models. If so, it is not applicable to your machine (see "Menu overview" on page 29).

- Press  (**Menu**) > **Print Setup** > **Emulation** on the control panel.

Item	Description
Emulation Type	The machine language defines how the computer communicates with the machine.
Setup	Sets the detailed settings for the selected emulation type.

System setup

Email setup



Some menus may not appear in the display depending on options or models. If so, it is not applicable to your machine (see "Menu overview" on page 29).

- Press **Setup > Machine Setup > Email Setup** .

Option	Description
SMTP Server	Sets the SMTP server configuration.
Send to Self	Sets to send the mail to yourself so that you can back up the email or use as a reminder.
Default To Address	Sets an email destination address as a default one.
Default From	Sets a sender's email address as a default one.
Default Subject	Sets an email's subject as a default one.

Address book setup



Some menus may not appear in the display depending on options or models. If so, it is not applicable to your machine (see "Menu overview" on page 29).

- Press **Setup > Machine Setup > Address Book** .

Option	Description
PhoneBook	Adds, views, prints or deletes the phone book list. You also can create a group.
Email	Adds, views, prints or deletes the email list. You also can create a group.

System setup

Document box setup



Some menus may not appear in the display depending on options or models. If so, it is not applicable to your machine (see "Menu overview" on page 29).

Doc Box Feature

- Press (Menu) > **Document Box** > **Doc Box Feature** on the control panel.

Option	Description
Add From Scan	Stores scanned documents in a box. The stored file will be named automatically as "yearmonthdayhourminutesecond".
Task From Box	Prints a document from a box.

Doc Box Setup

- Press (Menu) > **Document Box** > **Doc Box Setup** on the control panel.

Option	Description
Add From Scan	Sets the default options for storing the document to a box.
Task From Box	Sets the default options for printing the document from a box.

System setup

Network setup



Some menus may not appear in the display depending on options or models. If so, it is not applicable to your machine (see "Menu overview" on page 29).

- Press (**Menu**) > **Network** on the control panel,
- Or press **Setup** > **Machine Setup** > **Network Setup** .

Option	Description
TCP/IP (IPv4)	Selects the appropriate protocol and configure parameters to use the network environment. There are lots of parameters to be set. If you are not sure, leave as is, or consult the network administrator.
TCP/IP (IPv6)	Selects this option to use the network environment through IPv6 (see "IPv6 configuration" on page 147).
Ethernet Speed	Configure the network transmission speed.
802.1x	You can select the user authentication for network communication. For detailed information consult the network administrator.

Option	Description
Wireless	Selects this option to use the wireless network.
Clear Setting	Reverts the network settings to the default values. (Reboot required.)
<ul style="list-style-type: none">• Network Conf.• Network Configuration	This list shows information on your machine's network connection and configuration.
Net. Activate	You can set whether to use Ethernet on or off.



4. Special Features

This chapter explains special copying, scanning, faxing, and printing features.

- **Altitude adjustment** 206
- **Entering various characters** 207
- **Setting up the fax address book** 208
- **Printing features** 212
- **Scan features** 225
- **Fax features** 233
- **Using memory/hard drive features** 244



- The procedures in this chapter are mainly based on Windows 7.
- It may be necessary to press **OK** to navigate to lower-level menus for some models.

Altitude adjustment

Print quality is affected by atmospheric pressure, which is determined by the height of the machine above sea level. The following information will guide you on how to set your machine for the best print quality.

Before you set the altitude value, determine the altitude where you are.

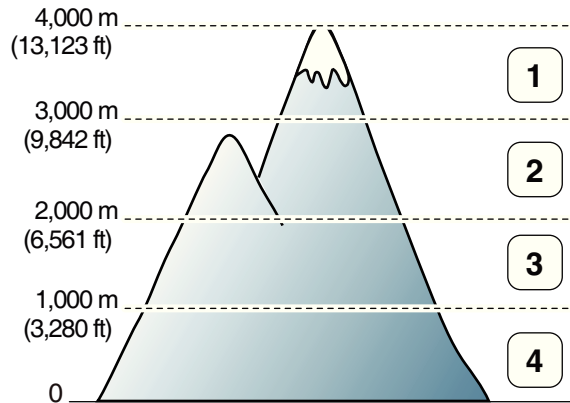

- 1 High 3
- 2 High 2
- 3 High 1
- 4 Normal

You can set the altitude value from **Device Settings** in Dell Printer Manager program or **Machine** section in Printer Settings Utility program.

- For Windows and Mac users, see "Device Settings" on page 253.



- You can also set the altitude in **System Setup** option on the machine's display (see "Machine's basic settings" on page 35).

Entering various characters

As you perform various tasks, you may need to enter names and numbers. For example, when you set up your machine, you enter your name or your company's name, and the fax number. When you store fax numbers or email addresses in memory, you may also enter the corresponding names.

Entering alphanumeric characters

Press the button until the correct letter appears on the display. For example, to enter the letter O, press 6, labeled with MNO. Each time you press 6, the display shows a different letter, M, N, O, m, n, o and finally 6. To find the letter that you want to enter, see "Keypad letters and numbers" on page 207.



- You can enter a space by pressing 1 twice.
- To delete the last digit or character, press the left/right or up/down arrow button.

Keypad letters and numbers



- Special character sets may differ from your machine depending on its options or the models.
- Some of the follow key values may not appear depending on the job you are doing.

Key	Assigned numbers, letters, or characters
1	@ / . ' 1
2	A B C a b c 2
3	D E F d e f 3
4	G H I g h i 4
5	J K L j k l 5
6	M N O m n o 6
7	P Q R S p q r s 7
8	T U V t u v 8
9	W X Y Z w x y z 9
0	& + - , 0
*	* % ^ _ ~ ! # \$ () [] (These symbols are available when you type for network authentication.)
#	# = ? " : { } < > ; (These symbols are available when you type for network authentication.)



Setting up the fax address book

Registering a speed dial number

1 Select  (fax) >  (**Address Book**) > **New&Edit** > **Speed Dial** on the control panel.

Or select **Setup** > **Machine Setup** > **Next** > **Address Book** > **Phone Book** > **View List** > **Individual** >  (options) > **Add** .

2 Enter a speed dial number and press **OK**.

 If an entry is already stored in the number you choose, the display shows the message to allow you to change it. To start over with another speed dial number, press  (**Back**).

3 Enter the name you want and press **OK**.



4 Enter the fax number you want and press **OK**.

5 Press the  (**Cancel** or **Stop/Clear**) button to return to ready mode.

Using speed dial numbers



When you are prompted to enter a destination number while sending a fax, enter the speed dial number at which you stored the number you want.









- For a one-digit (0-9) speed dial number, press and hold the corresponding digit button on the number keypad for more than 2 seconds.
- For a two- or three-digit speed dial number, press the first digit button(s) and then hold down the last digit button for more than 2 seconds.
- You can print the address book list by selecting  (fax) >  (**Address Book**) > **Print**.

Setting up the fax address book

Editing speed dial numbers



- 1 Select  (fax) >  (Address Book) > **New&Edit** > **Speed Dial** on the control panel.
Or select **Setup** > **Machine Setup** > **Next** > **Address Book** > **Phone Book** > **View List** > **Individual** .
- 2 Enter the speed dial number you want to edit and press **OK**.
- 3 Change the name and press **OK**.
- 4 Change the fax number and press **OK**.
- 5 Press  (**Cancel** or **Stop/Clear**) to return to ready mode.

Registering a group dial number

- 1 Select  (fax) >  (Address Book) > **New&Edit** > **Group Dial** on the control panel.
Or select **Setup** > **Machine Setup** > **Next** > **Address Book** > **Phone Book** > **View List** > **Group** >  (options) > **Add** .
 - 2 Enter a group dial number and press **OK**.
-  If an entry is already stored in the number you choose, the display shows the message to allow you to change it. To start over with another speed dial number, press  (**Back**).
- 3 Search by entering the first few letters of the speed dial's name to put in the group.
 - 4 Select the name and number you want and press **OK**.
 - 5 Select **Yes** when **Add?** appears.
 - 6 Repeat step 3 to include other speed dial numbers into the group.
 - 7 When you have finished, select **No** when **Another No.?** appears and press **OK**.
 - 8 Press  (**Cancel** or **Stop/Clear**) to return to ready mode.



Setting up the fax address book

Editing group dial numbers

- 1 Select  (fax) >  (**Address Book**) > **New&Edit** > **Group Dial** on the control panel.
Or select **Setup** > **Machine Setup** > **Next** > **Address Book** > **Phone Book** > **View List** > **Group** .
- 2 Enter the group dial number you want to edit and press **OK**.
- 3 Enter a new speed dial number to add and press **OK**, then **Add?** appears.
Enter a speed dial number stored in the group and press **OK**, **Delete?** appears.
- 4 Press **OK** to add or delete the number.
- 5 Repeat step 3 to add or delete more numbers.
- 6 Select **No** at the **Another No.?** and press **OK**.
- 7 Press  (**Cancel** or **Stop/Clear**) to return to ready mode.

Searching address book for an entry



There are two ways to search for a number in memory. You can either scan from A to Z sequentially, or you can search by entering the first letters of the name associated with the number.

- 1 Select  (fax) >  (**Address Book**) > **Search&Dial** > **Speed Dial** or **Group Dial** on the control panel.
- 2 Enter **All** or **ID** and press **OK**.
- 3 Press the name and number or the keypad button labeled with the letter you want to search.
For example, if you want to find the name "MOBILE," press the **6** button, which is labeled with "MNO."
- 4 Press  (**Cancel** or **Stop/Clear**) to return to ready mode.

Setting up the fax address book

Printing address book

You can check your  (**Address Book**) settings by printing a list.

- 1 Select  (fax) >  (**Address Book**) > **Print** on the control panel.
- 2 Press **OK**.
The machine begins printing.

Printing features



- For basic printing features, refer to the Basic Guide (see "Basic printing" on page 49).
- This feature may not be available depending on model or optional goods (see "Features by models" on page 7).

Changing the default print settings

- 1 Click the Windows **Start** menu.
- 2 Select **Control Panel > Devices and Printers**.
- 3 Right-click on your machine.
- 4 Select **Printing preferences**.



If **Printing preferences** has a ►, you can select other printer drivers connected to the selected printer.

- 5 Change the settings on each tab.
- 6 Click **OK**.



If you want to change the settings for each print job, change it in **Printing Preferences**.

Setting your machine as a default machine

- 1 Click the Windows **Start** menu.
- 2 Select **Control Panel > Devices and Printers**.
- 3 Select your machine.
- 4 Right-click your machine and select **Set as Default Printer**.



If **Printing preferences** has a ►, you can select other printer drivers connected to the selected printer.

Printing features

Using advanced print features



XPS printer driver: used to print XPS file format.

- See "Features by models" on page 7.
- The XPS printer driver can be installed only on Windows Vista OS or higher.
- Install optional memory when an XPS job does not print because the printer is out of memory.
- For models that provide XPS driver on the software CD:
 - You can install the XPS printer driver when you insert the software CD into your CD/DVD drive. When the installation window appears, select **Advanced Installation > Custom Installation**. You can select the XPS printer driver in the **Select Software and Utilities to Install** window.
- For models that provide XPS driver from the Dell website, www.Dell.com > find your product > Support or downloads.

Printing to a file (PRN)

You will sometimes need to save the print data as a file.

- 1 Check the **Print to file** box in the **Print** window.

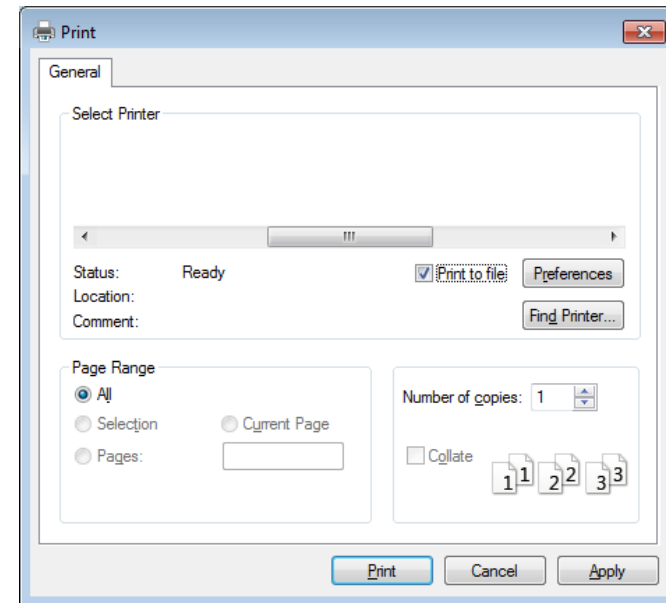

- 2 Click **Print**.
- 3 Type in the destination path and the file name, and then click **OK**.
For example, **c:\Temp\file name**.



If you type in only the file name, the file is automatically saved in **My Documents, Documents and Settings, or Users**. The saved folder may differ, depending on your operating system or the application you are using.

Printing features

Understanding special printer features

You can use advanced printing features when using your machine.



To take advantage of the printer features provided by your printer driver, click **Properties** or **Preferences** in the application's **Print** window to change the print settings. The machine name, that appears in the printer properties window may differ depending on the machine in use.



- Some menus may not appear on the display depending on options or models. If so, it is not applicable to your machine.
- Select the **Help** menu or click the  button from the window or press **F1** on your keyboard and click on any option you want to know about (see "Using help" on page 52).

Item	Description
<p data-bbox="51 815 315 887">Multiple Pages per Side</p> 	<p data-bbox="383 815 2175 887">Selects the number of pages to print on a single sheet of paper. To print more than one page per sheet, the pages will be reduced in size and arranged in the order you specify. You can print up to 16 pages on one sheet.</p>

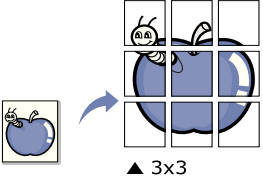
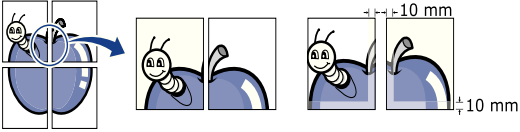
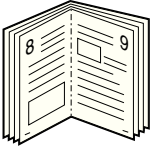

Printing features

Item	Description
<p>Poster Printing</p> 	<p>Prints a single-page document onto 4 (Poster 2x2), 9 (Poster 3x3), or 16 (Poster 4x4) sheets of paper, for the purpose of pasting the sheets together to form one poster-size document.</p> <p>Select the Poster Overlap value. Specify Poster Overlap in millimeters or inches by selecting the radio button on the upper right of Basic tab to make it easier to paste the sheets together.</p> 
<p>Booklet Printing^a</p> 	<p>Prints your document on both sides of a sheet of paper and arranges the pages so that the paper can be folded in half after printing to produce a booklet.</p> <ul style="list-style-type: none">• If you want to make a booklet, you need to print on Letter, Legal, A4, US Folio, or Oficio sized print media.• The Booklet Printing option is not available for all paper sizes. Select the available paper Size option under the Paper tab to see what paper sizes are available.• If you select an unavailable paper size, this option can be automatically canceled. Select only available paper (paper without  or  mark).
<ul style="list-style-type: none">• Double-sided Printing• Double-sided Printing (Manual)^a	<p>Print on both sides of a sheet of paper (duplex). Before printing, decide how you want your document oriented.</p> <ul style="list-style-type: none">• You can use this feature with Letter, Legal, A4, US Folio or Oficio sized paper• If your machine does not have a duplex unit, you should complete the printing job manually. The machine prints every other page of the document first. After that, a message appears on your computer.• Skip Blank Pages feature does not work when you select the duplex option.

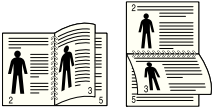
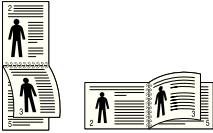
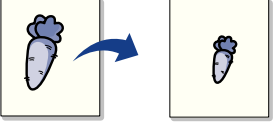
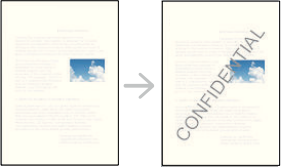
Printing features

Item	Description
<ul style="list-style-type: none"> • Double-sided Printing • Double-sided Printing (Manual)^a 	<ul style="list-style-type: none"> • Printer Default: If you select this option, this feature is determined by the settings you have selected on the control panel of the machine. This option is available only when you use the PCL/XPS printer driver. • None: Disables this feature. • Long Edge: This option is the conventional layout used in bookbinding.  • Short Edge: This option is the conventional layout used in calendars.  • Reverse Double-Sided Printing: Check this option to reverse the print order when duplex printing. This option is not available when you use Double-sided Printing (Manual).
<p>Paper Options</p> 	<p>Changes the size of a document to appear larger or smaller on the printed page by entering in a percentage by which to enlarge or decrease the document.</p>
<p>Watermark</p> 	<p>The watermark option allows you to print text over an existing document. For example, you use it when you want to have large gray letters reading "DRAFT" or "CONFIDENTIAL" printed diagonally across the first page or all pages of a document.</p>

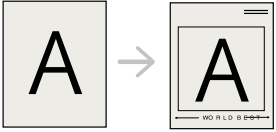

Printing features

Item	Description
Watermark (Creating a watermark)	<p>a To change the print settings from your software application, access Printing Preferences.</p> <p>b Click the Advanced tab, select Edit from the Watermark drop-down list. The Edit Watermarks window appears.</p> <p>c Enter a text message in the Watermark Message box. You can enter up to 256 characters. The message displays in the preview window.</p>
Watermark (Editing a watermark)	<p>a To change the print settings from your software application, access Printing Preferences.</p> <p>b Click the Advanced tab, select Edit from the Watermark drop-down list. The Edit Watermarks window appears.</p> <p>c Select the watermark you want to edit from the Current Watermarks list and change the watermark message and options.</p> <p>d Click Update to save the changes.</p> <p>e Click OK or Print until you exit the Print window.</p>
Watermark (Deleting a watermark)	<p>a To change the print settings from your software application, access Printing Preferences.</p> <p>b Click the Advanced tab, select Edit from the Watermark drop-down list. The Edit Watermarks window appears.</p> <p>c Select the watermark you want to delete from the Current Watermarks list and click Delete.</p> <p>d Click OK or Print until you exit the Print window.</p>
Overlay^a 	<p>This option is available only when you use the PCL/SPL printer driver (see "Software" on page 7).</p> <p>An overlay is text and/or images stored in the computer hard disk drive (HDD) as a special file format that can be printed on any document. Overlays are often used to take the place of letterhead paper. Rather than using preprinted letterhead, you can create an overlay containing exactly the same information that is currently on your letterhead. To print a letter with your company's letterhead, you do not need to load preprinted letterhead paper in the machine: just print the letterhead overlay on your document.</p> <p>To use a page overlay, you must create a new page overlay containing your logo or image.</p> <div data-bbox="383 1230 2197 1390"><ul style="list-style-type: none">• The overlay document size must be the same as the document you print with the overlay. Do not create an overlay with a watermark.• The resolution of the overlay document must be the same as that of the document you will print with the overlay.</div>

Printing features

Item	Description
Overlay^a (Creating a new page overlay)	<p>a To save the document as an overlay, access Printing Preferences.</p> <p>b Click the Advanced tab, and select Edit from the Text drop-down list. Edit Overlay window appears.</p> <p>c In the Edit Overlay window, click Create.</p> <p>d In the Save As window, type a name up to eight characters in the File name box. Select the destination path, if necessary (The default is C:\Formover).</p> <p>e Click Save. The name appears on the Overlay List.</p> <p>f Click OK or Print until you exit the Print window. The file is not printed. Instead, it is stored on your computer hard disk drive.</p>
Overlay^a (Using a page overlay)	<p>a Click the Advanced tab.</p> <p>b Select the desired overlay from the Text drop-down list.</p> <p>c If the overlay file you want does not appear in the Text drop-down list, select Edit... from the list and click Load. Select the overlay file you want to use. If you have stored the overlay file you want to use in an external source, you can also load the file when you access the Open window. After you select the file, click Open. The file appears in the Overlay List box and is available for printing. Select the overlay from the Overlay List box.</p> <p>d If necessary, check Confirm Page Overlay When Printing box. If this box is checked, a message window appears each time you submit a document for printing, asking you to confirm printing an overlay on your document. If this box is not checked and an overlay has been selected, the overlay automatically prints with your document.</p> <p>e Click OK or Print until you exit the Print window.</p>
Overlay^a (Deleting a page overlay)	<p>a In the Printing Preferences window, click the Advanced tab.</p> <p>b Select Edit in the Text drop down list.</p> <p>c Select the overlay you want to delete from the Overlay List box.</p> <p>d Click Delete.</p> <p>e When a confirming message window appears, click Yes.</p> <p>f Click OK or Print until you exit the Print window. You can delete page overlays that you no longer use.</p>

Printing features

Item	Description
Print Mode	<div data-bbox="398 284 2197 440" style="background-color: #f0f0f0; padding: 5px;"><ul style="list-style-type: none">• This feature is available only if you have installed the optional memory or mass storage device (HDD) (see "Variety feature" on page 7).• Some menus may not appear on the display depending on options or models. If so, it is not applicable to your machine.</div> <ul style="list-style-type: none">• Print Mode: The default Print Mode is Normal, which is for printing without saving the printing file in the memory.<ul style="list-style-type: none">- Normal: This mode prints without storing your document in the optional memory.- Proof: This mode is useful when you print more than one copy. You can print one copy first to check, then print the rest of the copies later.- Confidential: This mode is used for printing confidential documents. You need to enter a password to print.- Store: Select this setting to save a document in the mass storage device (HDD) without printing.- Store and Print: This mode is used when printing and storing document at the same time.- Spool: This option can be useful when handling large amounts of data. If you select this setting, the printer spools the document into the mass storage device (HDD) and then prints it from the mass storage device (HDD) queue, decreasing the computer's work load.- Print Schedule: Select this setting to print the document at a specified time.• User ID: This option is used when you need to find a saved file using the control panel.• Job Name: This option is used when you need to find a saved file using the control panel.
Job Encryption	<p data-bbox="383 1002 2192 1070">Encrypts printing data first, and transmits it to the machine. This feature protects the printing information even though the data is snatched on a network.</p> <div data-bbox="383 1129 2192 1286" style="background-color: #f0f0f0; padding: 5px;"><p>Job Encryption feature is enabled only when the mass storage device (HDD) is installed. The mass storage device (HDD) is used to decrypt the printing data (see "Variety feature" on page 7).</p></div>

a. This option is not available when you use XPS driver.

Printing features

Using Direct Printing Utility



- Direct Printing Utility may not be available depending on model or optional goods (see "Software" on page 7).
- Available for Windows OS users only.

What is Direct Printing Utility?

Direct Printing Utility is a program that sends the PDF files directly to your machine to print without having to opening the file.

To install this program, select **Advanced Installation > Custom Installation** and put a check mark in this program when you install the printer driver.



- Mass storage device (HDD) should be installed on your machine, to print files using this program. (see "Variety feature" on page 7).
- You cannot print PDF files that are restricted. Deactivate the printing restriction feature and retry printing.
- You cannot print PDF files that are restricted by a password. Deactivate the password feature, and retry printing.
- Whether or not a PDF file can be printed using the Direct Printing Utility program depends on how the PDF file was created.?
- The Direct Printing Utility program supports PDF version 1.7 and below. For higher versions, you must open the file to print it.

Printing

There are several ways you can print using the Direct Printing Utility.

- 1 From the **Start** menu select **Programs** or **All Programs > Dell Printers > Direct Printing Utility > Direct Printing Utility**.

The Direct Printing Utility window appears.

- For Windows 8, from **Charms**, select **Search > Apps**.

- 2 Select your machine from the **Select Printer** drop-down list and click **Browse**.

- 3 Select the file you wish to print and click **Open**.

The file is added in the **Select Files** section.

- 4 Customize the machine settings for your needs.

- 5 Click **Print**. The selected PDF file is sent to the machine.

Printing features

Using the right-click menu

- 1 Right-click on the PDF file to print and select **Direct Printing**.
The Direct Printing Utility window appears with the PDF file is added.
- 2 Select the machine to use.
- 3 Customize the machine settings.
- 4 Click **Print**. The selected PDF file is sent to the machine.

Mac printing



Some features may not be available depending on models or options. It means that the features are not supported.

Printing a document

When you print with a Mac, you need to check the printer driver settings in each application you use. Follow the steps below to print from a Mac:

- 1 Open the document to print.
- 2 Open the **File** menu and click **Page Setup (Document Setup** in some applications).
- 3 Choose your paper size, orientation, scaling, other options, and make sure that your machine is selected. Click **OK**.
- 4 Open the **File** menu and click **Print**.
- 5 Choose the number of copies and indicate which pages to print.
- 6 Click **Print**.

Printing features

Changing printer settings

You can use advanced printing features when using your machine.

Open an application and select **Print** from the **File** menu. The machine name, which appears in the printer properties window, may differ depending on the machine in use. Except for the name, the composition of the printer properties window is similar to the following.

Printing multiple pages on one sheet

You can print more than one page on a single sheet of paper. This feature provides a cost-effective way to print draft copies.

- 1 Open an application, and select **Print** from the **File** menu.
- 2 Select **Layout** from the drop-down list under **Orientation**. In the **Pages per Sheet** drop-down list, select the number of pages you want to print on one sheet of paper.
- 3 Select the other options to use.
- 4 Click **Print**.

The machine prints the selected number of pages to print on one sheet of paper.

Printing on both sides of the paper



Some features may not be available depending on models or options. It means that the features are not supported (see "Variety feature" on page 7).

Before printing in the duplex mode, decide on which edge you will be binding your finished document. The binding options are, as follows:

- **Long-Edge Binding:** This option is the conventional layout used in book binding.
- **Short-Edge Binding:** This option is the type often used with calendars.

- 1 From your Mac application, select **Print** from the **File** menu.
- 2 Select **Layout** from the drop-down list under **Orientation**.
- 3 Select a binding orientation from the **Two-Sided** option.
- 4 Select the other options to use.
- 5 Click **Print** and the machine prints on both sides of the paper.



If you print more than 2 copies, the first copy and the second copy might print on the same sheet of paper. Avoid printing on both sides of paper when you are printing more than 1 copy.

Printing features

Using help

Click the question mark on the bottom-left corner of the window and click on the topic you want to know about. A pop-up window appears with information about that option's feature, which is provided from the driver.

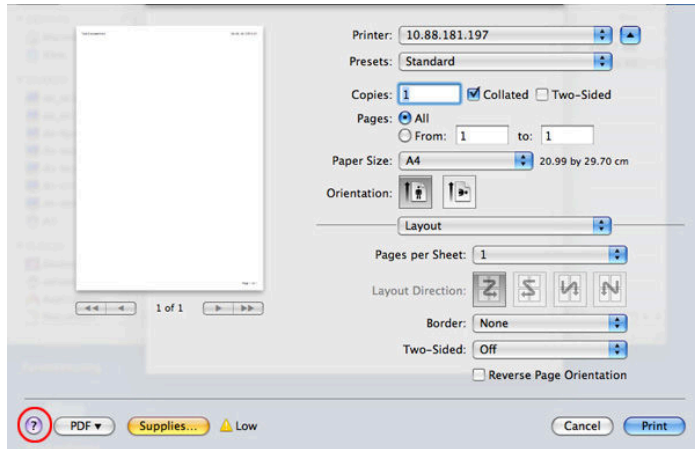

Linux printing



Some features may not be available depending on models or options. It means that the features are not supported.

Printing from applications

There are a lot of Linux applications that allow you to print using Common UNIX Printing System (CUPS). You can print on your machine from any such application.

- 1 Open the document to print
- 2 Open the **File** menu and click **Page Setup** (**Print Setup** in some applications).
- 3 Choose your paper size, orientation, and make sure that your machine is selected. Click **Apply**.
- 4 Open the **File** menu and click **Print**.
- 5 Select your machine to print.
- 6 Choose the number of copies and indicate which page to print.

Printing features

7 Change other printing options in each tab, if necessary.

8 Click **Print**.



Automatic/manual duplex printing may not be available depending on models. You can alternatively use the lpr printing system or other applications for odd-even printing.

Printing files

You can print many different types of files on your machine using the standard CUPS, directly from the command line interface. The CUPS lpr utility allows you to do that. You can print these files by using the command format below.

lp -d <printer name> -o <option> <file name>

Please refer to lp or man page on your system for more details.

Configuring Printer Properties

Using the **Printer Properties** window provided by the **Printers configuration**, you can change the various properties for your machine as a printer.

1 Open the **Unified Driver Configurator**.

If necessary, switch to **Printers configuration**.

2 Select your machine on the available printers list and click **Properties**.

3 The **Printer Properties** window appears.

The following five tabs display at the top of the window:

- **General:** Allows you to change the printer location and name. The name entered in this tab displays on the printer list in **Printers configuration**.
- **Connection:** Allows you to view or select another port. If you change the machine port from USB to parallel or vice versa while in use, you must re-configure the machine port in this tab.
- **Driver:** Allows you to view or select another machine driver. By clicking **Options**, you can set the default device options.
- **Jobs:** Shows the list of print jobs. Click **Cancel job** to cancel the selected job and select the **Show completed jobs** check box to see previous jobs on the job list.
- **Classes:** Shows the class that your machine is in. Click **Add to Class** to add your machine to a specific class or click **Remove from Class** to remove the machine from the selected class.

4 Click **OK** to apply the changes and close the **Printer Properties** window.

Scan features



- For basic scanning features, refer to the Basic Guide (see "Basic scanning" on page 59).
- This feature may not be available depending on model or optional goods (see "Features by models" on page 7).
- The maximum resolution that can be achieved depends upon various factors, including computer speed, available disk space, memory, the size of the image being scanned, and bit depth settings. Thus, depending on your system and what you are scanning, you may not be able to scan at certain resolutions, especially using enhanced dpi.

Basic scanning method



- This feature may not be available depending on model or optional goods (see "Variety feature" on page 7).

You can scan the originals with your machine via an USB cable or the network. The following methodologies can be used for scanning your documents:

- **Scan to PC:** Scan the originals from the control panel. Then, the scanned data will be stored in the connected computers **My Documents** folder (see "Basic Scanning" on page 59).

- **TWAIN:** TWAIN is the one of a preset imaging applications. Scanning an image launches the selected application, enabling you to control the scanning process. This feature can be used via the local connection or the network connection (see "Scanning from image editing program" on page 227).
- **Dell Scan Assistant/Dell Document Creator:** You can use this program to scan images or documents.
 - See "Scanning with Dell Scan Assistant" on page 228.
- **WIA:** WIA stands for Windows Images Acquisition. To use this feature, your computer must be connected directly with the machine via an USB cable (see "Scanning using the WIA driver" on page 228).
- **USB Memory:** You can scan a document and save the scanned image onto an USB memory device.
- **Email:** You can send the scanned image as an email attachment.
- **FTP/SMB:** You can scan an image and upload it to an FTP/SMB server.

Scan features

Setting the scan settings in the computer



This feature may not be available depending on model or optional goods (see "Features by models" on page 7).

- 1 Open **Dell Printer Manager** (see "Using Dell Printer Manager" on page 251).
- 2 Select the appropriate machine from the **Printer List**.
- 3 Select **Scan to PC Settings** menu.
- 4 Select the option you want.
 - **Scan Activation:** Determines whether or not scanning is enabled on the device.
 - **Basic** tab: Contains settings related to general scan and device settings.
 - **Image** tab: Contains settings related to image altering.
- 5 Press **Save** > **OK**.

Scanning from network connected machine



The machine that does not support the network interface, it will not be able to use this feature (see "Rear view" on page 20).

Make sure the printer driver is installed on your computer using the software CD, since the printer driver includes the scan program (see "Installing the driver locally" on page 24).

- 1 Place a single document face down on the document glass, or load the documents face up into the document feeder (see "Loading originals" on page 46).
- 2 Select  (**Scan**) > **Scan to PC** > **Network PC** on the control panel.
Or select **Scan** > **Network PC**.





If you see **Not Available** message, check the port connection.

- 3 Select your registered computer **ID**, and enter the **Password** if necessary.

Scan features



- **ID** is the same ID as the registered scan ID for **Dell Printer Manager** >  Switch to advanced mode > **Scan to PC Settings**.
- **Password** is the 4 digit number registered password for **Dell Printer Manager** >  Switch to advanced mode > **Scan to PC Settings**.

4 Select the option you want and press **OK**.

5 Scanning begins.



Scanned image is saved in computer's **C:\Users\users name\My Documents**. The saved folder may differ, depending on your operating system or the application you are using.

Scanning from image editing program

You can scan and import documents at the image editing software such as Adobe Photoshop, if the software is TWAIN-compliant. Follow the steps below to scan with TWAIN-compliant software:

- 1** Make sure that the machine is connected to your computer and powered on.
- 2** Place a single document face down on the document glass, or load the documents face up into the document feeder (see "Loading originals" on page 46).
- 3** Open an application, such as Adobe Photoshop.
- 4** Click **File** > **Import**, and select the scanner device.
- 5** Set the scan options.
- 6** Scan and save your scanned image.

Scan features

Scanning using the WIA driver

Your machine supports the Windows Image Acquisition (WIA) driver for scanning images. WIA is one of the standard components provided by Microsoft Windows 7 and works with digital cameras and scanners. Unlike the TWAIN driver, the WIA driver allows you to scan and easily adjust images without using additional software:



The WIA driver works only on Windows OS (not supported Windows 2000) with a USB port.

- 1 Make sure that the machine is connected to your computer and powered on.
- 2 Place a single document face down on the document glass, or load the documents face up into the document feeder (see "Loading originals" on page 46).
- 3 Click **Start > Control Panel > Hardware and Sound > Devices and Printers**.
- 4 Right-click on device driver icon in **Printers and Faxes > Start Scan**.
- 5 **New Scan** application appears.

- 6 Choose your scanning preferences and click **Preview** to see your preferences affect the picture.
- 7 Scan and save your scanned image.

Scanning with Dell Scan Assistant



- This feature may not be available depending on model or optional goods (see "Features by models" on page 7).
- For Windows, you need to download Scan Assistant from the Dell website to install the printer software (<http://www.Dell.com> > find your product > Support or Downloads). For Mac, open the **Applications** folder > **Dell** folder > **DellScan Assistant**.
- For Windows, you can use the OCR (Optical Character Reader) feature from Dell Scan Assistant program.

- 1 Download the software from the Dell website then unpack and install it.
- 2 Make sure that the machine is connected to your computer and powered on.
- 3 Place a single document face down on the document glass, or load the documents face up into the document feeder (see "Loading originals" on page 46).

Scan features

- 4 Click **Start** > **All programs** > **Dell Printers**, and start **Dell Scan Assistant**.

 Select the **Help** menu from the window and click on any option you want to know about.

- 5 Set the scan options.

- 6 Click **Scan**.

Mac scanning

Scanning from USB connected machine

- 1 Make sure that the machine is connected to your computer and powered on.
- 2 Place a single document face down on the document glass, or load the documents face up into the document feeder (see "Loading originals" on page 46).
- 3 Start **Applications** and click **Image Capture**.



If **No Image Capture device connected** message appears, disconnect the USB cable and reconnect it. If the problem continues, refer to the **Image Capture's** help.

- 4 Select the option you want.

- 5 Scan and save your scanned image.



If scanning does not operate in **Image Capture**, update Mac OS to the latest version.

Scanning from network connected machine



Network or wireless model only (see "Features by models" on page 7).

- 1 Make sure that your machine is connected to a network.
- 2 Place a single document face down on the document glass, or load the documents face up into the document feeder (see "Loading originals" on page 46).
- 3 Start **Applications** and click **Image Capture**.

Scan features

4 According to OS, follow steps below.

- For 10.5
 - Click **Devices > Browse Devices** on Menu bar.
 - Make sure that **Connected** checkbox is checked beside your machine in **Bonjour Devices**.
 - If you want to scan using TWAIN, refer to the Mac OS X10.4 steps above.
- For 10.6 -10.8, select your device below **SHARED**.

5 Set the scan options on this program.

6 Scan and save your scanned image.



- If scanning does not operate in Image Capture, update Mac OS to the latest version.
- For more information, refer to the **Image Capture's** help.
- You can also scan using TWAIN-compliant software, such as Adobe Photoshop.

Linux scanning

Scanning

- 1 Make sure that the machine is connected to your computer and powered on.
- 2 Double-click the **Unified Driver Configurator** on your desktop.
- 3 Click the  button to switch to Scanners Configuration.

Scan features

- 4 Select the scanner on the list.

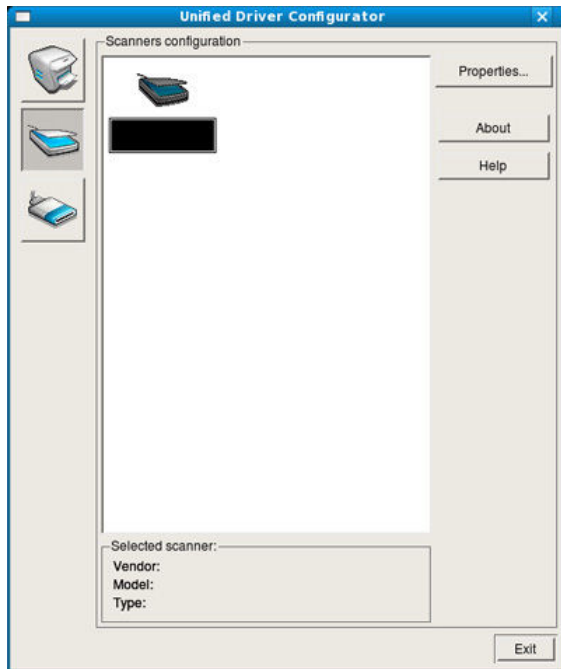

- 5 Click **Properties**.

- 6 Place a single document face down on the document glass, or load the documents face up into the document feeder (see "Loading originals" on page 46).

- 7 From the **Scanner Properties** window, click **Preview**.

- 8 The document is scanned and the image preview appears in the **Preview Pane**.

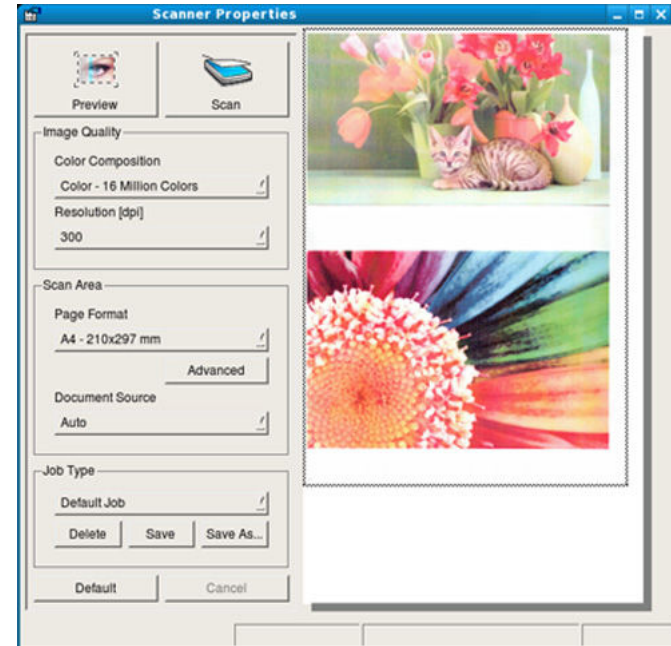

- 9 Drag the pointer to set the image area to be scanned in the **Preview Pane**.

- 10 Select the option you want.

- 11 Scan and save your scanned image.



For later use, you can save as your scan settings and add it to the **Job Type** drop-down list.

Scan features

Editing an image with Image Manager

The Image Manager application provides you with menu commands and tools to edit your scanned image.

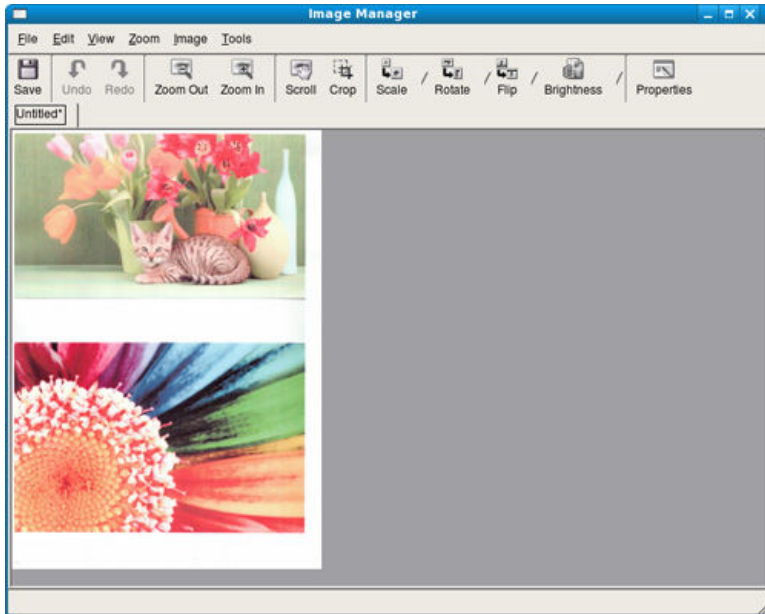



Fax features





- For basic faxing features, refer to the Basic Guide (see "Basic faxing" on page 60).

Automatic redialing

When the number you have dialed is busy or there is no answer when you send a fax, the machine automatically redials the number. The redial time depends on the country's factory default setting.

When the display shows **Retry Redial?**, press  (**Start**) button to redial the number without waiting. To cancel the automatic redialing, press  (**Cancel** or **Stop/Clear**).

To change the time interval between redials and the number of redial attempts.

- 1 Press  (fax) >  (**Menu**) > **Fax Setup** > **Sending** on the control panel.
- 2 Select **Redial Times** or **Redial Term** you want.
- 3 Select the option you want.

Redialing the fax number

- 1 Press  (**Redial/Pause**) button on the control panel.
- 2 Select the fax number you want.
Ten recently sent fax numbers with ten received Caller IDs are shown.
- 3 When an original is loaded in the document feeder, the machine automatically begins to send.
If an original is placed on the scanner glass, select **Yes** to add another page. Load another original and press **OK**. When you have finished, select **No** when **Another Page?** appears.



Confirming a transmission

When the last page of your original has been sent successfully, the machine beeps and returns to ready mode.

When something goes wrong while sending your fax, an error message appears on the display. If you receive an error message, press  (**Cancel** or **Stop/Clear**) to clear the message and try to send the fax again.

Fax features



You can set your machine to print a confirmation report automatically each time sending a fax is completed. Press  (fax) >  (**Menu**) > **Fax Setup** > **Sending** > **Send Report** on the control panel.

Sending a fax in the computer



- This feature may not be available depending on model or optional goods (see "Features by models" on page 7).

You can send a fax from your computer without going to the machine.

To send a fax from your computer, the **Dell Network PC Fax** program must be installed. This program will be installed when you installed the printer driver.

- 1 Open the document to be sent.
- 2 Select **Print** from the **File** menu.
The **Print** window will be displayed. It may look slightly different depending on your application.
- 3 Select **Dell Network PC Fax** from the **Print** window
- 4 Click **Print** or **OK**.

- 5 Enter the recipients' numbers and select the option

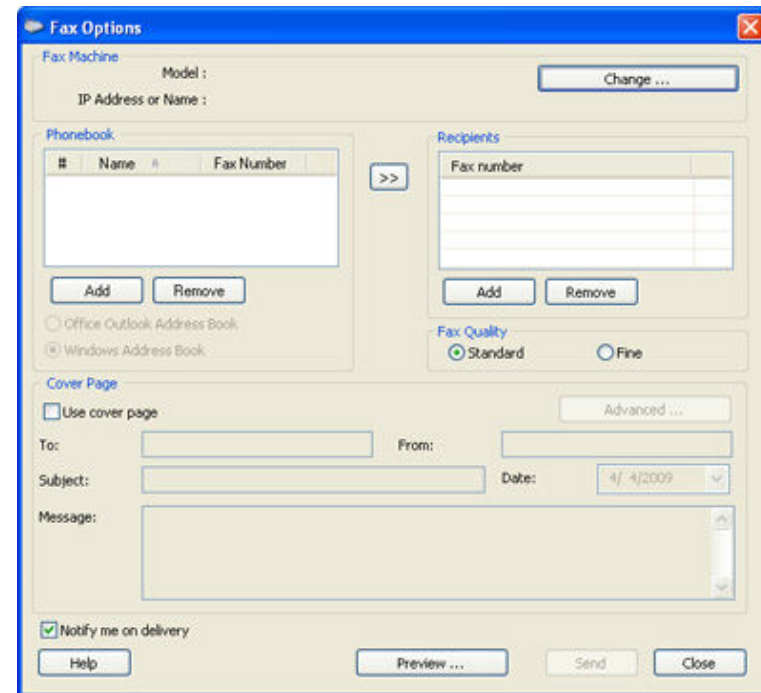



Select the **Help** menu or from the window and click on any option you want to know about.

- 6 Click **Send**.

Fax features

Delaying a fax transmission

You can set your machine to send a fax at a later time when you will not be present. You cannot send a color fax using this feature.

- 1 Place a single document face down on the document glass, or load the documents face up into the document feeder.
- 2 Press  (fax) on the control panel.
- 3 Adjust the resolution and the darkness to suit your fax needs.
- 4 Press  (**Menu**) > **Fax Feature** > **Delay Send** on the control panel.
Or select **Fax** > **Delayed Send** > **To** .
- 5 Enter the number of the receiving fax machine and press **OK**.
- 6 The display asks you to enter another fax number to send the document.
- 7 To enter more fax numbers, press **OK** when **Yes** highlights and repeat steps 5.



- You can add up to 10 destinations.
- Once you entered a group dial number, you cannot enter another group dial numbers anymore.

- 8 Enter the job name and the time.



If you set a time earlier than the current time, the fax will be sent at that time on the following day.

- 9 The original is scanned into memory before transmission.

The machine returns to ready mode. The display reminds you that you are in ready mode and that a delayed fax is set.





You can check the list of delayed fax jobs.



Press  (**Menu**) > **System Setup** > **Report** > **Schedule Jobs** on the control panel.

Fax features

Adding documents to a reserved fax



- 1 Place a single document face down on the document glass, or load the documents face up into the document feeder.
- 2 Press  (fax) >  (**Menu**) > **Fax Feature** > **Add Page** on the control panel.
- 3 Select the fax job and press **OK**.
When you have finished, select **No** when **Another Page?** appears. The machine scans the original into memory.
- 4 Press  (**Cancel** or **Stop/Clear**) to return to ready mode.

Canceling a reserved fax job

- 1 Press  (fax) >  (**Menu**) > **Fax Feature** > **Cancel Job** on the control panel.
- 2 Select the fax job you want and press **OK**.
- 3 Press **OK** when **Yes** highlights.
The selected fax is deleted from memory.
- 4 Press  (**Stop/Clear**) to return to ready mode.

Sending a priority fax

This function is used when a high priority fax need to be sent ahead of reserved operations. The original is scanned into memory and immediately transmitted when the current operation is finished.

- 1 Place a single document face down on the document glass, or load the documents face up into the document feeder.
- 2 Press  (**Fax**) >  (**Menu**) > **Fax Feature** > **Priority Send** on the control panel.
Or select **Fax** > **Priority Send** > **To** .
- 3 Enter the destination fax number and press **OK**.
- 4 Enter the job name and press **OK**.
- 5 If an original is placed on the scanner glass, select **Yes** to add another pages. Load another original and press **OK**.
When you have finished, select **No** when **Another Page?** appears.
The machine starts to scan and send a fax to destinations.

Fax features

Forwarding a sent fax to another destination

You can set the machine to forward the received or sent fax to other destination by a fax. If you are out of office but have to receive the fax, this feature may be useful.



- Though you sent or received a color fax, the data is forwarded in grayscale.

- 1 Place a single document face down on the document glass, or load the documents face up into the document feeder.
- 2 Press (fax) > (**Menu**) > **Fax Feature** > **Forward** > **Fax** > **Send Forward** > **On** on the control panel.
Or select **Setup** > **Machine Setup** > **Fax Setup** > **Forward** > **Fax** > **Send Forward** > **On** .



Forward options may not be available depending on model or optional goods (see "Variety feature" on page 7).

- 3 Enter the destination fax number, email address, or server address and press **OK**.

- 4 Press (**Cancel** or **Stop/Clear**) to return to ready mode.

Subsequent sent faxes will be forwarded to the specified fax machine.

Forwarding a received fax

You can set the machine to forward the received or sent fax to other destination by a fax. If you are out of office but have to receive the fax, this feature may be useful.



Though you sent or received a color fax, the data is forwarded in grayscale.

- 1 Press (fax) > (**Menu**) > **Fax Feature** > **Forward** > **Fax** > **Receive Forward** or **RCV Forward** > **Forward** on the control panel.
Or select **Setup** > **Machine Setup** > **Fax Setup** > **Forward** > **Fax** > **Receive Forward** or **RCV Forward** > **On** .



- **Forward** options may not be available depending on model or optional goods (see "Variety feature" on page 7).
- To set the machine to print out a fax when fax forwarding has been completed, select **Forward&Print**.

- 2 Enter the destination fax number, email address, or server address and press **OK**.

Fax features

- 3 Enter the starting time and ending time, then press **OK**.
- 4 Press  (**Cancel** or **Stop/Clear**) to return to ready mode.
Subsequent sent faxes will be forwarded to the specified fax machine.

Sending faxes on both sides of paper



- This is available only when you load originals into the document feeder.
- Some menus may not appear on the display depending on options or models. If so, it is not applicable to your machine.
- This feature may not be available depending on model or optional goods (see "Features by models" on page 7).



- 1 Place a single document face down on the document glass, or load the documents face up into the document feeder.
- 2 Press  (fax) > **Duplex** on the control panel.
Or select **Fax** > Select the menu you want > Select **Duplex** from the sub-menus > .
 - **Off:** Send faxes in normal mode.
 - **2 Side:** Send faxes on both sides of the original.

- **2->1Side ROT2:** Send faxes on both sides of the original and prints each one on a separate sheet, but the information on the back side of the printout is rotated 180°.

- 3 Press **OK**.

Receiving a fax in the computer



- This feature may not be available depending on model or optional goods (see "Features by models" on page 7).
- To use this feature, set the option on the control panel:
Press  (fax) >  (**Menu**) > **Fax Feature** > **Forward** > **PC** > **On** on the control panel.
Or select **Setup** > **Machine Setup** > **Next** > **Fax Setup** > **Forward** > **PC** > **On** .

- 1 Open the Dell Printer Manager.
- 2 Select the appropriate machine from the **Printer List**.
- 3 Select **Fax to PC Settings** menu.
- 4 Use **Enable Fax Receiving from Device** to change the fax settings.
 - **Image Type:** Convert the received faxes to PDF or TIFF.
 - **Save Location:** Select location to save the converted faxes.

Fax features

- **Prefix:** Select prefix.
- **Print received fax:** After receiving the fax, set prints information for the received fax.
- **Notify me when complete:** Set to show the popup window to notify receiving a fax.
- **Open with default application:** After receiving the fax, open it with default application.
- **None:** After receiving a fax, the machine does not notify the user or opens the application.



5 Press **Save** > **OK**.

Changing the receive modes

1 Press  (fax) >  (**Menu**) > **Fax Setup** > **Receiving** > **Receive Mode** on the control panel.

Or select **Setup** > **Machine Setup** > **Next** > **Default Setting** > **Fax Default** > **Common** > **Receive Mode**.

2 Select the option you want.

- **Fax:** Answers an incoming fax call and immediately goes into the fax reception mode.
- **Tel:** Receives a fax by pressing  (**On Hook Dial**) and then  (**Start**) button.

- **Ans/Fax:** Is for when an answering machine attached to your machine. Your machine answers an incoming call, and the caller can leave a message on the answering machine. If the fax machine senses a fax tone on the line, the machine automatically switches to Fax mode to receive the fax.



To use the **Ans/Fax** mode, attach an answering machine to the EXT socket on the back of your machine.

- **DRPD:** You can receive a call using the Distinctive Ring Pattern Detection (DRPD) feature. Distinctive Ring is a telephone company service which enables an user to use a single telephone line to answer several different telephone numbers. For further details, see "Receiving faxes using DRPD mode" on page 240.



This setting may not be available depending on your country.

3



Press **OK**.

4

Press  (**Cancel** or **Stop/Clear**) to return to ready mode.

Fax features

Receiving manually in Tel mode

You can receive a fax call by pressing  (**On Hook Dial**) button and then pressing  (**Start**) when you hear a fax tone. If your machine has a handset, you can answer calls using the handset (see "Features by models" on page 7).

Receiving in Answering Machine/Fax mode

To use this mode, you must attach an answering machine to the EXT socket on the back of your machine. If the caller leaves a message, the answering machine stores the message. If your machine detects a fax tone on the line, it automatically starts to receive the fax.



- If you have set your machine to this mode and your answering machine is switched off, or no answering machine is connected to EXT socket, your machine automatically goes into Fax mode after a predefined number of rings.
- If the answering machine has a user-selectable ring counter, set the machine to answer incoming calls within 1 ring.
- If the machine is in Tel mode, disconnect or switch off the answering machine with the fax machine. Otherwise, the outgoing message from the answering machine will interrupt your phone conversation.

Receiving faxes with an extension telephone

When you are using an extension telephone connected to the EXT socket, you can receive a fax from someone you are talking to on the extension telephone, without going to the fax machine.

When you receive a call on the extension phone and hear fax tones, press the keys ***9*** on the extension phone. The machine receives the fax.

9 is the remote receive code preset at the factory. The first and the last asterisks are fixed, but you can change the middle number to whatever you want.



While you are talking over the telephone connected to the EXT socket, copy and scan features are not available.



Receiving faxes using DRPD mode

This setting may not be available depending on your country. Distinctive Ring is a telephone company service which enables an user to use a single telephone line to answer several different telephone numbers. This feature is often used by answering services who answer telephones for many different clients and need to know which number someone is calling in on to properly answer the phone.

Fax features



This setting may not be available depending on your country.

- 1 Select  (fax) >  (**Menu**) > **Fax Setup** > **Receiving** > **DRPD Mode** > **Waiting Ring** on the control panel.

Or select **Setup** > **Machine Setup** > **Next** > **Default Setting** > **Fax Default** > **Common** > **Receive Mode** > **DRPD** .

- 2 Call your fax number from another telephone.
- 3 When your machine begins to ring, do not answer the call. The machine requires several rings to learn the pattern.

When the machine completes learning, the display shows **Completed DRPD Setup**. If the DRPD setup fails, **Error DRPD Ring** appears.

- 4 Press **OK** when DRPD appears and start over from step 2.



- DRPD must be set up again if you re-assign your fax number, or connect the machine to another telephone line.
- After DRPD has been set up, call your fax number again to verify that the machine answers with a fax tone. Then have a call placed to a different number assigned to that same line to be sure the call is forwarded to the extension telephone or answering machine plugged into the EXT socket.



Receiving in secure receiving mode



This feature may not be available depending on model or optional goods (see "Features by models" on page 7).

You may need to prevent your received faxes from being accessed by unauthorized people. Turn on secure receiving mode, then all incoming faxes go into memory. You can print the incoming faxes with entering the password.



To use the secure receiving mode, activate the menu from  (fax) >  (**Menu**) > **Fax Feature** > **Secure Receive** on the control panel.

Or select **Setup** > **Machine Setup** > **Next** > **Fax Setup** > **Secure Receive** .

Printing received faxes

1

Select  (fax) >  (**Menu**) > **Fax Feature** > **Secure Receive** > **Print** on the control panel.

Or select **Setup** > **Machine Setup** > **Next** > **Fax Setup** > **Secure Receive** > **Print** .

2

Enter a four-digit password and press **OK**.



Fax features

- 3 The machine prints all of the faxes stored in memory.

Printing faxes on both sides of the paper



- Some menus may not appear on the display depending on options or models. If so, it is not applicable to your machine.
- This feature may not be available depending on model or optional goods (see "Features by models" on page 7).

- 1 Place a single document face down on the document glass, or load the documents face up into the document feeder.
- 2 Press  (fax) >  (**Menu**) > **Fax Setup** > **Receiving** > **Duplex Print** on the control panel.
 - **Off:** Prints in Normal mode.
 - **Long Edge:** Prints pages to be read like a book.

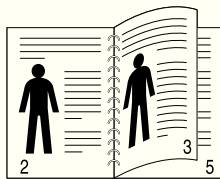

- **Short Edge:** Prints pages to be read by flipping like a note pad.

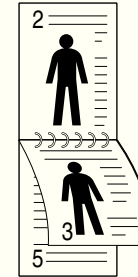

- 3 Press **OK**.
- 4 Press  (**Cancel** or **Stop/Clear**) to return to ready mode.

Receiving faxes in memory

Since your machine is a multi-tasking device, it can receive faxes while you are making copies or printing. If you receive a fax while you are copying or printing, your machine stores incoming faxes in its memory. Then, as soon as you finish copying or printing, the machine automatically prints the fax.





- If fax is received and being printed, other copy and print jobs cannot be processed at the same time.

Fax features

Printing sent fax report automatically

You can set the machine to print a report with detailed information about the previous 50 communication operations, including time and dates.

- 1 Press  (fax) >  (**Menu**) > **Fax Setup** > **Auto Report** > **On** on the control panel.
- 2 Press  (**Cancel** or **Stop/Clear**) to return to ready mode.

Using memory/hard drive features



You can use this feature in the models that have a mass storage device (HDD) or memory (see "Variety feature" on page 7).

Setting up the optional memory

From the printer driver

After installing the optional memory, you can use advanced printing features, such as proofing a job and specifying of printing a private job in the **Print** window. Select **Properties** or **Preference**, and configure the printing mode.

From the control panel

If your machine has optional memory or an optional hard drive, you can use these features from the (**Menu**) button > **System Setup** > **Job Management**.

- **Active Job:** All of the print jobs waiting to be printed are listed in the active job queue in the order you sent them to the printer. You can delete a job from the queue before printing, or promote a job to print sooner.
- **File Policy:** You can choose the file policy for generating file name before you proceed with the job through optional memory. If the optional memory already has the same name when you entered a new file name, you can rename or overwrite it.
- **Stored Job:** You can print or delete a stored job.



- Some menus may not appear on the display depending on options or models. If so, it is not applicable to your machine.
- After installing the hard drive, you can also print the predefined document templates from the (**Menu**) button > **System Setup** > **Form Menu**.



5. Useful Management Tools

This chapter introduces management tools provided to help you make full use of your machine.

- **Accessing management tools** 246
- **Using Firmware update utility** 247
- **Using Dell Supplies Ordering Utility** 248
- **Using Embedded Web Service** 249
- **Using Dell Printer Manager** 251
- **Using Dell Printer Status** 254
- **Using Dell Printer Experience** 256
- **Using the Linux Unified Driver Configurator** 261

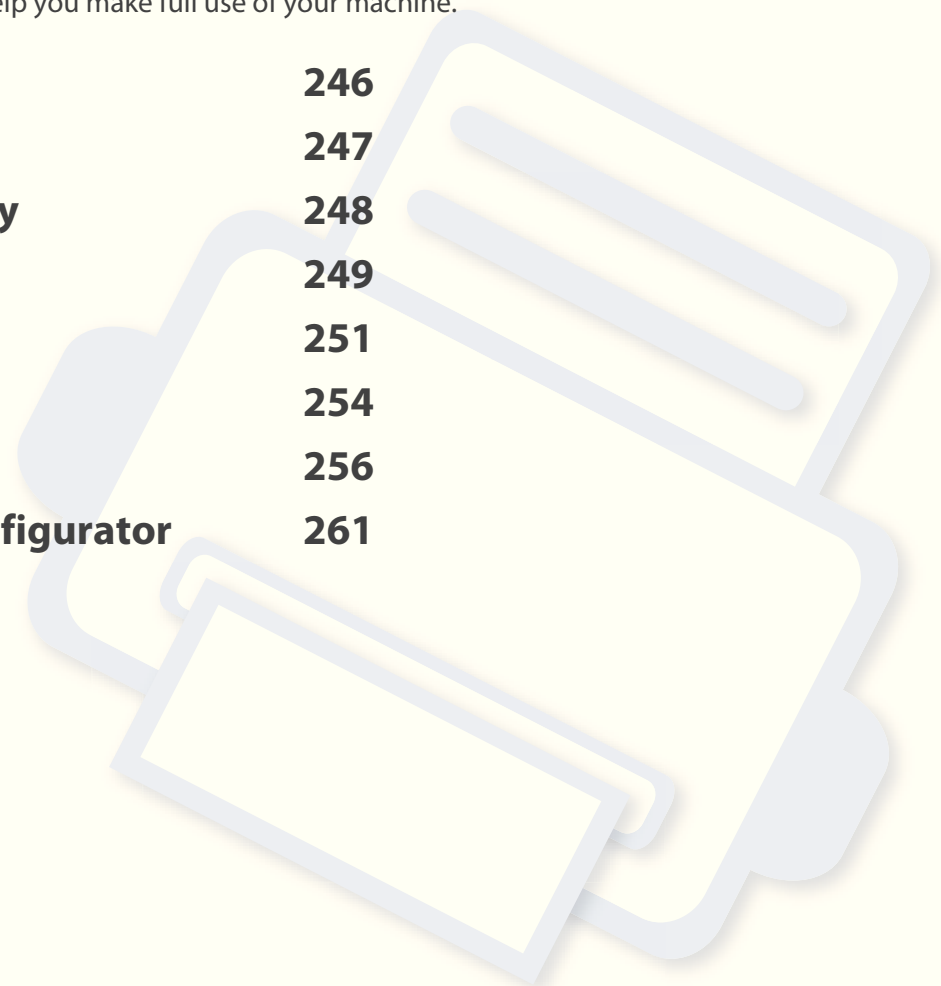

Accessing management tools

Dell provides a variety of management tools for Dell printers.

- 1 Make sure that the machine is connected to your computer and powered on.
- 2 From the **Start** menu, select **Programs** or **All Programs**.
 - For Windows 8, from the **Charms**, select **Search** > **Apps**.
- 3 Find **Dell Printers**.
- 4 Under **Dell Printers**, you can see installed management tools.
- 5 Click the management tool you want to use.



- After installing the driver, for some management tools, you can access them directly from the **Start** screen by clicking on the corresponding tile.
- For Windows 8, after installing the driver, for some management tools, you can access them directly from the **Start** screen by clicking on the corresponding tile.

Using Firmware update utility

Firmware Update Utility allows you to maintain your machine by upgrading firmware.

- 1 From the **Start** menu, select **Programs** or **All Programs** > **Dell** > **Dell Printers** > **your printer driver name** > **Firmware Update Utility**.
- 2 Download the latest firmware. Click <http://www.dell.com/support>.
- 3 If your printer is connected with an USB cable, click **USB Connected Printer** or **Network Connected Printer**.

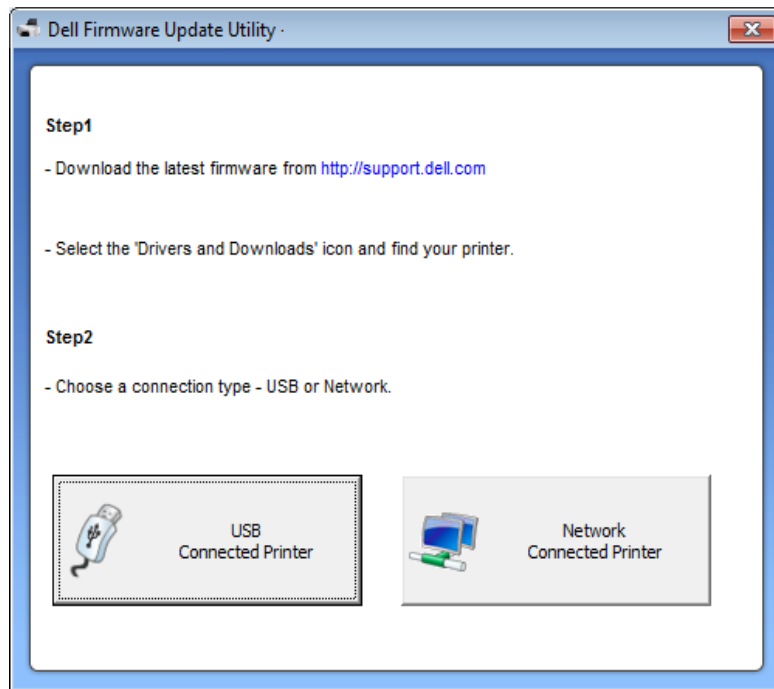

- 4 Click **Browse** and select the downloaded firmware file.
- 5 Click **Update Firmware**.

Using Dell Supplies Ordering Utility

To order replacement toner cartridges or supplies from Dell:



Available for Windows or Mac OS users only.

1 Double-click the **Dell Supplies Ordering Utility** icon on your desktop.



OR

From the **Start** menu, select **Programs** or **All Programs** > **Dell** > **Dell Printers** > **your printer driver name** > **Dell Supplies Ordering Utility**.



For Mac,

Open the **Applications** folder > **Dell** folder > **Dell Supplies Ordering Utility**.

2 The **Dell Supplies Ordering Utility** window opens.



Using Embedded Web Service



- Internet Explorer 6.0 or higher is the minimum requirement for Embedded Web Service.
- Embedded Web Service explanation in this user's guide may differ from your machine depending on its options or models.
- Network model only (see "Software" on page 7).

Accessing Embedded Web Service

- 1 Access a web browser, such as Internet Explorer, from Windows.
Enter the machine IP address of your printer (<http://xxx.xxx.xxx.xxx>) in the address field and press the Enter key or click **Go**.
- 2 Your machine's embedded website opens.

Logging into Embedded Web Service

Before configuring options in Embedded Web Service, you need to log-in as an administrator. You can still use Embedded Web Service without logging in but you won't have access to **Settings** tab and **Security** tab.

- 1 Click **Login** on the upper right of the Embedded Web Service website.
- 2 Type in the **ID** and **Password** then click **Login**.
 - **ID: admin**
 - **Password: dell00000**

Embedded Web Service overview



Some tabs may not appear depending on your model.



Information

Settings

Security

Maintenance

Information tab

This tab gives you general information about your machine. You can check things, such as remaining amount of toner. You can also print reports, such as an error report.

- **Active Alerts:** Shows the alerts that have occurred in the machine and their severity.
- **Supplies:** Shows how many pages are printed and amount of toner left in the cartridge.

Using Embedded Web Service

- **Usage Counters:** Shows the usage count by print types: simplex and duplex.
- **Current Settings:** Shows the machine's and network's information.
- **Print information:** Prints reports such as system related reports, e-mail address, and font reports.

Settings tab

This tab allows you to set configurations provided by your machine and network. You need to log-in as an administrator to view this tab.

- **Machine Settings** tab: Sets options provided by your machine.
- **Network Settings** tab: Shows options for the network environment. Sets options such as TCP/IP and network protocols.

Security tab

This tab allows you to set system and network security information. You need to log-in as an administrator to view this tab.

- **System Security:** Sets the system administrator's information and also enables or disables machine features.
- **Network Security:** IPv4/IPv6 filtering.
- **User Access Control:** Classifies users into several groups according to each user's role. Each user's authorization, authentication and accounting will be controlled by the group's role definition.

Maintenance tab

This tab allows you to maintain your machine by upgrading firmware and setting contact information for sending emails. You can also connect to Dell website or download drivers by selecting the **Link** menu.

- **Firmware Upgrade:** Upgrade your machine's firmware.
- **Contact Information:** Shows the contact information.
- **Link:** Shows links to useful sites where you can download or check information.

Using Dell Printer Manager



- Available for Windows and Mac OS users only (see "Software" on page 7).
- For Windows, Internet Explorer 6.0 or higher is the minimum requirement for Dell Printer Manager.

Dell Printer Manager is an application that combines Dell machine settings into one location. Dell Printer Manager combines device settings as well as printing environments, settings/actions and launching. All of these features provide a gateway to conveniently use your Dell machine. Dell Printer Manager provides two different user interfaces for the user to choose from: the basic user interface and the advanced user interface. Switching between the two interfaces is easy: just click a button.

Understanding Dell Printer Manager

To open the program:

For Windows,

Select **Start > Programs** or **All Programs > Dell > Dell Printers > Dell Printer Manager > Dell Printer Manager**.

For Mac,

Open the **Applications** folder > **Dell** folder > **Dell Printer Manager**.

The Dell Printer Manager interface is comprised of various basic sections as described in the table that follows:





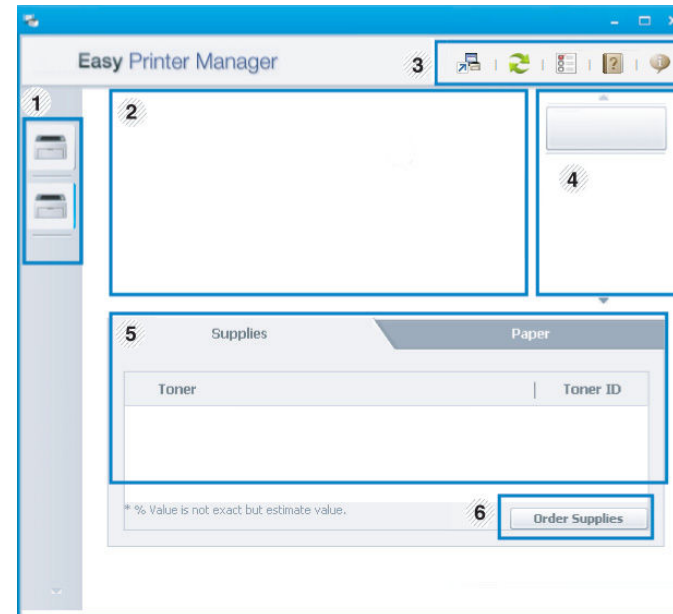

The screenshot may differ depending on operating system you are using.



1	Printer list	The Printer List displays printers installed on your computer and network printers added by network discovery (Windows only).
---	--------------	---

Using Dell Printer Manager

2	Printer information	<p>This area gives you general information about your machine. You can check information, such as the machine's model name, IP address (or Port name), and machine status.</p> <p> You can view the online User's Guide.</p>
3	Application information	<p>Includes links for changing to the advanced settings, preference, help, and about.</p> <p> The  button is used to change the user interface to the advanced settings user interface (see "Advanced settings user interface overview" on page 253).</p>
4	Quick links	<p>Displays Quick links to machine specific functions. This section also includes links to applications in the advanced settings.</p> <p> If you connect your machine to a network, the Embedded Web Service icon is enabled.</p>

5	Contents area	<p>Displays information about the selected machine, remaining toner level, and paper. The information will vary based on the machine selected. Some machines do not have this feature.</p>
6	Order supplies	<p>Click on the Order button from the supply ordering window. You can order replacement toner cartridge(s) from online.</p>



Select the **Help** menu or click the  button from the window and click on any option you want to know about.

Using Dell Printer Manager

Advanced settings user interface overview

The advanced user interface is intended to be used by the person responsible for managing the network and machines.



Some menus may not appear in the display depending on options or models. If so, it is not applicable to your machine.

Device Settings

You can configure various machine settings such as machine setup, paper, layout, emulation, network, and print information.

Scan to PC Settings

This menu includes settings to create or delete scan to PC profiles.

- **Scan Activation:** Determines whether or not scanning is enabled on the device.
- **Profile:** Displays the scanning profiles saved on the selected device.
- **Basic tab:** Contains settings related general scan and device settings.
- **Image tab:** Contains settings related to image altering.

Fax to PC Settings

This menu includes settings related to the basic fax functionality of the selected device.

- **Disable:** If **Disable** is **On**, incoming faxes will not be received on this device.
- **Enable Fax Receiving from Device:** Enables faxing on the device and allow more options to be set.

Alert Settings (Windows only)

This menu includes settings related to error alerting.

- **Printer Alert:** Provides settings related to when alerts will be received.
- **Email Alert:** Provides options relating to receiving alerts via email.
- **Alert History:** Provides a history of device and toner related alerts.

Using Dell Printer Status

The Dell Printer Status is a program that monitors and informs you of the machine status.



- The Dell Printer Status window and its contents shown in this user's guide may differ depending on the machine or operating system in use.
- Check the operating system(s) that are compatible with your machine (see "Specifications" on page 104).
- Available for Windows OS users only (see "Software" on page 7).

Dell Printer Status overview

If an error occurs while operating, you can check the error from the Dell Printer Status. Dell Printer Status is installed automatically when you install the machine software.

You can also launch Dell Printer Status manually. Go to the **Printing Preferences**, click the **Basic** tab > **Printer Status** button.

These icons appear on the Windows task bar:

Icon	Mean	Description
	Normal	The machine is in ready mode and experiencing no errors or warnings.
	Warning	The machine is in a state where an error might occur in the future. For example, it might be in toner low status, which may lead to toner empty status.
	Error	The machine has at least one error.

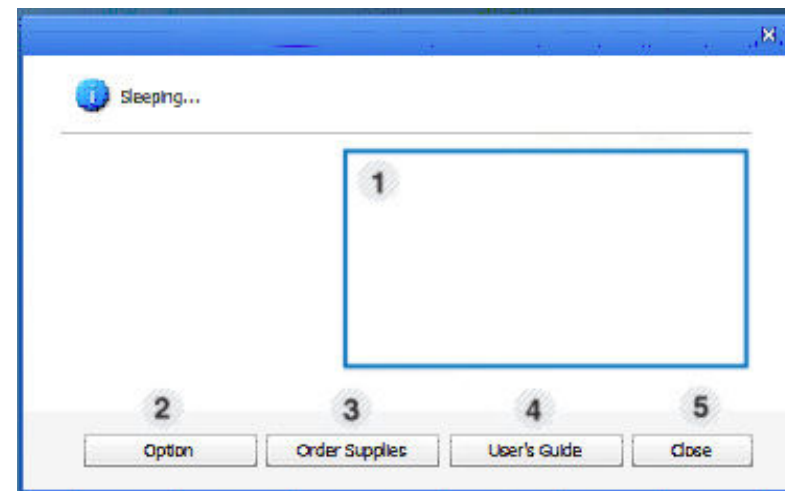

1	Toner Level	You can view the level of toner remaining in each toner cartridge. The machine and the number of toner cartridge(s) shown in the above window may differ depending on the machine in use. Some machines do not have this feature.
---	--------------------	---

Using Dell Printer Status

2	Option	You can set printing job alert related settings.
3	Order Supplies	You can order replacement toner cartridge(s) from online.
4	User's Guide	You can view the online User's Guide.
5	Close	Close the window.

Using Dell Printer Experience

Dell Printer Experience is a Dell application that combines Dell machine settings and machine management into one location. You can set device settings, order supplies, open troubleshooting guides, visit Dell's web site, and check connected machine information. This application will be automatically downloaded from the Windows **Store** if the machine is connected to a computer with an Internet connection.

Understanding the Dell Printer Experience

To open the application,

From the **Start** screen, select the **Dell Printer Experience** () tile.

The **Dell Printer Experience** interface comprises various useful features as described in the following table:



The screenshot may differ depending on the model you are using.

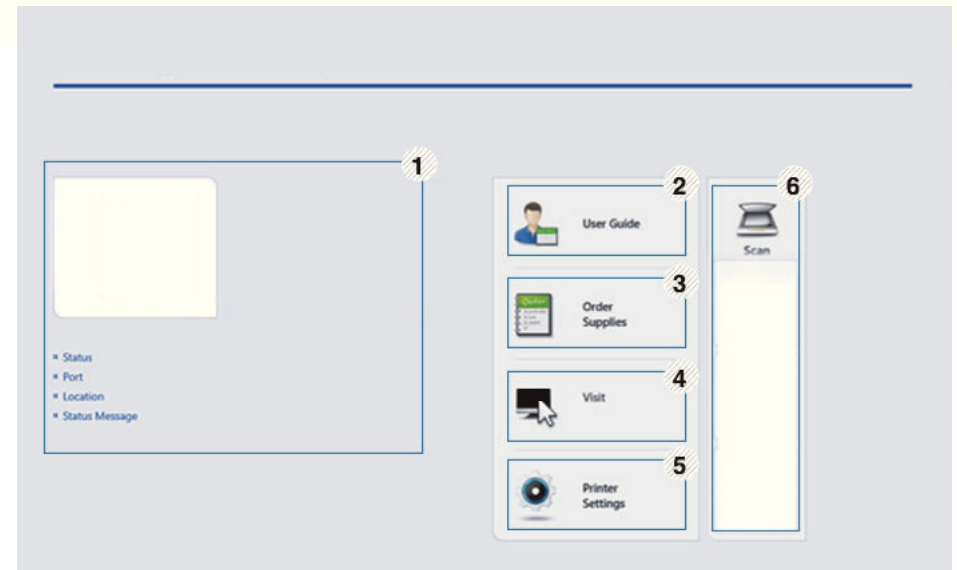

1	Printer Information	This area gives you general information about your machine. You can check information, such as the machine's status, location, IP address, and remaining toner level.
2	User Guide	You can view the online User's Guide. You need to be connected to the Internet to use this feature.  This button opens the Troubleshooting Guide when an error occurs. You can directly open the troubleshooting section in the user's guide.

Using Dell Printer Experience

3	Order Supplies	Click on this button to order replacement toner cartridges online. You need to be connected to the Internet to use this feature.
4	Visit Dell	Links to Dell printer website. You need to be connected to the Internet to use this feature.
5	Device List & Latest Scanned Image	The scan list displays devices that supports Dell Printer Experience . Under the device, you can see the latest scanned images. Your machine needs to be connected to a network to scan from here. This section is for the users with multi-functional printers.

Printing from Windows 8

This section explains common printing tasks from the **Start** screen.

Basic printing

- 1 Open the document to print.
- 2 From the **Charms**, select **Devices**.
- 3 Select your printer from the list
- 4 Select the printer settings, such as the number of copies and orientation.

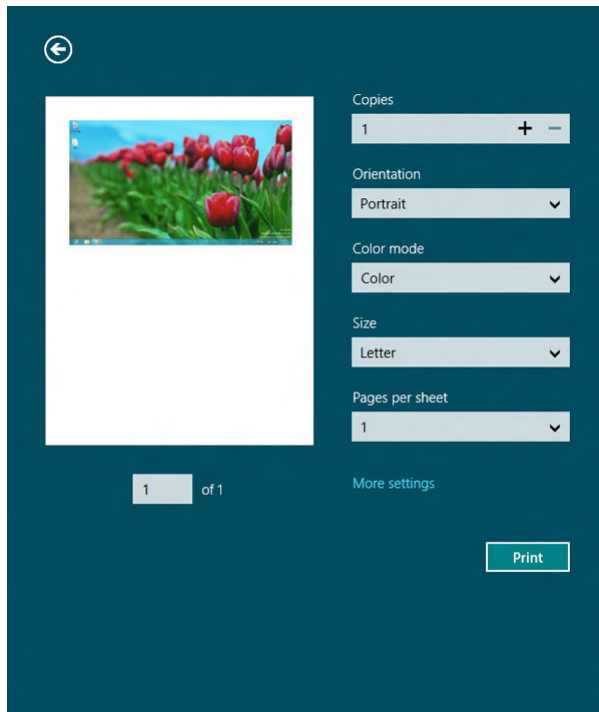

Using Dell Printer Experience

- 5 Click the **Print** button to start the print job.



Cancelling a print job

If the printing job is waiting in the print queue or print spooler, cancel the job as follows:

- You can access this window by simply double-clicking the machine icon () in the Windows task bar.
- You can also cancel the current job by pressing  (**Cancel** or **Stop/Clear**) button on the control panel.

Opening more settings



The screen may appear somewhat different depending on the model or options.

You can set up more printing parameters.

- 1 Open the document you want to print.
- 2 From the **Charms**, select **Devices**.
- 3 Select your printer from the list
- 4 Click **More settings**.

Using Dell Printer Experience

Basic tab

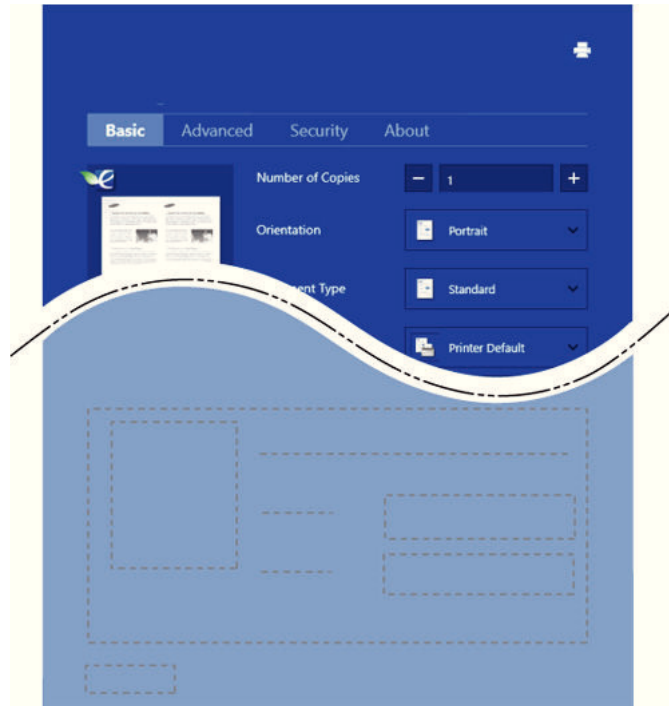

Basic

This option allows you to choose the basic printing settings such as copies, orientation, and document type.

Eco settings

This option allows you to choose multiple pages per side to save media.

Advanced tab



Paper settings

This option allows you to set the basic paper handling specifications.

Layout settings

This option allows you to set the various ways to layout your documents.

Using Dell Printer Experience

Scanning from Windows 8





This section is for the users with multi-functional printers.

Scanning with your machine lets you turn pictures and text into digital files that can be stored on your computer.

Scanning from Dell Printer Experience

The most frequently used printing menus are displayed for quick scanning.

- 1 Place a single document face down on the document glass, or load the documents face up into the document feeder.
- 2 Click the **Dell Printer Experience** tile on the **Start** screen.
- 3 Click **Scan** ().
- 4 Set up the scanning parameters such as image type, document size, and resolution.
- 5 Click **Prescan** () to check the image.
- 6 Adjust the prescanned image with scanning operation functions such as rotate and mirror.

- 7 Click **Scan** () and save the image.



- When you place the originals in the ADF (or DADF), **Prescan** () is not available.
- You can skip step 5, if the Prescan option is selected.

Using the Linux Unified Driver Configurator

The Unified Driver Configurator is a tool primarily intended for configuring machine devices. You need to install Unified Linux Driver to use Unified Driver Configurator (see "Installation for Linux" on page 133).

After the driver is installed on your Linux system, the Unified Driver Configurator icon will automatically be created on your desktop.

Opening Unified Driver Configurator

- 1 Double-click the **Unified Driver Configurator** on the desktop.
You can also click the **Startup** Menu icon and select **Dell Unified Driver > Unified Driver Configurator**.
- 2 Click each button on the left to switch to the corresponding configuration window.

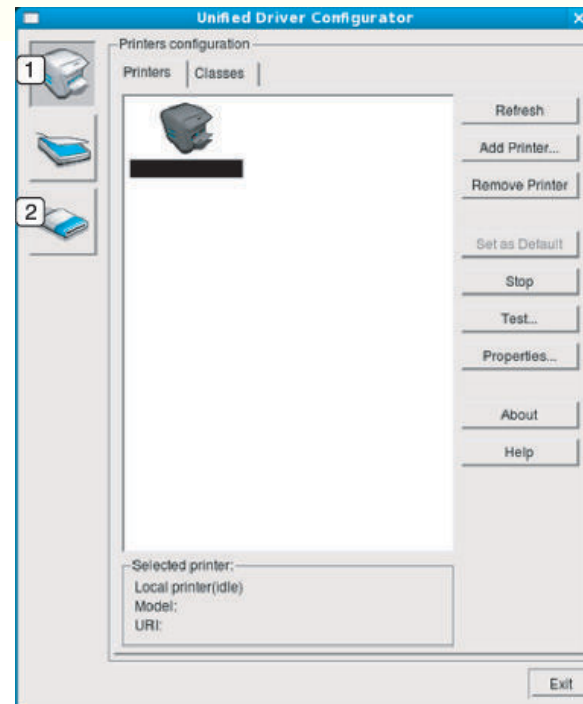

- 1 **Printer Configuration**
- 2 **Port Configuration**



To use the on screen help, the **Help** or **?** button from the window.

- 3 After changing the configurations, click **Exit** to close the **Unified Driver Configurator**.

Using the Linux Unified Driver Configurator

Printers configuration

Printers configuration has the two tabs: **Printers** and **Classes**.

Printers tab

View the current system's printer configuration by clicking on the machine icon button on the left side of the **Unified Driver Configurator** window.

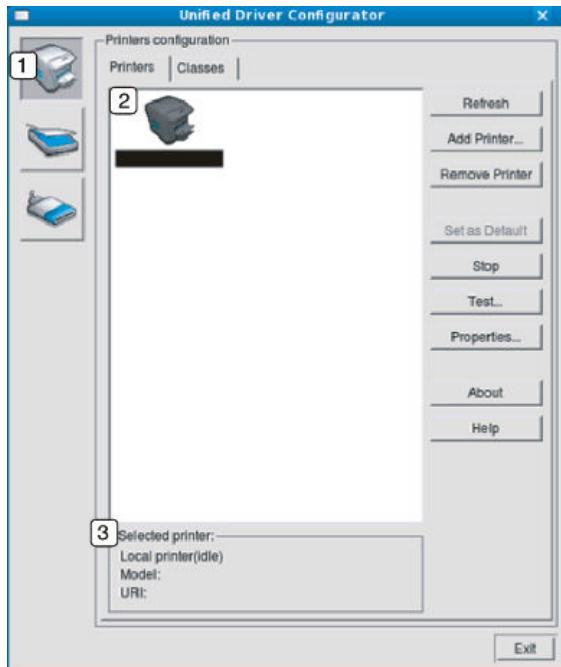

1	Switches to Printers configuration .
2	Shows all of the installed machines.
3	Shows the status, model name, and URI of your machine.

The printer control buttons are, as follows:

- **Refresh:** Renews the available machines list.
- **Add Printer:** Allows you to add a new machines.
- **Remove Printer:** Removes the selected machine.
- **Set as Default:** Sets the current selected machine as a default machine.
- **Stop/Start:** Stops/starts the machine.
- **Test:** Allows you to print a test page to ensure the machine is working properly.
- **Properties:** Allows you to view and change the printer's properties.

Using the Linux Unified Driver Configurator

Classes tab

The Classes tab shows a list of available machine classes.

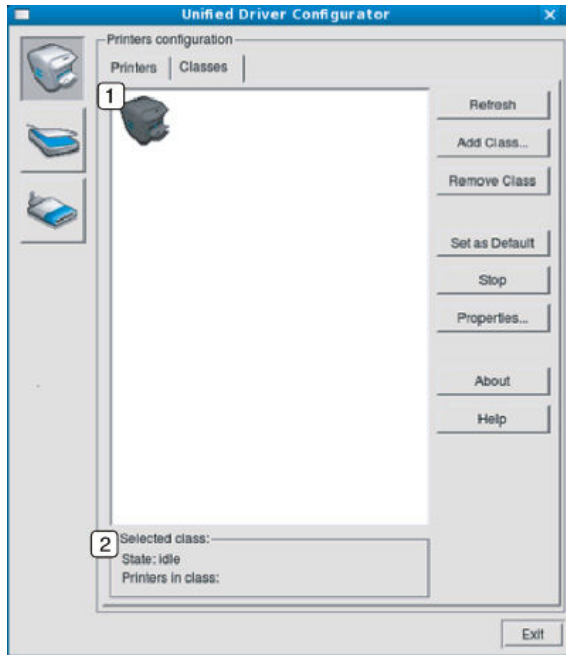

- 1 Shows all of the machine classes.
- 2 Shows the status of the class and the number of machines in the class.

- **Refresh:** Renews the classes list.
- **Add Class:** Allows you to add a new machine class.
- **Remove Class:** Removes the selected machine class.

Ports configuration

In this window, you can view the list of available ports, check the status of each port and release a port that is stalled in a busy state when its owner has terminated the job for any reason.

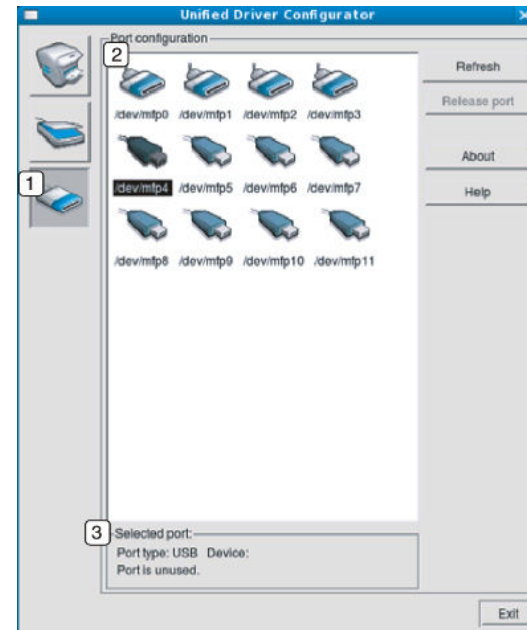

- 1 Switches to **Ports configuration**.
- 2 Shows all of the available ports.
- 3 Shows the port type, device connected to the port, and status.

- **Refresh:** Renews the available ports list.
- **Release port:** Releases the selected port.



6. Troubleshooting

This chapter gives helpful information for what to do if you encounter an error.

- **Paper feeding problems** 265
- **Power and cable connecting problems** 266
- **Printing problems** 267
- **Printing quality problems** 271
- **Copying problems** 279
- **Scanning problems** 280
- **Faxing problems** 281
- **Operating system problems** 283

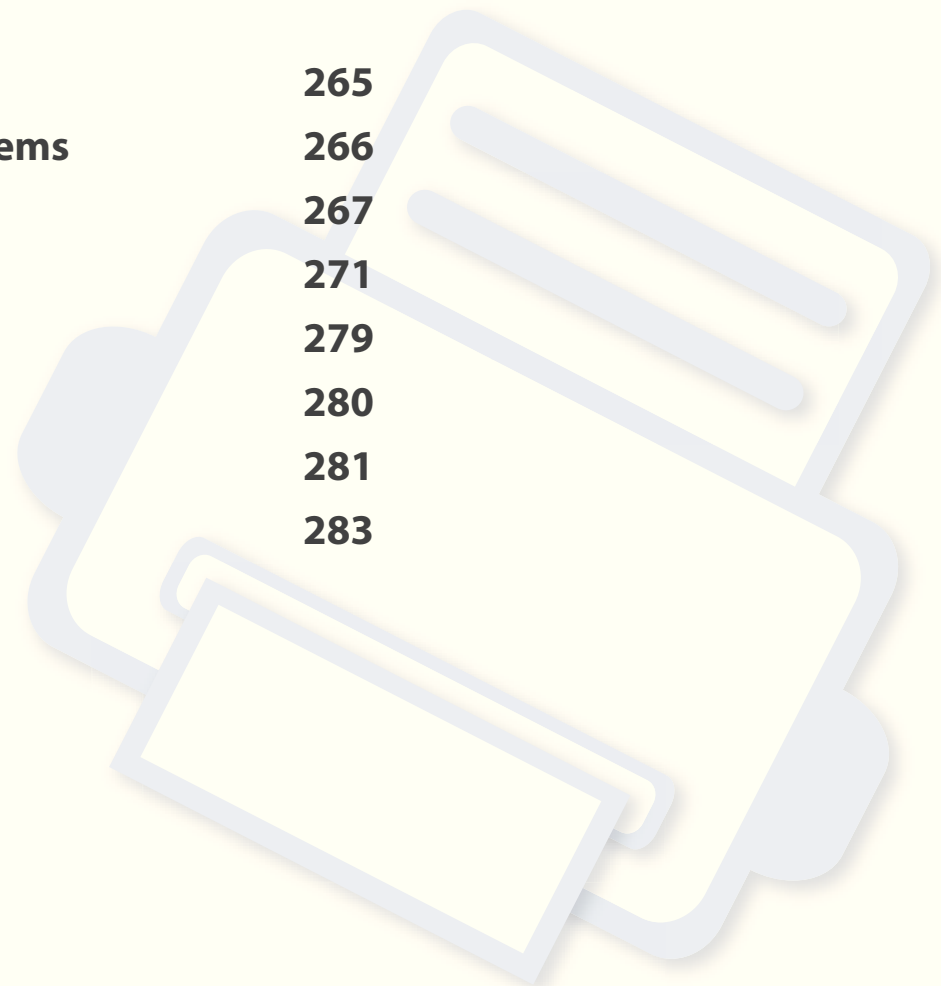

Paper feeding problems

Condition	Suggested solutions
Paper jams during printing.	Clear the paper jam.
Paper sticks together.	<ul style="list-style-type: none">• Check the maximum paper capacity of the tray.• Make sure that you are using the correct type of paper.• Remove paper from the tray and flex or fan the paper.• Humid conditions may cause some paper to stick together.
Multiple sheets of paper do not feed.	Different types of paper may be stacked in the tray. Load paper of only one type, size, and weight.
Paper does not feed into the machine.	<ul style="list-style-type: none">• Remove any obstructions from inside the machine.• Paper has not been loaded correctly. Remove paper from the tray and reload it correctly.• There is too much paper in the tray. Remove excess paper from the tray.• The paper is too thick. Use only paper that meets the specifications required by the machine.
The paper keeps jamming.	<ul style="list-style-type: none">• There is too much paper in the tray. Remove excess paper from the tray. If you are printing on special materials, use the manual feeding in tray.• An incorrect type of paper is being used. Use only paper that meets the specifications required by the machine.• There may be debris inside the machine. Open the front cover and remove any debris.
Envelopes skew or fail to feed correctly.	Ensure that the paper guides are against both sides of the envelopes.

Power and cable connecting problems

Condition	Suggested solutions
The machine is not receiving power, or the connection cable between the computer and the machine is not connected properly.	<ul style="list-style-type: none"><li data-bbox="658 300 2186 384">• Connect the machine to the electricity supply first. If the machine has a  (Power/Wakeup) button on the control, press it.<li data-bbox="658 405 1323 437">• Disconnect the machine's cable and reconnect it.

Printing problems

Condition	Possible cause	Suggested solutions
The machine does not print.	The machine is not receiving power.	Connect the machine to the electricity supply first. If the machine has a  (Power/Wakeup) button on the control, press it.
	The machine is not selected as the default machine.	Select your machine as your default machine in Windows.
	Check the machine for the following: <ul style="list-style-type: none">• The cover is not closed. Close the cover.• Paper is jammed. Clear the paper jam (see "Clearing paper jams" on page 92).• No paper is loaded. Load paper (see "Loading paper in the tray" on page 38).• The toner cartridge is not installed. Install the toner cartridge (see "Replacing the toner cartridge" on page 74).• Make sure the protect cover and sheets are removed from the toner cartridge (see "Replacing the toner cartridge" on page 74). If a system error occurs, contact your service representative.	
	The connection cable between the computer and the machine is not connected properly.	Disconnect the machine cable and reconnect it (see "Rear view" on page 20).
	The connection cable between the computer and the machine is defective.	If possible, attach the cable to another computer that is working properly and print a job. You can also try using a different machine cable.
	The port setting is incorrect.	Check the Windows printer settings to make sure that the print job is sent to the correct port. If the computer has more than one port, make sure that the machine is attached to the correct one.

Printing problems

Condition	Possible cause	Suggested solutions
The machine does not print.	The machine may be configured incorrectly.	Check the Printing Preferences to ensure that all of the print settings are correct.
	The printer driver may be incorrectly installed.	Uninstall and reinstall the machine's driver.
	The machine is malfunctioning.	Check the display message on the control panel to see if the machine is indicating a system error. Contact a service representative.
	The document size is so big that the hard disk space of the computer is insufficient to access the print job.	Get more hard disk space and print the document again.
	The output tray is full.	Once the paper is removed from the output tray, the machine resumes printing.
The machine selects print materials from the wrong paper source.	The paper option that was selected in the Printing Preferences may be incorrect.	For many software applications, the paper source selection is found under the Paper tab within the Printing Preferences (see "Opening printing preferences" on page 50). Select the correct paper source. See the printer driver help screen (see "Using help" on page 52).
A print job is extremely slow.	The job may be very complex.	Reduce the complexity of the page or try adjusting the print quality settings.
Half the page is blank.	The page orientation setting may be incorrect.	Change the page orientation in your application (see "Opening printing preferences" on page 50). See the printer driver help screen (see "Using help" on page 52).
	The paper size and the paper size settings do not match.	Ensure that the paper size in the printer driver settings matches the paper in the tray. Or, ensure that the paper size in the printer driver settings matches the paper selection in the software application settings you use (see "Opening printing preferences" on page 50).
The machine prints, but the text is wrong, garbled, or incomplete.	The machine cable is loose or defective.	Disconnect the machine cable and reconnect. Try a print job that you have already printed successfully. If possible, attach the cable and the machine to another computer that you know works and try a print job. Finally, try a new machine cable.

Printing problems

Condition	Possible cause	Suggested solutions
	The wrong printer driver was selected.	Check the application's printer selection menu to ensure that your machine is selected.
	The software application is malfunctioning.	Try printing a job from another application.
	The operating system is malfunctioning.	Exit Windows and reboot the computer. Turn the machine off and back on again.
Pages print, but they are blank.	The toner cartridge is defective or out of toner.	Redistribute the toner, if necessary. If necessary, replace the toner cartridge. <ul style="list-style-type: none"> • See "Redistributing toner" on page 72. • See "Replacing the toner cartridge" on page 74.
	The file may have blank pages.	Check the file to ensure that it does not contain blank pages.
	Some parts, such as the controller or the board, may be defective.	Contact a service representative.
The machine does not print PDF files correctly. Some parts of graphics, text, or illustrations are missing.	Incompatibility between the PDF file and the Acrobat products.	Printing the PDF file as an image may enable the file to print. Turn on Print As Image from the Acrobat printing options. <div data-bbox="1079 938 2190 1053" style="border: 1px solid #ccc; padding: 5px; margin-top: 10px;">  It will take longer to print when you print a PDF file as an image. </div>
The print quality of photos is not good. Images are not clear.	The resolution of the photo is very low.	Reduce the photo size. If you increase the photo size in the software application, the resolution will be reduced.
Before printing, the machine emits vapor near the output tray.	Using damp paper can cause vapor during printing.	This is not a problem. Just keep printing.

Printing problems

Condition	Possible cause	Suggested solutions
The machine does not print special-sized paper, such as billing paper.	Paper size and paper size setting do not match.	Set the correct paper size in the Custom in Paper tab in Printing Preferences (see "Opening printing preferences" on page 50).
The printed billing paper is curled.	The paper type setting does not match.	Change the printer option and try again. Go to Printing Preferences , click Paper tab, and set type to Thick (see "Opening printing preferences" on page 50).
Machine information is not displayed when you click the device in the Devices and Printers .	Check the Printer properties . Click the Ports tab. (Control Panel > Devices and Printers > Right-click on your printer icon and select Printer properties)	Machine information is not displayed when you click the device in the Devices and Printers .
The error related toast message pops up.	If the port is set to File or LPT, uncheck them and select TCP/IP, USB, or WSD.	The error related toast message pops up.

Printing quality problems

If the inside of the machine is dirty or paper has been loaded improperly, there might be a reduction in print quality. See the table below to clear the problem.

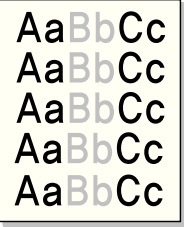
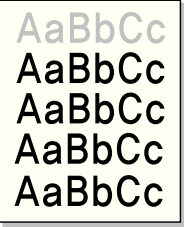
Condition	Suggested solutions
<p data-bbox="49 357 322 389">Light or faded print</p> 	<ul data-bbox="506 357 2190 751" style="list-style-type: none">• If a vertical white streak or faded area appears on the page, the toner supply is low. Install a new toner cartridge (see "Replacing the toner cartridge" on page 74).• The paper may not meet paper specifications; for example, the paper may be too moist or rough.• If the entire page is light, the print resolution setting is too low or the toner save mode is on. Adjust the print resolution and turn the toner save mode off. See the help screen of the printer driver.• A combination of faded or smeared defects may indicate that the toner cartridge needs cleaning. Clean the inside of your machine (see "Cleaning the machine" on page 78).• The surface of the LSU part inside the machine may be dirty. Clean the inside of your machine (see "Cleaning the machine" on page 78). If these steps do not correct the problem, contact a service representative.
<p data-bbox="49 786 472 903">The top half of the paper is printed lighter than the rest of the paper</p> 	<p data-bbox="506 786 1301 818">The toner might not adhere properly to this type of paper.</p> <ul data-bbox="506 842 2190 911" style="list-style-type: none">• Change the printer option and try again. Go to Printing Preferences, click the Paper tab, and set the paper type to Recycled (see "Opening printing preferences" on page 50).

Printing quality problems

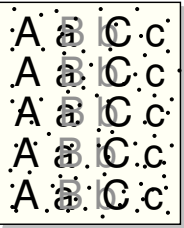
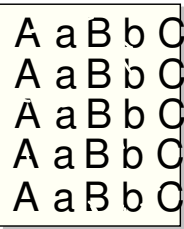
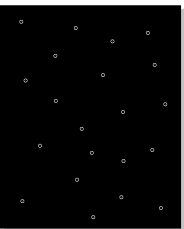
Condition	Suggested solutions
<p>Toner specks</p> 	<ul style="list-style-type: none">• The paper may not meet specifications; for example, the paper may be too moist or rough.• The transfer roller may be dirty. Clean the inside of your machine (see "Cleaning the machine" on page 78).• The paper path may need cleaning. Contact a service representative (see "Cleaning the machine" on page 78).
<p>Dropouts</p> 	<p>If faded areas, generally rounded, occur randomly on the page:</p> <ul style="list-style-type: none">• A single sheet of paper may be defective. Try reprinting the job.• The moisture content of the paper is uneven or the paper has moist spots on its surface. Try a different brand of paper.• The paper lot is bad. The manufacturing processes can cause some areas to reject toner. Try a different kind or brand of paper.• Change the printer option and try again. Go to Printing Preferences, click the Paper tab, and set type to Thick (see "Opening printing preferences" on page 50). <p>If these steps do not correct the problem, contact a service representative.</p>
<p>White Spots</p> 	<p>If white spots appear on the page:</p> <ul style="list-style-type: none">• The paper is too rough and a lot of dirt from paper falls to the inner components within the machine, so the transfer roller may be dirty. Clean the inside of your machine (see "Cleaning the machine" on page 78).• The paper path may need cleaning. Clean the inside of your machine (see "Cleaning the machine" on page 78). <p>If these steps do not correct the problem, contact a service representative.</p>

Printing quality problems

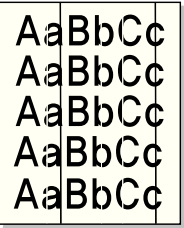
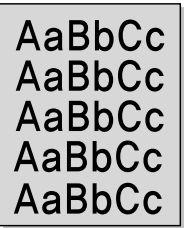
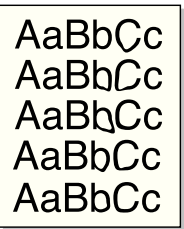
Condition	Suggested solutions
Vertical lines 	<p>If black vertical streaks appear on the page:</p> <ul style="list-style-type: none">• The surface (drum part) of the toner cartridge inside the machine has probably been scratched. Remove the toner cartridge and install a new one (see "Replacing the toner cartridge" on page 74). <p>If white vertical streaks appear on the page:</p> <ul style="list-style-type: none">• The surface of the LSU part inside the machine may be dirty. Clean the inside of your machine (see "Cleaning the machine" on page 78). If these steps do not correct the problem, contact a service representative.
Black or color background 	<p>If the amount of background shading becomes unacceptable:</p> <ul style="list-style-type: none">• Change to a lighter weight paper.• Check the environmental conditions: very dry conditions or a high level of humidity (higher than 80% RH) can increase the amount of background shading.• Remove the old toner cartridge and install a new one (see "Replacing the toner cartridge" on page 74).• Thoroughly redistribute the toner (see "Redistributing toner" on page 72).
Toner smear 	<ul style="list-style-type: none">• Clean the inside of the machine (see "Cleaning the machine" on page 78).• Check the paper type and quality.• Remove the toner cartridge and install a new one (see "Replacing the toner cartridge" on page 74).

Printing quality problems

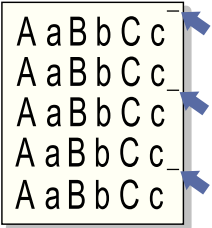
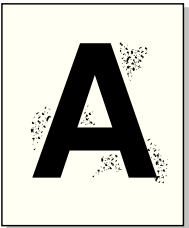
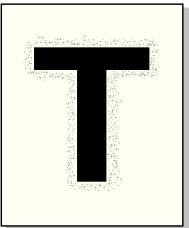
Condition	Suggested solutions
<p data-bbox="49 272 409 304">Vertical repetitive defects</p> 	<p data-bbox="504 272 1473 304">If marks repeatedly appear on the printed side of the page at even intervals:</p> <ul data-bbox="504 328 2190 544" style="list-style-type: none"><li data-bbox="504 328 2190 400">• The toner cartridge may be damaged. If you still have the same problem, remove the toner cartridge and, install a new one (see "Replacing the toner cartridge" on page 74).<li data-bbox="504 416 2190 488">• Parts of the machine may have toner on them. If the defects occur on the back of the page, the problem will likely correct itself after a few more pages.<li data-bbox="504 504 1464 544">• The fusing assembly may be damaged. Contact a service representative.
<p data-bbox="49 612 322 644">Background scatter</p> 	<p data-bbox="504 612 1621 644">Background scatter results from bits of toner randomly distributed on the printed page.</p> <ul data-bbox="504 668 2190 1054" style="list-style-type: none"><li data-bbox="504 668 2190 740">• The paper may be too damp. Try printing with a different batch of paper. Do not open packages of paper until necessary so that the paper does not absorb too much moisture.<li data-bbox="504 756 2190 876">• If background scatter occurs on an envelope, change the printing layout to avoid printing over areas that have overlapping seams on the reverse side. Printing on seams can cause problems. Or select Thick from the Printing Preferences window (see "Opening printing preferences" on page 50).<li data-bbox="504 892 2190 1011">• If background scatter covers the entire surface area of a printed page, adjust the print resolution through your software application or in Printing Preferences (see "Opening printing preferences" on page 50). Ensure the correct paper type is selected. For example: If Thicker Paper is selected, but Plain Paper actually used, an overcharging can occur causing this copy quality problem.<li data-bbox="504 1027 1868 1054">• If you are using a new toner cartridge, redistribute the toner first (see "Redistributing toner" on page 72).
<p data-bbox="49 1086 479 1158">Toner particles are around bold characters or pictures</p> 	<p data-bbox="504 1086 1249 1118">The toner might not adhere properly to this type of paper.</p> <ul data-bbox="504 1142 2190 1302" style="list-style-type: none"><li data-bbox="504 1142 2190 1214">• Change the printer option and try again. Go to Printing Preferences, click the Paper tab, and set the paper type to Recycled (see "Opening printing preferences" on page 50).<li data-bbox="504 1230 2190 1302">• Ensure the correct paper type is selected. For example: If Thicker Paper is selected, but Plain Paper actually used, an overcharging can occur causing this copy quality problem.

Printing quality problems

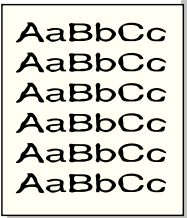
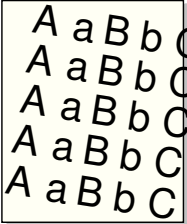
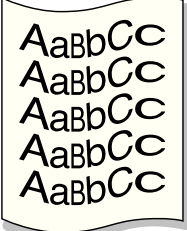
Condition	Suggested solutions
<p data-bbox="49 272 353 304">Misformed characters</p> 	<ul data-bbox="504 272 2072 304" style="list-style-type: none">• If characters are improperly formed and producing hollow images, the paper stock may be too slick. Try different paper.
<p data-bbox="49 608 203 639">Page skew</p> 	<ul data-bbox="504 608 1518 743" style="list-style-type: none">• Ensure that the paper is loaded properly.• Check the paper type and quality.• Ensure that the guides are not too tight or too loose against the paper stack.
<p data-bbox="49 951 226 983">Curl or wave</p> 	<ul data-bbox="504 951 1727 1086" style="list-style-type: none">• Ensure that the paper is loaded properly.• Check the paper type and quality. Both high temperature and humidity can cause paper curl.• Turn the stack of paper over in the tray. Also try rotating the paper 180° in the tray.

Printing quality problems

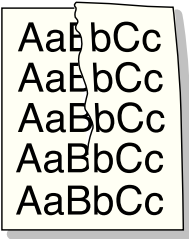
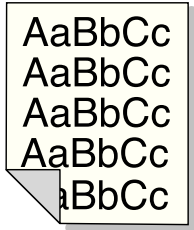
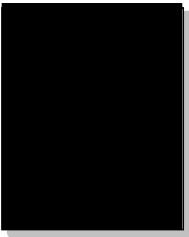
Condition	Suggested solutions
<p data-bbox="49 272 318 300">Wrinkles or creases</p> 	<ul data-bbox="504 272 1599 411" style="list-style-type: none">• Ensure that the paper is loaded properly.• Check the paper type and quality.• Turn the stack of paper over in the tray. Also try rotating the paper 180° in the tray.
<p data-bbox="49 619 412 646">Back of printouts are dirty</p> 	<ul data-bbox="504 619 1787 646" style="list-style-type: none">• Check for leaking toner. Clean the inside of the machine (see "Cleaning the machine" on page 78).
<p data-bbox="49 986 405 1013">Solid color or black pages</p> 	<ul data-bbox="504 986 2159 1161" style="list-style-type: none">• The toner cartridge may not be installed properly. Remove the cartridge and reinsert it.• The toner cartridge may be defective. Remove the toner cartridge and install a new one (see "Replacing the toner cartridge" on page 74).• The machine may require repairing. Contact a service representative.

Printing quality problems

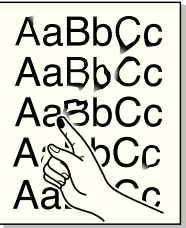
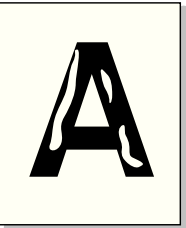
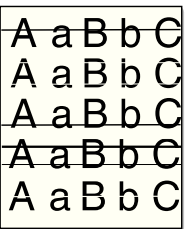
Condition	Suggested solutions
<p>Loose toner</p> 	<ul style="list-style-type: none">• Clean the inside of the machine (see "Cleaning the machine" on page 78).• Check the paper type and quality.• Remove the toner cartridge and then, install a new one (see "Replacing the toner cartridge" on page 74). <p>If the problem persists, the machine may require repair. Contact a service representative.</p>
<p>Character voids</p> 	<p>Character voids are white areas within parts of characters that should be solid black:</p> <ul style="list-style-type: none">• You may be printing on the wrong surface of the paper. Remove the paper and turn it around.• The paper may not meet paper specifications.
<p>Horizontal stripes</p> 	<p>If horizontally aligned black streaks or smears appear:</p> <ul style="list-style-type: none">• The toner cartridge may be installed improperly. Remove the cartridge and reinsert it.• The toner cartridge may be defective. Remove the toner cartridge and install a new one (see "Replacing the toner cartridge" on page 74). <p>If the problem persists, the machine may require repairing. Contact a service representative.</p>

Printing quality problems

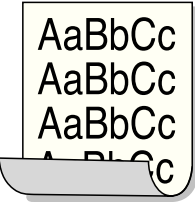
Condition	Suggested solutions
<p>Curl</p> 	<p>If the printed paper is curled or paper does not feed into the machine:</p> <ul style="list-style-type: none">• Turn the stack of paper over in the tray. Also try rotating the paper 180° in the tray.• Change the printer's paper option and try again. Go to Printing Preferences, click the Paper tab, and set type to Thin (see "Opening printing preferences" on page 50).
<ul style="list-style-type: none">• An unknown image repetitively appears on a few sheets• Loose toner• Light print or contamination occurs	<p>Your machine is probably being used at an altitude of 1,000 m (3,281 ft) or above. The high altitude may affect the print quality, such as loose toner or light imaging. Change the altitude setting for your machine (see "Altitude adjustment" on page 206).</p>

Copying problems

Condition	Suggested solutions
Copies are too light or too dark.	Adjust the darkness in copy feature to lighten or darken the backgrounds of copies (see "Changing the settings for each copy" on page 54).
Smears, lines, marks, or spots appear on copies.	<ul style="list-style-type: none">• If the defects are on the original, adjust darkness in copy feature to lighten the background of your copies.• If there are no defects on the original, clean the scan unit (see "Cleaning the scan unit" on page 82).
Copy image is skewed.	<ul style="list-style-type: none">• Ensure that the original is aligned with the registration guide.• The transfer roller may be dirty. Clean the inside of your machine (see "Cleaning the machine" on page 78).
Blank copies print out.	Ensure that the original is face down on the scanner glass or face up in the document feeder. If these steps do not correct the problem, contact a service representative.
Image rubs off the copy easily.	<ul style="list-style-type: none">• Replace the paper in the tray with paper from a new package.• In high humidity areas, do not leave paper in the machine for extended periods of time.
Frequent copy paper jams occur.	<ul style="list-style-type: none">• Fan the paper, then turn it over in the tray. Replace the paper in the tray with a fresh supply. Check/adjust the paper guides, if necessary.• Ensure that the paper is the proper type and weight (see "Print media specifications" on page 106).• Check for copy paper or pieces of copy paper remaining in the machine after a paper jam has been cleared.
Toner cartridge produces fewer copies than expected before running out of toner.	<ul style="list-style-type: none">• Your originals may contain pictures, solids, or heavy lines. For example, your originals may be forms, newsletters, books, or other documents that use more toner.• The scanner lid may be left open while copies are being made.• Turn the machine off and back on.

Scanning problems

Condition	Suggested solutions
The scanner does not work.	<ul style="list-style-type: none">• Make sure that you place the original to be scanned face down on the scanner glass, or face up in the document feeder (see "Loading originals" on page 46).• There may not be enough available memory to hold the document you want to scan. Try the Prescan function to see if that works. Try lowering the scan resolution rate.• Check that the machine printer cable is connected properly.• Make sure that the machine printer cable is not defective. Switch the printer cable with a known good cable. If necessary, replace the printer cable.
The unit scans very slowly.	<ul style="list-style-type: none">• Check if the machine is printing received data. If so, scan the document after the received data has been printed.• Graphics are scanned more slowly than text.• Communication speed slows in scan mode because of the large amount of memory required to analyze and reproduce the scanned image. Set your computer to the ECP printer mode through BIOS setting. It will help to increase the speed. For details about how to set BIOS, refer to your computer user's guide.
Message appears on your computer screen: <ul style="list-style-type: none">• Device can't be set to the H/W mode you want.• Port is being used by another program.• Port is disabled.• Scanner is busy receiving or printing data. When the current job is completed, try again.• Invalid handle.• Scanning has failed.	<ul style="list-style-type: none">• There may be a copying or printing job in progress. Try your job again when that job is finished.• The selected port is currently being used. Restart your computer and try again.• The machine printer cable may be improperly connected or the power may be off.• The scanner driver is not installed or the operating environment is not set up properly.• Ensure that the machine is properly connected and the power is on, then restart your computer.• The USB cable may be improperly connected or the power may be off.

Faxing problems

Condition	Suggested solutions
The machine is not working, there is no display, or the buttons are not working.	<ul style="list-style-type: none">• Unplug the power cord and plug it in again.• Ensure that there is power being supplied to the electrical outlet.• Ensure that the power is turned on.
No dial tone.	<ul style="list-style-type: none">• Check that the phone line is properly connected (see "Rear view" on page 20).• Check that the phone socket on the wall is working by plugging in another phone.
The numbers stored in memory do not dial correctly.	Make sure that the numbers are stored in memory correctly. To check that, print an address book list.
The original does not feed into the machine.	<ul style="list-style-type: none">• Make sure that the paper is not wrinkled and you are inserting it in correctly. Check that the original is the right size, not too thick or thin.• Make sure that the document feeder is firmly closed.• The document feeder rubber pad may need to be replaced. Contact a service representative (see "Available maintenance parts" on page 68).
Faxes are not received automatically.	<ul style="list-style-type: none">• The receiving mode should be set to fax (see "Changing the receive modes" on page 239).• Make sure that there is paper in the tray (see "Print media specifications" on page 106).• Check to see if the display shows any error message. If it does, clear the problem.
The machine does not send.	<ul style="list-style-type: none">• Make sure that the original is loaded in the document feeder or on the scanner glass.• Check the fax machine you are sending to, to see if it can receive your fax.
The incoming fax has blank spaces or is of poor-quality.	<ul style="list-style-type: none">• The fax machine sending you the fax may be faulty.• A noisy phone line can cause line errors.• Check your machine by making a copy.• A toner cartridge has almost reached its estimated cartridge life. Replace the toner cartridge (see "Replacing the toner cartridge" on page 74).

Faxing problems

Condition	Suggested solutions
Some of the words on an incoming fax are stretched.	The fax machine sending the fax had a temporary document jam.
There are lines on the originals you sent.	Check your scan unit for marks and clean it (see "Cleaning the scan unit" on page 82).
The machine dials a number, but the connection with the other fax machine fails.	The other fax machine may be turned off, out of paper, or cannot answer incoming calls. Speak with the other machine operator and ask them to solve the problem on their side.
Faxes do not store in memory.	There may not be enough memory space to store the fax. If the display indicating the memory status shows, delete any faxes you no longer need from the memory, and then try to store the fax again. Call for service.
Blank areas appear at the bottom of each page or on other pages, with a small strip of text at the top.	You may have chosen the wrong paper settings in the user option setting. Check the paper size and type again.

Operating system problems

Common Windows problems

Condition	Suggested solutions
“File in Use” message appears during installation.	Exit all software applications. Remove all software from the startup group, then restart Windows. Reinstall the printer driver.
“General Protection Fault”, “Exception OE”, “Spool 32”, or “Illegal Operation” messages appear.	Close all other applications, reboot Windows and try printing again.
“Fail To Print”, “A printer timeout error occurred” message appear.	These messages may appear during printing. Just keep waiting until the machine finishes printing. If the message appears in ready mode or after printing has completed, check the connection and/or whether an error has occurred.



Refer to the Microsoft Windows User's Guide that came with your computer for further information on Windows error messages.

Operating system problems

Common Mac problems

Condition	Suggested solutions
The machine does not print PDF files correctly. Some parts of graphics, text, or illustrations are missing.	<p>Printing the PDF file as an image may enable the file to print. Turn on Print As Image from the Acrobat printing options.</p> <p> It will take longer to print when you print a PDF file as an image.</p>
Some letters are not displayed normally during cover page printing.	<p>Mac OS cannot create the font while printing the cover page. The English alphabet and numbers are displayed normally on the cover page.</p>
When printing a document in Mac with Acrobat Reader 6.0 or higher, colors print incorrectly.	<p>Make sure that the resolution setting in your machine driver matches the one in Acrobat Reader.</p>



Refer to the Mac User's Guide that came with your computer for further information on Mac error messages.

Operating system problems

Common Linux problems

Condition	Suggested solutions
The machine does not print.	<ul style="list-style-type: none">• Check if the printer driver is installed in your system. Open Unified Driver Configurator and switch to the Printers tab in the Printers configuration window to look at the list of available machines. Make sure that your machine is displayed on the list. If not, open Add new printer wizard to set up your device.• Check if the machine is started. Open Printers configuration and select your machine from the printers list. Look at the description in the Selected printer pane. If its status contains Stopped, press the Start button. Normal operation of the machine should be restored. The “stopped” status might be activated when some problems in printing occur.• Check if your application has special print options such as “-oraw”. If “-oraw” is specified in the command line parameter, then remove it to print properly. For Gimp front-end, select “print” -> “Setup printer” and edit the command line parameter in the command item.
Some color images come out all black.	<p>This is a known bug in Ghostscript (until GNU Ghostscript version 7.05) when the base color space of the document is indexed color space and it is converted through CIE color space. Because Postscript uses CIE color space for Color Matching System, you should upgrade Ghostscript on your system to at least GNU Ghostscript version 7.06 or later. You can find recent Ghostscript versions at www.ghostscript.com.</p>
Some color images come out in unexpected color.	<p>This is a known bug in Ghostscript (until GNU Ghostscript version 7.xx) when the base color space of the document is indexed RGB color space and it is converted through CIE color space. Because Postscript uses CIE color space for Color Matching System, you should upgrade Ghostscript on your system to at least GNU Ghostscript version 8.xx or later. You can find recent Ghostscript versions at www.ghostscript.com.</p>
The machine does not print whole pages, and output is printed on half the page.	<p>It is a known problem that occurs when a color machine is used on version 8.51 or earlier of Ghostscript, 64-bit Linux OS, and has been reported to bugs.ghostscript.com as Ghostscript Bug 688252. The problem is solved in AFPL Ghostscript v. 8.52 or above. Download the latest version of AFPL Ghostscript from http://sourceforge.net/projects/ghostscript/ and install it to solve this problem.</p>

Operating system problems

Condition	Suggested solutions
I cannot scan via Gimp Front-end.	<p>Check if Gimp Front-end has Xsane:Device dialog. on the Acquire menu. If not, you should install Xsane plug-in for Gimp on the your computer. You can find Xsane plug-in package for Gimp on Linux distribution CD or Gimp home page. For the detailed information, refer to the Help for Linux distribution CD or Gimp Front-end application.</p> <p>If you wish to use another kind of scan application, refer to application's Help.</p>
"Cannot open port device file" error message appears when printing a document.	<p>Avoid changing print job parameters (e.g., via LPR GUI) while a print job is in progress. Known versions of CUPS server break the print job whenever print options are changed and then try to restart the job from the beginning. Since Unified Linux Driver locks the port while printing, the abrupt termination of the driver keeps the port locked and unavailable for subsequent print jobs. If this situation occurs, try to release the port by selecting Release port in the Port configuration window.</p>
The machine does not appear on the scanners list.	<ul style="list-style-type: none">• Ensure your machine is attached to your computer, connected properly via the USB port, and is turned on.• Ensure the scanner driver for your machine is installed in your system. Open Unified Linux Driver configurator, switch to Scanners configuration, then press Drivers. Make sure that driver with a name corresponding to your machine's name is listed in the window.• Ensure the port is not busy. Since functional components of machine (printer and scanner) share the same I/O interface (port), the situation of simultaneous access of different user applications to the same port is possible. To avoid possible conflicts, only one of them at a time is allowed to gain control over the device. The other user will encounter "device busy" response. This usually happens when starting a scan procedure. An appropriate message box appears. <p>To identify the source of the problem, open the Ports configuration and select the port assigned to your scanner, port's symbol /dev/mfp0 corresponds to LP:0 designation displayed in the scanners' options, /dev/mfp1 relates to LP:1, and so on. USB ports start at /dev/mfp4, so scanner on USB:0 relates to /dev/mfp4 respectively and so forth sequentially. In the Selected port pane, you can see if the port is occupied by another application. If this is the case, you should either wait for completion of the current job or press the Release port button, if you are sure that the present port application is not functioning properly.</p>
The machine does not scan.	<ul style="list-style-type: none">• Ensure a document is loaded into the machine, ensure your machine is connected to the computer.• If there is an I/O error while scanning.

Operating system problems



Refer to the Linux User's Guide that came with your computer for further information on Linux error messages.

Common PostScript problems

The following situations are PS language specific and may occur when several printer languages are used.

Problem	Possible cause	Solution
The PostScript file cannot be printed	The PostScript driver may not be installed correctly.	<ul style="list-style-type: none">• Install the PostScript driver (see "Software Installation" on page 130).• Print a configuration page and verify that the PS version is available for printing.• If the problem persists, contact a service representative.
Limit Check Error report prints	The print job was too complex.	You might need to reduce the complexity of the page or install more memory.
A PostScript error page prints	The print job may not be PostScript.	Make sure that the print job is a PostScript job. Check to see whether the software application expected a setup or PostScript header file to be sent to the machine.
The optional tray is not selected in the driver	The printer driver has not been configured to recognize the optional tray.	Open the PostScript driver properties, select the Device Options tab, and set the tray option.
When printing a document in Mac with Acrobat Reader 6.0 or higher, colors print incorrectly	The resolution setting in the printer driver may not be matched with the one in Acrobat Reader.	Make sure that the resolution setting in your printer driver matches the one in Acrobat Reader.



The following glossary helps you get familiar with the product by understanding the terminologies commonly used with printing as well as mentioned in this user's guide.

802.11

802.11 is a set of standards for wireless local area network (WLAN) communication, developed by the IEEE LAN/MAN Standards Committee (IEEE 802).

802.11b/g/n

802.11b/g/n can share same hardware and use the 2.4 GHz band. 802.11b supports bandwidth up to 11 Mbps, 802.11n supports bandwidth up to 150 Mbps. 802.11b/g/n devices may occasionally suffer interference from microwave ovens, cordless telephones, and Bluetooth devices.

Access point

Access Point or Wireless Access Point (AP or WAP) is a device that connects wireless communication devices together on wireless local area networks (WLAN), and acts as a central transmitter and receiver of WLAN radio signals.

ADF

An Automatic Document Feeder (ADF) is a scanning unit that will automatically feed an original sheet of paper so that the machine can scan some amount of the paper at once.

AppleTalk

AppleTalk is a proprietary suite of protocols developed by Apple, Inc for computer networking. It was included in the original Mac (1984) and is now deprecated by Apple in favor of TCP/IP networking.

BIT Depth

A computer graphics term describing the number of bits used to represent the color of a single pixel in a bitmapped image. Higher color depth gives a broader range of distinct colors. As the number of bits increases, the number of possible colors becomes impractically large for a color map. 1-bit color is commonly called as monochrome or black and white.

BMP

A bitmapped graphics format used internally by the Microsoft Windows graphics subsystem (GDI), and used commonly as a simple graphics file format on that platform.

BOOTP

Bootstrap Protocol. A network protocol used by a network client to obtain its IP address automatically. This is usually done in the bootstrap process of computers or operating systems running on them. The BOOTP servers assign the IP address from a pool of addresses to each client. BOOTP enables 'diskless workstation' computers to obtain an IP address prior to loading any advanced operating system.

CCD

Charge Coupled Device (CCD) is a hardware which enables the scan job. CCD Locking mechanism is also used to hold the CCD module to prevent any damage when you move the machine.

Collation

Collation is a process of printing a multiple-copy job in sets. When collation is selected, the device prints an entire set before printing additional copies.

Control Panel

A control panel is a flat, typically vertical, area where control or monitoring instruments are displayed. They are typically found in front of the machine.

Coverage

It is the printing term used for a toner usage measurement on printing. For example, 5% coverage means that an A4 sided paper has about 5% image or text on it. So, if the paper or original has complicated images or lots of text on it, the coverage will be higher and at the same time, a toner usage will be as much as the coverage.

CSV

Comma Separated Values (CSV). A type of file format, CSV is used to exchange data between disparate applications. The file format, as it is used in Microsoft Excel, has become a de facto standard throughout the industry, even among non-Microsoft platforms.

DADF

A Duplex Automatic Document Feeder (DADF) is a scanning unit that will automatically feed and turn over an original sheet of paper so that the machine can scan on both sides of the paper.

Default

The value or setting that is in effect when taking a printer out of its box state, reset, or initialized.

DHCP

A Dynamic Host Configuration Protocol (DHCP) is a client-server networking protocol. A DHCP server provides configuration parameters specific to the DHCP client host requesting, generally, information required by the client host to participate on an IP network. DHCP also provides a mechanism for allocation of IP addresses to client hosts.

DIMM

Dual Inline Memory Module (DIMM), a small circuit board that holds memory. DIMM stores all the data within the machine like printing data, received fax data.

DLNA

The Digital Living Network Alliance (DLNA) is a standard that allows devices on a home network to share information with each other across the network.

DNS

The Domain Name Server (DNS) is a system that stores information associated with domain names in a distributed database on networks, such as the Internet.

Dot Matrix Printer

A dot matrix printer refers to a type of computer printer with a print head that runs back and forth on the page and prints by impact, striking an ink-soaked cloth ribbon against the paper, much like a typewriter.

DPI

Dots Per Inch (DPI) is a measurement of resolution that is used for scanning and printing. Generally, higher DPI results in a higher resolution, more visible detail in the image, and a larger file size.

DRPD

Distinctive Ring Pattern Detection. Distinctive Ring is a telephone company service which enables a user to use a single telephone line to answer several different telephone numbers.

Duplex

A mechanism that will automatically turn over a sheet of paper so that the machine can print (or scan) on both sides of the paper. A printer equipped with a Duplex Unit can print on both sides of paper during one print cycle.

Duty Cycle

Duty cycle is the page quantity which does not affect printer performance for a month. Generally the printer has the lifespan limitation such as pages per year. The lifespan means the average capacity of print-outs, usually within the warranty period. For example, if the duty cycle is 48,000 pages per month assuming 20 working days, a printer limits 2,400 pages a day.

ECM

Error Correction Mode (ECM) is an optional transmission mode built into Class 1 fax machines or fax modems. It automatically detects and corrects errors in the fax transmission process that are sometimes caused by telephone line noise.

Emulation

Emulation is a technique of one machine obtaining the same results as another.

An emulator duplicates the functions of one system with a different system, so that the second system behaves like the first system. Emulation focuses on exact reproduction of external behavior, which is in contrast to simulation, which concerns an abstract model of the system being simulated, often considering its internal state.

Ethernet

Ethernet is a frame-based computer networking technology for local area networks (LANs). It defines wiring and signaling for the physical layer, and frame formats and protocols for the media access control (MAC)/data link layer of the OSI model. Ethernet is mostly standardized as IEEE 802.3. It has become the most widespread LAN technology in use during the 1990s to the present.

EtherTalk

A suite of protocols developed by Apple Computer for computer networking. It was included in the original Mac (1984) and is now deprecated by Apple in favor of TCP/IP networking.

FDI

Foreign Device Interface (FDI) is a card installed inside the machine to allow a third party device such as a coin operated device or a card reader. Those devices allow the pay-for-print service on your machine.

FTP

A File Transfer Protocol (FTP) is a commonly used protocol for exchanging files over any network that supports the TCP/IP protocol (such as the Internet or an intranet).

Fuser Unit

The part of a laser printer that fuses the toner onto the print media. It consists of a heat roller and a pressure roller. After toner is transferred onto the paper, the fuser unit applies heat and pressure to ensure that the toner stays on the paper permanently, which is why paper is warm when it comes out of a laser printer.

Gateway

A connection between computer networks, or between a computer network and a telephone line. It is very popular, as it is a computer or a network that allows access to another computer or network.

Grayscale

A shades of gray that represent light and dark portions of an image when color images are converted to grayscale; colors are represented by various shades of gray.

Halftone

An image type that simulates grayscale by varying the number of dots. Highly colored areas consist of a large number of dots, while lighter areas consist of a smaller number of dots.

Mass storage device (HDD)

Mass storage device (HDD), commonly referred to as a hard drive or hard disk, is a non-volatile storage device which stores digitally-encoded data on rapidly rotating platters with magnetic surfaces.

IEEE

The Institute of Electrical and Electronics Engineers (IEEE) is an international non-profit, professional organization for the advancement of technology related to electricity.

IEEE 1284

The 1284 parallel port standard was developed by the Institute of Electrical and Electronics Engineers (IEEE). The term "1284-B" refers to a specific connector type on the end of the parallel cable that attaches to the peripheral (for example, a printer).

Intranet

A private network that uses Internet Protocols, network connectivity, and possibly the public telecommunication system to securely share part of an organization's information or operations with its employees. Sometimes the term refers only to the most visible service, the internal website.

IP address

An Internet Protocol (IP) address is a unique number that devices use in order to identify and communicate with each other on a network utilizing the Internet Protocol standard.

IPM

The Images Per Minute (IPM) is a way of measuring the speed of a printer. An IPM rate indicates the number of single-sided sheets a printer can complete within one minute.

IPP

The Internet Printing Protocol (IPP) defines a standard protocol for printing as well as managing print jobs, media size, resolution, and so forth. IPP can be used locally or over the Internet to hundreds of printers, and also supports access control, authentication, and encryption, making it a much more capable and secure printing solution than older ones.

IPX/SPX

IPX/SPX stands for Internet Packet Exchange/Sequenced Packet Exchange. It is a networking protocol used by the Novell NetWare operating systems. IPX and SPX both provide connection services similar to TCP/IP, with the IPX protocol having similarities to IP, and SPX having similarities to TCP. IPX/SPX was primarily designed for local area networks (LANs), and is a very efficient protocol for this purpose (typically its performance exceeds that of TCP/IP on a LAN).

ISO

The International Organization for Standardization (ISO) is an international standard-setting body composed of representatives from national standards bodies. It produces world-wide industrial and commercial standards.

ITU-T

The International Telecommunication Union is an international organization established to standardize and regulate international radio and telecommunications. Its main tasks include standardization, allocation of the radio spectrum, and organizing interconnection arrangements between different countries to allow international phone calls. A -T out of ITU-T indicates telecommunication.

ITU-T No. 1 chart

Standardized test chart published by ITU-T for document facsimile transmissions.

JBIG

Joint Bi-level Image Experts Group (JBIG) is an image compression standard with no loss of accuracy or quality, which was designed for compression of binary images, particularly for faxes, but can also be used on other images.

JPEG

Joint Photographic Experts Group (JPEG) is a most commonly used standard method of lossy compression for photographic images. It is the format used for storing and transmitting photographs on the World Wide Web.

LDAP

The Lightweight Directory Access Protocol (LDAP) is a networking protocol for querying and modifying directory services running over TCP/IP.

LED

A Light-Emitting Diode (LED) is a semiconductor device that indicates the status of a machine.

MAC address

Media Access Control (MAC) address is a unique identifier associated with a network adapter. MAC address is a unique 48-bit identifier usually written as 12 hexadecimal characters grouped in pairs (e. g., 00-00-0c-34-11-4e). This address is usually hard-coded into a Network Interface Card (NIC) by its manufacturer, and used as an aid for routers trying to locate machines on large networks.

MFP

Multi Function Peripheral (MFP) is an office machine that includes the following functionality in one physical body, so as to have a printer, a copier, a fax, a scanner and etc.

MH

Modified Huffman (MH) is a compression method for decreasing the amount of data that needs to be transmitted between the fax machines to transfer the image recommended by ITU-T T.4. MH is a codebook-based run-length encoding scheme optimized to efficiently compress white space. As most faxes consist mostly of white space, this minimizes the transmission time of most faxes.

MMR

Modified Modified READ (MMR) is a compression method recommended by ITU-T T.6.

Modem

A device that modulates a carrier signal to encode digital information, and also demodulates such a carrier signal to decode transmitted information.

MR

Modified Read (MR) is a compression method recommended by ITU-T T.4. MR encodes the first scanned line using MH. The next line is compared to the first, the differences determined, and then the differences are encoded and transmitted.

Glossary

NetWare

A network operating system developed by Novell, Inc. It initially used cooperative multitasking to run various services on a PC, and the network protocols were based on the archetypal Xerox XNS stack. Today NetWare supports TCP/IP as well as IPX/SPX.

OPC

Organic Photo Conductor (OPC) is a mechanism that makes a virtual image for print using a laser beam emitted from a laser printer, and it is usually green or rust colored and has a cylinder shape.

An imaging unit containing a drum slowly wears the drum surface by its usage in the printer, and it should be replaced appropriately since it gets worn from contact with the cartridge development brush, cleaning mechanism, and paper.

Originals

The first example of something, such as a document, photograph or text, etc, which is copied, reproduced or translated to produce others, but which is not itself copied or derived from something else.

OSI

Open Systems Interconnection (OSI) is a model developed by the International Organization for Standardization (ISO) for communications. OSI offers a standard, modular approach to network design that divides the required set of complex functions into manageable, self-contained, functional layers. The layers are, from top to bottom, Application, Presentation, Session, Transport, Network, Data Link and Physical.

PABX

A private automatic branch exchange (PABX) is an automatic telephone switching system within a private enterprise.

PCL

Printer Command Language (PCL) is a Page Description Language (PDL) developed by HP as a printer protocol and has become an industry standard. Originally developed for early inkjet printers, PCL has been released in varying levels for thermal, dot matrix printer, and laser printers.

PDF

Portable Document Format (PDF) is a proprietary file format developed by Adobe Systems for representing two dimensional documents in a device independent and resolution independent format.

PostScript

PostScript (PS) is a page description language and programming language used primarily in the electronic and desktop publishing areas. - that is run in an interpreter to generate an image.

Printer Driver

A program used to send commands and transfer data from the computer to the printer.

Print Media

The media like paper, envelopes, labels, and transparencies which can be used in a printer, a scanner, a fax or, a copier.

PPM

Pages Per Minute (PPM) is a method of measurement for determining how fast a printer works, meaning the number of pages a printer can produce in one minute.

PRN file

An interface for a device driver, this allows software to interact with the device driver using standard input/output system calls, which simplifies many tasks.

Protocol

A convention or standard that controls or enables the connection, communication, and data transfer between two computing endpoints.

PS

See PostScript.

PSTN

The Public-Switched Telephone Network (PSTN) is the network of the world's public circuit-switched telephone networks which, on industrial premises, is usually routed through the switchboard.

RADIUS

Remote Authentication Dial In User Service (RADIUS) is a protocol for remote user authentication and accounting. RADIUS enables centralized management of authentication data such as usernames and passwords using an AAA (authentication, authorization, and accounting) concept to manage network access.

Resolution

The sharpness of an image, measured in Dots Per Inch (DPI). The higher the dpi, the greater the resolution.

SMB

Server Message Block (SMB) is a network protocol mainly applied to share files, printers, serial ports, and miscellaneous communications between nodes on a network. It also provides an authenticated Inter-process communication mechanism.

SMTP

Simple Mail Transfer Protocol (SMTP) is the standard for e-mail transmissions across the Internet. SMTP is a relatively simple, text-based protocol, where one or more recipients of a message are specified, and then the message text is transferred. It is a client-server protocol, where the client transmits an email message to the server.

SSID

Service Set Identifier (SSID) is a name of a wireless local area network (WLAN). All wireless devices in a WLAN use the same SSID in order to communicate with each other. The SSIDs are case-sensitive and have a maximum length of 32 characters.

Subnet Mask

The subnet mask is used in conjunction with the network address to determine which part of the address is the network address and which part is the host address.

TCP/IP

The Transmission Control Protocol (TCP) and the Internet Protocol (IP); the set of communications protocols that implement the protocol stack on which the Internet and most commercial networks run.

TCR

Transmission Confirmation Report (TCR) provides details of each transmission such as job status, transmission result and number of pages sent. This report can be set to print after each job or only after failed transmissions.

TIFF

Tagged Image File Format (TIFF) is a variable-resolution bitmapped image format. TIFF describes image data that typically come from scanners. TIFF images make use of tags, keywords defining the characteristics of the image that is included in the file. This flexible and platform-independent format can be used for pictures that have been made by various image processing applications.

Toner Cartridge

A kind of bottle or container used in a machine like a printer which contains toner. Toner is a powder used in laser printers and photocopiers, which forms the text and images on the printed paper. Toner can be fused by a combination of heat/pressure from the fuser, causing it to bind to the fibers in the paper.

TWAIN

An industry standard for scanners and software. By using a TWAIN-compliant scanner with a TWAIN-compliant program, a scan can be initiated from within the program. It is an image capture API for Microsoft Windows and Apple Mac operating systems.

UNC Path

Uniform Naming Convention (UNC) is a standard way to access network shares in Window NT and other Microsoft products. The format of a UNC path is:
\\<servername>\<sharename>\<Additional directory>

URL

Uniform Resource Locator (URL) is the global address of documents and resources on the Internet. The first part of the address indicates what protocol to use, the second part specifies the IP address or the domain name where the resource is located.

USB

Universal Serial Bus (USB) is a standard that was developed by the USB Implementers Forum, Inc., to connect computers and peripherals. Unlike the parallel port, USB is designed to concurrently connect a single computer USB port to multiple peripherals.

Watermark

A watermark is a recognizable image or pattern in paper that appears lighter when viewed by transmitted light. Watermarks were first introduced in Bologna, Italy in 1282; they have been used by papermakers to identify their product, and also on postage stamps, currency, and other government documents to discourage counterfeiting.

WEP

Wired Equivalent Privacy (WEP) is a security protocol specified in IEEE 802.11 to provide the same level of security as that of a wired LAN. WEP provides security by encrypting data over radio so that it is protected as it is transmitted from one end point to another.

WIA

Windows Imaging Architecture (WIA) is an imaging architecture that is originally introduced in Windows Me and Windows XP. A scan can be initiated from within these operating systems by using a WIA-compliant scanner.

WPA

Wi-Fi Protected Access (WPA) is a class of systems to secure wireless (Wi-Fi) computer networks, which was created to improve upon the security features of WEP.

WPA-PSK

WPA-PSK (WPA Pre-Shared Key) is special mode of WPA for small business or home users. A shared key, or password, is configured in the wireless access point (WAP) and any wireless laptop or desktop devices. WPA-PSK generates a unique key for each session between a wireless client and the associated WAP for more advanced security.

WPS

The Wi-Fi Protected Setup (WPS) is a standard for establishing a wireless home network. If your wireless access point supports WPS, you can configure the wireless network connection easily without a computer.

XPS

XML Paper Specification (XPS) is a specification for a Page Description Language (PDL) and a new document format, which has benefits for portable document and electronic document, developed by Microsoft. It is an XML-based specification, based on a new print path and a vector-based device-independent document format.

Index

A

address book	
editing	209
general setup	202, 210, 209
registering	208
using	208
address book setup	208

B

buttons	
eco	21
id copy	21
numeric keypad	22
wps	21

C

cleaning	
inside	79
outside	78
pickup roller	81
scan unit	82
cleaning a machine	78
control panel	21
convention	11

copy	
general setup	180
copying	
basic copying	54
reducing or enlarging copies	56

D

default settings	
tray setting	44
Dell printer experience	256
Dell Printer Status	254
direct printing utility	220
document box	203
general setup	203

E

eco printing	52
email	
general setup	202
Embedded Web Service	249
emulation	
general setup	201
emulation setup	201
entering character	207

error message	98
---------------	----

F

favorites settings, for printing	51
fax	
adding documents to a reserved fax	236, 233
canceling a reserved fax job	236, 239
delaying a fax transmission	235
forwarding a received fax to another destination	237
general setup	187
printing faxes on both sides of the paper	242
Printing sent fax report automatically	243
receiving a fax in the computer	238, 242, 240, 241, 240, 233
sending a fax in the computer	234, 236, 238
fax feature	233
fax sending	
multi sending	62
faxing	
adjusting darkness	64, 63
preparing to fax	60

Index

receiving in Fax mode	63	browsing the machine status	180, 186, 187, 192, 196	using SetIP	139
features	5			macintosh scanning	229
machine features	177	Linux		maintenance parts	68
print media feature	106	common Linux problems	285	manual feeding	
firmware update utility	247	driver installation for network connected	145, 133, 135	loading	40
front view	18	printer properties	224, 223	memory/hard drive feature	244
G		scanning	230	menu overview	29
general icons	11	unified driver configurator	261, 140	multi-purpose tray	
general settings	193	linux scanning	230	tips on using	40
glossary	288	loading		using special media	40
I		paper in the tray1	38	N	
id copy	57	special media	40	network	
installation		loading originals	46	driver installation	
accessories	69	M		Linux	145
J		machine information	180, 186, 187, 192, 196	Macintosh	144
jam		machine setup		Windows	141
clearing original document	87, 92	machine status	180, 186, 187, 192, 196	general setup	203, 204
tips for avoiding paper jams	86	Macintosh		installing environment	112, 137
L		common Macintosh problems	284	IPv6 configuration	147
LCD display		driver installation for network connected	144, 131, 132	SetIP program	138, 139, 140, 171
		printing	221	wired network setup	138, 149
		scanning	229, 110	n-up printing	
				Macintosh	222

Index

O

optional memory	
setting up the optional memory	244
output support	45
overlay printing	
create	218
delete	218
print	218

P

placing a machine	
adjusting the altitude	206
postScript driver	
troubleshooting	287
preparing originals type	45
print	
general setup	179
mobile OS	173
print media	
card stock	43
envelope	41
labels	42
output support	106
preprinted paper	43

setting the paper size	44, 40
print menu	179
printer preferences	
Linux	224
printing	
changing the default print settings	212
Linux	223
Macintosh	221
multiple pages on one sheet of paper	
Macintosh	222
printing a document	
Windows	49
Macintosh	222
	213
setting as a default machine	212, 214
using direct printing utility	220
printing a document	
Linux	223
Macintosh	221
printing feature	212
problem	
operating system problems	283
problems	
copying problems	279

faxing problems	281
paper feeding problems	265, 266, 267, 271
scanning problems	280

R

rear view	20
regulatory information	113
reports	
machine information	180, 187, 188, 189, 192, 193, 196, 197
resolution	
faxing	63

S

safety	
information	12
symbols	12
scan	
general setup	191
Scan Assitant	228
scan feature	225
Scanning	
Scanning with Dell Scan Assitant	228
scanning	

Index

basic information	225	storing	70	driver installation for network connected	
Linux scanning	230	tray		141,	24, 27
Macintosh scanning	229	adjusting the width and length	37	system requirements	109
Scanning from image editing program	227,	changing the tray size	37	using SetIP	138, 171
226,	228	manual feeding	40	wireless	
SetIP program	138, 171	setting the paper size and type	44	ad hoc mode	149
Special features	205			Infrastructure mode	149
specifications	104	U		USB cable	159
print media	106	understanding the status LED	96	WPS	
status	22	Unix		disconnecting	152
supplies		system requirements	111	PBC	153
available supplies	67	usb	201	wireless network	
estimated toner cartridge life	71	general setupusb	201	network cable	170
monitoring the supplies life	76	USB cable			
ordering	67	driver installation	24, 27, 131, 133, 132, 135		
replacing toner cartridge	74	using help	52, 223		
Supplies Ordering Utility	248	W			
T		watermark			
toner cartridge		create	217		
estimated life	71	delete	217		
handling instructions	70	edit	217		
non-Dell and refilled	70	Windows			
redistributing toner	72, 74	common Windows problems	283		