



C5t/F5t Tablet PC

Model CFT-003

User's Guide

© 2012 Motion Computing, Inc. All rights reserved.

This document contains information protected by copyright. No part of this document may be reproduced in any form without written consent from Motion.

The information in this document is provided "as is" and is subject to change without notice. Motion is not liable for errors or omissions in this document.

Motion, Motion Computing, Speak Anywhere, View Anywhere, and QuickNav are trademarks or registered trademarks of Motion Computing, Inc. in the U.S.A. and other countries.

Acrobat is a registered trademark of Adobe Systems Incorporated.

Bluetooth is a registered trademark owned by the Bluetooth SIG, Inc., U.S.A. and licensed to Motion Computing, Inc.

Intel, Intel Atom, Core, vPro, and Centrino are trademarks or registered trademarks of Intel Corporation or its subsidiaries in the United States and other countries.

Computrace is a registered trademark of Absolute Software Corp.

OmniPass is a trademark of Softex, Inc.

Realtek is a trademark of Realtek Semiconductor Corporation.

Microsoft, Windows, and Windows Journal are trademarks or registered trademarks of Microsoft Corporation in the United States and/or other countries.

Qualcomm, Gobi, and Gobi 3000 are trademarks or registered trademarks of Qualcomm Incorporated.

Wi-Fi is a registered trademark of the Wi-Fi Alliance.

HDMI, the HDMI logo, and High-Definition Multimedia Interface are trademarks of HDMI Licensing LLC in the United States and other countries.

Insyde and InsydeH₂O are trademarks of Insyde Software Corporation.

End users may not loan, rent, lease, lend, or otherwise transfer the CDs or DVDs provided for recovery purposes to another user, except as permitted in the End User License Agreement for such product.

This product incorporates copy protection technology that is protected by U.S. and foreign patents, including patent numbers 5,315,448 and 6,836,549, and other intellectual property rights. The use of Macrovision's copy protection technology in the product must be authorized by Macrovision. Reverse engineering or disassembly is prohibited.

Model CFT-003
PN 024-02-0335-A00

Motion Computing, Inc. has made every effort to identify trademarked properties and owners on this page. All brands and product names used in this document are for identification purposes only and may be trademarks or registered trademarks of their respective companies.

The warranties for Motion products are set forth in the express limited warranty statements accompanying such products. Nothing in this document constitutes an additional warranty.

The Motion Computing products and services may be covered by one or more patent-protected inventions. Additional patents may also be pending. For more information, see www.motioncomputing.com/info/patents.asp.

The end user may access only one operating system language version.

L'utilisateur final ne peut accéder qu'à une seule version linguistique du système d'exploitation.

Der Endbenutzer darf nur auf eine Sprachversion des Betriebssystems zugreifen.

De eindgebruiker heeft slechts toegang tot één taalversie van het besturingssysteem.

L'utente finale può accedere a una sola lingua del sistema operativo.

El usuario final sólo podrá acceder a una versión de idioma del sistema operativo.

Loppukäyttäjä voi käyttää vain yhtä käyttöjärjestelmän kieliversiota.

Användaren har endast tillgång till en språkversion av operativsystemet.

Slutbrugeren har kun adgang til ét af operativsystemets sprogversioner.

Sluttbruker kan aksessere kun én av operativsystemets språkversjoner.

O utilizador final pode alcançar somente uma versão de língua do sistema de exploração.

O usuário final pode acessar apenas uma versão de idioma do sistema operacional.

Contents

Chapter 1 Getting Started	1
Optional features	2
Mobile broadband with GPS	2
Discrete GPS with WAAS, EGNOS, and MSAS (optional)	2
Security	2
View Anywhere display	3
Other optional features	3
Overview of the C5t/F5t	4
Top side	4
Front	5
Right side	6
Back	7
Pen	8
Where to begin with your C5t/F5t	9
Step 1: Power up the tablet	9
Step 2: Connect to a wireless network	10
Step 3: Get familiar with your C5t/F5t Tablet PC	12
Step 4: When you take a break	12
Optional setup tasks	14
Create a recovery image	14
Attach the pen tether	14
Connect the tablet to a docking station	14
Connect the tablet to a display monitor	14
For more information	15
Chapter 2 Using your C5t/F5t	16
Introducing the C5t/F5t desktop and applications	17
Changing the taskbar	17
Using the Motion Dashboard	18
Accessing Motion tools from the Windows® notification area	19
Using touch	20
Calibrate touch	21
How to use gestures with the multiple-touch display	21
Changing to one-tap open for touch	21
Configuring touch input mode	22
Adjusting touch settings	22
Adjusting pen settings	23
Adjusting Tablet PC settings	23
Entering text and handwriting recognition	24
Opening and closing the input panel	25
Docking or floating the input panel	26
Entering numbers with numbers pad	26

Entering special keys with the extended keyboard	27
Using the handwriting recognition program	27
Using the front panel buttons	28
Configuring front panel buttons	29
Setting display options	29
Adjusting the display brightness	29
Rotating the display orientation	30
Enabling or disabling automatic rotation	30
Setting up an external display	30
Using the built-in microphones	33
Using speech recognition	33
Setting up speech recognition	33
Using dictation and voice commands	34
Using the cameras	35
Using the web camera	35
Using the documentation camera	35
Using the barcode scanner	36
Supported barcode types	36
Barcode scanner tips	37
Using the RFID reader	38
Using the battery	39
Checking tablet battery power	39
Removing and replacing the battery	41
Hot-swapping the battery	43
Long-term battery storage	43
Disposing of used batteries	43
Battery and power management tips	44
Changing the power plan	44
Changing how the power button functions	45
Using Wi-Fi (802.11 a/g/n)	45
Enabling or disabling Wi-Fi	45
Setting up a Wi-Fi connection	46
Using Mobile Broadband with GPS	46
Enabling Mobile Broadband with GPS	46
Using the GPS receiver	47
Using the Connection Manager	47
Using the discrete GPS receiver with WAAS, EGNOS, and MSAS	47
Using Bluetooth	48
Enabling or disabling Bluetooth	48
Setting up a Bluetooth device	48
Using the fingerprint reader	49
Starting the OmniPass application	50
Create an OmniPass user account	51
Replace your passwords	52
Setting up strong logon security	52
Using the smart card reader	53
Using the SIM card slot	54
Using Windows® Action Center	56
Setting up user accounts	56
Locating your serial number	57
Backing up your system	57

Restoring your system	57
Creating a system image.....	58
Restoring your system image from Windows® Control Panel	58
Restoring your system image if you can't start Windows® 7	59
Restoring your system without a system image.....	59
Finding other software	60

Chapter 3 Caring for your C5t/F5t61

General care.....	61
Caring for the display	62
Cleaning solutions.....	62
Caring for the pen	62
Replacing pen tips.....	63
Cleaning in a healthcare environment.....	63
Disinfecting procedures	63
Training and documentation considerations	64
Cleaning the fingerprint reader	64
Caring for the tablet battery	64
Traveling with your C5t/F5t Tablet PC.....	65

Chapter 4 Troubleshooting and FAQs.....66

Troubleshooting	66
Power issues	66
Battery issues	68
Display issues	68
Touch or pen issues	69
Ports and connectors issues.....	70
Network issues	71
Audio issues.....	74
System issues	74
Frequently asked questions.....	75

Index.....77

Getting Started

1

The Motion® C5t/F5t Tablet PCs are rugged, powerful, and mobile, providing real-time access to information in the field.

The C5t/F5t Tablet PCs includes these features:

- Intel® Core™ i3, i5, or i7 vPro™ Processors (i7 Processor includes Intel vPro™ technology)
- Windows® 7 Professional (32-bit or 64-bit)
- USB 2.0/3.0 port
- mSATA SSD
- up to 1600MHz DDR3L SDRAM memory
- Intel® HD Graphics 4000
- 10.4" XGA TFT LCD with 1024 × 768 native resolution
- Corning® Gorilla® Glass for increased display damage resistance
- Bright AAFS+LED Backlight Display Technology
- Dual input—digitizer pen and multi-touch
- View Anywhere® display for optimal viewing in all lighting conditions*
- Intel Display Power Saving Technology (DPST)
- Hot-swappable battery
- Integrated Wi-Fi® and Bluetooth®
- Integrated mobile broadband and global positioning system (GPS) receiver*
- Integrated 1.3 MP web camera and 3.0 MP documentation camera*
- Integrated fingerprint reader with OmniPass software
- Integrated 1D/2D barcode reader*
- Integrated 13.56-MHz passive RFID reader/writer*
- Smart card reader*; ISO 7816 PC/SC compliant, contact type smart card reader/writer
- Trusted Platform Module (TPM) for hardware-based security and optional Computrace® Complete, which allows you to identify your Tablet PC in the case of loss or theft.

* Optional features are available when you purchase your tablet.

Optional features

This section describes the optional features available when you purchase your C5t/F5t.

Mobile broadband with GPS

You can purchase a C5t/F5t Tablet PC with an optional embedded mobile broadband with GPS module that enables you to connect to a variety of mobile broadband networks for sending and receiving data wirelessly. You can typically use mobile broadband anywhere you can use your mobile phone. Mobile broadband is based on cellular network technology, so you can use it in more places than other wireless technologies.

The GPS receiver uses satellites to determine the current location, altitude, heading, and horizontal velocity of the C5t/F5t. The augmentation feature uses signals from geostationary satellites to improve on the reliability and accuracy of the signals from the GPS satellites. You don't need a network connection or an account with a mobile broadband network carrier to use the GPS receiver. You can use it with your preferred mapping applications to find your current and desired locations.

Motion Connection Manager is an application that you can use to manage your mobile broadband and GPS network connections. For information on setting up mobile broadband, see [Set up mobile broadband with GPS](#) on page 10.

Discrete GPS with WAAS, EGNOS, and MSAS (optional)

Your tablet may have an embedded discrete global positioning system (GPS) module that supports the Wide Area Augmentation System (WAAS) for improved accuracy in the United States; European Geostationary Navigation Overlay Service (EGNOS) for improved accuracy in Europe; and Multi-functional Satellite Augmentation System (MSAS) for improved accuracy in Japan. The proper Augmentation system will be detected based on your location. No special selection is required.

Security

Your C5t/F5t includes several features that you can use to enhance the security of your data and serve as the foundation for complementary security technologies. The core security features include password-protected BIOS, networking control, optional Computrace® Complete tracking software, a built-in fingerprint reader, Dashboard Security Center, and Trusted Platform Module (TPM) 1.2.

TPM

With the built-in TPM and Infineon Security Platform Tools, you can create and manage digital certificates, user and device authentication, full disk data encryption, and restricted network access. These features are most commonly used by enterprises and enabled by the system administrator. To download and install TPM, go to <http://>

www.motioncomputing.com/support/driver_download.asp, select the link to the operating system for your Tablet PC, and then scroll down to (TPM) Trusted Platform Module Software.

Computrace® Complete

The C5t/F5t Tablet PC can be purchased with the optional Computrace® Complete, which offers enhanced data protection, improved IT asset management, and managed computer theft recovery. With Computrace, organizations can track, manage, and secure their entire computer fleet, including remote and mobile devices, on or off the network.

View Anywhere display

The View Anywhere display option enhances outdoor viewing and bright-light viewing environments. The View Anywhere display includes all the features of the standard display plus:

- A protective layer that improves the sunlight contrast ratio and significantly reduces reflection and glare.
- Improved sunlight contrast ratio, which enhances viewability at wide viewing angles.
- Reduced reflection and glare and improved light pass-through efficiency.

Other optional features

Other C5t/F5t optional features include:





- Web and documentation cameras—See [Using the cameras](#) on page 35.
- Barcode scanner—See [Using the barcode scanner](#) on page 36.
- RFID reader—See [Using the RFID reader](#) on page 38.
- Smart card reader—See [Using the smart card reader](#) on page 53.

Overview of the C5t/F5t

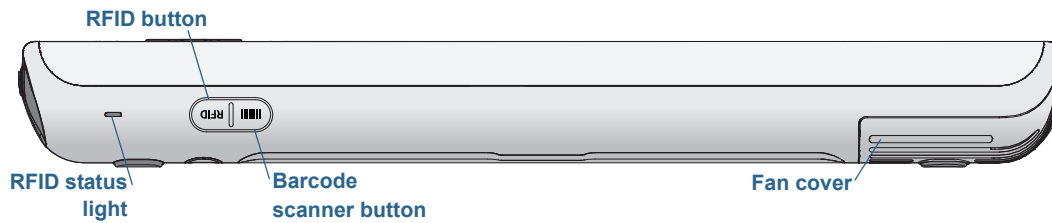
The following illustrations show the buttons, slots, and ports on the C5t/F5t Tablet PC.

Top side



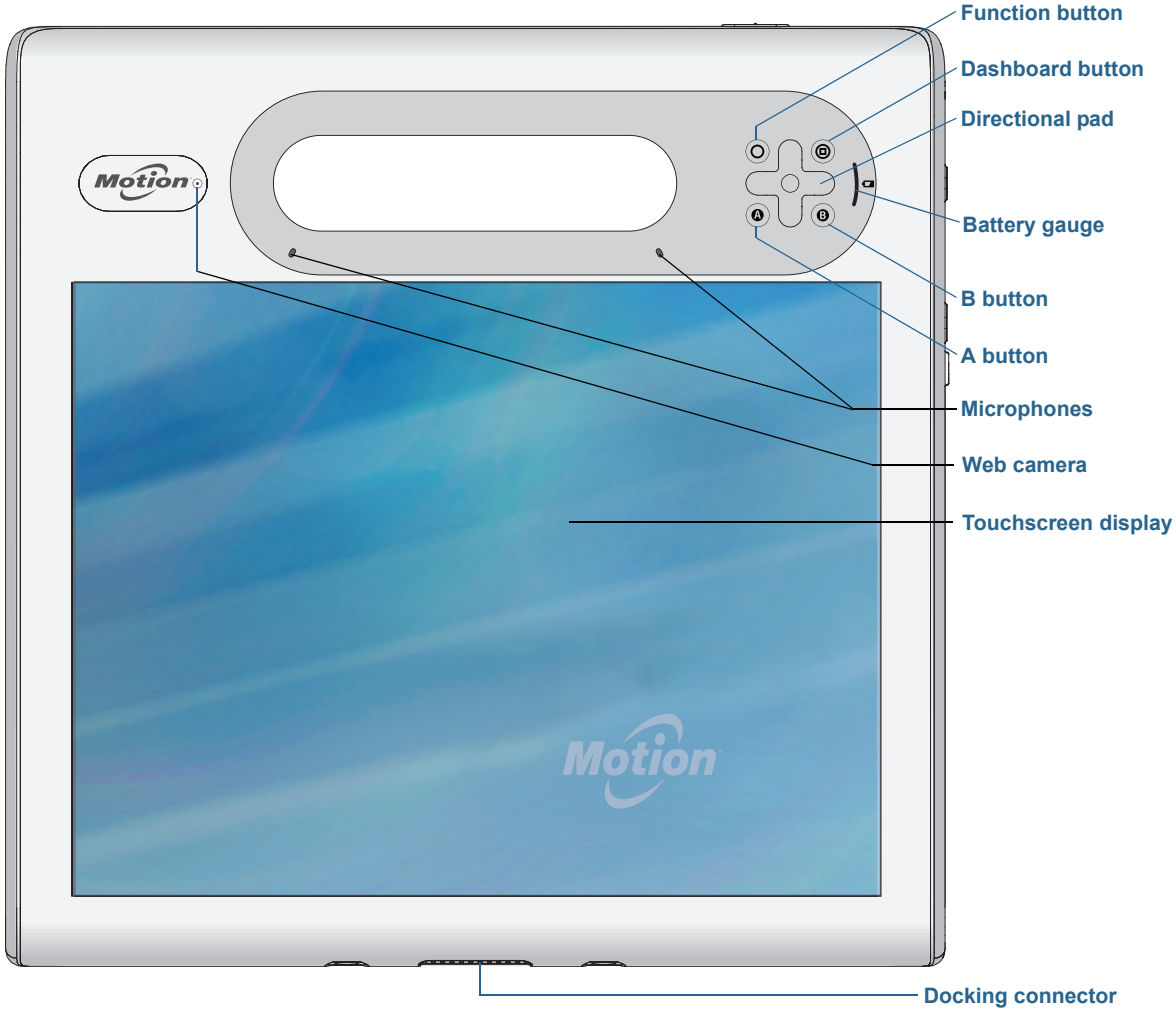

	RFID (optional) status light	Shows the status of the RFID reader.
	RFID reader (optional) button	Use to trigger the RFID reader.
	Barcode scanner (optional) button	Use to trigger the barcode scanner.
	Fan cover	Protects the fan assembly.

Front







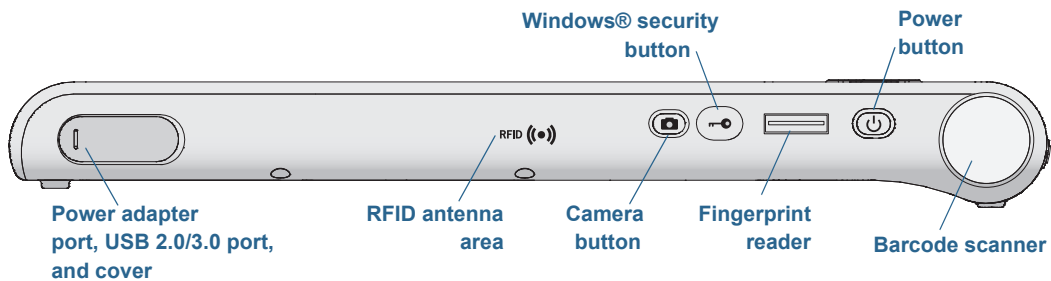

	Function button	Activate secondary functions for other buttons.
	Dashboard button	Open Motion Dashboard.
	Directional pad	Use for basic navigation. Equivalent to the arrow keys on a keyboard. The center button is equivalent to the Enter key.
	A button	Set up a custom action.
	B button	Set up a custom action.
	Battery gauge	Shows battery status.







	Microphones	Record sounds and use for speech recognition.
	Web camera (optional)	Interact over the web.
	Touchscreen display	Use your finger or pen to navigate the tablet.
	Docking connector	Connect to a C5t/F5t docking station.

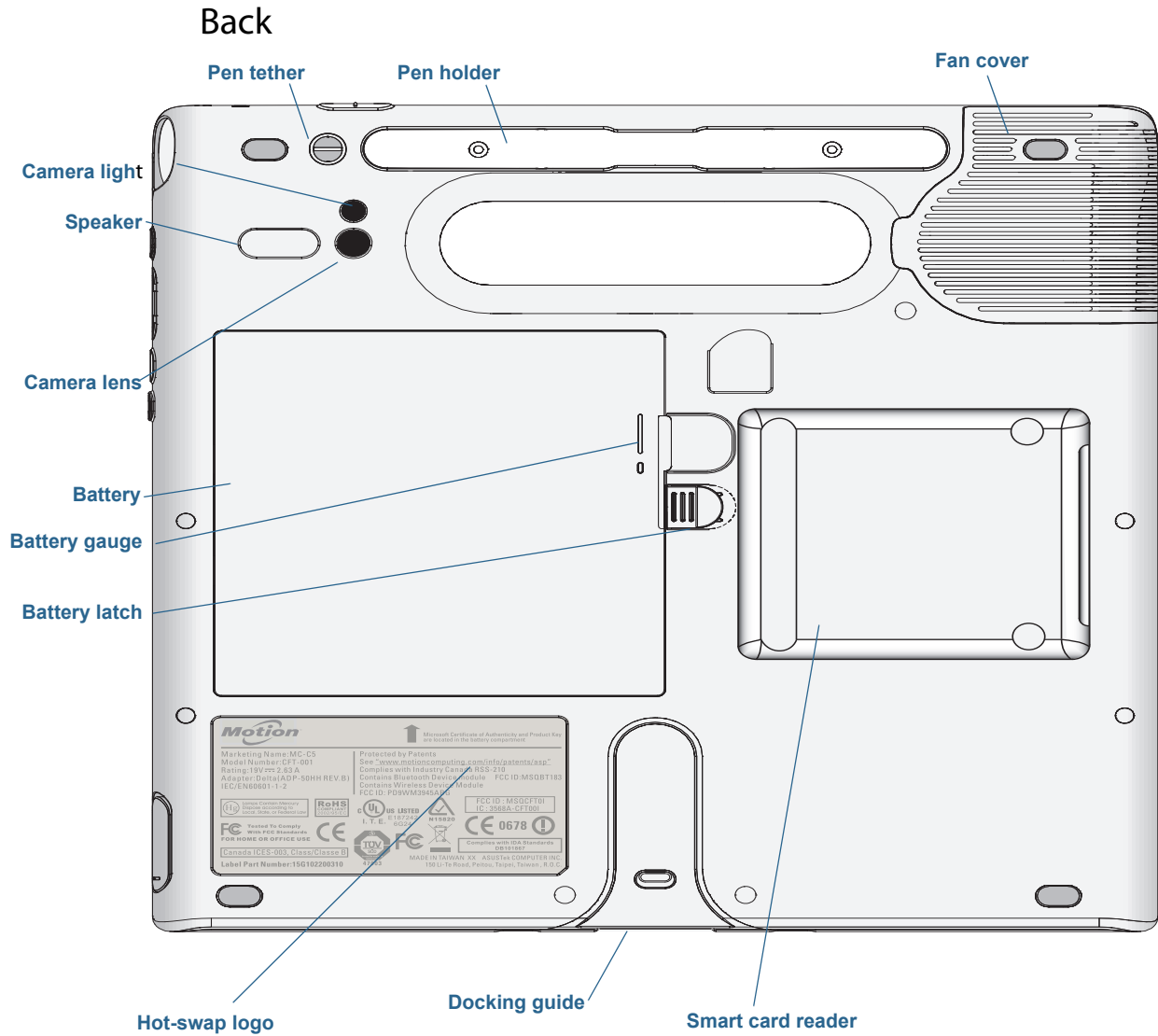

Right side



	Power adapter port, USB port, and cover	Connect the power adapter.
	RFID (optional) antenna area	Scan area for reading RFID tags.
	Camera (optional) button	Use to activate the built-in documentation camera.
	Windows® Security button	Use to log on to or lock the tablet. Equivalent to Ctrl+Alt+Del on a keyboard.
	Fingerprint reader	Scan your fingerprints for added security. You can also use the fingerprint reader as a navigation device.
	Power button	Turns the tablet on and off.
	Barcode scanner (optional)	Reads codes from barcode labels.



	Pen tether	Attach the pen tether.
	Pen holder	Use to store the pen when not in use.
	Fan cover	Protects the fan assembly.
	Camera (optional) lens	Capture images to the hard drive.
	Camera (optional) light	Provides light for the documentation camera.
	Speaker	Use for listening to audio.

	Battery	Powers the tablet when it is not plugged in or docked. Note: The Microsoft® Windows® Certificate of Authenticity is located under the battery.
	Battery gauge	Indicates the level of battery charge when you press the button next to the gauge.
	Battery latch	Opens the battery compartment's door.
	Hot-swap logo	Indicates that you can hot-swap the battery.
	Docking guide	Aligns the unit with the docking station (sold separately).
	Smart card reader (optional)	Reads information on a smart card.

Pen

The C5t/F5t Tablet PC supports touch with a pen as well as with your finger. You may find the pen handy when you want to write a quick email or take notes. The pen is particularly effective for precise data entry and navigation.

The pen includes a pressure-sensitive tip, a function button, and an eraser. The pen contains no batteries and requires no external power.

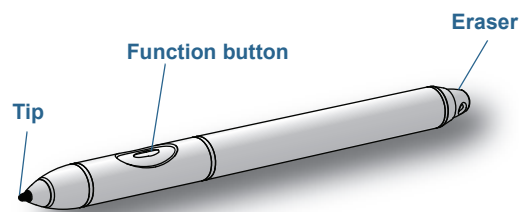

C5t/F5t pen

You can purchase additional pens from the [Motion Computing Accessories](#) page. For more information on using the pen, see [Using touch](#) on page 20.

Where to begin with your C5t/F5t

This section includes some steps you can follow to power up and get familiar with your C5t/F5t Tablet PC.

Step 1: Power up the tablet

1. Pull out the port door located at the bottom of the right side of the C5t/F5t to expose the AC adapter port and plug in the AC adapter.
2. Plug the power cord into an outlet.
 - The battery gauge turns amber to indicate that the battery is charging.
 - Keep the tablet on AC power until the battery is fully charged.

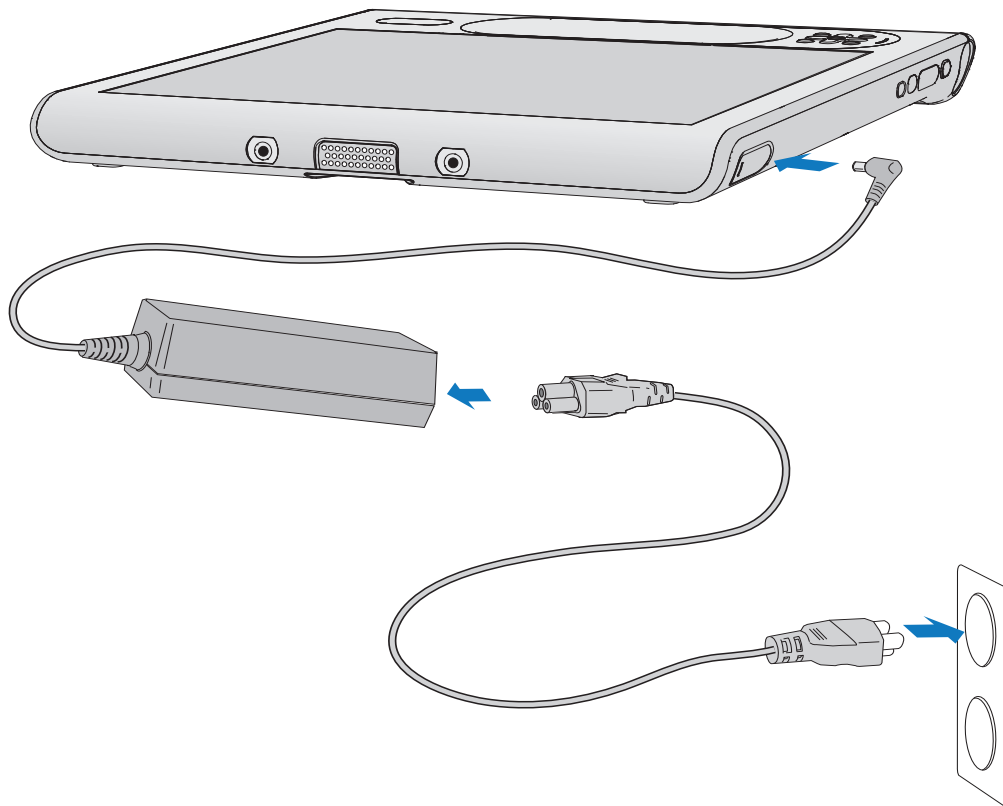

Power up the C5t/F5t

3. Press and release the power button  located on the top right side of the C5t/F5t to turn it on.

NOTE: You don't have to wait until the Tablet PC is fully charged before using it. However, it is recommended that you keep the power adapter plugged into an outlet so your C5t/F5t can continue charging.

4. Follow the on-screen instructions to set up your user account and activate Windows® 7.

Step 2: Connect to a wireless network

The C5t/F5t comes with built-in Wi-Fi and Bluetooth. Your Tablet PC may also include mobile broadband with GPS.

To set up available wireless networks:

- [Enable wireless from the Motion Dashboard](#)
- [Set up Wi-Fi](#)
- [Set up mobile broadband with GPS](#)
- [Set up Bluetooth](#)

Enable wireless from the Motion Dashboard

To set up wireless, you must first enable the wireless network adapters from the Motion Dashboard. The Dashboard is a Motion Computing application for configuring your C5t/F5t Tablet PC.

To enable wireless adapters:

1. Open the Motion Dashboard. From the Windows® taskbar, tap the Motion Dashboard icon .
2. Tap **Wireless**.
3. Tap the checkboxes next to all wireless networks you want to use:
 - **Enable Bluetooth Internal Wireless**
 - **Enable 802.11 Internal Wireless**
 - **Enable Mobile Broadband with GPS** (If this option is not listed, your C5t/F5t doesn't have mobile broadband installed.)

NOTE: To extend battery life, enable only the wireless devices that you will be using.

Set up Wi-Fi

Connect to the Internet and other computers wirelessly over Wi-Fi.

To set up Wi-Fi:

1. [Enable Wi-Fi](#) from the Motion Dashboard.
2. From the Windows® notification area, tap the wireless network icon .
3. Tap the desired wireless network from the list of available networks.

Set up mobile broadband with GPS

If you purchased your C5t/F5t with the optional mobile broadband module, you can connect to high-speed cellular networks worldwide. With the mobile broadband module and a data plan from one of several cellular network providers, you have full Internet access.

The mobile broadband module includes a GPS receiver that provides the current location of your C5t/F5t. With the GPS receiver, you can use most GPS navigation and mapping applications. You use the Motion Connection Manager to manage your mobile broadband network connections and monitor the GPS.

To set up mobile broadband:



1. Enable mobile broadband from the Motion Dashboard.
2. Start the Motion Connection Manager. From the Start menu, select **All Programs > Motion Computing > Motion CM**.
3. Tap the help icon  and select the help topic, *Setting up mobile broadband*.
4. Follow the instructions to set up a network profile and connect to the mobile broadband network.

NOTE: Before you can connect to a mobile broadband network, you must have an active account with a cellular network provider. Some providers require a SIM card for mobile broadband access; if you're not sure whether you need one, contact your mobile broadband provider.

Set up Bluetooth

The C5t/F5t has a built-in Bluetooth adapter that provides short-range wireless connectivity with other Bluetooth-enabled devices.

To set up Bluetooth:

1. Enable Bluetooth from the Motion Dashboard.
2. Add a Bluetooth device:
 - a. From the Windows® notification area, tap the Bluetooth icon  and select **Add a Device**.
 - b. Make sure the device is discoverable according to the Bluetooth device manufacturer's instructions. When a Bluetooth device is discoverable, it is visible to other Bluetooth devices within range.
 - c. Select the desired Bluetooth device from the list of available devices.
 - d. Follow the on-screen instructions to complete the procedure.
3. Make the C5t/F5t discoverable (visible) to other Bluetooth devices:
 - a. From the Windows® notification area, tap the Bluetooth icon  and select **Open settings**.
 - b. On the **Options** tab, select **Allow Bluetooth devices to find this computer**.

Step 3: Get familiar with your C5t/F5t Tablet PC

Once you've set up your C5t/F5t, take a few minutes to get familiar with your Tablet PC.

- Calibrate touch. You can adjust the touch settings by calibrating the digitizer. (The digitizer is software that detects the position of the pen or your finger on the touchscreen display.) For details, see [Calibrate touch](#) on page 21.
- Use Motion Computing tools to customize your tablet according to your work style. See [Using the Motion Dashboard](#) on page 18.
- Open the writing pad and provide handwriting samples to improve handwriting recognition. See [Entering text and handwriting recognition](#) on page 24.
- Take photos or use the web camera. See [Using the cameras](#) on page 35.
- Set up speech recognition. See [Using speech recognition](#) on page 33.

Step 4: When you take a break

When you leave your Tablet PC for a while, you can lock it to prevent unauthorized access by pressing the Security button and then selecting **Lock this computer** on the following screen. You can also put it in Sleep or Hibernate mode to save power by pressing the Power button.



Security and power buttons

Lock and unlock the Tablet PC

To lock the Tablet PC, either:

- Press the security button  on the right side of the tablet.
- If a keyboard is attached, press **Ctrl+Alt+Delete**.

To unlock the tablet:

- Press the security button  or **Ctrl+Alt+Delete** again.

Sleep mode

Place your tablet in Sleep mode when you go away for a short period of time. Sleep mode conserves battery power while you're away and when you return, your desktop is the same as you left it. Sleep mode is sometimes called "standby."

To put the tablet in Sleep mode:

- Save your files.
- Press and release the power button .
Note: While in Sleep mode, the power button flashes green.

To wake up the tablet from Sleep mode:

- Press and release the power button .

The tablet quickly resumes activity and your desktop is the same as you left it.

Hibernate mode

If you intend to leave your tablet for several hours or more, you can put the tablet in Hibernate mode. Like sleep, when you return from hibernate, your desktop is the same as you left it.

It takes longer to start up from Hibernate mode than sleep, but it consumes very little power, saves data to disk beforehand, and is still faster than starting your tablet after shutting it down.

To put the tablet in Hibernate mode:

- From the Start menu, tap the arrow next to **Shut down** and select **Hibernate**.

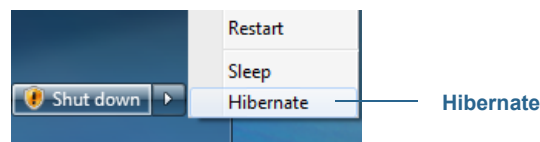

Hibernate from the Start menu

For more information on power options, see [Changing how the power button functions](#) on page 45.

Optional setup tasks

Create a recovery image

Once you've set up your C5t/F5t the way you like it, including installing your applications, create a system image on an external USB drive. This is a safety measure in the event that your system stops working.

A system image is an exact copy of a drive and includes Windows® 7, your system settings, programs, and files. For more information, see [Creating a system image](#) on page 58.

Attach the pen tether

The C5t/F5t pen comes with a tether so that you can attach the pen to your tablet to avoid misplacing it.

To attach the pen tether:

1. Slip one end of the tether through the hole at the end of the pen, then pull the pen through the loop until it is tight.
2. Slip the other end of the tether through the attach point on the C5t/F5t, then pull the pen through the loop until it is tight.

You can purchase additional pens from the [Motion Computing Accessories](#) page.

Connect the tablet to a docking station

The docking station for the C5t/F5t is a separate accessory that you can purchase from the [Motion Computing Accessories](#) page.

The docking station for the C5t/F5t adds functionality to your tablet, including port expansion for Ethernet, VGA monitors, and USB devices such as printers, keyboards, and mice. The docking station also charges the tablet and includes a charging bay for an extra battery. For details on installing and using the docking station, see the *CFT-Series Docking Station User's Guide* that accompanies the docking station.

Connect the tablet to a display monitor

Connect a display monitor to your C5t/F5t Tablet PC using the VGA port located on the docking station.

After connecting the monitor, set up the external display from the Motion Dashboard as described in [Setting up an external display](#) on page 30.

For more information

This *User's Guide* introduces the full set of C5t/F5t features and provides instructions for common tasks you'll perform. The rest of this book is organized as follows:

- **Using your C5t/F5t**—Provides instructions for basic C5t/F5t tasks including how to customize your tablet to fit the way you work using Motion Dashboard, how to use the cameras, how to set up speech recognition, and more.
- **Caring for your C5t/F5t**—Provides suggestions for the care and maintenance of your Tablet PC.
- **Troubleshooting and FAQs**—Provides answers for common issues you may encounter as you begin to use your C5t/F5t.

The *Getting Started* document located on the desktop provides a number of tips to get you started using the tablet quickly.

You will find other useful information on our website:

- [Tablet PC Tips & Tricks](#)
- [Motion Computing Support](#)
- [Free online training videos](#)
- [Knowledge Base](#)
- [Motion Computing Accessories](#)
- [Motion Computing Store](#)

NOTE: This guide is available in [French](#), [German](#), [Spanish](#) and [Portuguese](#) from the website.

Using your C5t/F5t

2

This chapter provides information about performing the following tasks:

- [Using the Motion Dashboard](#) on page 18
- [Using touch](#) on page 20
- [Entering text and handwriting recognition](#) on page 24
- [Using the front panel buttons](#) on page 28
- [Setting display options](#) on page 29
- [Using the built-in microphones](#) on page 33
- [Using speech recognition](#) on page 33
- [Using the barcode scanner](#) on page 36
- [Using the RFID reader](#) on page 38
- [Using the battery](#) on page 39
- [Using Wi-Fi \(802.11a/g/n\)](#) on page 45
- [Using Mobile Broadband with GPS](#) on page 46
- [Using the Connection Manager](#) on page 47
- [Using the discrete GPS receiver with WAAS, EGNOS, and MSAS](#) on page 47
- [Using Bluetooth](#) on page 48
- [Using the fingerprint reader](#) on page 49
- [Using the smart card reader](#) on page 53
- [Using Windows® Action Center](#) on page 56
- [Setting up user accounts](#) on page 56
- [Locating your serial number](#) on page 57
- [Backing up your system](#) on page 57
- [Restoring your system](#) on page 57
- [Finding other software](#) on page 60

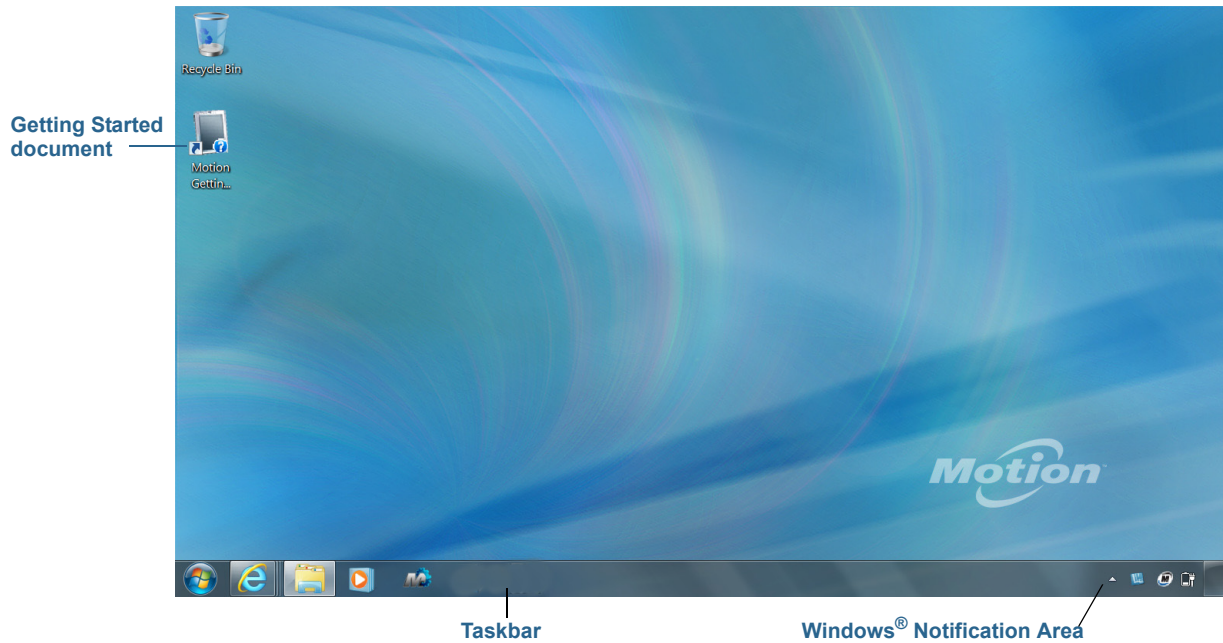

Introducing the C5t/F5t desktop and applications

When you start up the C5t/F5t for the first time, the desktop looks like the following picture. Motion Computing applications appear in the taskbar and Windows® notification area.



Motion Computing desktop

The Motion Computing applications are described below.

	Motion Getting Started	Document that contains tips for starting out with the C5t/F5t Tablet PC.
	Motion Dashboard	Motion application for changing tablet settings. See Using the Motion Dashboard on page 18.

Changing the taskbar

You may find it convenient to place the Windows® taskbar on the left edge of the display, especially if your Tablet PC has a touchscreen display.

To place the taskbar on the left edge of the screen:

1. Press and hold the Start menu icon and tap **Properties**.
2. Tap the **Taskbar** tab.
3. Make sure that **Lock the taskbar** is checked.
4. Under **Taskbar location on screen**, select **Left**.

5. Tap **OK**.

TIP: As an option, you can hide the taskbar altogether; it reappears when you tap the area. From the **Taskbar** tab, tap the **Auto-hide the taskbar** checkbox.

Using the Motion Dashboard

The Motion Dashboard provides a convenient way to change common tablet-related settings.

To open Motion Dashboard:

- From the Windows® taskbar, tap the Motion Dashboard icon .

Motion Dashboard is organized into categories, which are listed on the left of the Dashboard. Tap a category to display its settings. In the following illustration, Motion Dashboard is open to Display settings.

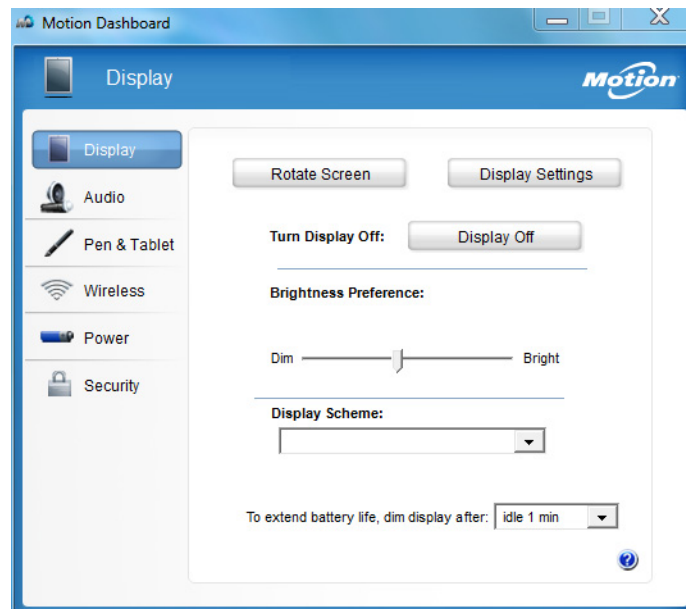

Motion Dashboard

The following table lists some of the tasks you can perform using the Motion Dashboard.

NOTE: This is a partial list of tasks that you can perform with Motion Dashboard. Some of these tasks are described in this chapter; all tasks are described in Motion Dashboard by tapping the help icon .

Dashboard Category	Task
Display	<ul style="list-style-type: none"> • Rotate the display orientation • Adjust the brightness of the display • Set advanced graphic properties • Set up an external display • Dim the display automatically
Audio	<ul style="list-style-type: none"> • Adjust speaker and microphone volume • Adjust advanced audio settings • Suppress background noise • Balance speakers
Pen & Tablet	<ul style="list-style-type: none"> • Configure touch to use touch only, pen only or both simultaneously • Adjust touch to left-handed setting • Adjust sensitivity to flicks and gestures • Use the pen function button for erasing digital ink instead of performing the right-click action • Personalize your handwriting so that it can be recognized more accurately
Wireless	<ul style="list-style-type: none"> • Enable and disable Wi-Fi, Bluetooth and mobile broadband • Choose to have wireless disabled on Start Up (it is enabled by default) • Adjust Wi-Fi, Bluetooth and mobile broadband properties
Power	<ul style="list-style-type: none"> • Select a power plan • Change what the power button does when pressed: sleep, hibernate or shut down
Security	<ul style="list-style-type: none"> • Set up the fingerprint reader and other security options

Accessing Motion tools from the Windows® notification area

For convenience, you can access common Motion tools from the Windows® notification area.

NOTE: Initially, the Motion icons don't appear in the Windows® notification area. Tap the arrow to view more icons. Tap **Customize** to have the icons appear in the Windows® notification area.

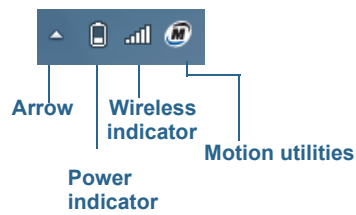

Motion icons in the Windows® notification area

Tap the Motion icon  to display:

- **Battery Health**—Shows the current battery charge level.
- **Motion Dashboard**—Opens the Motion Dashboard.
- **Options**—Lists options you can set:
 - **Show Hard Drive Activity**—When selected, the Motion icon blinks when there is hard drive activity.
 - **Automatic Display Rotation**—When selected, the C5t/F5t automatically changes the viewing orientation (landscape to portrait or vice versa) when the tablet is physically rotated.

Using touch

With the C5t/F5t Tablet PC, you can use either your finger, a pen, or both to interact with the touchscreen display. While it's convenient to use your finger most of the time, a pen gives you more precise control for editing a document or drawing graphics.

With touchscreen displays, you use your finger or pen as you would use a mouse. For example, tapping twice is the same as double-clicking a mouse. Tapping and holding is the same as right-clicking a mouse to open context-sensitive menus.

Here are some common ways to perform tasks on a touchscreen:

- **Tap**—Select something
- **Press and hold**—Open a menu of options. This is equivalent to right-clicking a mouse to display the right-click menu.

Note: Press and hold your finger until a circle appears, then lift your finger to display the menu.
- **Double-tap**—Perform a double-click action
- **Tap and drag**—Drag and drop
- **Pinch fingers together**—Zoom out
- **Spread fingers apart**—Zoom in
- **Flick**—Scroll through a list or move quickly
- **Press and hold the pen's function button** (equivalent to a right-click on a mouse)—Open a context-sensitive menu

NOTE: If the tablet doesn't respond when you tap with your finger, try using more area of your fingertip. Unlike other types of touchscreens, the C5t/F5t capacitive touchscreen doesn't respond to other input. For example, you can't tap it with another object such as a credit card or if you're wearing gloves.

Calibrate touch

The digitizer is software that detects the position of the pen or your finger on the touchscreen display. You should calibrate the digitizer the first time you start the Tablet PC. Then, recalibrate the digitizer whenever the pointer doesn't align with the pen tip or finger.

To calibrate the digitizer:

1. Open [Motion Dashboard](#).
2. Tap **Pen & Tablet**.
3. Under **Pen & Tablet**, tap **Calibrate Digitizer**.
4. Tap your finger on the display to calibrate for touch.
5. Follow the instructions in the calibration program.
6. Repeat the above steps, tapping the pen on the display to calibrate the pen.

How to use gestures with the multiple-touch display

The C5t/F5t Tablet PC touchscreen display supports multi-touch, which allows you to directly manipulate items on-screen, such as to navigate websites and view photos. For example, you can use your fingers to scroll through lists, zoom in and out, rotate, and so on.

Changing to one-tap open for touch

With touch, you may want to change how you select and open items. By default, Windows® folders are set up so that you tap once to select an item and double-tap to open it. For touchscreen displays, you can change the behavior to point to select an item and open an item with one tap instead of two.

To change folder options:

1. From the Windows® Control Panel, tap **Appearance and Personalization, Folder Options**, then tap **Specify single- or double-click to open**.
2. Under **Click items as follows**, tap **Single-click to open an item (point to select)**.

For more information, open Windows® Help and search for "folder options."

Configuring touch input mode

You can determine how touch input is configured by setting the input mode. You can use:

- Your finger only; no pen input is detected.
- The pen only; no finger input is detected.
- Both your finger and a pen.
- Switch between touch and pen input, in which case you double-tap to switch to touch input. This is useful to avoid the tablet from responding to unintentional touch input.

To configure touch settings:

1. Open [Motion Dashboard](#).
2. Tap **Pen & Tablet**.
3. Tap **Touch Settings**.
4. From the **Digitizer Options** tab, under **Input Mode** tap the desired mode.

Adjusting touch settings

You can adjust how your finger movements are interpreted in many ways. For example, you can:

- Adjust how quickly the tablet responds when you double-tap your finger
- Adjust how quickly the tablet responds when you press and hold your finger
- Show the touch pointer when interacting with items on the screen
- Change the touch pointer location, which can be helpful if you're left-handed
- Enable or disable multi-touch gestures and inkings
- Change the location of menus to appear to the right of your hand, which is helpful if you're left-handed

To change touch settings:

1. Open [Motion Dashboard](#).
2. Tap **Pen & Tablet**.
3. Tap **Pen & Input Devices**.
4. Tap the **Touch** tab.
5. To enable Touch, tap **Use your finger as an input device**.
6. To enable multi-touch gestures, tap **Enable multi-touch gestures and inking**.
7. To adjust the Double-tap action, under **Touch action**, tap **Double-tap**, then tap **Settings**. Move the slider to make your adjustments.
8. To adjust the Press and hold action, under **Touch action**, tap **Press and hold**, then tap **Settings**. Move the slider to make your adjustments.
9. To display the touch pointer on the screen, tap **Show the touch pointer**.

10. To change what the touch pointer looks like or where it's positioned, tap **Advanced Options**.

To change the location of menus for left-handed users:

1. Open [Motion Dashboard](#).
2. Tap **Pen & Tablet**.
3. Tap **Tablet PC Settings**.
4. Tap the **Other** tab and tap **Left-Handed**.

Adjusting pen settings

If the pen doesn't respond as accurately as you would like, you can make adjustments. For example, you can:

- Use the button on the pen to perform the right-click action or act as an eraser
- Adjust how quickly the tablet responds when you double-tap the pen
- Adjust how quickly the tablet responds when you press and hold the pen button

To change pen settings:

1. Open [Motion Dashboard](#).
2. Tap **Pen & Tablet**.
3. Tap **Pen & Input Devices**.
4. Tap the **Pen Options** tab.
5. To adjust the speed and spacial tolerance of the Double-tap action, under **Pen action**, tap **Double-tap** then tap **Settings**. Move the slider to make your adjustments.
6. To adjust the speed and duration of the Press and hold action, under **Pen action**, tap **Press and hold** then tap **Settings**. Move the slider to make your adjustments.
7. To enable the function button on the pen, tap **Use the pen button as a right-click equivalent**.
8. To enable the eraser, select the **Use the top of the pen to erase ink** option.

Adjusting Tablet PC settings

From **Tablet PC Settings**, you can change from right-handed to left-handed use.

To change hand orientation:

1. Open [Motion Dashboard](#).
2. Tap **Pen & Tablet**.
3. Tap **Tablet PC Settings**.
4. Tap the **Other** tab and make your desired change.

The **Configure your pen and touch displays** option on the **Tablet PC Settings Display** tab is useful for assigning touch to the appropriate display when one or more displays are connected to the tablet. By default, Windows® 7 assumes that an external display is for touch input. To change this, run **Setup** from **Tablet PC Settings** to assign touch to your tablet display.

NOTE: A keyboard must be connected to the tablet to perform this procedure.

To assign touch to the desired display:

1. Open **Motion Dashboard**.
2. Tap **Pen & Tablet**.
3. Tap **Tablet PC Settings**.
4. Tap the **Display** tab.
5. Tap **Setup** next to "Configure your pen and touch displays."
6. Tap **Touch Input**.
7. Press the **Enter** key until you see the instructions appear on the display that you want to use for touch input.
8. Follow the on-screen instructions.
9. Press **Esc** to end the process.

Entering text and handwriting recognition

You can enter text by either tapping characters on the on-screen keyboard or writing on a virtual writing pad. When you write on the writing pad, your handwriting converts to digital ink. "Digital inking" refers to the process of converting your handwriting to text. In the following picture of the writing pad, someone started writing Motion Computing and "Motion" has already been converted into digital ink.

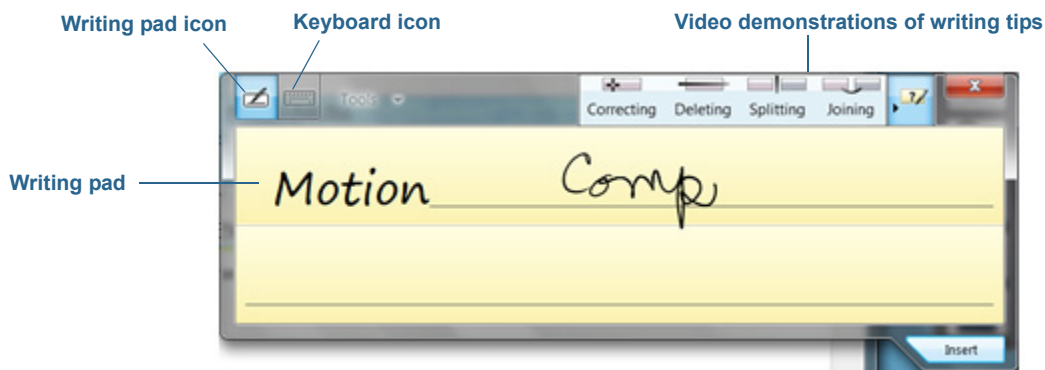

Input panel open to the writing pad

TIP: Tap the icons at the top of the input panel to view videos on making editing gestures. To hide the video tips, tap the icon on the right.

By tapping the keyboard icon at the top of the pad, the input panel opens to the on-screen keyboard.

Here's the input panel open to the on-screen keyboard. Tap the **Tools** menu for more input panel options and for viewing **Help Topics**.





Input panel open to the on-screen keyboard

TIP: Resize the keyboard panel by dragging the handle at the bottom right of the keyboard. Also, you can use the **Ctrl**, **Alt**, **Fn**, **Del**, and **Bksp** keys as you do on a normal keyboard.

Opening and closing the input panel

The Tablet PC input panel often opens automatically when you tap in a text field. You can also tap the tab located on the left side of the screen to expand the input panel.

To open the input panel, either:

- Tap at the place you want to enter text, such as in a text box. Then tap the input panel icon .
- Tap the input panel tab on the left edge of the screen .

To close the input panel:

- Tap the close button  at the top-right. The input panel slides back to the edge of the screen.

Docking or floating the input panel

By default, the input panel is floating and you can move it anywhere on the screen by placing your finger or pen on the title bar and dragging it.

If you prefer, you can dock the input panel so that, when it is open, it always appears at the same location, either at the top or bottom of the screen.

To dock or undock the input panel:

- At the top of the input panel, tap **Tools**.
- Select **Docking**.
- Select either **Dock at the top of the screen**, **Dock at the bottom of the screen** or **Float**.

TIP: If you're left-handed, you can move the input panel to the right edge of the screen to make it easier to use.

Entering numbers with numbers pad

If you find yourself typing a lot of numbers, use the numbers pad.

To open the numbers pad:

- Tap the Num key at the bottom of the writing pad.

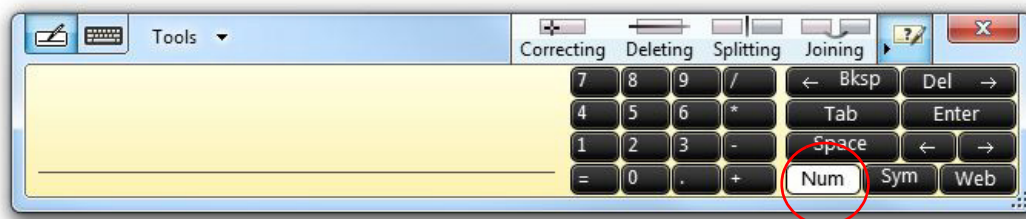

Numbers pad

Entering special keys with the extended keyboard

You can enter special keys using the on-screen expanded keyboard. Special keys include **Home**, **End**, **Insert**, **PgUp**, **PgDn**, **PrtScn**, **Pause**, and **ScrLk**.

To open the expanded keyboard:

- Tap the **Tools** key at the top of the input panel and choose **Show Expanded Keyboard**.



Expanded keyboard

Using the handwriting recognition program

The more you write, the quicker your handwriting is recognized because the tablet has an automatic learning tool that collects data about the words you use and how you write them. This data is stored in your user profile.

As a option, you can use the handwriting recognition application to train the tablet to recognize your handwriting style. You supply handwriting samples when prompted.

To start the handwriting recognition program:

1. Open [Motion Dashboard](#).
2. Tap **Pen & Tablet**.
3. Tap **Pen & Input Devices**.
4. Tap **Handwriting** and follow the on-screen instructions.

TIP: If you acquire your C5t/F5t from another user, you can reset automatic learning.

To reset handwriting automatic learning:

1. Open [Motion Dashboard](#).
2. Tap **Pen & Tablet**.
3. Tap **Pen & Input Devices**.
4. Tap **Handwriting**.
5. Tap **Don't use automatic learning**. The current handwriting profile is deleted.
6. Tap **Use automatic learning** to begin collecting handwriting data again.

NOTE: You can find other handwriting applications at the [Motion Computing Store](#).

Using the front panel buttons

You can use the buttons on the front of the Tablet PC to perform many functions without having to use the pen. The buttons are customizable, so you can modify their functions to suit the way you work.

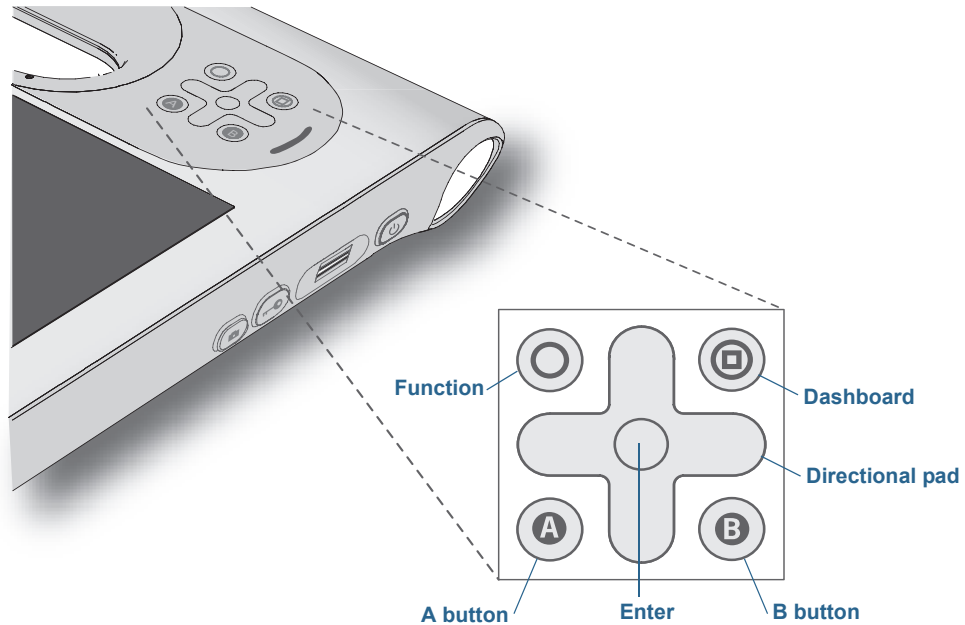

Button	Primary	Secondary (Function+button)
Function	Activates secondary function for other buttons	N/A
Dashboard	Starts Motion Dashboard	Opens Windows® Journal™
Directional pad	Moves the pointer or navigates through documents. Equivalent to arrow keys on a keyboard.	Left = Shift+Tab Right = Tab Up = Page Up Down = Page Down
Enter	Makes a selection—equivalent to the Enter key	Windows® logo key
A	Performs application-specific function	Rotates the display orientation
B	Activates the barcode scanner (if installed)	Cancels the current task—equivalent to the Esc key

The directional pad orientation rotates to match the display orientation. To move the pointer in a certain direction, press that direction on the pad regardless of orientation. For example, “up” in landscape orientation becomes “left” in portrait orientation.

Configuring front panel buttons

As you become more familiar with your tablet, you can customize the buttons on the front panel. You can configure the buttons to start your favorite program, run a command, or enter a key combination.

To configure the front panel buttons:

1. Open [Motion Dashboard](#).
2. Tap **Pen & Tablet**.
3. Tap the **Tablet PC Settings** button.
4. In the Tablet PC Settings window, tap the **Buttons** tab.
5. Select the button combination you want to change. The currently selected buttons appear in red.
6. Tap **Change**.
7. Select the appropriate action for the button.

For some actions, you must enter more information, such as the location of a program to start. You can select an action for **Press** and another for **Press and hold**. For more information, tap **What is press and hold?**

NOTE: To reset the buttons to their default values, tap the **Reset** button.

Setting display options

Use the procedures in this section to customize your display settings. You can adjust the brightness level, rotate the display, and change the order in which the display rotates.

Adjusting the display brightness

Changing the brightness of the display is useful when you want to conserve battery power.

To adjust the display brightness:

1. Open [Motion Dashboard](#).
2. Tap **Display**.
3. Move the Brightness slider to the desired level.

TIP: For optimal battery conservation and viewability, set the brightness scale to the mid-point or slightly above.

4. Select one of the following:
 - **Fixed**—Sets the display brightness to a constant level. Move the slider to adjust the display to the desired brightness level. When set to Fixed, the ambient light sensor is ignored.
 - **Dynamic**—Uses the ambient light sensor to maintain an appropriate brightness level for the current lighting condition. The Dynamic setting helps to conserve battery power.

Rotating the display orientation

You can easily change the screen orientation to fit your current task. For example, you may want to use the portrait orientation for filling out forms or reading a PDF or e-book. At other times, you may want a landscape orientation for web browsing or sketching.

To rotate the display:

1. Open [Motion Dashboard](#).
2. Tap **Display**.
3. Tap the **Rotate Screen** button.

Enabling or disabling automatic rotation

You can set the display to automatically rotate when you physically rotate the tablet. By default, automatic rotation is disabled.

To enable or disable rotating the display automatically:

1. From the Windows® notification area, tap **Options**.
2. Select or clear the **Automatic Display Rotation** check mark.

Setting up an external display

You can use your tablet with an external monitor or projector.

Display settings

When connecting to an external display, specify whether to:

- Duplicate (mirror) the displays
- Extend the tablet's display to span across the external monitor
- Use the external monitor only or use the tablet only

Mirror display

The “mirror display” theme duplicates the tablet display on both the display and monitor. This is useful when using your Tablet PC with a projector.

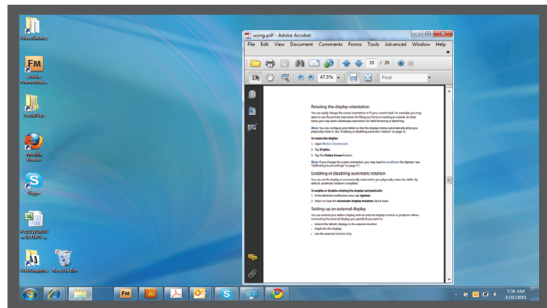

Tablet PC

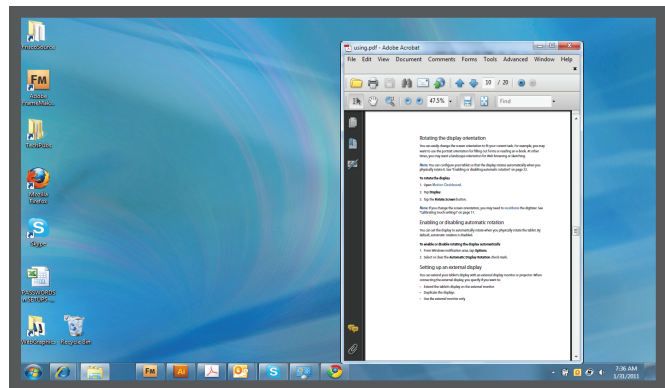

External monitor

Mirror display

Extended with monitor primary

The “extended with monitor primary” display scheme expands the desktop area across the tablet and external monitor, where the external monitor is the primary monitor. You can set the external monitor to use a different display resolution than the Tablet PC.

The C5t/F5t 10.4" XGA display has a resolution of 1024 X 768.

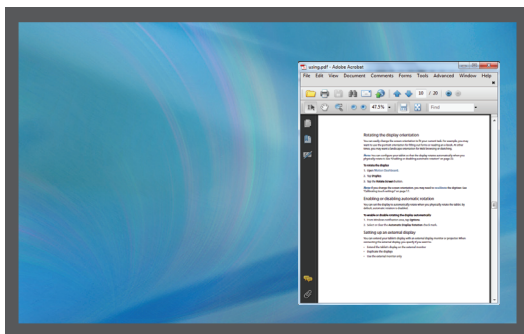

Tablet PC

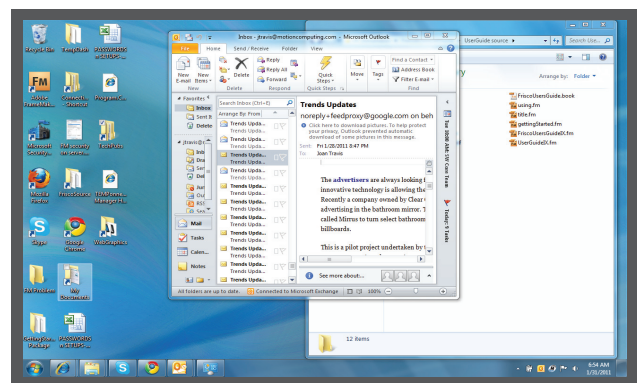

External monitor

Extended with monitor primary

Extended with tablet primary

The “extended with tablet primary” display scheme expands the desktop area across the tablet and external monitor, with the tablet as the primary display. You can set the external monitor to use a different display resolution than the tablet.

Monitor only

The “monitor only” display scheme uses the external monitor only.

Tablet only

The “tablet only” display scheme uses the tablet display only.

Connect an external monitor

To connect an external monitor to the C5t/F5t, you use the CFT-Series docking station, which is sold separately.

To set up an external monitor:

1. Connect the monitor cable from the external monitor into the CFT-Series docking station according to the *CFT-Series Docking Station User's Guide*.
2. Plug in the external monitor and turn it on.
3. If necessary, install software and drivers for the monitor. See the manufacturer's documentation for more information.
4. Open [Motion Dashboard](#).
5. Tap **Display**.
6. Select a **Display Scheme**.
7. If your Tablet PC doesn't respond to touch, follow the steps below to [enable touch on the correct display](#).

Resetting touch after adding other monitors

After setting up an external monitor, touch might be disabled on your tablet because Windows® 7 assumes that the external display is for touch input. You can enable touch on the correct display from the Motion Dashboard by following the procedure below. You'll need a keyboard.

To enable touch when your tablet is connected to an external display:

1. If it isn't already, attach a keyboard to the tablet.
2. Open [Motion Dashboard](#).
3. Tap **Pen & Tablet**.
4. Tap **Tablet PC Settings**.
5. Select the **Display** tab.
6. Tap **Setup** next to “Configure your pen and touch displays.”
7. Tap **Touch Input**.
8. Press the **Enter** key until you see the instructions appear on the display that you want to use for touch input.
9. Follow the on-screen instructions.
10. Press **Esc** to end the process.

Resetting the display after returning the tablet to the docking station

If you set up your tablet in a docking station with the display scheme expanded across both, and you remove the tablet temporarily from the docking station, the display scheme may need to be reset when you return the tablet to the docking station.

TIP: If the display still doesn't work properly, change the **Display Scheme** to **Tablet Only** and then change it back to the desired scheme.

Using the built-in microphones

You can use the built-in array microphones to record audio, dictate notes, and use voice commands. The two microphones are used at the same time to optimize sound detection for speech recognition and voice recording.

You can use the Speak Anywhere acoustics software to fine tune the built-in microphones to suit your environment. The software enables you to use the microphones in a variety of settings, including small or large groups, noisy environments, or for individual dictation or voice commands. The software improves the microphone reception by:

- Removing all sounds outside of the user-defined angle of acceptance.
- Minimizing background and ambient noise.
- Removing the echo caused by the microphone picking up the speaker output.

Using speech recognition

You can use speech recognition to interact with your tablet by voice. You can dictate documents and emails or use voice commands to control programs.

- **Dictation mode**—With Dictation mode, your tablet listens to everything you say and converts your words to text. You can use dictation mode to enter text directly into any document or text box.
- **Voice command mode**—With Voice command mode, your tablet listens for specific words that correspond to a list of available voice commands. You can use commands to switch between programs, save documents, copy, paste or undo.

Setting up speech recognition

Before you can use speech recognition, you must configure the microphones and train the system for the characteristics of your voice. You can then take the available speech tutorial to learn basic voice commands.

Set up the microphones

For best results, move to a quiet environment.

To set up the microphones:

1. In Control Panel, tap the **Ease of Access** category, then tap **Speech Recognition**.
2. Tap **Set up microphone**.
3. If you're using the tablet's microphone array, select **Other**.
4. Follow the instructions in the setup program.
5. If the microphones are set to an appropriate level, the meter will stay in the green zone while you read the sentences. If the level is too low or too high, use Motion Dashboard to adjust the level (page 18).

Train your tablet to recognize your speech

Use this procedure to improve your tablet's ability to understand your voice.

To train your tablet to recognize your speech:

1. In Control Panel, tap **Speech Recognition**.
2. Tap **Train your computer to better understand you**.
3. Follow the instructions in the setup program.

Taking the speech tutorial

You can use the speech tutorial to learn basic commands and dictation. The tutorial takes about 30 minutes to complete.

To take the speech tutorial:

1. In Control Panel, tap **Speech Recognition**.
2. Tap **Take Speech Tutorial**.
3. Follow the instructions in the tutorial program.

Using dictation and voice commands

After you've set up speech recognition, you can open it from Control Panel.

To use Dictation and Voice Commands:

1. In Control Panel, tap **Speech Recognition**.
2. Tap **Start Speech Recognition**.
3. Ensure that the Speech Recognition window is open and listening.

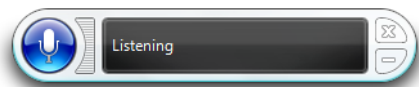

4. Do one of the following:

- For voice commands, say the appropriate command. For a list of commands, search Windows® Help and Support for “speech commands.”
- For dictation, open the program you want to use and start speaking.

For more information about speech recognition, search Windows® Help and Support for “speech recognition.”

Using the cameras

Your tablet may include built-in web and documentation cameras.

Using the web camera

The web camera is a 1.3MP camera that supports color images and streaming video. It is located on the front of your tablet. You can use the web camera for interacting with people online.

Use the software of your choice to operate the web camera.

Using the documentation camera

You can use the built-in documentation camera to take pictures and save them to your hard drive. The documentation camera is a 3MP, auto-focus camera. The camera lens is on the back of the tablet and includes a light to illuminate the subject.

The camera can capture pictures in BMP, JPG, PNG, GIF, and TIFF formats, and it has a maximum resolution of 2048 × 1536 pixels. By default, the camera captures pictures in BMP format with a resolution of 1600 × 1200 pixels.

To use the documentation camera:

1. Press the Camera button to activate the camera and open the viewfinder.

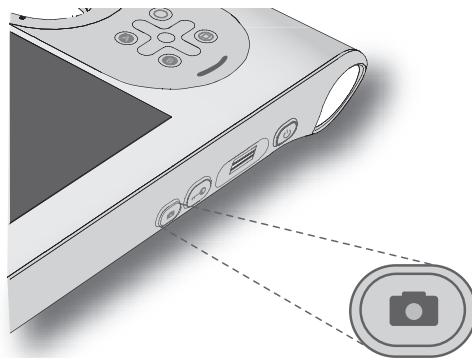

2. Press the Camera button again to take a picture. If you don't take a picture after a few seconds, the viewfinder closes automatically.

3. In the Pictures window, do one of the following:
 - To delete the picture, tap **Delete**. In the confirmation dialog box, tap **Yes**.
 - To copy the picture, tap **Copy to Clipboard**. You can then paste the picture into an image editing program.
 - To close the Pictures window, tap **Close**.
 - To save the picture, tap **Save**. In the Save As dialog box, specify a location and a file format, such as BMP, JPG, or GIF.

Documentation camera tips

- Hold the camera steady and allow it to focus.
- If your pen is tethered, ensure that the tether is not in front of the camera lens.
- Ensure you have adequate lighting.
- You can use the Pictures window to take and review multiple pictures. Use the slider bar at the bottom of the Pictures window to switch among active pictures.

Using the barcode scanner

Your C5t/F5t is available with an optional integrated 1D and 2D barcode scanner that you can use to retrieve information from barcodes. Many applications use barcodes for asset tracking, identification, and process controls.

Supported barcode types

The C5t/F5t barcode scanner supports several different types of barcodes—a minimum set of barcodes is enabled at the factory.

The following symbologies are enabled by default:

- Aztec Code
- EAN-128
- Code 39
- UPC-A
- EAN-8
- Interleaved 2 of 5
- Micro PDF417
- RSS Limited
- Code 128
- EAN-UCC-CC-AB
- DataMatrix
- UPC-E
- EAN-13
- PDF417
- RSS-14

Other barcode types can be enabled by using the MCA Configuration Editor that comes with the Tablet PC. To access the editor, from the Start Menu, select **All Programs > Intel > MCA Platform Driver** and tap **MCA Configuration Editor**.

To use the barcode scanner:

1. Open the application that you want to receive the barcode data and place the insertion point in the appropriate field.
2. Hold the unit by the handle with the scanner lens in front of you.
3. Aim the scanner lens at the barcode.

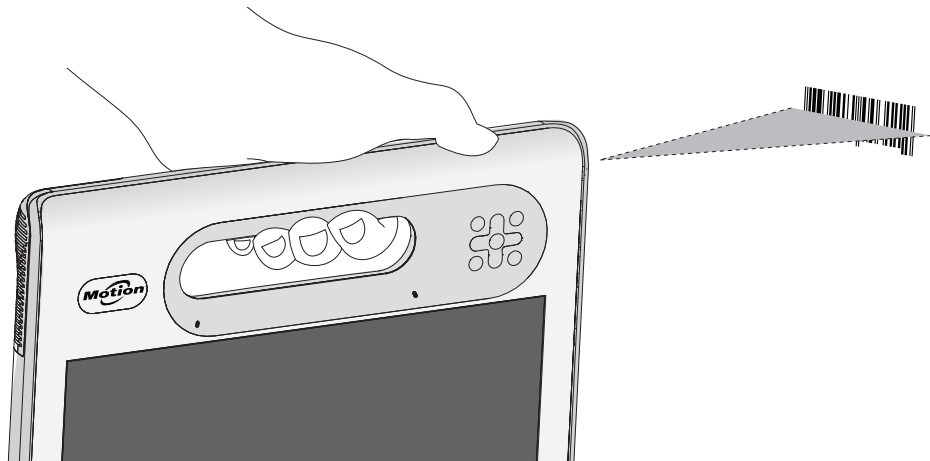

4. Press and release the barcode scanner button on the top of the unit. Ensure that the scan beam covers the entire barcode.

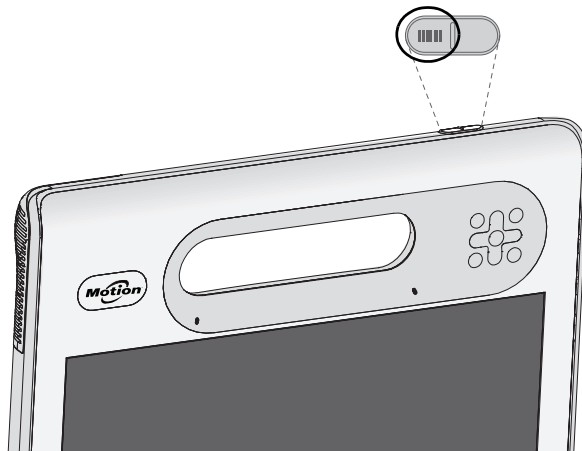

If the scan was successful, the data will appear in the application and you will hear a chime sound as confirmation.

Barcode scanner tips

- You will typically get the best scans if the lens is six to seven inches from the barcode.
- If you're having trouble scanning a barcode, use two hands to steady the tablet while you scan.

Using the RFID reader

Your Tablet PC may include an integrated 13.56 MHz RFID reader that you can use to retrieve information from RFID tags.

RFID tags use radio frequency (RF) transmissions to identify a product, animal, or person. RFID doesn't require direct contact or line-of-sight scanning, and can be scanned through many materials, including clothing. An RFID tag can store much more data than a typical barcode, and some RFID tags can both transmit and record data. RFID can be used for asset tracking, identification, process control, healthcare, and pharmaceutical applications.

The RFID reader supports the following formats:

- ISO/IEC 14443A/B
- ISO/IEC 15693
- ISO/IEC 18000-3
- MIFARE Classic

To use the RFID reader:

1. Hold the unit by the handle with the right edge in front of you.
2. Aim the right edge of the unit at the RFID tag. Ensure that the tag is 1–1.5 inches (25–40 mm) from the RFID antenna scan area.

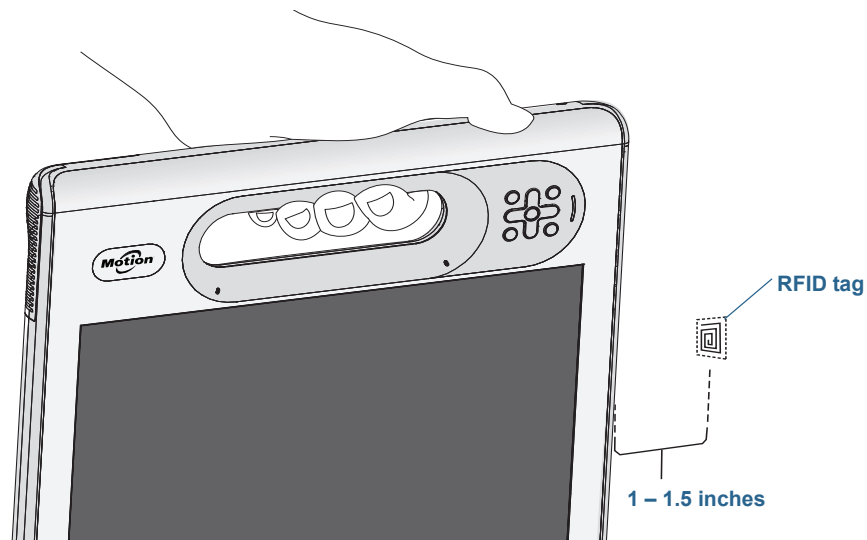

3. Press and release the RFID button on the top of the unit. The RFID light will come on to indicate that the unit is scanning.

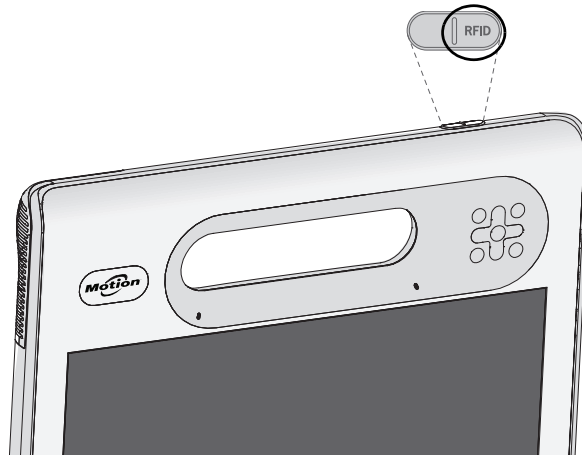

The RFID light goes off and the unit beeps to indicate a successful scan. The ASCII and Hex data appears in the RFID Tag Data window.

NOTE: RFID tags are typically used with specialized applications. See your system administrator for more information.

Using the battery

The C5t/F5t includes a high-capacity Lithium-ion battery that fits into the back of the unit. Under normal conditions, you can run the tablet on battery power for up to six hours.



DANGER: To avoid personal injury, handle the battery with care. Don't open, puncture, short, or expose it to fire or water. Keep the battery in an environment with ambient temperature of less than 104°F (40°C). For example, don't leave the battery in a closed car in hot weather for an extended time. For more information, see the *Safety and Regulatory Guide* packaged with the tablet.

Checking tablet battery power

You can check the remaining battery power several ways:

- When the tablet is plugged in to an outlet, the battery gauge shows whether the battery is fully charged (green) or charging (amber).
- When the tablet is running on battery, pressing the battery gauge button on the front displays status lights indicating the current level of charge.
- From the Motion Dashboard.
- From the Windows® notification area.

The battery gauge is located on the front of the C5t/F5t Tablet PC as shown:

You can use the battery gauge on the front of the unit to monitor the status of the battery.

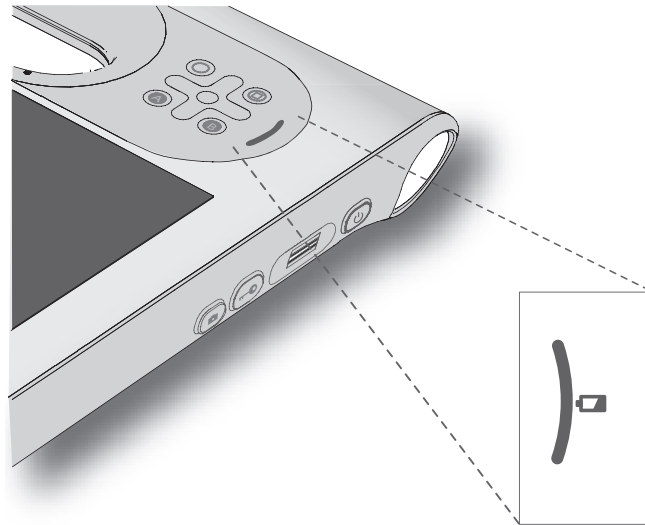

To check the remaining battery power while running on the battery:

1. Locate the battery gauge on the front of the tablet.
2. Count the number of battery gauge lights. Each light represents about 20% increments of a full charge.

When the tablet is on *battery power*, the lights indicate:

- Four green lights: The battery is three-fourths to fully charged.
- Three green lights: The battery is one-half to three-fourths charged.
- Two green lights: The battery is one-fourth to one-half charged.
- One green light: The battery is one-fourth charged.
- Flashing amber light: The battery is low and requires an immediate charge.

When the tablet is on *AC power*, the lights indicate:

- One amber light: The battery is less than one-fourth charged.
- Two amber lights: The battery is one-fourth to one-half charged.
- Three amber lights: The battery is one-half to three-fourths charged.
- Four amber lights: The battery is three-fourths charged.
- Four green lights: The battery is fully charged.

To check the remaining battery power when the tablet is off:

- Press the button next to the battery gauge on the back of the battery.

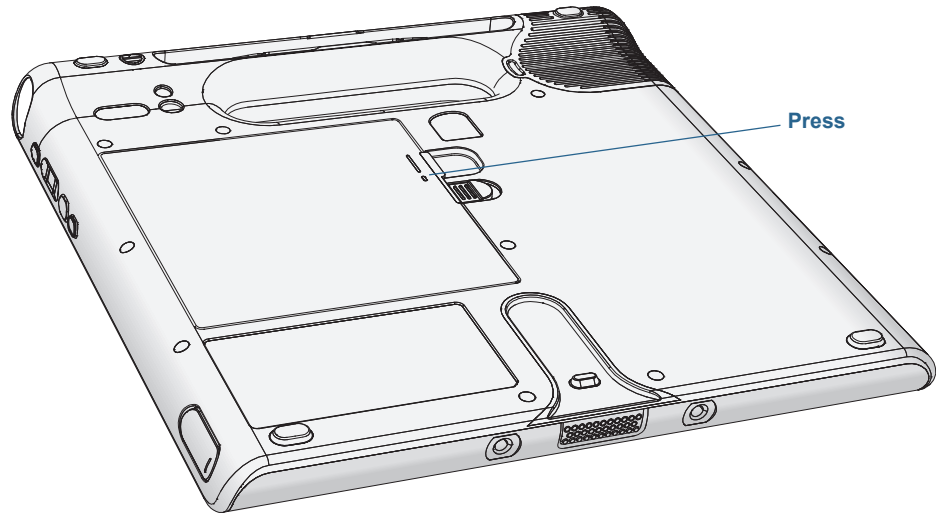

The indicator lights show the remaining charge. Each light represents about 20% of the total charge.



To check the remaining battery power from the Motion Dashboard:

1. Open [Motion Dashboard](#).
2. Tap **Power**, which displays the percentage of remaining battery charge.

To check the remaining battery power from the Windows® notification area:

- Tap the power indicator, which looks different depending on whether the tablet is plugged in.
 - If the tablet is plugged in, tap the plug icon .
 - If the tablet is on battery power, tap the battery icon .

Removing and replacing the battery

Before you remove the battery, ensure that the tablet is plugged in, turned off, or in Hibernate ([page 13](#)) or Sleep mode ([page 13](#)). If you're hot-swapping the battery ([page 43](#)), you can do so while the tablet is on and running on battery power.

To remove the battery:

1. With the back of the unit facing you, slide and hold the battery latch.
2. Insert your finger under the finger grip and remove the battery from the battery compartment.

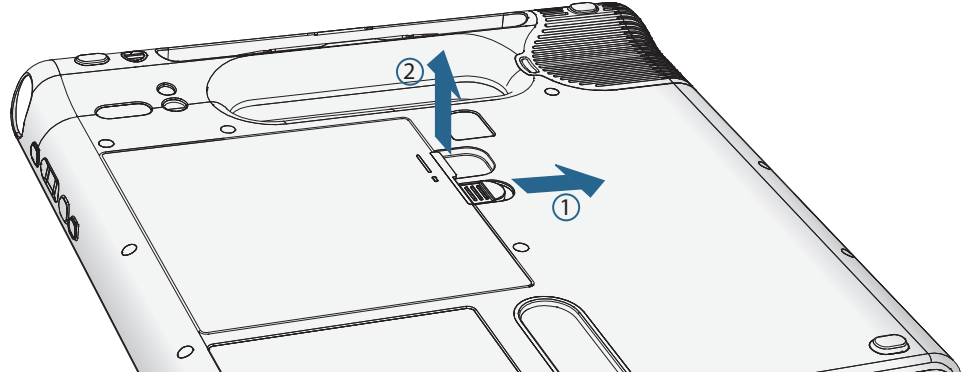

To replace the battery:

1. Place the tabbed end of the battery into the battery compartment.
2. Press the battery down until it locks into place.

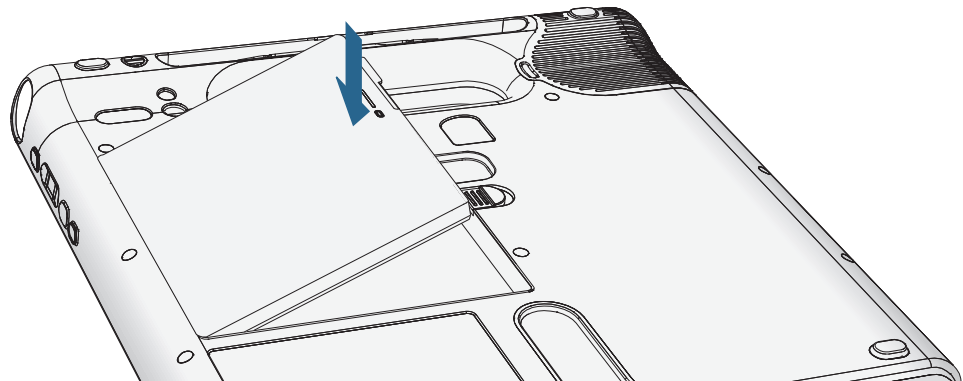

Hot-swapping the battery

Changing a tablet battery while the tablet is in use and running on battery power is called “hot-swapping.” You can hot-swap a battery only if you have a *second* charged battery to replace the battery that is low on power.

While hot-swapping the battery, you will notice the following behaviors:

- The tablet’s display gets dimmer. Once the charged battery is in the tablet, the tablet’s display brightens again.
- The battery gauge’s LED lights turn off. Once the charged battery is in the tablet, the LED lights turn on again.
- The power button is disabled. (The power button is disabled at any time the tablet has no battery and is not running on AC power through the power adapter.)

Important: You have one minute to hot-swap the battery. If you don’t insert a charged battery within one minute, the tablet goes into Hibernate mode. If the tablet is in Sleep mode and you don’t insert a battery within one minute, the tablet wakes up, then goes into Hibernate mode.

To hot-swap the battery:

1. Remove the battery (page 41).
2. Insert the new battery (page 41).

Important: Use only Motion Computing C5/F5-Series batteries with the tablet.

Long-term battery storage

Don’t store any batteries with a full charge; this can cause a permanent loss of charging capacity. For long-term storage, ensure that the charge level is between 20% and 40% (two contiguous LEDs illuminated), and remove the battery from the tablet. Check stored batteries every 90 days to determine the charge status. If only one LED or no LED is illuminated, recharge the batteries to a level between 20% and 40%.

For optimum care, store the battery in a cool, dry environment. Never expose the battery to temperatures above 60°C (140°F).

NOTE: In storage, the batteries will self-discharge at a rate of 10% of the total capacity per month.

Disposing of used batteries

A Lithium-ion (Li-ion) battery should be disposed of at a hazardous materials recycling center when it is no longer serviceable. Don’t throw it in a waste receptacle because the battery could be deposited in a landfill.

Battery and power management tips

- To lengthen the battery's usable life, use AC power when you can. The battery charges automatically when the tablet runs on AC power.
- For optimal battery life, use AC power when using a USB device such as a DVD player or external hard disk drive.
- When running on battery power, place the tablet in Hibernate or Sleep mode if you're going to leave it unattended for more than a few minutes. For more information on hibernate and Sleep mode, see [Changing how the power button functions](#) on page 45.
- Remember that the display, processor, wireless cards and accessories all draw on the battery, so adjust properties and disable unused accessories while running on battery power.
- Condition your battery once a month. To condition it, run the tablet on battery power until the battery's charge level drops below 20%.
- When running on battery power, adjust the display to a dimmer setting and enable Dynamic. Open [Motion Dashboard](#), tap the **Display** tab and tap **Dynamic**.
- Turn off wireless devices when they aren't being used. Open [Motion Dashboard](#), tap the **Wireless** tab, and clear the checkbox next to the wireless device you want to disable.

Changing the power plan

By default, the C5t/F5t uses the Motion Optimized power plan that is designed specifically for Motion Computing tablets. It balances the need to save power while maximizing tablet performance. When the tablet senses no current activity, it goes into Power Saver mode automatically.

If necessary, you can change the Motion Optimized power plan from the Motion Dashboard.

To change the power plan:

1. Open [Motion Dashboard](#).
2. Tap **Power**.
3. Tap **Power Options**.
4. Select a power plan from the list of available plans.

NOTE: Setting the power plan to Power Saver reduces the tablet's performance.

Changing how the power button functions

When you press and release the power button, it can go into one of the following modes:

- **Sleep**—The tablet pauses all activity immediately and quickly resumes when awakened. This saves power when you're away from your tablet for a short time. However, you will lose unsaved data if there's a power failure.
- **Hibernate**—The tablet saves the contents of memory to the hard drive and shuts down. Pressing the power button restores the desktop exactly as you left it. Hibernate consumes about as much power as a night light and takes less time to restart than the Shut down option.
- **Shut down**—Tablet shuts down. Pressing the power button reboots the tablet.

By default, the tablet goes to sleep when you press and release the power button . To wake up your tablet, press and release the power button again. You can put the tablet in Hibernate mode or shut it down completely from the Start menu.

You can change how the power button behaves when it is pressed either to hibernate or to shut down the tablet. You can set the behavior individually, depending on whether the tablet is running on battery or plugged in.

To change what happens when the power button is pressed:

1. Open [Motion Dashboard](#).
2. Tap **Power**.
3. Under **Power Switch on battery**, select what you want to happen when the power switch is pressed while the tablet is running on battery.
4. Under **Power Switch plugged in**, select what you want to happen when the power switch is pressed while the tablet is plugged into an outlet.

Using Wi-Fi (802.11a/g/n)

Use the information in this section to set up a Wi-Fi connection. Wireless access requires an appropriate access point. Internet access requires a working Internet connection.



DANGER: FAA regulations require that you disable any wireless connection when traveling by air. Failure to disable the wireless connection on the system while traveling by air can cause communications problems with aircraft instruments.

Enabling or disabling Wi-Fi

Before you can establish a Wi-Fi connection, you must enable the Wi-Fi adapter. You can enable the Wi-Fi adapter using Motion Dashboard.

NOTE: Wireless cards consume battery power. To reduce power consumption when running on battery power and when Wi-Fi is not being used, disable Wi-Fi in the Motion Dashboard.

To enable or disable Wi-Fi:

1. Open the Motion Dashboard to the Wireless panel (page 18).
2. Select or clear the **Enable Internal 802.11 Wireless** check box.

Setting up a Wi-Fi connection

Follow these steps to create a Wi-Fi connection.

To set up a Wi-Fi connection:

1. Open the Motion Dashboard to the Wireless panel (page 18).
2. Ensure that **Enable Internal 802.11 Wireless** is selected.
3. Tap the **Properties** button.
4. In the Network Connections center, tap the wireless network connection.
5. Tap **Connect To**, then select a network.

If you are connecting to a secure network, you may need to enter authentication information. If you are connecting to an unsecured network, you may be prompted to select whether to connect to the unsecured network or connect to a different network.

Using Mobile Broadband with GPS

Your Tablet PC may be equipped with an optional embedded Mobile Broadband with GPS module. Use the information in this section to enable Mobile Broadband and the Mobile Broadband GPS receiver. Mobile Broadband access requires an account with a Mobile Broadband network carrier. To use the GPS receiver, you do not need a network connection or an account with a Mobile Broadband network carrier.



WARNING: FAA regulations require that you disable any wireless device when traveling by air. Failure to disable the wireless device on the tablet while traveling by air can cause communication problems with aircraft instruments.

Enabling Mobile Broadband with GPS

Before you can establish a Mobile Broadband connection or use the Mobile Broadband GPS receiver, you must enable Mobile Broadband with GPS in Motion Dashboard.

NOTE: Wireless cards consume battery power. To reduce power consumption when running only on battery power and when Mobile Broadband is not being used, disable Mobile Broadband and GPS in the Motion Dashboard.

To enable Mobile Broadband with GPS:

1. Open the Motion Dashboard to the Wireless panel (page 18).
2. Select the **Enable Mobile Broadband with GPS** checkbox.

Using the GPS receiver

The Mobile Broadband module includes a GPS receiver. The GPS receiver provides the current location, altitude, heading, and horizontal velocity of the tablet through the Connection Manager user interface and through a virtual communications port.

You can use the Connection Manager to monitor the Mobile Broadband GPS receiver.

To use the GPS receiver, you do not need a network connection or an account with a Mobile Broadband network carrier.

Using the Connection Manager

The Connection Manager lets you configure the Mobile Broadband module with network profiles that enable it to function on various mobile broadband carrier networks. A network profile includes a mobile broadband network name and the information required to connect to the network.

The Connection Manager also lets you start, stop, and manage the Mobile Broadband GPS receiver.

To start the Connection Manager:

- Tap **Start > All Programs > Motion Computing > MotionCM**.

For more information, see the Connection Manager Help.

Using the discrete GPS receiver with WAAS, EGNOS, and MSAS

The discrete GPS receiver uses satellites to provide the current location, altitude, heading, and horizontal velocity of the tablet through a virtual communications port. There is no user interface for the discrete GPS receiver. The discrete GPS receiver is always on whenever the tablet is powered on. The virtual communications port assigned to the discrete GPS receiver by Windows® can be viewed in the Control Panel System Device Manager.

NOTE: To use the discrete GPS receiver, you don't need a network connection or an account with a Mobile Broadband network carrier or service provider.

Using Bluetooth

You can use Bluetooth to connect to accessory devices or other computers. The devices can communicate with each other when they are in range.

Enabling or disabling Bluetooth

Before you can set up a Bluetooth device, you must enable the Bluetooth adapter on the tablet. After you enable Bluetooth, the Bluetooth icon () appears in the notification area. You can tap on this icon to get shortcuts to the Bluetooth Settings window and the Add New Connection Wizard.

NOTE: To reduce power consumption when running on battery power and when Bluetooth is not being used, disable Bluetooth in the Motion Dashboard.

To enable or disable Bluetooth:

1. Open Motion Dashboard to and tap Wireless panel (see [Using the Motion Dashboard](#) on page 18).
2. Select or clear **Enable Internal Bluetooth Wireless**.

After you enable Bluetooth, the Bluetooth adapter tries to discover other Bluetooth devices within range. When a Bluetooth device is discoverable, it is visible to other Bluetooth devices in range. For information about making the Bluetooth device discoverable, see the device's documentation.

Setting up a Bluetooth device

Before you can use a Bluetooth device with your Tablet PC, you need to set up the Bluetooth connection. When the device is set up, or paired with the system, a passkey is used to create a secure connection between the system and the Bluetooth device.

NOTE: Although the passkey exchange helps to secure your data, Bluetooth wireless technology should not be considered completely secure.

To set up a Bluetooth connection:

1. Ensure that Bluetooth is enabled.
2. Place the Bluetooth device in discoverable mode. Each Bluetooth device may have a different way to make it discoverable. See the manufacturer's documentation for more information.
3. Click **Start**, then enter "bluetooth device" in the search field.
4. Select **Add a Bluetooth device** from the search results.

5. The **Select a device to add to this computer** window is displayed and Windows® searches for your Bluetooth device.
6. If the device is not discovered, see [Bluetooth wireless tips](#) on page 72.
7. Select your Bluetooth device after Windows® shows the device, then click **Next**.
8. Select a pairing option, then click **Next**.
9. Once the device is added, Windows® displays a confirmation that the Bluetooth device has been added.
10. Tap **Devices and Printers** to verify that the device has been added or click **Close** to close the window.

Using the fingerprint reader

Using the fingerprint reader, you can log on to the tablet by scanning your fingerprint instead of entering a password. This feature provides another level of security for the tablet.

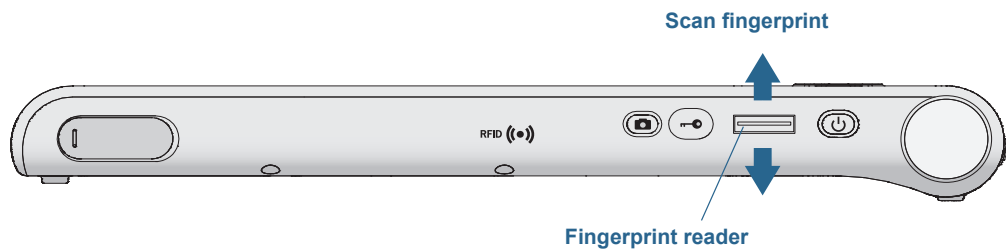

With the fingerprint reader, you can avoid having to enter passwords for your applications and websites. For example, instead of entering various passwords to your different website accounts, you can use your fingerprint to serve as a master password that works for all your accounts.

The steps to set up a fingerprint password include:

1. Start the Motion OmniPass™ application that you use to define and manage your fingerprint.
2. Create an Omnipass user account (called enrolling the user). See [page 51](#).
3. Replace passwords for sites by registering OmniPass credentials. After enrolling in OmniPass, the next time you're prompted for your password you can replace the password with your OmniPass credentials. See [page 52](#).
4. Set up strong logon security. See [page 52](#).

In addition, you can use OmniPass to protect sensitive data stored on your tablet and you can perform other security measures. For details, see the OmniPass help.

Starting the OmniPass application

You use the OmniPass application with the fingerprint reader to create and manage your fingerprints. After enrolling as an OmniPass user, you use OmniPass to secure files, applications and websites by requiring a fingerprint swipe.

To start Motion OmniPass:

- In the Windows® notification area, double-tap the Motion OmniPass icon (🔑).

When you start the application for the first time, the Motion OmniPass application looks like this:

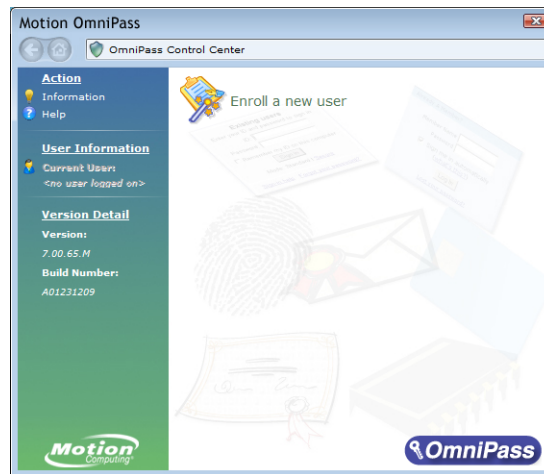

Motion OmniPass Initial Start Up

After you've enrolled as an OmniPass user, the application opens the OmniPass Control Center, which looks like this:



Create an OmniPass user account

You create (enroll as) a new OmniPass user to register your fingerprint. Before you begin, read the following tips.

Fingerprint reader tips

- For best results, use the **Practice** option to familiarize yourself with the fingerprint reader before enrolling the first time.
- Be consistent. Hold your finger and scan at the same angle each time. For example, if you enroll your finger with your hand open, hold your hand this way each time you scan.
- The scanner is bi-directional. You can move your finger from right to left or left to right.
- Read the prompts carefully and ensure that you wait for the prompt before you swipe.
- Swiping too fast or too slow can make a capture unsuccessful. Change the swipe speed until you learn what speed works best.
- When scanning, press hard enough to fully contact both the nickel-colored ring and the sensor; you don't have to press hard.
- Rub your fingers together to stimulate the natural skin oils so your fingerprint is easier to detect. Conversely, wipe dirt or debris off your finger before scanning it so nothing interferes with the scan.
- If you're having trouble enrolling a specific finger, enroll a different finger. Enroll multiple fingers in case one is injured.
- If you're repeatedly having trouble getting a good scan, you may need to clean the sensor. See [Cleaning the fingerprint reader](#) on page 64.

To enroll as a new OmniPass user:

1. If you haven't already done so, [Start OmniPass](#).
2. Tap **Enroll New User**.
3. Follow the instructions in the setup program. When prompted:
 1. Supply your Windows® login user name and password.
 2. Select **Authentec Fingerprint Device**.
 3. Choose which finger you want to use as your fingerprint password and swipe your finger as instructed.
 4. Enroll a second fingerprint, which you can use if you injure your first finger.

Note: You can enroll another fingerprint at another time from the OmniPass Control Center.
4. Back up your user profile to an external drive that you can store in a secure location in the event that your user profile is corrupted.

Replace your passwords

Once you've enrolled in OmniPass, you can use your OmniPass credentials instead of your password to log on to your accounts that require passwords. This is called password replacement. You set up password replacement the next time you're prompted for a password. Instead of entering the password, you register your OmniPass credentials.

To register OmniPass credentials:

1. At the user name and password prompt, enter your user name and password, but don't log on. (Don't tap **Enter**, **Submit**, or **OK**.)
2. Right-click the OmniPass icon, and select **Remember Password**. The Windows® arrow pointer changes to the OmniPass golden key.
3. Tap the key cursor on the window that has the password that you want OmniPass to remember.
Note: For some applications, you may have to use the password wizard to register passwords. If so, from OmniPass Control Center, tap **Password Wizard** and follow the instructions.
4. At the **Friendly Name** prompt, enter a descriptive name to identify the site that you're registering.
5. Check **Automatically enter**. This allows you instant access to the site without requiring a fingerprint scan or password. OmniPass will automatically submit your user name and password without prompting for verification.

Setting up strong logon security

For an additional level of security, you can enable strong logon security. Strong logon security forces you to authenticate with a specific security device (such as the fingerprint reader or a Smart Card) before allowing access to Windows®.

Notes:

- After strong logon security is enabled, the Windows® Welcome screen and Windows® Fast User Switching are disabled.
- After strong logon security is enabled, if the fingerprint reader or smart card reader fails, you may not be able to log on to the computer.

To enable strong logon security:

1. Start Motion OmniPass ([page 49](#)).
2. Tap **Change Your OmniPass Settings**.
3. Tap the **Change System Settings** tab.
4. Select the **Enable strong logon security** checkbox.
5. Tap **Save all changes**.
6. Tap **OK** and restart the computer.

After you restart the computer, you should configure the authentication rules for strong logon security.

To configure authentication rules:

1. Start Motion OmniPass ([page 49](#)).
2. Tap **Change Your OmniPass Settings**.
3. Tap **Set user authentication rules and policies**.
4. Select the appropriate authentication rules.
5. Tap **OK**.

Using the smart card reader

Your tablet may include the optional smart card reader located on the back of the tablet next to the battery. Using smart card software, this device reads information from the smart card when the card is inserted into the reader.

The smart card is an ISO 7816 PC/SC compliant, contact type smart card reader/writer.

Depending on the smart card software you're using:

- You may receive an acknowledgement when the smart card is fully engaged in the reader.
- You may receive a prompt or be required to shut down the software before removing the smart card.
- Some smart cards may require you to insert the smart card for authentication, and then remove the smart card when authentication is completed.
- Some smart cards may require keeping the card in the reader while the smart card software is running.

To insert the smart card:

1. Place the smart card in front of the smart card reader opening with the metal contacts of the embedded chip facing the back of the tablet.
2. Slide the smart card into the smart card reader until the card is firmly seated in the reader.

To remove the smart card:

1. Depending on your smart card software, you may be required to shut down the smart card software first before removing the card. With this type of software, removing the smart card while the tablet is running can result in logging off or shutting down the tablet.
2. Pull the card straight out of the reader.

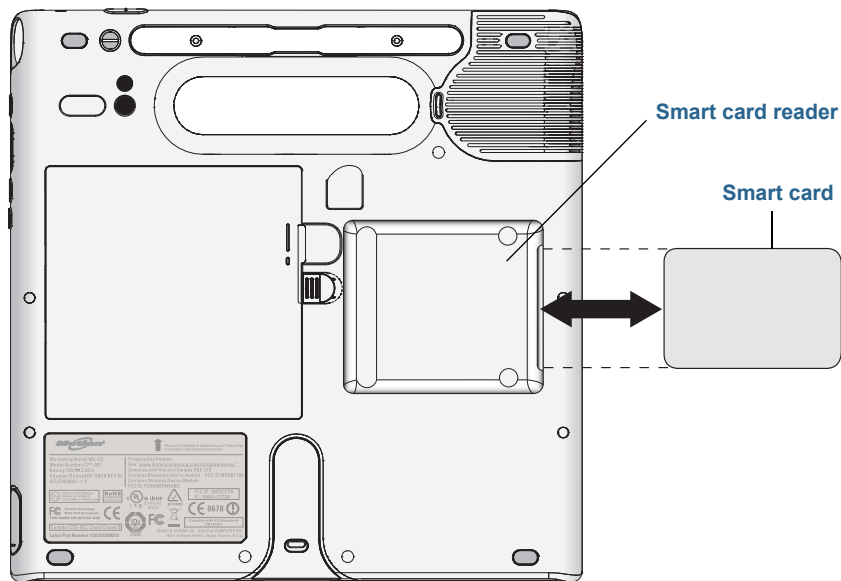

Using the SIM card slot

The SIM card slot holds one SIM card. You need to use a SIM card only if you're using mobile broadband on a GSM/UMTS/HSPA network. Contact your service provider for additional information.

To insert a SIM card:

1. Turn off the tablet and remove the battery ([page 41](#)).
2. Locate the SIM slot door and open it.

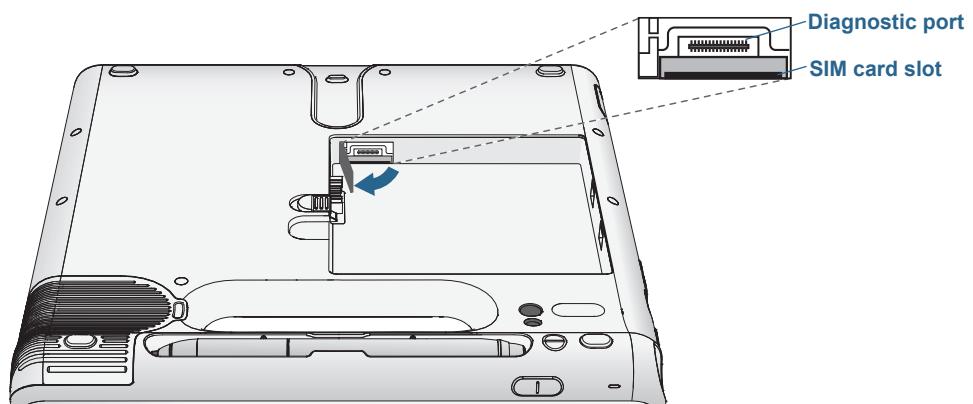

Note: The SIM card slot and a diagnostic port are behind the SIM card slot door. The SIM card slot is below the diagnostic port.

3. Place the SIM card label-side down on the battery tray. Ensure that the notch on the SIM card is in the upper-right corner.

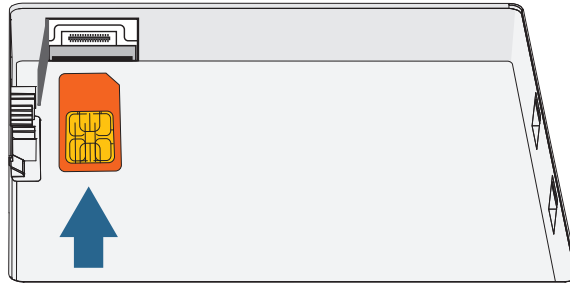

4. Slide the SIM card into the SIM card slot until it clicks into place. You may need to use a paper clip to push the SIM card all the way in.

To remove a SIM card:

1. Turn off the tablet and remove the battery ([page 41](#)).
2. Open the SIM card slot door.
3. Press the card in slightly until it pops out. You may need to use a paper clip to push the SIM card in to release it.

Using Windows® Action Center

Windows® Action Center provides a central location for you to manage the tablet's security settings and learn more about improving security. If a problem is detected (such as an out-of-date antivirus application), the Action Center sends you an alert and provides recommendations for how to remedy the situation.

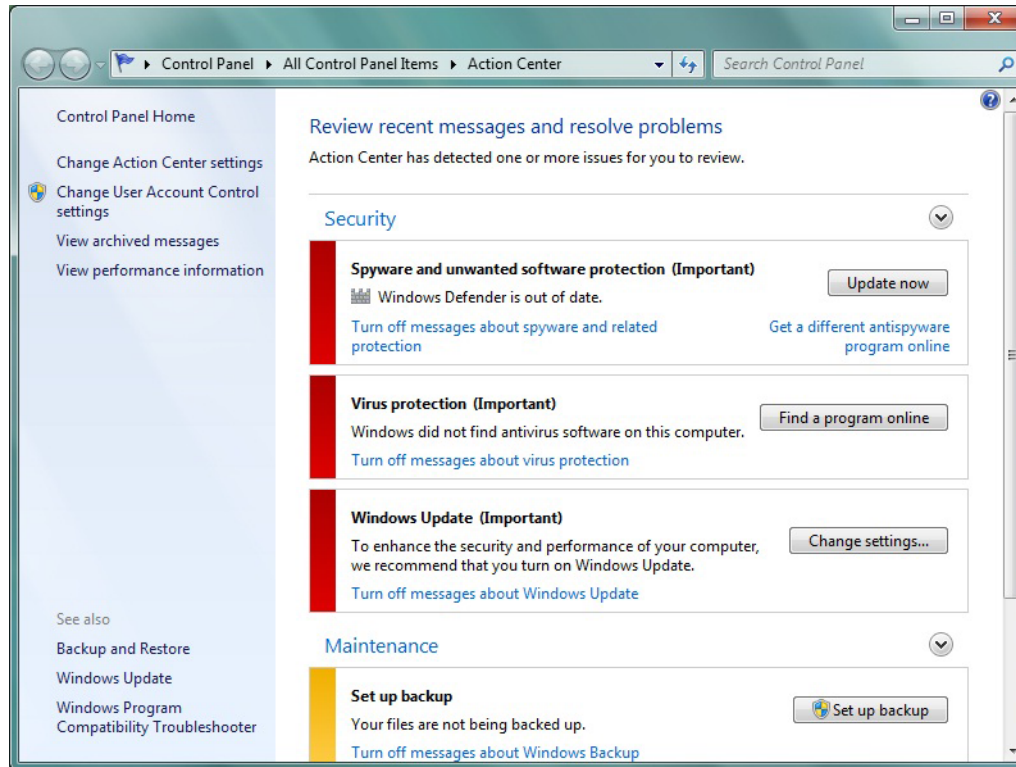

To learn more, open Motion Dashboard to the Security panel, then tap **Windows® Action Center**.

Setting up user accounts

If you share the tablet with other users, you can set up a user account for each user. User accounts control which files and programs users can access and what types of changes users can make to the computer. A user account allows each person to have their own settings.

If you have an administrator account, you can add new user accounts from the Microsoft® Management Console. For detailed instructions on setting up new users, open Windows® Help and search for "Create a user account."

Locating your serial number

You can locate the serial number for your C5t/F5t from the:

- White label underneath the battery, which is located on the back of the tablet. The number begins with “S/N.” To remove the battery, see [Removing and replacing the battery](#) on page 41.
- Windows® Start menu.
- BIOS Setup Utility.

To locate your serial number from the Start menu:

1. From the Start menu, tap **Computer**, then tap and hold anywhere in the window to open the options menu. Select **Properties**.
2. Under the **System** section of the page, view **Model**.
The serial number begins with “S/N.”

NOTE: You can also locate the number from the BIOS Setup Utility.

Backing up your system

To protect against loss or accidental deletion, schedule backups to occur automatically on a regular basis. Windows® 7 has a backup tool that you can use to configure what you want to backup and schedule backups on a regular basis.

To schedule backups:

1. From the Control Panel, tap **System and Security** category then tap **Back up your computer**.
2. Tap **Set up backup**.

Follow the on-screen instructions.

You can restore files from a backup. For more information, open Windows® Help and search for “Restore files from a backup.”

Restoring your system

Windows® 7 has specialized tools for restoring your system in case of system failure. This section covers:

- Creating a system image to use to restore your computer if necessary
- Restoring the computer from a system image using Windows® Control Panel
- Restoring the tablet from BIOS if Windows® 7 can't run

NOTE: System images are designed for restoring your entire system at once when you have a serious problem with Windows® 7. If you want to install particular files, folders or other data, use Windows® Backup.

Creating a system image

You can use a system image to restore the contents of your tablet if it ever stops working. A system image is an exact copy of a drive and includes Windows® 7, your system settings, programs, and files. The system image requires an external drive, such as a USB flash drive, on which to store the image.

NOTE: We recommend that you create a system image as soon as you set up your tablet and then periodically.

To create a system image:

1. Locate a USB flash drive or other external drive on which to store your system image.
2. From the Windows® Control Panel, tap **System and Security** category, then tap **Back up your computer**.
3. From the navigation bar on the left, tap **Create a system image**, then follow the on-screen instructions.

For complete instructions, open Windows® Help and search for “Back up your programs, system settings, and files.”

Restoring your system image from Windows® Control Panel

Use the Recovery tool from the Control Panel to restore your system if you can still access Windows® 7 or if you’re restoring your system image onto a different computer.

To restore your system from Windows® Control Panel:

1. Locate the external drive that contains your system image.
2. From the Windows® Control Panel, tap **System and Security** category, then tap **Backup your computer**.
3. Tap **Recover your system settings or your computer**, then **Advanced Recovery Methods**, then **Use a system image...**
4. Follow the on-screen instructions.

For more information, open Windows® Help and search for “Back up your programs, system settings, and files.”

Restoring your system image if you can't start Windows® 7

If you need to restore your system and cannot access Windows® 7, you can access the recovery tool in the Windows® Advanced Boot Options screen.

NOTE: Before starting, locate the external drive that contains the system image you created previously (page 58) and ensure that a keyboard is attached to your tablet.

To restore your system image from the Windows® Advanced Boot Options screen:

1. Press the tablet's power button  to start the tablet.
2. Press and hold the **F8** key to display the Windows® Advanced Boot Options screen.

You need to press **F8** *as soon as* the tablet starts up to access the Windows® Advanced Boot Options screen. If the Windows® logo appears, you need to try again by waiting until the Windows® logon prompt appears, and restarting your tablet from the Start menu.

3. In the **Advanced Boot Options** screen, select **Repair your computer** and press **Enter**.

The message "Windows is loading files..." and a progress bar will be displayed and there will be a brief waiting period while the necessary files load.

4. Select a keyboard layout in the System Recovery Options dialog box, then press **Enter**.
5. Select a user name and enter the password, then press **Enter**.
6. Attach the external drive that contains the system image.
7. In the **System Recovery Options** dialog box, use the **Tab** key to navigate to **System Image Recovery** and then press **Enter**.
8. Follow the instructions to **Re-image your computer**.

Restoring your system without a system image

If you need to restore your Windows® 7 system and you do not have a system image, you can restore Windows® to its original factory image. This does not restore any of your files or any programs that you have installed.

To reinstall the original factory image:

1. Ensure that a keyboard is attached to the tablet.
2. Press the tablet's power button  to start the tablet.
3. Press and hold the **F8** key to display the Windows® Advanced Boot Options screen.

You need to press **F8** *as soon as* the tablet starts up to access the Windows® Advanced Boot Options screen. If the Windows® logo appears, you need to try again by waiting until the Windows® logon prompt appears, and restarting your tablet from the Start menu.

4. In the **Advanced Boot Options** screen, select **Repair your computer** and press **Enter**.

The message “Windows is loading files...” and a progress bar will be displayed and there will be a brief waiting period while the necessary files load.

5. Select a keyboard layout in the System Recovery Options dialog box, then press **Enter**.
6. Select a user name and enter the password, then press **Enter**.
7. In the **System Recovery Options** dialog box, use the **Tab** key to navigate to **Reinstall Windows**.
8. Press **Enter** to reinstall Windows®.
9. Check to see whether Windows® was able to save any data from the tablet. Look in the folder called **Windows.old**.

Finding other software

For information about other software for your tablet, go to [Motion Computing Accessories](#) and the [Motion Computing Store](#). You will find links to software solutions for purchase as well as free downloads from Motion Computing and its service partners.

Caring for your C5t/F5t

3

Proper care and maintenance will keep your C5t/F5t Tablet PC working and in good condition. For general information about care of the tablet and its components and accessories, see the *Safety and Regulatory Guide* included with your Tablet PC.



WARNING: Follow the guidelines listed below when caring for your C5t/F5t Tablet PC and its components. Improper use may damage the Tablet PC and its components and void the warranty.

General care

- Protect the Tablet PC from exposure to extreme temperatures, shock, liquids, and strong magnetic fields.
- Don't place heavy objects on top of the Tablet PC.
- If you're storing the tablet for a long time, unplug the power adapter and remove the battery after partially discharging it.
- Don't open the case. Opening the case will void your warranty.

Caring for the display

Follow these suggestions to keep your display clean:

- Clean fingerprints and smudges from the display surface by wiping it with the cloth provided.
- If needed, use [a cleaning solution recommended by Motion Computing](#) to clean the display. Spray the solution on a cloth then wipe the display. Never spray directly onto the display surface and never use an abrasive cleaner.
- If liquid is spilled on the display, wipe it up immediately with a soft cloth like the one provided with the tablet.
- Use only the C5t/F5t pen to write on the display. Any other object could damage the display surface.
- Protect the display surface from unnecessary contact by using a case when transporting the Tablet PC.
- Cover the display with a protective display film.
- Avoid exposing the display to direct sunlight for long periods of time.
- If your tablet comes with a View Anywhere display, clean with any alcohol-based product recommended for anti-reflective glass. Other cleaning products might leave a residue.
- You can also purchase protective display films as well as protective cases from the [Motion Computing Accessories](#) page.

Cleaning solutions

Motion Computing maintains a list of [C5t/F5t chemical disinfectants and cleaning products](#) on its website.



WARNING: Don't use any corrosive or abrasive cleaners to clean or disinfect the tablet.

Caring for the pen

If you use a pen with your tablet:

- Store the pen in the pen holder when not in use.
- Avoid storing the pen vertically on its tip. It can damage the pen-to-digitizer function.
- Keep the pen away from any liquid because the pen contains electronic components that could be damaged when wet.
- In certain environments, particles or debris can stick to the pen tip or the Tablet PC display. Make sure you wipe off the pen with a soft cloth to avoid scratching the display.
- Change the tips regularly, especially if you drop the pen onto a rough surface that could damage the tip or embed debris in it. Damaged pen tips can scratch the display.

NOTE: To order pens or new pen tips, go to [Motion Computing Accessories](#).

Replacing pen tips

Pen tips eventually wear down or get damaged, so the pen includes extra tips and a tool for replacing them.

With typical use, you should change the pen tip every 90 days. If you use the pen in a dirty or dusty environment, you should change the pen tip every 30 days. Particles can become embedded in the pen tip and scratch the display.

To replace the pen tip:

1. Grasp the old tip with the replacement tool. Use the notch on the ring to grab the tip.
2. Pull the old tip out of the pen.
3. Insert a new tip, placing the flat end of the pen tip in first.
4. Apply slight pressure to push the tip in to place.

Cleaning in a healthcare environment

This section describes the cleaning procedures for the Tablet PC in a healthcare environment.

Disinfecting procedures

You should periodically disinfect the tablet according to the institutional policies of surface and equipment safety and cleanliness. Motion Computing has tested a variety of antimicrobial solvents and information about specific products is available upon request.

According to the Centers for Disease Control and Prevention, “items that do not ordinarily touch the patient or touch only intact skin aren’t involved in disease transmission, and generally do not necessitate disinfection between uses on different patients”.¹ We recommend using an EPA-approved low-level disinfectant when general cleaning is required. For a list of cleaning solutions tested by Motion Computing, see [Cleaning solutions](#) on page 62.

If the tablet becomes soiled with blood or other body fluids, a hospital-approved low-level disinfectant that is tuberculocidal/virucidal when used at recommended dilutions and contact times can be used.

1. Centers for Disease Control and Prevention. “Sterilization or Disinfection of Medical Devices-General Principles.” 2002.
<www.cdc.gov/ncidod/dhqp/bp_sterilization_medDevices.html> (20 Sept. 2006).

Visibly soiled areas should first be cleaned and then disinfected, or a detergent disinfectant can be used. For disinfection, the cleaned areas should be moistened with the appropriate germicide and allowed to air-dry.¹

If the tablet is used with patients who are infected or colonized with vancomycin-resistant enterococci or other drug-resistant microorganisms judged by the infection control program (based on current state, regional, or national recommendations, to be of special or clinical or epidemiologic significance or with highly virulent microorganisms such as Ebola or Lassa), then the unit should be dedicated to one patient or patient cohort or subjected to low-level cleaning between patient uses.¹

Training and documentation considerations

All users of tablet computers in the healthcare environment should be provided with training on proper cleaning procedures. Cleaning procedures should be added to the institution's policies and procedures for infection prevention.

Cleaning the fingerprint reader

Under normal circumstances, you should clean the fingerprint reader once a month, or whenever necessary.

To clean the fingerprint reader:

1. Shut down the tablet, unplug it, and remove the battery.
2. Lightly spray a cotton swab with household window cleaner.
3. Gently rub the sensor surface with the cotton swab, slowly rotating the swab so a new, clean surface of the swab is constantly exposed to the sensor surface. Don't allow cleaner to drip or run down into the electronics around the sensor.

Don't use bleach, solvents, or abrasives. Don't spray or pour any liquid directly on the sensor.

4. After cleaning, gently rub the surfaces again with a clean, dry cotton swab. Use a clean swab each time you clean the sensor.

Caring for the tablet battery

To maximize the performance of the battery, condition the battery once a month. To condition it, run the tablet on battery power until the battery's charge level drops below 20%. Then use AC power until it is fully charged.

You will receive a message if the tablet detects that the battery needs conditioning.

For more information about batteries, see [Using the battery](#) on page 39.

Traveling with your C5t/F5t Tablet PC

Use the following tips when you travel with your C5t/F5t Tablet PC:

- Put the Tablet PC in a case to protect the display. Motion Computing sells a variety of cases for the C5t/F5t. You can purchase one at the [Motion Computing Accessories](#) page.
- Store the pen in the pen holder located on the back side of the tablet handle.
- Pack the Tablet PC securely in a briefcase or hand-carried luggage and keep it separate from toiletries, liquids, and food. Don't pack it in checked luggage.
- Before extended use in the field or long trips away from AC power, adjust the power properties to maximize battery conservation. See [Changing the power plan](#) on page 44.
- For international travel, use the appropriate adapters for your destination's electrical outlets. You don't need to buy a voltage converter; the Motion AC adapter will automatically adjust to different voltages.
- You may want to carry proof of ownership or a merchandise passport when traveling internationally.
- Consult your insurance and credit card companies to learn about emergency travel assistance in case your Tablet PC becomes lost or disabled.
- Don't carry your tablet through a metal detector.
- Turn off the Tablet PC or place it in [Hibernation mode](#) for airplane takeoff and landing.

NOTE: The FAA requires that you suspend Wi-Fi, Bluetooth and mobile broadband connections before boarding a plane. You can disable them all at once. To disable the wireless devices, open [Motion Dashboard](#), tap the **Wireless** tab, and clear the checkbox next to each the wireless devices listed.



DANGER: Don't transport Li-ion batteries in checked baggage. The baggage hold can get very hot, which can overheat the Li-ion battery and result in a possible explosion. You can take up to two spare batteries in carry-on luggage, in addition to the one in the unit. Transporting batteries in checked baggage or transporting more than two spare batteries is a violation of federal transportation regulations.

Troubleshooting and FAQs

4

Motion Computing Tablet PCs are thoroughly tested for performance and quality, but occasionally issues can still occur. If you don't find the information you're looking for in this section, go to [Motion Computing Support](#).

Troubleshooting

Use the information in this section to identify and resolve common issues. If an issue has more than one potential cause, the most common cause is listed first.

Power issues

The tablet doesn't shut down

- An application might have stopped responding. Use Task Manager to manually stop the application. Press **Ctrl+Alt+Delete** or press the Security button and select **Start Task Manager**. You can also press and hold the power button  for five seconds to force the tablet to shut down. However, this is not recommended.
- If the tablet doesn't shut down after holding the power switch for five seconds, do the following:
 1. Remove the battery (see [Removing and replacing the battery](#) on page 41).
 2. Unplug the power adapter.

3. Press the camera, Windows® Security, and dashboard buttons simultaneously. For the locations of these buttons, see below.



The tablet won't enter Hibernation mode

- Hibernation might not be enabled. Enable hibernation by adjusting the power button behavior from Motion Dashboard. See [Changing how the power button functions](#) on page 45.

The tablet doesn't return from Hibernation mode while on battery power

- The battery might be depleted. Plug the Tablet PC's power adapter into an AC outlet and into the Tablet PC.

The power button is blinking but nothing is happening

- The tablet is in Sleep mode. Press the power button to wake up the tablet. To power off the tablet completely, you can press and hold the power button  about five seconds. However, this is not recommended. Under normal conditions, power off the tablet from the Start menu by tapping **Shut down**.

The display goes black while the Tablet PC is still turned on

- The tablet might have turned off the display to save power. To restore the display, touch the screen with your finger or the pen.
- The tablet might have gone into Sleep mode. Press and hold the power button  for about one second.
- The tablet might have gone into low-battery Hibernation mode. In Hibernation mode, the power status light is off. Plug the tablet in to AC power, then press and hold the power button for about one second.

Battery issues

The battery doesn't last very long (less than four hours)

- Hot or cold conditions can adversely affect the battery charge. Use AC power if you're operating the tablet in these conditions.
- Accessory devices such as a DVD player and applications that make heavy use of the hard drive can drain the battery more quickly. Remove the accessory devices or use AC power if possible.
- Condition the battery once a month by using the tablet on battery power and allowing the battery charge to drop below 20% before connecting the battery to AC power.
- The battery may be weakening. Use a different battery if possible.
- For other battery optimizing tips, see [Battery and power management tips](#) on page 44.

Display issues

When I connect to an external monitor, the cursor appears on the external monitor and not on my tablet

- This is a known Windows® 7 issue. If you've connected multiple touch-enabled displays, Windows® may not assign touch to the correct display. To fix this issue, run **Setup** to assign touch to the appropriate display. Make sure a keyboard is attached to your tablet and then open Motion Dashboard. Tap **Pen & Tablet**, then tap **Tablet PC Settings**. Tap the **Display** tab, then tap **Setup** next to "Configure your pen and touch displays." Tap **Touch Input**, then press the **Enter** key until you see the instructions appear on the display that you want to use for touch input. Follow the on-screen instructions for setting up touch on this display.

When I disconnect an external monitor, the desktop area is larger than the Tablet PC display

- The tablet may have expanded the desktop beyond the display area of the Tablet PC display when it was connected to the external monitor. Use Motion Dashboard to reset the Tablet PC to the display setting for stand-alone tablets. Open Motion Dashboard, tap **Display**. Then, from the **Display Scheme** drop-down list, select **Tablet Only**.
- The display resolution might not match the native resolution of the LCD. You can use other display resolutions, but you will get the best display quality when the display resolution matches the native resolution of the LCD. Use Windows® Display Properties to set the display resolution to 1024 × 768 pixels. For more information, open Windows® Help and Support and search for "change resolution".

The display goes black while the Tablet PC is still turned on

- The Tablet PC might have turned off the display to save power. To restore the display, tap the screen with the pen (or touch the screen if your tablet has a touchscreen display).
- The tablet might have gone into Sleep mode. Press and hold the power button  for about one second.
- The tablet might have gone into low-battery Hibernation mode. In Hibernation mode, the power status light is off. Plug the tablet into AC power, then press and hold the power button for about one second.

The display is too dim

- The display brightness may be set too low. Use Motion Dashboard to brighten the display. Open Motion Dashboard, tap **Display**, then move the brightness slider to the desired level.

The display is unreadable or distorted

- The screen resolution and color quality may not be set correctly. Use Windows® Display Properties to reset the display settings. From Windows® Control Panel, select **Hardware and Sound** category. Under **Display**, change the resolution until the display appears normal.
- The display driver may have been removed or become corrupted. Use Windows® Device Manager to reinstall the driver. For more information, open Windows® Help and Support and search for “update driver”.

To update the display device driver:

1. Make sure that the tablet is connected to a network.
2. In Control Panel, tap the **System and Security** category.
3. Select **System**.
4. Under System, select **Device Manager**.
5. Expand **Display adapters**.
6. Select the adapter and select **Action > Update Driver Software**.
7. Follow the on-screen instructions.

Touch or pen issues

The Tablet PC doesn't respond to the pen I am using

- Use only the C5/F5-Series pen with the tablet. The Tablet PC doesn't respond to other digitizer pens, even Motion Computing pens for other models.

When I add an external display, touch input doesn't appear on the desired display

- Run touch set up on the desired display. Make sure a keyboard is attached to your tablet and then open Motion Dashboard. Tap **Pen & Tablet**, then tap **Tablet PC Settings**. Tap the **Display** tab, then tap **Setup** next to “Configure your pen and touch displays.” Tap **Touch Input**, then press the **Enter** key until you see the instructions appear on the display that you want to use for touch input. Follow the on-screen instructions for setting up touch on this display.

When I write, I inadvertently click the function button on the pen

- Try adjusting how you hold the pen. Avoid resting your finger on the function button. You can also disable the function button. Open Motion Dashboard, then tap **Pen & Tablet**. Tap **Pen & Input Devices** and tap the **Pen Options** tab. Clear the checkbox, “Use the pen button as a right-click equivalent.”

The pen function button doesn't work

- You may not be pressing the button early enough. Try pressing and holding the pen function button before you touch the pen to the display surface.
- The pen function button may be disabled. To enable it, open Motion Dashboard, then tap **Pen & Tablet**. Tap **Pen & Input Devices** and tap the **Pen Options** tab. Tap the checkbox next to "Use the pen button as a right-click equivalent."

The eraser doesn't work

- The eraser may not be enabled. You can use Tablet and Pen Settings window to enable the eraser. See [Adjusting pen settings](#) on page 23. The eraser works on digital ink only, not text.

On-screen instructions require me to press Enter or Esc, but I don't have a keyboard

- Connect a keyboard to the tablet to continue.

The C5t/F5t responds to my finger but not my pen

- The tablet may be configured to ignore pen input. To check, open Motion Dashboard, then tap **Pen & Tablet**. Tap **Touch Settings** and tap the **Digitizer Options** tab. Set **Input mode** to the recognize both touch and pen.

The C5t/F5t tablet is too sensitive to touch

- Consider changing a touch setting so that you have to double-tap the display to enable touch. Open Motion Dashboard, then tap **Pen & Tablet**. Tap **Touch Settings** and then **Auto mode**.

The pointer on the screen doesn't align with the pen

- The pen may need to be calibrated. Open Motion Dashboard, then tap **Pen & Tablet**, and tap **Calibrate digitizer**. The calibration program begins. Don't touch the display until the program has finished.

Ports and connectors issues

The tablet doesn't recognize the USB device

- Windows® 7 may take a short time to recognize the USB device. Wait a few moments to see if Windows® recognizes the device.
- The device may not be connected properly. Check the connection and ensure it is inserted properly into the USB port.
- The correct driver might not be included with Windows® 7. Check the manufacturer's website for a current driver.

The C5t/F5t is in its dock, but the tablet doesn't recognize any accessory devices, such as the external disk drive or monitor

- The C5t/F5t may not be fully seated in the dock. Remove it from the dock and then replace it.

Network issues

The wireless adapter keeps connecting even when I don't want it to

- Disable the desired wireless adapter from the Motion Dashboard. Open Motion Dashboard, tap **Wireless**, and clear the checkbox next to the wireless adapter that you want to disable.

I can't connect to a wired Ethernet network

- To connect to an Ethernet network, your C5t/F5t must be connected to a docking station. The Ethernet port for the C5t/F5t is located on the dock.
- The connection may be loose. Remove the Ethernet cable and reconnect it.
- The Ethernet network may be experiencing problems. Check with someone near you to determine if he or she has network access.
- Replace the Ethernet cable.

Wi-Fi issues

I can't connect to a wireless Wi-Fi network

- Your C5t/F5t may not have located a Wi-Fi network. From the Start menu, tap **Control Panel** then **Network and Internet**. View your active networks. If no network is connected, tap **Connect to a network** and select a network from the list.
- Wi-Fi must be enabled from the Motion Dashboard. Open Motion Dashboard, tap **Wireless**, and tap the checkbox next to **Enable 802.11 Internal Wireless**.
- You may not have access to the network. Obtain a user name and password from a network administrator.
- Your tablet's security settings may prevent a connection. For example, the network may not be broadcasting the network name (SSID) or encryption may be required. Check with your system administrator.

Bluetooth issues

I can't connect to a Bluetooth network

- Bluetooth must be enabled from the Motion Dashboard. Open Motion Dashboard, tap **Wireless**, and tap the checkbox next to **Enable Bluetooth Internal Wireless**.
- Your Bluetooth device must be paired. From the Windows® notification area, tap the Bluetooth icon  and select **Add a Device**. Make sure the Bluetooth device is discoverable according to its manufacturer's instructions. Select the desired Bluetooth device from the list of available devices. Follow the on-screen instructions to complete the procedure.
- Your Bluetooth device is out of range. The Bluetooth devices are designed for short-range communication and can connect at distances up to 33 feet (10 meters).

No other Bluetooth device can detect the C5t/F5t tablet

- From the Windows® notification area, tap the Bluetooth icon  and select **Open settings**. On the **Options** tab, select **Allow Bluetooth devices to find this computer**.

I tried to pair my Bluetooth device several times but it is not detected:

- Bluetooth must be enabled from the Motion Dashboard. Open Motion Dashboard, tap **Wireless**, and tap the checkbox next to **Enable Bluetooth Internal Wireless**.
- Ensure that the Bluetooth device you're adding is discoverable. See the device's manufacturer's instructions for more information.
- Ensure that the Bluetooth device battery is charged.
- Check which Bluetooth devices are connected. From the Windows® notification area, tap the Bluetooth icon  and select **Show Bluetooth Devices**. The Devices window displays all the Bluetooth devices that are currently connected.
- If the tablet still can't detect the Bluetooth device, contact the device manufacturer for assistance.

My Bluetooth device doesn't work properly

- Some issues arise when using Bluetooth devices as listed below.

Bluetooth wireless tips

Motion Computing and its Bluetooth partners have worked to ensure a positive experience with this technology and to ensure Bluetooth interoperability. In doing so, we have found the following issues:

- **Interference**—If you're running Bluetooth and Wi-Fi at the same time, interference can affect the Bluetooth performance. This is most noticeable if:
 - You try to transfer large amounts of data, such as with file transfers
 - Several Bluetooth devices are operating in an office simultaneously
- **Speech Recognition**—Bluetooth audio has not been fully developed for speech recognition. Therefore, for speech recognition, we recommend that you not use a Bluetooth wireless headset. A better solution is to use Motion Speak Anywhere, which can record clear audio, dictate notes and use voice commands without a microphone headset.
- **Disconnection**—Some Bluetooth devices will disconnect when they go into power-saving mode. Most devices will automatically reconnect when they become active again.
- **Incompatible drivers**—If you attempt to install other wireless headset or other audio drivers (such as Bluetooth or USB) over the Tablet PC audio drivers, a malfunction of the Tablet PC audio system may occur because the drivers may not be compatible.
- **Interoperability**—If you're having issues with interoperability of Bluetooth devices, contact the manufacturer of your Bluetooth device and check its compatibility with the Bluetooth software installed on your Tablet PC.
- **Security**—Bluetooth devices use a passkey to create a secure connection between the Tablet PC and the Bluetooth device. Although the passkey exchange helps to secure your data, Bluetooth wireless technology shouldn't be considered completely secure.

Mobile broadband with GPS issues

I can't connect to a mobile broadband network

- Mobile broadband is only available if you purchased your C5t/F5t with the optional Mobile Broadband with GPS module.
- A mobile broadband network requires you to have a data plan from a cellular network provider.
- You may need a SIM card from your network provider. If the network is on a UMTS network (such as AT&T®, Orange® or T-Mobile®), your network carrier must provide you with a SIM card and you insert the SIM card (see [Using the SIM card slot](#) on page 54). The SIM card contains your account information.
- Mobile Broadband with GPS must be enabled from the Motion Dashboard. Open Motion Dashboard, tap **Wireless**, and tap the checkbox next to **Enable Mobile Broadband with GPS**.
- Motion Connection Manager must be running. The Motion Connection Manager icon  appears in the Windows® notification area when it is running. To start it, from the Windows® Start menu, select **All Programs > Motion Computing > MotionCM**.
- Mobile broadband must be set up through the Motion Connection Manager. To set it up, from the Windows® Start menu, select **All Programs > Motion Computing > MotionCM**. Tap the Help icon and select the help topic, "Setting up mobile broadband." Follow the instructions to set up a network profile and connect to a mobile broadband network.

I changed my SIM card and now I can't connect to my mobile broadband network

- The tablet should be shut down when changing or inserting the SIM card. Restart the tablet to enable the SIM card.

The GPS doesn't work

- The GPS receiver is only available if you purchased your C5t/F5t with the optional Mobile Broadband with GPS module.
- Mobile Broadband with GPS must be enabled from the Motion Dashboard. Open Motion Dashboard, tap **Wireless**, and tap the checkbox next to **Enable Mobile Broadband with GPS**.
- The GPS navigation or mapping application you are using must be able to handle standard NMEA GPS information.

My GPS isn't working properly

- Mobile Broadband with GPS must be enabled from the Motion Dashboard. Open Motion Dashboard, tap **Wireless**, and tap the checkbox next to **Enable Mobile Broadband with GPS**.
- If performance is slow, you may be blocking GPS antenna, which is located on the right, bottom side of the Tablet PC. Don't hold the tablet in this area (shown below) when using the GPS receiver.

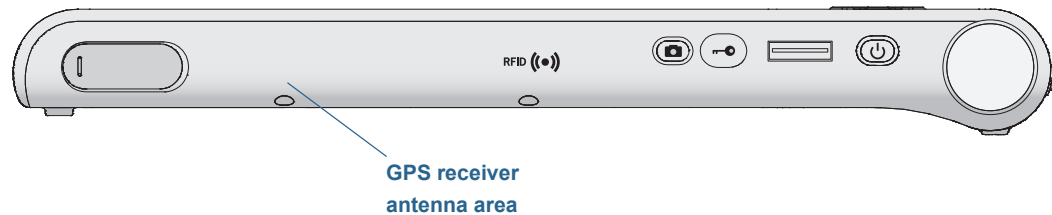

Audio issues

No sound is coming from the built-in speakers

- Ensure that nothing is connected to the audio in/out jack. Connecting headphones or external speakers disables the built-in speaker.
- The volume may be set too low or muted. You can use Motion Dashboard to increase the volume or turn mute off. Open Motion Dashboard, then tap **Audio**, and move the slider to the desired volume.

No sound is coming from the built-in speakers or external speakers

- The volume may be set too low or muted. You can use Motion Dashboard to increase the volume or turn mute off. Open Motion Dashboard, then tap **Audio**, and move the slider to the desired volume.
- The integrated audio components may have been overwritten. If you install a third-party audio device (such as a USB or Bluetooth device), the integrated audio may stop working. If this happens, reinstall the audio drivers. After you install these, if you still have issues with recording, contact your system administrator or service provider.

System issues

I forgot my BIOS password and can't access my tablet

- You can enter several incorrect passwords before the BIOS temporarily locks the system. You can try again by restarting the system. If you still can't log on, contact your system administrator.

The tablet seems to be operating slower than usual

- Reboot.
- The solid state drive (SSD) may be full or nearly full. You can use Disk Cleanup to free up space on your drive. For instructions, open Windows® Help and search for "disk cleanup."
- Unlike traditional hard drives, SSD drives, such the one installed in C5t/F5t, see no performance benefit from traditional HDD defragmentation tools. Using these tools

simply adds unnecessary wear to the SSD. It is recommended that you disable any automatic or scheduled defragmentation utilities on your tablet.

I want to make my tablet run faster

- Change the Power plan to **High Performance** from the Motion Dashboard (see [Using the Motion Dashboard](#) on page 18), Power tab.
- Adjust your Windows® settings. For instructions, open Windows® Help and search for “improve performance.”

Frequently asked questions

How can I make the battery charge last longer?

- By default, the power plan for the C5t/F5t is a balance between optimal performance and a long battery charge. If you want the tablet to run longer between charges, use the **Power saver** power plan. Open Motion Dashboard, tap **Power**. Tap **Power Options** and select **Power saver**.
- Use the Dynamic display setting. This automatically controls the display to conserve power. Open Motion Dashboard, tap **Display**, then tap **Dynamic**.
- Set the display to the dimmest level you’re comfortable with. Open Motion Dashboard, tap **Display**, then move the Brightness slider to the desired level.
- Disconnect any Ethernet connections that aren’t being used. Disable the wireless adapter and Bluetooth adapter if you’re not using them. Disconnect unnecessary USB devices. To disable the adapter, open Motion Dashboard, tap **Wireless**, and clear the checkbox next to the adapters you’re not using.
- Stop unnecessary background applications and processes.

How do I know if the tablet is charging when I plug it in to a power adapter?

- The battery gauge button on the front of the tablet is amber when the tablet is charging.

How do I check the battery charge when I’m running on the battery?

- The battery gauge on the front of the tablet shows the level of battery charge. The number of lights indicate the level of charge where four green lights indicate a full charge and one green light indicates that about 20% charge is remaining. If the lights are flashing amber, the battery is low and requires immediate charging.

How do I clean the display screen?

- To clean the display screen, wipe it with a soft cloth (like the one supplied). Don’t spray cleaners, pour any liquid, or wipe any abrasive cleaner on the screen or any surface of the Tablet PC. Don’t use tissues or paper towels to clean the screen. They contain wood fibers that may scratch the surface.
- Motion Computing maintains a list of [C5t/F5t chemical disinfectants and cleaning products](#) on its website.

How do I clean the View Anywhere display screen?

- To clean the View Anywhere display screen, wipe it with a soft cloth (like the one supplied). If needed, clean with any alcohol-based product recommended for use on anti-reflective glass. Other cleaning products may leave a residue. Don’t spray cleaners,

spray or pour any liquid, nor wipe any abrasive cleaner on the screen nor any surface of the unit. Don't use tissues or paper towels to clean the screen. They contain wood fibers and may scratch the surface.

Will scratches affect the performance of the display or digitizer?

- Our testing has not found appreciable loss of performance on a scratched display.

How sensitive is the screen to various elements?

- As with any computer or electronic device, you should protect the Tablet PC from liquids, dirt and sand, other contaminants, and extreme heat.

Why is the Tablet PC lacking USB and display adapter ports?

- The Tablet PC is designed to be easy to clean and disinfect, so ports and connectors are minimized.

Will any monitor, USB device, keyboard, or mouse work with the Tablet PC?

- If the device has a driver for Windows®, it will work with the Tablet PC. For a list of products that have been tested for Windows®, look for the Windows® Marketplace Tested Products page on the [Microsoft website](#).

How do I adjust the Tablet PC for left-handed use?

- From the Motion Dashboard (see [Using the Motion Dashboard](#) on page 18), tap **Pen and Tablet**, then **Tablet PC Settings**, then the **Other** tab. You can select left- or right-handed; this changes the location of the menus.

How can I stop the display screen from rotating automatically?

- From the navigation area, tap the Motion icon  then tap **Options** and clear **Automatic Display Rotation**.

What do I need to use the Tablet PC in another country?

- You will need a travel plug adapter, which you can find in airports and travel stores. You don't need to buy a voltage converter; the Motion AC adapter will automatically adjust to different voltages.

Where can I learn more about my C5t/F5t?

- To learn more about the C5t/F5t, check out our [training tutorials](#) and [knowledge base articles](#). Motion Computing also offers [corporate training classes](#).

Can I recycle my old computer?

- Yes. Motion Computing has a recycling program that allows free return of all Motion-branded products and non-Motion-branded electronics with the purchase of a similar Motion tablet for processing and disposal in an environmentally safe manner. For details, go to [Motion Computing recycling program](#).

Index

Numerics

- 802.11 Wi-Fi 10
- 802.11a/b/g
 - enabling 45
 - setting up 46
 - using 45

A

- AC power 9
- accessories 15, 60
- amber light 75
- amber lights 40
- ambient light sensor 30
- antenna, GPS 74
- audio
 - drivers 74
 - settings 19
 - troubleshooting 74
- automatic display rotation 20
 - enabling or disabling 30
- Automatic Updates 56

B

- battery
 - checking status 39, 75
 - gauge 5
 - health 20, 64
 - hot swapping 43
 - optimizing 44, 75
 - status light 40
 - swapping 43
 - tips 44
 - using 39–44
- battery gauge 9, 40
- battery gauge button 40
- BIOS
 - boot options 59
 - troubleshooting password 74
- blinking lights 40
- blinking power button 67

Bluetooth

- discovery 72
- enabling 48
- setting up 11, 48, 72
- tips 72
- troubleshooting 71
- using 48
- boot options 59
- buttons
 - about 28
 - configuring 29
 - functions 28

C

- C5t/F5t
 - specifications 1
- calibrating for touch 21
- calibrating the digitizer 21
- calibrating the pen 21
- camera
 - button 6
 - documentation 6, 7
 - web 6
- cameras 35
- care and maintenance
 - display 62
 - fingerprint reader 64
 - general care 61
 - pen 62
 - replacing pen tips 63
 - tablet pen 62
- checking battery status 39
- CL900
 - locating serial number 57
- cleaning
 - fingerprint reader 64
- cleaning the display 62
- Computrace® Complete 3
- conditioning the battery 64
- configuring
 - front panel buttons 29
- connecting
 - display monitor 14
 - docking station 14
- context-sensitive menu 20, 23
- Corning Gorilla glass 1

- credit card 21
- Ctrl+Alt+Del 6, 13
- customizing buttons 29

D

- Dashboard button
 - about 28
 - configuring 29
- desktop
 - Getting Started doc 17
 - introduction 17
- dictation mode 33
- digital ink 24
- digitizer
 - Motion Dashboard options 22
- digitizer pen
 - calibrating 21
- directional pad 5, 28
- Discrete GPS receiver with WAAS, EGNOS, and MSAS 47
- discrete GPS with WAAS, EGNOS, and MSAS 2
- display
 - automatic display rotation 20, 30, 76
 - care and cleaning 62
 - connecting external 14
 - Display Scheme 32
 - dynamic brightness fixed brightness 30
 - extended 31
 - fixed brightness 30
 - locking display orientation 30
 - mirror 31
 - orientation 76
 - resetting after returning the tablet to a docking station 33
 - rotating 30
 - scratch resistance 1
 - scratches 76
 - settings 29–33
 - touch with multiple 24, 32
 - troubleshooting 68–69
 - turning off automatic rotation 76
 - using 29
- Display Scheme 32
- disposing of used batteries 43
- docking connector 6
- docking input panel on the screen 26
- docking station 14
- double-tap 20, 22, 23

- downloads, free 60
- dynamic brightness 30

E

- enabling
 - 802.11a/b/g 45
 - Bluetooth 48
 - Wi-Fi 45
- End key 27
- eraser
 - use pen function button as 23
- Esc button
 - configuring 29
- extended display 31
- external display, using 30

F

- FAA wireless air travel requirement 65
- features
 - optional 2
- finding your tablet's 57
- fingerprint reader 49
 - about 49
 - tips 51
- five-way directional controller 5, 28
- flashing lights 40
- flicks 20, 22
- free downloads 60
- front panel buttons
 - about 28
 - configuring 29
- front panel light 40
- Function button
 - about 28
 - configuring 29

G

- gestures 22
 - enable multi-touch 22
- Getting Started 17
- Gorilla glass 1
- GPS antenna 74
- GPS receiver 2, 10
 - troubleshooting 73
- green lights 40

H

- handwriting recognition applications 27
- hard drive activity 20

- hibernate 13, 67
 - about 45
- Home key 27
- hot swapping battery 43

I

- indicator light 40
- inking 22, 24
- input mode 22
- input panel
 - docking 26
 - numbers pad 26
- input panel, docking or floating 26
- Insert key 27
- integrated microphones 33
- Internet Options 56

K

- keyboard 76
 - show special keys 27
- Knowledge Base 15
- knowledge base 76

L

- landscape mode 30
- LCD
 - View Anywhere 3
- left-handedness 19, 23, 26, 76
- locking
 - the tablet 13
- locking display orientation 30

M

- microphones 19, 33
 - using 33
- mirror display 31
- mobile broadband 10
- mobile broadband with GPS
 - troubleshooting 73
- mobile Broadband with GPS module 2, 46
- monitor only display 31
- monitors
 - touch 32
 - touch input 24
- monitors, using multiple 30
- Motion Computing Accessories 15, 60
- Motion Computing Store 15, 28
- Motion Computing Support 15, 66
- Motion Connection Manager 11, 73

- Motion Dashboard 17, 18, 20
 - opening 10, 18
 - using 18–28
- Motion Dashboard button 28
- Motion Optimized power plan 44
- Motion utilities 19
- moving taskbar location 17
- multi-touch gestures 22

N

- network profiles 47
 - definition 47
- notification area 19
- numbers pad 26

O

- OmniPass
 - about 49
- OmniPass™ application 49
- optimization
 - battery 44
 - power plan 44
- optional features 2, 3
 - Computrace® Complete 3
 - mobile broadband with GPS 2
 - security 2
 - TPM 2
 - View Anywhere display 3

P

- Page Down 28
- Page down key 27
- Page Up 28
- Page up key 27
- password replacement
 - about 52
 - using 52
- passwords and user accounts 56
- Pause key 27
- pen
 - calibrating 21
 - care and maintenance 62
 - disable function button 23
 - disabling pen input 22
 - taking care of 62
 - troubleshooting 69
 - use function button as eraser 23
- Pen & Input Devices 22
- portrait mode 30
- portrait orientation 30

- power adapter
 - port 6
- power button 45
 - blinking 67
- power plan
 - Motion Optimized 44
 - Power Saver 75
- Power Switch on battery or plugged in 45
- Print screen key 27

R

- recycle old computer 76
- removing the battery 41
- repairing Windows 59
- replacing pen tips 63
- replacing the battery 41
- right-click 20, 23
- rotating the display 30, 76

S

- scheme
 - display 32
- scratch resistance 1
- scratches 76
- screen. See display 76
- Scroll lock key 27
- security 2
- serial number 57
- setting up
 - 802.11a/b/g 46
 - Bluetooth 48, 72
 - docking station 14
 - external monitor 14
 - mobile broadband 10
 - strong logon security 52
 - the tablet PC 9
 - Wi-Fi 10, 46
- setting up users and passwords 56
- Shift+Tab 28
- Shut down 67
- shut down 45
- sleep 13
 - about 45
- software solutions 60
- spatial tolerance 23
- Speak Anywhere 33
- speaker 19, 74
- specifications 1
- speech recognition 33–35
 - setting up 34

- status light 5, 40
- strong logon security
 - about 52
 - enabling 52
- swapping batteries 43
- system image 14, 58

T

- Tab key 28
- Tablet & Pen Settings 29
- tablet only display 31
- tablet PC
 - accessories 15
 - desktop 17
 - managing with Motion Dashboard 18
 - optional features 2
 - shutting down 45
 - software 60
 - specifications 1
 - training tutorials 76
- Tablet PC input panel 26
- Tablet PC Tips & Tricks 15
- taskbar 10, 18
 - moving to left 17
- text
 - entering 24–27
- touch
 - and pen 22
 - calibrating 21
 - disabling touch input 22
 - gestures 22
 - on multiple displays 32
 - pointer, adjusting 22
 - pointer, show or hide 22
 - resetting after adding other monitors 32
 - setting spatial tolerance, speed, and duration 23
 - troubleshooting 69
 - using 20–23
 - using multiple monitors 24
- touchscreen display 6
 - caring for 62
- TPM 2
- training 15
- training classes
 - corporate 76
- training tutorials 76
- traveling with your tablet PC 65

- troubleshooting
 - audio 74
 - battery 68
 - display 68
 - input 69

U

- USB 2.0 port
 - troubleshooting 70
- USB port 6
- user accounts 56
- using
 - 802.11a/b/g 45
 - Bluetooth 48
 - external display 30
 - external monitors 30
 - microphones 33
 - Motion Dashboard 18–28
 - power plans 44
 - sleep mode 45
 - speech recognition 33
 - Wi-Fi 45

V

- View Anywhere display 3
- voice commands 33

W

- web camera 6
- Wi-Fi 10
 - enabling 45
 - setting up 46
 - using 45
- Windows
 - Advanced Boot Options 59
 - notification area 19, 30
 - repairing 59
 - Setup wizard 9
 - speech recognition 33
 - Windows.old directory 60
- Windows Firewall 56
- Windows Security Center
 - about 56
 - using 56
- wireless
 - setting up 802.11 Wi-Fi 10
 - setting up Bluetooth 11
 - setting up mobile broadband 10
- wireless network
 - setting up 10
 - troubleshooting 71–72
- wireless networking 10, 11
- WWLAN. See mobile broadband

Z

- zoom in and out 20