

AUDIOVOX[®]
DRIVEN BY DICE ELECTRONICS



iPhone | Internet Radio | Satellite

for selected Nissan/Infiniti vehicles

Installation Guide/User manual



Copyrights and Trademarks

Copyright 2012 Audiovox Electronics Corporation

The Audiovox and Audiovox Driven by DICE Electronics logos are trademarks of Audiovox Electronics Corporation

iPod and iPhone are trademarks of Apple, Inc.

All Trademarks and Logos are the property of their respective owners.

All rights reserved.

Printed in the U.S.A.

Table of Contents

Warning and safety	4	Text display fields	20
Product registration	5	Controlling the DUO iPod source	21
Silverline DUO kit contents.....	6	Repeat and random selection	22
DIP switch settings	7	Controlling the DUO SIRIUS source	23
Supported iPod models	8	Internet Radio App support	24
Note to Installer	9	Data connection requirements	24
Connection diagram	10	Controlling the Internet Radio App	25
Installation	11	Text display from the Internet Radio App.....	26
iPod content browsing	12	Terminating the Internet Radio App	27
Charging	12	Auxiliary audio source	28
iPod locked/unlocked settings and features	13	Optional Remote Kit: iPod/App.....	29
Preset configuration	14	Optional Remote Kit: SIRIUS	30
Basic operation	15	Troubleshooting	31
Operating the DUO in SAT emulation	16	Firmware update	34
		Warranty	35

Warning and safety!

Please read these instructions carefully before proceeding. Failure to follow instructions may result in improper operation or injury. Neither Audiovox Electronics Corporation nor Apple Inc., its regional offices, distributors or resellers take any responsibility for any damage or injury as a result of using the integration kit.

- Do not open, disassemble or alter the interface in any way.
- Do not insert anything into the casing.
- Do not cut or try to alter cables in any way and always use the correct connections.
- Only operate unit when stationary or ask passengers to operate it for you.
- Do not allow the Apple iPod/iPhone to distract you from driving.
- Exercise good judgement and keep your eyes on the road at all times.
- Do not expose unit to extreme temperatures, humidity or shock.
- Keep the unit and iPod/iPhone away from fluids.

- Keep away from children! - Interface components may contain small parts, can be broken or disassembled and components may become loose from vibration and heat. Small components and packaging materials may be a choking hazard when handled by children.



Congratulations on your purchase!

Thank you for purchasing this integration kit. Please review this booklet before operating the unit. This interface was designed and manufactured to seamlessly integrate with your vehicle's factory audio system.

Product registration

We recommend registering your Audiovox product so you can receive news about important firmware updates and have unlimited access to our online support system.

To register your Audiovox product, please complete the following steps:

1. Visit <http://www.audiovoxproducts.com>
2. Look up and save the serial number of the product.
3. Complete the product registration form.
4. Submit the form.
5. Save the registration sheet in a safe place for future reference.

If you are unable to complete the registration via internet, please call Audiovox at 1-800-645-4994.



Prior to installation make sure the module's firmware is up to date to ensure compatibility with the latest features and enhancements. Please refer to page 34 to update firmware.

Silverline DUO kit contents



Silverline DUO module



user manual

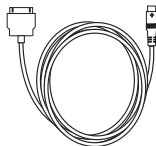

iPod docking
cable

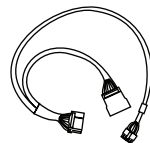

Vehicle Interface
Harness

Optional accessories (sold separately):



AUX connector

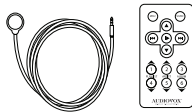

IR Receiver &
Remote controller

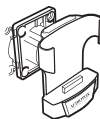

Cradle
(A-DCR-50-PTH)

For more accessories, visit www.audiovoxproducts.com

DIP switch settings

The following DIP switch settings are used to configure the Silverline DUO module to interface with the various vehicle radios. Before installation, set the DIP switch to the position shown for the corresponding radios.

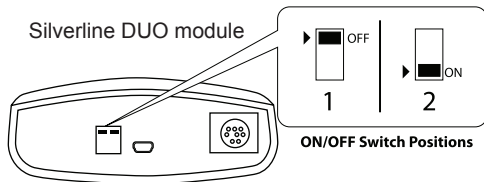

Car configuration switches	
Satellite (SAT)	Retain factory (SAT)
<p>OFF OFF</p>	<p>ON OFF</p>
Setting for SAT capable radios without factory SIRIUS/XM module installed.	Setting for SAT capable radios with factory SIRIUS/XM module installed. This setting retains the factory satellite module functionality (compatible harness and specific installation required)

Supported iPod models and firmware version requirements

Model	Firmware / OS Version
1G nano	1.3.1
iPod 5G	1.3
2G nano	1.1.3
iPod classic	1.1.2
3G nano	1.1.3
iPod touch	iOS 3.1.3
iPhone	iOS 3.1.3
iPhone 3G	iOS 4.2.1
4G nano	1.0.4
120 GB classic	2.0.1
2G touch	iOS 4.2.1
iPhone 3GS	iOS 5

Model	Firmware / OS Version
160 GB classic	2.0.4
5G nano	1.0.2
3G touch	iOS 5
iPhone 4	iOS 5
iPhone 4S	iOS 5
4G touch	iOS 5
6G nano	1.2

Attention installer! Please read the following!

Audiovox strongly recommends that the unit be installed in an easily accessible place!
DO NOT PLACE IT BEHIND THE RADIO AND DO NOT HIDE UNDER CARPET!

Whether the unit is professionally or self installed, put the module where you, the end user can get to it easily in the future. (Have the installer show you where the interface module is installed.)

Installing the module behind the radio will make it difficult to:

- Add possible future upgrades, changing software, adding new features, improving operation;
- Access the AUX input on the module to attach any audio device;
- Access the DIP switches located on the module;
- Remove the unit in case of failure.

MAKE SURE THAT THE MODULE IS IN AN ACCESSIBLE PLACE!

Connection diagram

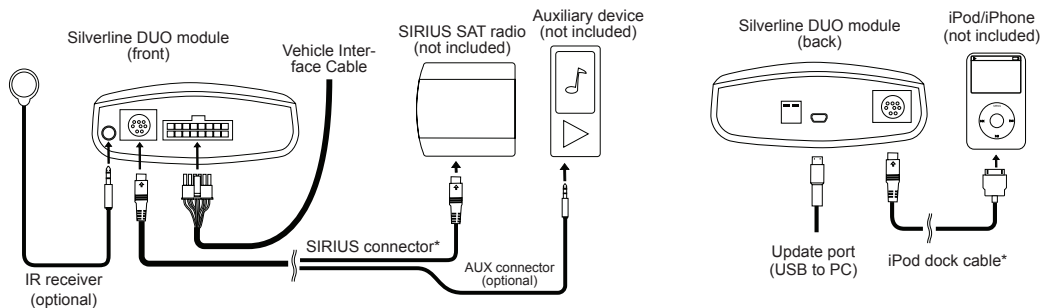

*Do not connect the iPod dock cable under any circumstance to the SIRIUS module connector! Improper connection can cause permanent damage to iPod/SIRIUS module.

Installation

1. Verify compatibility

2. Disconnect battery



3. Remove radio from car

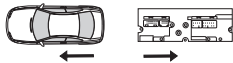

4. Install Silverline DUO cable



5. Route kit to glove box or other accessible location

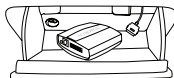

6. Connect battery & test

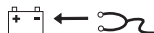

7. Complete install by re-installing radio

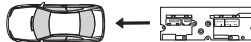

Some radios will enter an anti-theft security mode and will lock requiring the radio's security code to be entered to unlock it. This code can be requested from the vehicle's dealership.

iPod content browsing

By default, the interface creates a Playlist having a name that is the same as the name of the iPod. This Playlist is the very first on the list of Playlists shown while browsing in Playlist mode. This Playlist contains all the songs on the iPod. Once a Playlist is selected an Artist may be selected within that Playlist using the Artist Mode. Albums by the selected Artist within the selected Playlist may be selected in Album Mode. "ALL ARTIST" and "ALL ALBUM" designate all available content in those categories.



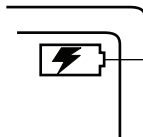

Charging

The interface automatically charges the battery of the iPod when connected and your vehicle ignition key is in the ACC/ON position.



Charging may be shown by an icon that appears on the upper right corner of the iPod screen. May vary by model.

iPod locked/unlocked settings and features

	iPod hold ON	iPod hold OFF
		
Radio control	✓	Limited
iPod control	×	✓
	Before connecting the iPod to the module, turn the hold switch ON to fully control and browse the songs from the wireless remote. The iPod is locked in this state.	Before connecting the iPod to the module, turn the hold switch OFF to fully control and browse the songs from iPod. Browsing capabilities are limited from the wireless remote.

Note: Setting the iPod's hold switch must be done prior to connecting it to the dock cable.
iPod nano 6th generation will always be in locked mode since it does not have a lock switch.





For iPod touch and iPhone, when the screen is not active (as shown on the left), the iPod/iPhone is locked (Press the power button to lock the iPhone/iPod Touch).

Preset Configuration



To enable full functionality of the DUO with your radio, step 1-3 must be perform.

1.  Means you have 3-banks of 6-PRESETS each (A, B and C). You must assign one bank for DUO operation.
2. Once a preset-bank (A,B or C) has been selected, tune the radio into "SAT" mode by pressing the  or  button.
3. Once the radio is in "SAT" mode, assign the functions to the presets 1-6 by pressing and holding each preset for 3-seconds (one preset at a time).

Note: the preset functions should be as follows for iPod:

1= SONG, 2= PLAYLISTS, 3= ARTISTS, 4= ALBUMS, 5= PODCASTS, 6= AUDIOBOOKS

Basic operation

Accessing the DUO as the audio source:

Much like the radio's AM/FM tuner, satellite radio or CD audio sources, the Silverline DUO is integrated to be part of the vehicle's audio system. To access the DUO source, press the SAT or RADIO button. Pressing this button repeatedly will cycle through sources present in the vehicle (SAT > DUO).

DUO source selection:

The DUO adds additional audio sources including iPod, SIRIUS Satellite Radio* and auxiliary audio input*. To cycle between these sources, use the SEEK, TRACK or TUNE buttons within the first 5 seconds of accessing the DUO as the audio source.

**These sources require additional parts/accessories/service from Audiovox and/or third parties and can only be selected if devices are connected.*

Silverline DUO Interface settings. Presets must be selected within 5 seconds of selecting the DUO as the audio source. After 5 seconds the Presets will activate the various browsing features.

Select DISC 1 to apply settings and resume audio playback.

Select DISC 3 to change default volume level; use track up/down to adjust between Min and Max.

Select DISC 4 to enable/disable scrolling text.

Select DISC 6 to view Silverline DUO serial number and firmware version.

DISC 2 and 5 have no settings available.

Operating the DUO in SAT emulation mode

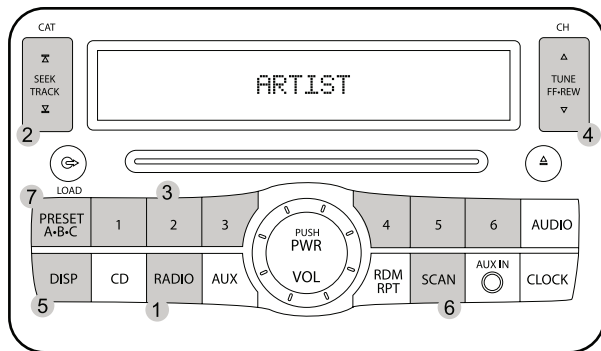

1. **Enter SAT mode** (Silverline DUO is accessible in SAT mode)
2. **iPod:** press to change browsing modes
SIRIUS: change categories
3. **iPod:** access PRESET modes 1-6
SIRIUS: access station PRESETS when listening to SIRIUS
4. **iPod:** Press for next item (song, playlist, etc...) **SIRIUS:** Next SIRIUS channel
5. Toggle between available text fields
6. **iPod:** Press to toggle shuffle and repeat
SIRIUS: Scan channels on/off
7. Switch PRESET banks (A/B/C)

Operating the DUO in SAT emulation mode

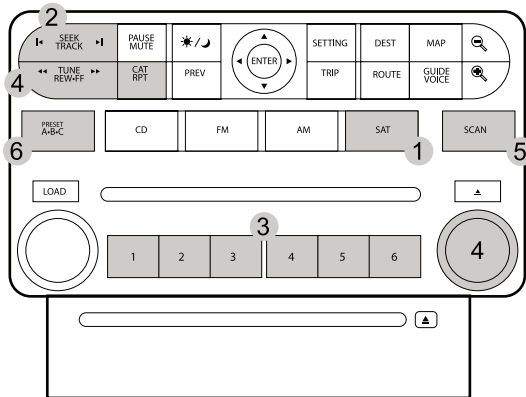

- 1. Enter SAT mode** (Silverline DUO is accessible in SAT mode)
- 2. iPod:** press to change browsing modes
SIRIUS: change categories
- 3. iPod:** access PRESET modes 1-6
SIRIUS: access station PRESETS when listening to SIRIUS
- 4. iPod:** Turn dial for next item (song, playlist, etc...) **SIRIUS:** Next SIRIUS channel
- 5. iPod:** Press to toggle shuffle and repeat
SIRIUS: Scan channels on/off
- 6. Switch PRESET banks (A/B/C)**

Operating the DUO in SAT emulation mode

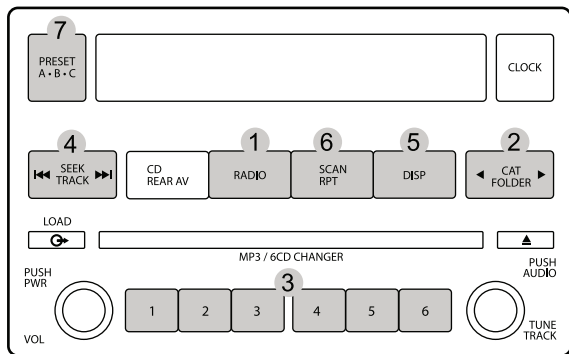

1. **Enter SAT mode** (Silverline DUO is accessible in SAT mode)
2. **iPod:** press to change browsing modes
SIRIUS: change categories
3. **iPod:** access PRESET modes 1-6
SIRIUS: access station PRESETS when listening to SIRIUS
4. **iPod:** Press for next item (song, playlist, etc...) **SIRIUS:** Next SIRIUS channel
5. Toggle between available text fields
6. **iPod:** Press to toggle shuffle and repeat
SIRIUS: Scan channels on/off
7. Switch PRESET banks (A/B/C)

Operating the DUO in SAT emulation mode

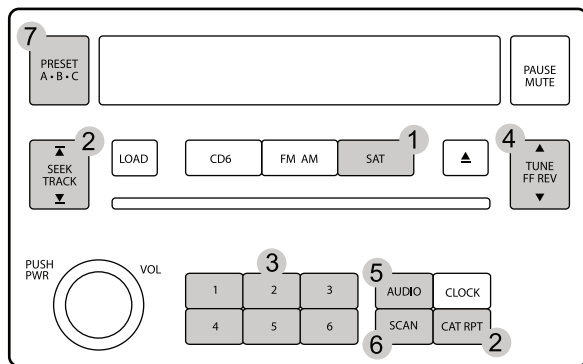

1. **Enter SAT mode** (Silverline DUO is accessible in SAT mode)
2. **iPod**: press to change browsing modes
SIRIUS: change categories
3. **iPod**: access PRESET modes 1-6
SIRIUS: access station PRESETS when listening to SIRIUS
4. **iPod**: Press for next item (song, playlist, etc...) **SIRIUS**: Next SIRIUS channel
5. Toggle between NAME, TITLE, BASS, MID, TREBLE, FADE, BALANCE, SSV, DISPLAY MODE, then press **4.** to select additional options
6. **iPod**: Press to toggle shuffle and repeat
SIRIUS: Scan channels on/off
7. Switch PRESET banks (A/B/C)

Text display fields - SAT emulation (non-NAV radios)

Press the DISP-MODE button to cycle through the available text fields. Note that the display will automatically toggle between the other text fields upon a channel change. Select the “-NAME-” text field to see the mode you are in and select the “-TITLE-” text field to view what is playing. In PRESET 1 you will always see the album and artist information of your selection in the “-NAME-” text field and the song name in the “-TITLE-” text field. The “-Channel name-” and the “-Category name-” fields are fixed.

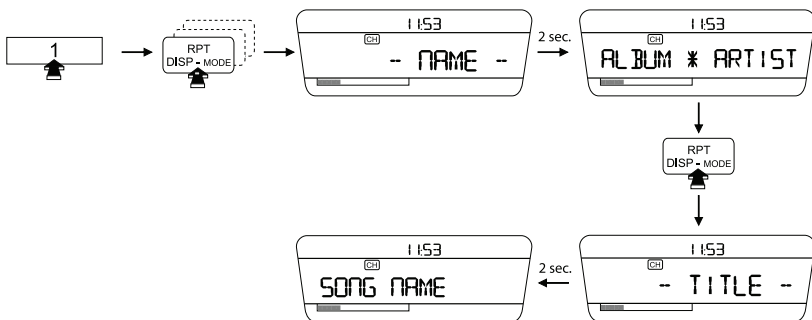

Controlling the DUO iPod source

The Silverline DUO features content browsing making it easy to find by song, playlist, artist, podcast and audiobook. After connecting the iPod, select the desired browsing mode by selecting the appropriate DISC. Press the SEEK button or turn the TUNE dial repeatedly to browse contents; 1 second after releasing the button, your selection is executed.

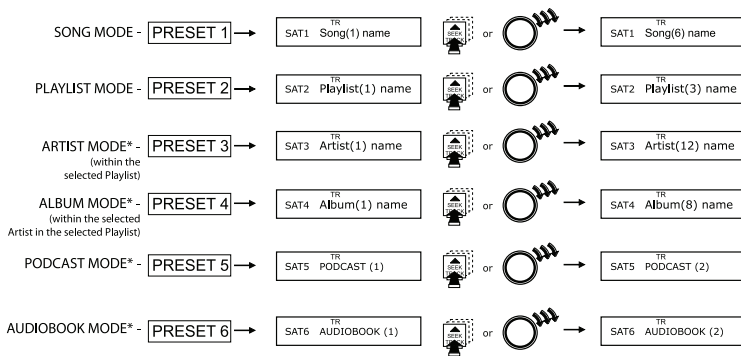

*Only available when iPod is locked. When iPod is unlocked the radio will only display song titles.

Repeat and random (shuffle) selection

The Silverline DUO features shuffle & repeat selection. Enter the shuffle & repeat selection menu by pressing the SCAN button, then press TRACK UP to cycle through the shuffle options and TRACK DOWN for repeat options. After selection, press SCAN again to exit the shuffle & repeat selection menu.

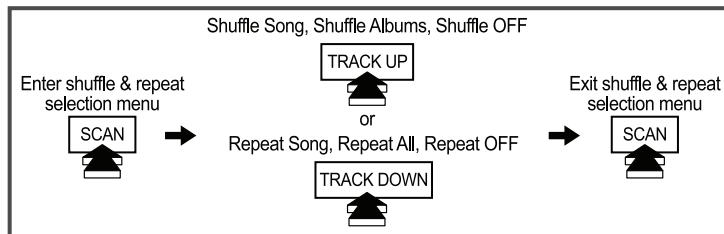

Controlling the DUO SIRIUS source (only available for SAT emulation)

The Silverline DUO integration kit features SIRIUS connectivity. Use the SEEK button or TUNE dial to browse between subscribed channels.

To store a subscribed channel to memory:

Tune to the station to be stored, **press and hold** the desired PRESET buttons to save.

To recall a memorized channel: Simply press the desired PRESET button (PRESET 1-6).

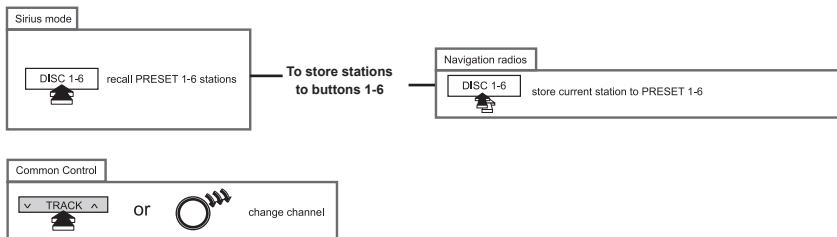

NOTES: If a SIRIUS CONNECT compatible tuner is not detected, then a "No Tuner" vehicle message is displayed.

Go to Channel 000 to view the SIRIUS Tuner ID for activation. The 12 digit SID display format is shown in two parts as SID "123456-" followed by "-789ABC".

Internet Radio Application support (iPhone/iPod touch)

This kit includes support for internet radio streaming apps available on the iTunes® Store. Thousands of stations can be streamed through data connections. Supported apps include Livio Car Internet Radio, Pandora, iHeart Radio and more. Supported features such as text display on screen, and next/previous track functions will vary by app.

To learn more about each app specifically, please visit the website for the app you need information about.



Data connection requirements (3G/4G/WiFi)

Users must have an active wireless data connection in order to stream music from an app while in the car. Data connections including "3G" or "4G" through wireless carriers, or a third party wireless Internet access point connected to your mobile device through WiFi will work. Because this app requires a data connection, it will only work on connected devices such as the iPhone and iPod touch.

Controlling Internet Radio Apps

NOTE: The following features may not be supported by all apps. For demonstration purposes the following examples will show the features for the Livio Car Internet Radio app.

The app must be active on the screen of the device. To do so, simply tap the app's icon and it will load.

Next/previous TRACK buttons execute application specific features such as skipping stream or cycling between station presets. **DISC/PRESET (1-6) buttons** are associated with station presets when used with the Livio Car Internet Radio application.

iPhone operating system iOS5 enabled application developers to share the "now playing" screen information. For example, when using the Pandora App, you will see artist, album and song information on the radio's screen. When using an application that doesn't implement this feature, or running iOS4, only the name of the application will be shown.

Please note that although iOS 4 (4.2.1) is supported on iPhone 3G and iPod Touch 2nd generation, applications do not run in the background. As such, loading the app takes longer than on devices where the app is present in the background.



If your listening experience is interrupted by a call, under most conditions, the app will resume playback at the end of the call.

Music playback apps running on your iPhone are sent to background automatically when the home button of the phone is pressed, but the music playback itself is not stopped.

To resume playback of your iPod music library, stop Livio playback by tapping on the screen below the Livio Radio logo. An icon representing “stop” will show on the main Livio screen. Press the home button to send the application to the background. (Other apps may need to be terminated manually. Please see next page.)

A few seconds after this, the iPod music playback application will reinitialize itself and become active again if the iPod was locked when it was connected to the kit. (This is indicated by an Accessory Connected message being shown when the iPod icon is tapped.)

If the iPod was in unlocked state when it was connected to the kit, press the play button on the iPod application.

Text display from the Internet Radio App

Text that scrolls across the radio’s screen is associated with the stream shown on the radio and displays current song or station information. Stream must be playing before information on the display is updated.

Terminate (kill) the App

If you need to terminate (kill) the app please follow the steps below:

1. Double-tap on the home button of the iPhone to bring up the list of running apps. If you don't see the app's icon right away, swipe the screen left or right to locate it. Note: If you do not see such task bar but rather a music control popup then you have an iOS device that does not support background run of apps, therefore this section is not applicable to you.
2. Press and hold the icon of the app until a red minus icon shows.
3. Tap the red minus icon shown on top of the app.
4. This will close the app.
5. In a few seconds, the iPod music playback app should reinitialize itself and become active again. This can be verified by going back to the list of running apps and swiping the screen until the music control section is shown. The iPod app icon next to the music control sections shows that iPod is your audio source.

Internet Radio App Settings

Many radio stations offer lower bitrates. Selecting streams with a lower bitrate will reduce data usage and may reduce stream interruptions during the drive. For example with the Livio Car Internet Radio app, to adjust bitrates manually, users can: Go to the Setting menu of the device, select the Livio Radio settings the change the Maximum Bitrate Filter and set it to 64K. Other settings such as Buffer time and Reliability filter may also help in getting a more stable connection.

Auxiliary audio source (only with optional AUX connector)

The DUO AUX cable (A-ACC-106-AUX) can be used to connect an auxiliary device, such as an MP3 player, DVD player or other audio source.

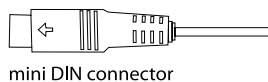
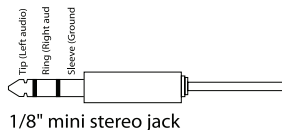
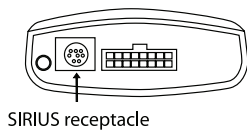

The auxiliary audio source can be accessed in both CDC and SAT emulation modes.

To access AUX audio source:

- Plug the mini DIN connector of the AUX adapter cable into the SIRIUS receptacle and connect the 1/8" mini stereo jack to the sound output of your audio device.
- Enter AUX mode (see pg. 15).
- All music playback is controlled through your audio device.

Optional Remote Kit: Functions for iPod/App

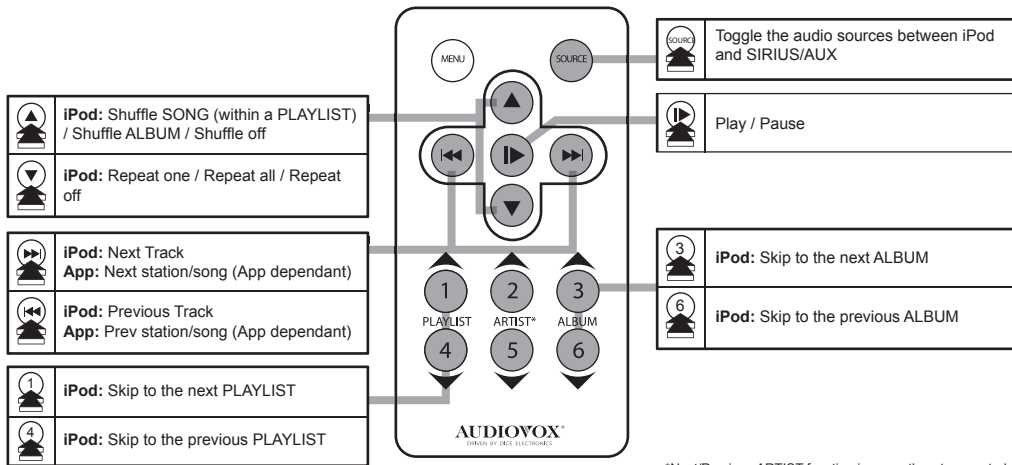

*Next/Previous ARTIST function is currently not supported.

Optional Remote Kit: Functions for SIRIUS

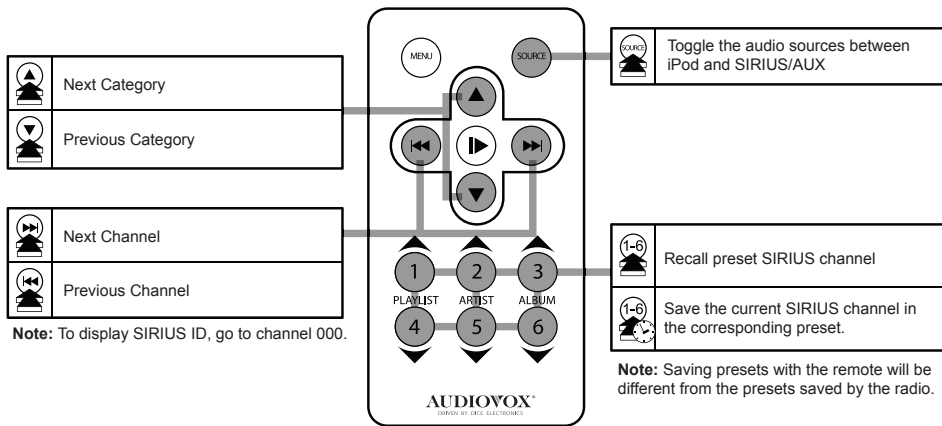

Troubleshooting

Problem	Solution
Radio/NAV display only shows DISC and track number and there is no iPod control.	Make sure DIP switch settings are correctly set for text display (refer to page 8 for DIP switch settings).
No text display on radio.	Make sure DIP switch settings are correctly set for text display (refer to page 8 for DIP switch settings).
Radio/steering wheel controls do not operate iPod.	Reset iPod and make sure most recent iPod firmware is installed.
Music is distorted or sound level is too low with iPod connected.	Make sure all EQ and BASS boost options are turned off on your iPod. Adjustments to the gain setting may be required (refer to page 19).
No audio from iPod source.	Reset the iPod. Verify proper connection to iPod/interface. Check for compatibility. Older iPod models don't support USB audio.

Problem	Solution
Sirius tuner can't be selected.	Ensure the cable connecting SIRIUS tuner is securely connected to the correct receptacle.
Why does the radio display show "EMPTY/STOP" and no music plays?	The iPod has reached the end of a playlist. Please select a new Playlist.
Cannot select the interface.	Verify that the correct button is used to access the interface (RADIO/SAT).
Radio/ steering wheel controls do not operate iPod.	Reset iPod and make sure the most recent iPod firmware is installed. Check vehicle user manual on how steering wheel controls work, long presses may toggle alternate function.
Why does category read "PRESELCTD"?	Playback of content selected on the iPod before it is connected to the interface continues until new content is selected.

Problem	Solution
Why does the message “iPod UNLOCKED” display on screen?	When the Silverline DUO is playing iPod music in UNLOCKED mode, browsing mode information isn't available so the “iPod UNLOCKED” notification is shown. To view information associated with browsing modes, ensure the iPod's hold button is set before connecting it to Silverline DUO.
The radio displays channel 99 (“CH99”). Track up/down controls do not work.	Track 99 indicates that the Silverline DUO is in auxiliary audio (AUX) mode. See page 15 on how to enter/exit this mode.

Updating Firmware (Mac OS illustrated)



Connect module via mini USB



Device specifications and update selection

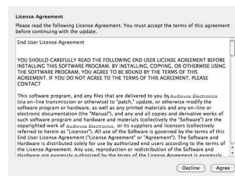

License Agreement (click Agree to proceed)

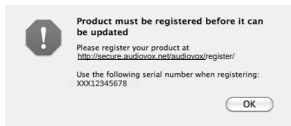

Product registration notification

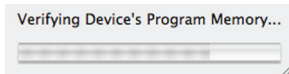

Firmware update progress

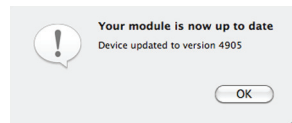

Module updated successfully!

The above screen shots are for illustration purposes only.



AUDIOVOX

12 MONTH LIMITED WARRANTY

AUDIOVOX ELECTRONICS CORP. (the Company) warrants to the original retail purchaser of this product that should this product or any part thereof, under normal use and conditions, be proven defective in material or workmanship within 12 months from the date of original purchase, such defect(s) will be repaired or replaced with reconditioned product (at the Company's option) without charge for parts and repair labor. A game controller, if supplied, is similarly warranted for ninety (90) days.

To obtain repair or replacement within the terms of this Warranty, the product is to be delivered with proof of warranty coverage (e.g. dated bill of sale), specification of defect(s), transportation prepaid, to the Company at the address shown below.

This Warranty does not extend to the elimination of externally generated static or noise, to correction of antenna problems, to costs incurred for installation, removal or reinstallation of the product, or to damage to digital memory/media devices, gaming devices, discs, speakers, accessories, or vehicle electrical systems.

This Warranty does not apply to any product or part thereof which, in the opinion of the Company, has suffered or been damaged through alteration, improper installation, mishandling, misuse, neglect, accident, or by removal or defacement of the factory serial number/bar code label(s). THE EXTENT OF THE COMPANY'S LIABILITY UNDER THIS WARRANTY IS LIMITED TO THE REPAIR OR REPLACEMENT PROVIDED ABOVE AND, IN NO EVENT, SHALL THE COMPANY'S LIABILITY EXCEED THE PURCHASE PRICE PAID BY PURCHASER FOR THE PRODUCT.

This Warranty is in lieu of all other express warranties or liabilities. ANY IMPLIED WARRANTIES, INCLUDING ANY IMPLIED WARRANTY OF MERCHANTABILITY, SHALL BE LIMITED TO THE DURATION OF THIS WRITTEN WARRANTY. ANY ACTION FOR BREACH OF ANY WARRANTY HEREUNDER INCLUDING ANY IMPLIED WARRANTY OF MERCHANTABILITY MUST BE BROUGHT WITHIN A PERIOD OF 24 MONTHS FROM DATE OF ORIGINAL PURCHASE. IN NO CASE SHALL THE COMPANY BE LIABLE FOR ANY CONSEQUENTIAL OR INCIDENTAL DAMAGES FOR BREACH OF THIS OR ANY OTHER WARRANTY. No person or representative is authorized to assume for the Company any liability other than expressed herein in connection with the sale of this product.

Some states do not allow limitations on how long an implied warranty lasts or the exclusion or limitation of incidental or consequential damage so the above limitations or exclusions may not apply to you. This Warranty gives you specific legal rights and you may also have other rights which vary from state to state.

Audiovox Electronics Corporation, 150 Marcus Blvd., Hauppauge, New York 11788 • 1-800-645-4994

128-9032

Installation notes:

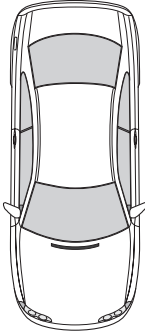
Installed by:	Illustration: 
Installed date:	
Other notes:	

Nissan/Infiniti compatible integration
for iPod/iPhone, Internet Radio, SIRIUS and AUX.
www.audiovoxproducts.com

OMA-DUO-100-NIS-012012



For Customer Service
Visit Our Website At
www.audiovoxproducts.com
Product Information, Photos,
FAQ's, Owner's Manuals



AUDIOVOX
ELECTRONICS CORP.

150 Marcus Blvd., Hauppauge, New York 11788
©2012 Made in China • Fabriqué en Chine • Hecho en China



SAVE ENVIRONMENT
PLEASE RECYCLE
ÉCONOMISER L'ENVIRONNEMENT
RECYCLEZ S'IL VOUS PLÂT
EXCEPTO EL AMBIENTE
RECYCLE FOR FAVOR