



Maintenance & Service Guide

HP Pro 3400 Microtower Business PC

HP Pro 3405 Microtower Business PC

HP Pro 3410 Microtower Business PC

HP Pro 3410 Small Form Factor Business PC

© Copyright 2011 Hewlett-Packard Development Company, L.P. The information contained herein is subject to change without notice.

Microsoft and Windows are trademarks of Microsoft Corporation in the U.S. and other countries.

The only warranties for HP products and services are set forth in the express warranty statements accompanying such products and services. Nothing herein should be construed as constituting an additional warranty. HP shall not be liable for technical or editorial errors or omissions contained herein.

This document contains proprietary information that is protected by copyright. No part of this document may be photocopied, reproduced, or translated to another language without the prior written consent of Hewlett-Packard Company.

Maintenance & Service Guide

HP Pro 3400 Microtower Business PC

HP Pro 3405 Microtower Business PC

HP Pro 3410 Microtower Business PC

HP Pro 3410 Small Form Factor Business PC

First Edition (September 2011)

Document Part Number: 670580-001

About This Book

 **WARNING!** Text set off in this manner indicates that failure to follow directions could result in bodily harm or loss of life.

 **CAUTION:** Text set off in this manner indicates that failure to follow directions could result in damage to equipment or loss of information.

 **NOTE:** Text set off in this manner provides important supplemental information.

Table of contents

1 Product Features	1
Feature Overview	1
Microtower Components	3
Small Form Factor Components	4
2 Installing and Customizing the Software	5
Installing the Operating System	5
Downloading Microsoft Windows Updates	5
Installing or Upgrading Device Drivers (Windows systems)	6
Accessing Disk Image (ISO) Files	6
Protecting the Software	6
3 Computer Setup (F10) Utility	7
Computer Setup (F10) Utilities	7
Using Computer Setup (F10) Utilities	8
Computer Setup—File	9
Computer Setup—Storage	10
Computer Setup—Security	12
Computer Setup—Power	15
Computer Setup—Advanced	16
Recovering the Configuration Settings	17
4 Illustrated parts catalog	18
Microtower Chassis Spare Parts	18
Computer Major Components	18
Cables	21
Misc Parts	22
Drives	23
Misc Boards	23
Sequential Part Number Listing	24
Small Form Factor (SFF) Chassis Spare Parts	26

Computer major components	26
Cables	28
Misc Parts	29
Drives	30
Misc Boards	30
Sequential Part Number Listing	30
5 Serial ATA (SATA) Drive Guidelines and Features	33
SATA Hard Drives	33
SATA Hard Drive Cables	33
SATA Data Cable	33
SMART ATA Drives	34
Hard Drive Capacities	34
6 Routine Care and Disassembly Preparation	35
Electrostatic Discharge Information	35
Generating Static	35
Preventing Electrostatic Damage to Equipment	36
Personal Grounding Methods and Equipment	36
Grounding the Work Area	37
Recommended Materials and Equipment	37
Operating Guidelines	38
Routine Care	38
General Cleaning Safety Precautions	38
Cleaning the Computer Case	38
Cleaning the Keyboard	39
Cleaning the Monitor	39
Cleaning the Mouse	40
Service Considerations	40
Power Supply Fan	40
Tools and Software Requirements	40
Screws	40
Cables and Connectors	41
Hard Drives	41
Lithium Coin Cell Battery	41
7 Removal and Replacement Procedures – Microtower Chassis	42
Serviceability Features	42
Preparation for Disassembly	42
Access Panel	43

Front Bezel	44
Memory	45
DDR3-SDRAM DIMMs	45
Populating DIMM Sockets	46
Removing Memory Modules	47
Expansion Cards	49
Cable Management	55
Cable Connections	56
Drives	57
Installing Additional Drives	58
System Board Drive Connections	59
Removing an Optical Drive	61
Removing a Hard Drive	61
Front I/O and USB Panel Housing Assembly	63
Power Switch/LED Assembly	66
System Fan	68
Fan Sink Assembly	70
Processor	71
Power Supply	75
System Board	76
Battery	77

8 Removal and Replacement Procedures – Small Form Factor (SFF) Chassis 79

Preparation for Disassembly	79
Access Panel	80
Front Bezel	82
Memory	83
DDR3-SDRAM DIMMs	83
Populating DIMM Sockets	84
Removing DIMMs	85
Expansion Card	88
Cable Management	92
Cable Connections	93
Drives	94
Drive Positions	94
Removing Drives	95
Removing an Optical Drive	95
Removing the Hard Drive	97
Power Switch	101
Front USB Assembly	103
Fan Assembly	106

Fan Sink	108
Processor	110
Power Supply	112
System Board	114
Battery	116
Appendix A Connector Pin Assignments	118
Ethernet BNC	118
USB	118
Microphone	118
Headphone	119
Line-in Audio	119
Line-out Audio	119
4-Pin Power (for CPU)	119
Monitor	120
Serial Interface, Powered and Non-Powered	120
DVI Connector	121
24-Pin Power	122
PCI Express	123
PCI Express	124
Appendix B Power Cord Set Requirements	125
General Requirements	125
Japanese Power Cord Requirements	125
Country-Specific Requirements	126
Appendix C POST Error Messages	127
POST Numeric Codes and Text Messages	128
Interpreting POST Diagnostic Front Panel LEDs and Audible Codes	136
Appendix D Troubleshooting Without Diagnostics	140
Safety and Comfort	140
Before You Call for Technical Support	140
Helpful Hints	141
Solving General Problems	143
Solving Power Problems	146
Solving Diskette Problems	147
Solving Hard Drive Problems	149
Solving Media Card Reader Problems	152
Solving Display Problems	153

Solving Audio Problems	158
Solving Printer Problems	160
Solving Keyboard and Mouse Problems	161
Solving Hardware Installation Problems	163
Solving Network Problems	165
Solving Memory Problems	167
Solving Processor Problems	169
Solving CD-ROM and DVD Problems	169
Solving USB Flash Drive Problems	171
Solving Front Panel Component Problems	172
Solving Internet Access Problems	173
Solving Software Problems	175
Contacting Customer Support	176
Appendix E Password Security and Resetting CMOS	177
Resetting the Password Jumper	178
Clearing and Resetting the CMOS	178
Appendix F Backup and Recovery	180
Windows 7 – Backup and Recovery	180
Backing Up Your Information	180
Performing a Recovery	182
Using the Windows Recovery Tools	182
Using F11	183
Using a Windows 7 Operating System DVD (purchased separately)	183
Appendix G Specifications	185
MT Specifications	185
SFF Specifications	186
Index	187

1 Product Features

Feature Overview

The HP Pro 3400 series includes the following features:

- Choice of Intel® (HP Pro 3400 and HP Pro 3410) or AMD processor (HP Pro 3405)
- Choice of integrated graphics or ATI or NVIDIA graphics cards
- Up to 8 GB DDR3 SDRAM system memory available standard (depending on model)
- Hard drives:

Model 3400/3405

3.5-inch, 5400 rpm, 3.0 Gb/s hard drive (1.5 TB/2.0 TB)

3.5-inch, 7200 rpm, 3.0 Gb/s hard drive (250 GB/320 GB/500 GB/750 GB/1 TB/1.5 TB)

3.5-inch, 7200 rpm, 6.0 Gb/s hard drive (250 GB/320 GB/500 GB/750 GB/1 TB)

Model 3410

3.5-inch, 7200 rpm, 3.0 Gb/s hard drive (500 GB/750 GB/1 TB/1.5 TB)

3.5-inch, 7200 rpm, 6.0 Gb/s hard drive

- Optical drives:

Model 3400

SuperMulti DVD drive

DVD-ROM drive

Model 3405

SuperMulti LightScribe drive

SuperMulti DVD drive

DVD-ROM drive

Model 3410

SuperMulti LightScribe drive

SuperMulti DVD drive

- Integrated Realtek RTL8171E Gigabit Ethernet Controller (HP 3400 Pro only) or Integrated Realtek RTL8111E PCI-E Gigabit Ethernet Controller (HP 3405 Pro only) and Integrated Realtek RTL8111EL PCI-E Gigabit Ethernet Controller (HP 3410 Pro only)
- 10 USB 2.0 ports on HP Pro 3400 (5 on board header (including 2 on Front I/O, 4 rear, 1 mini card)
- 13 USB 2.0 ports on HP Pro 3405 (4 dual on board header (including 2 on Front I/O, 4 rear, 1 mini card)
- 10 USB 2.0 ports on HP Pro 3410 (5 on board header (including 2 on Front I/O, 4 rear)
- Video ports:
 - Model 3400**
 - DVI
 - VGA
 - Model 3405**
 - DVI-I
 - DVI-D
 - Model 3410**
 - VGA
 - HDMI
- HP Wireless NIC 802.11b/g/n Mini Card (1x1) (optional for HP Pro 3400 and HP Pro 3405 only)
- 5.1 channel audio (HP Pro 3400 and 3410); 7.1 channel audio (HP Pro 3405)
- Genuine Windows 7 versions, FreeDOS, or RedFlag Linux

Microtower Components

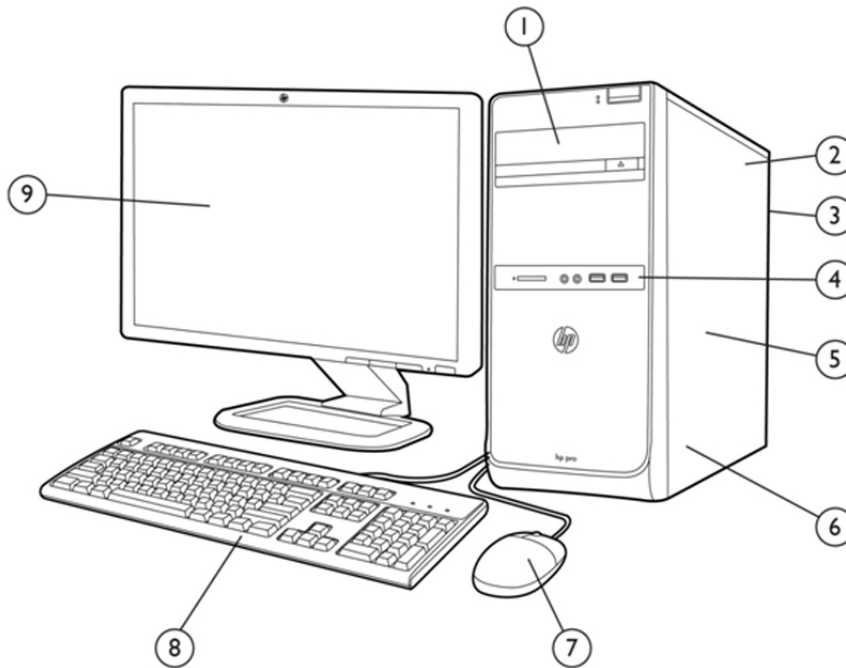

Table 1-1 Microtower Components

1	(1) external 5.25" drive bay for optional optical drive	6	Model 3400/3405: (3) PCIe x1 slots, (1) PCIe x16 slot, (1) miniPCI slot* ¹ Model 3410: (1) PCIe x1 slot, (1) PCIe x16 slot, (2) PCI 2.2 slots
2	Power Supply	7	USB Scroll Mouse
3	Rear I/O includes: (4) USB 2.0 ports, RJ-45 network interface, DVI and VGA video interfaces, microphone jack, audio in/out jacks (5.1 channel audio out)	8	HP USB Standard Value Keyboard
4	Front I/O includes: (2) USB 2.0 ports, dedicated headphone output, microphone jack	9	Display (sold separately)
5	(1) internal 3.5" hard drive bays		

¹ HP Pro 3400 and HP Pro 3405 only, HP Pro 3410 has no mini PCI slot

Small Form Factor Components

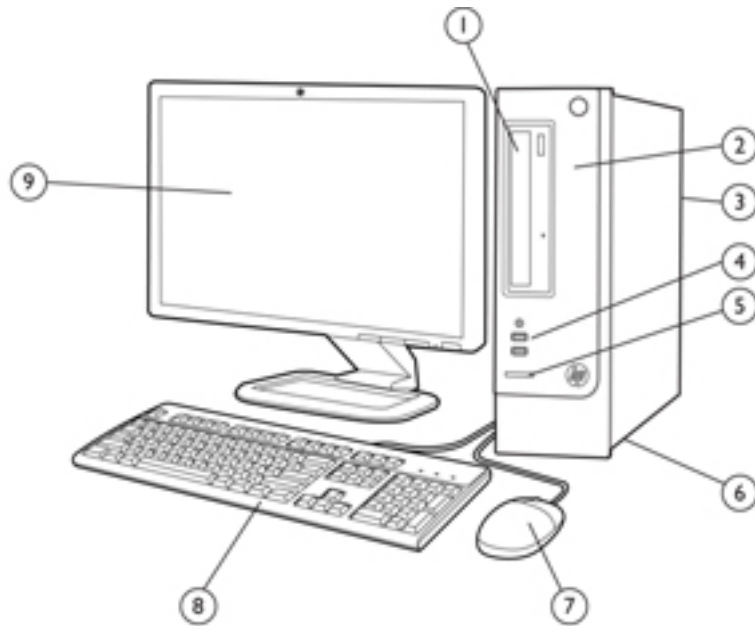



Table 1-2 Microtower Components

1	External 5.25" drive bay for optical drive	6	Power Supply
2	Internal 3.5" hard drive bay	7	USB Scroll Mouse
3	Rear I/O includes: (3) PCIe x1 slots, (1) PCIe x16 slot, (1) miniPCI slot, (4) USB 2.0 ports, RJ-45 network interface, DVI and VGA video interfaces, microphone jack, audio in/out jacks (5.1 channel audio out)	8	HP USB Standard Value Keyboard
4	Front I/O includes: (2) USB 2.0 ports, dedicated headphone output	9	Monitor (sold separately)
5	HP 6-in-1 Media Card Reader (some models)		

2 Installing and Customizing the Software

If your computer was not shipped with a Microsoft operating system, some portions of this documentation do not apply. Additional information is available in online help after you install the operating system.

 **NOTE:** If the computer was shipped with Windows 7 loaded, you will be prompted to register the computer with HP Total Care before installing the operating system. You will see a brief movie followed by an online registration form. Fill out the form, click the **Begin** button, and follow the instructions on the screen.

 **CAUTION:** Do not add optional hardware or third-party devices to the computer until the operating system is successfully installed. Doing so may cause errors and prevent the operating system from installing properly.

 **NOTE:** Be sure there is a 10.2-cm (4-inch) clearance at the back of the unit and above the monitor to permit the required airflow.

Installing the Operating System

The first time you turn on the computer, the operating system is installed automatically. This process takes about 5 to 10 minutes, depending on which operating system is being installed. Carefully read and follow the instructions on the screen to complete the installation.

 **CAUTION:** Once the automatic installation has begun, **DO NOT TURN OFF THE COMPUTER UNTIL THE PROCESS IS COMPLETE.** Turning off the computer during the installation process may damage the software that runs the computer or prevent its proper installation.

 **NOTE:** If the computer shipped with more than one operating system language on the hard drive, the installation process could take up to 60 minutes.

If your computer was not shipped with a Microsoft operating system, some portions of this documentation do not apply. Additional information is available in online help after you install the operating system.

Downloading Microsoft Windows Updates

1. To set up your Internet connection, click **Start > Internet Explorer** and follow the instructions on the screen.
2. Once an Internet connection has been established, click the **Start** button.

3. Select the **All Programs** menu.
4. Click on the **Windows Update** link.

The **Windows Update** screen appears. Click **view available updates** and make sure all critical updates are selected. Click the **Install** button and follow the instructions on the screen.

It is recommended that you install all of the critical updates and service packs.

5. After the updates have been installed, Windows will prompt you to reboot the machine. Be sure to save any files or documents that you may have open before rebooting. Then select **Yes** to reboot the machine.

Installing or Upgrading Device Drivers (Windows systems)

When installing optional hardware devices after the operating system installation is complete, you must also install the drivers for each of the devices.

If prompted for the i386 directory, replace the path specification with `C:\i386`, or use the **Browse** button in the dialog box to locate the i386 folder. This action points the operating system to the appropriate drivers.

Obtain the latest support software, including support software for the operating system from <http://www.hp.com/support>. Select your country and language, select **Download drivers and software (and firmware)**, enter the model number of the computer, and press **Enter**.

Accessing Disk Image (ISO) Files

There are disk image files (ISO files) included on your PC that contain the installation software for additional software. These CD image files are located in the folder `C:\SWSetup\ISOs`. Each .iso file can be burned to CD media to create an installation CD. It is recommended that these disks be created and the software installed in order to get the most from your PC. The software and image file names are:

- Corel WinDVD SD and BD – installation software for WinDVD – used to play DVD movies
- HP Insight Diagnostics OR Vision Diagnostics – software to perform diagnostic activities on your PC

Protecting the Software

To protect the software from loss or damage, keep a backup copy of all system software, applications, and related files stored on the hard drive. Refer to the operating system or backup utility documentation for instructions on making backup copies of your data files.

3 Computer Setup (F10) Utility

Computer Setup (F10) Utilities

Use Computer Setup (F10) Utility to do the following:

- Change factory default settings.
- Set the system date and time.
- Set, view, change, or verify the system configuration, including settings for processor, graphics, memory, audio, storage, communications, and input devices.
- Modify the boot order of bootable devices such as hard drives, optical drives, or USB flash media devices.
- Enable Quick Boot, which is faster than Full Boot but does not run all of the diagnostic tests run during a Full Boot. You can set the system to:
 - always Quick Boot (default);
 - periodically Full Boot (from every 1 to 30 days); or
 - always Full Boot.
- Select Post Messages Enabled or Disabled to change the display status of Power-On Self-Test (POST) messages. Post Messages Disabled suppresses most POST messages, such as memory count, product name, and other non-error text messages. If a POST error occurs, the error is displayed regardless of the mode selected. To manually switch to Post Messages Enabled during POST, press any key (except **F1** through **F12**).
- Establish an Ownership Tag, the text of which is displayed each time the system is turned on or restarted.
- Enter the Asset Tag or property identification number assigned by the company to this computer.
- Enable the power-on password prompt during system restarts (warm boots) as well as during power-on.
- Establish a setup password that controls access to the Computer Setup (F10) Utility and the settings described in this section.
- Secure integrated I/O functionality, including the serial, USB, or parallel ports, audio, or embedded NIC, so that they cannot be used until they are unsecured.
- Enable or disable removable media boot ability.

- Solve system configuration errors detected but not automatically fixed during the Power-On Self-Test (POST).
- Replicate the system setup by saving system configuration information on a USB device and restoring it on one or more computers.
- Execute self-tests on a specified ATA hard drive (when supported by drive).
- Enable or disable DriveLock security (when supported by drive).

Using Computer Setup (F10) Utilities

Computer Setup can be accessed only by turning the computer on or restarting the system. To access the Computer Setup Utilities menu, complete the following steps:

1. Turn on or restart the computer. If you are in Microsoft Windows, click **Start > Shut Down > Restart**.
2. Press either **Esc** or **F10** while the “Press the ESC key for Startup Menu” message is displayed at the bottom of the screen.

Pressing **Esc** displays a menu that allows you to access different options available at startup.

 **NOTE:** If you do not press **Esc** or **F10** at the appropriate time, you must restart the computer and again press **Esc** or **F10** when the monitor light turns green to access the utility.

3. If you pressed **Esc**, press **F10** to enter Computer Setup.
4. A choice of five headings appears in the Computer Setup Utilities menu: File, Storage, Security, Power, and Advanced.
5. Use the arrow (left and right) keys to select the appropriate heading. Use the arrow (up and down) keys to select the option you want, then press **Enter**. To return to the Computer Setup Utilities menu, press **Esc**.
6. To apply and save changes, select **File > Save Changes and Exit**.
 - If you have made changes that you do not want applied, select **Ignore Changes and Exit**.
 - To reset to factory settings or previously saved default settings (some models), select **Apply Defaults and Exit**. This option will restore the original factory system defaults.

 **CAUTION:** Do NOT turn the computer power OFF while the BIOS is saving the Computer Setup (F10) changes because the CMOS could become corrupted. It is safe to turn off the computer only after exiting the F10 Setup screen.

Table 3-1 Computer Setup (F10) Utility

Heading	Table
File	Computer Setup—File on page 9
Storage	Computer Setup—Storage on page 10
Security	Computer Setup—Security on page 12
Power	Computer Setup—Power on page 15
Advanced	Computer Setup—Advanced on page 16

Computer Setup—File



NOTE: Support for specific Computer Setup options may vary depending on the hardware configuration.

Table 3-2 Computer Setup—File

Option	Description
System Information	Lists: <ul style="list-style-type: none">• Product name• SKU number (some models)• Processor type/speed/stepping• Cache size (L1/L2/L3) (dual core processors have this listed twice)• Installed memory size/speed, number of channels (single or dual) (if applicable)• Integrated MAC address for embedded, enabled NIC (if applicable)• System BIOS (includes family name and version)• Chassis serial number• Asset tracking number
About	Displays copyright notice.
Set Time and Date	Allows you to set system time and date.
Apply Defaults and Exit	Applies the currently selected default settings and clears any established passwords.
Ignore Changes and Exit	Exits Computer Setup without applying or saving any changes.
Save Changes and Exit	Saves changes to system configuration or default settings and exits Computer Setup.

Computer Setup—Storage



NOTE: Support for specific Computer Setup options may vary depending on the hardware configuration.

Table 3-3 Computer Setup—Storage

Option	Description
Device Configuration	<p>Lists all installed BIOS-controlled storage devices.</p> <p>When a device is selected, detailed information and options are displayed. The following options may be presented:</p> <p>Hard Disk: Size, model, firmware version, serial number.</p> <p>Emulation type has the following choices:</p> <ul style="list-style-type: none">• None (prevents BIOS data accesses and disables it as a boot device)• Hard Disk (treated as a hard disk) <p>CD-ROM: Model, firmware version, serial number.</p>
Storage Options	<p>SATA Emulation</p> <p>Allows you to choose how the SATA controller and devices are accessed by the operating system. There are two supported options: IDE and AHCI.</p> <p>The default is set based on the Feature Byte code stored in the SMBIOS Type11/Feature Byte string as follows:</p> <p>Feature Byte Default</p> <p>FBC_SATA_RAID RAID</p> <p>FBC_SATA_AHCI AHCI</p> <p>FBC_SATA_IDE IDE</p> <p>Otherwise (none found) Platform-dependent - to be implemented by BIOS Integrator</p> <p>IDE - This is the most backwards-compatible setting of the three options. Operating systems usually do not require additional driver support in IDE mode.</p> <p>AHCI (default option) - Allows operating systems with AHCI device drivers loaded to take advantage of more advanced features of the SATA controller.</p>

Table 3-3 Computer Setup—Storage (continued)

DPS Self-Test	<p>Allows you to execute self-tests on ATA hard drives capable of performing the Drive Protection System (DPS) self-tests.</p> <p>NOTE: This selection will only appear when at least one drive capable of performing the DPS self-tests is attached to the system.</p>
Boot Order	<p>Allows you to:</p> <ul style="list-style-type: none">• Specify the order in which EFI boot sources (such as a internal hard drive, USB hard drive, USB optical drive, or internal optical drive) are checked for a bootable operating system image. Each device on the list may be individually excluded from or included for consideration as a bootable operating system source. <p>EFI boot sources always have precedence over legacy boot sources.</p> <ul style="list-style-type: none">• Specify the order in which legacy boot sources (such as a network interface card, internal hard drive, USB optical drive, or internal optical drive) are checked for a bootable operating system image. Each device on the list may be individually excluded from or included for consideration as a bootable operating system source.• Specify the order of attached hard drives. The first hard drive in the order will have priority in the boot sequence and will be recognized as drive C (if any devices are attached). <p>NOTE: You can use F5 to disable individual boot items, as well as disable EFI boot and/or legacy boot.</p> <p>NOTE: MS-DOS drive lettering assignments may not apply after a non-MS-DOS operating system has started.</p> <p>Shortcut to Temporarily Override Boot Order</p> <p>To boot one time from a device other than the default device specified in Boot Order, restart the computer and press Esc (to access the boot menu) and then F9 (Boot Order), or only F9 (skipping the boot menu) when the monitor light turns green. After POST is completed, a list of bootable devices is displayed. Use the arrow keys to select the preferred bootable device and press Enter. The computer then boots from the selected non-default device for this one time.</p>

Computer Setup—Security



NOTE: Support for specific Computer Setup options may vary depending on the hardware configuration.

Table 3-4 Computer Setup—Security

Option	Description
Setup Password	<p>Allows you to set and enable a setup (administrator) password.</p> <p>NOTE: If the setup password is set, it is required to change Computer Setup options, flash the ROM, and make changes to certain plug and play settings under Windows.</p> <p>If a setup password is set, the computer requires that you enter it before accessing the following functions: Boot Menu (F9), Computer Setup (F10), System Recovery (F11), Network Boot (F12).</p> <p>See the <i>Desktop Management Guide</i> for more information.</p>
Power-On Password	<p>Allows you to set and enable a power-on password. The power-on password prompt appears after a power cycle. If the user does not enter the correct power-on password, the unit will not boot.</p> <p>NOTE: This selection will only appear when at least one drive that supports the DriveLock feature is attached to the system.</p> <p>See the <i>Desktop Management Guide</i> for more information.</p>
Password Options	<p>Allows you to enable/disable:</p> <p>(This selection appears only if a power-on password or setup password is set.)</p> <ul style="list-style-type: none">• Lock Legacy Resources (appears if a setup password is set). Default is enabled.• Setup Browse Mode (appears if a setup password is set) (allows viewing, but not changing, the F10 Setup Options without entering setup password). Default is enabled.• Password prompt on F9, F11, & F12 (allows access to menus without entering setup password). Default is enabled.• Network Server Mode (appears if a power-on password is set). Default is disabled. <p>See the <i>Desktop Management Guide</i> for more information.</p>
Device Security	<p>Allows you to set Device Available/Device Hidden (default is Device Available) for:</p> <ul style="list-style-type: none">• System audio• Serial ports (some models)• Parallel port (some models)• Network controller <p>NOTE: You must disable AMT before trying to hide the network controller.</p> <ul style="list-style-type: none">• SATA0• SATA1• SATA2• SATA3

Table 3-4 Computer Setup—Security (continued)

USB Security	Allows you to set Enabled/Disabled (default is Enabled) for: <ul style="list-style-type: none">• Front USB Ports<ul style="list-style-type: none">◦ USB Port 3◦ USB Port 4• Rear USB Ports<ul style="list-style-type: none">◦ USB Port 8◦ USB Port 9◦ USB Port 10◦ USB Port 11• Internal USB Ports<ul style="list-style-type: none">◦ USB Port 0◦ USB Port 1◦ USB Port 2◦ USB Port 5
Slot Security	Allows you to disable any PCI Express or MiniCard slot. Default is enabled.
Network Boot	Enables/disables the computer's ability to boot from an operating system installed on a network server. (Feature available on NIC models only; the network controller must be either a PCI expansion card or embedded on the system board.) Default is enabled.

Table 3-4 Computer Setup—Security (continued)

System IDs	<p>Allows you to view:</p> <ul style="list-style-type: none">• Product Name• Serial number• Universal Unique Identifier (UUID) number. The UUID can only be updated if the current chassis serial number is invalid. (These ID numbers are normally set in the factory and are used to uniquely identify the system.)• SKU Number• Family Name• Asset tag (18-byte identifier), a property identification number assigned by the company to the computer.• Feature Byte• Build ID• Keyboard locale setting for System ID entry
System Security (some models: these options are hardware dependent)	<p>Data Execution Prevention (enable/disable) - Helps prevent operating system security breaches. Default is enabled.</p> <p>Virtualization Technology (VTx/VTd)(some models) (enable/disable) - Controls the virtualization features of the processor and DMA remapping features of the chipset. Changing this setting requires turning the computer off and then back on. Default is disabled.</p> <p>Intel TXT (LT) Support (some models) (enable/disable) - Controls the underlying processor and chipset features needed to support a virtual appliance. Changing this setting requires turning the computer off and then back on. Default is disabled. To enable this feature you must enable the following features:</p> <ul style="list-style-type: none">• Embedded Security Device Support• Virtualization Technology• Virtualization Technology Directed I/O <p>Embedded Security Device Support (some models) (enable/disable) - Permits activation and deactivation of the Embedded Security Device. Changing this setting requires turning the computer off and then back on.</p> <p>NOTE: To configure the Embedded Security Device, a Setup password must be set.</p> <ul style="list-style-type: none">• Reset to Factory Settings (some models) (Do not reset/Reset) - Resetting to factory defaults will erase all security keys. Changing this setting requires turning the computer off and then back on. Default is Do not reset. <p>CAUTION: The embedded security device is a critical component of many security schemes. Erasing the security keys will prevent access to data protected by the Embedded Security Device. Choosing Reset to Factory Settings may result in significant data loss.</p> <p>OS management of Embedded Security Device (some models) (enable/disable) - This option allows the user to limit operating system control of the Embedded Security Device. Changing this setting requires turning the computer off and then back on. This option allows the user to limit OS control of the Embedded Security Device. Default is enabled.</p> <p>Reset of Embedded Security Device through OS (some models) (enable/disable) - This option allows the user to limit the operating system ability to request a Reset to Factory Settings of the Embedded Security Device. Changing this setting requires turning the computer off and then back on. Default is disabled.</p> <p>NOTE: To enable this option, a Setup password must be set.</p>

Computer Setup—Power



NOTE: Support for specific Computer Setup options may vary depending on the hardware configuration.

Table 3-5 Computer Setup—Power

Option	Description
Hardware Power Management	<p>SATA Power Management – Enables or disables SATA bus and/or device power management. Default is enabled.</p> <p>S5 Maximum Power Savings – Turns off power to all nonessential hardware when system is off to meet EUP Lot 6 requirement of less than 1 Watt power usage. Default is enabled.</p> <p>S5 Wake on LAN (enable/disable).</p> <ul style="list-style-type: none">• To disable Wake on LAN during the off state (S5), use the arrow (left and right) keys to select the Advanced > Device Options menu and set the S5 Wake on LAN feature to Disable. This obtains the lowest power consumption available on the computer during S5. It does not affect the ability of the computer to Wake on LAN from suspend or hibernation, but will prevent it from waking from S5 via the network. It does not affect operation of the network connection while the computer is on.• If a network connection is not required, completely disable the network controller (NIC) by using the arrow (left and right) keys to select the Security > Device Security menu. Set the Network Controller option to Device Hidden. This prevents the network controller from being used by the operating system and reduces the power used by the computer in S5.
Thermal	<p>CPU Fan Speed (view only) – Lets you view fan speed.</p> <p>System Fan Speed (view only) – Lets you view fan speed.</p>

Computer Setup—Advanced



NOTE: Support for specific Computer Setup options may vary depending on the hardware configuration.

Table 3-6 Computer Setup—Advanced (for advanced users)

Option	Heading
Power-On Options	<p>Allows you to set:</p> <ul style="list-style-type: none">• POST messages (enable/disable). Default is disabled.• After Power Loss (off/on/previous state). Default is Power off. Setting this option to:<ul style="list-style-type: none">◦ Power off—causes the computer to remain powered off when power is restored.◦ Power on—causes the computer to power on automatically as soon as power is restored.◦ Previous state—causes the computer to power on automatically as soon as power is restored, if it was on when power was lost. <p>NOTE: If you turn off power to the computer using the switch on a power strip, you will not be able to use the suspend/sleep feature or the Remote Management features.</p> <ul style="list-style-type: none">• POST Delay (in seconds). Enabling this feature will add a user-specified delay to the POST process. This delay is sometimes needed for hard disks on some PCI cards that spin up very slowly, so slowly that they are not ready to boot by the time POST is finished. The POST delay also gives you more time to select F10 to enter Computer (F10) Setup. Default is None.
BIOS Power-On	<p>Allows you to set the computer to turn on automatically at a time you specify.</p>
Bus Options	<p>On some models, allows you to enable or disable:</p> <ul style="list-style-type: none">• PCI SERR# Generation. Default is enabled.• PCI VGA Palette Snooping, which sets the VGA palette snooping bit in PCI configuration space; only needed when more than one graphics controller is installed. Default is disabled.
Device Options	<p>Allows you to set:</p> <ul style="list-style-type: none">• Num Lock State at Power-On (off/on). Default is off.• Integrated Video (enable/disable). Use this option to disable the integrated video controller when another video controller is present in the system. Default is enabled.• Multi-Processor (enable/disable). Use this option to disable multi-processor support under the OS. Default is enabled.• NIC PXE Option ROM Download (PXE, iSCSI, disabled). The BIOS contains an embedded NIC option ROM to allow the unit to boot through the network to a PXE server. This is typically used to download a corporate image to a hard drive. The NIC option ROM takes up memory space below 1MB commonly referred to as DOS Compatibility Hole (DCH) space. This space is limited. This F10 option will allow users to disable the downloading of this embedded NIC option ROM thus giving more DCH space for additional PCI cards which may need option ROM space. The default will be to have the NIC option-ROM-enabled. Default is PXE.

Recovering the Configuration Settings

This method of recovery requires that you first perform the **Save to Removable Media** command with the Computer Setup (F10) Utility before **Restore** is needed.



NOTE: It is recommended that you save any modified computer configuration settings to a USB flash media device and save the device for possible future use.

To restore the configuration, insert the USB flash media device with the saved configuration and perform the **Restore from Removable Media** command with the Computer Setup (F10) Utility.

4 Illustrated parts catalog

This chapter provides spare part information for all chassis.

Microtower Chassis Spare Parts

Computer Major Components

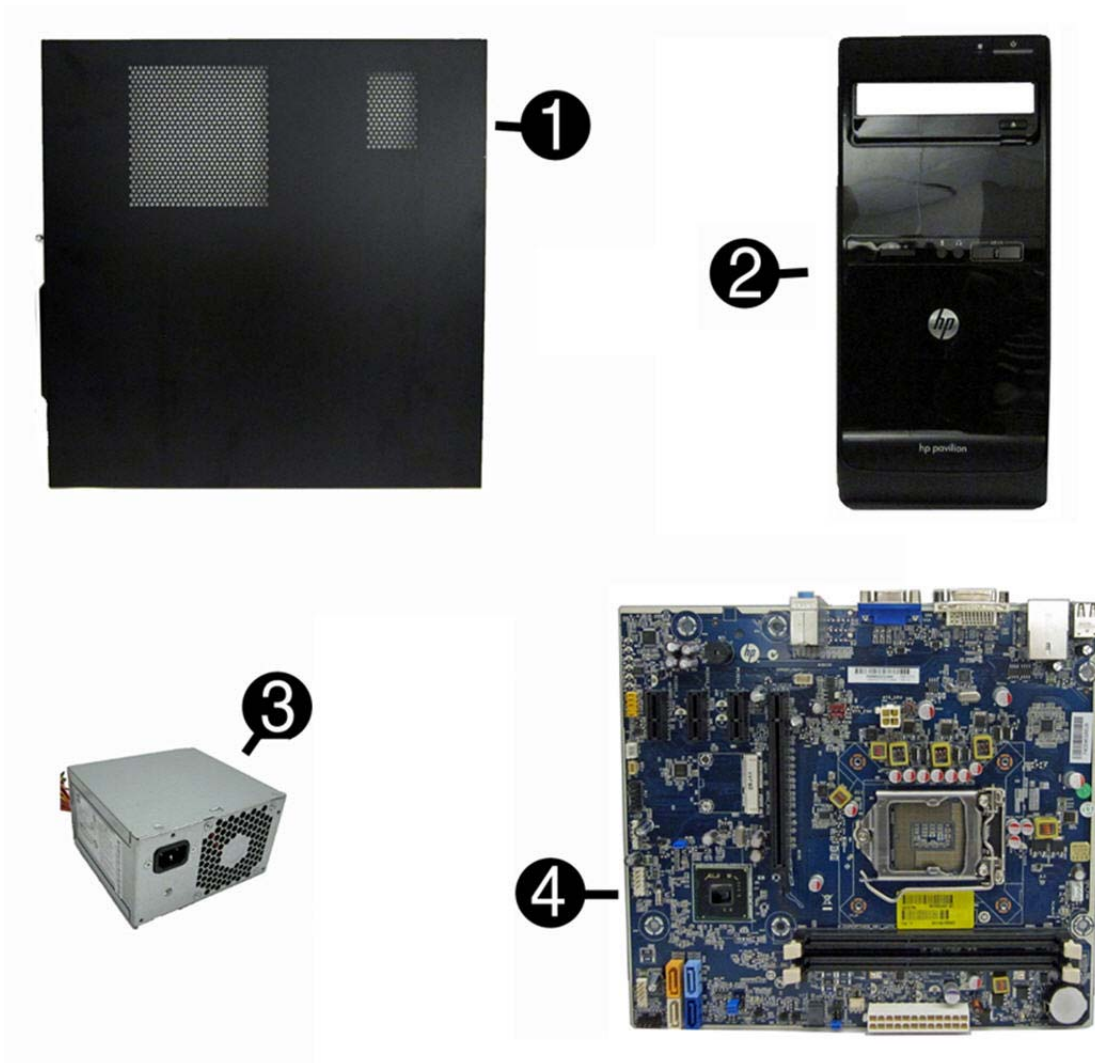

Item	Description	Spare part number
(1)	Access panel	674373-001
(2)	Front bezel	
	For use in only the EMEA region	667849-001
	With optical drive door for use in Brazil	667849-201
	For use in the North America and Latin America regions	670692-001
(3)	Power supply, 300W	
	300W, active PFC, not for use in Brazil	656721-001
	300W	664862-001
(4)	System board (includes replacement thermal material)	
	System board for use in 3400 models with Intel processors	660281-001
	System board for use in 3410 models with Intel processors in Brazil	665223-001
	System board for use in 3405 models with AMD processors	660155-001
	Memory modules (PC3-10600, 1333-MHz; not illustrated)	
	4-GB	585157-001
	2-GB	635803-001
	1-GB	635802-001
	Processors (include replacement thermal material; not illustrated)	
	Intel processors (for use in model 3400/3410)	
	Intel Core i7 2600S (2.8-GHz, 8-MB L3 cache; not for use in Brazil)	638419-001
	Intel Core i7 2600 (3.4-GHz, 8-MB L3 cache)	638632-001
	Intel Core i5 2500 (3.3-GHz, 6-MB L3 cache; not for use in Brazil)	638631-001
	Intel Core i5 2400 (3.1-GHz, 6-MB L3 cache; not for use in Brazil)	638630-001
	Intel Core i5 2320 (3.0-GHz, 6-MB L3 cache)	665121-001
	Intel Core i5 2310 (2.9-GHz, 6-MB L3 cache; not for use in Brazil)	657111-001
	Intel Core i5 2300 (2.8-GHz, 6-MB L3 cache; not for use in Brazil)	654601-001
	Intel Core i3 2130 (3.4-GHz, 3-MB L3 cache; not for use in Brazil)	665120-001
	Intel Core i3 2120 (3.3-GHz, 3-MB L3 cache; not for use in Brazil)	638629-001
	Intel Core i3 2105 (3.1-GHz, 3-MB L3 cache; not for use in Brazil)	655970-001
	Intel Core i3 2100 (3.1-GHz, 3-MB L3 cache)	638628-001
	Intel Pentium Dual-Core, G860 (3.0-GHz, 3-MB L3 cache; not for use in Brazil)	665123-001
	Intel Pentium Dual-Core, G850 (2.9-GHz, 3-MB L3 cache)	655973-001
	Intel Pentium Dual-Core, G840 (2.8-GHz, 3-MB L3 cache; not for use in Brazil)	655972-001
	Intel Pentium Dual-Core, G630 (2.7-GHz, 3-MB L3 cache; not for use in Brazil)	665122-001
	Intel Pentium Dual-Core, G620 (2.6-GHz, 3-MB L3 cache)	655971-001

Item	Description	Spare part number
	Intel Celeron G540 (2.5-GHz, 2-MB L3 cache; not for use in Brazil)	665119-001
	Intel Celeron G530 (2.4-GHz, 2-MB L3 cache; not for use in Brazil)	665117-001
	Intel Celeron G440 (1.6-GHz, 1-MB L3 cache; not for use in Brazil)	665467-001
AMD Advanced Processing Units (APUs) (for use in model 3405)		
	A-Series, X4 A8-3800 (2.4 GHz, 4-MB L2 cache, 65W; Radeon HD6550D graphics core)	667723-001
	A-Series, X4 A6-3650 (2.6 GHz, 4-MB L2 cache, 100W; Radeon HD6550D graphics core)	667722-001
	A-Series, X4 A6-3600 (2.1 GHz, 4-MB L2 cache, 65W; Radeon HD6530D graphics core)	667724-001
	A-Series, X4 A8-3550 (2.9 GHz, 4-MB L2 cache, 100W; Radeon HD6550D graphics core)	667721-001
	A-Series, X4 A4-3400 (2.7 GHz, 4-MB L2 cache, 65W; Radeon HD6530D graphics core)	667725-001
	A-Series, X2 E2-3200 (2.4 GHz, 1-MB L2 cache, 65W; Radeon HD6370D graphics core)	667726-001
	A-Series, X4 A8-3800 (2.4 GHz, 2-MB L2 cache, 65W; Radeon HD6550D graphics core)	667723-001

Cables

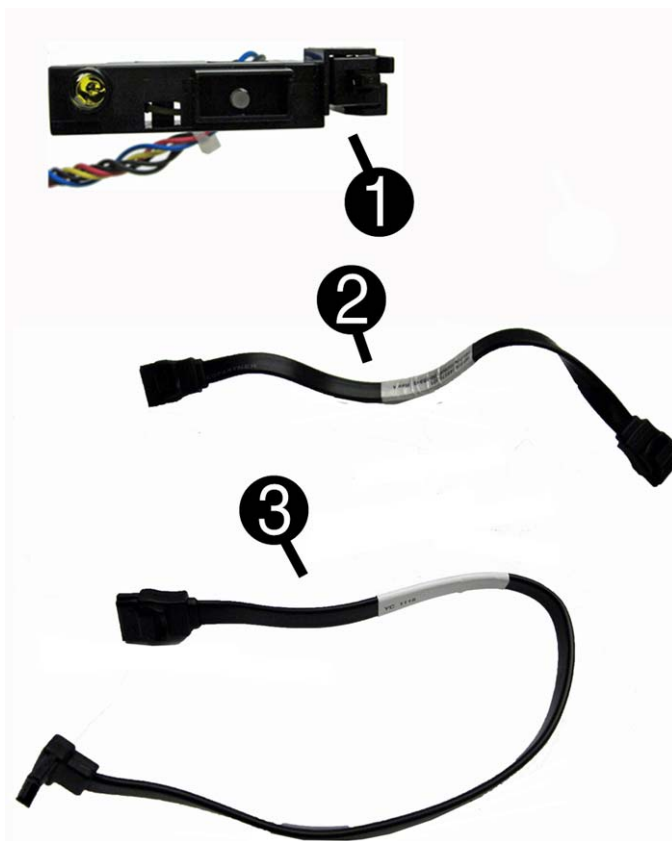

Item	Description	Spare part number
(1)	Power switch/LED assembly	667850-001
(2)	SATA cable, 165 mm	657102-001
(3)	SATA cable, 254 mm	667854-001
	Adapter, DVI to VGA, HF (not illustrated)	657401-001

Misc Parts

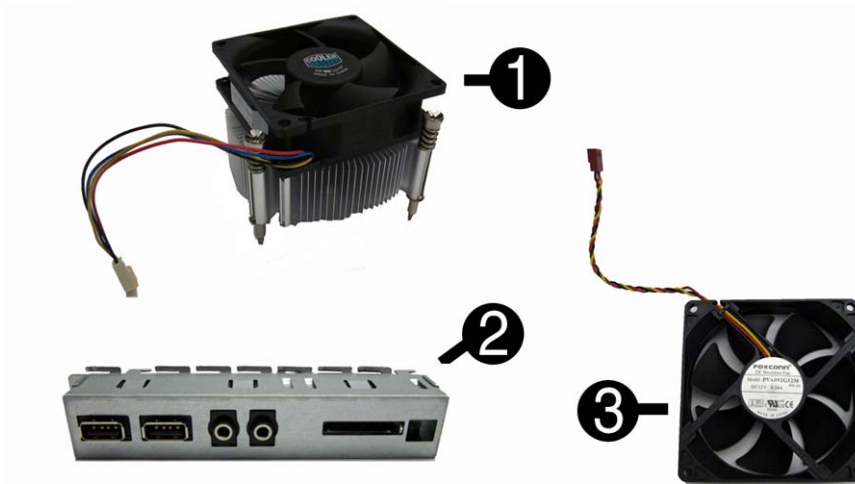

Item	Description	Spare part number
(1)	Fan sink (includes replacement thermal material)	
	For use in models with Intel processors	667727-001
	For use in models with AMD processors	657402-001
(2)	Front I/O and USB assembly	
	Does not include card reader	667853-001
	Includes card reader	667852-001
(3)	Chassis fan	
	For use in EMEA, North American, and Latin American regions; not for Brazil	657103-001
	For use in Brazil	514238-001, or 434645-001
	Mouse (optical, USB; not illustrated)	596410-001
	HP Business Digital Headset	642738-001
	Rubber feet (not illustrated)	530593-001

Drives

Description	Spare part number
Hard drive	
2-TB, 5400-rpm	613210-001
1.5-TB, 7200-rpm	613209-001
1.5-TB, 5400-rpm	652272-001
1-TB, 7200-rpm	667719-001
750-GB, 7200-rpm	632938-001
500-GB, 7200-rpm	667720-001
250-GB, 7200-rpm	621419-001
Optical drive	
16X SATA DVD-ROM drive (not for Brazil)	581599-001
16X SATA DVD±RW drive	581600-001

Misc Boards

Description	Spare part number
ATI Radeon HD 6450 1-GB graphics adapter	638132-001
ATI Radeon HD 6570 2-GB graphics adapter, full height (not for use in Brazil)	638406-001
ATI Radeon HD 6450 512-MB graphics adapter	647449-001
AMD Radeon HD 6350 512MB DDR3 FH PCIe x16 Card	631728-001
nVidia GeForce GT530 2-GB graphics adapter, full height (not for use in Brazil)	657106-001
nVidia GeForce GT405 512-MB graphics adapter (not for use in Brazil)	657108-001
nVidia GeForce GT520 1-GB graphics adapter, full height (not for use in Brazil)	657399-001
802.11b/g/n (1x1) WLAN module	634906-001

Sequential Part Number Listing

Spare part number	Description
434645-001	Chassis fan for use in Brazil
514238-001	Chassis fan for use in Brazil
530593-001	Rubber feet
581599-001	16X SATA DVD-ROM drive (not for Brazil)
581600-001	16X SATA DVD±RW drive
585157-001	Memory module, 4-GB, PC3 10600, 1333-MH
596410-001	Mouse, USB, optical
613209-001	1.5-TB hard drive
613210-001	2-TB, 5400-rpm hard drive
621419-001	250 GB, 7200 rpm SATA hard drive
631728-001	AMD Radeon HD 6350 512MB DDR3 FH PCIe x16 Card
632938-001	750-GB, 7200 RPM hard drive
634906-001	802.11b/g/n (1x1) WLAN module
635802-001	Memory module, 1-GB, PC3 10600, 1333-MHz
635803-001	Memory module, 2-GB, PC3 10600, 1333-MHz
638132-001	ATI Radeon HD 6450 1-GB graphics adapter
638406-001	ATI Radeon HD 6570 2-GB graphics adapter, full height (not for use in Brazil)
638419-001	Intel Core i7 2600S processor (2.7-GHz, 8-MB L3 cache; not for use in Brazil)
638628-001	Intel Core i3 2100 processor (3.1-GHz, 3-MB L3 cache)
638630-001	Intel Core i5 2400 processor (3.1-GHz, 6-MB L3 cache; not for use in Brazil)
638631-001	Intel Core i5 2500 processor (3.3-GHz, 6-MB L3 cache; not for use in Brazil)
638632-001	Intel Core i7 2600 processor (3.4-GHz, 8-MB L3 cache)
642758-001	HP Business Digital Headset
647449-001	ATI Radeon HD 6450 512-MB graphics adapter
652272-001	1.5-TB, 5400-rpm hard drive
654601-001	Intel Core i5 2300 processor (2.8-GHz, 6-MB L3 cache; not for use in Brazil)
655970-001	Intel Core i3 2105 processor (3.1-GHz, 3-MB L3 cache; not for use in Brazil)
655971-001	Intel Pentium Dual-Core, G620 (2.6-GHz, 3-MB L3 cache)
655972-001	Intel Pentium Dual-Core, G840 (2.8-GHz, 3-MB L3 cache; not for use in Brazil)
655973-001	Intel Pentium Dual-Core, G850 (2.9-GHz, 3-MB L3 cache)
657399-001	nVidia GeForce GT520 1-GB graphics adapter, full height (not for use in Brazil)
657401-001	DVI to VGA adapter, HF

Spare part number	Description
657402-001	Fan sink for use in models with Intel processors (includes replacement thermal material)
656721-001	Power supply, 300W, active PFC, not for use in Brazil
656790-001	Intel Core i5 2405S (2.5-GHz, 6-MB L3 cache; not for use in Brazil)
657102-001	SATA cable, 165 mm
657402-001	Fan sink for use in models with AMD processors (includes replacement thermal material)
657103-001	Chassis fan
657106-001	nVidia GeForce GT530 2-GB graphics adapter, full height (not for use in Brazil)
657108-001	nVidia GeForce GT405 512-MB graphics adapter (not for use in Brazil)
657111-001	Intel Core i5 2310 processor (2.9-GHz, 6-MB L3 cache; not for use in Brazil)
660155-001	System board for use in models with AMD processors on 3405 models (includes replacement thermal material)
660281-001	System board for use in models with Intel processors on 3400 models (includes replacement thermal material)
664862-001	Power supply, 300W
665117-001	Intel Celeron G530 processor (2.4 GHz, 2-MB L3 cache, 65W; not for Brazil)
665119-001	Intel Celeron G540 processor (2.5 GHz, 2-MB L3 cache, 65W; not for Brazil)
665120-001	Intel Core i3 2130 processor (3.4 GHz, 3-MB L3 cache, 65W; not for Brazil)
665121-001	Intel Core i5 2320 processor (3.0 GHz, 6-MB L3 cache, 95W)
665122-001	Intel Pentium Dual-Core G630 processor (2.7 GHz, 3-MB L3 cache, 65W; not for Brazil)
665123-001	Intel Pentium Dual-Core G860 processor (3.0 GHz, 3-MB L3 cache, 65W; not for Brazil)
665223-001	System board for use in models with Intel processors on 3410 models in Brazil (includes thermal material)
665467-001	Intel Celeron G440 (1.6 GHz, 1-MB L3 cache, 35W; not for Brazil)
667719-001	1 TB hard drive
667720-001	500 GB hard drive
667721-001	AMD A-Series X4 A8-3550 processor (2.8 GHz, 4-MB L2 cache, 100W; Radeon HD6550D graphics core; not for use in Brazil)
667722-001	AMD A-Series X4 A6-3650 processor (2.6 GHz, 4-MB L2 cache, 100W; Radeon HD6550D graphics core; not for use in Brazil)
667723-001	AMD A-Series X4 A8-3800 processor (2.4 GHz, 4-MB L2 cache, 65W; Radeon HD6550D graphics core; not for use in Brazil)
667724-001	AMD A-Series X4 A6-3600 processor (2.1 GHz, 4-MB L2 cache, 65W; Radeon HD6530D graphics core; not for use in Brazil)
667725-001	AMD A-Series X2 A4-3400 processor (2.7 GHz, 4-MB L2 cache, 65W; Radeon HD6530D graphics core; not for use in Brazil)
667726-001	AMD A-Series X2 E2-3200 processor (2.4 GHz, 1-MB L2 cache, 65W; Radeon HD6370D graphics core; not for use in Brazil)
667727-001	Fan sink for use in models with Intel processors

Spare part number	Description
667849-001	Front bezel for use in the EMEA region
667849-201	Front bezel with optical drive door for use in Brazil
667850-001	Power switch/LED assembly with cable
674373-001	Access panel
667852-001	Front I/O and USB assembly; includes card reader
667853-001	Front I/O and USB assembly; does not include card reader
667854-001	SATA cable, 254 mm
670692-001	Front bezel for use in North America and Latin America regions

Small Form Factor (SFF) Chassis Spare Parts

Computer major components

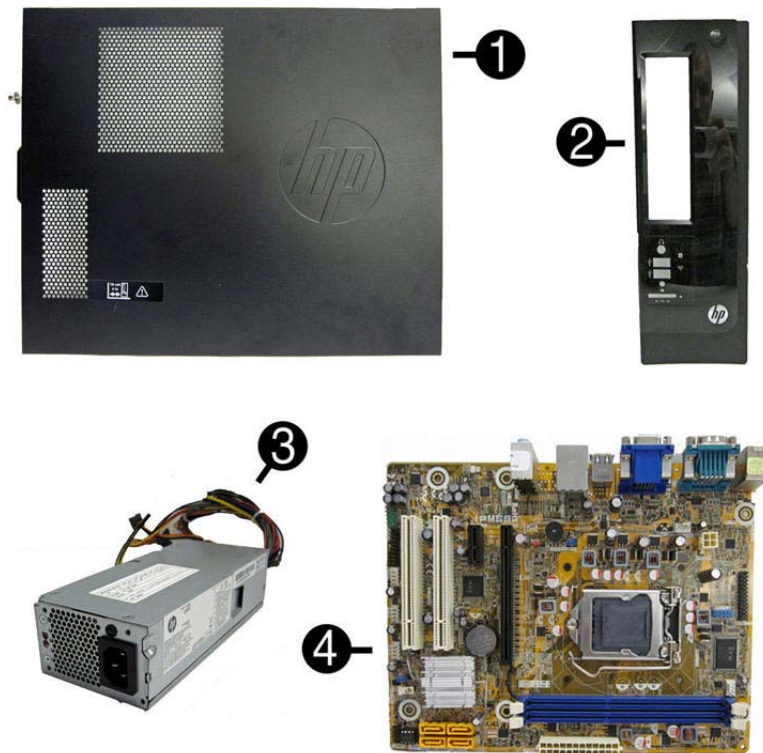

Item	Description	Spare part number
(1)	Access panel	656832-001
(2)	Front bezel	656835-001
(3)	Power supply	
	220W	656722-001
	270W	665224-001

Item	Description	Spare part number
(4)	System board (includes replacement thermal material)	665223-001
	Memory modules (PC3-10600, 1333-MHz; not illustrated)	
	4-GB	585157-001
	2-GB	635803-001
	1-GB	635802-001
	Processors (include replacement thermal material; not illustrated)	
	Intel Core i7 processor:	
	2600S (2.8-GHz, 8-MB L3 cache, 65W)	638419-001
	Intel Core i5 processors:	
	2500S (2.7-GHz, 6-MB L3 cache, 65W)	638420-001
	2500 (3.3 GHz, 6-MB L3 cache, 95W)	638631-001
	2405S (2.5-GHz, 6-MB L3 cache, 65W)	656790-001
	2400S (2.5-GHz, 6-MB L3 cache, 65W)	640953-001
	2400 (3.1 GHz, 6-MB L3 cache, 95W)	638630-001
	2320 (3.0 GHz, 6-MB L3 cache, 95W)	665121-001
	2310 (2.9 GHz, 6-MB L3 cache, 95W)	657111-001
	2300 (2.8 GHz, 6-MB L3 cache, 95W)	654601-001
	Intel Core i3 processors:	
	2130 (3.4 GHz, 3-MB L3 cache, 65W)	665120-001
	2120 (3.3-GHz, 3-MB L3 cache, 65W)	638629-001
	2100 (3.1-GHz, 3-MB L3 cache, 65W)	638628-001
	Intel Pentium Dual-Core processors:	
	G860 (3.0-GHz, 3-MB L3 cache, 65W)	665123-001
	G850 (2.9-GHz, 3-MB L3 cache, 65W)	655973-001
	G840 (2.8-GHz, 3-MB L3 cache, 65W)	655972-001
	G630 (2.7 GHz, 3-MB L3 cache, 65W)	665122-001
	G620 (2.6-GHz, 3-MB L3 cache, 65W)	655971-001
	G540 (2.5 GHz, 2-MB L3 cache, 65W)	665119-001
	G530 (2.4 GHz, 2-MB L3 cache, 65W)	665117-001
	G530T (2.0 GHz, 2-MB L3 cache, 35W)	665118-001

Cables

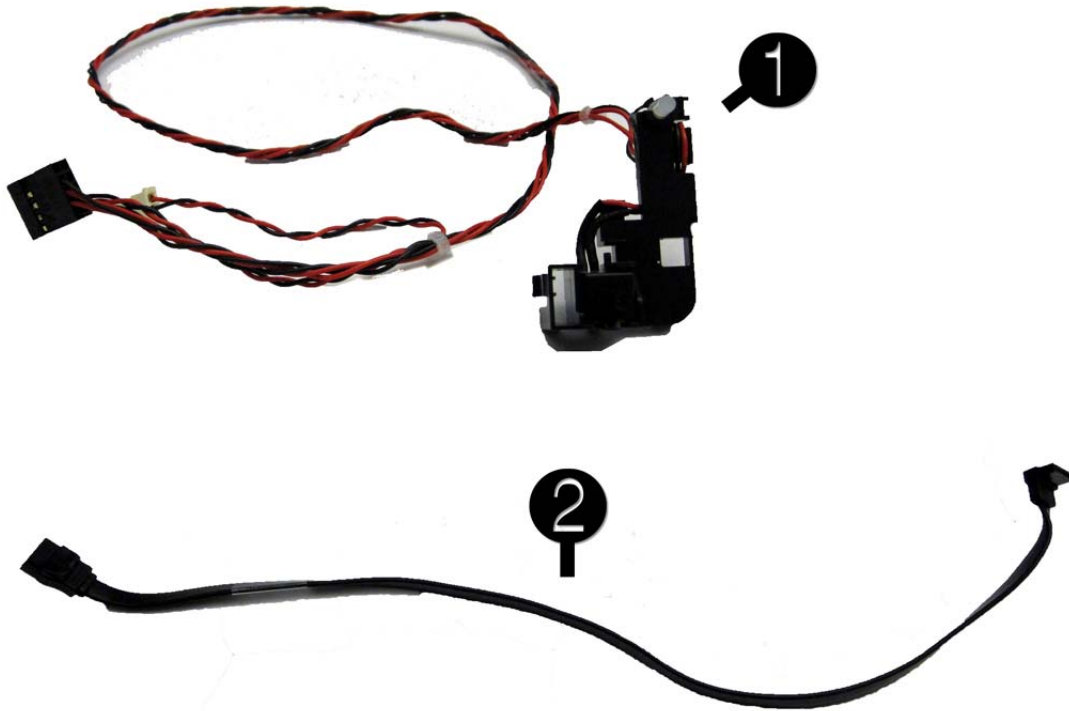

Item	Description	Spare part number
(1)	Power switch/LED assembly	656984-001
(2)	SATA cable, 370 mm	656833-001

Misc Parts

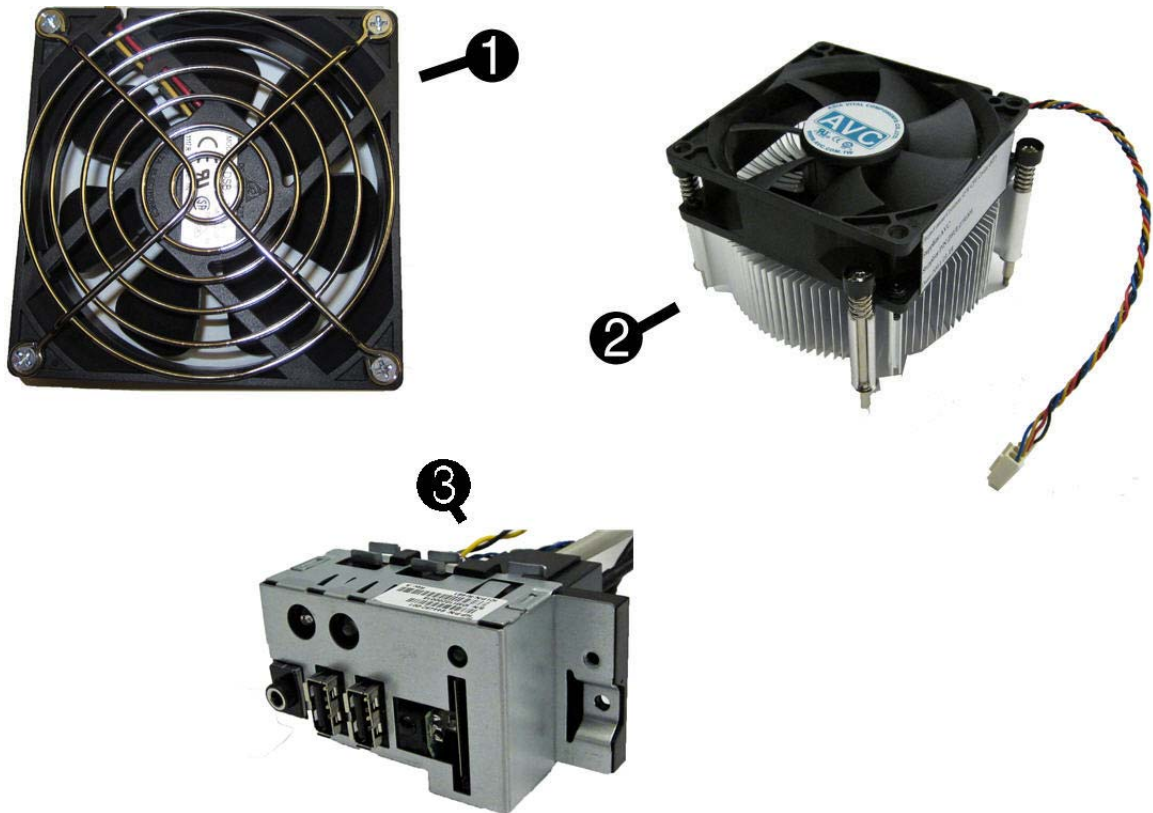

Item	Description	Spare part number
(1)	Chassis fan	656834-001
(2)	Fan sink (includes replacement thermal material)	657402-001
(3)	Front I/O and card reader (6-in-1)	656983-001
	DVI to VGA adapter (not illustrated)	202997-001
	DVI to VGA adapter, HF (not illustrated)	657401-001
	DVI to VGA adapter, HF, 29-pin (not illustrated)	657851-001
	RTC battery (not illustrated)	319603-001
	Mouse (optical, USB; not illustrated)	596410-001
	Keyboard for use in Brazil	537924-201
	Feet	660261-001
	HP Business Digital Headset	642738-001
	Webcam HD-2200	671734-001

Drives

Description	Spare part number
Hard drive	
2-TB, 7200-rpm	616608-001
1.5-TB, 7200-rpm	613209-001
1-TB, 7200-rpm	621418-001
750-GB, 7200-rpm	632938-001
500-GB, 7200-rpm	621421-001
320-GB, 7200-rpm	621420-001
Optical drive	
16X SATA DVD±RW drive	581600-001
DVD-ROM drive	581599-001

Misc Boards

Description	Spare part number
nVidia GeForce GT530 2-GB graphics adapter	659354-001
nVidia GeForce 405 PCIe x16 graphics card, 1 GB	656789-001
ATI Radeon HD6570 1-GB graphics adapter	659355-001
ATI Radeon HD6450 PCIe x16 graphics card, 1 GB	647451-001
ATI Radeon HD6450 PCIe x16 graphics card, 512 MB	647450-001

Sequential Part Number Listing

Spare part number	Description
202997-001	DVI to VGA adapter (not illustrated)
319603-001	RTC battery (not illustrated)
537924-201	Keyboard for use in Brazil
581599-001	DVD-ROM drive
581600-001	16X SATA DVD±RW drive
585157-001	Memory module, 4-GB, PC3 10600, 1333-MH
596410-001	Mouse, USB, optical
613209-001	1.5-TB hard drive
616608-001	2-TB hard drive
621418-001	1-TB hard drive

Spare part number	Description
621420-001	320-GB, 7200-rpm hard drive
621421-001	500-GB, 7200-rpm hard drive
632938-001	750-GB, 7200-rpm hard drive
635802-001	Memory module, 1-GB, PC3 10600, 1333-MHz
635803-001	Memory module, 2-GB, PC3 10600, 1333-MHz
638419-001	Intel Core i7 2600S processor (2.7-GHz, 8-MB L3 cache, 65W)
638420-001	Intel Core i5 2500S processor (2.7-GHz, 6-MB L3 cache, 65W)
638628-001	Intel Core i3 2100 processor (3.1-GHz, 3-MB L3 cache, 65W)
638629-001	Intel Core i3 2120 processor (3.3-GHz, 3-MB L3 cache, 65W)
638630-001	Intel Core i5 2400 processor (3.1 GHz, 6-MB L3 cache, 95W)
638631-001	Intel Core i5 2500 processor (3.3 GHz, 6-MB L3 cache, 95W)
640953-001	Intel Core i5 2400S processor (2.5-GHz, 6-MB L3 cache, 65W)
642738-001	HP Business Digital Headset
647450-001	ATI Radeon HD6450 PCIe x16 graphics card, 512 MB
647451-001	ATI Radeon HD6450 PCIe x16 graphics card, 1 GB
654601-001	Intel Core i5 2300 processor (2.8 GHz, 6-MB L3 cache, 95W)
655971-001	Intel Pentium Dual-Core G620 processor (2.6-GHz, 3-MB L3 cache, 65W)
655972-001	Intel Pentium Dual-Core G840 processor (2.8-GHz, 3-MB L3 cache, 65W)
655973-001	Intel Pentium Dual-Core G850 processor (2.9-GHz, 3-MB L3 cache, 65W)
656722-001	Power supply, 220W
656790-001	Intel Core i5 2405S processor (2.5-GHz, 6-MB L3 cache, 65W)
656833-001	SATA cable, 370 mm
656789-001	nVidia GeForce 405 PCIe x16 graphics card, 1 GB
656832-001	Access panel
656834-001	Chassis fan
656835-001	Front bezel
656983-001	Front I/O and card reader (6-in-1)
656984-001	Power switch/LED assembly
657111-001	Intel Core i5 2310 processor (2.9 GHz, 6-MB L3 cache, 95W)
657401-001	DVI to VGA adapter, HF
657402-001	Fan sink (includes replacement thermal material)
657851-001	DVI to VGA adapter, 29-pin HF
659354-001	nVidia GeForce GT530 2-GB graphics adapter
659355-001	ATI Radeon HD6570 1-GB graphics adapter

Spare part number	Description
660261-001	Feet
665117-001	Intel Pentium Dual-Core G530 processor (2.4 GHz, 2-MB L3 cache, 65W)
665118-001	Intel Pentium Dual-Core G530T processor (2.0 GHz, 2-MB L3 cache, 35W)
665119-001	Intel Pentium Dual-Core G540 processor (2.5 GHz, 2-MB L3 cache, 65W)
665120-001	Intel Core i3 2130 processor (3.4 GHz, 3-MB L3 cache, 65W)
665121-001	Intel Core i5 2320 processor (3.0 GHz, 6-MB L3 cache, 95W)
665122-001	Intel Pentium Dual-Core G630 processor (2.7 GHz, 3-MB L3 cache, 65W)
665123-001	Intel Pentium Dual-Core G860 processor (3.0 GHz, 3-MB L3 cache, 65W)
665223-001	System board for use in Brazil
665224-001	Power supply, 270W
671734-001	Webcam HD-2200

5 Serial ATA (SATA) Drive Guidelines and Features

 **NOTE:** HP only supports the use of SATA hard drives on these models of computer. No Parallel ATA (PATA) drives are supported.

SATA Hard Drives

Serial ATA Hard Drive Characteristics	
Number of pins/conductors in data cable	7/7
Number of pins in power cable	15
Maximum data cable length	39.37 in (100 cm)
Data interface voltage differential	400-700 mV
Drive voltages	3.3 V, 5 V, 12 V
Jumpers for configuring drive	N/A
Data transfer rate	3.0 Gb/s

SATA Hard Drive Cables

SATA Data Cable

Always use an HP approved SATA 3.0 Gb/s cable as it is fully backwards compatible with the SATA 1.5 Gb/s drives.

Current HP desktop products ship with SATA 3.0 Gb/s hard drives.

SATA data cables are susceptible to damage if overflexed. Never crease a SATA data cable and never bend it tighter than a 30 mm (1.18 in) radius.

The SATA data cable is a thin, 7-pin cable designed to transmit data for only a single drive.

SMART ATA Drives

The Self Monitoring Analysis and Recording Technology (SMART) ATA drives for the HP Personal Computers have built-in drive failure prediction that warns the user or network administrator of an impending failure or crash of the hard drive. The SMART drive tracks fault prediction and failure indication parameters such as reallocated sector count, spin retry count, and calibration retry count. If the drive determines that a failure is imminent, it generates a fault alert.

Hard Drive Capacities

The combination of the file system and the operating system used in the computer determines the maximum usable size of a drive partition. A drive partition is the largest segment of a drive that may be properly accessed by the operating system. A single hard drive may therefore be subdivided into a number of unique drive partitions in order to make use of all of its space.

Because of the differences in the way that drive sizes are calculated, the size reported by the operating system may differ from that marked on the hard drive or listed in the computer specification. Drive size calculations by drive manufacturers are bytes to the base 10 while calculations by Microsoft are bytes to the base 2.

Drive/Partition Capacity Limits				
			Maximum Size	
File System	Controller Type	Operating System	Partition	Drive
FAT 32	ATA	Windows 7	32 GB	2 TB
NTFS	ATA	Windows 7	2 TB	2 TB

6 Routine Care and Disassembly Preparation

This chapter provides general service information for the computer. Adherence to the procedures and precautions described in this chapter is essential for proper service.

⚠ CAUTION: When the computer is plugged into an AC power source, voltage is always applied to the system board. You must disconnect the power cord from the power source before opening the computer to prevent system board or component damage.

Electrostatic Discharge Information

A sudden discharge of static electricity from your finger or other conductor can destroy static-sensitive devices or microcircuitry. Often the spark is neither felt nor heard, but damage occurs. An electronic device exposed to electrostatic discharge (ESD) may not appear to be affected at all and can work perfectly throughout a normal cycle. The device may function normally for a while, but it has been degraded in the internal layers, reducing its life expectancy.

Networks built into many integrated circuits provide some protection, but in many cases, the discharge contains enough power to alter device parameters or melt silicon junctions.

Generating Static

The following table shows that:

- Different activities generate different amounts of static electricity.
- Static electricity increases as humidity decreases.

Event	Relative Humidity		
	55%	40%	10%
Walking across carpet	7,500 V	15,000 V	35,000 V
Walking across vinyl floor	3,000 V	5,000 V	12,000 V
Motions of bench worker	400 V	800 V	6,000 V
Removing DIPs* from plastic tube	400 V	700 V	2,000 V

Removing DIPs* from vinyl tray	2,000 V	4,000 V	11,500 V
Removing DIPs* from Styrofoam	3,500 V	5,000 V	14,500 V
Removing bubble pack from PCB	7,000 V	20,000 V	26,500 V
Packing PCBs in foam-lined box	5,000 V	11,000 V	21,000 V

*These are then multi-packaged inside plastic tubes, trays, or Styrofoam.

 **NOTE:** 700 volts can degrade a product.

Preventing Electrostatic Damage to Equipment

Many electronic components are sensitive to ESD. Circuitry design and structure determine the degree of sensitivity. The following packaging and grounding precautions are necessary to prevent damage to electric components and accessories.

- To avoid hand contact, transport products in static-safe containers such as tubes, bags, or boxes.
- Protect all electrostatic parts and assemblies with conductive or approved containers or packaging.
- Keep electrostatic sensitive parts in their containers until they arrive at static-free stations.
- Place items on a grounded surface before removing them from their container.
- Always be properly grounded when touching a sensitive component or assembly.
- Avoid contact with pins, leads, or circuitry.
- Place reusable electrostatic-sensitive parts from assemblies in protective packaging or conductive foam.

Personal Grounding Methods and Equipment

Use the following equipment to prevent static electricity damage to equipment:

- **Wrist straps** are flexible straps with a maximum of one-megohm \pm 10% resistance in the ground cords. To provide proper ground, a strap must be worn snug against bare skin. The ground cord must be connected and fit snugly into the banana plug connector on the grounding mat or workstation.
- **Heel straps/Toe straps/Boot straps** can be used at standing workstations and are compatible with most types of shoes or boots. On conductive floors or dissipative floor mats, use them on both feet with a maximum of one-megohm \pm 10% resistance between the operator and ground.

Static Shielding Protection Levels	
Method	Voltage
Antistatic plastic	1,500
Carbon-loaded plastic	7,500
Metallized laminate	15,000

Grounding the Work Area

To prevent static damage at the work area, use the following precautions:

- Cover the work surface with approved static-dissipative material. Provide a wrist strap connected to the work surface and properly grounded tools and equipment.
- Use static-dissipative mats, foot straps, or air ionizers to give added protection.
- Handle electrostatic sensitive components, parts, and assemblies by the case or PCB laminate. Handle them only at static-free work areas.
- Turn off power and input signals before inserting and removing connectors or test equipment.
- Use fixtures made of static-safe materials when fixtures must directly contact dissipative surfaces.
- Keep work area free of nonconductive materials such as ordinary plastic assembly aids and Styrofoam.
- Use field service tools, such as cutters, screwdrivers, and vacuums, that are conductive.

Recommended Materials and Equipment

Materials and equipment that are recommended for use in preventing static electricity include:

- Antistatic tape
- Antistatic smocks, aprons, or sleeve protectors
- Conductive bins and other assembly or soldering aids
- Conductive foam
- Conductive tabletop workstations with ground cord of one-megohm +/- 10% resistance
- Static-dissipative table or floor mats with hard tie to ground
- Field service kits
- Static awareness labels
- Wrist straps and footwear straps providing one-megohm +/- 10% resistance
- Material handling packages
- Conductive plastic bags
- Conductive plastic tubes
- Conductive tote boxes
- Opaque shielding bags
- Transparent metallized shielding bags
- Transparent shielding tubes

Operating Guidelines

To prevent overheating and to help prolong the life of the computer:

- Keep the computer away from excessive moisture, direct sunlight, and extremes of heat and cold.
- Operate the computer on a sturdy, level surface. Leave a 10.2-cm (4-inch) clearance on all vented sides of the computer and above the monitor to permit the required airflow.
- Never restrict the airflow into the computer by blocking any vents or air intakes. Do not place the keyboard, with the keyboard feet down, directly against the front of the desktop unit as this also restricts airflow.
- Occasionally clean the air vents on all vented sides of the computer. Lint, dust, and other foreign matter can block the vents and limit the airflow. Be sure to unplug the computer before cleaning the air vents.
- Never operate the computer with the cover or side panel removed.
- Do not stack computers on top of each other or place computers so near each other that they are subject to each other's re-circulated or preheated air.
- If the computer is to be operated within a separate enclosure, intake and exhaust ventilation must be provided on the enclosure, and the same operating guidelines listed above will still apply.
- Keep liquids away from the computer and keyboard.
- Never cover the ventilation slots on the monitor with any type of material.
- Install or enable power management functions of the operating system or other software, including sleep states.

Routine Care

General Cleaning Safety Precautions

1. Never use solvents or flammable solutions to clean the computer.
2. Never immerse any parts in water or cleaning solutions; apply any liquids to a clean cloth and then use the cloth on the component.
3. Always unplug the computer when cleaning with liquids or damp cloths.
4. Always unplug the computer before cleaning the keyboard, mouse, or air vents.
5. Disconnect the keyboard before cleaning it.
6. Wear safety glasses equipped with side shields when cleaning the keyboard.

Cleaning the Computer Case

Follow all safety precautions in [General Cleaning Safety Precautions on page 38](#) before cleaning the computer.

To clean the computer case, follow the procedures described below:

- To remove light stains or dirt, use plain water with a clean, lint-free cloth or swab.
- For stronger stains, use a mild dishwashing liquid diluted with water. Rinse well by wiping it with a cloth or swab dampened with clear water.
- For stubborn stains, use isopropyl (rubbing) alcohol. No rinsing is needed as the alcohol will evaporate quickly and not leave a residue.
- After cleaning, always wipe the unit with a clean, lint-free cloth.
- Occasionally clean the air vents on the computer. Lint and other foreign matter can block the vents and limit the airflow.

Cleaning the Keyboard

Follow all safety precautions in [General Cleaning Safety Precautions on page 38](#) before cleaning the keyboard.

To clean the tops of the keys or the keyboard body, follow the procedures described in [Cleaning the Computer Case on page 38](#).

When cleaning debris from under the keys, review all rules in [General Cleaning Safety Precautions on page 38](#) before following these procedures:

⚠ CAUTION: Use safety glasses equipped with side shields before attempting to clean debris from under the keys.

- Visible debris underneath or between the keys may be removed by vacuuming or shaking.
- Canned, pressurized air may be used to clean debris from under the keys. Caution should be used as too much air pressure can dislodge lubricants applied under the wide keys.
- If you remove a key, use a specially designed key puller to prevent damage to the keys. This tool is available through many electronic supply outlets.

⚠ CAUTION: Never remove a wide leveled key (like the space bar) from the keyboard. If these keys are improperly removed or installed, the keyboard may not function properly.

- Cleaning under a key may be done with a swab moistened with isopropyl alcohol and squeezed out. Be careful not to wipe away lubricants necessary for proper key functions. Use tweezers to remove any fibers or dirt in confined areas. Allow the parts to air dry before reassembly.

Cleaning the Monitor

- Wipe the monitor screen with a clean cloth moistened with water or with a towelette designed for cleaning monitors. Do not use sprays or aerosols directly on the screen; the liquid may seep into the housing and damage a component. Never use solvents or flammable liquids on the monitor.
- To clean the monitor body follow the procedures in [Cleaning the Computer Case on page 38](#).

Cleaning the Mouse

Before cleaning the mouse, ensure that the power to the computer is turned off.

- Clean the mouse ball by first removing the retaining plate and the ball from the housing. Pull out any debris from the ball socket and wipe the ball with a clean, dry cloth before reassembly.
- To clean the mouse body, follow the procedures in [Cleaning the Computer Case on page 38](#).

Service Considerations

Listed below are some of the considerations that you should keep in mind during the disassembly and assembly of the computer.

Power Supply Fan

The power supply fan is a variable-speed fan based on the temperature in the power supply.

CAUTION: The cooling fan is always on when the computer is in the “On” mode. The cooling fan is off when the computer is in “Standby,” “Suspend,” or “Off” modes.

You must disconnect the power cord from the power source before opening the computer to prevent system board or component damage.

Tools and Software Requirements

To service the computer, you need the following:

- Torx T-15 screwdriver (HP screwdriver with bits, PN 161946-001)
- Torx T-15 screwdriver with small diameter shank (for certain front bezel removal)
- Flat-bladed screwdriver (may sometimes be used in place of the Torx screwdriver)
- Phillips #2 screwdriver
- Diagnostics software
- HP tamper-resistant T-15 wrench (Smart Cover FailSafe Key, PN 166527-001) or HP tamper-resistant bits (Smart Cover FailSafe Key, PN 166527-002)

Screws

The screws used in the computer are not interchangeable. They may have standard or metric threads and may be of different lengths. If an incorrect screw is used during the reassembly process, it can damage the unit. HP strongly recommends that all screws removed during disassembly be kept with the part that was removed, then returned to their proper locations.

CAUTION: Metric screws have a black finish. U.S. screws have a silver finish and are used on hard drives only.

CAUTION: As each subassembly is removed from the computer, it should be placed away from the work area to prevent damage.

Cables and Connectors

Most cables used throughout the unit are flat, flexible cables. These cables must be handled with care to avoid damage. Apply only the tension required to seat or unseat the cables during insertion or removal from the connector. Handle cables by the connector whenever possible. In all cases, avoid bending or twisting the cables, and ensure that the cables are routed in such a way that they cannot be caught or snagged by parts being removed or replaced.

 **CAUTION:** When servicing this computer, ensure that cables are placed in their proper location during the reassembly process. Improper cable placement can damage the computer.

Hard Drives

Handle hard drives as delicate, precision components, avoiding all physical shock and vibration. This applies to failed drives as well as replacement spares.

- If a drive must be mailed, place the drive in a bubble-pack mailer or other suitable protective packaging and label the package “Fragile: Handle With Care.”
- Do not remove hard drives from the shipping package for storage. Keep hard drives in their protective packaging until they are actually mounted in the CPU.
- Avoid dropping drives from any height onto any surface.
- If you are inserting or removing a hard drive, turn off the computer. Do not remove a hard drive while the computer is on or in standby mode.
- Before handling a drive, ensure that you are discharged of static electricity. While handling a drive, avoid touching the connector. For more information about preventing electrostatic damage, refer to [Electrostatic Discharge Information on page 35](#)
- Do not use excessive force when inserting a drive.
- Avoid exposing a hard drive to liquids, temperature extremes, or products that have magnetic fields such as monitors or speakers.

Lithium Coin Cell Battery

The battery that comes with the computer provides power to the real-time clock and has a minimum lifetime of about three years.

See the appropriate removal and replacement chapter for the chassis you are working on in this guide for instructions on the replacement procedures.

 **WARNING!** This computer contains a lithium battery. There is a risk of fire and chemical burn if the battery is handled improperly. Do not disassemble, crush, puncture, short external contacts, dispose in water or fire, or expose it to temperatures higher than 140°F (60°C). Do not attempt to recharge the battery.

 **NOTE:** Batteries, battery packs, and accumulators should not be disposed of together with the general household waste. In order to forward them to recycling or proper disposal, please use the public collection system or return them to HP, their authorized partners, or their agents.

7 Removal and Replacement Procedures – Microtower Chassis

Adherence to the procedures and precautions described in this chapter is essential for proper service. After completing all necessary removal and replacement procedures, run the Diagnostics utility to verify that all components operate properly.



NOTE: Not all features listed in this guide are available on all computers.

Serviceability Features

The computers include features that make them easy to upgrade and service. A Torx T-15, Phillips, or flat blade screwdriver is needed for many of the installation procedures described in this guide.

Preparation for Disassembly

1. Close any open software applications.
2. Exit the operating system.
3. Remove any diskette or compact disc from the computer.
4. Turn off the computer and any peripheral devices that are connected to it.



CAUTION: Turn off the computer before disconnecting any cables.

CAUTION: Regardless of the power-on state, voltage is always present on the system board as long as the system is plugged into an active AC outlet. In some systems the cooling fan is on even when the computer is in the “Standby,” or “Suspend” modes. The power cord should always be disconnected before servicing a unit.

5. Disconnect the power cord from the electrical outlet and then from the computer.
6. Disconnect all peripheral device cables from the computer.



NOTE: During disassembly, label each cable as you remove it, noting its position and routing. Keep all screws with the units removed.



CAUTION: The screws used in the computer are of different thread sizes and lengths; using the wrong screw in an application may damage the unit.

Access Panel

Description	Spare part number
Access panel	674373-001

1. Prepare the computer for disassembly ([Preparation for Disassembly on page 42](#)).
2. Loosen the captive Torx screw (1) on the back panel that secures the panel to the computer.
3. Slide the side panel toward the back (2), and then pull it away from the computer.

 **NOTE:** Lay the computer on its side to install internal parts.

Figure 7-1 Removing the access panel



To replace the access panel, reverse the removal steps.

Front Bezel

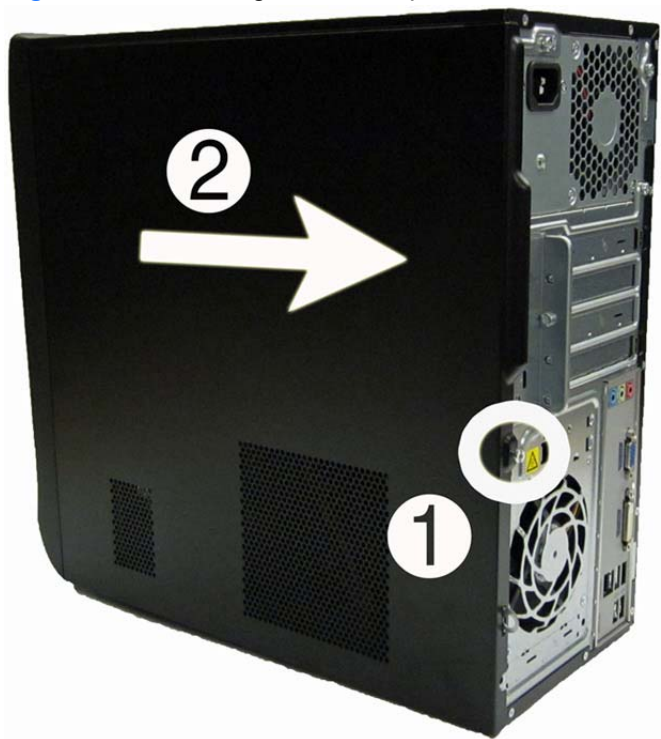
Description	Spare part number
Front bezel for use in EMEA region only	667849-001
Front bezel with optical drive door for use in Brazil	667849-201
Front bezel with for use in North American and Latin American regions	670692-001

1. Prepare the computer for disassembly ([Preparation for Disassembly on page 42](#)).
2. Remove the access panel ([Access Panel on page 43](#)).
3. Press outward on the three latches (1) on the right side of the bezel.
4. Rotate the right side of the bezel off the chassis, and then remove the bezel from the chassis (2).

Figure 7-2 Removing the Front Bezel

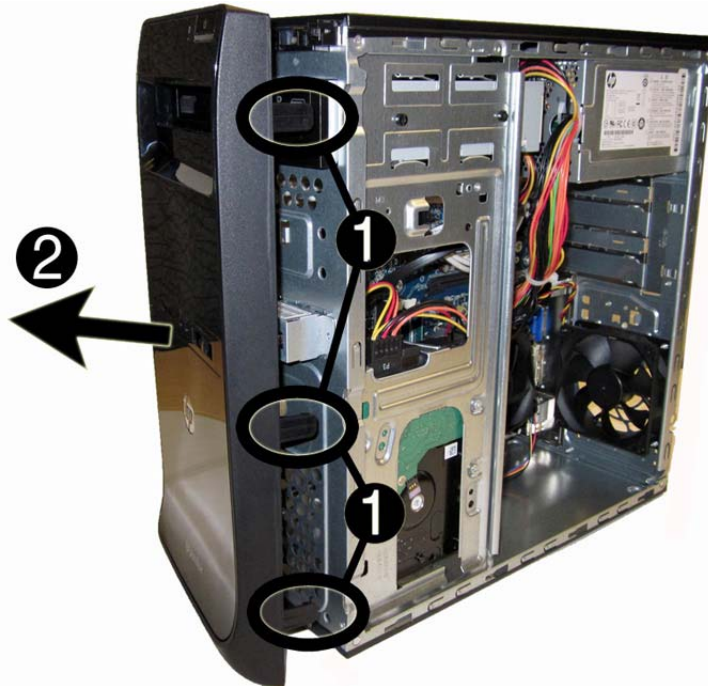

To reinstall the front bezel, reverse the removal procedure.

Memory

Description	Spare part number
4-GB, PC3-10600	585157-001
2-GB, PC3-10600	635803-001
1-GB, PC3-10600	635802-001

The computer comes with double data rate 3 synchronous dynamic random access memory (DDR3-SDRAM) dual inline memory modules (DIMMs).

DDR3-SDRAM DIMMs

The system board offers two memory sockets.

These memory sockets are populated with at least one preinstalled DIMM. To achieve the maximum memory support, you can populate the system board with up to 8-GB of memory.

For proper system operation, the DDR3-SDRAM DIMMs must be:

- industry-standard 240-pin
- unbuffered non-ECC PC3-10600 DDR3-1333 MHz-compliant
- 1.5 volt DDR3-SDRAM DIMMs

The DDR3-SDRAM DIMMs must also:

- support CAS latency 9 DDR3 1333 MHz (9-9-9 timing)
- contain the mandatory JEDEC SPD information

In addition, the computer supports:

- 512-Mbit, 1-Gbit, and 2-Gbit non-ECC memory technologies
- single-sided and double-sided DIMMs
- DIMMs constructed with x8 and x16 DDR devices; DIMMs constructed with x4 SDRAM are not supported

 **NOTE:** The system will not operate properly if you install unsupported DIMMs.

Populating DIMM Sockets

Populate the DIMM sockets in the following order: XMM1, XMM2 or Channel A, Channel B.

Figure 7-3 DIMM Socket Locations (HP Pro 3400 model shown)

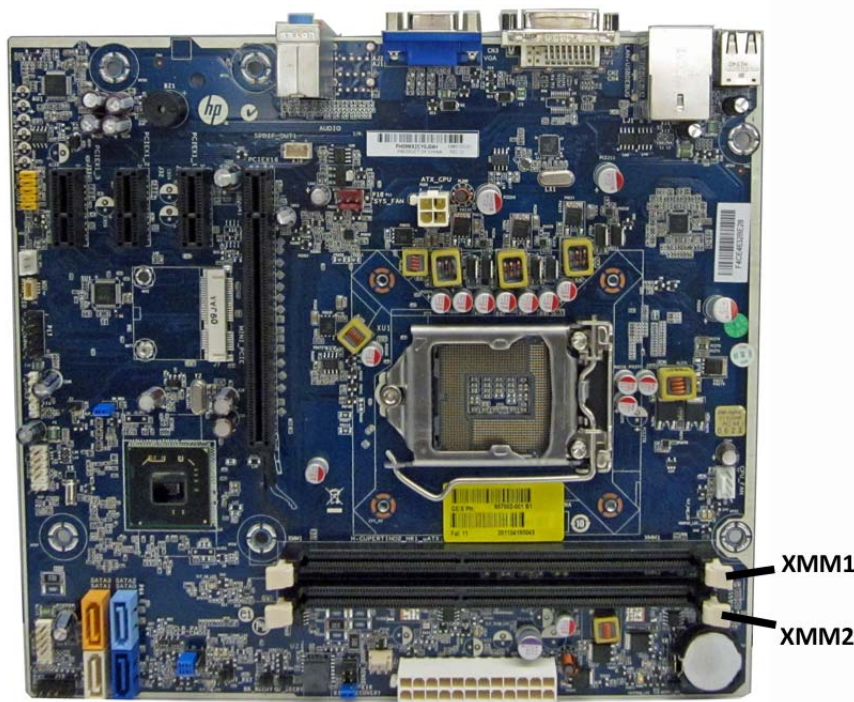

Table 7-1 DIMM Sockets

Description	Socket Color	Insertion Order
XMM1 socket, Channel A (populate first)	HP Pro 3400: Black	1
	HP Pro 3405/3410: Blue	
XMM2 socket, Channel A	HP Pro 3400: Black	2
	HP Pro 3405/3410: Blue	

NOTE: A memory module must occupy the XMM1/Channel A socket.

The system will automatically operate in single channel mode, dual channel mode, or flex mode, depending on how the DIMMs are installed.

- The system will operate in single channel mode if the DIMM sockets are populated in one channel only.
- The system will operate in a higher-performing dual channel mode if the total memory capacity of the DIMMs in Channel A is equal to the total memory capacity of the DIMMs in Channel B. The technology and device width can vary between the channels. For example, if Channel A is populated with one 1-GB DIMM and Channel B is populated with one 2-GB DIMM, the system will operate in dual channel mode.

- The system will operate in flex mode if the total memory capacity of the DIMMs in Channel A is not equal to the total memory capacity of the DIMMs in Channel B. In flex mode, the channel populated with the least amount of memory describes the total amount of memory assigned to dual channel and the remainder is assigned to single channel. For optimal speed, the channels should be balanced so that the largest amount of memory is spread between the two channels. If one channel will have more memory than the other, the larger amount should be assigned to Channel A. For example, if you are populating the sockets with one 2-GB DIMM, and one 1-GB DIMM, Channel A should be populated with the 2-GB DIMM, and Channel B should be populated with the 1-GB DIMM. With this configuration, 2 GB will run as dual channel and 1 GB will run as single channel.
- In any mode, the maximum operational speed is determined by the slowest DIMM in the system.

The system will automatically operate in single channel mode, dual channel mode, or flex mode, depending on how the DIMMs are installed.

Removing Memory Modules

⚠ CAUTION: You must disconnect the power cord and wait approximately 30 seconds for the power to drain before adding or removing memory modules. Regardless of the power-on state, voltage is always supplied to the memory modules as long as the computer is plugged into an active AC outlet. Adding or removing memory modules while voltage is present may cause irreparable damage to the memory modules or system board.

The memory module sockets have gold-plated metal contacts. When upgrading the memory, it is important to use memory modules with gold-plated metal contacts to prevent corrosion and/or oxidation resulting from having incompatible metals in contact with each other.

Static electricity can damage the electronic components of the computer or optional cards. Before beginning these procedures, ensure that you are discharged of static electricity by briefly touching a grounded metal object.

When handling a memory module, be careful not to touch any of the contacts. Doing so may damage the module.

-
1. Prepare the computer for disassembly ([Preparation for Disassembly on page 42](#)).
 2. Remove the access panel ([Access Panel on page 43](#)).
 3. Locate the memory module sockets on the system board.

⚠ WARNING! To reduce risk of personal injury from hot surfaces, allow the internal system components to cool before touching.

4. Open both latches (1) of the memory module socket , and remove the memory module from the socket (2).

Figure 7-4 Removing a DIMM

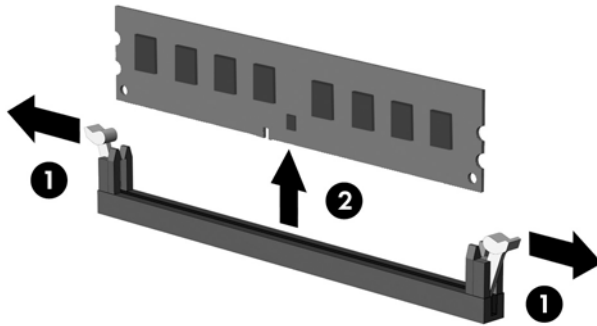

To install a memory module, reverse the removal procedures.

 **NOTE:** A memory module can be installed in only one way. Match the notch on the module with the tab on the memory socket.

A DIMM must occupy the XMM1 socket.

To create a dual-channel memory configuration, the memory capacity of Channel A must equal the memory capacity of Channel B. Refer to [Populating DIMM Sockets on page 46](#) for more information.

Expansion Cards

Description	Spare part number
802.11b/g/n (1x1) WLAN module	634906-001
ATI Radeon HD 6450 1-GB graphics adapter	638132-001
ATI Radeon HD 6450 512-MB graphics adapter	647449-001
nVidia GeForce GT405 2-GB graphics adapter, full height (not for Brazil)	638406-001
nVidia GeForce GT530 2-GB graphics adapter, full height (not for Brazil)	657106-001
nVidia GeForce GT405 512-MB graphics adapter (not for Brazil)	657108-001
nVidia GeForce GT520 1-GB graphics adapter, full height (not for Brazil)	657399-001

The computer has the following expansion slots:

Table 7-2 Expansion Slots

Slot Type	Number of Slots
PCI 2.3 slots. Can accommodate an expansion card up to 17.46 cm (6.875 inches) in length.	2 (HP Pro 3410 only)
PCI Express x1 slots	3 (HP Pro 3400 and HP Pro 3405); 1 (HP Pro 3410)
PCI Express x16 slots	1
MiniPCI slot	1 (HP Pro 3400 and HP Pro 3405 only)

Figure 7-5 Expansion Slot Locations (HP Pro 3400/3405 [3400 shown])

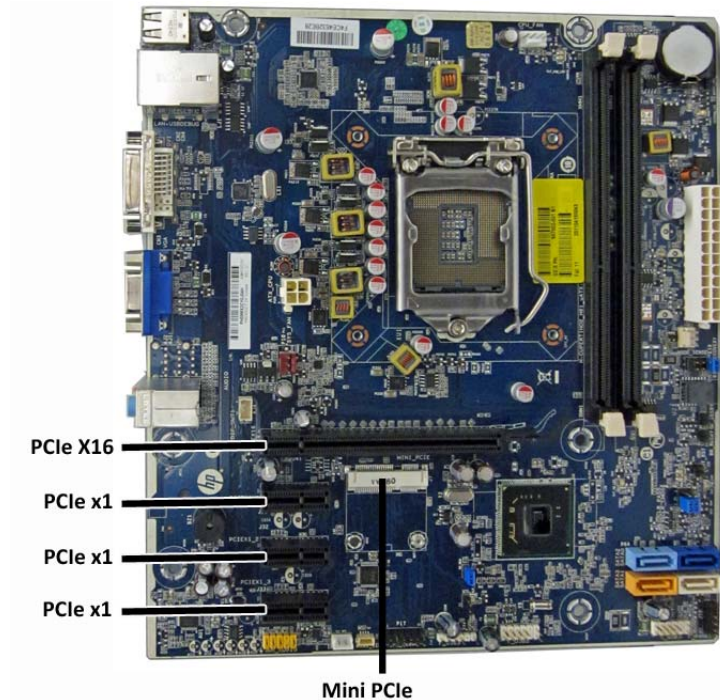
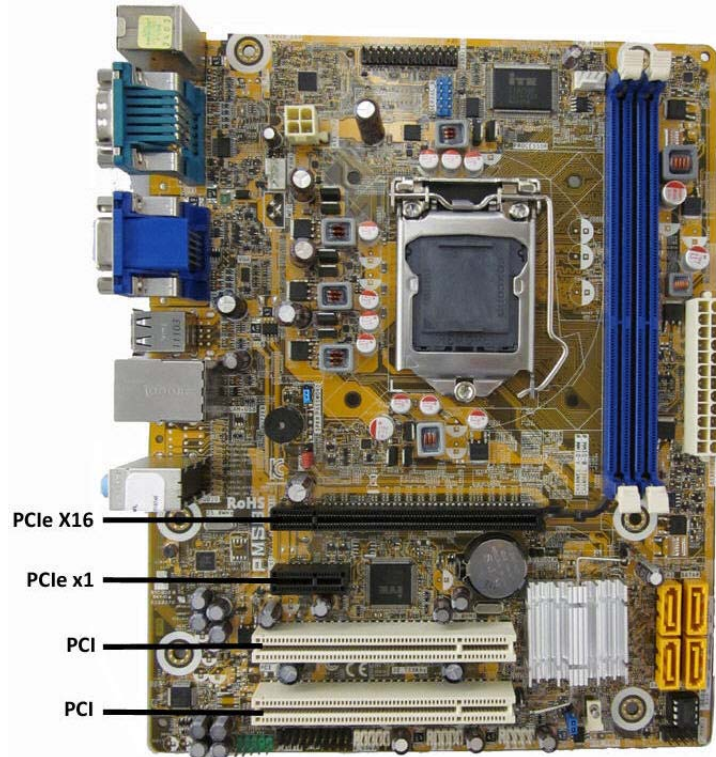



Table 7-3 Expansion Slots

Item	Description
PCIe X16	PCI Express x16 expansion slot
PCIe x1	PCIe x1 expansion slot
PCIe x1	PCIe x1 expansion slot
PCIe x1	PCIe x1 expansion slot
Mini PCIe	Mini PCIe slot (WLAN module)

Figure 7-6 Expansion Slot Locations (HP Pro 3410)



 **NOTE:** Board appearance and color may vary.



 **NOTE:** You can install a PCI Express x1, x4, x8, or x16 expansion card in the PCI Express x16 expansion slot.

Table 7-4 Expansion Slots

Item	Description
PCIe X16	PCI Express x16 expansion slot
PCIe x1	PCIe x1 expansion slot
PCI	PCI expansion slot
PCI	PCI expansion slot

 **NOTE:** You can install a PCI Express x1, x4, x8, or x16 expansion card in the PCI Express x16 expansion slot.

To remove, replace, or add an expansion card:

1. Prepare the computer for disassembly ([Preparation for Disassembly on page 42](#)).
2. Remove the access panel ([Access Panel on page 43](#)).
3. Locate the correct vacant expansion socket on the system board and the corresponding expansion slot on the back of the computer chassis.

4. On the rear of the computer, a slot cover lock secures the expansion card brackets in place. Remove the screw from the slot cover lock then slide the slot cover lock up to remove it from the chassis.

Figure 7-7 Opening the Slot Cover Lock



5. Before installing an expansion card, remove the expansion slot cover or the existing expansion card.

 **NOTE:** Before removing an installed expansion card, disconnect any cables that may be attached to the expansion card.

- a. If you are installing an expansion card in a vacant socket, you must use a flat blade screwdriver to pry out the metal shield on the rear panel that covers the expansion slot. Be sure to remove the appropriate shield for the expansion card you are installing.

Figure 7-8 Removing an Expansion Slot Cover



- b. If you are removing a PCI Express x1 card, hold the card at each end and carefully rock it back and forth until the connectors pull free from the socket. Be sure not to scrape the card against the other components.

Figure 7-9 Removing a PCI Express x1 Expansion Card

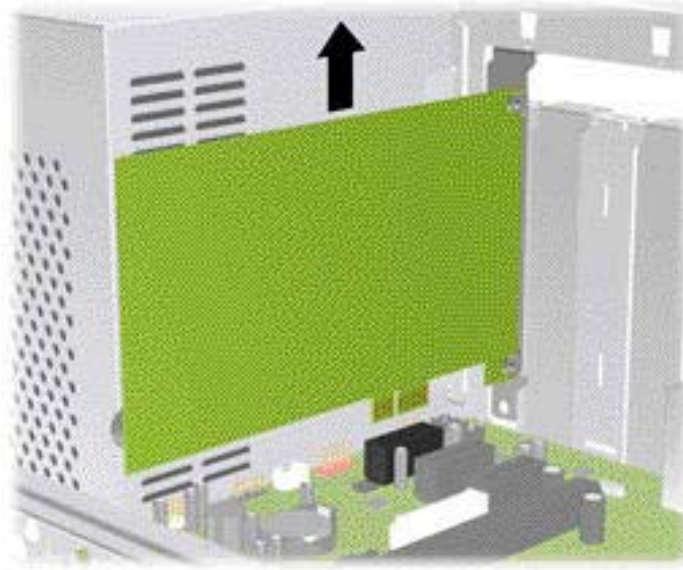

- c. If you are removing a PCI Express x16 card, pull the retention arm on the back of the expansion socket away from the card and carefully rock the card back and forth until the connectors pull free from the socket. Be sure not to scrape the card against the other components.

Figure 7-10 Removing a PCI Express x16 Expansion Card

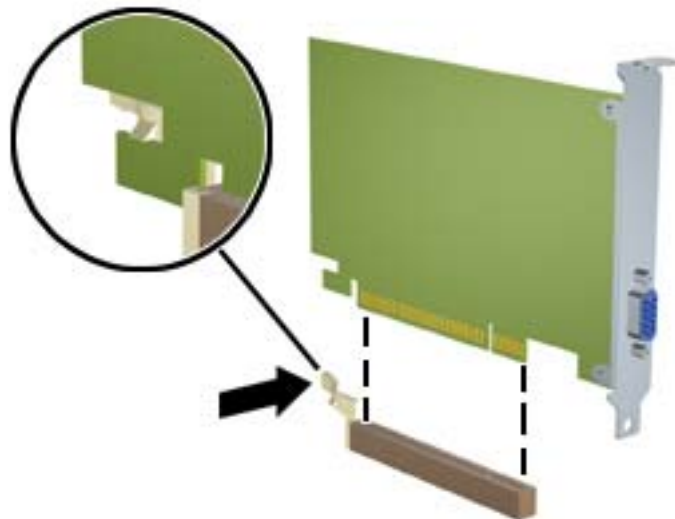

- 6. Store the removed card in anti-static packaging.

7. If you are not installing a new expansion card, install an expansion slot cover to close the open slot.

CAUTION: After removing an expansion card, you must replace it with a new card or expansion slot cover for proper cooling of internal components during operation.

8. To install a new expansion card, hold the card just above the expansion socket on the system board then move the card toward the rear of the chassis so that the bottom of the bracket on the card slides into the small slot on the chassis. Press the card straight down into the expansion socket on the system board.

Figure 7-11 Installing an Expansion Card

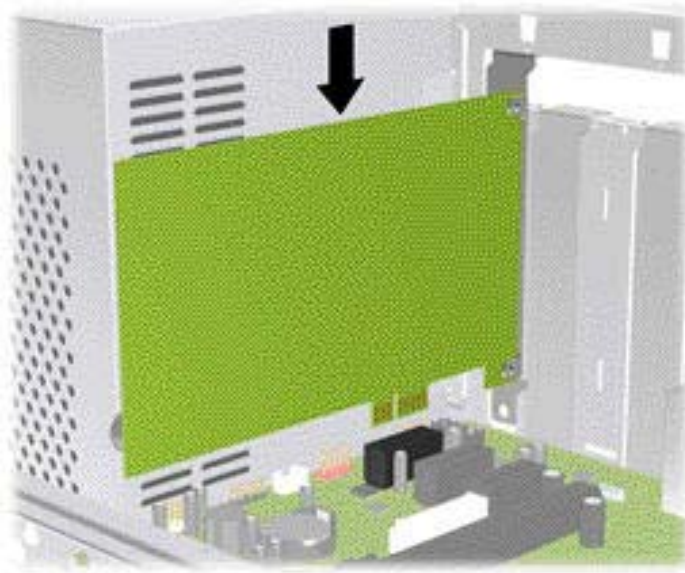

NOTE: When installing an expansion card, press firmly on the card so that the whole connector seats properly in the expansion card slot.

9. Replace the slot cover lock and secure it in place with the screw that was previously removed.

Figure 7-12 Securing the Expansion Cards and Slot Covers



10. Connect external cables to the installed card, if needed. Connect internal cables to the system board, if needed.
11. Reconfigure the computer, if necessary. Refer to [Computer Setup \(F10\) Utility on page 7](#) for instructions on using Computer Setup.

Cable Management

Always follow good cable management practices when working inside the computer.

- Keep cables away from major heat sources like the heat sink.
- Do not jam cables on top of expansion cards or memory modules. Printed circuit cards like these are not designed to take excessive pressure on them.
- Some flat ribbon cables come prefolded. Never change the folds on these cables.
- Never bend a SATA data cable tighter than a 30 mm (1.18 in) radius.
- Never crease a SATA data cable.
- Do not rely on components like the drive cage, power supply, or computer cover to push cables down into the chassis. Always position the cables to lay properly by themselves.

When removing the power supply power cable from the P1 connector on the system board, always follow these steps:

1. Squeeze on the top of the retaining latch attached to the cable end of the connector **(1)**.
2. Grasp the cable end of the connector and pull it straight up **(2)**.

⚠ CAUTION: Always pull the connector - NEVER pull on the cable. Pulling on the cable could damage the cable and result in a failed power supply.

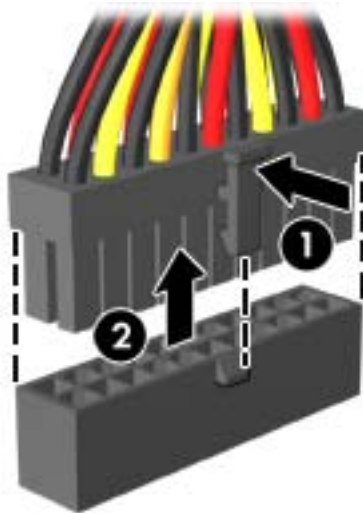

Cable Connections

System board connectors are color-coded to make it easier to find the proper connection.

Connector Name	Connector Color	Description
ATX_POWER	white	Power supply, 24-pin
ATX_CPU	white	Power supply, 4-pin
SYS_FAN	brown	Chassis fan
CPU_FAN (HP Pro 3400/3405)	white	Heat sink fan
CPU_FAN1 (HP Pro 3410)		
INT_SPKR (HP Pro 3400/3405 only)	white	Speaker
F_PANEL	black	Power switch
F_AUDIO	yellow	Front I/O audio
F_USB1	white	HP Pro 3400/3410: Media card reader HP Pro 3405: Front I/O USB
F_USB2	white	HP Pro 3400/3410: Front I/O USB HP Pro 3405: Media card reader
F_USB3	white	HP Pro 3400/3410: Front I/O USB
F_USB4	white	HP Pro 3405: Front I/O USB
SATA0	dark blue	Primary hard drive
SATA1	white	Primary optical drive
SATA2	light blue	Second hard drive
SATA3	orange	Second optical drive

Drives

Description	Spare part number
16X SATA DVD±RW drive	581600-001
6X SATA DVD-ROM drive (not for Brazil)	581599-001
2 TB, 7200 rpm SATA hard drive	613210-001
1.5 TB, 7200 rpm SATA hard drive	613209-001
1.5-TB, 5400-rpm SATA hard drive	652272-001
1 TB, 7200 rpm SATA hard drive	667719-001
750 GB, 7200 rpm SATA hard drive	632938-001
500 GB, 7200 rpm SATA hard drive	667720-001
250 GB, 7200 rpm SATA hard drive	621419-001

The computer supports up to three drives that may be installed in various configurations.

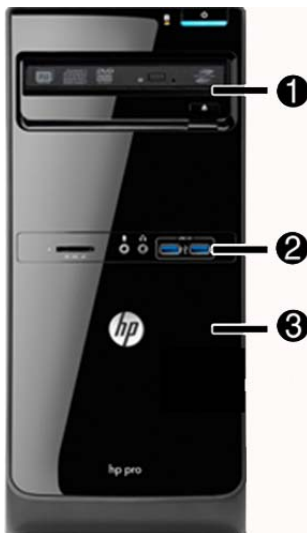

Table 7-5 Drive locations

Item	Description
1	Optical drive
2	Optical drive or media card reader
3	Hard drive (internal)

This section describes the procedure for replacing or upgrading the storage drives. A Torx T-15 screwdriver is needed to remove and install the guide screws on a drive.

Installing Additional Drives

When installing drives, follow these guidelines:

- The primary Serial ATA (SATA) hard drive must be connected to the dark blue primary SATA connector on the system board labeled SATA0.
- Connect an optical drive to the light blue SATA connector on the system board labeled SATA2.
- Connect a media card reader to:
 - HP Pro 3400/3410: F_USB1 system board connector
 - HP Pro 3405: F_USB2 system board connector
- The power cables for the SATA drives connect directly to the power supply. The primary hard drive connects to the power connector labeled P4. the primary optical drive connects to the power connector labeled P3.
- The system does not support Parallel ATA (PATA) optical drives or PATA hard drives.

⚠ CAUTION: To prevent loss of work and damage to the computer or drive:

If you are inserting or removing a drive, shut down the operating system properly, turn off the computer, and unplug the power cord. Do not remove a drive while the computer is on or in standby mode.

Before handling a drive, ensure that you are discharged of static electricity. While handling a drive, avoid touching the connector. For more information about preventing electrostatic damage, refer to [Electrostatic Discharge Information on page 35](#).

Handle a drive carefully; do not drop it.

Do not use excessive force when inserting a drive.

Avoid exposing a hard drive to liquids, temperature extremes, or products that have magnetic fields such as monitors or speakers.

If a drive must be mailed, place the drive in a bubble-pack mailer or other protective packaging and label the package "Fragile: Handle With Care."

System Board Drive Connections

Refer to the following illustration and table to identify the system board drive connectors.

Figure 7-13 System Board Drive Connections (HP Pro 3400 shown)

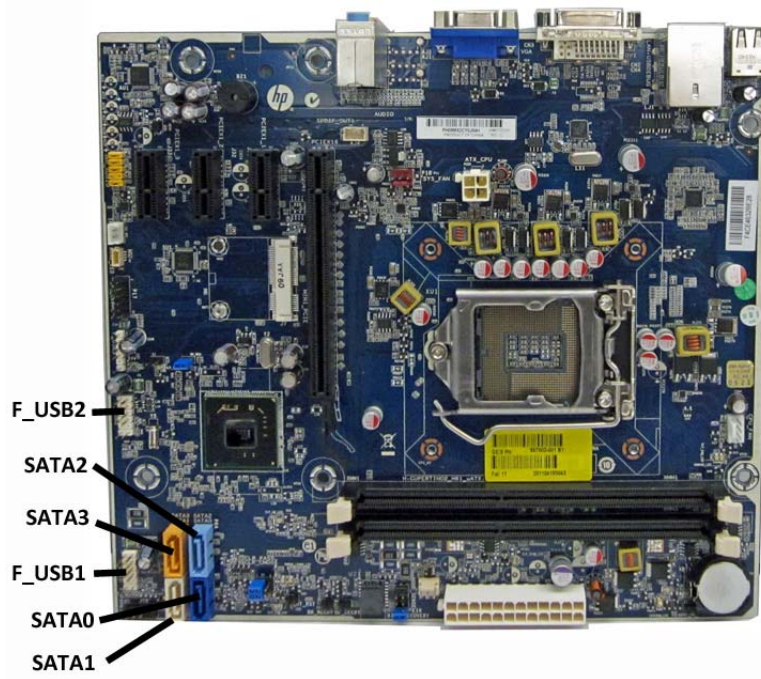

Table 7-6 System Board Drive Connections

System Board Connector	System Board Label	Color
SATA0	SATA0	dark blue
SATA1	SATA1	white
SATA2	SATA2	light blue
SATA3	SATA3	orange
Media Card Reader	F_USB1 (HP Pro 3400/3410)	white

Figure 7-14 System Board Drive Connections (HP Pro 3405 shown)

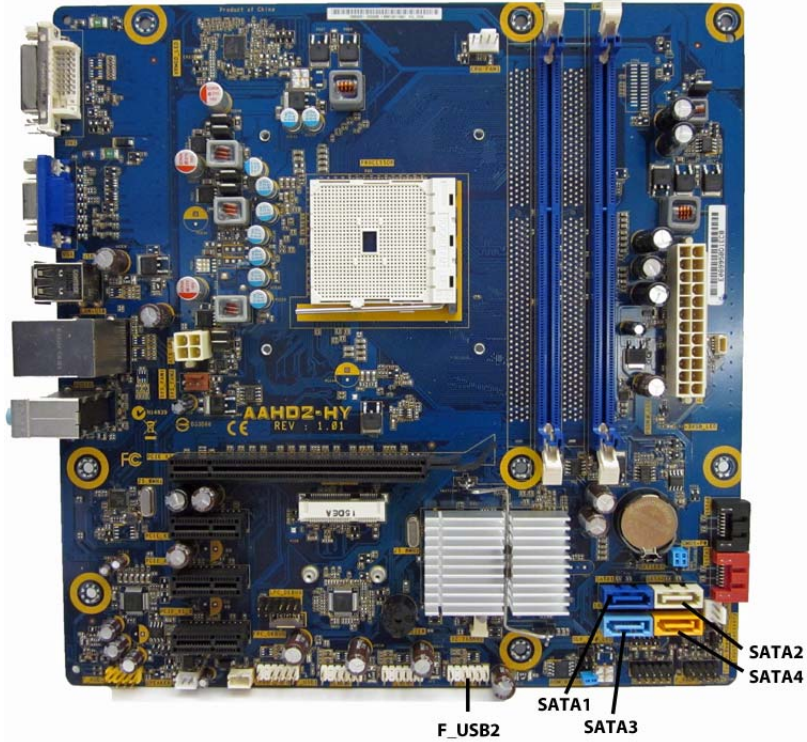

Table 7-7 System Board Drive Connections – Model 3405

System Board Connector	System Board Label	Color
SATA1	SATA1	dark blue
SATA2	SATA2	white
SATA3	SATA3	light blue
SATA4	SATA4	orange
Media Card Reader	F_USB2	white

Removing an Optical Drive

CAUTION: All removable media should be taken out of a drive before removing the drive from the computer.

To remove an optical drive:

1. Prepare the computer for disassembly ([Preparation for Disassembly on page 42](#)).
2. Remove the access panel ([Access Panel on page 43](#)).
3. Remove the front bezel ([Front Bezel on page 44](#)).
4. Disconnect the power and data cables (1) from the rear of the optical drive.
5. Remove the two Torx screws (2) that secure the drive to the computer.
6. Slide the drive out of the computer (3).

Figure 7-15 Removing the optical drive



To install an optical drive, reverse the removal procedures.

Removing a Hard Drive

NOTE: Before you remove the old hard drive, be sure to back up the data from the old hard drive so that you can transfer the data to the new hard drive. Also, if you are replacing the primary hard drive, make sure you have created a Recovery Disc Set to restore the operating system, software drivers, and any software applications that were preinstalled on the computer.

1. Prepare the computer for disassembly ([Preparation for Disassembly on page 42](#)).
2. Remove the access panel ([Access Panel on page 43](#)).
3. Disconnect the power and data cables (1) from the rear of the hard drive.
4. Remove the four Torx screws (2) that secure the drive to the computer.

5. Slide the hard drive toward the bottom of the computer **(3)**, and then remove it from the computer..

Figure 7-16 Removing the hard drive

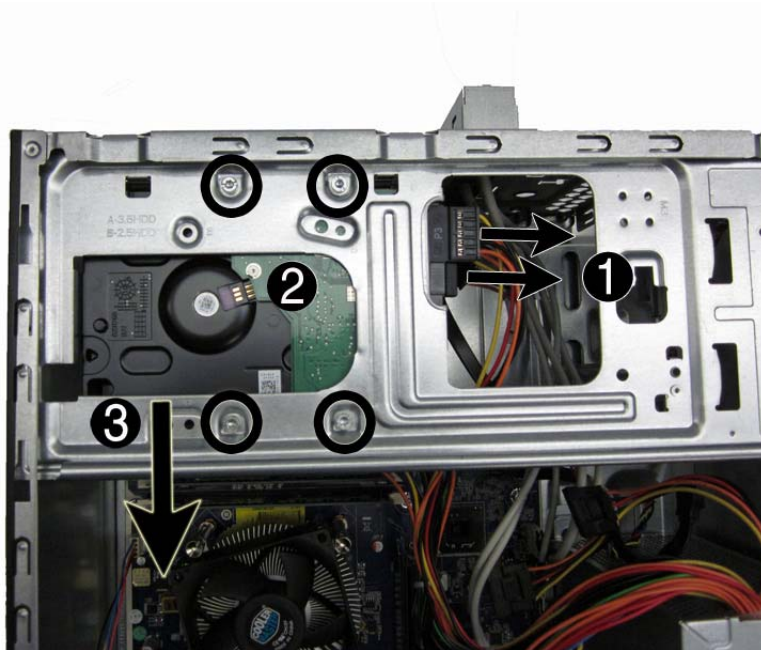

To install a hard drive, reverse the removal procedures.

Front I/O and USB Panel Housing Assembly

Description	Spare part number
Front I/O and USB assembly without card reader	667853-001
Front I/O and USB assembly with card reader	667852-001

1. Prepare the computer for disassembly ([Preparation for Disassembly on page 42](#)).
2. Remove the access panel ([Access Panel on page 43](#)).
3. Lay the computer on its side with the front facing toward you.
4. Remove the front bezel ([Front Bezel on page 44](#)).
5. Remove the cables from the metal clip built into the bottom of the chassis, and then unplug the three cables that connect the assembly to the system board. The assembly cables connect to the following system board connectors:

Table 7-8 Front I/O connectors

HP Pro 3400/3410 models	HP Pro 3405 models
F_AUDIO – yellow connector	F_AUDIO – yellow connector
F_USB2 – white connector	F_USB1 – white connector
F_USB3 – white connector	F_USB4 – white connector

Figure 7-17 Front I/O connectors- HP Pro 3400/3410 models[3400 shown)

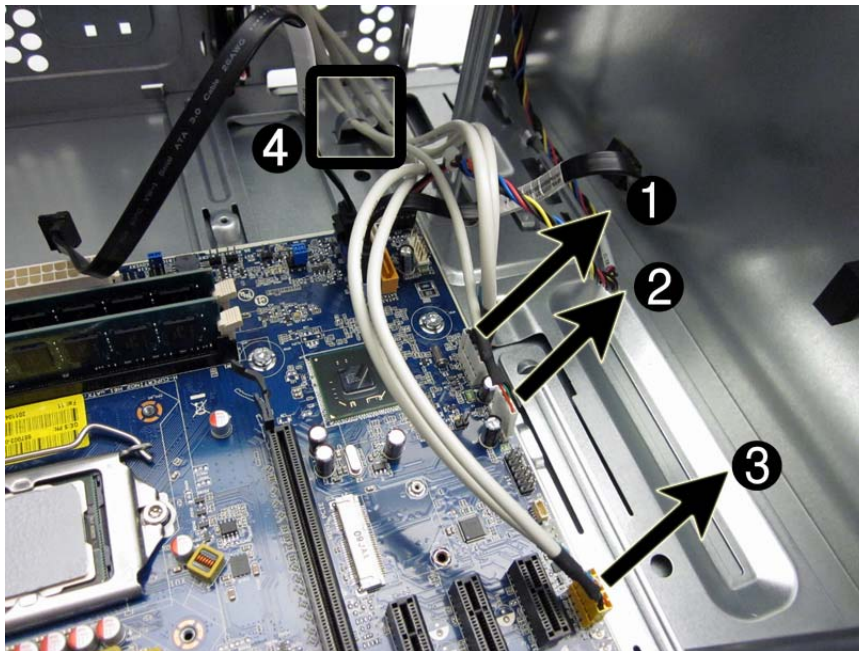
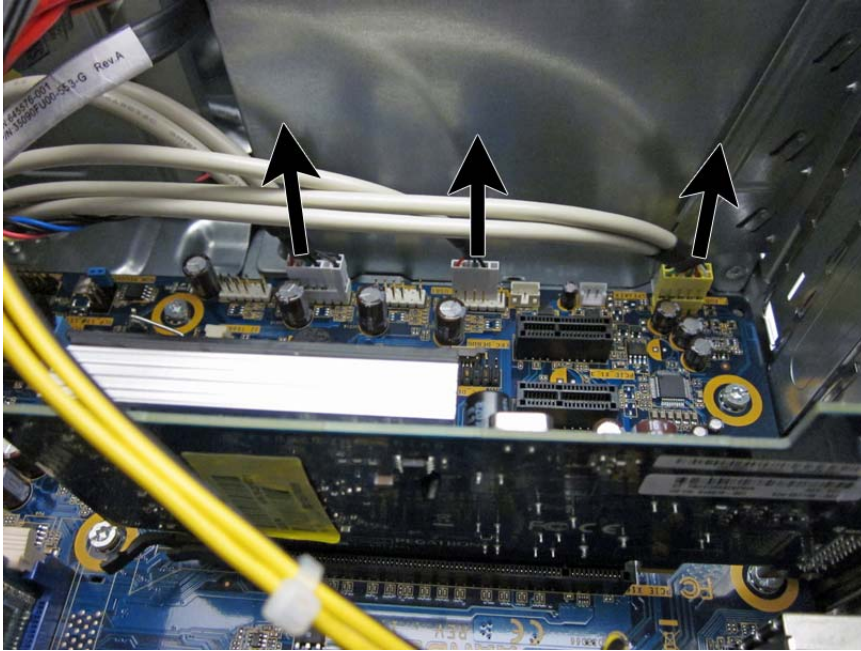

Figure 7-18 Front I/O connectors — HP Pro 3405 models



6. Push in on the lever to the left of the assembly.

Figure 7-19 Front I/O connectors



7. Pull the assembly outward away from the front of the chassis while guiding the cables through the hole in the chassis.

To install the housing assembly, reverse the removal procedures.

When installing the assembly, note that the cable closest to the front of the computer has two separate connectors that plug into the same system board connector.

Figure 7-20 Front I/O connectors

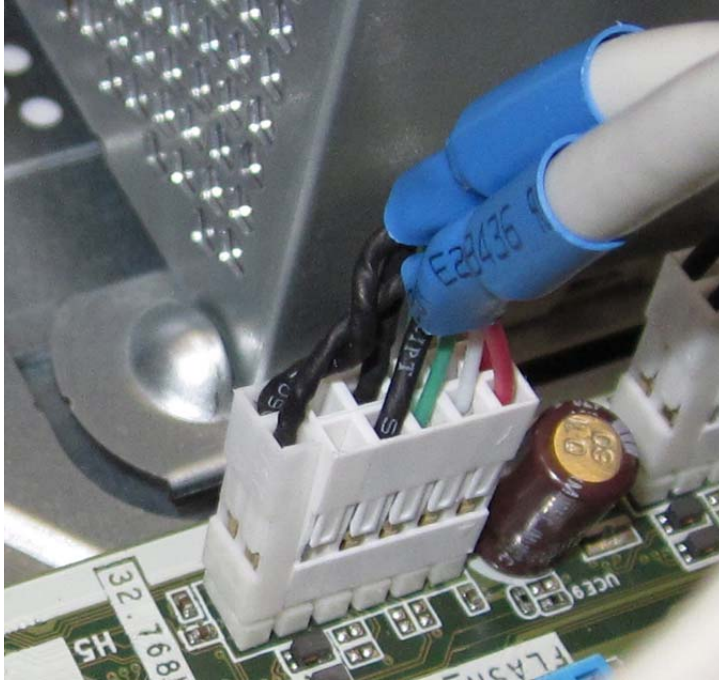

Power Switch/LED Assembly

Description	Spare part number
Power switch/LED assembly	667850-001

1. Prepare the computer for disassembly ([Preparation for Disassembly on page 42](#)).
2. Remove the access panel ([Access Panel on page 43](#)).
3. Remove the front bezel ([Front Bezel on page 44](#)).
4. Remove the optical drive ([Removing an Optical Drive on page 61](#)).
5. Disconnect the braided cables from the black system board connector labeled F_PANEL (1).
6. Remove the cable from the metal clip (2) built into the computer.
7. From the inside of the computer, push up on the tab on the bottom of the assembly (3) to disengage it from the computer.

Figure 7-21 Removing the power switch cable, disengaging the assembly

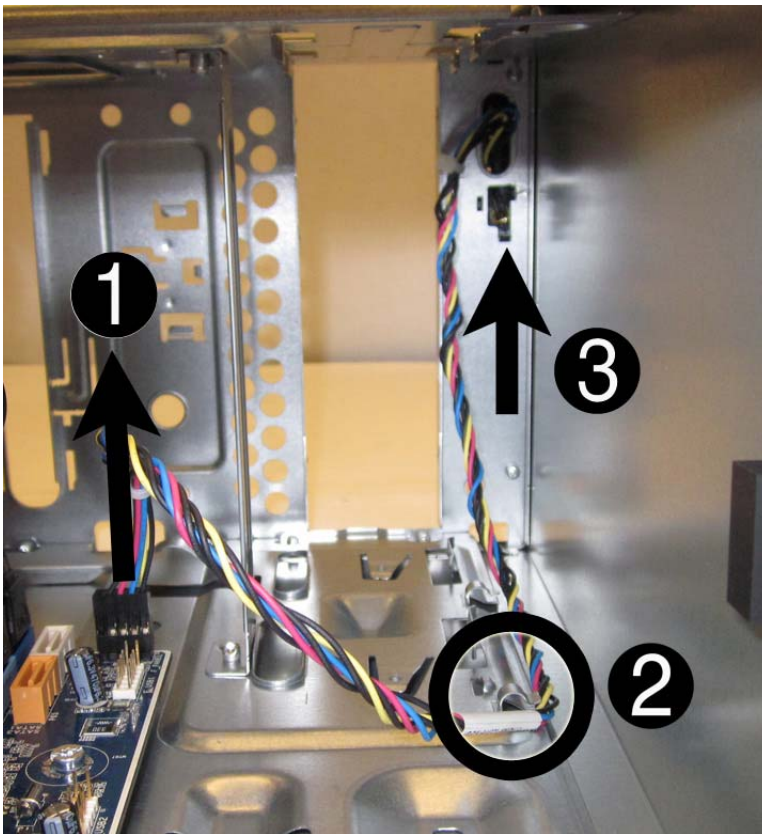

8. Pull the power switch away from the chassis while guiding the wires through the hole in the chassis.

Figure 7-22 Removing the power switch assembly

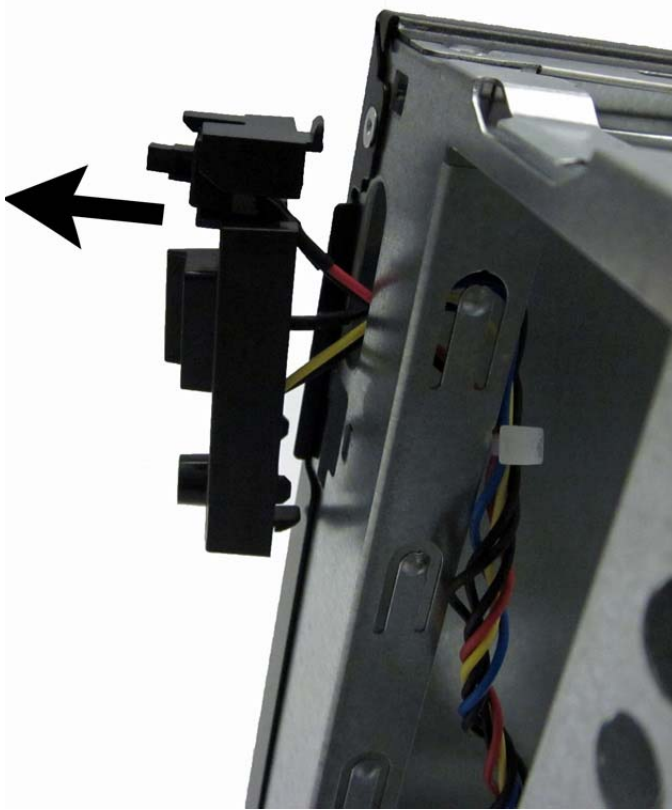

To install the power switch/LED assembly, reverse the removal procedures.

System Fan

Description	Spare part number
Chassis fan for use in EMEA, North American, and Latin American regions; not for Brazil	657103-001
Chassis fan for use in Brazil	514238-001
	434645-001

1. Prepare the computer for disassembly ([Preparation for Disassembly on page 42](#)).
2. Remove the access panel ([Access Panel on page 43](#)).
3. Lay the computer on its side with the rear facing toward you.
4. Remove the three Phillips screws that secure the fan to the chassis.

Figure 7-23 Removing the fan



 **NOTE:** System board appearance may vary.

5. From the inside of the computer, disconnect the cable from the red/brown system board connector labeled SYS_FAN (1), pull the fan into the chassis until it clears the chassis lip, and then lift it out of the chassis (2).

Figure 7-24 Removing the fan

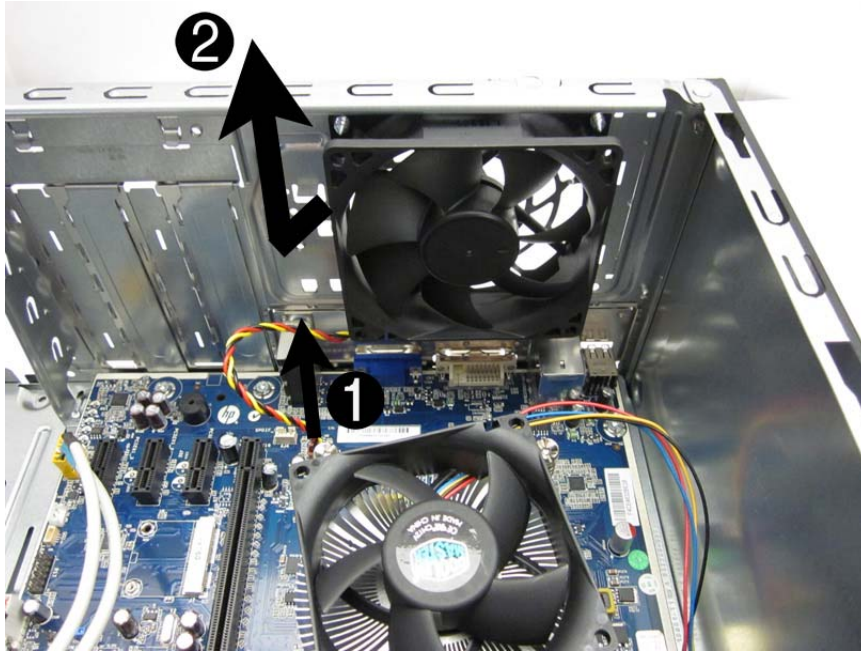

To install the fan, reverse the removal procedures.

Fan Sink Assembly

Description	Spare part number
Fan sink for use in models with Intel processors	667727-001
Fan sink for use in models with AMD processors	657402-001

1. Prepare the computer for disassembly ([Preparation for Disassembly on page 42](#)).
2. Remove the access panel ([Access Panel on page 43](#)).
3. Disconnect the fan sink cable from the white system board connector labeled CPU FAN (HP Pro 3400/3405) or CPU_FAN1 (HP Pro 3410) (1).
4. Loosen the four captive Torx screws (2) that secure the fan sink to the system board.
5. Lift the heat sink from the processor (3) and set it on its side to keep from contaminating the work area with thermal grease.

Figure 7-25 Removing the fan sink

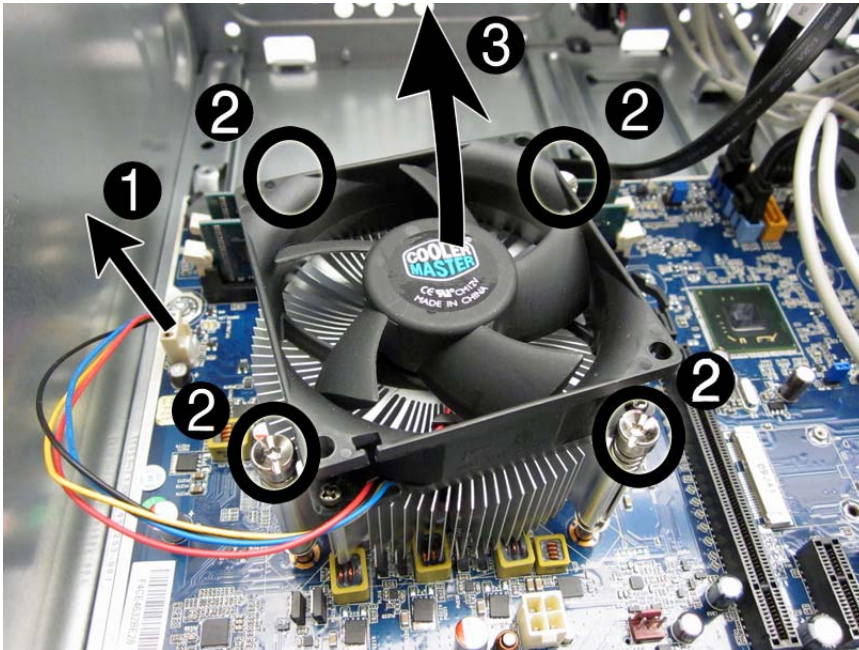

CAUTION: Heat sink retaining screws should be tightened in diagonally opposite pairs (as in an X) to evenly seat the heat sink to the processor. This is especially important as the pins on the socket are very fragile and any damage to them may require replacing the system board.

When reinstalling an existing heat sink, make sure that its bottom has been cleaned with an alcohol wipe and fresh thermal grease has been applied to the top of the processor. New heat sinks come from the factory with fresh thermal grease already applied.

Processor

HP Pro 3400/3410 uses Intel processors. HP Pro 3405 uses AMD processors.

Description	Spare part number
Intel Core i7 processors	
2600S (2.7 GHz, 8-MB L3 cache; not for Brazil)	638419-001
2600 (3.4 GHz, 8-MB L3 cache, 95W)	638632-001
Intel Core i5 processors	
2500 (3.3 GHz, 6-MB L3 cache; not for Brazil)	638631-001
2400 (3.1-GHz, 6-MB L3 cache; not for use in Brazil)	638630-001
2320 (3.0 GHz, 6-MB L3 cache, 95W)	665121-001
2310 (2.9-GHz, 6-MB L3 cache; not for Brazil)	657111-001
2300 (2.8-GHz, 6-MB L3 cache; not for Brazil)	654601-001
Intel Core i3 processors	
2130 (3.4 GHz, 3-MB L3 cache; not for Brazil)	665120-001
2120 (3.3 GHz, 3-MB L3 cache; not for Brazil)	638629-001
2105 (3.1 GHz, 3-MB L3 cache; not for Brazil)	655970-001
2100 (3.1 GHz, 3-MB L3 cache)	638628-001
Intel Pentium Dual-Core processors	
G860 (3.0-GHz, 3-MB L3 cache; not for use in Brazil)	665123-001
G850 (2.9-GHz, 3-MB L3 cache)	655973-001
G840 (2.8-GHz, 3-MB L3 cache; not for Brazil)	655972-001
G630 (2.7-GHz, 3-MB L3 cache; not for use in Brazil)	665122-001
G620 (2.6-GHz, 3-MB L3 cache)	655971-001
Intel Celeron processors:	
G540 (2.5 GHz, 2-MB L3 cache, 65W; not for Brazil)	665119-001
G530 (2.4 GHz, 2-MB L3 cache, 65W; not for Brazil)	665117-001
G440 (1.6 GHz, 1-MB L3 cache, 35W; not for Brazil)	665467-001
AMD A-Series Advanced Processing Units (APU); not for use in Brazil:	
X4 A8-3800 (2.4 GHz, 4-MB L2 cache, 65W; Radeon HD6550D graphics core)	667723-001
X4 A6-3650 (2.6 GHz, 4-MB L2 cache, 100W; Radeon HD6550D graphics core)	667722-001
X4 A6-3600 (2.1 GHz, 4-MB L2 cache, 65W; Radeon HD6530D graphics core)	667724-001
X4 A8-3550 (2.8 GHz, 4-MB L2 cache, 65W; Radeon HD6550D graphics core)	667721-001

Description	Spare part number
X2 A4-3400 (2.7 GHz, 4-MB L2 cache, 65W; Radeon HD6530D graphics core)	667725-001
X2 E2-3200 (2.4 GHz, 1-MB L2 cache, 65W; Radeon HD6370D graphics core)	667726-001

1. Prepare the computer for disassembly ([Preparation for Disassembly on page 42](#)).
2. Remove the access panel ([Access Panel on page 43](#)).
3. Lay the computer on its side with the rear facing toward you.
4. Remove the fan sink ([Fan Sink Assembly on page 70](#)).
5. If removing an AMD processor, skip to step 6. If removing an Intel processor, rotate the locking lever to its full open position (1), raise and rotate the microprocessor retainer to its full open position (2), and then carefully lift the processor from the socket (3).

CAUTION: Do NOT handle the pins in the processor socket. These pins are very fragile and handling them could cause irreparable damage. Once pins are damaged it may be necessary to replace the system board.

CAUTION: The heat sink must be installed within 24 hours of installing the processor to prevent damage to the processor's solder connections.

Figure 7-26 Removing an Intel processor

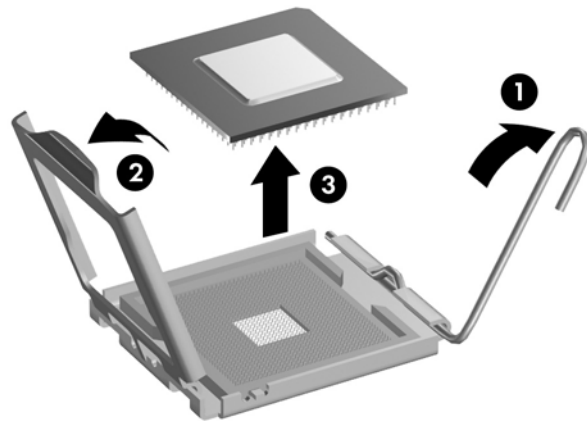

6. If removing an AMD processor, rotate the locking lever to its full open position (1), and then carefully lift the processor from the socket (2).

CAUTION: Do NOT handle the pins in the processor socket. These pins are very fragile and handling them could cause irreparable damage. Once pins are damaged it may be necessary to replace the system board.

CAUTION: The heat sink must be installed within 24 hours of installing the processor to prevent damage to the processor's solder connections.

Figure 7-27 Removing an AMD processor

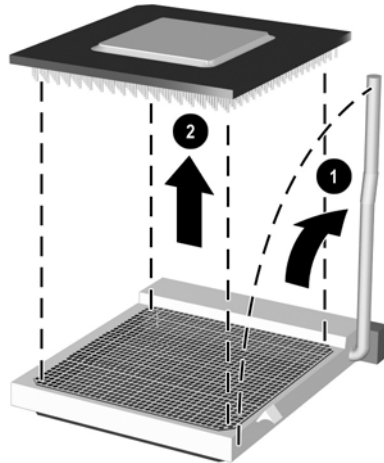

To install a new processor:

1. Place the processor in its socket.
2. If installing an AMD processor, skip to step 3. If installing an Intel processor, close the retainer.
3. Secure the locking lever.
If reusing the existing heat sink, go to step 4.
If using a new heat sink, go to step 7.
4. If reusing the existing heat sink, clean the bottom of the heat sink with the alcohol pad provided in the spares kit.
5. Apply the thermal grease provided in the spares kit to the top of the processor and install the heat sink atop the processor.
6. Go to step 8.

7. If using a new fan sink, remove the protective covering from the bottom of the fan sink and place it in position atop the processor.
8. Secure the fan sink to the system board and system board tray with the 4 captive screws and attach the fan sink control cable to the system board.

 **CAUTION:** Heat sink retaining screws should be tightened in diagonally opposite pairs (as in an X) to evenly seat the heat sink on the processor. This is especially important as the pins on the socket are very fragile and any damage to them may require replacing the system board.

 **NOTE:** After installing a new processor onto the system board, always update the system ROM to ensure that the latest version of the BIOS is being used on the computer. The latest system ROM BIOS can be found on the Web at: <http://h18000.www1.hp.com/support/files>.

Power Supply

Description	Spare part number
Power supply, 300W (Active PFC; not for use in Brazil)	656721-001
Power supply, 300W	664862-001

⚠ WARNING! Voltage is always present on the system board when the computer is plugged into an active AC outlet. To avoid possible personal injury and damage to the equipment the power cord should be disconnected from the computer and/or the AC outlet before opening the computer.

📝 NOTE: When installing a new power supply, be sure to set the red switch to the setting (230 V or 115 V) appropriate for the country in which the computer is used. Spare power supplies normally arrive set for 230 V.

1. Prepare the computer for disassembly ([Preparation for Disassembly on page 42](#)).
2. Remove the access panel ([Access Panel on page 43](#)).
3. Disconnect all power cables from the mass storage devices and from the system board.
4. From the rear of the computer, remove the four Torx screws that secure the power supply to the chassis.

Figure 7-28 Power supply screws



5. Inside of the unit, press the power supply release latch on the chassis base (1).

- Slide the power supply toward the front of the computer (2), then lift the power supply out of the computer (3).

Figure 7-29 Removing the power supply

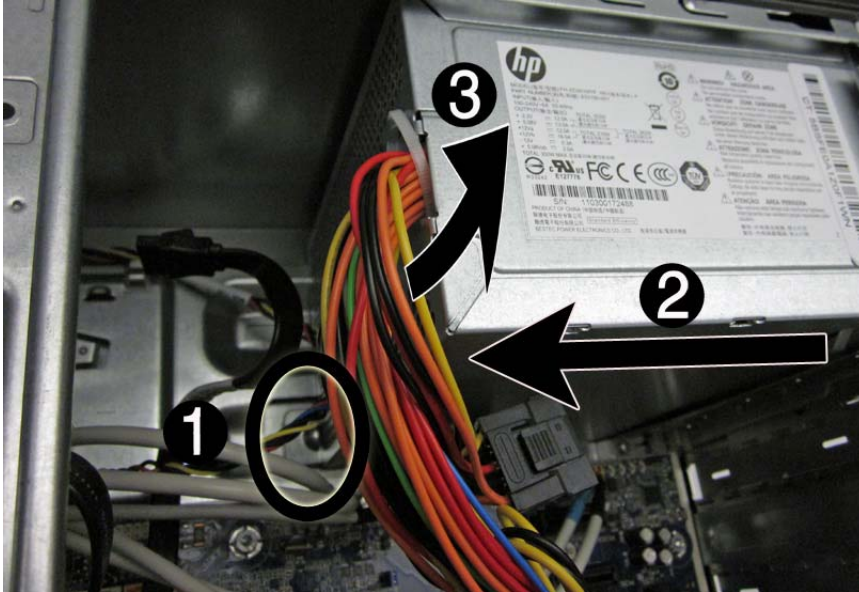

To install the power supply, reverse the removal procedure.

System Board

Description	Spare part number
System board for use in 3400 models with Intel processors (includes thermal material)	660281-001
System board for use in 3410 models with Intel processors in Brazil (includes thermal material)	665223-001
System board for use in 3405 models with AMD processors (includes thermal material)	660155-001

When replacing the system board, be sure that the following components are removed from the defective system board and installed on the replacement system board:

- Memory modules
- Processor
- Expansion cards

To remove the system board:

- Prepare the computer for disassembly ([Preparation for Disassembly on page 42](#)).
- Remove the access panel ([Access Panel on page 43](#)).
- Remove the front bezel ([Front Bezel on page 44](#)).
- Remove any expansion cards ([Expansion Cards on page 49](#)).
- Disconnect all cables from the system board.

6. Remove the six screws that secure the system board to the chassis.

 **NOTE:** HP Pro 3405 is secured with eight screws.

7. Slide the system board toward the front of the chassis, and then lift it up and out of the chassis.

Figure 7-30 Removing the system board (HP Pro 3400 shown)

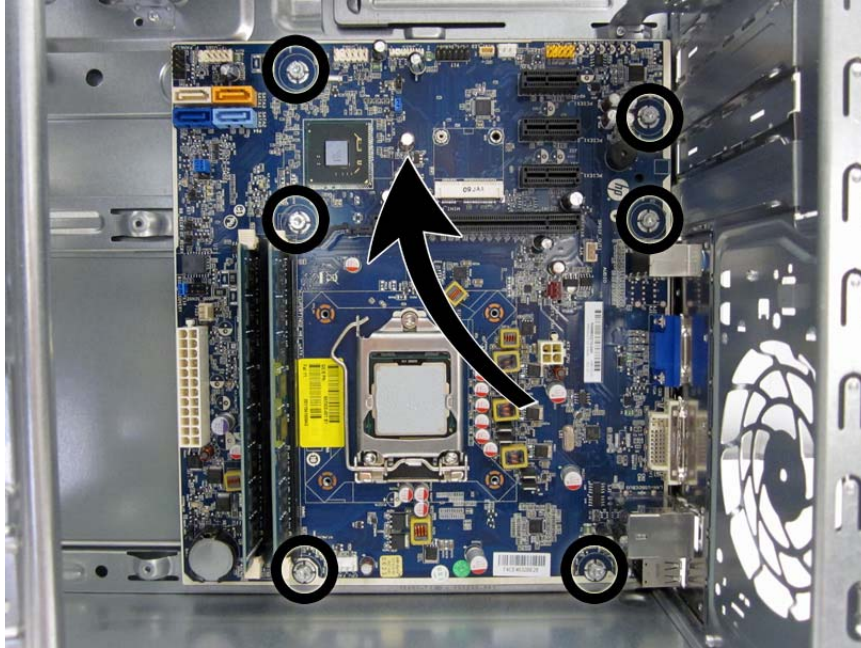

To install the system board, reverse the removal procedure.

 **NOTE:** When replacing the system board, you must also change the chassis serial number in the BIOS.

 **NOTE:** After installing a new system board, always update the system ROM to ensure that the latest version of the BIOS is being used on the computer. The latest system ROM BIOS can be found at: <http://h18000.www1.hp.com/support/files>.

Battery

The battery that comes with your computer provides power to the real-time clock and has a lifetime of about three years. When replacing the battery, use a battery equivalent to the battery originally installed on the computer. The computer comes with a 3-volt lithium coin cell battery.

 **NOTE:** The lifetime of the lithium battery can be extended by plugging the computer into a live AC wall socket. The lithium battery is only used when the computer is NOT connected to AC power.

 **WARNING!** This computer contains an internal lithium manganese dioxide battery. There is a risk of fire and burns if the battery is not handled properly. To reduce the risk of personal injury:

- Do not attempt to recharge the battery.
- Do not expose to temperatures higher than 60°C (140°F)
- Do not disassemble, crush, puncture, short external contacts, or dispose of in fire or water.
- Replace the battery only with the HP/Compaq spare designated for this product.

⚠ CAUTION: Before replacing the battery, it is important to back up the computer CMOS settings. When the battery is removed or replaced, the CMOS settings will be cleared. Refer to the [Troubleshooting Without Diagnostics on page 140](#) chapter for information on backing up the CMOS settings.

📝 NOTE: Batteries, battery packs, and accumulators should not be disposed of together with the general household waste. In order to forward them to recycling or proper disposal, please use the public collection system or return them to HP, its authorized partners, or its agents.

⚠ CAUTION: Static electricity can damage the electronic components of the computer or optional equipment. Before beginning these procedures, ensure that you are discharged of static electricity by briefly touching a grounded metal object.

1. Prepare the computer for disassembly ([Preparation for Disassembly on page 42](#)).
2. Remove the access panel ([Access Panel on page 43](#)).

📝 NOTE: It may be necessary to remove an expansion card to gain access to the battery.

3. Locate the battery and battery holder on the system board.
4. To release the battery from its holder, squeeze the metal clamp that extends above one edge of the battery. When the battery pops up, lift it out (1).
5. To insert the new battery, slide one edge of the replacement battery under the holder's lip with the positive side up (2). Push the other edge down until the clamp snaps over the other edge of the battery.

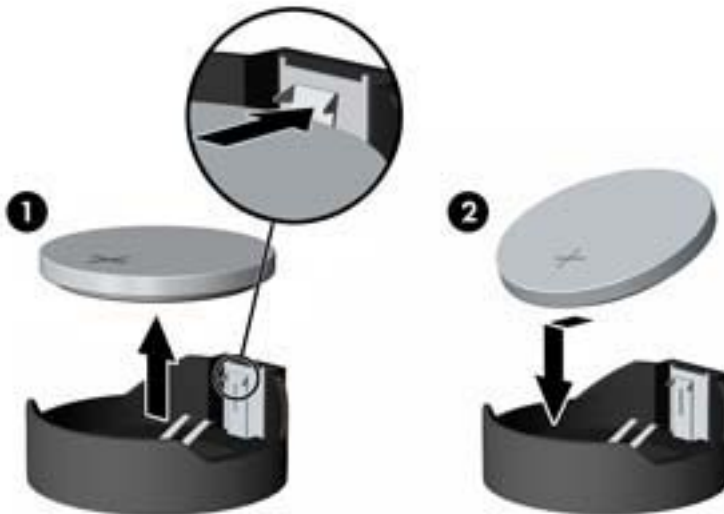

6. Replace the computer access panel.
7. Plug in the computer and turn on power to the computer.
8. Reset the date and time, your passwords, and any special system setups, using Computer Setup. Refer to [Computer Setup \(F10\) Utility on page 7](#).

8 Removal and Replacement Procedures – Small Form Factor (SFF) Chassis

Adherence to the procedures and precautions described in this chapter is essential for proper service. After completing all necessary removal and replacement procedures, run the Diagnostics utility to verify that all components operate properly.

 **NOTE:** Not all features listed in this guide are available on all computers.

Preparation for Disassembly

See [Routine Care and Disassembly Preparation on page 35](#) for initial safety procedures.

1. Remove/disengage any security devices that prohibit opening the computer.
2. Close any open software applications.
3. Exit the operating system.
4. Remove any compact disc or media card from the computer.
5. Turn off the computer and any peripheral devices that are connected to it.

 **CAUTION:** Turn off the computer before disconnecting any cables.

Regardless of the power-on state, voltage is always present on the system board as long as the system is plugged into an active AC outlet. In some systems the cooling fan is on even when the computer is in the “Standby,” or “Suspend” modes. The power cord should always be disconnected before servicing a unit.

6. Disconnect the power cord from the electrical outlet and then from the computer.
7. Disconnect all peripheral device cables from the computer.

 **NOTE:** During disassembly, label each cable as you remove it, noting its position and routing. Keep all screws with the units removed.

 **CAUTION:** The screws used in the computer are of different thread sizes and lengths; using the wrong screw in an application may damage the unit.

Access Panel

Description	Spare part number
Access panel	656832-001

1. Prepare the computer for disassembly ([Preparation for Disassembly on page 79](#)).
2. If the computer is on a stand, remove the computer from the stand.
3. Remove the Torx screw that secures the access panel to the computer.

Figure 8-1 Removing the access panel screw



4. Slide the access panel toward the back of the computer, and then pull it away from the computer.

Figure 8-2 Removing the access panel



To install the access panel, reverse the removal procedure.

Front Bezel

Description	Spare part number
Front bezel	656835-001

1. Prepare the computer for disassembly ([Preparation for Disassembly on page 79](#)).
2. Remove the access panel ([Access Panel on page 80](#)).
3. Lift up the three tabs on the top of the bezel.

Figure 8-3 Removing the front bezel

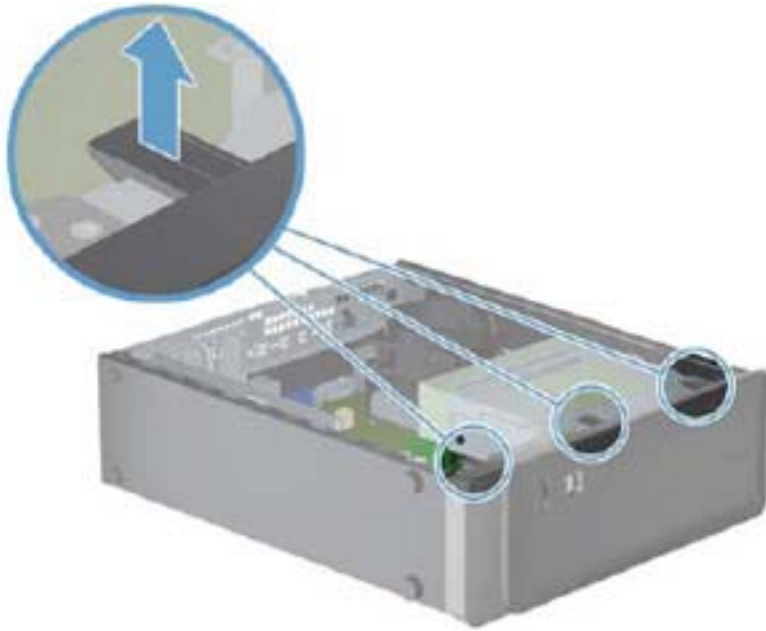

4. Rotate the bezel off the chassis.

Figure 8-4 Removing the front bezel

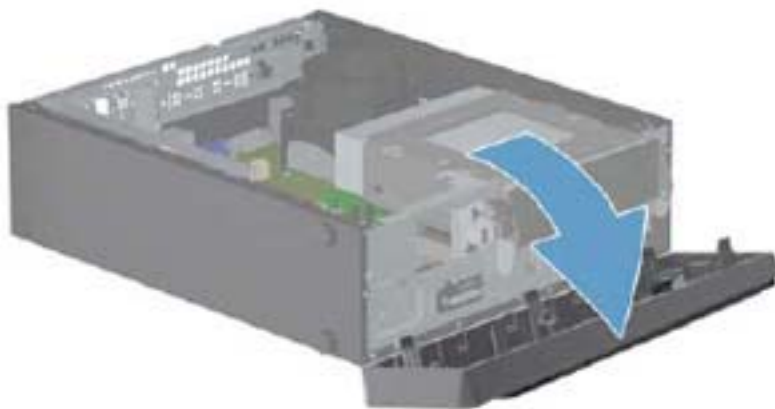

To install the front bezel, reverse the removal procedure.

Memory

Description	Spare part number
4-GB, PC3-10600	585157-001
2-GB, PC3-10600	635803-001
1-GB, PC3-10600	635802-001

The computer comes with double data rate 3 synchronous dynamic random access memory (DDR3-SDRAM) dual inline memory modules (DIMMs).

DDR3-SDRAM DIMMs

The memory sockets on the system board can be populated with up to two DIMMs.

These memory sockets are populated with at least one preinstalled DIMM. To achieve the maximum memory support, you can populate the system board with up to 8 GB of memory:

For proper system operation, the DDR3-SDRAM DIMMs must be:

- industry-standard 240-pin
- unbuffered non-ECC PC3-10600 DDR3-1333 MHz-compliant
- 1.5 volt DDR3-SDRAM DIMMs

The DDR3-SDRAM DIMMs must also:

- support CAS latency 9 DDR3 1333 MHz (9-9-9 timing)
- contain the mandatory JEDEC SPD information

In addition, the computer supports:

- 512-Mbit, 1-Gbit, and 2-Gbit non-ECC memory technologies
- single-sided and double-sided DIMMs
- DIMMs constructed with x8 and x16 DDR devices; DIMMs constructed with x4 SDRAM are not supported



NOTE: The system will not operate properly if you install unsupported DIMMs.

Populating DIMM Sockets

There are two DIMM sockets on the system board, with one socket per channel.

Populate the DIMM sockets in the following order: Channel A then Channel B

Figure 8-5 DIMM Socket Locations

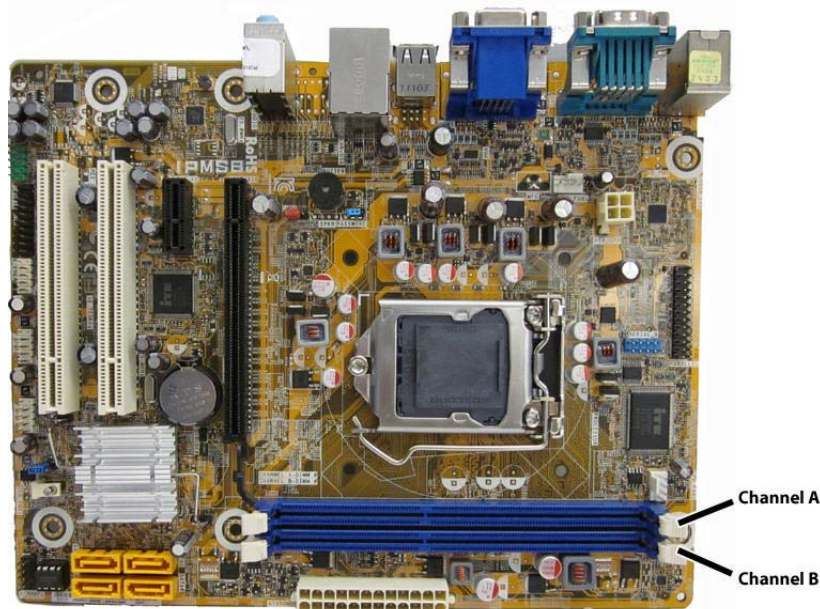

Table 8-1 DIMM Socket Locations

Description	Socket Color	Insertion Order
Channel A (populate first)	Blue	1
Channel B	Blue	2

NOTE: A DIMM must occupy the Channel A socket.

- The system will operate in single channel mode if the DIMM sockets are populated in one channel only.
- The system will operate in a higher-performing dual channel mode if the total memory capacity of the DIMM in Channel A is equal to the total memory capacity of the DIMM in Channel B. The technology and device width can vary between the channels. For example, if Channel A is populated with one 2-GB DIMMs and Channel B is populated with one 2-GB DIMM, the system will operate in dual channel mode.
- The system will operate in flex mode if the total memory capacity of the DIMM in Channel A is not equal to the total memory capacity of the DIMM in Channel B. In flex mode, the channel populated with the least amount of memory describes the total amount of memory assigned to dual channel and the remainder is assigned to single channel. For optimal speed, the channels should be balanced so that the largest amount of memory is spread between the two channels. If one channel will have more memory than the other, the larger amount should be assigned to Channel A. For example, if you are populating the sockets with one 2-GB DIMM, and one 1-GB DIMMs, Channel A should be populated with the 2-GB DIMM, and Channel B should be

populated with the 1-GB DIMM. With this configuration, 2 GB will run as dual channel and 1 GB will run as single channel.

- In any mode, the maximum operational speed is determined by the slowest DIMM in the system.

The system will automatically operate in single channel mode, dual channel mode, or flex mode, depending on how the DIMMs are installed.

Removing DIMMs

CAUTION: You must disconnect the power cord and wait approximately 30 seconds for the power to drain before adding or removing memory modules. Regardless of the power-on state, voltage is always supplied to the memory modules as long as the computer is plugged into an active AC outlet. Adding or removing memory modules while voltage is present may cause irreparable damage to the memory modules or system board.

The memory module sockets have gold-plated metal contacts. When upgrading the memory, it is important to use memory modules with gold-plated metal contacts to prevent corrosion and/or oxidation resulting from having incompatible metals in contact with each other.

Static electricity can damage the electronic components of the computer or optional cards. Before beginning these procedures, ensure that you are discharged of static electricity by briefly touching a grounded metal object. For more information, refer to [Electrostatic Discharge Information on page 35](#).

When handling a memory module, be careful not to touch any of the contacts. Doing so may damage the module.

1. Prepare the computer for disassembly ([Preparation for Disassembly on page 79](#)).
2. Remove the access panel ([Access Panel on page 80](#)).
3. Remove the front bezel ([Front Bezel on page 82](#)).
4. Rotate the optical drive to its upright position.

Figure 8-6 Rotating the optical drive

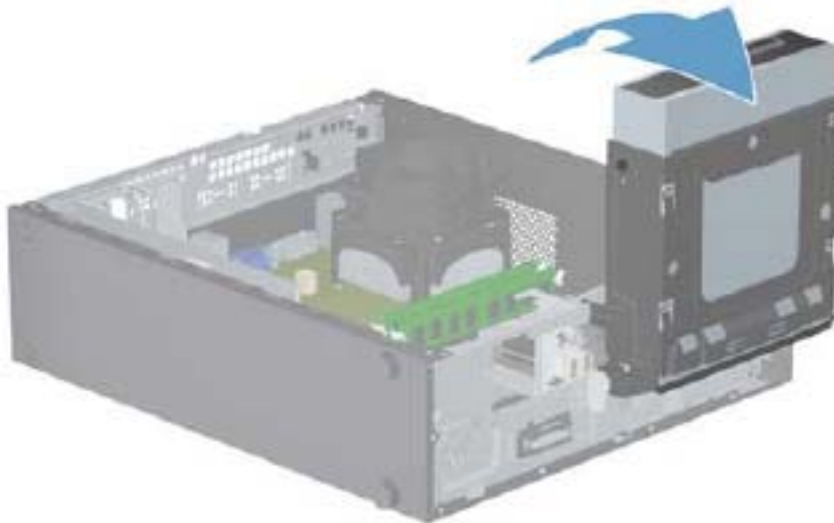

5. Open both latches of the memory module socket (1), and remove the memory module from the socket (2).

Figure 8-7 Removing a DIMM

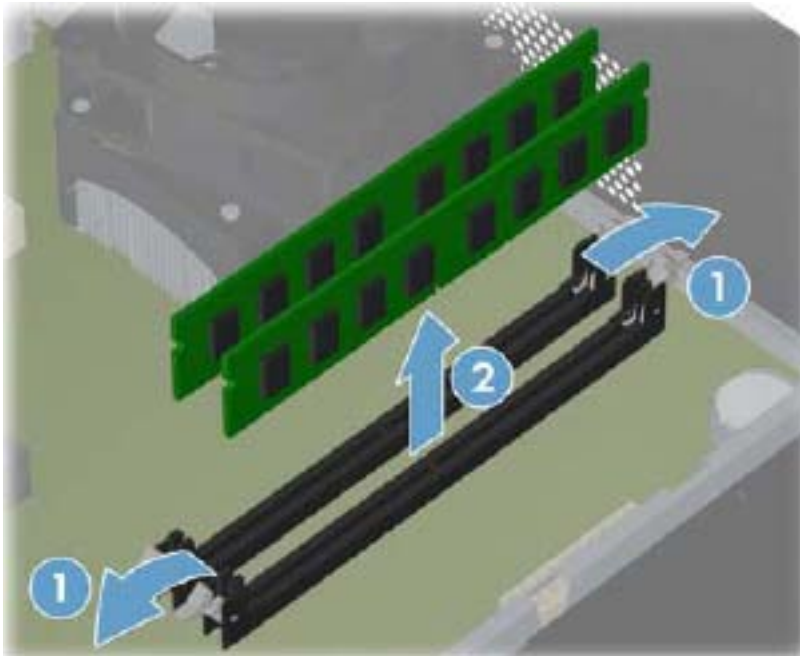



 **NOTE:** A memory module can be installed in only one way. Match the notch on the module with the tab on the memory socket.

For maximum performance, populate the sockets so that the memory capacity is spread as equally as possible between Channel A and Channel B.

6. To install a memory module, holding the module by the edges, completely slide it into the slot. Make sure the module is pressed completely into the socket, and then gently push down on the module until it snaps in place.

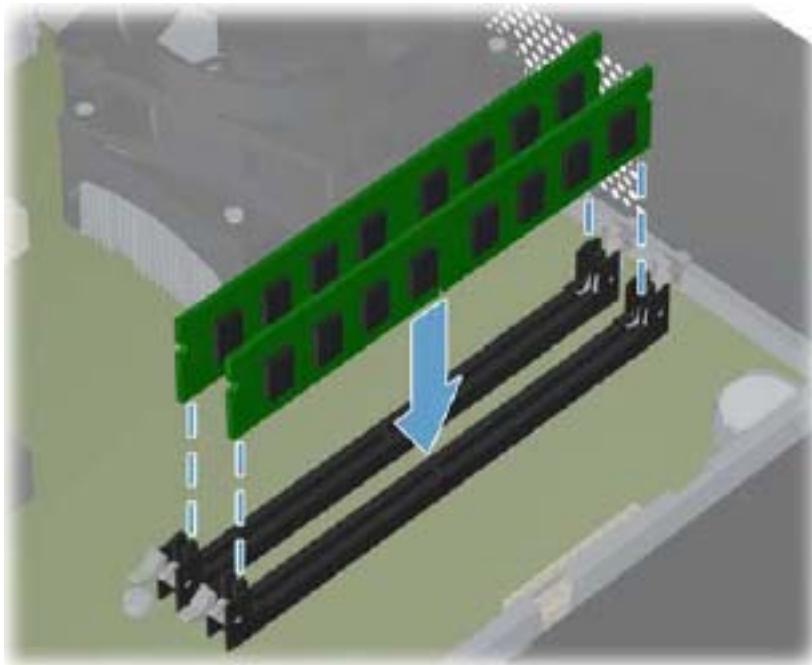
Figure 8-8 Installing a DIMM



 **NOTE:** A memory module can be installed in only one way. Match the notch on the module with the tab on the memory socket.

For maximum performance, populate the sockets so that the memory capacity is spread as equally as possible between Channel A and Channel B.

The computer should automatically recognize the additional memory the next time you turn on the computer.

Expansion Card

Description	Spare part number
Graphics cards	
nVidia GeForce GT530 2-GB graphics adapter	659354-001
nVidia GeForce 405 PCIe x16 graphics card, 1 GB	656789-001
ATI Radeon HD6570 1-GB graphics adapter	659355-001
ATI Radeon HD6450 PCIe x16 graphics card, 1 GB	647451-001
ATI Radeon HD6450 PCIe x16 graphics card, 512 MB	647450-001

The HP Pro 3410 SFF has one PCIe x16 expansion slot, one PCIe x1 expansion slots, and two PCI 2.2 slots.

Figure 8-9 Expansion Slot Locations

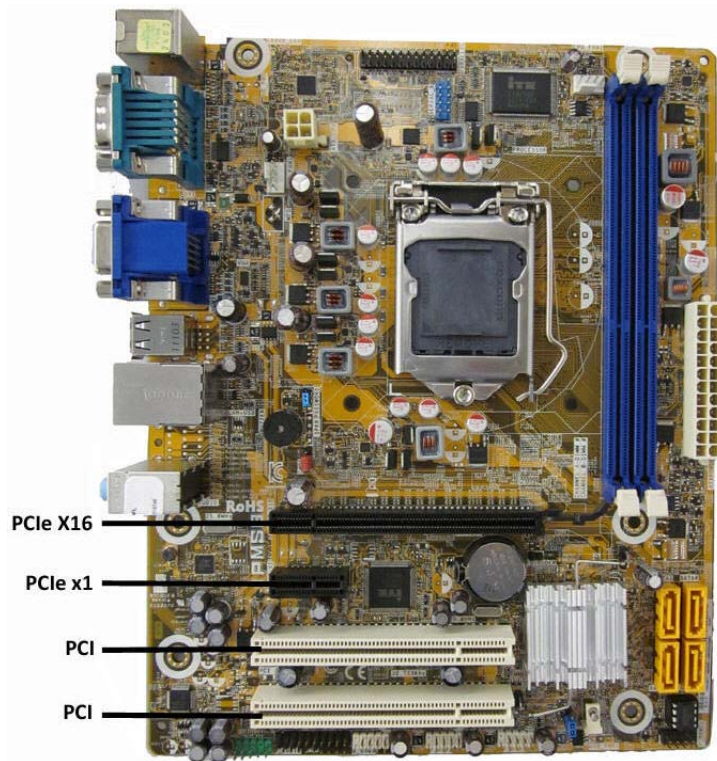

NOTE: Board appearance and color may vary.

NOTE: You can install a PCI Express x1, x4, x8, or x16 expansion card in the PCI Express x16 expansion slot.

Table 8-2 Expansion Slots

Item	Description
PCIe X16	PCI Express x16 expansion slot

Table 8-2 Expansion Slots (continued)

Item	Description
PCIe x1	PCIe x1 expansion slot
PCI	PCI expansion slot
PCI	PCI expansion slot

To remove, replace, or add an expansion card:

1. Prepare the computer for disassembly ([Preparation for Disassembly on page 79](#)).
2. Remove the access panel ([Access Panel on page 80](#)).
3. Locate the correct vacant expansion socket on the system board and the corresponding expansion slot on the back of the computer chassis.
4. Release the slot cover bracket by removing the screw that secures the bracket, and then lifting the bracket off the computer.

Figure 8-10 Opening the expansion slot bracket



5. Before installing an expansion card, remove the expansion slot cover or the existing expansion card.



NOTE: Before removing an installed expansion card, disconnect any cables that may be attached to the expansion card.

- a. If you are installing an expansion card in a vacant socket, remove the appropriate expansion slot cover on the back of the chassis. Pull the slot cover straight up then away from the inside of the chassis.

- b. If you are removing a PCI Express x16 card, pull the retention arm on the back of the expansion socket away from the card and carefully rock the card back and forth until the connectors pull free from the socket. Pull the expansion card straight up from the socket then away from the inside of the chassis to release it from the chassis frame. Be sure not to scrape the card against the other components.



 **NOTE:** PCI cards and PCI Express x1 cards do not have the retention arm. PCI Express X16 card is shown below.

Figure 8-11 Removing a standard PCI expansion card



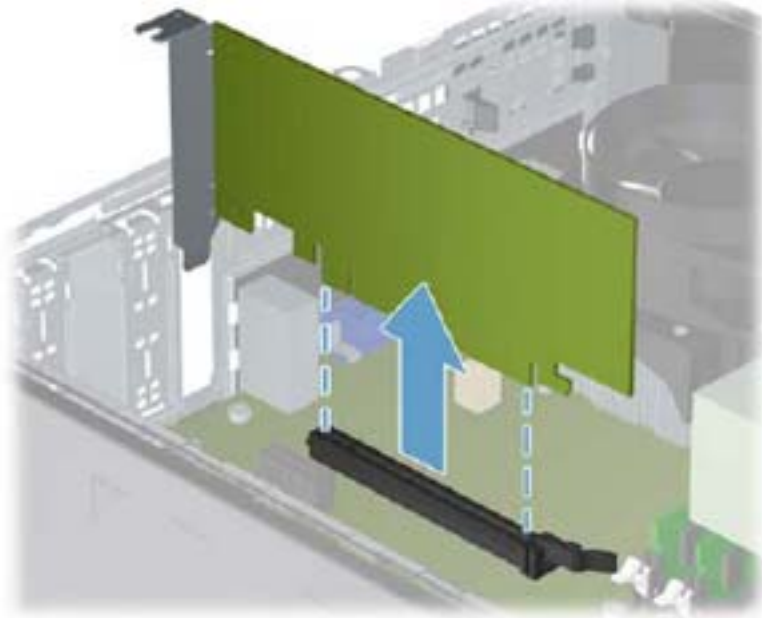

6. Store the removed card in anti-static packaging.
7. If you are not installing a new expansion card, install an expansion slot cover to close the open slot.

 **CAUTION:** After removing an expansion card, you must replace it with a new card or expansion slot cover for proper cooling of internal components during operation.

8. To install a new expansion card, hold the card just above the expansion socket on the system board then move the card toward the rear of the chassis so that the bracket on the card is aligned with the open slot on the rear of the chassis. Press the card straight down into the expansion socket on the system board.

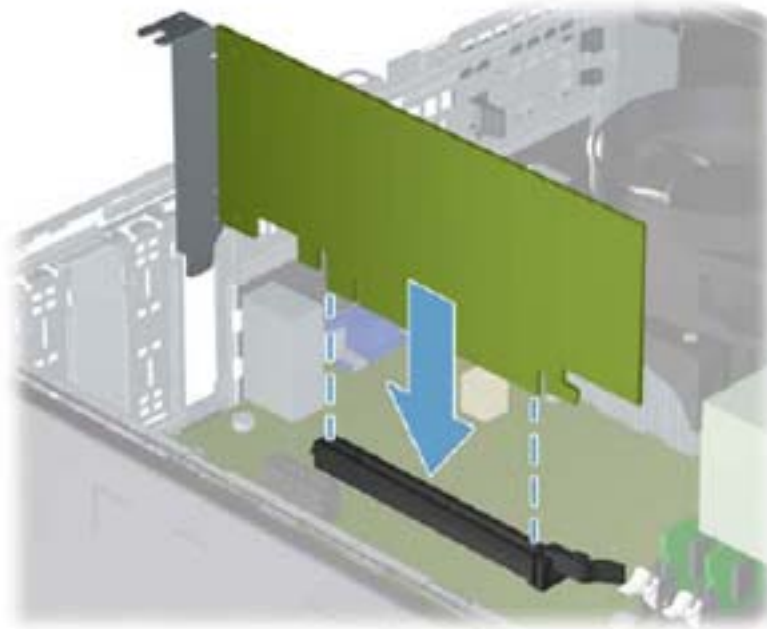
Figure 8-12 Installing an expansion card



 **NOTE:** When installing an expansion card, press firmly on the card so that the whole connector seats properly in the expansion card slot.

9. Reattach the bracket to the back of the computer

Figure 8-13 Replacing the expansion slot bracket



10. Connect external cables to the installed card, if needed. Connect internal cables to the system board, if needed.
11. Reconfigure the computer, if necessary.

Cable Management

Always follow good cable management practices when working inside the computer.

- Keep cables away from major heat sources like the heat sink.
- Do not jam cables on top of expansion cards or memory modules. Printed circuit cards like these are not designed to take excessive pressure on them.
- Some flat ribbon cables come prefolded. Never change the folds on these cables.
- Never bend a SATA data cable tighter than a 30 mm (1.18 in) radius.
- Never crease a SATA data cable.
- Do not rely on components like the drive cage, power supply, or computer cover to push cables down into the chassis. Always position the cables to lay properly by themselves.

When removing the power supply power cable from the P1 connector on the system board, always follow these steps:

1. Squeeze on the top of the retaining latch attached to the cable end of the connector **(1)**.
2. Grasp the cable end of the connector and pull it straight up **(2)**.

⚠ CAUTION: Always pull the connector - NEVER pull on the cable. Pulling on the cable could damage the cable and result in a failed power supply.

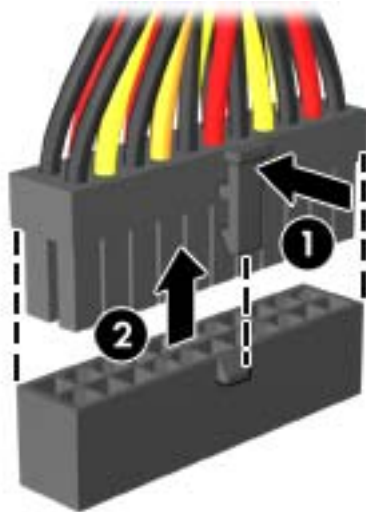

Cable Connections

System board connectors are color-coded to make it easier to find the proper connection.

Connector Name	Connector Color	Description
ATX_POWER	white	Power supply, 24-pin
ATX_CPU	white	Power supply, 4-pin
SYS_FAN	brown	Chassis fan
CPU_FAN1	white	Heat sink fan
F_PANEL	black	Power switch
F_AUDIO	yellow	Front I/O audio
F_USB1	white	Media card reader
F_USB2	white	Front I/O USB
F_USB3	white	Front I/O USB
SATA0	dark blue	Primary hard drive
SATA1	white	Primary optical drive
SATA2	light blue	Second hard drive
SATA3	orange	Second optical drive

Drives

Description	Spare part number
16X SATA DVD±RW drive	581600-001
16X SATA DVD±RW drive	581600-001
2 TB, 7200 rpm SATA hard drive	616608-001
1.5 TB, 7200 rpm SATA hard drive	613209-001
1 TB, 7200 rpm SATA hard drive	621418-001
750 GB, 7200 rpm SATA hard drive	632938-001
500 GB, 7200 rpm SATA hard drive	621421-001
320 GB, 7200 rpm SATA hard drive, 2.5-inch	621420-001

Drive Positions

Figure 8-14 Drive positions

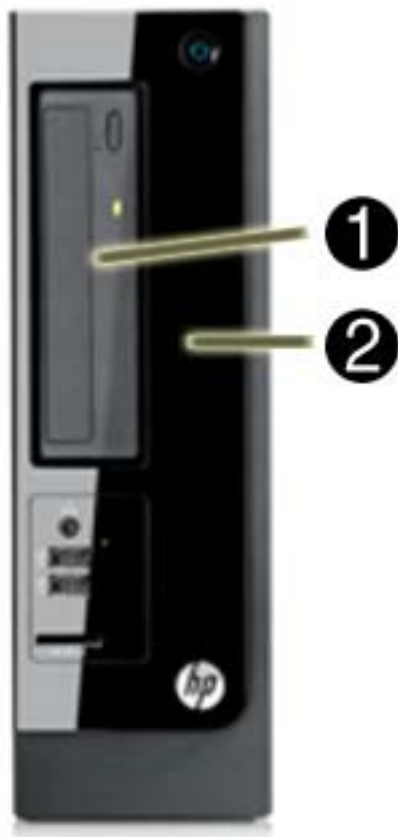

Table 8-3 Drive Positions

1	5.25-inch external drive bay for an optical drive
2	3.5-inch internal drive bay for a hard drive

To verify the type and size of the storage devices installed in the computer, run Computer Setup.

Removing Drives

When installing drives, follow these guidelines:

- The primary Serial ATA (SATA) hard drive must be connected to the dark blue primary SATA connector on the system board labeled SATA0.
- Connect an optical drive to the light blue SATA connector on the system board labeled SATA2.
- The power cables for the SATA drives connect directly to the power supply. The primary hard drive connects to the power connector labeled P4. the primary optical drive connects to the power connector labeled P3.
- The system does not support Parallel ATA (PATA) optical drives or PATA hard drives.

 **CAUTION:** To prevent loss of work and damage to the computer or drive:

If you are inserting or removing a drive, shut down the operating system properly, turn off the computer, and unplug the power cord. Do not remove a drive while the computer is on or in standby mode.

Before handling a drive, ensure that you are discharged of static electricity. While handling a drive, avoid touching the connector. For more information about preventing electrostatic damage, refer to [Electrostatic Discharge Information on page 35](#).

Handle a drive carefully; do not drop it.

Do not use excessive force when inserting a drive.

Avoid exposing a hard drive to liquids, temperature extremes, or products that have magnetic fields such as monitors or speakers.

If a drive must be mailed, place the drive in a bubble-pack mailer or other protective packaging and label the package "Fragile: Handle With Care."

Removing an Optical Drive

 **CAUTION:** All removable media should be taken out of a drive before removing the drive from the computer.

1. Prepare the computer for disassembly ([Preparation for Disassembly on page 79](#)).
2. Remove the access panel ([Access Panel on page 80](#)).
3. Remove the front bezel ([Front Bezel on page 82](#)).
4. Rotate the drive cage to its upright position.

5. If removing an optical drive, disconnect the cables from the rear of the drive.

Figure 8-15 Removing the drive cables

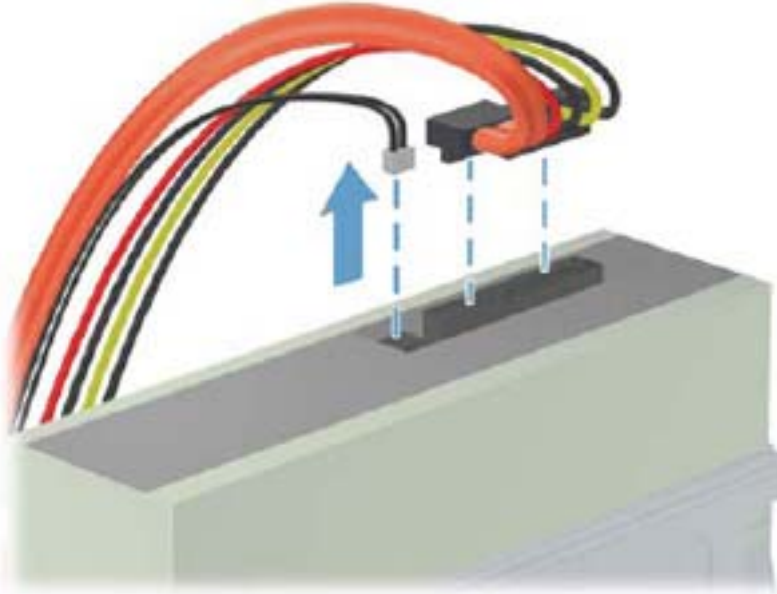

6. Remove the Torx screw from the cage.

Figure 8-16 Removing the optical drive screw

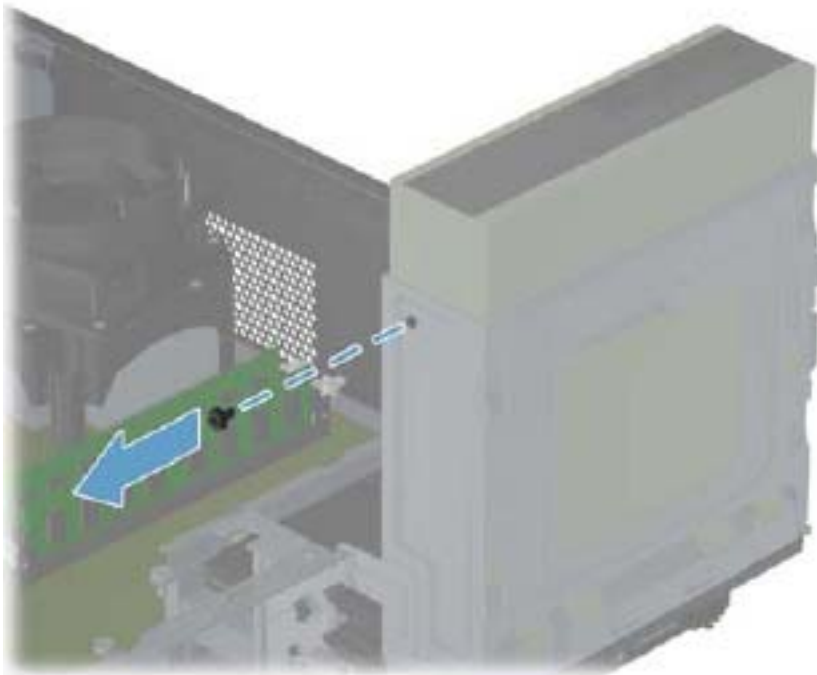

7. Return the drive to its normal position.

8. Push the optical drive from behind, and then remove it from the front of the computer.

Figure 8-17 Removing the optical drive



Removing the Hard Drive

 **NOTE:** Before you remove the old hard drive, be sure to back up the data from the old hard drive so that you can transfer the data to the new hard drive.

The preinstalled 3.5-inch hard drive is located under the power supply. To remove and replace the hard drive:

1. Prepare the computer for disassembly ([Preparation for Disassembly on page 79](#)).
2. Remove the access panel ([Access Panel on page 80](#)).
3. Remove the front bezel ([Front Bezel on page 82](#)).
4. Rotate the drive cage to its upright position.

5. On the front of the computer, pull and hold the hard drive release latch to unlock the hard drive.

Figure 8-18 Pulling the hard drive release latch

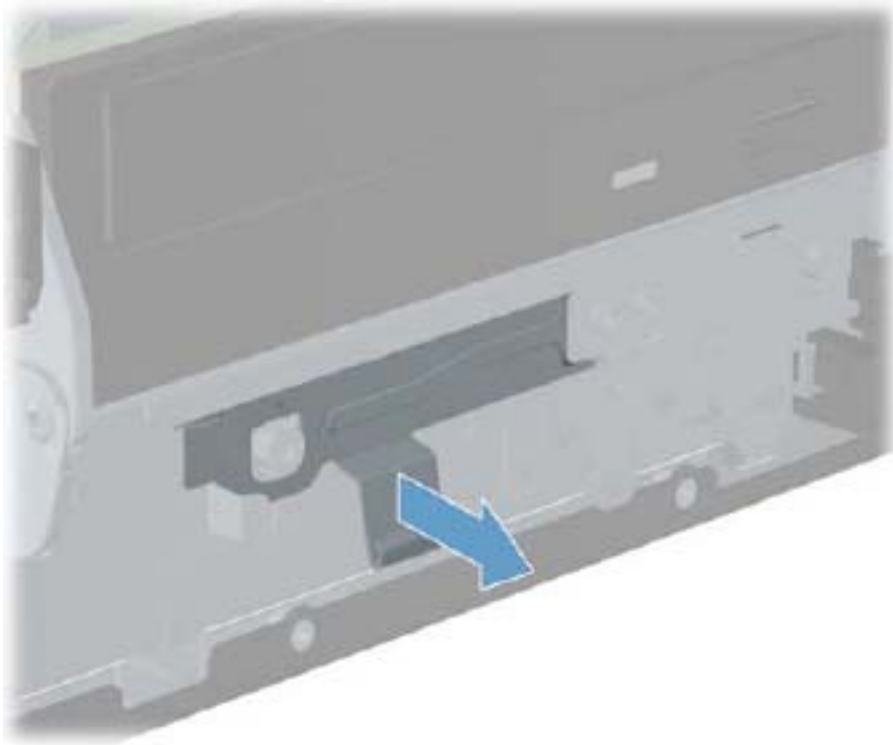

6. With the release latch pulled out, lift the rear of the hard drive.

Figure 8-19 Lifting the hard drive

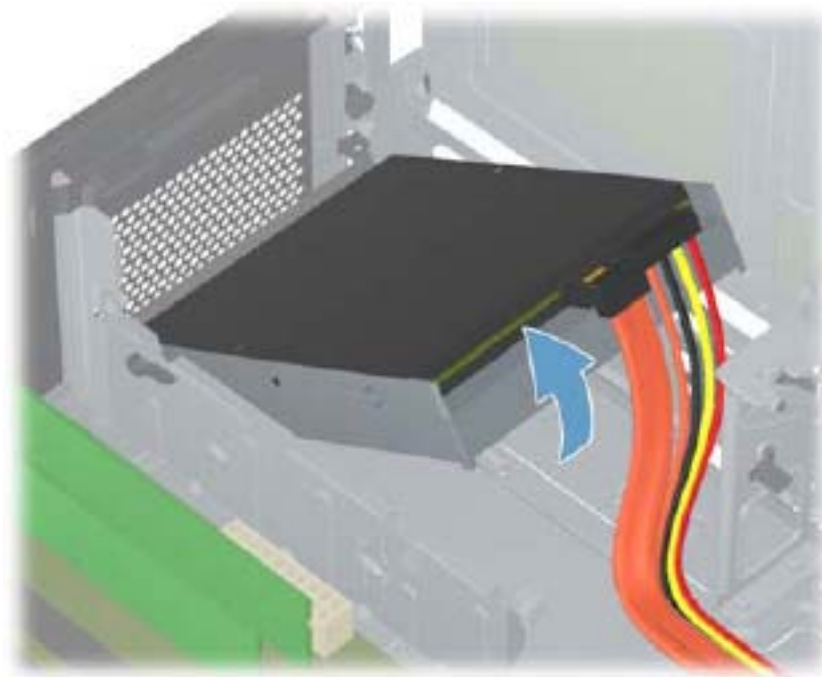

7. Disconnect the cables from the rear of the hard drive.

Figure 8-20 Disconnecting the hard drive cables

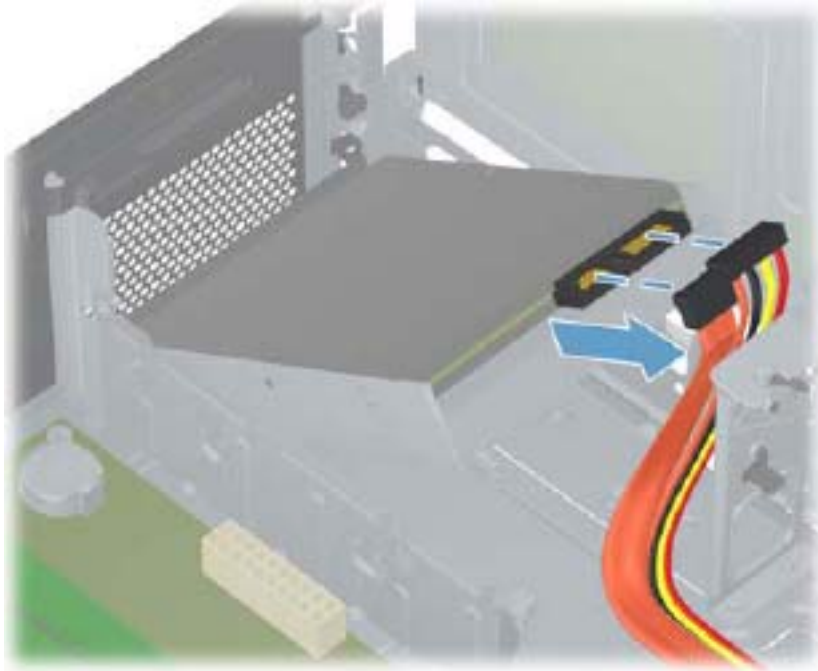

8. Remove the hard drive from the computer.

Figure 8-21 Removing the hard drive

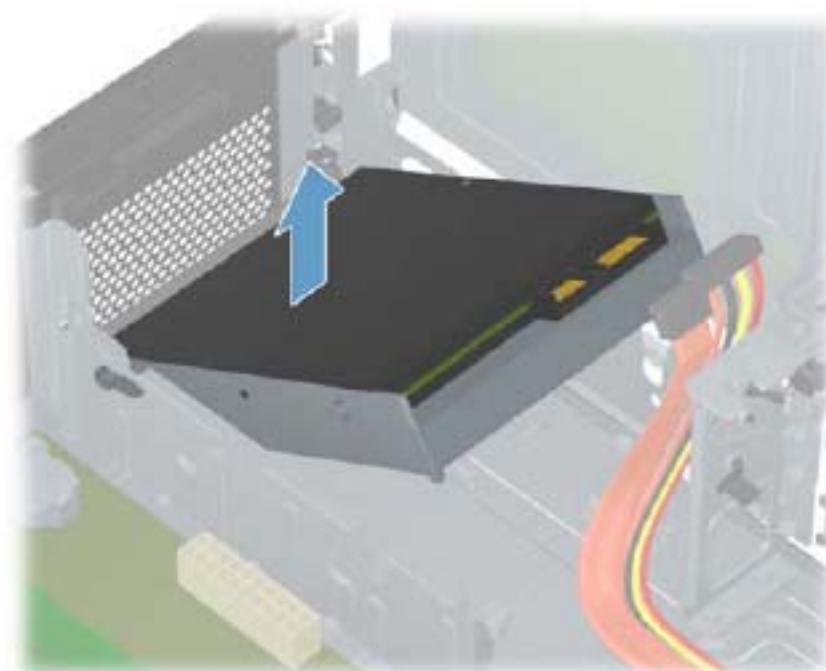

9. Remove the four guide screws from the hard drive for use in the replacement hard drive.

Figure 8-22 Removing the hard drive guide screws



To replace the hard drive, reverse the removal procedures.

Power Switch

Description	Spare part number
Power switch/LED assembly	656984-001

The power switch is attached to the front of the chassis using tabs (no screws). Its cable routes through metal tabs in the chassis floor. The power switch cable connects to the front USB assembly cable.

1. Prepare the computer for disassembly ([Preparation for Disassembly on page 79](#)).
2. Remove the access panel ([Access Panel on page 80](#)).
3. Remove the front bezel ([Front Bezel on page 82](#)).
4. From the inside of the computer, remove the power switch cable from the tabs on the computer floor.

Figure 8-23 Removing the power switch cable



5. Disconnect the power switch cable from the front USB assembly cable.

Figure 8-24 Disconnecting the power switch cable

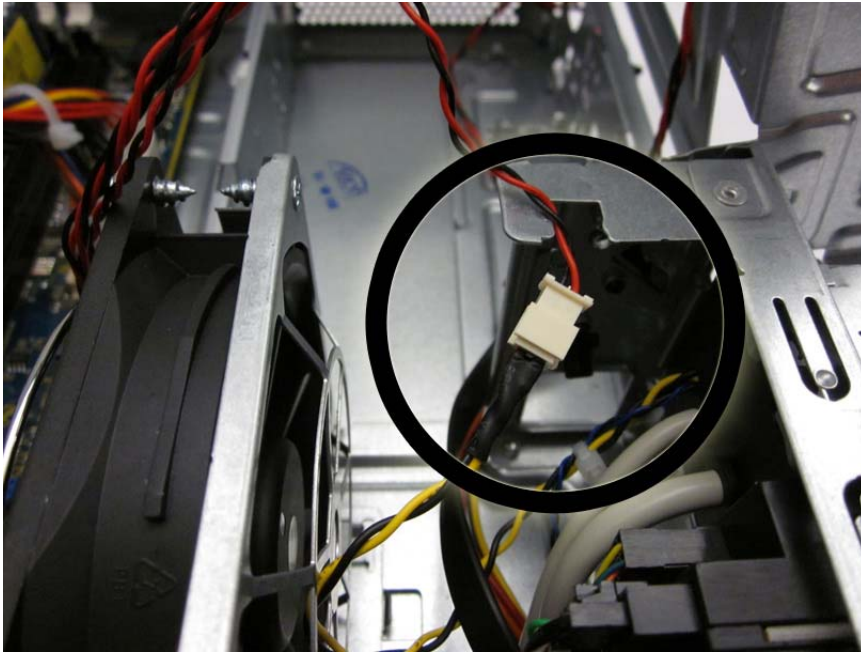

6. From the outside, front of the computer, press the tab on the right side of the power switch (1) to disengage it from the chassis.
7. Rotate the power switch right to left (2), and then remove it from the computer (3) while routing the cable through the hole in the front of the chassis.

Figure 8-25 Removing the power switch

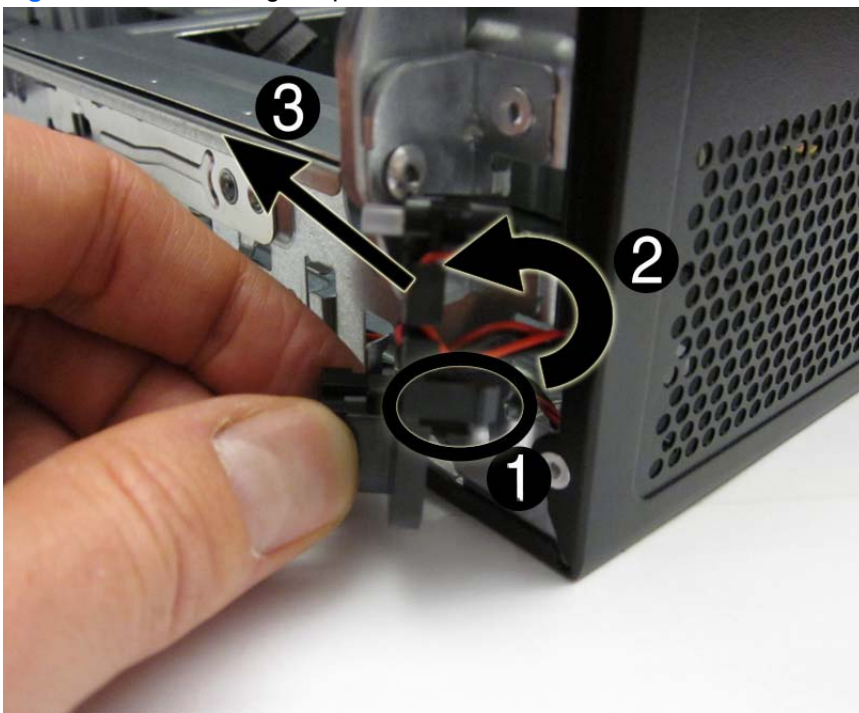

To install the power switch, reverse the removal procedure.

Front USB Assembly

Description	Spare part number
Front I/O and card reader (6-in-1)	656983-001

The front USB assembly is secured to the front of the chassis with one screw. Push the assembly into the chassis to remove it.

1. Prepare the computer for disassembly ([Preparation for Disassembly on page 79](#)).
2. Remove the access panel ([Access Panel on page 80](#)).
3. Remove the front bezel ([Front Bezel on page 82](#)).
4. Disconnect the four cables from the system board as follows:
 - Yellow connector labeled F_AUDIO
 - White connector labeled MINI_LED
 - White connector labeled F_USB3
 - Black connector labeled F_USB2

Figure 8-26 Disconnecting the front I/O cables

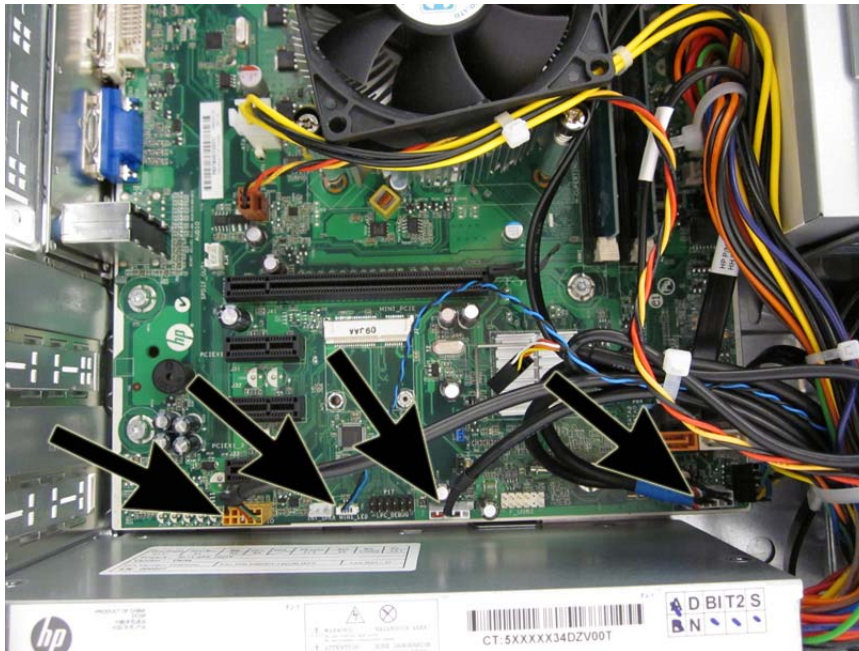

5. Remove the cables from the clip on the base pan of the computer.

Figure 8-27 Removing the cables from the clip



6. From the front of the computer, remove the screw that secures the assembly to the front of the chassis.

Figure 8-28 Removing the front USB assembly screw



7. Push the left side of the assembly down slightly (1), and then push the assembly into the computer (2).

Figure 8-29 Disengaging the front USB assembly

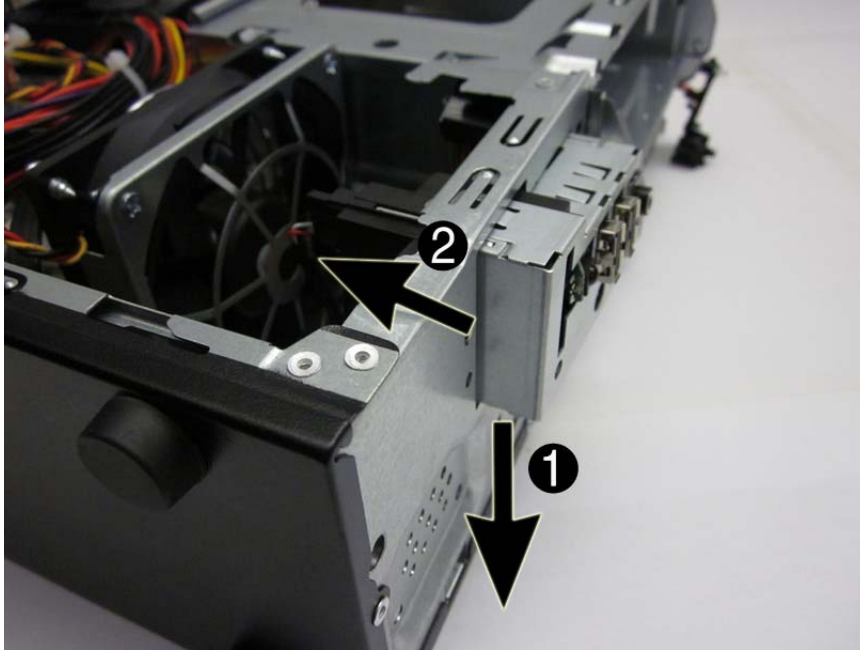

8. Remove the assembly from the computer.

To install the front USB assembly, reverse the removal procedure.

Fan Assembly

Description	Spare part number
Fan	656834-001

The fan assembly is attached to the inside floor of the chassis using two screws. The fan is inside of a removal metal cage.

1. Prepare the computer for disassembly ([Preparation for Disassembly on page 79](#)).
2. Remove the access panel ([Access Panel on page 80](#)).
3. Remove the front bezel ([Front Bezel on page 82](#)).
4. Disconnect the fan cable from the system board connector labeled SYS_FAN.
5. Remove the Torx screw that secures the left side of the fan to the computer.
6. Cut the plastic tie (1) that secures the fan cable to the power supply power cables.
7. Remove the two screws (2) that secure the fan to the computer. The screw near the computer side is not shown in the following image.
8. Lift the fan assembly up and out of the computer (3).

Figure 8-30 Removing the fan

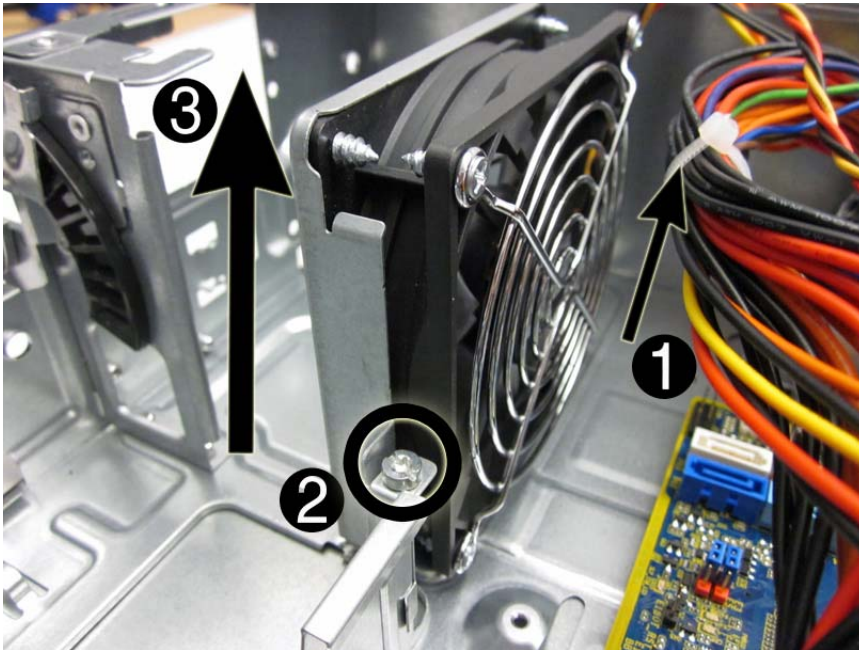

9. if you need to remove the fan from the metal case, remove the four screws that secure the fan to the case, and remove the fan from the case.

Figure 8-31 Removing the fan from the metal case

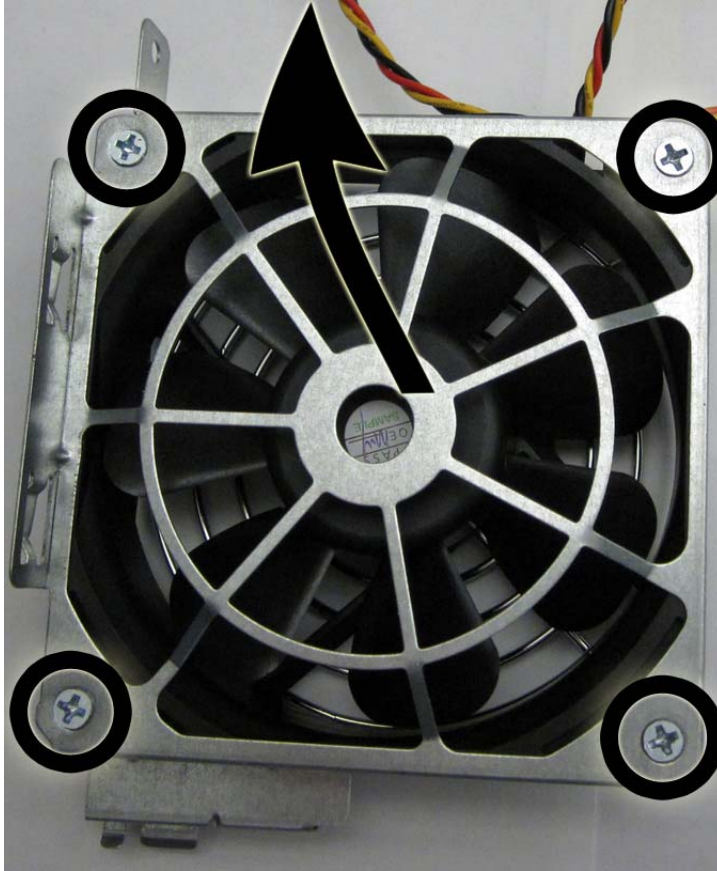

To install the fan, reverse the removal procedure.

Fan Sink

Description	Spare part number
Fan sink	657402-001

The fan sink is secured atop the processor with four captive Torx screws. A fan cable connects to the system board.

1. Prepare the computer for disassembly ([Preparation for Disassembly on page 79](#)).
2. Remove the access panel ([Access Panel on page 80](#)).
3. Loosen the four captive screws that secure the fan sink to the system board tray.

CAUTION: Fan sink retaining screws should be removed in diagonally opposite pairs (as in an X) to even the downward forces on the processor. This is especially important as the pins on the socket are very fragile and any damage to them may require replacing the system board.

Figure 8-32 Loosening the fan sink screws



4. Disconnect the cable from the system board (1), lift the fan sink from atop the processor (2) and set it on its side to keep from contaminating the work area with thermal grease.

Figure 8-33 Removing the fan sink

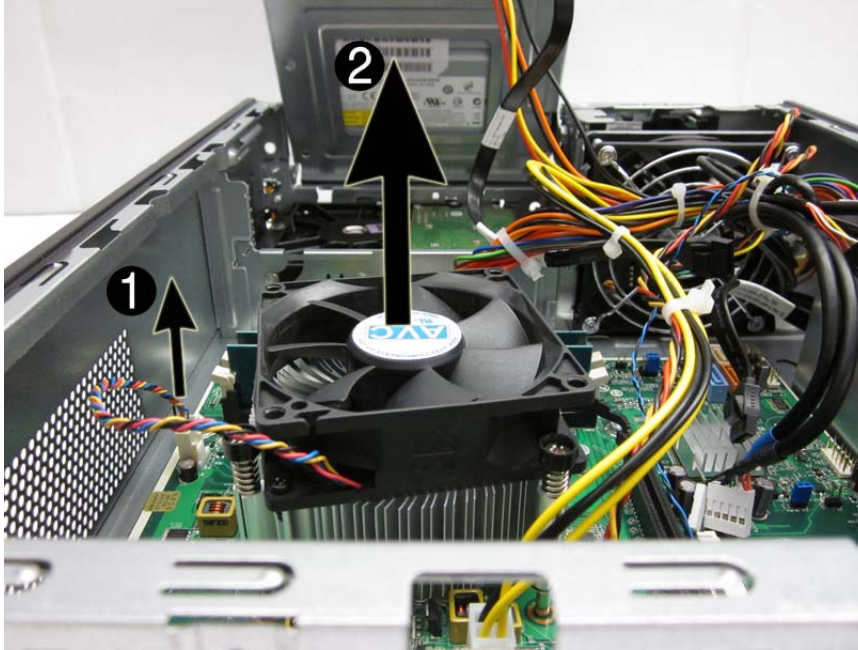

When reinstalling the fan sink, make sure that its bottom has been cleaned with an alcohol wipe and fresh thermal grease has been applied to the top of the processor.

CAUTION: Fan sink retaining screws should be tightened in diagonally opposite pairs (as in an X) to evenly seat the heat sink on the processor to avoid damage that could require replacing the system board.

Failure to install the fan duct may cause the computer to overheat.

Processor

Description	Spare part number
Intel Core i7 processors	
2600S (2.7 GHz, 8-MB L3 cache, 65W)	638419-001
Intel Core i5 processors	
2500S (2.7 GHz, 6-MB L3 cache, 65W)	638420-001
2500 (3.3 GHz, 6-MB L3 cache, 95W)	638631-001
2405S (2.5-GHz, 6-MB L3 cache, 65W)	656790-001
2400S (2.5 GHz, 6-MB L3 cache, 65W)	640953-001
2400 (3.1 GHz, 6-MB L3 cache, 95W)	638630-001
2320 (3.0 GHz, 6-MB L3 cache, 95W)	665121-001-001
2310 (2.9 GHz, 6-MB L3 cache, 95W)	657111-001
2300 (2.8 GHz, 6-MB L3 cache, 95W)	654601-001
Intel Core i3 processors	
2130 (3.4 GHz, 3-MB L3 cache, 65W)	665120-001
2120 (3.3 GHz, 3-MB L3 cache, 65W)	638629-001
2100 (3.1 GHz, 3-MB L3 cache, 65W)	638628-001
Intel Pentium Dual-Core processors	
G860 (3.0 GHz, 3-MB L3 cache, 65W)	665123-001
G850 (2.9-GHz, 3-MB L3 cache, 65W)	655973-001
G840 (2.8-GHz, 3-MB L3 cache, 65W)	655972-001
G630 (2.7 GHz, 3-MB L3 cache, 65W)	665122-001
G620 (2.6-GHz, 3-MB L3 cache, 65W)	655971-001
G540 (2.5 GHz, 2-MB L3 cache, 65W)	665119-001
G530 (2.4 GHz, 2-MB L3 cache, 65W)	665117-001
G530T (2.0 GHz, 2-MB L3 cache, 35W)	665118-001

1. Prepare the computer for disassembly ([Preparation for Disassembly on page 79](#)).
2. Remove the access panel ([Access Panel on page 80](#)).
3. Remove the fan sink ([Fan Sink on page 108](#)).
4. Rotate the locking lever to its full open position **(1)**.
5. Raise and rotate the microprocessor retainer to its fully open position **(2)**.

- Carefully lift the processor from the socket (3).

CAUTION: Do NOT handle the pins in the processor socket. These pins are very fragile and handling them could cause irreparable damage. Once pins are damaged it may be necessary to replace the system board.

The heat sink must be installed within 24 hours of installing the processor to prevent damage to the processor's solder connections.

Figure 8-34 Removing the processor

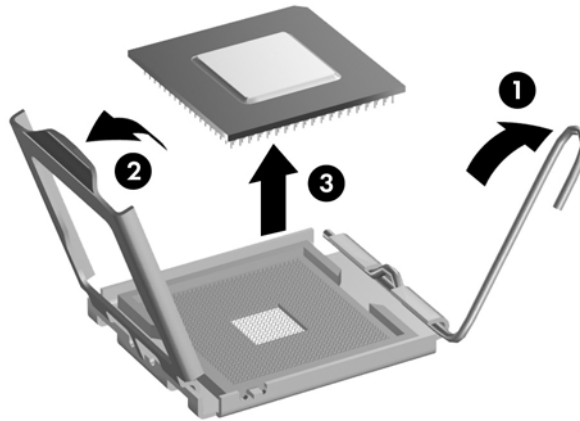

To install a new processor:

- Place the processor in its socket and close the retainer. Make sure the slot in the processor fits into the post on the socket.
- Secure the locking lever. If reusing the existing heat sink, go to step 3. If using a new heat sink, go to step 6.
- If reusing the existing fan sink, clean the bottom of the fan sink with the alcohol pad provided in the spares kit.

CAUTION: Before reinstalling the fan sink you must clean the top of the processor and the bottom of the fan sink with an alcohol pad supplied in the spares kit. After the alcohol has evaporated, apply thermal grease to the top of the processor from the syringe supplied in the spares kit.

- Apply the thermal grease provided in the spares kit to the top of the processor and install the fan sink atop the processor.
- Go to step 7.

6. If using a new fan sink, remove the protective covering from the bottom of the fan sink and place it in position atop the processor.
7. Secure the fan sink to the system board and system board tray.

CAUTION: Fan sink retaining screws should be tightened in diagonally opposite pairs (as in an X) to evenly seat the fan sink on the processor. This is especially important as the pins on the socket are very fragile and any damage to them may require replacing the system board.

NOTE: After installing a new processor onto the system board, always update the system ROM to ensure that the latest version of the BIOS is being used on the computer. The latest system BIOS can be found on the Web at: <http://h18000.www1.hp.com/support/files>.

Power Supply

Description	Spare part number
Power supply, 220W	656722-001
Power supply, 270W	665224-001

WARNING! To reduce potential safety issues, only the power supply provided with the computer, a replacement power supply provided by HP, or a power supply purchased as an accessory from HP should be used with the computer.

The rotating power supply is located at the rear of the chassis. It is held in place by a bracket – no screws are used.

WARNING! Voltage is always present on the system board when the computer is plugged into an active AC outlet. To avoid possible personal injury and damage to the equipment the power cord should be disconnected from the computer and/or the AC outlet before opening the computer.

The power supply is secured to the rear of the computer with four Torx screws. On the inside of the computer, a tab secures the power supply to the base pan.

1. Prepare the computer for disassembly ([Preparation for Disassembly on page 79](#)).
2. Remove the access panel ([Access Panel on page 80](#)).
3. Rotate the drive cage up and disconnect the power cables from all of the drives.
4. Disconnect the power cables from the system board as follows:
 - white 24-pin labeled P1 from ATX_POWER system board connector
 - white 4-pin labeled P2 from ATX_CPU system board connector

5. From the rear of the computer, remove the four screws that secure the power supply to the computer.

Figure 8-35 Removing the power supply screws



6. On the inside of the computer, press the tab at the front of the power supply (1), pull the power supply forward, slide it back and toward the side of the computer so it can sit lower on the bottom of the computer, and then rotate it and lift it out of the computer (2).

Figure 8-36 Removing the power supply

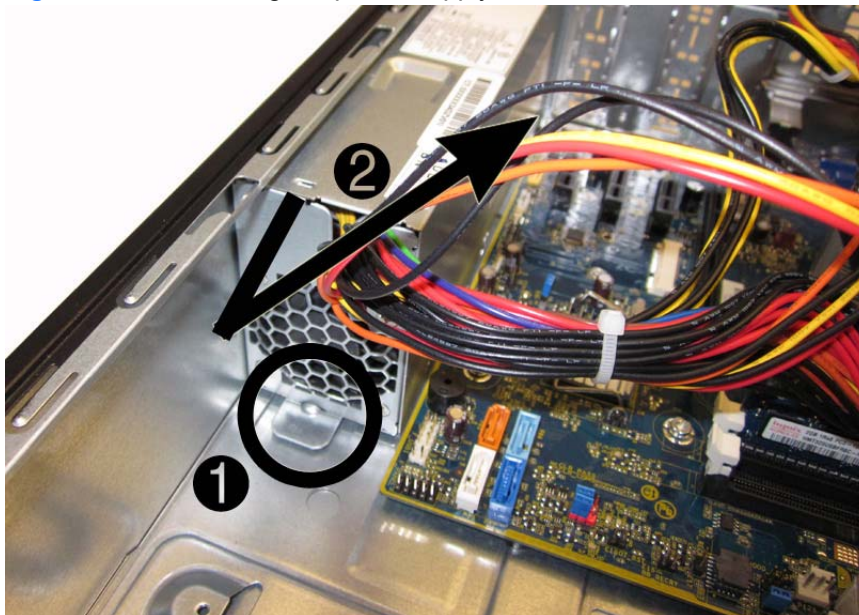

To install the power supply, reverse the removal procedure.

CAUTION: When installing the power supply cables, make sure they are properly positioned so they are not cut by the drive cage and are not pinched by the rotating power supply.

System Board

Description	Spare part number
System board (includes thermal material)	665223-001

The system board is secured to the computer with six screws.

1. Prepare the computer for disassembly ([Preparation for Disassembly on page 79](#)).
2. Remove the access panel ([Access Panel on page 80](#)).
3. When replacing the system board, make sure the following components are removed from the defective system board and installed on the replacement system board:
 - Memory modules (see [Memory on page 83](#))
 - Expansion cards ([Expansion Card on page 88](#))
 - Heat sink ([Fan Sink on page 108](#))
 - Processor ([Processor on page 110](#))
4. Remove the fan from the chassis ([Fan Assembly on page 106](#)).
5. Rotate the drive cage to its upright position.
6. Rotate the power supply to its full upright position.
7. Disconnect all data and power cables from the system board.
8. Disconnect the balance of the cables from the system board.

9. Remove the six screws that secure the system board to the chassis.

 **NOTE:** System board appearance may vary.

Figure 8-37 Removing the system board screws



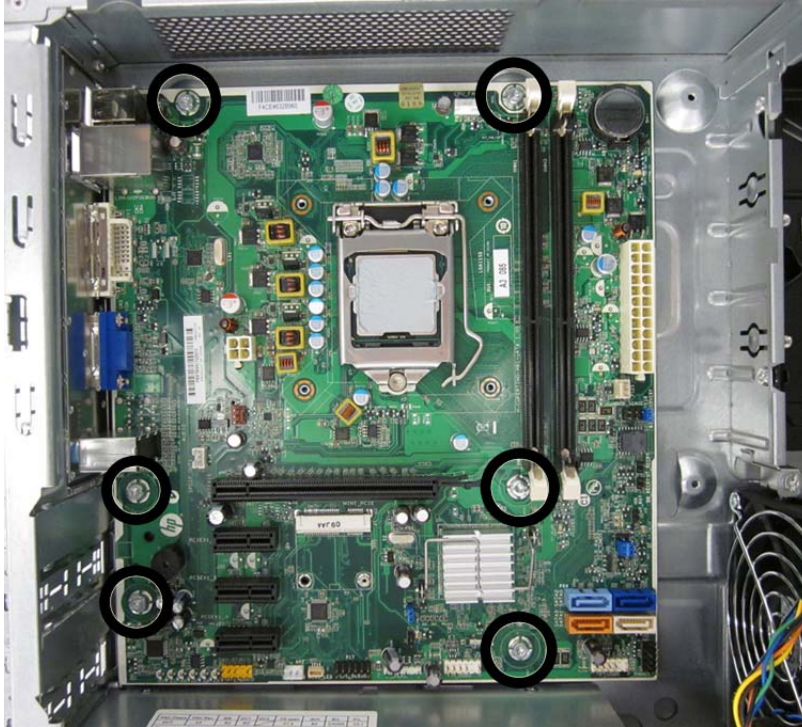
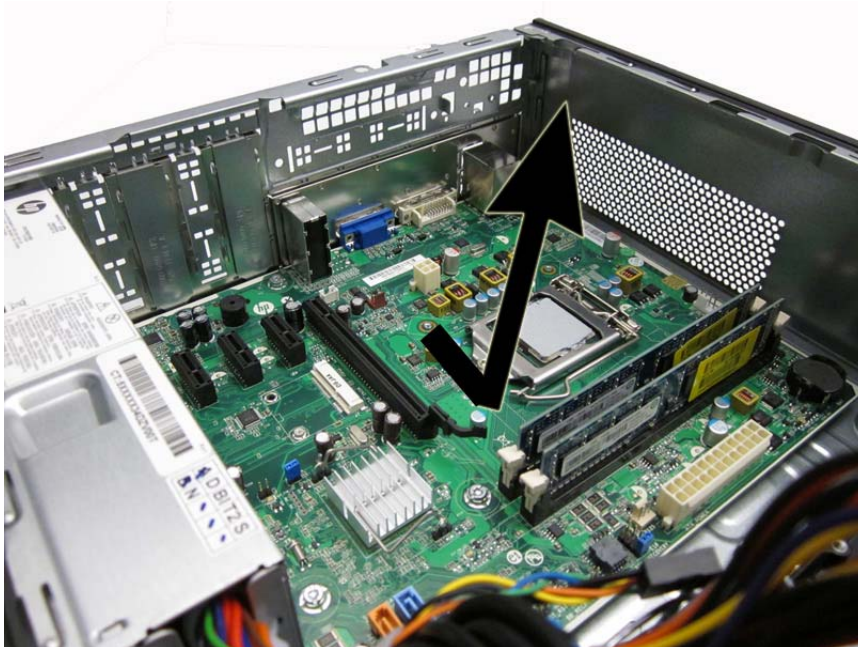

10. Slide the system board away from the rear of the computer to disengage the ports, and then lift the board up and out of the chassis.

Figure 8-38 Removing the system board



To install the system board, reverse the removal procedure.

 **NOTE:** When replacing the system board, you must also change the chassis serial number in the BIOS.

 **CAUTION:** Before reinstalling the heat sink you must clean the top of the processor and the bottom of the heat sink with an alcohol pad supplied in the spares kit. After the alcohol has evaporated, apply thermal grease to the top of the processor from the syringe supplied in the spares kit.

CAUTION: When reconnecting the cables it is important that they be positioned so they do not interfere with the rotation of the drive cage or power supply.

Battery

The battery that comes with your computer provides power to the real-time clock and has a lifetime of about three years. When replacing the battery, use a battery equivalent to the battery originally installed on the computer. The computer comes with a 3-volt lithium coin cell battery.

 **NOTE:** The lifetime of the lithium battery can be extended by plugging the computer into a live AC wall socket. The lithium battery is only used when the computer is NOT connected to AC power.

 **WARNING!** This computer contains an internal lithium manganese dioxide battery. There is a risk of fire and burns if the battery is not handled properly. To reduce the risk of personal injury:

- Do not attempt to recharge the battery.
- Do not expose to temperatures higher than 60°C (140°F)
- Do not disassemble, crush, puncture, short external contacts, or dispose of in fire or water.
- Replace the battery only with the HP/Compaq spare designated for this product.

 **CAUTION:** Before replacing the battery, it is important to back up the computer CMOS settings. When the battery is removed or replaced, the CMOS settings will be cleared. Refer to the [Troubleshooting Without Diagnostics on page 140](#) chapter for information on backing up the CMOS settings.

 **NOTE:** Batteries, battery packs, and accumulators should not be disposed of together with the general household waste. In order to forward them to recycling or proper disposal, please use the public collection system or return them to HP, its authorized partners, or its agents.

 **CAUTION:** Static electricity can damage the electronic components of the computer or optional equipment. Before beginning these procedures, ensure that you are discharged of static electricity by briefly touching a grounded metal object.

1. Prepare the computer for disassembly ([Preparation for Disassembly on page 42](#)).
2. Remove the access panel ([Access Panel on page 43](#)).

 **NOTE:** It may be necessary to remove an expansion card to gain access to the battery.

3. Locate the battery and battery holder on the system board.
4. To release the battery from its holder, squeeze the metal clamp that extends above one edge of the battery. When the battery pops up, lift it out (1).

5. To insert the new battery, slide one edge of the replacement battery under the holder's lip with the positive side up (2). Push the other edge down until the clamp snaps over the other edge of the battery.



6. Replace the computer access panel.
7. Plug in the computer and turn on power to the computer.
8. Reset the date and time, your passwords, and any special system setups, using Computer Setup. Refer to [Computer Setup \(F10\) Utility on page 7](#).



A Connector Pin Assignments

This appendix contains the pin assignments for many computer and workstation connectors. Some of these connectors may not be used on the product being serviced.

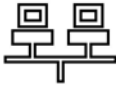

Ethernet BNC

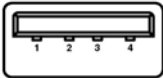
Connector and Icon	Pin	Signal
	1	Data
	2	Ground

USB

Connector and Icon	Pin	Signal
	1	+5 VDC
	2	- Data
	3	+ Data
	4	Ground

Microphone

Connector and Icon (1/8" miniphone)	Pin	Signal
	1 (Tip)	Audio_left
	2 (Ring)	Audio_Right
	3 (Shield)	Ground

Headphone

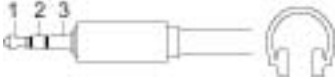
Connector and Icon (1/8" miniphone)	Pin	Signal
	1 (Tip)	Audio_left
	2 (Ring)	Power_Right
	3 (Shield)	Ground

Line-in Audio

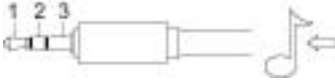
Connector and Icon (1/8" miniphone)	Pin	Signal
	1 (Tip)	Audio_In_Left
	2 (Ring)	Audio_In_Right
	3 (Shield)	Ground

Line-out Audio

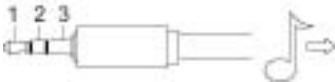
Connector and Icon (1/8" miniphone)	Pin	Signal
	1 (Tip)	Audio_Out_Left
	2 (Ring)	Audio_Out_Right
	3 (Shield)	Ground

4-Pin Power (for CPU)

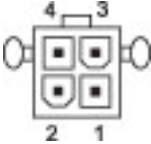
Connector and Icon	Pin	Signal
	1	GND
	2	GND
	3	+12V CPU
	4	-12V CPU

Monitor

Connector and Icon

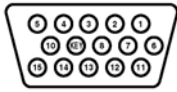

Pin	Signal	Pin	Signal
1	Red Analog	9	+5V (fused)
2	Green Analog	10	Ground
3	Blue Analog	11	Not used
4	Not used	12	DDC Serial Data
5	Ground	13	Horizontal Sync
6	Ground	14	Vertical Sync
7	Ground	15	DDC Serial Clock
8	Ground		

Serial Interface, Powered and Non-Powered

Connector and Icon



Pin	Signal
1	Carrier Detect (12V if powered)
2	Receive Data
3	Transmit Data
4	Data Terminal Ready
5	Signal Ground
6	Data Set Ready
7	Request to Send
8	Clear to Send
9	Ring Indicator (5V if powered)

DVI Connector

Connector and Icon

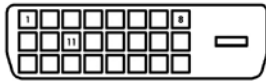

Pin	Signal	Pin	Signal
1	T.M.D.S. Data2-	13	T.M.D.S. Data3+
2	T.M.D.S. Data2+	14	+5V Power
3	T.M.D.S. Data2/4 Shield	15	Ground (for +5V)
4	T.M.D.S. Data4-	16	Hot Pug Detect
5	T.M.D.S. Data4+	17	T.M.D.S. Data0-
6	DDC Clock	18	T.M.D.S. Data0+
7	DDC Data	19	T.M.D.S. Data0/5 Shield
8	No Connect	20	T.M.D.S. Data5-
9	T.M.D.S. Data1-	21	T.M.D.S. Data5+
10	T.M.D.S. Data1+	22	T.M.D.S. Data Shield
11	T.M.D.S. Data1/3 Shield	23	T.M.D.S. Clock+
12	T.M.D.S. Data3-	24	T.M.D.S. Clock-

24-Pin Power

Connector

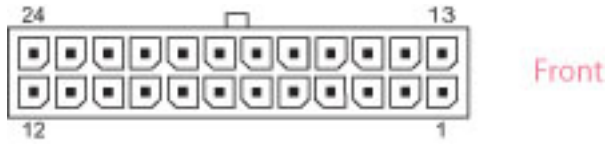

Pin	Signal	Pin	Signal	Pin	Signal	Pin	Signal
1	+3.3V	7	GND	13	+3.3V	19	GND
2	+3.3V	8	POK	14	-12V	20	open
3	GND	9	+5 Vaux	15	GND	21	+5V
4	+5V	10	+12V	16	PSON	22	+5V
5	GND	11	+12V	17	GND	23	+5V
6	+5V	12	+3.3V	18	GND	24	GND

PCI Express

x1, x4, x8, and x16 PCI Express Connector

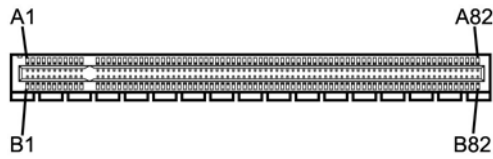

Pin A

Pin	Signal	Pin	Signal	Pin	Signal	Pin	Signal	Pin	Signal
1	PRSNT1	6	JTAG3	11	PERST#	16	PERp0	21	PERp1
2	+12V	7	JTAG4	12	GND	17	PERn0	22	PERn1
3	+12V	8	JTAG5	13	REFCLK+	18	GND	23	GND
4	GND	9	+3.3V	14	REFCLK-	19	RSVD	24	GND
5	JTAG2	10	+3.3V	15	GND	20	GND	25	PERp2
26	PERn(2)	31	GND	36	PERn4	41	GND	46	GND
27	GND	32	RSVD	37	GND	42	GND	47	PERp7
28	GND	33	RSVD	38	GND	43	PERp6	48	PERn7
29	PERp3	34	GND	39	PERp5	44	PERn6	49	GND
30	PERn3	35	PERp4	40	PERn5	45	GND	50	RSVD
51	GND	56	PERp9	61	PERn10	66	GND	71	GND
52	PERp8	57	PERn9	62	GND	67	GND	72	PERp13
53	PERn8	58	GND	63	GND	68	PERp12	73	PERn13
54	GND	59	GND	64	PERp11	69	PERn12	74	GND
55	GND	60	PERp10	65	PERn11	70	GND	75	GND
76	PERp14	81	PERn15						
77	PERn14	82	GND						
78	GND								
79	GND								
80	PERp15								

Pin B information is on the next page

NOTE: x1 PCI Express uses pins 1-18

x4 PCI Express uses pins 1-32

x8 PCI Express uses pins 1-49

x16 PCI Express uses pins 1-8

PCI Express

x1, x4, x8, and x16 PCI Express Connector

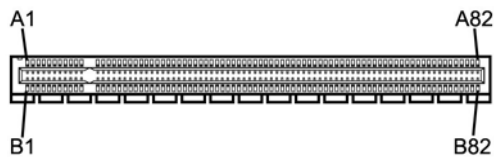

Pin B

Pin	Signal	Pin	Signal	Pin	Signal	Pin	Signal	Pin	Signal
1	+12V	6	SMDAT	11	WAKE#	16	GND	21	GND
2	+12V	7	GND	12	RSVD	17	GND	22	GND
3	RSVD	8	+3.3 V	13	GND	18	PETp1	23	PETp2
4	GND	9	JTAG1	14	PETp0	19	PETn1	24	PETn2
5	SMCLK	10	3.3vAux	15	PETn0	20		25	GND
26	GND	31	PRSNT2#	36	GND	41	PETp6	46	PETn7
27	PETp3	32	GND	37	PETp5	42	PRTn6	47	GND
28	PETn3	33	PETp4	38	PETn5	43	GND	48	PRSNT2#
29	GND	34	PETn4	39	GND	44	GND	49	GND
30	RSVD	35	GND	40	GND	45	PETp7	50	PETp8
51	PETn8	56	GND	61	GND	66	PETp12	71	PETn13
52	GND	57	GND	62	PETp11	67	PETn12	72	GND
53	GND	58	PETp10	63	PETn11	68	GND	73	GND
54	PETp9	59	PETn10	64	GND	69	GND	74	PETp14
55	PETn9	60	GND	65	GND	70	PETp13	75	PETn14
76	GND	81	PRSNT2#						
77	GND	82	RSVD						
78	PETp15								
79	PETn15								
80	GND								

Pin B information is on the next page

NOTE: x1 PCI Express uses pins 1-18

x4 PCI Express uses pins 1-32

x8 PCI Express uses pins 1-49

x16 PCI Express uses pins 1-8

B Power Cord Set Requirements

The power supplies on some computers have external power switches. The voltage select switch feature on the computer permits it to operate from any line voltage between 100-120 or 220-240 volts AC. Power supplies on those computers that do not have external power switches are equipped with internal switches that sense the incoming voltage and automatically switch to the proper voltage.

The power cord set received with the computer meets the requirements for use in the country where you purchased the equipment.

Power cord sets for use in other countries must meet the requirements of the country where you use the computer.

General Requirements

The requirements listed below are applicable to all countries:

1. The power cord must be approved by an acceptable accredited agency responsible for evaluation in the country where the power cord set will be installed.
2. The power cord set must have a minimum current capacity of 10A (7A Japan only) and a nominal voltage rating of 125 or 250 volts AC, as required by each country's power system.
3. The diameter of the wire must be a minimum of 0.75 mm² or 18AWG, and the length of the cord must be between 1.8 m (6 feet) and 3.6 m (12 feet).

The power cord should be routed so that it is not likely to be walked on or pinched by items placed upon it or against it. Particular attention should be paid to the plug, electrical outlet, and the point where the cord exits from the product.

 **WARNING!** Do not operate this product with a damaged power cord set. If the power cord set is damaged in any manner, replace it immediately.

Japanese Power Cord Requirements

For use in Japan, use only the power cord received with this product.

 **CAUTION:** Do not use the power cord received with this product on any other products.

Country-Specific Requirements

Additional requirements specific to a country are shown in parentheses and explained below.

Country	Accrediting Agency	Country	Accrediting Agency
Australia (1)	EANSW	Italy (1)	IMQ
Austria (1)	OVE	Japan (3)	METI
Belgium (1)	CEBC	Norway (1)	NEMKO
Canada (2)	CSA	Sweden (1)	SEMKO
Denmark (1)	DEMKO	Switzerland (1)	SEV
Finland (1)	SETI	United Kingdom (1)	BSI
France (1)	UTE	United States (2)	UL
Germany (1)	VDE		

1. The flexible cord must be Type HO5VV-F, 3-conductor, 0.75mm² conductor size. Power cord set fittings (appliance coupler and wall plug) must bear the certification mark of the agency responsible for evaluation in the country where it will be used.
2. The flexible cord must be Type SVT or equivalent, No. 18 AWG, 3-conductor. The wall plug must be a two-pole grounding type with a NEMA 5-15P (15A, 125V) or NEMA 6-15P (15A, 250V) configuration.
3. Appliance coupler, flexible cord, and wall plug must bear a "T" mark and registration number in accordance with the Japanese Dentori Law. Flexible cord must be Type VCT or VCTF, 3-conductor, 0.75 mm² conductor size. Wall plug must be a two-pole grounding type with a Japanese Industrial Standard C8303 (7A, 125V) configuration.

C POST Error Messages

This appendix lists the error codes, error messages, and the various indicator light and audible sequences that you may encounter during Power-On Self-Test (POST) or computer restart, the probable source of the problem, and steps you can take to resolve the error condition.

POST Message Disabled suppresses most system messages during POST, such as memory count and non-error text messages. If a POST error occurs, the screen will display the error message. To manually switch to the POST Messages Enabled mode during POST, press any key (except [F10](#), [F11](#), or [F12](#)). The default mode is POST Message Disabled.

The speed at which the computer loads the operating system and the extent to which it is tested are determined by the POST mode selection.

Quick Boot is a fast startup process that does not run all of the system level tests, such as the memory test. Full Boot runs all of the ROM-based system tests and takes longer to complete.

Full Boot may also be enabled to run every 1 to 30 days on a regularly scheduled basis. To establish the schedule, reconfigure the computer to the Full Boot Every x Days mode, using Computer Setup.



NOTE: For more information on Computer Setup, see [Computer Setup \(F10\) Utility on page 7](#).

POST Numeric Codes and Text Messages

This section covers those POST errors that have numeric codes associated with them. The section also includes some text messages that may be encountered during POST.



NOTE: The computer will beep once after a POST text message is displayed on the screen.

Table C-1 Numeric Codes and Text Messages

Control panel message	Description	Recommended action
101-Option ROM Checksum Error	System ROM or expansion board option ROM checksum.	<ol style="list-style-type: none">1. Verify the correct ROM.2. Flash the ROM if needed.3. If an expansion board was recently added, remove it to see if the problem remains.4. Clear CMOS. (See Appendix B, Password Security and Resetting CMOS on page 177.)5. If the message disappears, there may be a problem with the expansion card.6. Replace the system board.
103-System Board Failure	DMA or timers.	<ol style="list-style-type: none">1. Clear CMOS. (See Appendix B, Password Security and Resetting CMOS on page 177.)2. Remove expansion boards.3. Replace the system board.
110-Out of Memory Space for Option ROMs	Recently added PCI expansion card contains an option ROM too large to download during POST.	<ol style="list-style-type: none">1. If a PCI expansion card was recently added, remove it to see if the problem remains.2. In Computer Setup, set Advanced > Device Options > NIC PXE Option ROM Download to DISABLE to prevent PXE option ROM for the internal NIC from being downloaded during POST to free more memory for an expansion card's option ROM. Internal PXE option ROM is used for booting from the NIC to a PXE server.
162-System Options Not Set	Configuration incorrect. RTC (real-time clock) battery may need to be replaced.	Run Computer Setup and check the configuration in Advanced > Onboard Devices . Reset the date and time under Control Panel . If the problem persists, replace the RTC battery. See the Removal and Replacement section for instructions on installing a new battery, or contact an authorized dealer or reseller for RTC battery replacement.

Table C-1 Numeric Codes and Text Messages (continued)

Control panel message	Description	Recommended action
163-Time & Date Not Set	Invalid time or date in configuration memory. RTC (real-time clock) battery may need to be replaced.	Reset the date and time under Control Panel (Computer Setup can also be used). If the problem persists, replace the RTC battery. See the Removal and Replacement section for instructions on installing a new battery, or contact an authorized dealer or reseller for RTC battery replacement.
163-Time & Date Not Set	CMOS jumper may not be properly installed.	Check for proper placement of the CMOS jumper if applicable.
164-MemorySize Error	Memory amount has changed since the last boot (memory added or removed).	Press the F1 key to save the memory changes.
164-MemorySize Error	Memory configuration incorrect.	<ol style="list-style-type: none">1. Run Computer Setup or Windows utilities.2. Make sure the memory module(s) are installed properly.3. If third-party memory has been added, test using HP-only memory.4. Verify proper memory module type.
201-Memory Error	RAM failure.	<ol style="list-style-type: none">1. Ensure memory modules are correctly installed.2. Verify proper memory module type.3. Remove and replace the identified faulty memory module(s).4. If the error persists after replacing memory modules, replace the system board.
213-Incompatible Memory Module in Memory Socket(s) X, X, ...	A memory module in memory socket identified in the error message is missing critical SPD information, or is incompatible with the chipset.	<ol style="list-style-type: none">1. Verify proper memory module type.2. Try another memory socket.3. Replace DIMM with a module conforming to the SPD standard.
214-DIMM Configuration Warning	Populated DIMM Configuration is not optimized.	Rearrange the DIMMs so that each channel has the same amount of memory.
219-ECC Memory Module Detected ECC Modules not supported on this Platform	Recently added memory module(s) support ECC memory error correction.	<ol style="list-style-type: none">1. If additional memory was recently added, remove it to see if the problem remains.2. Check product documentation for memory support information.
301-Keyboard Error	Keyboard failure.	<ol style="list-style-type: none">1. Reconnect keyboard with computer turned off.2. Check connector for bent or missing pins.3. Ensure that none of the keys are depressed.4. Replace keyboard.

Table C-1 Numeric Codes and Text Messages (continued)

Control panel message	Description	Recommended action
303-Keyboard Controller Error	I/O board keyboard controller.	<ol style="list-style-type: none">1. Reconnect keyboard with computer turned off.2. Replace the system board.
304-Keyboard or System Unit Error	Keyboard failure.	<ol style="list-style-type: none">1. Reconnect the keyboard with computer turned off.2. Ensure that none of the keys are depressed.3. Replace the keyboard.4. Replace the system board.
501-Display Adapter Failure	Graphics display controller.	<ol style="list-style-type: none">1. Reseat the graphics card (if applicable).2. Clear CMOS. (See Appendix B, Password Security and Resetting CMOS on page 177.)3. Verify monitor is attached and turned on.4. Replace the graphics card (if possible).
510-Flash Screen Image Corrupted	Flash Screen image has errors.	Reflash the system ROM with the latest BIOS image.
511-CPU, CPUA, or CPUB Fan not Detected	CPU fan is not connected or may have malfunctioned.	<ol style="list-style-type: none">1. Reseat CPU fan.2. Reseat fan cable.3. Replace CPU fan.
512-Chassis, Rear Chassis, or Front Chassis Fan not Detected	Chassis, rear chassis, or front chassis fan is not connected or may have malfunctioned.	<ol style="list-style-type: none">1. Reseat chassis, rear chassis, or front chassis fan.2. Reseat fan cable.3. Replace chassis, rear chassis, or front chassis fan.
513-Front Chassis fan not detected	Front chassis fan is not connected or may have malfunctioned.	<ol style="list-style-type: none">1. Reseat front chassis fan.2. Reseat fan cable.3. Replace front chassis fan.
514-CPU or Chassis Fan not Detected	CPU or chassis fan is not connected or may have malfunctioned.	<ol style="list-style-type: none">1. Reseat CPU or chassis fan.2. Reseat fan cable.3. Replace CPU or chassis fan.
515-Power Supply fan not detected	Power supply fan is not connected or may have malfunctioned.	<ol style="list-style-type: none">1. Reseat power supply fan.2. Reseat fan cable.3. Replace power supply fan.

Table C-1 Numeric Codes and Text Messages (continued)

Control panel message	Description	Recommended action
601-Diskette Controller Error	Diskette controller circuitry or floppy drive circuitry incorrect.	<ol style="list-style-type: none"> 1. Check and/or replace cables. 2. Clear CMOS. (See Appendix B, Password Security and Resetting CMOS on page 177.) 3. Replace diskette drive. 4. Replace the system board.
605-Diskette Drive Type Error	Mismatch in drive type.	<ol style="list-style-type: none"> 1. Disconnect any other diskette controller devices (tape drives). 2. Clear CMOS. (See Appendix B, Password Security and Resetting CMOS on page 177.)
660-Display cache is detected unreliable	Integrated graphics controller display cache is not working properly and will be disabled.	Replace system board if minimal graphics degrading is an issue.
912-Computer Cover Has Been Removed Since Last System Startup	Computer cover was removed since last system startup.	No action required.
917-Front Audio Not Connected	Front audio harness has been detached or unseated from motherboard.	Reconnect or replace front audio harness.
918-Front USB Not Connected	Front USB harness has been detached or unseated from motherboard.	Reconnect or replace front USB harness.
921-Device in PCI Express slot failed to initialize	There is an incompatibility/problem with this device and the system or PCI Express Link could not be retrained to an x1.	Try rebooting the system. If the error reoccurs, the device may not work with this system
1151-Serial Port A Address Conflict Detected	Both external and internal serial ports are assigned to COM1.	<ol style="list-style-type: none"> 1. Remove any serial port expansion cards. 2. Clear CMOS. (See Appendix B, Password Security and Resetting CMOS on page 177.) 3. Reconfigure card resources and/or run Computer Setup or Windows utilities.
1152-Serial Port B Address Conflict Detected	Both external and internal serial ports are assigned to COM2.	<ol style="list-style-type: none"> 1. Remove any serial port expansion cards. 2. Clear CMOS. (See Appendix B, Password Security and Resetting CMOS on page 177.) 3. Reconfigure card resources and/or run Computer Setup or Windows utilities.
1155-Serial Port Address Conflict Detected	Both external and internal serial ports are assigned to same IRQ.	<ol style="list-style-type: none"> 1. Remove any serial port expansion cards. 2. Clear CMOS. (See Appendix B, Password Security and Resetting CMOS on page 177.) 3. Reconfigure card resources and/or run Computer Setup or Windows utilities.

Table C-1 Numeric Codes and Text Messages (continued)

Control panel message	Description	Recommended action
1720-SMART Hard Drive Detects Imminent Failure	Hard drive is about to fail. (Some hard drives have a hard drive firmware patch that will fix an erroneous error message.)	<ol style="list-style-type: none">1. Determine if hard drive is giving correct error message. Enter Computer Setup and run the Drive Protection System test under Storage > DPS Self-test.2. Apply hard drive firmware patch if applicable. (Available at http://www.hp.com/support.)3. Back up contents and replace hard drive.
1796-SATA Cabling Error	One or more SATA devices are improperly attached. For optimal performance, the SATA 0 and SATA 1 connectors must be used before SATA 2 and SATA 3.	Ensure SATA connectors are used in ascending order. For one device, use SATA 0. For two devices, use SATA 0 and SATA 1. For three devices, use SATA 0, SATA 1, and SATA 2.
1797-SATA Drivelock is not supported in RAID mode.	Drivelock is enabled on one or more SATA hard drives, and they cannot be accessed while the system is configured for RAID mode.	Either remove the Drivelocked SATA device or disable the Drivelock feature. To disable the Drivelock feature, enter Computer Setup, change Storage > Storage Options > SATA Emulation to IDE , and select File > Save Changes and Exit . Reenter Computer Setup and select Security > Drivelock Security . For each listed Drivelock-capable SATA device, ensure Drivelock is Disabled . Lastly, change Storage > Storage Options > SATA Emulation back to RAID and select File > Save Changes and Exit .
1801-Microcode Patch Error	Processor is not supported by ROM BIOS.	<ol style="list-style-type: none">1. Upgrade BIOS to proper version.2. Change the processor.
2200-PMM Allocation Error during MEBx Download	Memory error during POST execution of the Management Engine (ME) BIOS Extensions option ROM.	<ol style="list-style-type: none">1. Reboot the computer.2. Unplug the power cord, re-seat the memory modules, and reboot the computer.3. If the memory configuration was recently changed, unplug the computer, restore the original memory configuration, and reboot the computer.4. If the error persists, replace the system board.

Table C-1 Numeric Codes and Text Messages (continued)

Control panel message	Description	Recommended action
2201-MEBx Module did not checksum correctly	Memory error during POST execution of the Management Engine (ME) BIOS Extensions option ROM.	<ol style="list-style-type: none">1. Reboot the computer.2. Unplug the power cord, re-seat the memory modules, and reboot the computer.3. If the memory configuration was recently changed, unplug the power cord, restore the original memory configuration, and reboot the computer.4. If the error persists, replace the system board.
2202-PM Deallocation Error during MEBx cleanup	Memory error during POST execution of the Management Engine (ME) BIOS Extensions option ROM.	<ol style="list-style-type: none">1. Reboot the computer.2. Unplug the power cord, re-seat the memory modules, and reboot the computer.3. If the memory configuration was recently changed, unplug the power cord, restore the original memory configuration, and reboot the computer.4. If the error persists, replace the system board.
2203-Setup error during MEBx execution	MEBx selection or exit resulted in a setup failure.	<ol style="list-style-type: none">1. Reboot the computer.2. Unplug the power cord, re-seat the memory modules, and reboot the computer.3. If the memory configuration was recently changed, unplug the power cord, restore the original memory configuration, and reboot the computer.4. If the error persists, replace the system board.
2204-Inventory error during MEBx execution	BIOS information passed to the MEBx resulted in a failure.	<ol style="list-style-type: none">1. Reboot the computer.2. If the error persists, update to the latest BIOS version.3. If the error still persists, replace the system board.
2205-Interface error during MEBx execution	MEBx operation experienced a hardware error during communication with ME.	<ol style="list-style-type: none">1. Reboot the computer.2. If the error persists, update to the latest BIOS version.3. If the error still persists, replace the system board.

Table C-1 Numeric Codes and Text Messages (continued)

Control panel message	Description	Recommended action
2211-Memory not configured correctly for proper MEBx execution.	DIMM1 or XMM1 is not installed.	Make sure there is a memory module in the black DIMM1 socket and that it is properly seated.
2212-USB Key Provisioning failure writing to device	USB device used for USB key provisioning will not allow BIOS to update provision file properly.	<ol style="list-style-type: none">1. Try a different USB key device for provisioning.2. If the error persists, update to the latest BIOS version and ME firmware version.3. If the error still persists, replace the system board.
2217-ME Firmware Version request failure	ME firmware is not properly responding to BIOS query for version information.	<ol style="list-style-type: none">1. Reboot the computer.2. If the error persists, update to the latest BIOS version and ME firmware version.3. If the error still persists, replace the system board.
2218-ME Firmware Version should be updated	ME firmware must be updated to match current functionality contained in the system BIOS.	<ol style="list-style-type: none">1. Update to the latest ME firmware version.2. If the error persists and system BIOS has been recently updated, restore previous system BIOS version.3. If the error still persists, replace the system board.
2219-USB Key Provisioning file has invalid header identifier	Provisioning file contained on the USB key has been corrupted or is not a valid version for the current ME firmware.	<ol style="list-style-type: none">1. Recreate the provisioning file using third party management console software.2. If the error persists and system BIOS has been recently updated, restore previous system BIOS version. Otherwise, update the ME firmware version.3. If the error still persists, replace the system board.
2220-USB Key Provisioning file has mismatch version	Provisioning file contained on the USB key is not a valid version for the current ME firmware.	<ol style="list-style-type: none">1. Reboot the computer.2. If the error persists and system BIOS has been recently updated, restore previous system BIOS version. Otherwise, update the ME firmware version.3. If the error still persists, replace the system board.

Table C-1 Numeric Codes and Text Messages (continued)

Control panel message	Description	Recommended action
2230-General error during MEBx execution	Error occurred during MEBx execution which fails into the "General" grouping. Status information displayed along with the error provides further clarity into the failure. MEBx handles transference of information between the system BIOS and ME firmware.	<ol style="list-style-type: none">1. Reboot the computer.2. If the error persists, update to the latest BIOS version and ME firmware version.3. If the error still persists, replace the system board.
2231-ME error during MEBx execution	Error occurred during MEBx execution which fails into "ME" grouping.	<ol style="list-style-type: none">1. Reboot the computer.2. If the error persists, update to the latest BIOS version and ME firmware version.3. If the error still persists, replace the system board.
2232-AMT error during MEBx execution	Error occurred during MEBx execution which fails into "AMT" grouping.	<ol style="list-style-type: none">1. Reboot the computer.2. If the error persists, update to the latest BIOS version and ME firmware version.3. If the error still persists, replace the system board.
2233-HECI error during MEBx execution	Error occurred during MEBx execution which fails into "MEI or HECI" grouping.	<ol style="list-style-type: none">1. Reboot the computer.2. If the error persists, update to the latest BIOS version and ME firmware version.3. If the error still persists, replace the system board.
2239-ME image lock failure	Special system configurations with reduced ME firmware image require BIOS control of ME firmware upgrading. A failure has occurred after the ME firmware update process in which the BIOS could not relock the ME firmware region.	<ol style="list-style-type: none">1. Reboot the computer.2. If the error persists, update to the latest BIOS version and ME firmware version.3. If the error still persists, replace the system board.
2240-ME image unlock failure	Special system configurations with reduced ME firmware image require BIOS control of ME firmware upgrading. A failure has occurred prior to the ME firmware update process in which the BIOS could not unlock the ME firmware region.	<ol style="list-style-type: none">1. Reboot the computer.2. If the error persists, update to the latest BIOS version and ME firmware version.3. If the error still persists, replace the system board.
Invalid Electronic Serial Number	Electronic serial number is missing.	Enter the correct serial number in Computer Setup.

Table C-1 Numeric Codes and Text Messages (continued)

Control panel message	Description	Recommended action
Network Server Mode Active and No Keyboard Attached	Keyboard failure while Network Server Mode enabled.	<ol style="list-style-type: none"> 1. Reconnect keyboard with computer turned off. 2. Check connector for bent or missing pins. 3. Ensure that none of the keys are depressed. 4. Replace keyboard.
Parity Check 2	Parity RAM failure.	Run Computer Setup and Diagnostic utilities.

Interpreting POST Diagnostic Front Panel LEDs and Audible Codes

This section covers the front panel LED codes as well as the audible codes that may occur before or during POST that do not necessarily have an error code or text message associated with them.

 **WARNING!** When the computer is plugged into an AC power source, voltage is always applied to the system board. To reduce the risk of personal injury from electrical shock and/or hot surfaces, be sure to disconnect the power cord from the wall outlet and allow the internal system components to cool before touching.

 **NOTE:** If you see flashing LEDs on a PS/2 keyboard, look for flashing LEDs on the front panel of the computer and refer to the following table to determine the front panel LED codes.

Recommended actions in the following table are listed in the order in which they should be performed.

Not all diagnostic lights and audible codes are available on all models.

Table C-2 Diagnostic Front Panel LEDs and Audible Codes

Activity	Beeps	Possible Cause	Recommended Action
Green Power LED On.	None	Computer on.	None
Green Power LED flashes every two seconds.	None	Computer in Suspend to RAM mode (some models only) or normal Suspend mode.	None required. Press any key or move the mouse to wake the computer.

Table C-2 Diagnostic Front Panel LEDs and Audible Codes (continued)

Activity	Beeps	Possible Cause	Recommended Action
Red Power LED flashes two times, once every second, followed by a two second pause. Beeps stop after fifth iteration but LEDs continue until problem is solved.	2	Processor thermal protection activated: A fan may be blocked or not turning. OR The heat sink/fan assembly is not properly attached to the processor.	<ol style="list-style-type: none">1. Ensure that the computer air vents are not blocked and the processor cooling fan is running.2. Open hood, press power button, and see if the processor fan spins. If the processor fan is not spinning, make sure the fan's cable is plugged onto the system board header.3. If fan is plugged in, but is not spinning, then replace heat sink/fan assembly.4. Contact an authorized reseller or service provider.
Red Power LED flashes three times, once every second, followed by a two second pause. Beeps stop after fifth iteration but LEDs continue until problem is solved.	3	Processor not installed (not an indicator of bad processor).	<ol style="list-style-type: none">1. Check to see that the processor is present.2. Reseat the processor.
Red Power LED flashes four times, once every second, followed by a two second pause. Beeps stop after fifth iteration but LEDs continue until problem is solved.	4	Power failure (power supply is overloaded). OR The incorrect external power supply adapter is being used on the USDT.	<ol style="list-style-type: none">1. Open the hood and ensure the 4 or 6-wire power supply cable is seated into the connector on the system board.2. Check if a device is causing the problem by removing ALL attached devices (such as hard, diskette, or optical drives, and expansion cards). Power on the system. If the system enters the POST, then power off and replace one device at a time and repeat this procedure until failure occurs. Replace the device that is causing the failure. Continue adding devices one at a time to ensure all devices are functioning properly.3. Replace the power supply.4. Replace the system board. <p>OR</p> <p>The USDT power supply adapter must be at 135W and use the Smart ID technology before the system will power up. Replace the power supply adapter with the HP-supplied USDT power supply adapter.</p>

Table C-2 Diagnostic Front Panel LEDs and Audible Codes (continued)

Activity	Beeps	Possible Cause	Recommended Action
Red Power LED flashes five times, once every second, followed by a two second pause. Beeps stop after fifth iteration but LEDs continue until problem is solved.	5	Pre-video memory error.	CAUTION: To avoid damage to the DIMMs or the system board, you must unplug the computer power cord before attempting to reseat, install, or remove a DIMM module. <ol style="list-style-type: none">1. Reseat DIMMs.2. Replace DIMMs one at a time to isolate the faulty module.3. Replace third-party memory with HP memory.4. Replace the system board.
Red Power LED flashes six times, once every second, followed by a two second pause. Beeps stop after fifth iteration but LEDs continue until problem is solved.	6	Pre-video graphics error.	For systems with a graphics card: <ol style="list-style-type: none">1. Reseat the graphics card.2. Replace the graphics card.3. Replace the system board. For systems with integrated graphics, replace the system board.
Red Power LED flashes seven times, once every second, followed by a two second pause. Beeps stop after fifth iteration but LEDs continue until problem is solved.	7	System board failure (ROM detected failure prior to video).	Replace the system board.
Red Power LED flashes eight times, once every second, followed by a two second pause. Beeps stop after fifth iteration but LEDs continue until problem is solved.	8	Invalid ROM based on bad checksum.	<ol style="list-style-type: none">1. Reflash the system ROM with the latest BIOS image. See the "Boot Block Emergency Recovery Mode" section of the <i>Desktop Management Guide</i> for more information.2. Replace the system board.
Red Power LED flashes nine times, once every second, followed by a two second pause. Beeps stop after fifth iteration but LEDs continue until problem is solved.	9	System powers on but is unable to boot.	<ol style="list-style-type: none">1. Check that the voltage selector, located on the rear of the power supply (some models), is set to the appropriate voltage. Proper voltage setting depends on your region.2. Unplug the AC power cord from the computer, wait 30 seconds, then plug the power cord back in to the computer.3. Replace the system board.4. Replace the processor.

Table C-2 Diagnostic Front Panel LEDs and Audible Codes (continued)

Activity	Beeps	Possible Cause	Recommended Action
Red Power LED flashes ten times, once every second, followed by a two second pause. Beeps stop after fifth iteration but LEDs continue until problem is solved.	10	Bad option card.	<ol style="list-style-type: none">1. Check each option card by removing the card (one at a time if multiple cards), then power on the system to see if fault goes away.2. Once a bad card is identified, remove and replace the bad option card.3. Replace the system board.
Red Power LED flashes eleven times, once every second, followed by a two second pause. Beeps stop after fifth iteration but LEDs continue until problem is solved.	11	The current processor does not support a feature previously enabled on this system.	<ol style="list-style-type: none">1. Install a TXT capable processor.2. Disable TXT in the Computer Setup (F10) utility.3. Reinstall the original processor.
System does not power on and LEDs are not flashing.	None	System unable to power on.	<p>Press and hold the power button for less than 4 seconds. If the hard drive LED turns green, the power button is working correctly. Try the following:</p> <ol style="list-style-type: none">1. Check that the voltage selector (some models), located on the rear of the power supply, is set to the appropriate voltage. Proper voltage setting depends on your region.2. Replace the system board. <p>OR</p> <p>Press and hold the power button for less than 4 seconds. If the hard drive LED does not turn on green then:</p> <ol style="list-style-type: none">1. Check that the unit is plugged into a working AC outlet.2. Open hood and check that the power button harness is properly connected to the system board.3. Check that both power supply cables are properly connected to the system board.4. Check to see if the 5V_aux light on the system board is turned on. If it is turned on, then replace the power button harness. If the problem persists, replace the system board.5. If the 5V_aux light on the system board is not turned on, remove the expansion cards one at a time until the 5V_aux light on the system board turns on. If the problem persists, replace the power supply.

D Troubleshooting Without Diagnostics

This chapter provides information on how to identify and correct minor problems, such as diskette drive, hard drive, optical drive, graphics, audio, memory, and software problems. If you encounter problems with the computer, refer to the tables in this chapter for probable causes and recommended solutions.

Safety and Comfort

 **WARNING!** Misuse of the computer or failure to establish a safe and comfortable work environment may result in discomfort or serious injury. Refer to the *Safety & Comfort Guide* at <http://www.hp.com/ergo> for more information on choosing a workspace and creating a safe and comfortable work environment. For more information, refer to the *Safety & Regulatory Information* guide.

Before You Call for Technical Support

If you are having problems with the computer, try the appropriate solutions below to try to isolate the exact problem before calling for technical support.

- Run the HP diagnostic tool.
- Run the hard drive self-test in Computer Setup. Refer to [Computer Setup \(F10\) Utility on page 7](#) for more information.
- Check the Power LED on the front of the computer to see if it is flashing red. The flashing lights are error codes that will help you diagnose the problem. Refer to Appendix A, [POST Error Messages on page 127](#) for more information.
- If the screen is blank, plug the monitor into a different video port on the computer if one is available. Or, replace the monitor with a monitor that you know is functioning properly.
- If you are working on a network, plug another computer with a different cable into the network connection. There may be a problem with the network plug or cable.
- If you recently added new hardware, remove the hardware and see if the computer functions properly.
- If you recently installed new software, uninstall the software and see if the computer functions properly.
- Boot the computer to the Safe Mode to see if it will boot without all of the drivers loaded. When booting the operating system, use “Last Known Configuration.”

- Refer to the comprehensive online technical support at <http://www.hp.com/support>.
- Refer to [Helpful Hints on page 141](#) in this guide.

To assist you in resolving problems online, HP Instant Support Professional Edition provides you with self-solve diagnostics. If you need to contact HP support, use HP Instant Support Professional Edition's online chat feature. Access HP Instant Support Professional Edition at: <http://www.hp.com/go/ispe>.

Access the Business Support Center (BSC) at <http://www.hp.com/go/bizsupport> for the latest online support information, software and drivers, proactive notification, and worldwide community of peers and HP experts.

If it becomes necessary to call for technical assistance, be prepared to do the following to ensure that your service call is handled properly:

- Be in front of your computer when you call.
- Write down the computer serial number, product ID number, and monitor serial number before calling.
- Spend time troubleshooting the problem with the service technician.
- Remove any hardware that was recently added to your system.
- Remove any software that was recently installed.
- Restore the system from the Recovery Disc Set that you created or restore the system to its original factory condition in HP Backup and Recovery Manager.

 **CAUTION:** Restoring the system will erase all data on the hard drive. Be sure to back up all data files before running the restore process.

 **NOTE:** For sales information and warranty upgrades (Care Packs), call your local authorized service provider or dealer.

Helpful Hints

If you encounter problems with the computer, monitor, or software, see the following list of general suggestions before taking further action:

- Check that the computer and monitor are plugged into a working electrical outlet.
- Check that the voltage select switch (some models) is set to the appropriate voltage for your region (115V or 230V).
- Check that the computer is turned on and the green power light is on.
- Check that the monitor is turned on and the green monitor light is on.
- Check the Power LED on the front of the computer to see if it is flashing red. The flashing lights are error codes that will help you diagnose the problem. Refer to Appendix A, [POST Error Messages on page 127](#) for more information.
- Turn up the brightness and contrast controls of the monitor if the monitor is dim.
- Press and hold any key. If the system beeps, then the keyboard should be operating correctly.
- Check all cable connections for loose connections or incorrect connections.

- Wake the computer by pressing any key on the keyboard or pressing the power button. If the system remains in suspend mode, shut down the computer by pressing and holding the power button for at least four seconds then press the power button again to restart the computer. If the system will not shut down, unplug the power cord, wait a few seconds, then plug it in again. The computer will restart if it is set to power on automatically as soon as power is restored in Computer Setup. If it does not restart, press the power button to start the computer.
- Reconfigure the computer after installing a non-plug and play expansion board or other option. See [Solving Hardware Installation Problems on page 163](#) for instructions.
- Be sure that all the needed device drivers have been installed. For example, if you are using a printer, you need a driver for that model printer.
- Remove all bootable media (diskette, CD, or USB device) from the system before turning it on.
- If you have installed an operating system other than the factory-installed operating system, check to be sure that it is supported on the system.
- If the system has multiple video sources (embedded, PCI, or PCI-Express adapters) installed (embedded video on some models only) and a single monitor, the monitor must be plugged into the monitor connector on the source selected as the primary VGA adapter. During boot, the other monitor connectors are disabled and if the monitor is connected into these ports, the monitor will not function. You can select which source will be the default VGA source in Computer Setup.

 **CAUTION:** When the computer is plugged into an AC power source, there is always voltage applied to the system board. You must disconnect the power cord from the power source before opening the computer to prevent system board or component damage.

Solving General Problems

You may be able to easily resolve the general problems described in this section. If a problem persists and you are unable to resolve it yourself or if you feel uncomfortable about performing the operation, contact an authorized dealer or reseller.

⚠ WARNING! When the computer is plugged into an AC power source, voltage is always applied to the system board. To reduce the risk of personal injury from electrical shock and/or hot surfaces, be sure to disconnect the power cord from the wall outlet and allow the internal system components to cool before touching.

Table D-1 Solving General Problems

Computer appears locked up and will not turn off when the power button is pressed.	
Cause	Solution
Software control of the power switch is not functional.	<ol style="list-style-type: none">1. Press and hold the power button for at least four seconds until the computer turns off.2. Disconnect the power cord from the electrical outlet.

Computer will not respond to USB keyboard or mouse.	
Cause	Solution
Computer is in standby mode.	To resume from standby mode, press the power button or press any key. CAUTION: When attempting to resume from standby mode, do not hold down the power button for more than four seconds. Otherwise, the computer will shut down and you will lose any unsaved data.
System has locked up.	Restart computer.

Computer date and time display is incorrect.	
Cause	Solution
RTC (real-time clock) battery may need to be replaced. NOTE: Connecting the computer to a live AC outlet prolongs the life of the RTC battery.	First, reset the date and time under Control Panel (Computer Setup can also be used to update the RTC date and time). If the problem persists, replace the RTC battery. See the Removal and Replacement section for instructions on installing a new battery, or contact an authorized dealer or reseller for RTC battery replacement.

Cursor will not move using the arrow keys on the keypad.	
Cause	Solution
The Num Lock key may be on.	Press the Num Lock key. The Num Lock light should not be on if you want to use the arrow keys. The Num Lock key can be disabled (or enabled) in Computer Setup.

There is no sound or sound volume is too low.

Cause	Solution
System volume may be set low or muted.	<ol style="list-style-type: none">1. Check the F10 BIOS settings to make sure the internal system speaker is not muted (this setting does not affect the external speakers).2. Make sure the external speakers are properly connected and powered on and that the speakers' volume control is set correctly.3. Use the system volume control available in the operating system to make sure the speakers are not muted or to increase the volume.

Poor performance is experienced.

Cause	Solution
Processor is hot.	<ol style="list-style-type: none">1. Make sure airflow to the computer is not blocked. Leave a 10.2-cm (4-inch) clearance on all vented sides of the computer and above the monitor to permit the required airflow.2. Make sure fans are connected and working properly (some fans only operate when needed).3. Make sure the processor heat sink is installed properly.
Hard drive is full.	Transfer data from the hard drive to create more space on the hard drive.
Low on memory.	Add more memory.
Hard drive fragmented.	Defragment hard drive.
Program previously accessed did not release reserved memory back to the system.	Restart the computer.
Virus resident on the hard drive.	Run virus protection program.
Too many applications running.	<ol style="list-style-type: none">1. Close unnecessary applications to free up memory.2. Add more memory. Some applications run in the background and can be closed by right-clicking on their corresponding icons in the task tray. To prevent these applications from launching at startup, go to Start > All Programs > Accessories > Run and type <code>msconfig</code>. On the Startup tab of the System Configuration Utility, clear applications that you do not want to launch automatically.
Some software applications, especially games, are stressful on the graphics subsystem	<ol style="list-style-type: none">1. Lower the display resolution for the current application or consult the documentation that came with the application for suggestions on how to improve performance by adjusting parameters in the application.2. Add more memory.3. Upgrade the graphics solution.
Cause unknown.	Restart the computer.

Computer powered off automatically and the Power LED flashes Red two times, once every second, followed by a two second pause, and the computer beeps two times. (Beeps stop after fifth iteration but LEDs continue flashing).

Cause	Solution
Processor thermal protection activated: A fan may be blocked or not turning. OR The heat sink is not properly attached to the processor.	<ol style="list-style-type: none">1. Ensure that the computer air vents are not blocked and the processor cooling fan is running.2. Open hood, press power button, and see if the processor fan spins. If the processor fan is not spinning, make sure the fan's cable is plugged onto the system board header.3. If fan is plugged in, but is not spinning, then replace the heat sink/fan assembly.4. Contact an authorized reseller or service provider.

System does not power on and the LEDs on the front of the computer are not flashing.

Cause	Solution
System unable to power on.	<p>Press and hold the power button for less than 4 seconds. If the hard drive LED turns green, then:</p> <ol style="list-style-type: none">1. Check that the voltage selector, located on the rear of the power supply on some models, is set to the appropriate voltage. Proper voltage setting depends on your region.2. Remove the expansion cards one at a time until the 5V_aux light on the system board turns on.3. Replace the system board. <p>OR</p> <p>Press and hold the power button for less than 4 seconds. If the hard drive LED does not turn on green then:</p> <ol style="list-style-type: none">1. Check that the unit is plugged into a working AC outlet.2. Open hood and check that the power button harness is properly connected to the system board.3. Check that both power supply cables are properly connected to the system board.4. Check to see if the 5V_aux light on the system board is turned on. If it is turned on, then replace the power button harness.5. If the 5V_aux light on the system board is off, then replace the power supply.6. Replace the system board.

Solving Power Problems

Common causes and solutions for power problems are listed in the following table.

Table D-2 Solving Power Problems

Power supply shuts down intermittently.

Cause	Solution
Voltage selector switch on rear of computer chassis (some models) not switched to correct line voltage (115V or 230V).	Select the proper AC voltage using the selector switch.
Power supply will not turn on because of internal power supply fault.	Contact an authorized service provider to replace the power supply.

Computer powered off automatically and the Power LED flashes Red two times, once every second, followed by a two second pause, and the computer beeps two times. (Beeps stop after fifth iteration but LEDs continue flashing.)

Cause	Solution
Processor thermal protection activated: A fan may be blocked or not turning. OR The heat sink is not properly attached to the processor.	<ol style="list-style-type: none">1. Ensure that the computer air vents are not blocked and the processor cooling fan is running.2. Open hood, press power button, and see if the processor fan spins. If the processor fan is not spinning, make sure the fan's cable is plugged onto the system board header.3. If fan is plugged in, but is not spinning, then replace the heat sink/fan assembly.4. Contact an authorized reseller or service provider.

Power LED flashes Red four times, once every second, followed by a two second pause, and the computer beeps four times. (Beeps stop after fifth iteration but LEDs continue flashing.)

Cause	Solution
Power failure (power supply is overloaded).	<ol style="list-style-type: none">1. Check that the voltage selector, located on the rear of the power supply (some models), is set to the appropriate voltage. Proper voltage setting depends on your region.2. Open the hood and ensure the 4- or 6-wire power supply cable is seated into the connector on the system board.3. Check if a device is causing the problem by removing ALL attached devices (such as hard, diskette, or optical drives, and expansion cards). Power on the system. If the system enters the POST, then power off and replace one device at a time and repeat this procedure until failure occurs. Replace the device that is causing the failure. Continue adding devices one at a time to ensure all devices are functioning properly.4. Replace the power supply.5. Replace the system board.

Solving Diskette Problems

Common causes and solutions for diskette problems are listed in the following table.

 **NOTE:** The computer does not support internal diskette drives. Only USB diskette drives are supported.

 **NOTE:** You may need to reconfigure the computer when you add or remove hardware, such as an additional diskette drive. See [Solving Hardware Installation Problems on page 163](#) for instructions.

Table D-3 Solving Diskette Problems

Diskette drive light stays on.	
Cause	Solution
Diskette is damaged.	Right-click Start , click Explore , and right-click on a drive. Select Properties then select the Tools tab. Under Error-checking click Check Now .
Diskette is incorrectly inserted.	Remove diskette and reinsert.
Drive cable is not properly connected.	Reconnect drive cable. Ensure that all four pins on the diskette power cable are connected to the drive.

Drive not found.	
Cause	Solution
Cable is loose.	Reseat diskette drive data and power cable.
Removable drive is not seated properly.	Reseat the drive.
The device has been hidden in Computer Setup.	Run the Computer Setup utility and ensure Device Available is selected for the Legacy Diskette in Security > Device Security .

Diskette drive cannot write to a diskette.	
Cause	Solution
Diskette is not formatted.	Format the diskette. <ol style="list-style-type: none">1. From Windows Explorer select the disk (A) drive.2. Right-click the drive letter and select Format.3. Select the desired options, and click Start to begin formatting the diskette.
Diskette is write-protected.	Use another diskette or remove the write protection.
Writing to the wrong drive.	Check the drive letter in the path statement.
Not enough space is left on the diskette.	<ol style="list-style-type: none">1. Use another diskette.2. Delete unneeded files from diskette.
Diskette is damaged.	Replace the damaged disk.

Cannot format diskette.

Cause	Solution
Invalid media reported.	When formatting a disk in MS-DOS, you may need to specify diskette capacity. For example, to format a 1.44-MB diskette, type the following command at the MS-DOS prompt: FORMAT A: /F:1440
Disk may be write-protected.	Open the locking device on the diskette.
Legacy diskette writes are disabled in Computer Setup.	Enter Computer Setup and enable Legacy Diskette Write in Storage > Storage Options .

A problem has occurred with a disk transaction.

Cause	Solution
The directory structure is bad, or there is a problem with a file.	Right-click Start , click Explore , and right-click on a drive. Select Properties then select the Tools tab. Under Error-checking click Check Now .

Diskette drive cannot read a diskette.

Cause	Solution
You are using the wrong diskette type for the drive type.	Check the type of drive that you are using and use the correct diskette type.
You are reading the wrong drive.	Check the drive letter in the path statement.
Diskette is damaged.	Replace the diskette with a new one.

"Invalid system disk" message is displayed.

Cause	Solution
A diskette that does not contain the system files needed to start the computer has been inserted in the drive.	When drive activity stops, remove the diskette and press the Spacebar . The computer should start up.
Diskette error has occurred.	Restart the computer by pressing the power button.

Cannot Boot to Diskette.

Cause	Solution
Diskette is not bootable.	Replace with a bootable diskette.

Table D-3 Solving Diskette Problems (continued)

Cause	Solution
Diskette boot has been disabled in Computer Setup.	<ol style="list-style-type: none">1. Run Computer Setup and enable USB device in Storage > Boot Order.2. Run Computer Setup and enable USB device in Storage > Storage Options > Removable Media Boot. <p>NOTE: Both steps should be used as the Removable Media Boot function in Computer Setup overrides the Boot Order enable command.</p>
Network server mode is enabled in Computer Setup.	Run Computer Setup and disable Network Server Mode in Security > Password Options .

Solving Hard Drive Problems

Table D-4 Solving Hard Drive Problems

Cause	Solution
Hard drive error occurs.	
Hard disk has bad sectors or has failed.	<ol style="list-style-type: none">1. Right-click Start, click Explore, and right-click on a drive. Select Properties then select the Tools tab. Under Error-checking click Check Now.2. Use a utility to locate and block usage of bad sectors. If necessary, reformat the hard disk.
Disk transaction problem.	
Either the directory structure is bad or there is a problem with a file.	Right-click Start , click Explore , and right-click on a drive. Select Properties then select the Tools tab. Under Error-checking click Check Now .
Drive not found (identified).	
Cable could be loose.	Check cable connections.

Table D-4 Solving Hard Drive Problems (continued)**Drive not found (identified).**

Cause	Solution
The system may not have automatically recognized a newly installed device.	See reconfiguration directions in the Solving Hardware Installation Problems on page 163 section. If the system still does not recognize the new device, check to see if the device is listed within Computer Setup. If it is listed, the probable cause is a driver problem. If it is not listed, the probable cause is a hardware problem. If this is a newly installed drive, run the Computer Setup utility and try adding a POST delay under Advanced > Power-On .
The device is attached to a SATA port that has been hidden in Computer Setup.	Run the Computer Setup utility and ensure Device Available is selected for the device's SATA port in Security > Device Security .
Drive responds slowly immediately after power-up.	Run Computer Setup and increase the POST Delay in Advanced > Power-On Options .

Nonsystem disk/NTLDR missing message.

Cause	Solution
The system is trying to start from a diskette that is not bootable.	Remove the diskette from the diskette drive.
The system is trying to start from the hard drive but the hard drive may have been damaged.	<ol style="list-style-type: none"> 1. Insert a bootable diskette into the diskette drive and restart the computer. 2. Check the hard drive format using fdisk: If NTFS formatting, use a third party reader to evaluate the drive. If FAT32 formatting, the hard drive cannot be accessed.
System files missing or not properly installed.	<ol style="list-style-type: none"> 1. Insert a bootable diskette into the diskette drive and restart the computer. 2. Check the hard drive format using Fdisk: If NTFS formatting, use a third party reader to evaluate the drive. If FAT32 formatting, the hard drive cannot be accessed. 3. Install system files for the appropriate operating system.
Hard drive boot has been disabled in Computer Setup.	Run the Computer Setup utility and enable the hard drive entry in the Storage > Boot Order list.
Bootable hard drive is not attached as first in a multi-hard drive configuration.	If attempting to boot from a hard drive, ensure it is attached to the system board dark blue SATA connector.
Bootable hard drive's controller is not listed first in the Boot Order.	Run the Computer Setup utility and select Storage > Boot Order and ensure the bootable hard drive's controller is listed immediately under the Hard Drive entry.

Computer will not boot from hard drive.

Cause	Solution
The device is attached to a SATA port that has been hidden in Computer Setup.	Run the Computer Setup utility and ensure Device Available is selected for the device's SATA port in Security > Device Security .
Boot order is not correct.	Run the Computer Setup utility and change boot sequence in Storage > Boot Order .
Hard Drive's "Emulation Type" is set to "None."	Run the Computer Setup utility and change the "Emulation Type" to "Hard Disk" in the device's details under Storage > Device Configuration .
Hard drive is damaged.	Observe if the front panel Power LED is blinking RED and if any beeps are heard. See Appendix A, POST Error Messages on page 127 to determine possible causes for the blinking red and beep codes. See the Worldwide Limited Warranty for terms and conditions.

Computer seems to be locked up.

Cause	Solution
Program in use has stopped responding to commands.	Attempt the normal Windows "Shut Down" procedure. If this fails, press the power button for four or more seconds to turn off the power. To restart the computer, press the power button again.

The removable hard drive has no power to the hard drive enclosure.

Cause	Solution
The lock on the enclosure is not turned to the "ON" position.	Insert the key and turn the lock clockwise 90 degrees. The green LED on the front of the enclosure should be on.
Power cable from the computer power supply to the enclosure frame is not properly connected.	Check the power supply to make sure it is properly connected to the rear of the enclosure frame.

The removable hard drive is not recognized by the computer.

Cause	Solution
The removable hard drive carrier is not fully seated in the enclosure frame or the hard drive is not fully seated in the carrier.	Push the carrier into the enclosure frame so that the connector on the rear of the frame is properly seated. If this does not solve the problem, turn off the computer, remove the carrier, and check to see if the connector on the hard drive is properly seated in the carrier.

The removable hard drive enclosure is beeping and the green LED is flashing.

Cause	Solution
Fan failure alarm on the removable hard drive enclosure has been activated.	Shut down the computer and contact HP for a replacement enclosure.

Solving Media Card Reader Problems

Table D-5 Solving Media Card Reader Problems

A write-protected or locked error occurs when attempting to write to the media card.

Cause	Solution
Media card is locked. Locking the media card is a safety feature that prevents writing to and deleting from an SD/Memory Stick/PRO card.	If using an SD card, make sure that the lock tab located on the right of the SD card is not in the locked position. If using a Memory Stick/PRO card, make sure that the lock tab located on the bottom of the Memory Stick/PRO card is not in the locked position.

Can not write to the media card.

Cause	Solution
The media card is a read-only memory (ROM) card.	Check the manufacturer's documentation included with your card to see if it writable. Refer to the previous section for a list of compatible cards.
Media card is locked. Locking the media card is a safety feature that prevents writing to and deleting from an SD/Memory Stick/PRO card.	If using an SD card, make sure that the lock tab located on the right of the SD card is not in the locked position. If using a Memory Stick/PRO card, make sure that the lock tab located on the bottom of the Memory Stick/PRO card is not in the locked position.

Unable to access data on the media card after inserting it into a slot.

Cause	Solution
The media card is not inserted properly, is inserted in the wrong slot, or is not supported.	Ensure that the card is inserted properly with the gold contact on the correct side. The green LED will light if inserted properly.

Do not know how to remove a media card correctly.

Cause	Solution
The computer's software is used to safely eject the card.	Open Computer , right-click on the corresponding drive icon, and select Eject . Then pull the card out of the slot. NOTE: Never remove the card when the green LED is flashing

After installing the media card reader and booting to Windows, the reader and the inserted cards are not recognized by the computer.

Cause	Solution
The operating system needs time to recognize the device if the reader was just installed into the computer and you are turning the PC on for the first time.	Wait a few seconds so that the operating system can recognize the reader and the available ports, and then recognize whatever media is inserted in the reader.

After inserting a media card in the reader, the computer attempts to boot from the media card.

Cause	Solution
The inserted media card has boot capability.	If you do not want to boot from the media card, remove it during boot or do not select the option to boot from the inserted media card during the boot process.

Solving Display Problems

If you encounter display problems, see the documentation that came with the monitor and to the common causes and solutions listed in the following table.

Table D-6 Solving Display Problems

Blank screen (no video).

Cause	Solution
Monitor is not turned on and the monitor light is not on.	Turn on the monitor and check that the monitor light is on.
Bad monitor.	Try a different monitor.
The cable connections are not correct.	Check the cable connection from the monitor to the computer and to the electrical outlet.
You may have a screen blanking utility installed or energy saver features are enabled.	Press any key or click the mouse button and, if set, type your password.
System ROM is corrupted; system is running in Boot Block Emergency Recovery Mode (indicated by eight beeps).	Reflash the system ROM with the latest BIOS image.
You are using a fixed-sync monitor and it will not sync at the resolution chosen.	Be sure that the monitor can accept the same horizontal scan rate as the resolution chosen.
Computer is in standby mode.	Press the power button to resume from standby mode. CAUTION: When attempting to resume from standby mode, do not hold down the power button for more than four seconds. Otherwise, the computer will shut down and you will lose any unsaved data.
Monitor cable is plugged into the wrong connector.	Systems may have a monitor connection on both the motherboard or an add-in card. Try moving the monitor connection to a different connector on the back of the computer

Table D-6 Solving Display Problems (continued)**Blank screen (no video).**

Cause	Solution
Monitor settings in the computer are not compatible with the monitor.	<ol style="list-style-type: none"> 1. In Control Panel, under Appearance and Personalization, select Adjust screen resolution. 2. Use the sliding control to reset the resolution.
Monitor is configured to use an input that is not active.	Use the monitor's on-screen menu controls to select the input that is being driven by the system. Refer to the monitor's user documentation for more information on the on-screen controls and settings.

Blank screen and the power LED flashes Red five times, once every second, followed by a two second pause, and the computer beeps five times. (Beeps stop after fifth iteration but LEDs continue flashing.)

Cause	Solution
Pre-video memory error.	<ol style="list-style-type: none"> 1. Reseat DIMMs. Power on the system. 2. Replace DIMMs one at a time to isolate the faulty module. 3. Replace third-party memory with HP memory. 4. Replace the system board.

Blank screen and the power LED flashes Red six times, once every second, followed by a two second pause, and the computer beeps six times. (Beeps stop after fifth iteration but LEDs continue flashing.)

Cause	Solution
Pre-video graphics error.	<p>For systems with a graphics card:</p> <ol style="list-style-type: none"> 1. Reseat the graphics card. Power on the system. 2. Replace the graphics card. 3. Replace the system board. <p>For systems with integrated graphics, replace the system board.</p>

Blank screen and the power LED flashes Red seven times, once every second, followed by a two second pause, and the computer beeps seven times. (Beeps stop after fifth iteration but LEDs continue flashing.)

Cause	Solution
System board failure (ROM detected failure prior to video).	Replace the system board.

Monitor does not function properly when used with energy saver features.

Cause	Solution
Monitor without energy saver capabilities is being used with energy saver features enabled.	Disable monitor energy saver feature.

Dim characters.

Cause	Solution
The brightness and contrast controls are not set properly.	Adjust the monitor brightness and contrast controls.
Cables are not properly connected.	Check that the graphics cable is securely connected to the graphics card and the monitor.

Blurry video or requested resolution cannot be set.

Cause	Solution
If the graphics controller was upgraded, the correct graphics drivers may not be loaded.	Install the video drivers included in the upgrade kit.
Monitor is not capable of displaying requested resolution.	Change requested resolution.
Graphics card is bad.	Replace the graphics card.

The picture is broken up, rolls, jitters, or flashes.

Cause	Solution
The monitor connections may be incomplete or the monitor may be incorrectly adjusted.	<ol style="list-style-type: none">1. Be sure the monitor cable is securely connected to the computer.2. In a two-monitor system or if another monitor is in close proximity, be sure the monitors are not interfering with each other's electromagnetic field by moving them apart.3. Fluorescent lights or fans may be too close to the monitor.
Monitor needs to be degaussed.	Degauss the monitor. Refer to the documentation that came with the monitor for instructions.

Image is not centered.

Cause	Solution
Position may need adjustment.	Press the monitor's Menu button to access the OSD menu. Select ImageControl/ Horizontal Position or Vertical Position to adjust the horizontal or vertical position of the image.

“No Connection, Check Signal Cable” displays on screen.

Cause	Solution
Monitor video cable is disconnected.	Connect the video cable between the monitor and computer. CAUTION: Ensure that the computer power is off while connecting the video cable.

“Out of Range” displays on screen.

Cause	Solution
Video resolution and refresh rate are set higher than what the monitor supports.	Restart the computer and enter Safe Mode. Change the settings to a supported setting then restart the computer so that the new settings take effect.

Vibrating or rattling noise coming from inside a CRT monitor when powered on.

Cause	Solution
Monitor degaussing coil has been activated.	None. It is normal for the degaussing coil to be activated when the monitor is powered on.

Clicking noise coming from inside a CRT monitor.

Cause	Solution
Electronic relays have been activated inside the monitor.	None. It is normal for some monitors to make a clicking noise when turned on and off, when going in and out of standby mode, and when changing resolutions.

High pitched noise coming from inside a flat panel monitor.

Cause	Solution
Brightness and/or contrast settings are too high.	Lower brightness and/or contrast settings.

Fuzzy focus; streaking, ghosting, or shadowing effects; horizontal scrolling lines; faint vertical bars; or unable to center the picture on the screen (flat panel monitors using an analog VGA input connection only).

Cause	Solution
Flat panel monitor's internal digital conversion circuits may be unable to correctly interpret the output synchronization of the graphics card.	<ol style="list-style-type: none">1. Select the monitor's Auto-Adjustment option in the monitor's on-screen display menu.2. Manually synchronize the Clock and Clock Phase on-screen display functions. To download a SoftPak that will assist you with the synchronization, go to the following Web site, select the appropriate monitor, and download either SP32347 or SP32202: http://www.hp.com/support
Graphics card is not seated properly or is bad.	<ol style="list-style-type: none">1. Reseat the graphics card.2. Replace the graphics card.

Certain typed symbols do not appear correct.

Cause	Solution
The font you are using does not support that particular symbol.	Use the Character Map to locate and select the appropriate symbol. Click Start > All Programs > Accessories > System Tools > Character Map . You can copy the symbol from the Character Map into a document.

Solving Audio Problems

If the computer has audio features and you encounter audio problems, see the common causes and solutions listed in the following table.

Table D-7 Solving Audio Problems

Sound cuts in and out.

Cause	Solution
Processor resources are being used by other open applications.	Shut down all open processor-intensive applications.

Sound does not come out of the speaker or headphones.

Cause	Solution
Software volume control is turned down or muted.	Double-click the Speaker icon on the taskbar, then make sure that Mute is not selected and use the volume slider to adjust the volume.
Audio is hidden in Computer Setup.	Enable the audio in Computer Setup: Security > Device Security > System Audio .
The external speakers are not turned on.	Turn on the external speakers.
The audio device may be connected to the wrong jack.	Ensure that the device is connected to the correct jack on the computer. The speakers should be plugged into the rear line-out jack and the headphones should be plugged into the front headphone jack.
External speakers plugged into the wrong audio jack on a recently installed sound card.	See the sound card documentation for proper speaker connection.
Digital CD audio is not enabled.	Enable digital CD audio. In the Device Manager, right-click on the CD/DVD device and select Properties . Make sure Enable digital CD audio for this CD-ROM device is checked.
Headphones or devices connected to the line-out connector mute the internal speaker.	Turn on and use headphones or external speakers, if connected, or disconnect headphones or external speakers.
Computer is in standby mode.	Press the power button to resume from standby mode. CAUTION: When attempting to resume from standby mode, do not hold down the power button for more than four seconds. Otherwise, the computer will shut down and you will lose any unsaved data.
Internal speaker is disabled in Computer Setup.	Enable the internal speaker in Computer Setup. Select Advanced > Device Options > Internal Speaker .
The application is set to use a different audio device than speakers.	Some graphics cards support audio over the DisplayPort connection, so multiple audio devices may be listed in Device Manager. Make sure the correct device is being used.

Table D-7 Solving Audio Problems (continued)

Sound does not come out of the speaker or headphones.

Cause	Solution
Some applications can select which audio output device is used.	Make sure the application has selected the correct audio device.
The operating system controls may be set to use a different audio device as the default output device than what is expected.	Set the operating system to use the correct audio device.

Sound from headphones is not clear or muffled.

Cause	Solution
Headphones are plugged into the rear audio output connector. The rear audio output connector is for powered audio devices and is not designed for headphone use.	Plug the headphones into the headphone connector on the front of the computer.

Computer appears to be locked up while recording audio.

Cause	Solution
The hard disk may be full.	Before recording, make sure there is enough free space on the hard disk. You can also try recording the audio file in a compressed format.

Line-in jack is not functioning properly.

Cause	Solution
Jack has been reconfigured in the audio driver or application software.	In the audio driver or application software, reconfigure the jack or set the jack to its default value.

There is no sound or sound volume is too low.

Cause	Solution
The application is set to use a different audio device than speakers.	Some graphics cards support audio over the DisplayPort connection, so multiple audio devices may be listed in Device Manager. Make sure the correct device is being used.
Some applications can select which audio output device is used.	Make sure the application has selected the correct audio device.
The operating system controls may be set to use a different audio device as the default output device than what is expected.	Set the operating system to use the correct audio device.

Solving Printer Problems

If you encounter printer problems, see the documentation that came with the printer and to the common causes and solutions listed in the following table.

Table D-8 Solving Printer Problems

Printer will not print.

Cause	Solution
Printer is not turned on and online.	Turn the printer on and make sure it is online.
The correct printer drivers for the application are not installed.	<ol style="list-style-type: none">1. Install the correct printer driver for the application.2. Try printing using the MS-DOS command: <pre>DIR C:\ > [printer port]</pre>where [printer port] is the address of the printer being used. If the printer works, reload the printer driver.
If you are on a network, you may not have made the connection to the printer.	Make the proper network connections to the printer.
Printer may have failed.	Run printer self-test.

Printer will not turn on.

Cause	Solution
The cables may not be connected properly.	Reconnect all cables and check the power cord and electrical outlet.

Printer prints garbled information.

Cause	Solution
The correct printer driver for the application is not installed.	Install the correct printer driver for the application.
The cables may not be connected properly.	Reconnect all cables.
Printer memory may be overloaded.	Reset the printer by turning it off for one minute, then turn it back on.

Printer is offline.

Cause	Solution
The printer may be out of paper.	Check the paper tray and refill it if it is empty. Select online.

Solving Keyboard and Mouse Problems

If you encounter keyboard or mouse problems, see the documentation that came with the equipment and to the common causes and solutions listed in the following table.

Table D-9 Solving Keyboard Problems

Keyboard commands and typing are not recognized by the computer.

Cause	Solution
Keyboard connector is not properly connected.	<ol style="list-style-type: none">1. On the Desktop, click Start, click the arrow on the lower right corner of the Start menu, then select Shut Down.2. After the shutdown is complete, reconnect the keyboard to the back of the computer and restart the computer.
Program in use has stopped responding to commands.	Shut down your computer using the mouse and then restart the computer.
Keyboard needs repairs.	See the Worldwide Limited Warranty for terms and conditions.
Computer is in standby mode.	Press the power button to resume from standby mode. CAUTION: When attempting to resume from standby mode, do not hold down the power button for more than four seconds. Otherwise, the computer will shut down and you will lose any unsaved data.

Cursor will not move using the arrow keys on the keypad.

Cause	Solution
The Num Lock key may be on.	Press the Num Lock key. The Num Lock light should not be on if you want to use the arrow keys. The Num Lock key can be disabled (or enabled) in Computer Setup.

Table D-10 Solving Mouse Problems

Mouse does not respond to movement or is too slow.

Cause	Solution
Mouse connector is not properly plugged into the back of the computer.	Shut down the computer using the keyboard. <ol style="list-style-type: none">1. Press the Ctrl and Esc keys at the same time (or press the Windows logo key) to display the Start menu.2. Use the arrow keys to select Shut Down and then press the Enter key.3. After the shutdown is complete, plug the mouse connector into the back of the computer (or the keyboard) and restart.
Program in use has stopped responding to commands.	Shut down the computer using the keyboard then restart the computer.

Table D-10 Solving Mouse Problems (continued)

Mouse does not respond to movement or is too slow.

Cause	Solution
Mouse may need cleaning.	Remove the roller ball cover on the mouse and clean the internal components.
Mouse may need repair.	See the Worldwide Limited Warranty for terms and conditions.
Computer is in standby mode.	Press the power button to resume from standby mode. CAUTION: When attempting to resume from standby mode, do not hold down the power button for more than four seconds. Otherwise, the computer will shut down and you will lose any unsaved data.

Mouse will only move vertically, horizontally, or movement is jerky.

Cause	Solution
Mouse roller ball or the rotating encoder shafts that make contact with the ball are dirty.	Remove roller ball cover from the bottom of the mouse and clean the internal components with a mouse cleaning kit available from most computer stores.

Solving Hardware Installation Problems

You may need to reconfigure the computer when you add or remove hardware, such as an additional drive or expansion card. If you install a plug and play device, Windows automatically recognizes the device and configures the computer. If you install a non–plug and play device, you must reconfigure the computer after completing installation of the new hardware. In Windows, use the **Add Hardware Wizard** and follow the instructions that appear on the screen.

⚠ WARNING! When the computer is plugged into an AC power source, voltage is always applied to the system board. To reduce the risk of personal injury from electrical shock and/or hot surfaces, be sure to disconnect the power cord from the wall outlet and allow the internal system components to cool before touching.

Table D-11 Solving Hardware Installation Problems

Cause	Solution
Device is not seated or connected properly.	Ensure that the device is properly and securely connected and that pins in the connector are not bent down.
Cable(s) of new external device are loose or power cables are unplugged.	Ensure that all cables are properly and securely connected and that pins in the cable or connector are not bent down.
Power switch of new external device is not turned on.	Turn off the computer, turn on the external device, then turn on the computer to integrate the device with the computer system.
When the system advised you of changes to the configuration, you did not accept them.	Reboot the computer and follow the instructions for accepting the changes.
A plug and play board may not automatically configure when added if the default configuration conflicts with other devices.	Use Windows Device Manager to deselect the automatic settings for the board and choose a basic configuration that does not cause a resource conflict. You can also use Computer Setup to reconfigure or disable devices to resolve the resource conflict.
USB ports on the computer are disabled in Computer Setup.	Run the Computer Setup utility and ensure that Device available is selected for appropriate USB ports under Security > USB Security .

Cause	Solution
Wrong memory modules were used in the upgrade or memory modules were installed in the wrong location.	<ol style="list-style-type: none">1. Review the documentation that came with the system to determine if you are using the correct memory modules and to verify the proper installation. NOTE: DIMM1 or XMM1 must always be installed.2. Observe the beeps and LED lights on the front of the computer. Beeps and flashing LEDs are codes for specific problems.3. If you still cannot resolve the issue, contact Customer Support.

Power LED flashes Red five times, once every second, followed by a two second pause, and the computer beeps five times. (Beeps stop after fifth iteration but LEDs continue flashing.)

Cause	Solution
Memory is installed incorrectly or is bad.	<p>CAUTION: To avoid damage to the DIMMs or the system board, you must unplug the computer power cord before attempting to reseat, install, or remove a DIMM module.</p> <ol style="list-style-type: none">1. Reseat DIMMs. Power on the system.2. Replace DIMMs one at a time to isolate the faulty module. <p>NOTE: DIMM1 or XMM1 must always be installed.</p> <ol style="list-style-type: none">3. Replace third-party memory with HP memory.4. Replace the system board.

Power LED flashes Red six times, once every second, followed by a two second pause, and the computer beeps six times. (Beeps stop after fifth iteration but LEDs continue flashing.)

Cause	Solution
Graphics card is not seated properly or is bad, or system board is bad.	<p>For systems with a graphics card:</p> <ol style="list-style-type: none">1. Reseat the graphics card. Power on the system.2. Replace the graphics card.3. Replace the system board. <p>For systems with integrated graphics, replace the system board.</p>

Power LED flashes Red ten times, once every second, followed by a two second pause, and the computer beeps ten times. (Beeps stop after fifth iteration but LEDs continue flashing.)

Cause	Solution
Bad option card.	<ol style="list-style-type: none">1. Check each option card by removing the cards one at time (if multiple cards), then power on the system to see if fault goes away.2. Once bad card is identified, remove and replace bad option card.3. Replace the system board.

Solving Network Problems

Some common causes and solutions for network problems are listed in the following table. These guidelines do not discuss the process of debugging the network cabling.

Table D-12 Solving Network Problems

Cause	Solution
Wake-on-LAN feature is not functioning.	
S5 Maximum Power Saving feature is enabled.	Disable the S5 Maximum Power Saving option in Computer Setup. Select Power > Hardware Power Management > S5 Maximum Power Saving .
S5 Wake on LAN is disabled.	: Enable the S5 Wake on LAN option in Computer Setup. Select Advanced > Device Options > S5 Wake on LAN .
Wake-on-LAN is not enabled.	To enable Wake-on-LAN: <ol style="list-style-type: none">1. Select Start > Control Panel.2. Under Network and Internet, select View network status and tasks.3. Click Local Area Connection.4. Click the Properties button.5. Click the Configure button.6. Click the Power Management tab, then select the check box to Allow this device to wake the computer.

Cause	Solution
Network driver does not detect network controller.	
Network controller is disabled.	<ol style="list-style-type: none">1. Run Computer Setup and enable network controller.2. Enable the network controller in the operating system via Device Manager.
Incorrect network driver.	Check the network controller documentation for the correct driver or obtain the latest driver from the manufacturer's Web site.

Cause	Solution
Network status link light never flashes.	
NOTE: The network status light is supposed to flash when there is network activity.	
No active network is detected.	Check cabling and network equipment for proper connection.
Network controller is not set up properly.	Check for the device status within Windows, such as Device Manager for driver load and the Network Connections applet within Windows for link status.

Table D-12 Solving Network Problems (continued)**Network status link light never flashes.****NOTE:** The network status link light is supposed to flash when there is network activity.

Cause	Solution
Network controller is disabled.	<ol style="list-style-type: none"> 1. Run Computer Setup and enable network controller. 2. Enable the network controller in the operating system via Device Manager.
Network driver is not properly loaded.	Reinstall network drivers.
System cannot autosense the network.	Disable auto-sensing capabilities and force the system into the correct operating mode.

Diagnostics reports a failure.

Cause	Solution
The cable is not securely connected.	Ensure that the cable is securely attached to the network connector and that the other end of the cable is securely attached to the correct device.
The cable is attached to the incorrect connector.	Ensure that the cable is attached to the correct connector.
There is a problem with the cable or a device at the other end of the cable.	Ensure that the cable and device at the other end are operating correctly.
Network controller interrupt is shared with an expansion board.	Under the Computer Setup Advanced menu, change the resource settings for the board.
The network controller is defective.	Contact an authorized service provider.

Diagnostics passes, but the computer does not communicate with the network.

Cause	Solution
Network drivers are not loaded, or driver parameters do not match current configuration.	<p>Make sure the network drivers are loaded and that the driver parameters match the configuration of the network controller.</p> <p>Make sure the correct network client and protocol is installed.</p>
The network controller is not configured for this computer.	Select the Network icon in the Control Panel and configure the network controller.

Network controller stopped working when an expansion board was added to the computer.

Cause	Solution
Network controller interrupt is shared with an expansion board.	Under the Computer Setup Advanced menu, change the resource settings for the board.
The network controller requires drivers.	Verify that the drivers were not accidentally deleted when the drivers for a new expansion board were installed.
The expansion board installed is a network card (NIC) and conflicts with the embedded NIC.	Under the Computer Setup Advanced menu, change the resource settings for the board.

Network controller stops working without apparent cause.

Cause	Solution
The files containing the network drivers are corrupted.	Reinstall the network drivers, using the Recovery Disc Set created from the hard drive's Recovery Partition.
The cable is not securely connected.	Ensure that the cable is securely attached to the network connector and that the other end of the cable is securely attached to the correct device.
The network controller is defective.	Contact an authorized service provider.

New network card will not boot.

Cause	Solution
New network card may be defective or may not meet industry-standard specifications.	Install a working, industry-standard NIC, or change the boot sequence to boot from another source.

Cannot connect to network server when attempting Remote System Installation.

Cause	Solution
The network controller is not configured properly.	Verify Network Connectivity, that a DHCP Server is present, and that the Remote System Installation Server contains the NIC drivers for your NIC.

System setup utility reports unprogrammed EEPROM.

Cause	Solution
Unprogrammed EEPROM.	Contact an authorized service provider.

Solving Memory Problems

If you encounter memory problems, some common causes and solutions are listed in the following table.

 **CAUTION:** Power may still be supplied to the DIMMs when the computer is turned off (depending on the Management Engine (ME) settings). To avoid damage to the DIMMs or the system board, you must unplug the computer power cord before attempting to reseat, install, or remove a DIMM module.

For those systems that support ECC memory, HP does not support mixing ECC and non-ECC memory. Otherwise, the computer will not boot the operating system.

 **NOTE:** The memory count will be affected by configurations with the Management Engine (ME) enabled. The ME uses 8MB of system memory in single channel mode or 16MB of memory in dual-channel mode to download, decompress, and execute the ME firmware for Out-of-Band (OOB), third-party data storage, and other management functions.

Table D-13 Solving Memory Problems**System will not boot or does not function properly after installing additional memory modules.**

Cause	Solution
A memory module is not installed in the DIMM1 or XMM1 socket.	Ensure that a memory module is installed in the DIMM1 or XMM1 socket on the system board. This socket must be populated with a memory module.
Memory module is not the correct type or speed grade for the system or the new memory module is not seated properly.	Replace module with the correct industry-standard device for the computer. On some models, ECC and non-ECC memory modules cannot be mixed.

Out of memory error.

Cause	Solution
Memory configuration may not be set up correctly.	Use the Device Manager to check memory configuration.
You have run out of memory to run the application.	Check the application documentation to determine the memory requirements.

Memory count during POST is wrong.

Cause	Solution
The memory modules may not be installed correctly.	Check that the memory modules have been installed correctly and that proper modules are used.
Integrated graphics may use system memory.	No action required.

Insufficient memory error during operation.

Cause	Solution
Too many Terminate and Stay Resident programs (TSRs) are installed.	Delete any TSRs that you do not need.
You have run out of memory for the application.	Check the memory requirements for the application or add more memory to the computer.

Power LED flashes Red five times, once every second, followed by a two second pause, and the computer beeps five times. (Beeps stop after fifth iteration but LEDs continue flashing.)

Cause	Solution
Memory is installed incorrectly or is bad.	<ol style="list-style-type: none"> 1. Reseat DIMMs. Power on the system. 2. Replace DIMMs one at a time to isolate the faulty module. 3. Replace third-party memory with HP memory. 4. Replace the system board.

Solving Processor Problems

If you encounter processor problems, common causes and solutions are listed in the following table.

Table D-14 Solving Processor Problems

Cause	Solution
Poor performance is experienced.	
Processor is hot.	<ol style="list-style-type: none">1. Make sure the airflow to the computer is not blocked.2. Make sure the fans are connected and working properly (some fans only operate when needed).3. Make sure the processor heat sink is installed properly.
Power LED flashes Red three times, once every second, followed by a two second pause.	
Processor is not seated properly or not installed.	<ol style="list-style-type: none">1. Check to see that the processor is present.2. Reseat the processor.
Power LED flashes Red eleven times, once every second, followed by a two second pause.	
The current processor does not support a feature previously enabled on this system.	<ol style="list-style-type: none">1. Install a TXT capable processor.2. Disable TXT in the Computer Setup (F10) utility.3. Reinstall the original processor.

Solving CD-ROM and DVD Problems

If you encounter CD-ROM or DVD problems, see the common causes and solutions listed in the following table or to the documentation that came with the optional device.

Table D-15 Solving CD-ROM and DVD Problems

Cause	Solution
System will not boot from CD-ROM or DVD drive.	
The device is attached to a SATA port that has been hidden in the Computer Setup utility.	Run the Computer Setup utility and ensure Device Available is selected for the device's SATA port in Security > Device Security .
Removable Media Boot is disabled in the Computer Setup utility.	Run the Computer Setup utility and enable booting to removable media in Storage > Storage Options . Ensure CD-ROM is enabled in Storage > Boot Order .
Network Server Mode is enabled in Computer Setup.	Run the Computer Setup utility and disable Network Server Mode in Security > Password Options .

Table D-15 Solving CD-ROM and DVD Problems (continued)

System will not boot from CD-ROM or DVD drive.

Cause	Solution
Non-bootable CD in drive.	Try a bootable CD in the drive.
Boot order not correct.	Run the Computer Setup utility and change boot sequence in Storage > Boot Order .

Drive not found (identified).

Cause	Solution
Cable could be loose.	Check cable connections.
The system may not have automatically recognized a newly installed device.	See reconfiguration directions in the Solving Hardware Installation Problems on page 163 section. If the system still does not recognize the new device, check to see if the device is listed within Computer Setup. If it is listed, the probable cause is a driver problem. If it is not listed, the probable cause is a hardware problem. If this is a newly installed drive, run the Computer Setup utility and try adding a POST delay under Advanced > Power-On Options .
The device is attached to a SATA port that has been hidden in Computer Setup.	Run the Computer Setup utility and ensure Device Available is selected for the device's SATA port in Security > Device Security .
Drive responds slowly immediately after power-up.	Run Computer Setup and increase the POST Delay in Advanced > Power-On Options .

CD-ROM or DVD devices are not detected or driver is not loaded.

Cause	Solution
Drive is not connected properly or not properly configured.	See the documentation that came with the optional device.

Movie will not play in the DVD drive.

Cause	Solution
Movie may be regionalized for a different country.	See the documentation that came with the DVD drive.
Decoder software is not installed.	Install decoder software.
Damaged media.	Replace media.
Movie rating locked out by parental lock.	Use DVD software to remove parental lock.
Media installed upside down.	Reinstall media.

Cannot eject compact disc (tray-load unit).

Cause	Solution
Disc not properly seated in the drive.	Turn off the computer and insert a thin metal rod into the emergency eject hole and push firmly. Slowly pull the tray out from the drive until the tray is fully extended, then remove the disc.

CD-ROM, CD-RW, DVD-ROM, or DVD-R/RW drive cannot read a disc or takes too long to start.

Cause	Solution
Media has been inserted upside down.	Re-insert the media with the label facing up.
The DVD-ROM drive takes longer to start because it has to determine the type of media played, such as audio or video.	Wait at least 30 seconds to let the DVD-ROM drive determine the type of media being played. If the disc still does not start, read the other solutions listed for this topic.
CD or DVD disc is dirty.	Clean CD or DVD with a CD cleaning kit, available from most computer stores.
Windows does not detect the CD-ROM or DVD-ROM drive.	<ol style="list-style-type: none">1. Use Device Manager to remove or uninstall the device.2. Restart the computer and let Windows detect the CD or DVD driver.

Recording or copying CDs is difficult or impossible.

Cause	Solution
Wrong or poor quality media type.	<ol style="list-style-type: none">1. Try using a slower speed when recording.2. Verify that you are using the correct media for the drive.3. Try a different brand of media. Quality varies widely between manufacturers.

Solving USB Flash Drive Problems

If you encounter USB flash drive problems, common causes and solutions are listed in the following table.

Table D-16 Solving USB Flash Drive Problems

USB flash drive is not seen as a drive letter in Windows.

Cause	Solution
The drive letter after the last physical drive is not available.	Change the default drive letter for the flash drive in Windows.

USB flash drive not found (identified).

Cause	Solution
The device is attached to a USB port that has been hidden in Computer Setup.	Run the Computer Setup utility and ensure that "Device available" is selected for "Front USB Ports" and "Rear USB Ports" under Security > Device Security .
The device was not properly seated before power-up.	Ensure the device is fully inserted into the USB port before applying power to the system

System will not boot from USB flash drive.

Cause	Solution
Boot order is not correct.	Run the Computer Setup utility and change boot sequence in Storage > Boot Order .
Removable Media Boot is disabled in the Computer Setup utility.	Run the Computer Setup utility and enable booting to removable media in Storage > Storage Options . Ensure USB is enabled in Storage > Boot Order .

The computer boots to DOS after making a bootable flash drive.

Cause	Solution
Flash drive is bootable.	Install the flash drive only after the operating system boots.

Solving Front Panel Component Problems

If you encounter problems with devices connected to the front panel, refer to the common causes and solutions listed in the following table.

Table D-17 Solving Front Panel Component Problems

A USB device, headphone, or microphone is not recognized by the computer.

Cause	Solution
Device is not properly connected.	<ol style="list-style-type: none">1. Turn off the computer.2. Reconnect the device to the front of the computer and restart the computer.
The device does not have power.	If the USB device requires AC power, be sure one end is connected to the device and one end is connected to a live outlet.
The correct device driver is not installed.	<ol style="list-style-type: none">1. Install the correct driver for the device.2. You might need to reboot the computer.
The cable from the device to the computer does not work.	<ol style="list-style-type: none">1. If possible, replace the cable.2. Restart the computer.

Table D-17 Solving Front Panel Component Problems (continued)

A USB device, headphone, or microphone is not recognized by the computer.

Cause	Solution
The device is not working.	<ol style="list-style-type: none">1. Replace the device.2. Restart the computer.
USB ports on the computer are disabled in Computer Setup.	Run the Computer Setup utility and ensure that Device available is selected for appropriate USB ports under Security > USB Security .

Solving Internet Access Problems

If you encounter Internet access problems, consult your Internet Service Provider (ISP) or refer to the common causes and solutions listed in the following table.

Table D-18 Solving Internet Access Problems

Unable to connect to the Internet.

Cause	Solution
Internet Service Provider (ISP) account is not set up properly.	Verify Internet settings or contact your ISP for assistance.
Modem is not set up properly.	Reconnect the modem. Verify the connections are correct using the quick setup documentation.
Web browser is not set up properly.	Verify that the Web browser is installed and set up to work with your ISP.
Cable/DSL modem is not plugged in.	Plug in cable/DSL modem. You should see a "power" LED light on the front of the cable/DSL modem.
Cable/DSL service is not available or has been interrupted due to bad weather.	Try connecting to the Internet at a later time or contact your ISP. (If the cable/DSL service is connected, the "cable" LED light on the front of the cable/DSL modem will be on.)
The CAT5 UTP cable is disconnected.	Connect the CAT5 UTP cable between the cable modem and the computer's RJ-45 connector. (If the connection is good, the "PC" LED light on the front of the cable/DSL modem will be on.)
IP address is not configured properly.	Contact your ISP for the correct IP address.
Cookies are corrupted. (A "cookie" is a small piece of information that a Web server can store temporarily with the Web browser. This is useful for having the browser remember some specific information that the Web server can later retrieve.)	<ol style="list-style-type: none">1. Select Start > Control Panel.2. Click Network and Internet.3. Click Internet Options.4. In the Browsing history section on the General tab, click the Delete button.5. Select the Cookies check box and click the Delete button.

Cannot automatically launch Internet programs.

Cause	Solution
You must log on to your ISP before some programs will start.	Log on to your ISP and launch the desired program.

Internet takes too long to download Web sites.

Cause	Solution
Modem is not set up properly.	Verify that the modem is connected and communicating properly. <ol style="list-style-type: none">1. Select Start > Control Panel.2. Click on Hardware and Sound.3. Click on Device Manager.4. Double-click Modems.5. Double-click Agere Systems PCI-SV92PP Soft Modem.6. On the General tab, click Diagnostics.7. Click Query Modem. A "Success" response indicates the modem is connected and working properly.

Solving Software Problems

Most software problems occur as a result of the following:

- The application was not installed or configured correctly.
- There is insufficient memory available to run the application.
- There is a conflict between applications.
- Be sure that all the needed device drivers have been installed.
- If you have installed an operating system other than the factory-installed operating system, check to be sure it is supported on the system.

If you encounter software problems, see the applicable solutions listed in the following table.

Table D-19 Solving Software Problems

Computer will not continue and no HP logo screen has appeared.	
Cause	Solution
POST error has occurred.	Observe the beeps and LED lights on the front of the computer. See Appendix A, POST Error Messages on page 127 to determine possible causes. See the Restore Kit or the Worldwide Limited Warranty for terms and conditions.

Computer will not continue after HP logo screen has appeared.	
Cause	Solution
System files may be damaged.	Use recovery diskette to scan hard drive for errors.

“Illegal Operation has Occurred” error message is displayed.	
Cause	Solution
Software being used is not Microsoft-certified for your version of Windows.	Verify that the software is certified by Microsoft for your version of Windows (see program packaging for this information).
Configuration files are corrupt.	If possible, save all data, close all programs, and restart the computer.

Contacting Customer Support

For help and service, contact an authorized reseller or dealer. To locate a reseller or dealer near you, visit <http://www.hp.com>.



NOTE: If you take the computer to an authorized reseller, dealer, or service provider for service, remember to provide the setup and power-on passwords if they are set.

Refer to the number listed in the warranty or in the *Support Telephone Numbers* guide for technical assistance.

E Password Security and Resetting CMOS

This computer supports security password features, which can be established through the Computer Setup Utilities menu.

This computer supports two security password features that are established through the Computer Setup Utilities menu: setup password and power-on password. When you establish only a setup password, any user can access all the information on the computer except Computer Setup. When you establish only a power-on password, the power-on password is required to access Computer Setup and any other information on the computer. When you establish both passwords, only the setup password will give you access to Computer Setup.

When both passwords are set, the setup password can also be used in place of the power-on password as an override to log in to the computer. This is a useful feature for a network administrator.

If you forget the password for the computer, you can clear that password so you can gain access to the information on the computer by resetting the password jumper.

 **CAUTION:** Pushing the CMOS button will reset CMOS values to factory defaults. It is important to back up the computer CMOS settings before resetting them in case they are needed later. Back up is easily done through Computer Setup. See [Computer Setup \(F10\) Utility on page 7](#) for information on backing up the CMOS settings.

Resetting the Password Jumper

To disable the power-on or setup password features, or to clear the power-on or setup passwords, complete the following steps:

1. Shut down the operating system properly, then turn off the computer and any external devices, and disconnect the power cord from the power outlet.
2. With the power cord disconnected, press the power button again to drain the system of any residual power.

 **WARNING!** To reduce the risk of personal injury from electrical shock and/or hot surfaces, be sure to disconnect the power cord from the wall outlet, and allow the internal system components to cool before touching.

 **CAUTION:** When the computer is plugged in, the power supply always has voltage applied to the system board even when the unit is turned off. Failure to disconnect the power cord can result in damage to the system.

Static electricity can damage the electronic components of the computer or optional equipment. Before beginning these procedures, ensure that you are discharged of static electricity by briefly touching a grounded metal object. See the *Safety & Regulatory Information* guide for more information.

3. Remove the access panel.
4. Locate the header and jumper labeled CLR_PASS on models 3400/3405 or PASSWORD on model 3410.

 **NOTE:** The password jumper is blue so that it can be easily identified. For assistance locating the password jumper and other system board components, see the Illustrated Parts & Service Map (IPSM). The IPSM can be downloaded from <http://www.hp.com/support>.

5. Remove the jumper from pins 2 and 3.
6. Place the jumper on pins 1 or 2.
7. Put the jumper back on pins 2 or 3.
8. Replace the access panel.
9. Reconnect the external equipment.
10. Plug in the computer and turn on power. Allow the operating system to start. This clears the current passwords and disables the password features.
11. To establish new passwords, use Computer Setup.

Clearing and Resetting the CMOS

The computer's configuration memory (CMOS) stores information about the computer's configuration.

The CMOS button resets CMOS but does not clear the power-on and setup passwords.

Clearing CMOS will clear the Active Management Technology (AMT) settings in the Management Engine BIOS Extension (MEBx), including the password. The password will default to "admin" and will

need to be reset. The AMT settings will also need to be reset. To access the MEBx, press **Ctrl+P** during POST.

1. Shut down the operating system properly, then turn off the computer and any external devices, and disconnect the power cord from the power outlet.
2. With the power cord disconnected, press the power button again to drain the system of any residual power.

 **WARNING!** To reduce the risk of personal injury from electrical shock and/or hot surfaces, be sure to disconnect the power cord from the wall outlet, and allow the internal system components to cool before touching.

 **CAUTION:** When the computer is plugged in, the power supply always has voltage applied to the system board even when the unit is turned off. Failure to disconnect the power cord can result in damage to the system.

Static electricity can damage the electronic components of the computer or optional equipment. Before beginning these procedures, ensure that you are discharged of static electricity by briefly touching a grounded metal object. See the *Safety & Regulatory Information* guide for more information.

3. Remove the access panel.
4. Locate the header and jumper labeled CLR_CMOS on models 3400/3405 or CMOS on model 3410.

 **NOTE:** The password jumper is blue so that it can be easily identified. For assistance locating the password jumper and other system board components, see the Illustrated Parts & Service Map (IPSM). The IPSM can be downloaded from <http://www.hp.com/support>.

5. Remove the jumper from pins 2 and 3.
6. Place the jumper on pins 1 or 2.
7. Put the jumper back on pins 2 or 3.
8. Replace the access panel.
9. Reconnect the external equipment.
10. Plug in the computer and turn on power. Allow the operating system to start. This clears the current passwords and disables the password features.

 **NOTE:** You will receive POST error messages after clearing CMOS and rebooting advising you that configuration changes have occurred. Use Computer Setup to reset any special system setups along with the date and time.

For instructions on Computer Setup, see [Computer Setup \(F10\) Utility on page 7](#).

F Backup and Recovery

Windows 7 – Backup and Recovery

To protect your information, use Windows® Backup and Restore to back up individual files and folders, back up your entire hard drive (select models only), create system repair discs (select models only), or create system restore points. In case of system failure, you can use the backup files to restore the contents of your computer.

Windows Backup and Restore provides the following options:

- Creating a system repair disc (select models only)
- Backing up individual files and folders
- Creating a system image (select models only)
- Scheduling automatic backups (select models only)
- Creating system restore points
- Recovering individual files
- Restoring the computer to a previous state
- Recovering information using recovery tools

 **NOTE:** For detailed instructions, perform a search for these topics in Help and Support.

 **NOTE:** In case of system instability, HP recommends that you print the recovery procedures and save them for later use.

Backing Up Your Information

Recovery after a system failure is as complete as your most current backup. You should create system repair discs (select models only) and your initial backup immediately after software setup. As you add new software and data files, you should continue to back up your system on a regular basis to maintain a reasonably current backup. The system repair discs (select models only) are used to start up (boot) the computer and repair the operating system in case of system instability or failure. Your initial and subsequent backups allow you to restore your data and settings if a failure occurs.

You can back up your information to an optional external hard drive, a network drive, or discs.

Note the following when backing up:

- Store personal files in the Documents library, and back it up regularly.
- Back up templates that are stored in their associated programs.
- Save customized settings that appear in a window, toolbar, or menu bar by taking a screen shot of your settings. The screen shot can be a time-saver if you have to reset your preferences.

To create a screen shot:

1. Display the screen you want to save.
2. Copy the screen image:

To copy only the active window, press **alt+fn+prt sc**.

To copy the entire screen, press **fn+prt sc**.

3. Open a word-processing document, and then select **Edit > Paste**.

The screen image is added to the document.

4. Save the document.

- When backing up to discs, use any of the following types of discs (purchased separately): CD-R, CD-RW, DVD+R, DVD+R DL, DVD-R, DVD-R DL, or DVD±RW. The discs you use will depend on the type of optical drive installed in your computer.

 **NOTE:** DVDs and DVDs with double-layer (DL) support store more information than CDs, so using them for backup reduces the number of recovery discs required.

- When backing up to discs, number each disc before inserting it into the optical drive of the computer.

To create a backup using Backup and Restore, follow these steps:

 **NOTE:** Be sure that the computer is connected to AC power before you start the backup process.

 **NOTE:** The backup process may take over an hour, depending on file size and the speed of the computer.

1. Select **Start > All Programs > Maintenance > Backup and Restore**.
2. Follow the on-screen instructions to set up your backup, create a system image (select models only), or create a system repair disc (select models only).

 **NOTE:** Windows® includes the User Account Control feature to improve the security of your computer. You may be prompted for your permission or password for tasks such as installing software, running utilities, or changing Windows settings. Refer to Help and Support for more information.

Performing a Recovery

In case of system failure or instability, the computer provides the following tools to recover your files:

- Windows recovery tools: You can use Windows Backup and Restore to recover information you have previously backed up. You can also use Windows Startup Repair to fix problems that might prevent Windows from starting correctly.
- F11 recovery tools: You can use the F11 recovery tools to recover your original hard drive image. The image includes the Windows operating system and software programs installed at the factory.

 **NOTE:** If you are unable to boot (start up) your computer and you cannot use the system repair discs you previously created (select models only), you must purchase a Windows 7 operating system DVD to reboot the computer and repair the operating system. For additional information, refer to the “Using a Windows 7 operating system DVD (purchased separately)” section in this guide.

Using the Windows Recovery Tools

To recover information you previously backed up, follow these steps:

1. Select **Start > All Programs > Maintenance > Backup and Restore**.
2. Follow the on-screen instructions to recover your system settings, your computer (select models only), or your files.

 **NOTE:** Windows includes the User Account Control feature to improve the security of your computer. You may be prompted for your permission or password for tasks such as installing software, running utilities, or changing Windows settings. Refer to Help and Support for more information.

To recover your information using Startup Repair, follow these steps:

 **CAUTION:** All files you have created and any software installed on the computer are permanently removed. When reformatting is complete, the recovery process restores the operating system, as well as the drivers, software, and utilities from the backup used for recovery.

1. If possible, back up all personal files.
2. If possible, check for the presence of the Windows partition and the HP Recovery partition.

To check for the Windows partition, select **Start > Computer**.

To check for the HP Recovery partition, select **Start**, right-click **Computer**, click **Manage**, and then click **Disk Management**.

 **NOTE:** If the Windows partition and the HP Recovery partition are not listed, you must recover your operating system and programs using the System Recovery discs that you can obtain from HP Support.

3. If the Windows partition and the HP Recovery partition are listed, restart the computer, and then press F8 before the Windows operating system loads.
4. Select **Repair Your Computer**. The following options display: Startup Repair, System Restore, System Image Recovery, Windows Memory Diagnostics, Command Prompt, Recovery Manager.

5. Select one of the first three listed tools to repair your computer.
6. Follow the on-screen instructions.

 **NOTE:** For additional information on recovering information using the Windows tools, perform a search for these topics in Help and Support.

Using F11

 **CAUTION:** Using **F11** completely erases hard drive contents and reformats the hard drive. All files you have created and any software installed on the computer are permanently removed. The **F11** recovery tool reinstalls the operating system and HP programs and drivers that were installed at the factory. Software not installed at the factory must be reinstalled.

If Windows 7 is not responding, but the computer is working, follow these steps to perform a System Recovery.

1. If possible, back up all personal files.
2. If possible, check for the presence of the HP Recovery partition: select **Start**, right-click **Computer**, click **Manage**, and then click **Disk Management**.

 **NOTE:** If the Windows partition and the HP Recovery partition are not listed, you must recover your operating system and programs using the System Recovery discs that you can obtain from HP Support.

3. Press the Power button to turn on the computer.
4. As soon as you see the initial company logo screen appear, repeatedly press the **F11** key on your keyboard until the `Windows is Loading Files...` message appears on the screen.
5. Under **I need help immediately**, tap **System Recovery**.
6. If you are prompted to back up your files, and you have not done so, tap **Back up your files first (recommended)**, and then tap **Next**. Otherwise, tap **Recover without backing up your files**, and then tap **Next**.
7. System Recovery begins. After System Recovery is complete, tap **Finish** to restart the computer.

Using a Windows 7 Operating System DVD (purchased separately)

If you are unable to boot (start up) your computer and you cannot use the system repair discs you previously created (select models only), you must use System Recovery discs that you can obtain from HP Support to reboot the computer and repair the operating system. Make sure that your most recent backup (stored on discs or on an external drive) is easily accessible.

 **CAUTION:** All files you have created and any software installed on the computer are permanently removed. When reformatting is complete, the recovery process helps you restore the operating system, as well as drivers, software, and utilities.

To initiate recovery using a Windows 7 operating system DVD, follow these steps:



NOTE: This process takes several minutes.

1. If possible, back up all personal files.
2. Restart the computer, and then insert the Windows 7 operating system DVD into the optical drive before the Windows operating system loads.
3. When prompted, press any keyboard key.
4. Follow the on-screen instructions.
5. Click **Next**.
6. Select **Repair your computer**.
7. Follow the on-screen instructions.

G Specifications

MT Specifications

Table G-1 Specifications

Chassis		
Height	14.49 in	36.8 cm
Width	6.50 in	16.5 cm
Depth	15.31 in	38.9 cm
Approximate Weight	15.28 - 15.83 lb	6.932 - 7.18 kg
Temperature Range		
Operating	32° to 104°F	0° to 40°C
Nonoperating	-22° to 149°F	-30° to 65°C
Relative Humidity (noncondensing)		
Operating	15-95%	15-95%
Non-operating	15-95%	15-95%
Maximum Altitude (unpressurized)		
Operating	7,500 ft	2286 m
Nonoperating	15,000 ft	4572 m
Power Supply		
Energy Consumption	230 VAC	
Heat Dissipation*	55.6 W	
Normal Operation	1.45 W	
Sleep (Energy Star Low Power Mode)	0.90 W	
Off		
Model	300W	
Rated Voltage Range	100-240 VAC	

¹ *Heat dissipation is calculated based on the measured watts, assuming the service level is attained for one hour.

SFF Specifications

Table G-2 Specifications

Chassis		
Height	12.77 in	32.5 cm
Width	4.98 in	10.4 cm
Depth	15.61 in	39.7 cm
Approximate Weight	13.9 lb	6.3 kg
Temperature Range		
Operating	32° to 104°F	0° to 40°C
Nonoperating	-22° to 149°F	-30° to 65°C
Relative Humidity (noncondensing)		
Operating	15-95%	15-95%
	15-95%	15-95%
Maximum Altitude (unpressurized)		
Operating	7,500 ft	2286 m
Nonoperating	15,000 ft	4572 m
Power Supply		
Energy Consumption		142.7 KWh
Normal Operation		39.61 W
Sleep (Energy Star Low Power Mode)		1.55 W
Off		0.67 W
Model	220W	
Rated Voltage Range	100-240 VAC	

Index

Symbols/Numerics

24-pin power pin assignments
122

4-pin power pin assignments 119

A

access panel

removal and replacement 43

SFF removal and
replacement 80

SFF spare part number 80

spare part number 19, 26, 43

access panel, SFF

spare part number 26, 31

audible codes 136

audio problems 158

B

backing up files 180

Backup and Restore 180, 181

battery

disposal 41

removal and replacement 77,
116

beep codes 136

booting options

Full Boot 127

Quick Boot 127

C

cable connections 56, 93

cable management 55, 92

cable pinouts

SATA data 33

cautions

AC power 35

cables 41

cooling fan 40

electrostatic discharge 35

keyboard cleaning 39

keyboard keys 39

CD-ROM or DVD problems 169

cleaning

computer 38

mouse 40

safety precautions 38

CMOS

backing up 177

clearing and resetting 178

computer cleaning 38

connecting drive cables 58

connections

system board 56, 93

connector pin assignments 118

country power cord set

requirements 126

creating a backup 180

Customer Support 140, 176

D

disassembly preparation 42

SFF 79

diskette problems 147

drive connectors 59

drives

connecting cables 58

installing 58

removal and replacement 57

SFF cable connections 95

SFF installation 95

SFF locations 94

DVI pin assignments 121

E

electrostatic discharge (ESD) 35

preventing damage 36

error

codes 127, 136

messages 128

ethernet

BNC pin assignments 118

expansion card

SFF installation 88

SFF removal 88

expansion card sockets 50, 51,
88

expansion slot cover

removing 52

replacing 54

F

F11 recovery 183

fan

power supply 40

removal and replacement 68

SFF spare part number 106

spare part number 22, 25, 68

fan sink

removal and replacement 70

SFF spare part number 108

spare part number 22, 25, 70

fan sink, SFF

spare part number 29, 31

fan, SFF

spare part number 29, 31

features 1

flash drive problems 171

flashing LEDs 136

front bezel

removal and replacement 44

SFF removal and
replacement 82

SFF spare part number 82

spare part number 19, 44

- front bezel,
 - spare part number 26
- front bezel, SFF
 - spare part number 26, 31
- front fan
 - SFF removal and replacement 106
- front I/O and card reader assembly
 - SFF spare part number 103
 - spare part number 29, 31
- Front I/O and USB assembly
 - spare part number 22, 26, 63
- front I/O device
 - removal and replacement 63
- front I/O, power switch assembly
 - SFF removal and replacement 103
- front panel problems 172

G

- general problems 143
- graphics card, spare part number 30, 31, 88
- grounding methods 36

H

- hard drive
 - proper handling 41
 - removing 61
 - SATA characteristics 33
 - SFF installation 97
 - SFF removal 97
 - spare part number 31
 - spare part numbers 23, 24, 30
- hard drive problems 149
- hard drive recovery 183
- hardware installation problems 163
- headphone pin assignments 119
- heat sink
 - removal and replacement 70
 - SFF removal and replacement 108
- helpful hints 141
- hood sensor
 - SFF removal and replacement 101

I

- installing
 - drive cables 58
 - SFF drive cables 95
 - SFF expansion card 88
 - SFF hard drive 97
 - SFF memory 83
- Internet access problems 173

K

- keyboard
 - cleaning 39
- keyboard problems 161

L

- LEDs
 - blinking power 136
 - blinking PS/2 keyboard 136
- line-in audio pin assignments 119
- line-out audio pin assignments 119

M

- Media Card Reader problems 152
- memory
 - populating sockets 46, 84
 - removal and replacement 45
 - SFF installation 83
 - specifications 45, 83
- memory module
 - spare part number 45, 83
- memory modules
 - spare part number 19, 24, 27, 30, 31
- memory problems 167
- microphone pin assignments 118
- microtower components 3
- monitor
 - pin assignments 120
- monitor problems 153
- mouse
 - cleaning 40
 - spare part number 22, 29
- mouse problems 161

N

- network problems 165
- numeric error codes 128

O

- operating guidelines 38
- optical drive
 - removing 61
 - SFF removal 95
 - spare part numbers 23, 24, 30
- optical drive problems 169
- overheating, prevention 38

P

- password
 - clearing 177
 - power-on 177
 - setup 177
- PCI card 50, 51, 88
- PCI Express card 50, 51, 53, 88
- PCI Express pin assignments 123
- POST error messages 127
- power cord set requirements
 - country specific 126
- power problems 146
- power supply
 - fan 40
 - operating voltage range 185, 186
 - removal and replacement 75
 - SFF removal and replacement 112
 - spare part number 19, 25
- power supply, SFF
 - spare part number 26, 31
- power switch/LED
 - removal and replacement 66
- power switch/LED assembly
 - SFF spare part number 101
 - spare part number 21, 26, 66
- power switch/LED assembly, SFF
 - spare part number 28, 31
- power-on password 177
- preparation for disassembly 42
- printer problems 160
- problems
 - audio 158
 - CD-ROM or DVD 169
 - diskette 147
 - flash drive 171
 - front panel 172
 - general 143

- hard drive 149
- hardware installation 163
- Internet access 173
- keyboard 161
- Media Card Reader 152
- memory 167
- monitor 153
- mouse 161
- network 165
- power 146
- printer 160
- processor 169
- software 175
- processor
 - removal and replacement 72
 - SFF removal and replacement 110
 - spare part number 19, 24, 27, 31
- processor problems 169
- R**
- recovering information 182
- recovery partition 183
- removal and replacement
 - access panel 43
 - battery 77, 116
 - drives 57
 - fan 68
 - fan sink 70
 - front bezel 44
 - front I/O device 63
 - heat sink 70
 - memory 45
 - power supply 75
 - power switch 66
 - processor 72
 - SFF front bezel 80, 82
 - SFF front fan 106
 - SFF front I/O, power switch assembly 103
 - SFF heat sink 108
 - SFF hood sensor 101
 - SFF power supply 112
 - SFF processor 110
 - SFF system board 114
 - system board 76
- removing
 - expansion slot cover 52
 - hard drive 61
 - optical drive 61
 - PCI Express card 53
 - PCI Express x1 card 53
 - SFF expansion card 88
 - SFF hard drive 97
 - SFF optical drive 95
- resetting
 - CMOS 177
 - password jumper 177
- restoring the hard drive 183
- S**
- safety and comfort 140
- safety precautions
 - cleaning 38
- SATA
 - connectors on system board 33
 - data cable pinouts 33
 - hard drive characteristics 33
- SATA cable
 - spare part number 21
- SATA cable, SFF
 - spare part number 28
- screws, correct size 40
- SDRAM (synchronous dynamic random access memory) 45
- serial interface pin assignments 120
- service considerations 40
- serviceability features 42
- setup password 177
- SFF
 - access panel, spare part number 26, 31
 - disassembly preparation 79
 - fan sink, spare part number 29, 31
 - fan, spare part number 29, 31
 - front bezel removal and replacement 80, 82
 - front bezel, spare part number 26, 31
 - front fan removal and replacement 106
 - front I/O, power switch assembly removal and replacement 103
 - heat sink removal and replacement 108
- hood sensor removal and replacement 101
- power supply removal and replacement 112
- power supply, spare part number 26, 31
- power switch/LED assembly, spare part number 28, 31
- preparation for disassembly 79
- processor removal and replacement 110
- SATA cable, spare part number 28
- system board removal and replacement 114
- system board, spare part number 27
- small form factor components 4
- software
 - problems 175
 - servicing computer 40
- spare part number
 - tamper-resistant wrench 40
 - Torx T-15 screwdriver 40
- specifications
 - computer 185
 - memory 45, 83
- static electricity 35
- system board
 - removal and replacement 76
 - SATA connectors 33
 - SFF removal and replacement 114
 - spare part number 19, 76
- system board drive connections 59
- system board,
 - spare part number 25
- system board, SFF
 - spare part number 27
- T**
- tamper-proof screws
 - tool 40
- temperature control 38
- tools, servicing 40
- Torx T15 screwdriver 40

U

USB pin assignments 118

V

ventilation, proper 38

W

Wake-on-LAN feature 165

Windows 7 operating system

DVD 183