

Aspire Notebook Series

Quick Guide

Product registration

When using your product for the first time, it is recommended that you immediately register it. This will give you access to some useful benefits, such as:

- Faster service from our trained representatives.
- Membership in the Acer community: receive promotions and participate in customer surveys.
- The latest news from Acer.

Hurry and register, as other advantages await you!

How to register

To register your Acer product, please visit **www.acer.com**. Select your country, click **PRODUCT REGISTRATION** and follow the simple instructions.

You will also be asked to register your product during the setup process, or you can double-click the Registration icon on the desktop.

After we receive your product registration, you will be sent a confirmation email with important data that you should keep in a safe place.

Obtaining Acer accessories

We are happy to inform you that Acer's warranty extension program and Notebook accessories are available online. Come and visit our online shop and find what you need at **store.acer.com**.

The Acer store is being progressively rolled out, and, unfortunately may not be available in some regions. Please check back regularly to see when it will be available in your country.

© 2011. All Rights Reserved.

Aspire Notebook Series Quick Guide
Original Issue: 06/2011

Model number: _____

Serial number: _____

Date of purchase: _____

Place of purchase: _____

Acer recommends...

Productivity Software

Work Great with Microsoft® Office 2010 - Express your ideas, solve problems and simplify everyday projects with Office 2010.

Photo editing - Easily edit and print your photos with Windows Live Photo Gallery. Then share them on Facebook, YouTube or Windows Live.

Search & Decide with Bing - Find and organize the answers you need using Bing™, so you can make faster, more informed decisions.

First things first

We would like to thank you for making an Acer notebook your choice for meeting your mobile computing needs.

Your guides

To help you use your Acer notebook, we have designed a set of guides:

First off, the **setup poster** helps you get started with setting up your computer.

The **Aspire Generic User Guide** contains useful information applying to all models in the Aspire product series. It covers basic topics such as using the keyboard and audio, etc. Please understand that due to its nature, the **Generic User Guide** will occasionally refer to functions or features which are only contained in certain models of the series, but not necessarily in the model you purchased. Such instances are marked in the text with language such as "only for certain models".

The **Quick Guide** introduces you to the basic features and functions of your new computer. For more on how your computer can help you to be more productive, please refer to the **Aspire Generic User Guide**. This guide contains detailed information on such subjects as system utilities, data recovery, expansion options and troubleshooting. In addition it contains warranty information and the general regulations and safety notices for your notebook. It is available in Portable Document Format (PDF) and comes preloaded on your notebook. Follow these steps to access it:

- 1 Click on  **Start > All Programs > AcerSystem**.
- 2 Click on **Aspire Generic User Guide**.



Note: Viewing the file requires Adobe Reader. If Adobe Reader is not installed on your computer, clicking on **Aspire Generic User Guide** will run the Adobe Reader setup program first. Follow the instructions on the screen to complete the installation. For instructions on how to use Adobe Reader, access the **Help and Support** menu.



Your Acer notebook tour

After setting up your computer as illustrated in the setup poster, let us show you around your new Acer notebook.

Top view

















#	Icon	Item	Description
1		Integrated webcam	Web camera for video communication.

#	Icon	Item	Description
2		Display screen	Also called Liquid-Crystal Display (LCD), displays computer output (configuration may vary by model).
3		Power button	Turns the computer on and off.
4		Keyboard	For entering data into your computer.
5		Touchpad	Touch-sensitive pointing device which functions like a computer mouse.
6		Microphone	Internal microphone for sound recording.
		Power indicator	Indicates the computer's power status.
7		Battery indicator	Indicates the computer's battery status. 1. Charging: The light shows amber when the battery is charging. 2. Fully charged: The light shows blue when in AC mode.
8		Click buttons (left and right)	The left and right buttons function like the left and right mouse buttons.
9		Speaker	Delivers audio output.

Hotkeys



The computer employs hotkeys or key combinations to access most of the computer's controls like screen brightness and volume output.

To activate hotkeys, press and hold the <Fn> key before pressing the other key in the hotkey combination.

Hotkey	Icon	Function	Description
<Fn> + <F3>		Communication	Enables/disables the computer's communication devices.
<Fn> + <F4>		Sleep	Puts the computer in Sleep mode.
<Fn> + <F5>		Display toggle	Switches display output between the display screen, external monitor (if connected) and both.
<Fn> + <F6>		Screen blank	Turns the display screen backlight off to save power. Press any key to return.
<Fn> + <F7>		Touchpad toggle	Turns the internal touchpad on and off.
<Fn> + <F8>		Speaker toggle	Turns the speakers on and off.
<Fn> + <D>		Brightness up	Increases the screen brightness.
<Fn> + <L>		Brightness down	Decreases the screen brightness.
<Fn> + <A>		Volume up	Increases the sound volume.
<Fn> + <V>		Volume down	Decreases the sound volume.
<Fn> + <Home>		Play/Pause	Play or pause a selected media file.
<Fn> + <Pg Up>		Stop	Stop playing the selected media file.
<Fn> + <Pg Dn>		Previous	Return to the previous media file.
<Fn> + <End>		Next	Jump to the next media file.

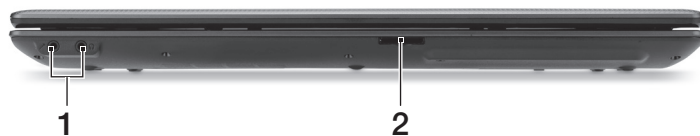

Closed front view



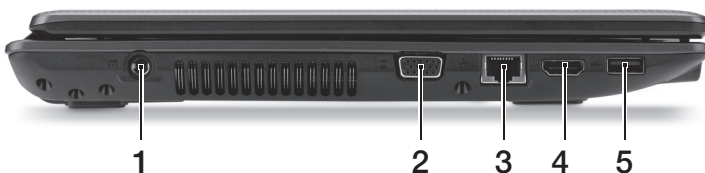

#	Icon	Item	Description
1		Microphone jack	Accepts inputs from external microphones.
		Headphones/ speaker jack	Connects to audio devices (e.g., speakers, headphones).
2		2-in-1 card reader	Accepts Secure Digital (SD), MultiMediaCard (MMC). Note: Push to remove/install the card. Only one card can operate at any time.

Left view





#	Icon	Item	Description
1		DC-in jack	Connects to an AC adapter.
2		External display (VGA) port	Connects to a display device (e.g., external monitor, LCD projector).
3		Ethernet (RJ-45) port	Connects to an Ethernet 10/100-based network.

#	Icon	Item	Description
4		HDMI port	Supports high-definition digital video connections.
5		USB 2.0 port	Connects to USB 2.0 devices (e.g., USB mouse, USB camera).

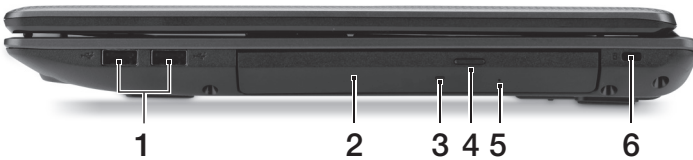
Right view



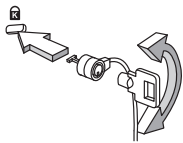

#	Icon	Item	Description
1		USB 2.0 ports	Connect to USB 2.0 devices (e.g., USB mouse, USB camera).
2		Optical drive	Internal optical drive; accepts CDs or DVDs.
3		Optical disk access indicator	Lights up when the optical drive is active.
4		Optical drive eject button	Ejects the optical disk from the drive.
5		Emergency eject hole	Ejects the optical drive tray when the computer is turned off. Note: Insert a paper clip to the emergency eject hole to eject the optical drive tray when the computer is off.

#	Icon	Item	Description
6		Kensington lock slot 	Connects to a Kensington-compatible computer security lock. Note: Wrap the computer security lock cable around an immovable object such as a table or handle of a locked drawer. Insert the lock into the notch and turn the key to secure the lock. Some keyless models are also available.

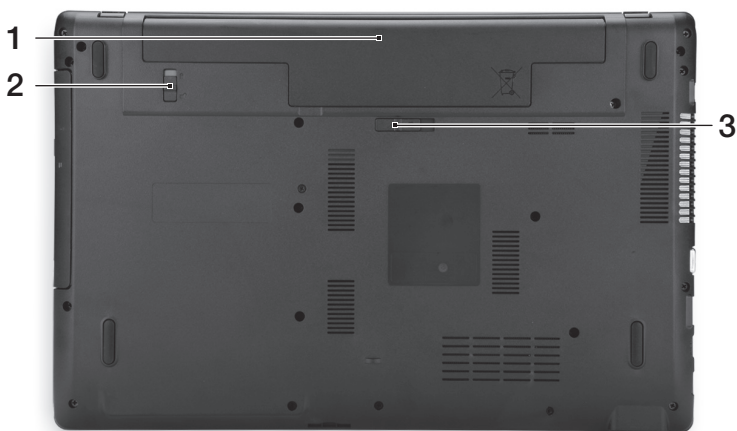
Base view



#	Icon	Item	Description
1		Battery bay	Houses the computer's battery pack.
2		Battery lock	Locks the battery in position.
3		Battery release lock	Releases the battery for removal.

Environment

- Temperature:
 - Operating: 5 °C to 35 °C
 - Non-operating: -20 °C to 65 °C
 - Humidity (non-condensing):
 - Operating: 20% to 80%
 - Non-operating: 20% to 80%
-