

Copyright © 2010
All Rights Reserved - Printed in China

T1000/T1005 Series Netbook User's Manual

Date Issued: 2010/ 08

This manual takes you, step by step, through setting up and using your new netbook PC. Information in this manual has been carefully checked for accuracy and is subject to change without prior notice.

No part or parts of this manual may be reproduced, stored in a retrieval system, or transmitted, in any form or by any means, electronic, mechanical, by photocopy, recording, or otherwise, without prior written consent.

Trademarks

Product names used herein are for identification purposes only and may be the trademarks of their respective companies.

Microsoft®, MS-DOS, Windows®, and Windows® Sound System are trademarks of the Microsoft Corporation.

Intel® & Atom™ are registered trademarks of Intel Corporation.

Sound Blaster & Sound Blaster Pro are trademarks of Creative Technology.

All other brands or product names mentioned in this manual are trademarks or registered trademarks of their respective companies.

Safety Instructions

Use the following safety guidelines to help protect you and prevent damage to your netbook.

When Using Your T1000/T1005 Netbook



CAUTION: Notebooks generate heat while in use and this can build up in the base of the notebook. When using the notebook please be careful and do not rest the notebook on exposed skin as contact with the base can cause serious discomfort or a serious skin rash or burn.

- Do not attempt to service the netbook yourself. Always follow installation instructions carefully.
- Do not carry a battery in your pocket, purse, or other container where metal objects (such as car keys) could come into contact with and short-circuit battery terminals. The resulting excessive flow of current would cause extreme temperatures and result in excessive burns or a possible fire or explosion.
- Be sure that nothing rests on your AC adapter's power cable and that the cable is not placed where it can be tripped over or can be stepped on and damaged.
- While you are using the computer or charging the battery, place the AC adapter in a ventilated area, like on a desktop or on the floor while it is charging as this may prevent ventilation and cause the adapter to overheat. Do not use the AC adapter while it is inside a carrying case.
- Do not insert objects into the air vent of your netbook computer. Doing so can cause short-circuiting and may result in fire or electrical shock. This will also hamper ventilation.
- Use only the AC adapter and batteries that are supplied by your netbook manufacturer. Using other types of battery or AC adapter may heighten the risk of fire or explosion.
- Incorrectly inserted batteries may result in an explosion.
- Replace only with the same or compatible battery recommended by the manufacturer.
- Please discard used batteries according to the manufacturer's instructions.
- Before you connect your netbook to a power source, ensure that the voltage rating of the AC adapter matches that of the available power source.
 - 115 V/60 Hz in most of North and South America and some Far Eastern countries such as South Korea.
 - 100 V/50 Hz in eastern Japan and 100 V/60Hz in western Japan.
 - 230 V/50 Hz in most of Europe, the Middle & Far East and Africa.
 - If you use an extension cord with your AC adapter, ensure that the total ampere rating of all devices plugged into the extension cord does not exceed its total capacity.
- When removing battery from your netbook, first turn off the system, disconnect the AC adapter from the electrical outlet, and then remove the battery.
- To avoid risk of an electrical shock, do not connect or disconnect any cables, or perform maintenance or reconfiguration of this product during a thunderstorm.
- Do not throw batteries into fire, doing so may cause an explosion. Check with local authorities first for battery disposal instructions.
- When setting up your netbook for work, place it on a level surface.
- When traveling, do not check your netbook as baggage. You can put your netbook through an X-ray security machine, but never put your netbook through a metal detector. If you have your netbook checked by hand, be sure to have a charged battery ready in case you are asked to turn on your netbook.

- When traveling with the hard drive removed from your netbook, wrap the drive in an insulated material, such as cloth or paper. If you have the drive checked by hand, you may be asked to install the drive into your netbook. You can have the hard drive checked through an X-ray machine, but never put the drive through a metal detector.
- When traveling, do not place your netbook in the overhead storage compartment where it could shift around. Do not drop your netbook or subject it to other mechanical shocks.
- Protect your netbook, battery, and hard drive from all types of environmental hazards that it may be exploded to during use or while being transported.
- When you move your netbook in environments where there is a substantial difference of temperature or humidity level, condensation may form on or within your netbook. To avoid damaging your netbook, please allow sufficient time for the moisture to evaporate before continue using.

NOTICE: When taking your netbook from a colder to a warmer environment or vice versa, allow your netbook enough time to adapt to the new environment before switching the notebook on.

- When unplugging the power cord, please make sure that you pull on its connector or on its strain relief loop, and not on the power cord itself. As you pull out the connector, please ensure that it is pulled out evenly in order not to bend its connecting pins. Also, before you connect the power cord, make sure that both connectors are correctly oriented and aligned.
- Before you clean your netbook, turn it off first, unplug it from its power source, and remove the battery.

- Handle interior components with care. When removing a component, please hold it by the edge and not on the connecting pins (such as the memory module).



When using your telephone equipments, safety instructions should always be followed in order to prevent fire, electrical shock or injuries, these instructions include:

- Do not use this product near water, for example, near a bathtub, washing basins, kitchen/laundry sinks, wet basements or swimming pools.
- Avoid using cordless phones during an electrical storm as lightning may cause electrical shocks and damage.

WARNING: Voiding the Warranty

- * If the battery is not properly handled, there may be a risk of explosion; make sure you are using the same or compatible battery.
- * Please discard used batteries according to the instructions given by the manufacturer.
- * Please be aware that use of cracked, severely scratched or poor quality discs may damage the optical drive and corrupt data in the disc. Such discs may break while inside the optical drive and may damage the drive and may void the notebook warranty.

Regulatory Notices

Federal Communications Commission Notice

This equipment has been tested and found to comply with the limits for a Class B digital service, pursuant to Part 15 of the FCC rules. These limits are designed to provide reasonable protection against harmful interference in a residential installation.

Any changes or modifications made to this equipment may void the user's authority to operate this equipment. This equipment generates, uses, and can radiate radio frequency energy. If not installed and used in accordance with the instructions, may cause harmful interference to radio communications. However, there is no guarantee that interference will not occur in a particular installation. If this equipment does cause harmful interference to radio or television reception, which can be determined by turning the equipment off and on, the user is encouraged to try to correct the interference by one or more of the following measures:

- Reorient or relocate the receiving antenna.
- Increase the separation between the equipment and receiver.
- Connect the equipment into an outlet on a circuit different from that to which the receiver is connected.
- Consult the dealer or an experienced radio/TV technician for help.
- All external cables connecting to this basic unit must be shielded.

For cables connecting to PCMCIA cards, see the option manual or installation instructions.

RF exposure

This equipment must be installed and operated in accordance with provided instructions and must not be co-located or operating in conjunction with any other antenna or transmitter. End-users and installers must be provide with antenna installation instructions and transmitter operating conditions for satisfying RF exposure compliance.

SAR Value:0.323 W/Kg

CE Notice (European Union)

This symbol  indicates this T1000/T1005 series netbook computer complies with the EMC Directive and the European Union's Low Voltage Directive. This symbol also indicates that T1000/T1005 meets the following technical standards:

- EN 55022 — “Limitations and Methods of Measurement for the Radio Interferences of Information Technology Equipment.”
- EN 55024 — “Information technology equipment - Immunity characteristics - Limits and methods of measurement.”
- EN 61000-3-2 — “Electromagnetic compatibility (EMC) - Chapter 3: Limits - Section 2: Limits on the harmonic current emissions (Equipment input current up to and including 16 A per phase).”
- EN 61000-3-3 — “Electromagnetic compatibility (EMC) - Chapter 3: Limits - Section 3: Limits on the voltage fluctuations and flicker in low-voltage power supply systems for equipment with rate current up to and including 16 A.”
- EN 60950 — “Safety of Information Technology Equipment.”



NOTE: EN 55022 emissions requirements provide for two classifications

- Class A governs commercial use
- Class B governs residential use

For CB:

- Only use batteries designed for this computer. The wrong battery type may explode, leak or damage the computer
- Do not remove any batteries from the computer while it is powered on.

- Do not continue to use a battery that has been dropped, or that appears damaged (e.g. bent or twisted) in any way. Even if the computer continues to work with a damaged battery in place, it may cause circuit damage, which may possibly result in fire.
- Recharge the batteries using the notebook's system. Incorrect recharging may make the battery explode.
- Do not try to repair a battery pack. Refer any battery pack repair or replacement to your service representative or qualified service personnel.
- Keep children away from, and promptly dispose of a damaged battery. Always dispose of batteries carefully. Batteries may explode or leak if exposed to fire, or improperly handled or discarded.
- Keep the battery away from metal appliances.
- Affix tape to the battery contacts before disposing of the battery.
- Do not touch the battery contacts with your hands or metal objects.

Battery Disposal & Caution

The product that you have purchased contains a rechargeable battery. The battery is recyclable. At the end of its useful life, under various state and local laws. It may be illegal to dispose of this battery into the municipal waste stream. Check with your local solid waste officials for details in your area for recycling options or proper disposal. Danger of explosion if battery is incorrectly replaced. Replace only with the same or equivalent type recommended by the manufacturer. Discard used battery according to the manufacturer's instructions.

BSMI Notice (Taiwan Only)

Most netbook computers are classified by the Bureau of Standards, Meteorology and Inspection (BSMI) as Class B information technology equipment (ITE).



R32323

The symbol above must be attached to the product indicating compliance with the BSMI standard.





Preface

Congratulations on your purchase of a netbook computer! Your new netbook features the most innovative features in portable computing technology. It combines state-of-the-art ergonomics with sophisticated architecture, providing you with a personal computer that is compact, powerful, and easy to use. Designed for a wide range of general, business, and personal productivity applications, this netbook is an ideal choice for use in the office, at home, and on the road.

This Manual contains all the information you need to set up and use your netbook computer. It describes all of its features in a thorough yet easy-to-understand manner.

Content

Safety Instructions	I
Regulatory Notices	III
Preface	VII

Chapter 1 Introducing Your T1000/T1005 Netbook

1.1 Panoramic View	2
1.2 Left View	3
1.3 Right View	3
1.4 Cover View	4
1.5 Bottom View	4
1.6 Status Indicators	5
1.7 Turning Your T1000/T1005 Netbook On and Off	6
1.8 Keyboard Functions	6
1.9 Using the Wireless LAN (WLAN)	8
1.10 Using the Battery Pack	8
1.11 Installing T1000/T1005 Device Drivers	9
1.12 Use your T1000/T1005 as a Tablet PC	10
1.13 Operating Temperature	10

Chapter 2 Battery

2.1 Battery Pack	12
2.2 Recharging the Battery Pack	12
2.3 Questions and Answers	12

2.4 Power Consumption	13
2.5 Removing the Battery Pack	13
2.6 Battery Capacity Inspection	14

Chapter 3 The T1000/T1005 Utilities

3.1 GIGABYTE Smart Manager	16
3.2 GIGABYTE Smart Recovery	18

Chapter 4 Troubleshooting / Q&A

4.1 Troubleshooting	20
4.2 Q&A	23

Appendix I Specifications

Appendix II GIGABYTE Service Information

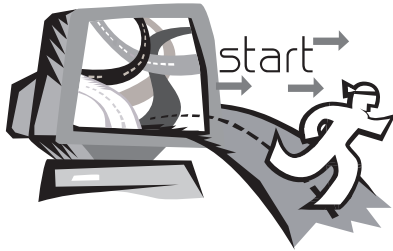

Chapter 1 Introducing Your T1000/T1005 Netbook

This chapter will show you how to operate your T1000/T1005 series netbook, including connecting the AC adapter, turning the computer on/off, using touch-pad, keyboard, hot keys, battery, and so on. If you are new to computers and to the operating system, this chapter will guide you through some of the new exciting features that are available .

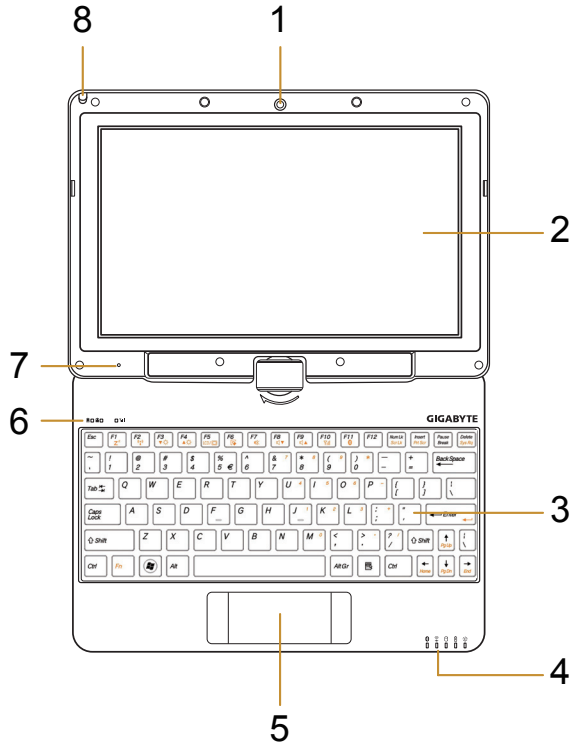

1.1 Panoramic View



#	Icon	Item	Description
1		Web Camera	Web camera for video communication.
2		LCD Display	Displays computer output.
3		Keyboard	For entering data into your computer.
4		LED Indicators	Show the status of certain system components and their active state.
5		Touchpad	Touch-sensitive pointing device which functions like a computer mouse.
6		Num. Lock, Caps Lock & 3.5G LEDs	Num. Lock, Caps Lock & 3.5G LED lights. (Please refer to the detailed descriptions of the LED indicators on Page 5 of the User's Manual.)
7		Microphone	Internal microphone for sound recording.
8		Stylus Pen Slot	The slot stores the Stylus Pen. (Both Stylus Pen Slot and Stylus Pen are only available in selected models).

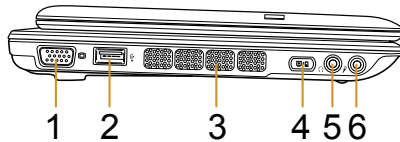

1.2 Left View

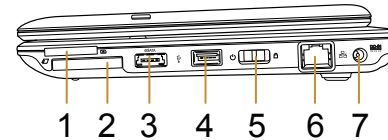

#	Icon	Item	Description
1		External Display (VGA) Port	Connects to a display device such as external monitor or LCD projector.
2		USB Port	Connects to USB devices such as a USB mouse, USB printers and USB external Hard drives.
3		Air Vent	To vent excess heat from the netbook.
4		Function Key	To activate the function key a).The battery capacity can be displayed when the battery is loaded and the function button is pressed in shutdown/standby/hibernate mode. b).In the Windows® 7 operation system: Open / Close the Smart Manager system utility.
5		Headphone Jack	Connects to audio line-out devices such as speakers and headphones.
6		Microphone Jack	Accepts inputs from external microphones.

1.3 Right View



#	Icon	Item	Description
1		Multi Card Reader	Accepts SD/MMC/MS/MS Pro memory cards.
2		Express Card Slot	Accepts PC Card Express 34 Cards. (Optional)
3	eSATA	eSATA/ USB Combo Port	The combo port doubles as an eSATA and a USB port allowing USB devices and external Hard Drives to be connected using just one port.
4		USB Port	Connects to USB devices such as USB mouse, USB printers and USB external Hard drives.
5		Power Button	Turns the computer on and off.
6		Ethernet Port	Connects to an Ethernet 10/100/1000 based network.
7		DC-in Jack	Connects the an AC adapter.

1.4 Cover View

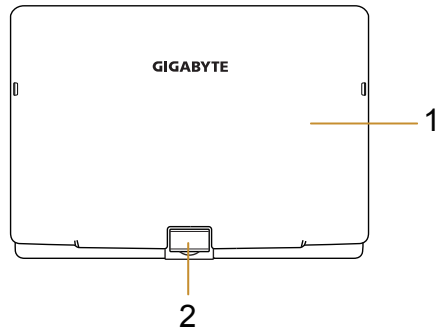

#	Item	Description
1	Cover	To protect the T1000/T1005 netbook.
2	Axle	To rotate the LCD Panel.



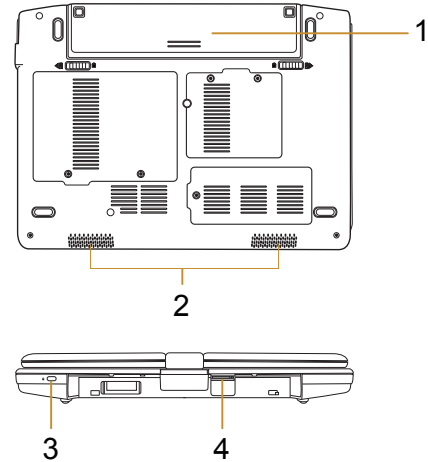



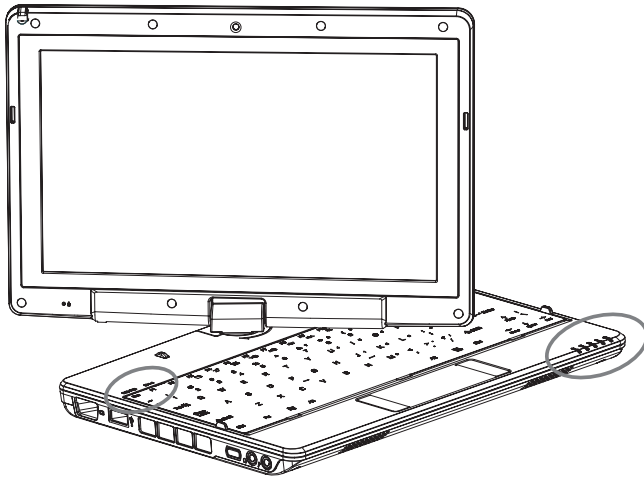

1.5 Bottom View



#	Item	Description
1	Battery	Computer battery pack.
2	Speaker	Delivers stereo audio.
3	Kensington Lock	Connects to a Kensington-compatible computer security lock.
4	SIM Card Slot	To insert of a mobile SIM card for the 3.5G function. (Optional)

1.6 Status Indicators



Icon	Item	Description
	Bluetooth Status LED	Indicates when the Bluetooth device is active.
	Wireless LAN Status LED	Indicates when the WiFi LAN device is active.
	HDD Status LED	Indicates when the hard disk drive is active.
	Battery Status LED	Flash when charging, and is off when the battery is full.
	Power Status LED	Indicates the computer's power status.
	Number-locked Indicator	The keyboard is in Number-lock mode.
	Caps-locked Indicator	The keyboard is in Caps-lock mode.
	3.5G Indicator	WWAN (3.5G) on/off status.

1.7 Turning Your T1000/T1005 Netbook On and Off

Turning on the power

Open the T1000/T1005 netbook lid and slide the power switch to the left for one or two seconds. The power indicator will glow blue once the computer is powered on.

Turning off the power





If you are not going to use your T1000/T1005 netbook for a while, it is best to turn off its power. Before turning off power, close all open programs first and shut down the operating system.

After turning off your T1000/T1005 netbook, make it a habit to leave the LCD panel open for a while after it has been used for an extended period of time. This allows the interior of your T1000/T1005 netbook to cool off. Closing the panel will force the heat up against the LCD screen, and doing so can cause lasting damage to the screen. More importantly, never close the LCD panel for a long period of time when the computer is on or when the power saving function is disabled.

1.8 Keyboard Functions







T1000/T1005 netbook is equipped with a standard typewriter-layout keyboard and has extra features.







Icon	Description
	Press Caps Lock to set all the characters input into UPPER CASE capital letter mode.
	To turn on the numeric keypad overlay, press Num Lk .
	Press this key to scroll the screen under some programs.
	Press this key to activate Windows® START menu. Can be used for Windows Shortcuts.
	Press this key to function as the right button of the mouse.

Fn Combination Keys (Hot Keys)

Use  **Fn** key combined with other keys to activate, close or set special functions. These combinations are also called Hot Keys. To use the Hot Keys, press and hold down **<Fn>** together with the keys described below:

Hotkey	Function	Description
Fn+F1 	Sleep	Enable the computer into Sleep mode.
Fn+F2 	Wireless LAN	Enables/disables the Wireless LAN function.
Fn+F3 	Brightness Down	Decrease the screen brightness.
Fn+F4 	Brightness Up	Increases the screen brightness.
Fn+F5 	Display Toggle	Switches display output between the display screen, external monitor (if connected) and both.
Fn+F6 	Touchpad Toggle	Turns the internal touchpad on and off.
Fn+F7 	Speaker Toggle	Turns the speaker on and off.

Fn+F8 	Volume Down	Decreases the sound volume.
Fn+F9 	Volume Up	Increases the sound volume.
Fn+F10 	3.5G	Enables / disables the 3.5G function.
Fn+F11 	Bluetooth	Enables/disables the Bluetooth function.

1.9 Using the Wireless LAN

You can use the Smart Manager (3.1 GIGABYTE Smart Manager Functions) or Fn combination keys (1.8 Keyboard Function) to turn on Wireless LAN.

Right-click the Wireless network icon on the Taskbar and select View available wireless network. Select AP (Access Point) you want to connect to and type necessary information. Click Connect. And If you place the mouse pointer on the Wireless network icon on the Taskbar, you can see the status of the wireless network.



.....

Tips: You can learn details by referring to instruction documentation for your wireless network.



.....

Notice: Creating security settings for the wireless LAN is important, we assume no responsibility for any security problems that may arise from the use of the Wireless LAN.

1.10 Using the Battery Pack

T1000/T1005 series netbook is designed to operate with one of the following power sources:

- AC power (using the AC adapter connected to an electrical outlet)
- Lithium-Ion (Li-Ion) battery pack

You should use the AC adapter whenever possible; use the battery pack only when AC power is unavailable. The rechargeable Li-Ion battery pack allows you to operate your T1000/T1005 computer without an external power source. When you use the AC adapter to connect your T1000/T1005 to a power outlet, the internal battery will begin to recharge. While the battery is charging, the Battery Charge icon on the indicator panel will be on. Once the battery is fully charged, the Battery Charge icon will turn off.

- Operating video, or audio equipment can increase the use of your computer's power.
- Decreasing monitor brightness can also save power.
- When the battery is not fully charged, allow your battery to be charged completely before using it (i.e., before disconnecting AC power).
- The battery will not be charged when remaining battery is higher than 95% (The battery will be charged to 100% when remaining battery is less than 95%).
- Li-Ion Battery is vulnerable; do not charge it with other power adapter, otherwise fire or explosion may occur.

Replacing the Battery

The battery will gradually weaken over time. We recommend that you replace your battery when you notice a significant decrease of battery capacity.

To change the battery pack, follow the steps below:

1. Turn off the computer.
2. Close the lid and flip the computer over.
3. Slide the battery latch. Continue to hold it until the battery is removed.
4. Make sure the replacement battery is properly oriented before inserting it into the battery compartment.

1.11 Installing T1000/T1005 Device Drivers

If your T1000/T1005 netbook already has an operating system installed, it is best to install all necessary device drivers in order for the hardware to properly function.

Before installing drivers, check with your vendors to see if they have already installed all the drivers with the operating system, if not, please place the Utility Driver CD into external CD RW/DVD RW Drive. An Auto Run installation screen will appear.



1.12 Use your T1000/T1005 as a Tablet PC

The screen of T1000/T1005 is convertible to simulate a Tablet PC. Follow the steps to use this function.

1. Open the lid (the screen display) of T1000/T1005.

2. On the top center above the keyboard is the pivot connecting the display panel to the bottom case. There is a sign "↻"

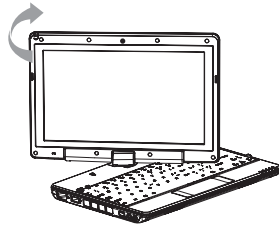

3. Follow the sign to turn the screen clockwise up to 180 degree so that the screen is facing out.

4. Lay the turned screen down into the flat position. The keyboard will be covered by the display. Use the stylus or simply touch the screen to operate T1000/T1005 as a Tablet PC.

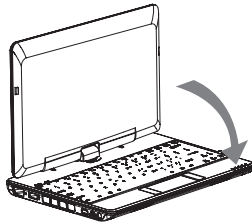

5. When done with Tablet PC, reverse the screen to 90 degree, turn counter set T1000/T1005 back to original posi

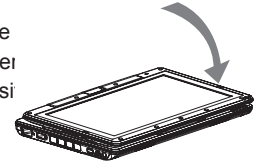

* Attention: Please note that the screen can only rotate at 180 degree clockwise. Be sure to turn the screen according to the sign. Forcing the screen to turn at the wrong angle will cause serious damage to the the T1000/T1005.

1.13 Operating Temperature

Operating Temperature : 10°C to 40°C

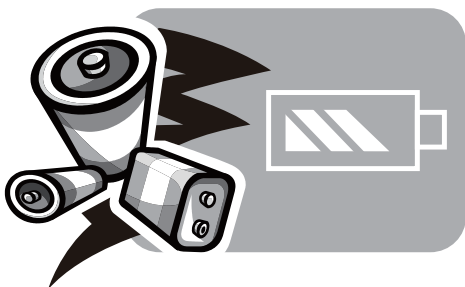

Chapter 2 Battery

2.1 Battery Pack

Your T1000/T1005 is equipped with a high-energy rechargeable Lithium Ion (Li-Ion) battery pack. Battery life will vary depending on the product configuration, product model, applications loaded on the product, power management settings of the product, and the product features used by the customer. As with all batteries, the maximum capacity of this battery will decrease with time and usage.

2.2 Recharging The Battery Pack

Your T1000/T1005 supports both on-line and off-line recharge. Follow the procedure below to recharge battery:

- Make sure the battery pack is installed in the T1000/T1005.
- Connect the AC adapter to the T1000/T1005 and to an electrical outlet.
- When a battery pack is being recharged, its battery LED (refer to 1.6 Status Indicators) should be lit.

2.3 Questions And Answers

- Q:** I can feel a mild heat next to the battery pack. Is it normal?
- A:** The battery will generate heat during recharging and discharging. There is a protection circuit inside the T1000/T1005 to prevent overheating. User needs not to worry.
- Q:** My battery operation time is not as long as it should be. Why?
- A:** The battery is heat sensitive and can only be charged to its maximum if the battery and its environmental temperature remain within 15-25°C (59-77°F). The more the temperature deviates from this range during recharging, the less chance there is for the battery to be fully charged. In order to recharge the pack to its full capacity, users are requested to cool down the unit by unplugging the AC Adapter. Wait until it is cooled down. Then plug in the AC Adapter to start recharging again.
- Q:** I did not use my spare battery for a few days. Even though it was fully recharged, there wasn't as much power left as a newly charged one. Why?
- A:** The batteries will self-discharge when they are not being recharged. To make sure a battery pack is fully charged, recharge before use. Always keep the battery inside the T1000/T1005 and have the AC adapter connected whenever possible.

Q: I did not use my spare battery for months. I have problem in recharging it.

A: If you happen to leave your battery pack to go through an extended period of self-discharge, say more than three months, the battery voltage level will become too low and needs to be Pre-Charged (to bring the battery voltage level high enough) before it automatically (for Li-Ion only) resumes its normal Fast Charge.

2.4 Power Consumption

Select Power Options in the Control Panel or Power Mode in Smart Manager (3.1 GIGABYTE Smart Manager Functions) to adjust Power Consumption.

2.5 Removing the Battery Pack

This battery pack can easily be removed and replaced. Make sure that the computer is properly shutdown before changing the battery pack. If you would like to change the battery pack while power is on, make sure this battery pack is not the only electrical source to the system unit. Follow the steps below to remove the battery pack.

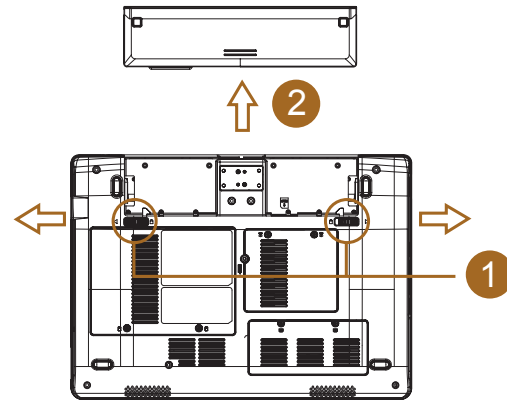

- Make sure the system is properly shutdown.
- Flip the system upside down as shown.
- Push the battery lock to the unlock position as shown by **#1**.
- Remove the battery pack as shown by **#2**.

To insert the battery pack, reverse the steps above.

2.6 Battery Capacity Inspection

When system is turn off, press the function key (Please refer to 1.2) to inspect the battery capacity.The LED indicators will show the battery capacity status.

The LED indicators will show the battery capacity status as following:

- 5 LED indicators on: Battery capacity 100%
- 4 LED indicators on: Battery capacity 80%
- 3 LED indicators on: Battery capacity 60%
- 2 LED indicators on: Battery capacity 40%
- 1 LED indicator on: Battery capacity 20%
- 1 LED indicator flashing: Low battery capacity
- No LED indicator on:
 - A. Please check the battery is inserted properly.
 - B. No battery capacity.



Chapter 3 The T1000/T1005 Utilities

3.1 GIGABYTE Smart Manager



Due to variations of Smart Manager versions, the interface, icons, sequence and functions might be different comparing to the guide.



Battery Status:

The Battery icon with capacity status will be shown on the screen after the battery is placed.



AC-IN:

The AC-IN icon will be shown on the screen once the AC Adapter is plugged in. The battery icon will be shown on the screen when using battery as the main power source.



Volume Control:

Press the volume control icon to adjust the volume level.



Mute:

Press the mute icon to enable/disable the mute mode.



Brightness:

Press the brightness icon to adjust the level of the display backlight brightness.



Power Mode:

Press the power mode icon to select different power management mode.



Wireless LAN:

Press the Wireless LAN icon to enable/disable Wireless LAN connectivity.



Bluetooth:

Press the Bluetooth icon to enable/disable Bluetooth radio.



3G:

Press the 3G icon to enable/disable 3G device. (Optional)

**Camera:**

Press the camera icon to turn on/off Webcam power.

**Smart Charge**

Press the Smart Charge icon to select the USB power supplying mode under Sleep Mode when using battery as the main power source *. (Optional)

**Screen Rotation:**

Press the screen rotation icon to rotate the display direction.

**Touch Screen Setting:**

Press the touch panel icon to adjust touch panel settings.

**USB3.0:**

Press the USB3.0 icon to enable/disable USB3.0 port. (Optional)

*** The Introduction of GIGABYTE Smart Charge function**

The GIGABYTE Smart Charge allows you to charge your digital devices through USB ports while the computer is in the sleep mode. When your computer is powered through an AC adapter by direct AC power supply, you will be able to use Smart Charge when the computer is in Off/Sleep/Hibernation mode. However, if the battery pack is the sole power supply for your computer, Smart Charge only works in Off/Hibernation mode.

To ensure sufficient power supply for system operation, you can set the computer (via GIGABYTE Smart Manager) to automatically cease this function at 50/40/30% of power level. (Note: Smart Charge function is available in selected models.)

3.2 GIGABYTE Smart Recovery

System Recovery - Restore your T1000/T1005 Operating System
The hard drive of the T1000/T1005 has a hidden partition that contains a full backup image of the operating system that can be used to recover the system in the event that something happens to the operating system.

! If the hard drive is removed or the partition deleted, the recover options will no longer be available and a recovery service will be needed.

Launch System Recovery

The System Recover feature is part of the notebook installation and it ships preset from the factory. The Options menu allows you to launch the Windows Recovery tool to reinstall the operating system to factory defaults.

Below will briefly describe how to launch the Recovery Tool and to get the recovery started.

1. Turn off or restart the notebook.
2. Turn the notebook on and press and hold the F9 key to launch the tool.



3. The recovery window will open and give you the option to "Recovery" in the toolbar. You will be prompted if you want to recovery. Click on "Recovery" to begin the repair if you do.



4. The "Recovering" window will open and begin the recovery.

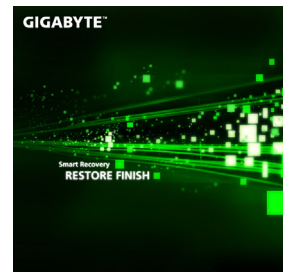

5. Once it is complete you will be prompted to reboot the notebook.

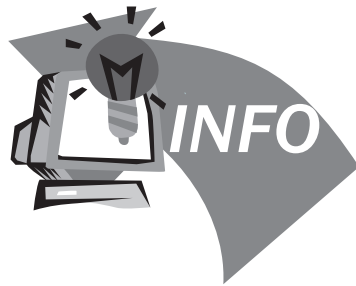

Chapter 4 Troubleshooting / Q&A

This chapter contains advice and solutions to a few basic troubles you might encounter when you use T1000/T1005. Please refer to this chapter and follow the instructions to solve troubles.

4.1 Troubleshooting



.....
Warning: Under the condition that you can't handle trouble, please refer to your dealer to get professional service.

AC Adapter

Trouble	Solution
No power supplies to T1000/T1005	Make sure the AC adapter is well connected to the power source and T1000/T1005. Check the cable and plug to make sure they are OK. If they are broken, please contact your local dealer ASAP.

Battery Pack

Trouble	Solution
No power supplies to T1000/T1005	The remaining power in battery pack may be not enough to power on the machine. Connect AC adapter to recharge it.
Can't be recharged after connecting AC adapter	Check temperature of battery pack's surface. Battery pack can't be recharged if its temperature is too high or too low. Recharged it after its temperature is the same with the normal environment one. If battery pack is fully discharged, it won't be recharged at once. Please wait for some minutes. If the power indicators of battery pack are always not lit up, its life may be over. Please contact your dealer to buy another one.

Battery life depends on using condition of T1000/T1005. You can change the settings in Power Manager of OS to save power.

Battery life is not as long as it should be

Battery pack can't exert its full capacity if it works when not fully recharged frequently. Power T1000/T1005 by battery pack until its power drops to a critically low level and the machine emits a high-pitched beep or displays a warning message; after that, recharge battery pack to make battery pack work longer.



WARNING: Please pay attention to the following information regarding the battery pack:

1. Be sure to recycle the waste batteries.
2. Do not place the batteries near high-temperature locations, fire source or in burning fire as this may cause the batteries to explode
3. Do not assemble/disassemble /modify the batteries without authorization.
4. Use the battery pack provided by the original manufacturer only. Batteries other than those supplied by the original manufacturer may damage the device.

Keyboard

Trouble	Solution
Press character keys but number displayed instead of character	Check if Num Lock is activated.
Confusing display	Make sure there is no software to configure the keyboard.

WARNING: Please pay attention to the following information about keyboard maintenance.

1. Dust built-up may occur to the keyboard after long-term use. It is recommended to clean the keyboard with a small brush. Please shut down the machine before cleaning the surface of the keyboard and wipe it with a soft cloth dipped in cleaner or water gently.
2. In case any liquid enters the keyboard, shut off the power supply immediately, remove the batteries and contact the original manufacturer directly for repair. Do not disassemble the keyboard yourself for repair.

Hard Disc Drive (HDD)

Trouble	Solution
HDD can't be booted	The operating system is corrupted by incorrect operation or virus. Try to clean virus and then configure your operating system correctly.
	Maybe the documents of your OS run in error; please refer to the manual of your OS.
HDD performs very slowly	There is too much file fragment. Use disk defrag tools to rearrange the programs on the hard disk.

WARNING: Please pay attention to the following information about Hard Drive maintenance.

1. The hard disk is a high-speed data storage device. Avoid using the T1000/T1005 in unstable locations as far as possible to prevent hard disk damage and data loss.
2. Please use the computer in accordance with normal startup/shutdown procedures; improper startup/shutdown may shorten the service life of the hard disk.

Printer

Trouble	Solution
The data can't be output from T1000/T1005 to printer	Make sure printer is powered on. Make sure its cable is OK and its USB interface is well connected to T1000/T1005.
Error printing	Make sure your printer is compatible to your T1000/T1005. Please refer to the user's manual of your printer for help.

LAN

Trouble	Solution
Can't be connected	Be sure the RJ45 connector is firmly connected to the network hub or switch.

USB

Trouble	Solution
Equipments connected can't work	The USB3.0 port (positioned at the left side of T1005) embedded with T1005 can't work under DOS mode. Please connect the USB cord of the equipment to other USB ports. Be sure the driver of the equipment is installed correctly.

LCD

Trouble	Solution
The screen is blank	<p>Press hot key Fn + F5 to change the display mode if certain external monitor is connected.</p> <p>Make sure the system isn't in the mode of Hibernation or Standby.</p>



WARNING: Please pay attention for below matters at mounting design of touch panel of LCD module.

1. Do not put a heavy force along the edge of active area
2. Do not put a heavy shock or stress on the touch panel and film surface.
3. Do not put heavy goods on the touch panel.



4. The touch control LCD screen is the most fragile component of the T1000/T1005 and is prone to rupture under external forces. Do not place any object on the keyboard or between the keyboard and the screen to prevent damage to the LCD screen.
5. When traveling with GIGABYTE T1000/T1005, place it in a special case in a tidy manner as far as possible. Excess objects may squeeze the machine and therefore damage the LCD screen.
6. Do not touch the screen with sharp objects directly.
7. It is recommended that the LCD screen be wiped with a special screen cleaning cloth. Wipe the screen gently to avoid breakage of the screen.
8. Prevent any liquid from entering the LCD screen as this may damage the elements of the LCD screen.

Audio

Trouble	Solution
	Adjust sound controller.
	Check the setting of sound volume of software.
No sound emitted	<p>Check if the ear phone is firmly connected.</p> <p>Check the Devices Manager of Windows. Be sure the Sound function has been activated and isn't interfered with other hardware.</p>

Sleep / Hibernation

Trouble	Solution
Can't enter into Standby/ Hibernation	Please check if the Windows Media Player is running. If Yes, the T1000/T1005 netbook can't enter into Standby or Hibernation mode. Please close Windows Media Player.

4.2 Q&A

- ◇ My computer switches to hibernation mode much too quickly, and I have to constantly hit a key or move the mouse to bring back the screen. What can I do?

This is part of Windows Power Management. Access Power Management by clicking on Start / Control Panel / Performance and Maintenance / Power Options, and change the time next to the "Turn off monitor" option to the time you want. You have the choice of either adjusting time for the power supply or for the battery.

- ◇ I've heard that cleaning and rearranging files on the hard drive will improve program's launch speed, how do I do that?

Good disk maintenances can improve program launch speed. This normally includes deleting unnecessary files, and defragmenting hard disk so that files can be more efficiently grouped. Windows contains maintenance utilities for these tasks; run Disk Cleanup to remove unnecessary files, and Disk Defragmenter to defragment file blocks. For more information about these utilities, please refer to your Windows documentation.

- ◇ What kind of external microphone can I use with my notebook computer?

You will need to use a self-amplifying microphone.

- ◇ There are echoes coming from my speakers. What can I do?

Double click on the Speaker icon on the task bar. Then, under Microphone Balance, check the Mute box.

- ◇ Because of a software problem, I was unable to shut the computer down from Windows, I pressed the power button to power off the computer, but it didn't work. How can I force a power off?

Make sure you press the power button for at least 4 seconds. Normally, this will force the computer to shut off.

- ◇ Why can't I charge the battery of my portable computer after it was out of use for some time?

After your portable computer has not been used for a long time (say, more than a month), the battery will enter into low voltage protection mode. Under this circumstance, restoring to normal voltage will require the battery to be slowly charged for several hours. Once the battery has been fully charged, your computer will resume to normal operation.

◇ My computer says: "CMOS Battery Low", what should I do?

If your computer is without power (i.e. unplug the computer power source from the power outlet and remove the battery pack from it) for over 45 days, you would lose the information stored in CMOS.

Please follow the steps below to reconfigure your CMOS settings:

1. Press F2 to enter into the BIOS setup utility.
2. Select "Load Optional Defaults?". When you see the following prompt, choose <OK> and then press <Enter>.
3. Select "Save Changes and Exit", select <OK> and press <Enter> to restart your computer.

◇ How to unplug or eject devices

1. In the notification area next to your task bar, double-click the Safe Removal icon. Safe Removal displays a list of Plug and Play devices that support safe removal and that are currently attached to the system.

If you do not see the Safe Removal icon, your device does not support safe removal, and you cannot unplug or eject your device using Safe Removal.

2. In Safely Remove Hardware, in the list of devices, select the device that you want to unplug or eject, and then click Stop. This tells the system that you will be unplugging or ejecting the device.

3. In Stop a Hardware device, click OK.

A notification appears stating that it is now safe to unplug or eject the device.

Caution

- Unplugging or ejecting a device that supports safe removal without first using the Safe Removal application to warn the system can cause data to be lost or your system to become unstable. For example, if you use Safe Removal, however, you can warn the system before you unplug or eject a device, preventing possible loss of data.

Note

- For removable storage devices that can safely be removed while the system is on, the system disables write caching by default. It does this so the devices can be removed without loss of data. When write caching is disabled, however, the system will likely experience slower performance, so be sure to enable write caching when you have finished removing the device.

◇ Does T1000/T1005 provide a hardware switch or function button to enable/disable the Bluetooth function?

T1000/T1005 provides a combined function button to enable/disable the 3G (Fn+F10) and Bluetooth (Fn+F11) functions. (3G is optional)

- ◇ What are the considerations for the use of the touch control screen?

In accordance with the principle of panel structure, the surroundings of the touch control panel are highly sensitive. Hence, drawing lines along the surroundings of the chassis is strictly prohibited as this may damage the Pet/film due to extreme pressure or cause the internal liners/pads on the edges of the outer shell to displace, therefore squeezing the edges of the touch control screen and causing the screen to fail.

- ◇ What is the capacity of SDHC card that T1000/T1005 can support?

The specification of SDHC that T1000/T1005 SD card reader supports shall be in accordance with that of the SD Association. Currently, the maximum capacity announced by SD Association is 32GB
<http://www.sdcard.org/developers/tech/sdhc/>

- ◇ How can T1000/T1005 be upgraded in the DOS and Windows mode?

Please refer to GIGABYTE official website
www.gigabyte.com

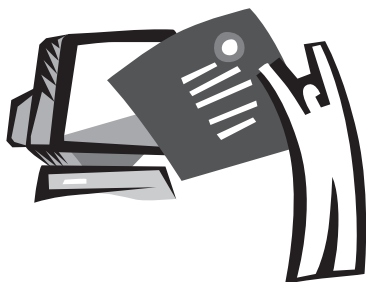

Appendix I Specifications

Specifications		
CPU	Intel® Atom™ Processor	
OS	Microsoft® Windows®7 Compliance	
LCD	10.1" HD Ready TFT-LCD Touch Panel, WXGA 1366x768, with LED back-light	
System Memory	DDRII SO-DIMM*1 (Max 2GB) / DDRIII SO-DIMM*1 (Max 2GB)	
Chipset	Intel® NM10 Express Chipset	
Video Graphics	Intel® GMA 3150	
Hard Disk Drive	2.5" 9.5mm SATA HDD 5400rpm	
I/O Port	USB Port*2, eSATA/USB Combo, D-sub, RJ45, Mic-in, Earphone-out, 4-in-1 Card Reader (SD/MMC/MS/MS Pro), Express Card Slot (Optional), DC-in Jack	
Audio	1.5Watt Speaker*2, Internal Microphone	
Communications	LAN	10/100/1000Mbps Ethernet
	Wireless LAN	802.11b/g/n Wireless
	Bluetooth	Bluetooth V2.1 + EDR
	HSDPA (3.5G)	HSDPA Antenna built-in, HSDPA Module supported (Optional)
Webcam	1.3 Mega Pixel Webcam	
Security	Kensington Lock	
Battery	Li-ion 4 cell, 4500mAh Li-ion 6 cell, 6600mAh / 7650mAh	
Dimensions	265(W) x 195(D) x 38.5(H) mm (including 4 cell battery) 265(W) x 214(D) x 41.4(H) mm (including 6 cell battery)	
Weight	~1.3kg (including 4 cell battery) ~1.48kg (including 6 cell battery)	
Remark	Stylus Pen Slot and Stylus Pen are only available in selected models.	

* The Specifications list above may appear different from your model.

Appendix II GIGABYTE Service Information

More service information please link to GIGABYTE official website:
www.gigabyte.com