



imageCLASS

MF3010 / MF3010VP

User's Guide

Contents

Important Safety Instructions	2
Important Safety Instructions	3
Installation	4
Power Supply	6
Handling	8
Maintenance and Inspections	10
Consumables	12
Others	14
Installation and Handling	15
Basic Operation	19
Parts and Their Functions	20
Front Side	21
Back Side	22
Interior	23
Paper Cassette	24
Operation Panel and Display	25
Using the Quick Reference Guide	27
Energy Saving Functions (Sleep Mode)	29
How to Operate Menus	30
Setting List	31
Toner Cartridges	36
About the Supplied Toner Cartridge	37
About Replacement Toner Cartridges	38
Handling Toner Cartridges	39
Storing Toner Cartridges	41
Purchasing Consumables	42
Placing Documents	43
Attention (Placing Documents)	45
Loading Paper	46
In the Paper Cassette	47
Attention (Loading Paper)	50
Paper Loading Capacity	51
Paper Loading Orientation	52
Setting a Paper Type	54
Initializing Menus	56
Printing the User Data List	57
Upgrading Firmware	58
Locating the Serial Number	59

Specifications	61
Machine Specifications	62
Copy Specifications	63
Printer Specification	64
Scanner Specifications	65
Document Type	66
Supported Document Types	67
Scan Area	68
Paper	69
Supported Paper Types	70
Printable Area	73
Copy	75
Basic Copy Operations	76
Registering the Quantity that You Frequently Copy (Up to Twenty-nine Copies)	78
Adjusting the Density	79
Enlarging/Reducing Copy	81
Copying Both Sides of Cards onto One Side (ID Card Copy)	83
Copying Two Documents onto One Sheet (2 on 1 Copy)	86
Selecting Copy Type (Speed Priority/Resolution Priority)	88
Emphasizing the Outline of an Image (Sharpness)	90
Print	93
Preparing to Print from Your Computer	94
Setting Up Printer Sharing	95
Printing Fundamentals	97
Printing	98
Configuring the Default Print Settings	101
Viewing the Online Help	103
Printing on Custom Paper Size	105
Registering a Custom Paper Size	106
Canceling Print	107
Selecting and Canceling Jobs	108
Scan	110
Preparing to Use the Scan Functions	111
System Requirements (Scan)	112
Basic Scan Flow	113
Scanning Using the MF Toolbox	114
Scanning an Image Using an Application	116
Scanning Using the WIA Driver	117
[New Scan] Dialog Box	121
Attention (WIA Driver)	123

Using the MF Toolbox	124
Combining Multiple Documents into One PDF File	130
Using the ScanGear MF	132
Using Simple Mode	133
Using Advanced Mode	136
Defining a Scan Area (Cropping Frame)	148
Setting Resolution	150
Troubleshooting	152
Clearing Jams	153
Removing Jammed Paper	155
Troubleshooting	160
Paper Feeding Problems	162
Cannot Print, or the Images on Printouts are Spotted or Distorted	163
Copying Problems	164
The Copy Output is Hardly Readable and Copied Poorly	165
Printing Problems	166
Cannot Print Documents from a Computer	167
Scanning Problems	168
Cannot Scan a Document	170
Installation and Uninstallation Problems	172
Miscellaneous Problems	173
Printing Results are Not Good	174
Paper Curls	175
Paper Creases	176
Printing is Uneven	177
White Specks or Spots Appear on the Printout	178
The Toner does Not Flow Well into the Paper	179
Vertical Streaks Appear on the Output	180
Toner Smudges and Spatters Appear around Text and Images	181
The Printout is Too Dark	182
Printed Bar Codes Cannot be Scanned	183
Images may be partially cut off on the output	184
Uninstalling the Software	185
When a Service Error Has Occurred	188
When a Problem cannot be Resolved	189
Maintenance	192
Cleaning the Machine	193
Cleaning the Exterior	194
Cleaning the Inside of the Machine	195
Cleaning the Fixing Unit	198
Cleaning the Platen Glass	199
Attention (Cleaning the Machine)	200

Replacing Toner Cartridges	202
Before Replacing the Toner Cartridge	203
Replacing the Toner Cartridge	206
Attention (Replacing the Toner Cartridge)	210
Special Mode	213
Relocating the Machine	216
Attention (Relocating the Machine)	219
Appendix	221
Third Party Software	222
Manuals and Their Contents	223
Basic Windows Operations	224
Disclaimers	227
Copyright	228
Trademarks	229
Using User's Guide	231
Screen Layout of the User's Guide	232
Top Page	233
Topic Page	235
Search Method	236
Viewing the User's Guide	237

Important Safety Instructions

Important Safety Instructions	2
Important Safety Instructions	3
Installation	4
Power Supply	6
Handling	8
Maintenance and Inspections	10
Consumables	12
Others	14
Installation and Handling	15

Important Safety Instructions

85RS-000

Please read these "Important Safety Instructions" thoroughly before using the machine.

These instructions are intended to prevent injuries to you and other persons as well as equipment damage. Failure to follow these instructions could result in serious personal injury, product damage, or improper operation.

Please follow the instructions in this manual.

Important Safety Instructions

85RS-001

Please read the following safety warnings and precautions before using the machine.

- ▶ " **Installation(P. 4)** "
- ▶ " **Power Supply(P. 6)** "
- ▶ " **Handling(P. 8)** "
- ▶ " **Maintenance and Inspections(P. 10)** "
- ▶ " **Consumables(P. 12)** "
- ▶ " **Others(P. 14)** "

Installation

85RS-002

To use this machine safely and comfortably, carefully read the following precautions and install the machine in an appropriate location.

WARNING

- Do not install the machine in a location near alcohol, paint thinner, or other flammable substances. If flammable substances come into contact with electrical parts inside the machine, this may result in a fire or electrical shock.
- Do not connect unapproved cables to this machine. Doing so may result in a fire or electrical shock.
- If any foreign substance falls into this machine, unplug the power plug from the AC power outlet and contact your local authorized Canon dealer.
- Do not place the following items on the machine.
 - Necklaces and other metal objects
 - Cups, vases, flowerpots, and other containers filled with water or liquids

If these items come into contact with a high-voltage area inside the machine, this may result in a fire or electrical shock.

If these items are dropped or spilled inside the machine, immediately turn off the power switches of the machine and computer (1) and disconnect the interface cable if it is connected (2). Then, unplug the power plug from the AC power outlet (3) and contact your local authorized Canon dealer.

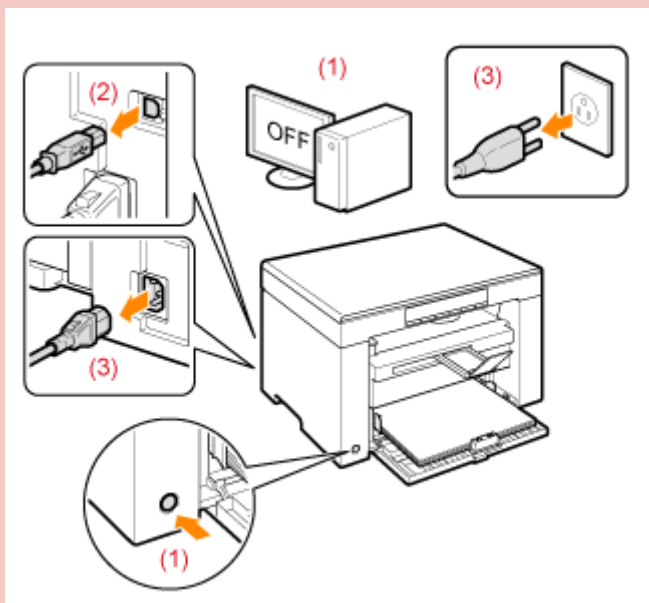

CAUTION

- Do not install the machine in unstable locations, such as on unsteady platforms or inclined floors, or in locations subject to excessive vibrations, as this may cause the machine to fall or tip over, resulting in personal injury.
- The ventilation slots are provided for proper ventilation of working parts inside the machine. Never place the machine on a soft surface, such as a bed, sofa, or rug. Blocking the slots can cause the machine to overheat, resulting in a fire.
- Do not install the machine in the following locations, as this may result in a fire or electrical shock.

- A damp or dusty location
 - A location exposed to smoke and steam, such as near a cookery or humidifier
 - A location exposed to rain or snow
 - A location near a water faucet or water
 - A location exposed to direct sunlight
 - A location subject to high temperatures
 - A location near open flames
- When installing the machine, gently lower the machine to the installation site so as not to catch your hands between the machine and the floor or between the machine and other equipment, as this may result in personal injury.
 - When connecting the interface cable, connect it properly by following the instructions in this manual. If not connected properly, this may result in malfunction or electrical shock.
 - When moving the machine, follow the instructions in this manual to hold it correctly. Failure to do so may cause you to drop the machine, resulting in personal injury.
🔧 " **Relocating the Machine(P. 216)** "
 - Machines with a hard disk may not operate properly when used at high altitudes of about 3,000 meters above sea level, or higher.

 **IMPORTANT**

If the operating noise concerns you

Depending on the use environment and operating mode, if the operating noise is of concern, it is recommended that the machine be installed in a place other than the office.

Power Supply

85RS-003

WARNING

- Do not damage or modify the power cord. Also, do not place heavy objects on the power cord or pull on or excessively bend it. This can cause electrical damage, resulting in fire or electrical shock.
- Keep the power cord away from all heat sources. Failure to do so can cause the power cord insulation to melt, resulting in a fire or electrical shock.
- The power cord should not be taut, as this may lead to a loose connection and cause overheating, which could result in a fire.
- The power cord may become damaged if it is stepped on, fixed with staples, or if heavy objects are placed on it. Continued use of a damaged power cord can lead to an accident, such as a fire or electrical shock.
- Do not plug or unplug the power plug with wet hands, as this can result in electrical shock.
- Do not plug the power cord into a multiplug power strip, as this can result in a fire or electrical shock.
- Do not bundle up or tie up the power cord in a knot, as this can result in a fire or electrical shock.
- Insert the power plug completely into the AC power outlet. Failure to do so can result in a fire or electrical shock.
- If excessive stress is applied to the connection part of the power cord, it may damage the power cord or the wires inside the machine may be disconnected. This could result in a fire. Avoid the following situations:
 - Connecting and disconnecting the power cord frequently.
 - Tripping over the power cord.
 - The power cord is bent near the connection part, and continuous stress is being applied to the power outlet or the connection part.
 - Applying a shock to the power connector.
- The machine must be connected to a socket-outlet with grounding connection by the provided power cord.
- Do not use power cords other than the one provided, as this can result in a fire or electrical shock.
- The provided power cord is intended for use with this machine. Do not connect the power cord to other devices.
- As a general rule, do not use extension cords. Using an extension cord may result in a fire or electrical shock.
- Remove the power plug from the AC power outlet and refrain from using the machine during a thunder storm. Lightning can result in a fire, electrical shock or malfunction.
- Make sure that the power supply for the machine is safe, and has a steady voltage.

CAUTION

Important Safety Instructions

- Do not use a power supply voltage other than that listed herein, as this may result in a fire or electrical shock.
- Always grasp the power plug when unplugging the power plug. Do not pull on the power cord, as this may expose the core wire of the power cord or damage the cord insulation, causing electricity to leak, resulting in a fire or electrical shock.
- Leave sufficient space around the power plug so that it can be unplugged easily. If objects are placed around the power plug, you may be unable to unplug it in an emergency.

Handling

85RS-004

WARNING

- Do not disassemble or modify the machine. There are high-temperature and high-voltage components inside the machine which may result in a fire or electrical shock.
- Electrical equipment can be hazardous if not used properly. Do not allow children to touch the power cord, cables, internal gears, or electrical parts.
- If the machine makes an unusual noise or emits smoke, heat, or an unusual smell, immediately turn off the power switches of the machine and computer and disconnect the interface cable if it is connected. Then, unplug the power plug from the AC power outlet and contact your local authorized Canon dealer. Continued use can result in a fire or electrical shock.
- Do not use flammable sprays near the machine. If flammable substances come into contact with electrical parts inside the machine, this may result in a fire or electrical shock.
- Always turn off the power switches of the machine and computer, and then unplug the power plug and interface cables before moving the machine. Failure to do so can damage the cables or cords, resulting in a fire or electrical shock.
- Confirm that the power plug or power connector is inserted completely after moving the machine. Failure to do so can result in an overheating and fire.
- Do not drop paper clips, staples, or other metal objects inside the machine. Also, do not spill water, liquids, or other flammable substances (alcohol, benzene, paint thinner, etc.) inside the machine. If these items come into contact with a high-voltage area inside the machine, this may result in a fire or electrical shock. If these items are dropped or spilled inside the machine, immediately turn off the power switches of the machine and computer and disconnect the interface cable if it is connected. Then, unplug the power plug from the AC power outlet and contact your local authorized Canon dealer.
- When plugging or unplugging a USB cable when the power plug is plugged into an AC power outlet, do not touch the metal part of the connector, as this can result in electrical shock.

CAUTION

- Do not place heavy objects on the machine. The object or the machine may fall, resulting in personal injury.
- Turn off the power switch when the machine will not be used for a long period of time, such as overnight. Turn off the machine and unplug the power plug if the machine will not be used for an extended period of time, such as for several days.
- Open or close covers and install or remove cassettes gently and carefully. Be careful not to hurt your fingers.
- Keep your hands and clothing away from the roller in the output area. Even if the machine is not printing, the roller may suddenly rotate and catch your hands or clothing, resulting in personal injury.

Important Safety Instructions

- The output slot is hot during and immediately after printing. Do not touch the area surrounding the output slot, as this may result in burns.
- Printed paper may be hot immediately after being output. Be careful when removing the paper and aligning the removed paper, especially after continuous printing. Failure to do so may result in burns.
- When performing tasks such as clearing paper jams, take care be careful not to reach your hand too far into the machine. Doing so could result in injury.
- When performing copy with a thick book placed on the platen glass, do not press the platen glass forcefully. This may damage the platen glass and cause personal injury.
- Be careful not to drop a heavy object, such as a dictionary, on the platen glass. This may damage the platen glass and cause personal injury.
- Close the platen glass gently so as not to catch your hand. This may result in personal injury.
- The laser beam can be harmful to the human body. The laser beam is confined in the laser scanner unit by a cover, so there is no danger of the laser beam escaping during normal machine operation. Read the following remarks and instructions for safety.
 - Never open covers other than those indicated in this manual.
 - Do not remove the caution label attached to the cover of the laser scanner unit.



- If the laser beam should escape and enter your eyes, exposure may cause damage to your eyes.

Maintenance and Inspections

85RS-005

WARNING

- When cleaning the machine, turn off the machine and computer, and unplug the interface cables and power plug. Failure to do so can result in a fire or electrical shock.
- Unplug the power plug from the AC power outlet periodically and clean the area around the base of the power plug's metal pins and the AC power outlet with a dry cloth to remove all dust and grime. In damp, dusty, or smoky locations, dust can build up around the power plug and become damp, which can cause a short circuit, resulting in a fire.
- Use a damp, well wrung-out cloth to clean the machine. Dampen cleaning cloths with water only. Do not use alcohol, benzine, paint thinner, or other flammable substances. Do not use tissue paper or paper towels. If these substances come into contact with electrical parts inside the machine, they may generate static electricity or result in a fire or electrical shock.
- Some areas inside the machine are subject to high voltage. When removing jammed paper or when inspecting inside of the machine, be careful not to allow necklaces, bracelets, or other metal objects to touch the inside of the machine, as this can result in burns or electrical shock.
- Do not dispose of used toner cartridges in open flames. This may cause the toner remaining inside the cartridges to ignite, resulting in burns or fire.
- If you accidentally spill or scatter toner, carefully gather the toner particles together or wipe them up with a soft, damp cloth in a way that prevents inhalation. Never use a vacuum cleaner that does not have safeguards against dust explosions to clean up spilled toner. Doing so may cause a malfunction in the vacuum cleaner, or result in a dust explosion due to static discharge.
- Confirm that the power plug or power connector is inserted completely after cleaning the machine. Failure to do so can result in an overheating and fire.
- Check the power cord and plug regularly. The following conditions may result in fire, so please contact your local authorized Canon dealer or the Canon help line.
 - There are burn marks on the power plug.
 - The blade on the power plug is deformed or broken.
 - The power is turned OFF or ON when bending the power cord.
 - The coating of the power cord is damaged, cracked, or dented.
 - A part of the power cord becomes hot.
- Check regularly that the power cord and plug are not handled in the following manner. Failure to do so can result in a fire or electrical shock.
 - The power connector is loosened.
 - Stress is being applied to the power cord by a heavy object or by fixing it with staples.
 - The power plug is loosened.
 - The power cord is tied in a bundle.
 - A part of the power cord is put in an aisle.
 - The power cord is put in front of the heating appliance.

⚠ CAUTION

- The fixing unit and its surroundings inside the machine become hot during use. When removing jammed paper or when inspecting the inside of the machine, do not touch the fixing unit and its surroundings, as this may result in burns.

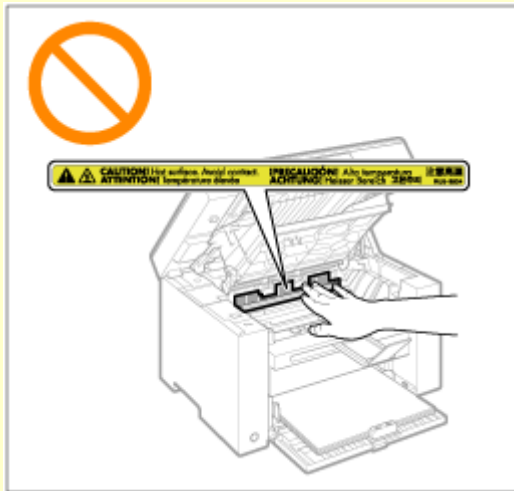

- When removing jammed paper or when inspecting the inside of the machine, do not expose yourself to the heat emitted from the fixing unit and its surroundings for a prolonged period of time. Doing so may result in low temperature burns, even though you did not touch the fixing unit and its surroundings directly, as this may result in burns.
- If paper is jammed, remove the jammed paper so that any pieces of paper do not remain inside the machine. Also, do not put your hand in an area other than indicated areas, as this may result in personal injuries or burns.
- When removing jammed paper or replacing a toner cartridge, be careful not to get any toner on your hands or clothing, as this will dirty your hands or clothing. If toner gets on your hands or clothing, wash them immediately with cold water. Washing with warm water sets the toner, making it impossible to remove the toner stains.
- When removing jammed paper, be careful not to allow the toner on the paper to scatter. The toner may get into your eyes or mouth. If toner gets into your eyes or mouth, wash them immediately with cold water and consult a physician.
- When loading paper or removing jammed paper, be careful not to cut your hands with the edges of the paper.
- When removing a toner cartridge, remove the toner cartridge carefully so as to prevent the toner from scattering and getting into your eyes or mouth. If toner gets into your eyes or mouth, wash them immediately with cold water and consult a physician.
- Do not attempt to disassemble the toner cartridge. The toner may scatter and get into your eyes or mouth. If toner gets into your eyes or mouth, wash them immediately with cold water and consult a physician.
- If toner leaks from the toner cartridge, be careful not to inhale the toner or allow it to come into direct contact with your skin. If the toner comes into contact with your skin, wash with soap. If the skin becomes irritated or you inhale the toner, consult a physician immediately.

Consumables

85RS-006

WARNING

- Do not dispose of used toner cartridges in open flames. This may cause the toner to ignite, resulting in burns or fire.
- Do not store toner cartridges or paper in a location exposed to open flames. This may cause the toner or paper to ignite, resulting in burns or fire.
- When disposing of a toner cartridge, place the toner cartridge into a bag to prevent the toner from scattering, and then dispose of the toner cartridge according to local regulations.
- If you accidentally spill or scatter toner, carefully gather the toner particles together or wipe them up with a soft, damp cloth in a way that prevents inhalation. Never use a vacuum cleaner that does not have safeguards against dust explosions to clean up spilled toner. Doing so may cause a malfunction in the vacuum cleaner, or result in a dust explosion due to static discharge.

If you are using a cardiac pacemaker

The toner cartridge generates a low level magnetic flux. If you are using a cardiac pacemaker and feel abnormalities, please move away from the toner cartridge and consult your physician immediately.

CAUTION

- Keep the toner cartridges and other consumables out of the reach of small children. If the toner or other parts are ingested, consult a physician immediately.
- Do not attempt to disassemble the toner cartridge. The toner may scatter and get into your eyes or mouth. If toner gets into your eyes or mouth, wash them immediately with cold water and consult a physician.
- If toner leaks from the toner cartridge, be careful not to inhale the toner or allow it to come into direct contact with your skin. If the toner comes into contact with your skin, wash with soap. If the skin becomes irritated or you inhale the toner, consult a physician immediately.
- Do not pull out the sealing tape forcefully or stop at midpoint, as this may cause toner to spill out. If toner gets into your eyes or mouth, wash them immediately with cold water and consult a physician.

IMPORTANT

Be careful of counterfeit toner cartridges

Please be aware that there are counterfeit Canon toner cartridges in the marketplace. Use of counterfeit toner cartridge may result in poor print quality or machine performance. Canon is not responsible for any malfunction, accident or damage caused by the use of counterfeit toner cartridge.

For more information, see global.canon/ctc.

Toner cartridge packing materials

- Save the packing materials for the toner cartridge. They are required when transporting this machine.
- The packing materials may be changed in form or placement, or may be added or removed without notice.

Important Safety Instructions

- After you pull out the sealing tape from the toner cartridge, dispose of it in accordance with the applicable local regulations.

When disposing of a used toner cartridge or the like

When discarding a toner cartridge or the like, place it in the original packing material to prevent toner from scattering from inside, and dispose of it in accordance with the applicable local regulations.

Others

85RS-007

 **WARNING**

If you are using a cardiac pacemaker

This machine generates a low level magnetic field. If you use a cardiac pacemaker and feel abnormalities, please move away from this machine and consult your physician immediately.

Installation and Handling

85RS-008

To make sure safe and trouble-free operation, the following installation requirements must be observed.

Read the instructions carefully before installing the machine.

- ▶ **Temperature and Humidity Conditions(P. 15)**
- ▶ **Power Supply Requirements(P. 15)**
- ▶ **Installation Requirements(P. 16)**
- ▶ **Installation Space(P. 17)**
- ▶ **Maintenance and Inspections(P. 17)**
- ▶ **Customer Support(P. 17)**

IMPORTANT

Important Safety Instructions

Be sure to read "Important Safety Instructions" before installing the machine.

Temperature and Humidity Conditions

- Temperature range: 10 to 30°C (50 to 86°F)
- Humidity range: 20 to 80 % RH (no condensation)

IMPORTANT

Protecting the machine from condensation

- Allow the machine to adjust to the installation environment (room temperature and humidity) for at least two hours before using, to prevent condensation from forming inside the machine when:
 - the installation location is warmed up too rapidly.
 - the machine has been moved to a hot, humid location from a cool, dry location.
- If water droplets (condensation) form inside the machine, this may result in paper jams or poor print quality.

To use an ultrasonic humidifier

We recommend that purified or impurity-free water be used when using an ultrasonic humidifier. The use of tap water or well water may result in contamination by impurities in the air, as well as print quality degradation due to water trapped inside the machine.

Power Supply Requirements

110 to 127 V, 50/60 Hz

IMPORTANT

Precautions when connecting the power cord

- Do not connect the machine to an uninterruptible power source.

- Make sure to plug an AC power plug into the AC outlet. Do not use the other sockets of the AC outlet.
- Do not plug the power plug into the auxiliary outlet on a computer.
Do not connect the machine and any of the following devices to the same AC outlet.
 - Copy machine
 - Air conditioner
 - Shredder
 - Equipment that consumes a large amount of electricity
 - Equipment that generates electrical noise
- Wait for at least five seconds to plug the power cord into the outlet again after the cord has been unplugged.

Miscellaneous precautions

- The maximum power consumption of the machine is 900 W or less.
- Electrical noise or a dramatic voltage drop may result in improper operation and irretrievable data loss.

Installation Requirements

- A location that has sufficient free space
- A location that has good ventilation
- A location that has a flat, even surface
- A location that can withstand the weight of the machine

IMPORTANT

Do not install the machine at the following locations, as this may result in product damage.

- A location subject to dramatic temperature and humidity changes
- A location subject to condensation
- A poorly ventilated location
(If you perform high-volume printing for an extended period of time using the machine placed in a poorly ventilated room, you may be exposed to ozone and odors generated by the machine, as well as chemical particles released during printing.
It is highly important that proper ventilation be assured at the installation location.)
- A location near equipment that generates magnetic or electromagnetic waves
- A laboratory or location where chemical reactions occur
- A location exposed to salt air, corrosive gases, or toxic gases
- A location where the floor is covered with a carpet or floor mat, to cause the machine to slide easily over or sink into the carpet or mat from its weight

Installation Space

Required installation space

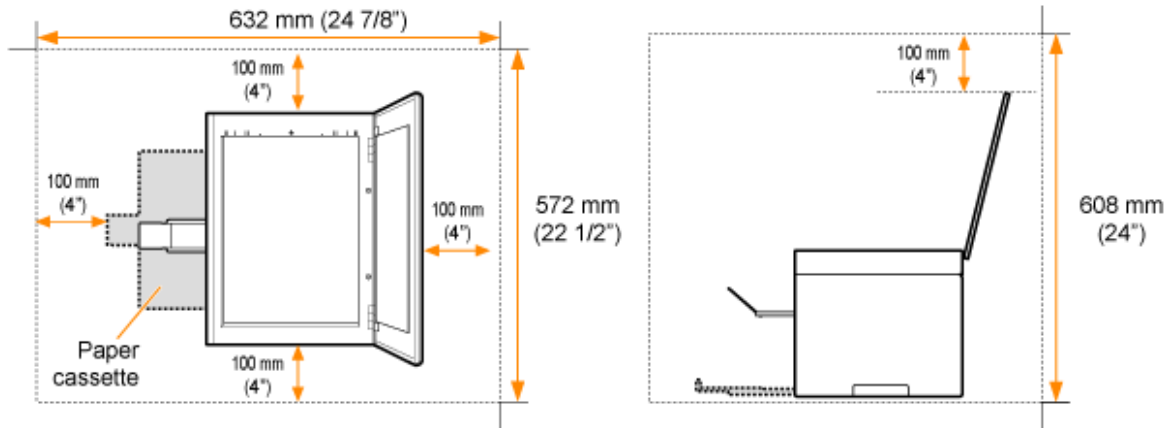

Maintenance and Inspections

IMPORTANT

- Follow the instructions written on the caution label attached to this machine.
- Avoid shaking or applying a shock to the machine.
- To prevent a paper jam, do not turn the power ON/OFF, open/close the operation panel or rear cover, and load/unload paper in the middle of printing operation.
- Be sure to remove the toner cartridges from the machine when moving the machine.
- To avoid exposing the toner cartridge to light, place it in the protective bag that comes with the machine or wrap it in a thick cloth.
- Clean this machine periodically. If dust accumulates, the machine may not operate properly. If a problem occurs during operation, see "**Troubleshooting(P. 152)**". If the problem cannot be resolved or you feel the machine requires an inspection, see "**When a Problem cannot be Resolved(P. 189)**".
- The repair parts and toner cartridge for use with the machine will be available for at least seven (7) years after this machine model has been discontinued.

Customer Support

The machine is designed to make sure safe use and be maintenance-free. If a problem occurs during operation, see "**Troubleshooting(P. 152)**". When the problem cannot be resolved after referring to the appropriate trouble shooting section, contact your local authorized Canon dealer or the Canon help line.

Basic Operation

Basic Operation	19
Parts and Their Functions	20
Front Side	21
Back Side	22
Interior	23
Paper Cassette	24
Operation Panel and Display	25
Using the Quick Reference Guide	27
Energy Saving Functions (Sleep Mode)	29
How to Operate Menus	30
Setting List	31
Toner Cartridges	36
About the Supplied Toner Cartridge	37
About Replacement Toner Cartridges	38
Handling Toner Cartridges	39
Storing Toner Cartridges	41
Purchasing Consumables	42
Placing Documents	43
Attention (Placing Documents)	45
Loading Paper	46
In the Paper Cassette	47
Attention (Loading Paper)	50
Paper Loading Capacity	51
Paper Loading Orientation	52
Setting a Paper Type	54
Initializing Menus	56
Printing the User Data List	57
Upgrading Firmware	58
Locating the Serial Number	59

Basic Operation

85RS-009

This chapter describes the features and useful functions of the machine. The following sections give a brief overview of the machine and instructions on how to use the machine efficiently. Read these sections thoroughly before using the machine.

Learning about parts of the machine	See " Parts and Their Functions(P. 20) ."
Learning about energy saving functions (sleep functions)	See " Energy Saving Functions (Sleep Mode)(P. 29) ."
Navigating the Menu	See " How to Operate Menus(P. 30) ."
Checking the details of the toner cartridges	See " Toner Cartridges(P. 36) ."
Placing documents	See " Placing Documents(P. 43) ."
Loading paper	See " Loading Paper(P. 46) ."
Setting the paper type	See " Setting a Paper Type(P. 54) ."
Restoring the setup menus to the default value	See " Initializing Menus(P. 56) ."
To check menu settings	See " Printing the User Data List(P. 57) ."
Checking the counter	
Learning about firmware upgrades	See " Upgrading Firmware(P. 58) ."
Locating the serial number	See " Locating the Serial Number(P. 59) ."

Parts and Their Functions

85RS-00A

This section describes the parts of the machine and their functions.

- ▶ " **Front Side(P. 21)** "
- ▶ " **Back Side(P. 22)** "
- ▶ " **Interior(P. 23)** "
- ▶ " **Paper Cassette(P. 24)** "
- ▶ " **Operation Panel and Display(P. 25)** "

Front Side

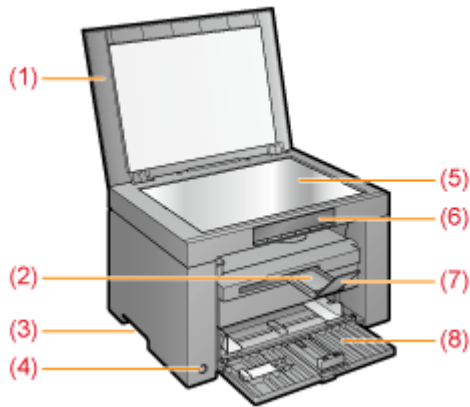

- (1) Platen Glass Cover**
Protects the platen glass.
- (2) Output Tray Extension**
Extend this tray to load large size documents.
- (3) Lift Handles**
Hold this handles to lift or transport the machine.
- (4) Power Switch**
Used to switch the machine ON or OFF.
- (5) Platen Glass**
Load paper.
- (6) Operation Panel**
Used to control the machine.
▶ " Operation Panel and Display(P. 25) "
- (7) Paper Stopper**
Prevents paper from falling from the output tray.
- (8) Paper Cassette**
Load the paper.
▶ " Paper Cassette(P. 24) "

Back Side

85RS-00E

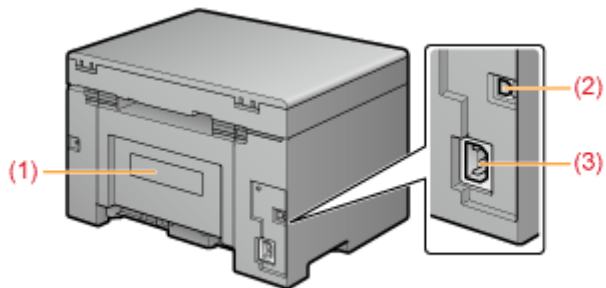

(1) Rating Label

The current value indicated in this rating label shows the average power current consumption.

(2) USB Port

Connect the USB cable.

(3) Power Socket

Connect the power cord.

Interior

85RS-00F

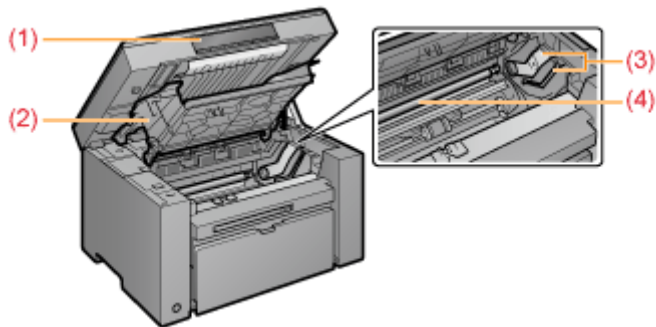

(1) Scanning Platform

Open this cover to replace the toner cartridge or clear paper jams.

(2) Toner Cover

Open this cover to replace the toner cartridge or clear paper jams.

(3) Toner Guides

Used to insert the toner cartridge so that the protrusion on the side of the toner cartridge fits into these guides.

(4) Transfer Roller

Used to transfer toner onto paper.

Paper Cassette

85RS-00H

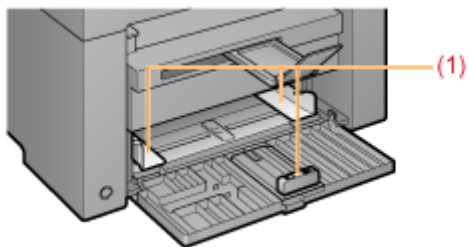

(1) Paper Guides

Adjust these guides to fit the document.



Operation Panel and Display

- ▶ Operation Panel(P. 25)
- ▶ Viewing the Display(P. 25)

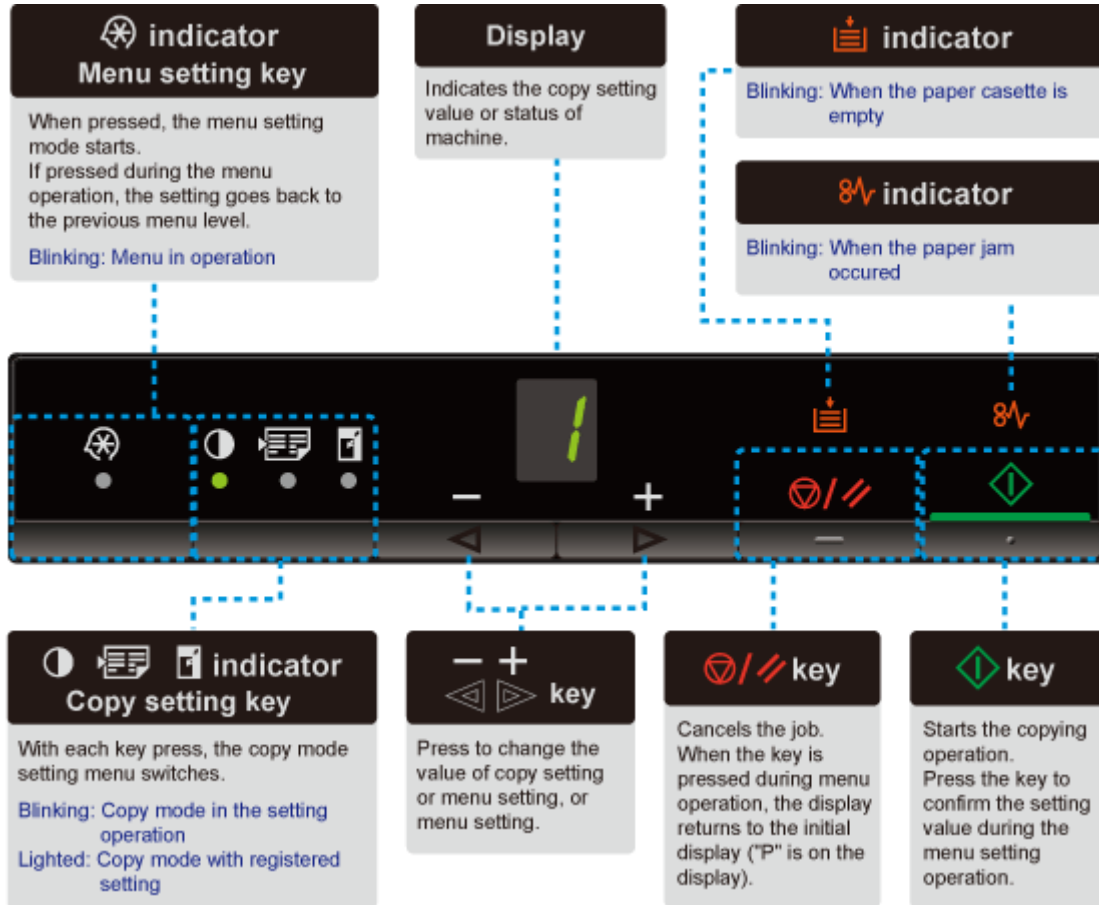
Operation Panel



NOTE

When [], [], and [] are on at a time
 A service error is occurring.
 ▶ " When a Service Error Has Occurred(P. 188) "

Viewing the Display

Copy settings, menu setting items, or setting values are displayed.

- ▶ " Setting List(P. 31) "

Also, they are displayed according to the printer status as follows.

Display	Status

Display	Status
	<ul style="list-style-type: none"> • Printing • Printing the User Data List • Cleaning • Updating the firmware • Scanning
	<p>Cancellation is processing after the [] key was pressed.</p>
	<p>Sleep state  " Energy Saving Functions (Sleep Mode)(P. 29) "</p>
	<p>The toner cover is open.</p>
	<p>A service error has occurred.  " When a Service Error Has Occurred(P. 188) "</p>
	<ul style="list-style-type: none"> • Resetting the settings • Setting value limit display <p>(For each copy setting, the display turns off when an attempt is made to exceed the upper or lower setting limits by pressing the [+] or [-] keys.)</p>

Using the Quick Reference Guide

Place this guide near the printer for effective usage.

Quick Reference Guide



Front side (operating instruction page)

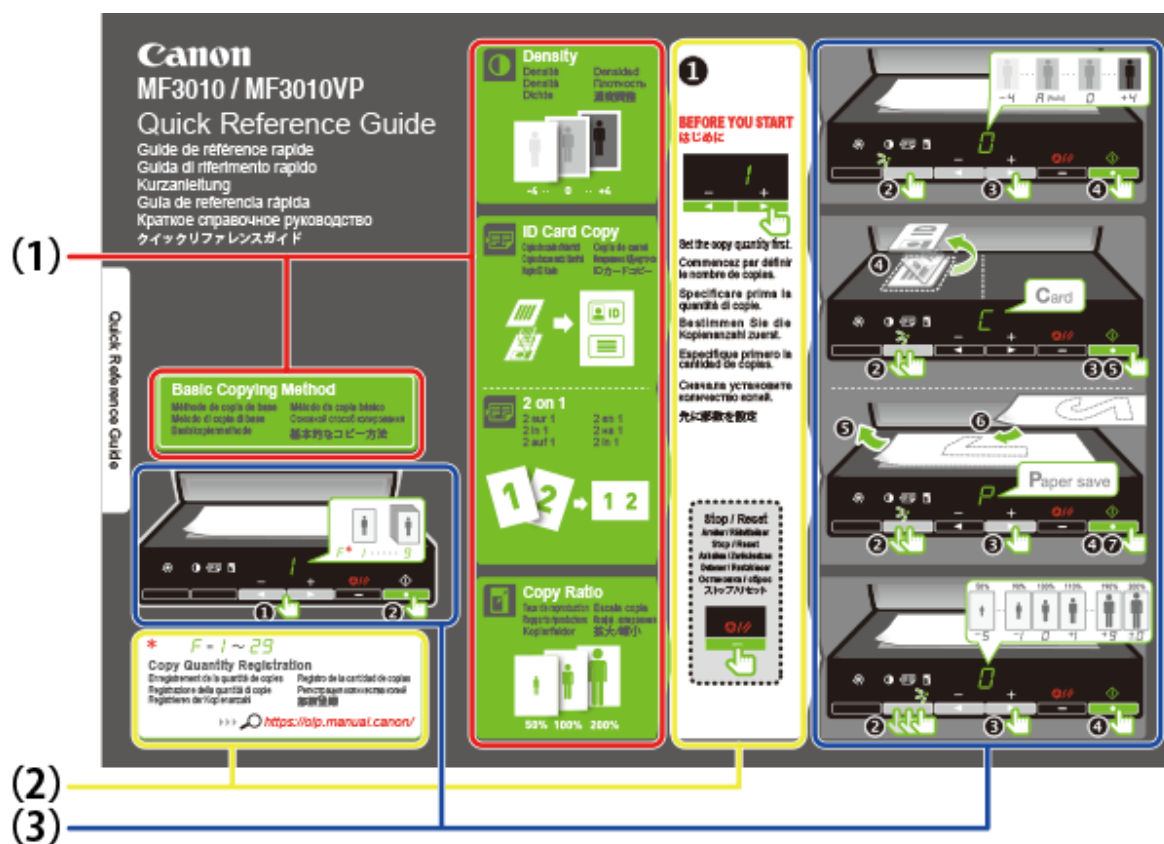

(1) Description of Various Copy

- ▶ " Basic Copy Operations(P. 76) "
- ▶ " Adjusting the Density(P. 79) "
- ▶ " Enlarging/Reducing Copy(P. 81) "
- ▶ " Copying Both Sides of Cards onto One Side (ID Card Copy)(P. 83) "
- ▶ " Copying Two Documents onto One Sheet (2 on 1 Copy)(P. 86) "

(2) Quantity Settings

If you frequently copy with the fixed quantity, see " **Registering the Quantity that You Frequently Copy (Up to Twenty-nine Copies)(P. 78) .** "

(3) Operating Procedures

Follow the procedure in numerical order.

For details on the setting values for each setting, see " **Setting List(P. 31) .** "

Reverse side (paper jams and troubleshooting page)

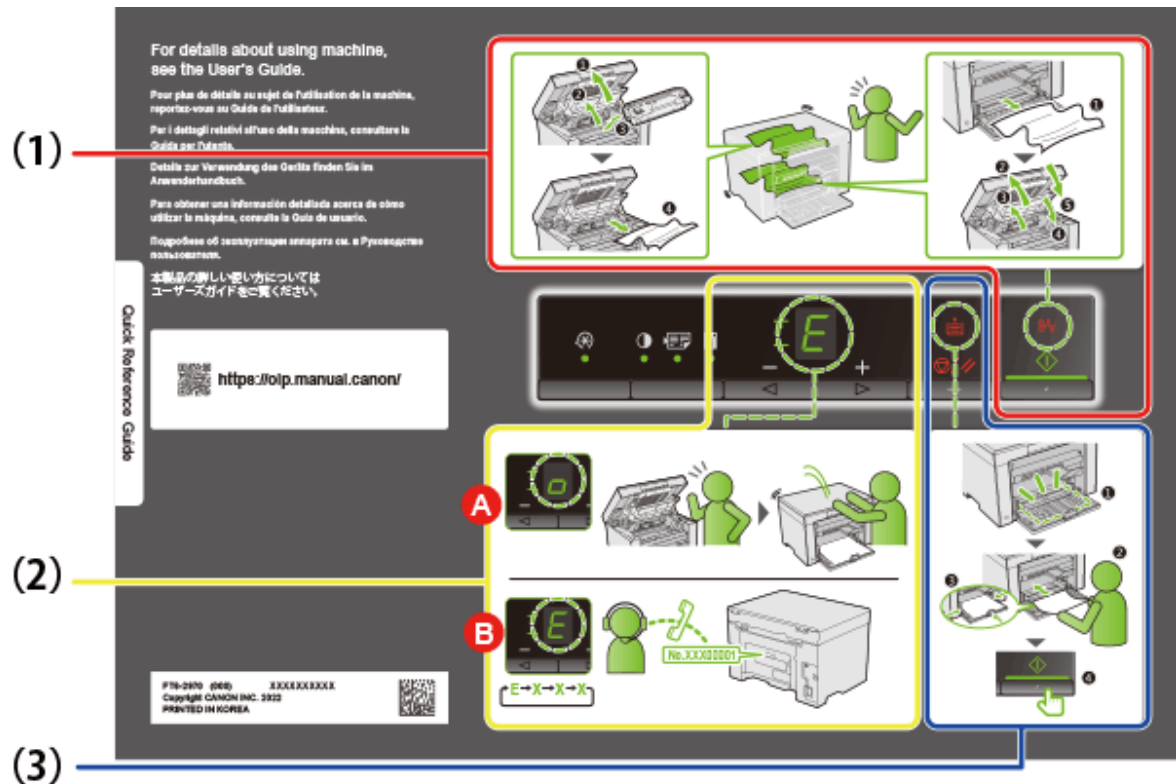

(1) If a Paper Jam Has Occurred

▶ "Removing Jammed Paper(P. 155) "

(2) A : Cover Open

▶ " How to Operate Menus(P. 30) "

B : Service Error

▶ " When a Service Error Has Occurred(P. 188) "

(3) No Paper

▶ " Loading Paper(P. 46) "

Energy Saving Functions (Sleep Mode)

85RS-00L

A function is provided that transitions the printer into an energy saving mode with low power consumption (sleep function) when it is not used for a set period of time. After 5 minutes* has elapsed during which time data is not received from the computer and there are no changes to the printer, it transitions into the sleep mode.

* You cannot change the transition time.

IMPORTANT

Power consumption when the printer is turned OFF

Even when the printer is turned OFF a tiny amount of power is still being consumed while the printer is plugged into an AC power outlet. In order to eliminate power consumption completely, unplug the power cord from the AC power outlet.

When entering the sleep mode

All indicators turn off and the display shows " - ".

Situations where the machine does not enter the sleep mode

- When the machine is in operation
- When data remains in the memory
- When an error, such as open cover, occurs in the printer
- When the machine is operating such as adjusting and cleaning
- When a paper jam occurs in the machine
- When it updates the firmware



The machine resumes from the sleep mode

- When any key on the printer's operation panel is pressed
- When a print job is sent from a computer, and printing starts
- When USB cables are connected

How to Operate Menus

This section describes how to operate or set up the menu.

To cancel operations

Press [], and then press [] (Menu setting key).

It cancels operations without saving the settings and returns to a status where normal operation is possible.

	Operating results	Operating procedures
1		<p>Press [] (Menu setting key), and then start the menu operation.</p> <p>When the menu is operating, the menu indicator blinks.</p>
2		<p>Press [] or [], select the items which you want to set. Letters showing menu items are displayed on the display.</p> <p>▶ " Setting List(P. 31) "</p>
3		<p>Press [], set the menu to be able to change the settings.</p> <p>※ To return to the previous screen, press [].</p>
4		<p>Press [] or [], change the setting values.</p>
5		<p>Press [], confirm the setting.</p>
6		<p>Press [] (Menu setting key), exit the menu operation.</p> <p>The menu indicator turns off.</p>

Setting List











85RS-00S



- ▶ Copy Setting List(P. 31)
- ▶ Menu Setting List(P. 33)

Copy Setting List

The following copy settings are available for the printer.

You can switch the copy settings by pressing [  ] (Copy setting key).

Indicator	Function name (Default value)	Setting value		Reference
		Display	Detail	
No blinking	Copy quantity setting (Default value: 1)	F	Custom copy quantity	▶ " Custom copy quantity(P. 32) "
		1	1 copy	▶ " Basic Copy Operations(P. 76) "
		2	2 copies	
		3	3 copies	
		4	4 copies	
		5	5 copies	
		6	6 copies	
		7	7 copies	
		8	8 copies	
		9	9 copies	
[] indicator	Copy density (Default value: 0)	-4		▶ " Adjusting the Density(P. 79) "
		-3		
		-2		
		-1		
		A	Auto	
		0		
		+1		
		+2		
		+3		
		+4		

Indicator	Function name (Default value)	Setting value		Reference
		Display	Detail	
[] indicator	2 on 1/ID card copy (Default value: C)	C	ID card copy	▶ " Copying Both Sides of Cards onto One Side (ID Card Copy) (P. 83) " ▶ " Copying Two Documents onto One Sheet (2 on 1 Copy)(P. 86) "
		P	2 on 1 copy	
[] indicator	Enlarging/reducing copy (Default value: 0)	-5	50%	▶ " Enlarging/Reducing Copy(P. 81) "
		-4	60%	
		-3	70%	
		-2	80%	
		-1	90%	
		0	100% (magnification)	
		+1	110%	
		+2	120%	
		+3	130%	
		+4	140%	
		+5	150%	
		+6	160%	
		+7	170%	
		+8	180%	
+9	190%			
±0	200%			

 **NOTE**

Indicator display

The display is changed for each of [], [], and [] indicators according to the status.

Blinking : The function indicator in the setting process blinks.

Lighted : After the setting is done, the corresponding indicator lights up.

Custom copy quantity

Function name (Default value)	Setting value		Reference
	Display	Detail	
Custom copy quantity (Default value: ±0)	1	1 copy	▶ " Registering the Quantity that You Frequently Copy (Up to Twenty-nine Copies)(P. 78) "
	2	2 copies	







Function name (Default value)	Setting value		Reference
	Display	Detail	
	3	3 copies	
	4	4 copies	
	5	5 copies	
	6	6 copies	
	7	7 copies	
	8	8 copies	
	9	9 copies	
	+0	10 copies	
	+1	11 copies	
	+2	12 copies	
	+3	13 copies	
	+4	14 copies	
	+5	15 copies	
	+6	16 copies	
	+7	17 copies	
	+8	18 copies	
	+9	19 copies	
	±0	20 copies	
	±1	21 copies	
	±2	22 copies	
	±3	23 copies	
	±4	24 copies	
	±5	25 copies	
	±6	26 copies	
	±7	27 copies	
	±8	28 copies	
	±9	29 copies	

Menu Setting List



The following menu settings are available for the printer.

After pressing [] (Menu setting key), press [◀] or [▶] to switch the menu settings.

▶ How to Operate Menus(P. 30)

Indicator	Function name (Default value)	Setting value		Reference
		Display	Detail	
	Paper type setting (Default value: 1)	1	Plain paper	▶ " Setting a Paper Type(P. 54) "
		+1	Plain Paper L	
		2	Heavy Paper 1	
		+2	Heavy Paper 2	
		3	Rough Paper	
		4	Envelope	
		5	Transparency	
		6	Label	
	Copy type setting (Default value: 1)	1	Speed Priority	▶ " Selecting Copy Type (Speed Priority/ Resolution Priority)(P. 88) "
		2	Resolution Priority	
	Sharpness setting (Default value: 0)	-3	—	▶ " Emphasizing the Outline of an Image (Sharpness)(P. 90) "
		-2	—	
		-1	—	
		0	—	
		+1	—	
		+2	—	
		+3	—	
	Product Extended Survey Program On/Off (Default value: 1)	0	Off	Enable or disable the Product Extended Survey Program (a program for the machine usage survey). <div style="border: 1px solid #00a0c0; padding: 10px; background-color: #e0f2f1;"> <p> IMPORTANT</p> <p>When the setup is complete</p> <p>Restart the machine to take effect the settings.</p> </div>
		1	On	
	Special Mode b (Default value: 1)	0	Off	▶ " Special Mode(P. 213) "
		1	Mode 1	
		2	Mode 2	

Basic Operation

Indicator	Function name (Default value)	Setting value		Reference
		Display	Detail	
		3	Mode 3	
		4	Mode 4	
	Special Mode c (Default value: 0)	0	Off	▶ " Special Mode(P. 213) "
		1	Mode 1	
		2	Mode 2	
		3	Mode 3	
	Special Mode d (Default value: 0)	0	Off	▶ " Special Mode(P. 213) "
		1	Mode 1	
		2	Mode 2	
	Special Mode h (Default value: 0)	0	Off	▶ " Special Mode(P. 213) "
		1	On	
	Cleaning the Fixing Unit	—	—	▶ " Cleaning the Fixing Unit(P. 198) "
	Printing the User Data List	—	—	▶ " Printing the User Data List(P. 57) "
	Upgrading Firmware	—	—	▶ " Upgrading Firmware(P. 58) "
	Initializing Menus	—	—	▶ " Initializing Menus(P. 56) "

Toner Cartridges

85RS-00U

For more information on the toner cartridges, see the following sections.

- ▶ " **About the Supplied Toner Cartridge(P. 37) "**
- ▶ " **About Replacement Toner Cartridges(P. 38) "**
- ▶ " **Handling Toner Cartridges(P. 39) "**
- ▶ " **Storing Toner Cartridges(P. 41) "**
- ▶ " **Purchasing Consumables(P. 42) "**

About the Supplied Toner Cartridge

85RS-00W

The average yield of the toner cartridge that comes with the machine is as follows.

Canon Cartridge 125 Starter	Average yield*1 : 700 sheets
-----------------------------	------------------------------

*1 The average yield is on the basis of "ISO/IEC 19752"*2 under the condition that A4 size paper is used for printing with the default print density setting.

*2 "ISO/IEC 19752" is an ISO standard method for "the determination toner cartridge yield for monochrome electrophotographic printers and multi-function devices that contain printer components." The term ISO stands for International Organization for Standardization.

The average yield of the replacement toner cartridge varies from that of the supplied toner cartridge.

About Replacement Toner Cartridges

85RS-00X

Purchase replacement toner cartridges from your local authorized Canon dealer.

Follow the instructions provided in the following sections to replace the toner cartridge. Note that you may need to replace the toner cartridge earlier than the suggested replacement interval, depending on where the machine is installed, what kinds of paper used for printing, and what types of documents that you are printing.

Canon genuine toner cartridge	Replacement Intervals
Canon Cartridge 125	Average yield*1 : 1600 sheets

*1 The average yield is on the basis of "ISO/IEC 19752"*2 under the condition that A4 size paper is used for printing with the default print density setting.

*2 "ISO/IEC 19752" is an ISO standard method for "the determination toner cartridge yield for monochrome electrophotographic printers and multi-function devices that contain printer components."

IMPORTANT

About replacement toner cartridges

For optimum print quality, using Canon genuine toner cartridges is recommended.

Model name	Supported Canon genuine toner cartridge
MF3010 / MF3010VP	Canon Cartridge 125

Handling Toner Cartridges

85RS-00Y

Note the following when handling the toner cartridge.

WARNING

Do not place the toner cartridge in fire.

This may cause toner remaining inside the cartridge to ignite and result in burns.

When cleaning up spilled or scattered toner

If you accidentally spill or scatter toner, carefully gather the toner particles together or wipe them up with a soft, damp cloth in a way that prevents inhalation.

Never use a vacuum cleaner that does not have safeguards against dust explosions to clean up spilled toner. Doing so may cause a malfunction in the vacuum cleaner, or result in a dust explosion due to static discharge.

CAUTION

If toner leaks from the toner cartridge

Be careful not to inhale the toner or allow it to come into direct contact with your skin. If the toner comes into contact with your skin, wash with soap. If the skin becomes irritated or you inhale the toner, consult a physician immediately.

When removing a toner cartridge

Make sure to remove it carefully. If not removed with care, the toner powder may scatter and come in contact with your eyes and mouth. If toner gets into your eyes or mouth, wash them immediately with cold water and consult a physician.

Keep the toner cartridge away from small children.

If the toner or other parts are ingested, consult a physician immediately.

Do not disassemble the toner cartridge.

The toner may scatter and get into your eyes or mouth. If toner gets into your eyes or mouth, wash them immediately with cold water and consult a physician.

IMPORTANT

Handling toner cartridges

- Keep the toner cartridge away from computer screens, disk drives, and floppy disks. They may be damaged by magnet which is in inside of the toner cartridge.
- Avoid locations subject to high temperature, high humidity, or rapid changes in temperature.
- Do not expose the toner cartridge to direct sunlight or bright light for more than five minutes.
- Store the toner cartridge in its protective bag. Do not open the bag until you are ready to install the toner cartridge in the machine.
- Keep the protective bag for the toner cartridge. They are required when transporting the machine such as during relocation.
- Do not store the toner cartridge in a salty atmosphere or where there are corrosive gases such as from aerosol sprays.
- Do not remove the toner cartridge from the machine unnecessarily.
- Print quality may deteriorate if the drum surface is exposed to light or is damaged.
- Always hold the toner cartridge by its handle to avoid touching the drum.

- Do not place the toner cartridge in an upright or an upside down position. If the toner is kept upright or upside down, the toner will solidify and may not return to its original condition even if it is shaken.
- When disposing of a used toner cartridge, place the toner container into its protective bag to prevent the toner from scattering, and then dispose of the toner cartridge according to local regulations.

Be careful of counterfeit toner cartridges.

Please be aware that there are counterfeit Canon toner cartridges in the marketplace.

Use of counterfeit toner cartridge may result in poor print quality or machine performance.

Canon is not responsible for any malfunction, accident or damage caused by the use of counterfeit toner cartridge.

For more information, see <http://www.canon.com/counterfeit>.

Storing Toner Cartridges

85RS-010

Be aware of the following points when storing a new toner cartridge or handling the toner cartridge that was taken out of the machine for maintenance or relocating the machine somewhere.

IMPORTANT

Precautions when storing toner cartridges

To use toner cartridges in a safe and trouble-free manner, store them in a place that fulfills the following conditions.

- Do not store toner cartridges in a location exposed to direct sunlight.
- Do not store toner cartridges in a location subject to high temperature or humidity or in a location with dramatic changes in temperature or humidity.
 - Storage temperature range: 0 to 35°C (32 to 95°F)
 - Storage humidity range: 35 to 85% RH (no condensation)
- Do not store toner cartridges in a place where corrosive gases, such as ammonia, are generated, or where a considerable amount of salt is contained in the air, or where there is a lot of dust.
- Keep toner cartridges out of the reach of small children.
- Keep toner cartridges away from products that may be damaged by magnetism, such as a floppy disk or disk drive.

Store toner cartridges in the same orientation as when they are installed in the machine.

Do not store toner cartridges vertically or upside-down.

When removing the toner cartridge which is being used from the machine

Immediately place the removed toner cartridge into the original protective bag or wrap it with a thick cloth.

About a new toner cartridge

Do not take a new toner cartridge out of the protective bag until it is ready to be used.

NOTE

About condensation

Even within the storable humidity range, water droplets may develop both inside and outside toner cartridges due to the difference in temperature. The formation of water droplets is called condensation. Condensation will adversely affect the quality of toner cartridges.

Purchasing Consumables

85RS-011

To purchase replacement toner cartridges, contact your local authorized Canon dealer.

To find a dealer near, contact the Canon help line.

Placing Documents

85RS-012

This section describes how to place documents on the platen glass.

Before placing the documents on the platen glass, see " **Attention (Placing Documents)(P. 45)** ."

1 Open the platen glass.



2 Place your document face down.



3 Align the document with the appropriate paper size marks.

If the document does not match any of the paper size marks, align the center of your document with the arrow mark.

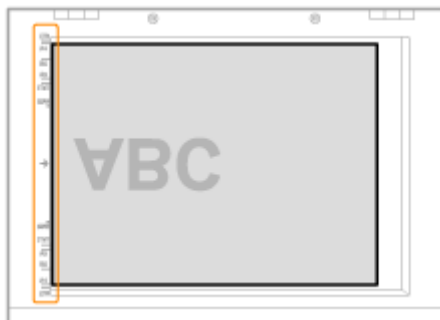

4 Close the platen glass gently.

The machine is ready to scan or copy the document.

When scanning or copying is complete, remove the document from the platen glass.

Attention (Placing Documents)

85RS-013

 **CAUTION**

Precautions when closing the platen glass

- Be careful not to get your fingers caught. This may cause personal injury.
- Do not press down the feeder forcefully. This may damage the platen glass and cause personal injury.

Loading Paper

85RS-014

This section describes how to load paper in the paper cassette.

 **NOTE****To set your choice of paper type**

By default, the paper type is set to Plain paper (60 to 90 g/m² (16 to 24 lb Bond)). To use a different paper type, you need to change the default settings.

▶ " **Setting a Paper Type(P. 54)** "

▶ " **In the Paper Cassette(P. 47)** "

In the Paper Cassette

85RS-015

Before loading paper in the paper cassette, see " **Attention (Loading Paper)(P. 50)** ."

- 1 Spread the paper guides a little wider than the paper size.

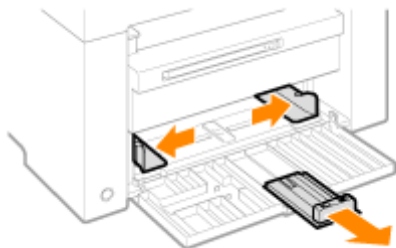

- 2 Gently load the paper stack into the paper cassette with the print side face up, until the edge of the paper stack meets the back of the paper cassette.

- " Paper Loading Capacity(P. 51) "
- " Paper Loading Orientation(P. 52) "

Make sure that the paper stack does not exceed the load limit guides (A).

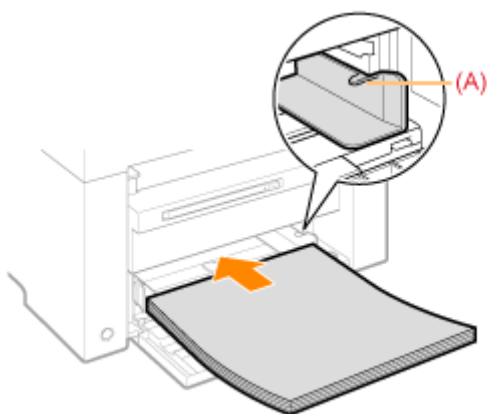

When loading envelopes

- (1) Fold the envelope flap.

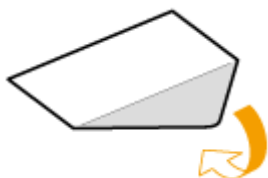

- (2) Place the stack of envelopes on a flat surface, flatten them to release any remaining air, and make sure that the edges are pressed tightly.



(3) Loosen any stiff corners of the envelopes and flatten curls as shown in the figure.

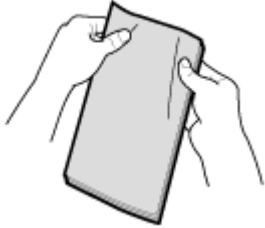

(4) Align the edges of the envelopes on a flat surface.

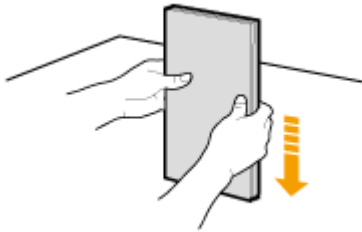

(5) Gently load the envelopes into the paper cassette with the print side face up, until the edge of the envelope stack meets the back of the paper cassette.

3 Adjust the paper guides to the paper width without space.

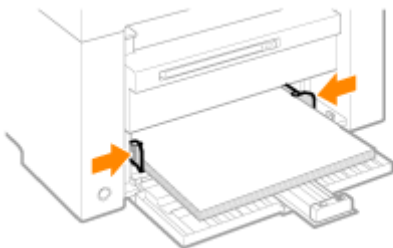

IMPORTANT

Adjust the paper guides to the paper width without space.

If the paper guides are too loose or too tight, this may result in misfeeds or paper jams.

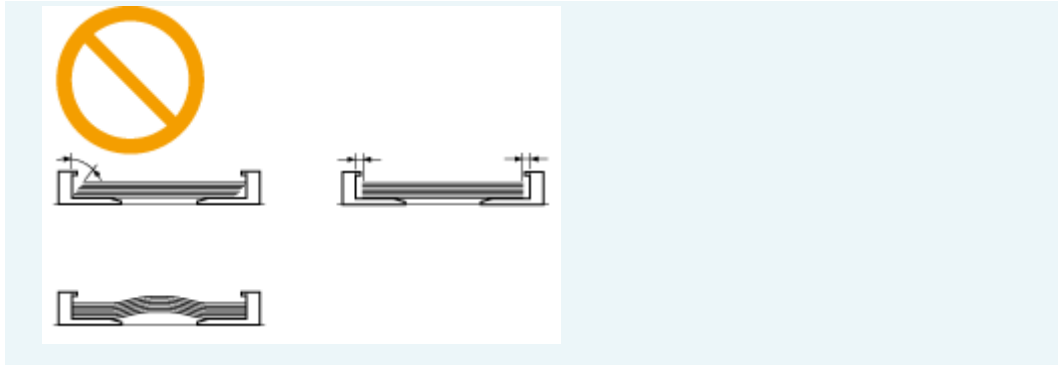

4 Adjust the rear paper guide to the paper length without space.

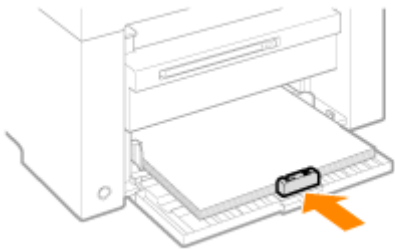

5 Pull out the output tray extension and lift the paper stopper.

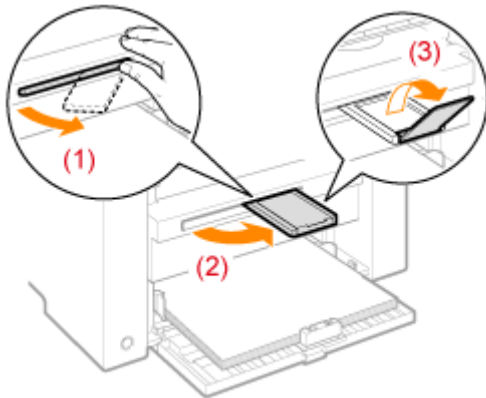

6 Set the paper type loaded in the tray.

▶ " Setting a Paper Type(P. 54) "

Attention (Loading Paper)

CAUTION

Adjust the paper guides to the paper width without space.

Handle paper carefully not to cut your hands with the edges of the paper.

IMPORTANT

Be sure to align the paper guides with the width of the paper.

- If the paper guides are too loose or too tight, this may result in misfeeds or paper jams.
- Printouts may be askew depending on the printing environment. Properly load paper to avoid this.

Be sure to adjust paper sizes to the documents.

Adjust the size of the paper loaded in the paper cassette to the documents.

When the paper which is loaded in the paper cassette is smaller than the documents, the output may be dirty with the toner that is placed outside of the paper.

When using paper that has been poorly cut

If you use paper that has been poorly cut, multiple sheets of paper may be fed at once. In this case, fan the paper thoroughly, and then align the edges of the stack properly on a hard, flat surface.

Do not exceed the load limit mark when loading paper.

Make sure that the paper stack does not exceed the line of the load limit mark. If the paper stack exceeds the load limit mark lines, this may result in misfeeds.

When printing on envelopes

Load envelopes with the front side (non-glued side) facing up. You cannot print on the reverse side of envelopes.

Also, be sure to close the flap before loading envelopes.

NOTE

For more information on supported paper types

 "Supported Paper Types(P. 70) "

Abbreviations on the paper guides inside the paper cassette

Paper size	Paper guide
Legal	LGL
Letter	LTR
Executive	EXEC

Paper Loading Capacity

85RS-017

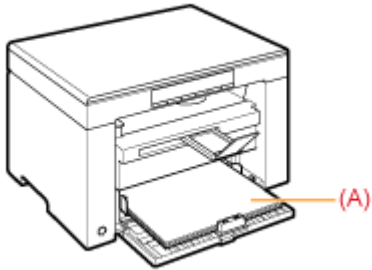

Paper type	Paper cassette
Plain paper (Ex. 80 g/m ² (21 lb Bond))	Approx. 150 sheets
Heavy paper (Ex. 91 g/m ² (24 lb Bond))	Approx. 100 sheets
Heavy paper (Ex. 128 g/m ² (50 lb Cover))	Approx. 60 sheets
Transparency	Approx. 100 sheets
Label	Approx. 50 sheets
Envelope	Approx. 10 envelopes

Paper Loading Orientation

85RS-018

When printing on paper that has a preprinted letterhead or logo

Load paper as shown below.

(➡ : Feeding direction)

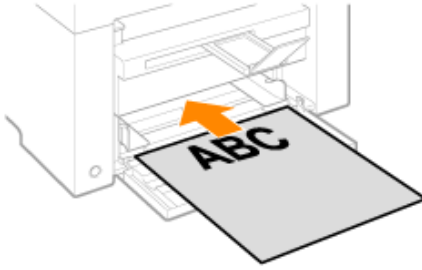
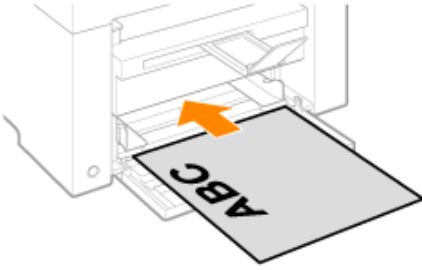
	Portrait orientation	Landscape orientation
1-sided printing	 <p>(with the printed side face up)</p>	 <p>(with the printed side face up)</p>

Printing on envelopes

Load envelopes with the front side (non-glued side) face up as shown below.

(➡ : Feeding direction)

Envelope No.10, DL, ISO-C5

Load the envelopes with the flap toward the left side of the paper cassette when viewed from the front.

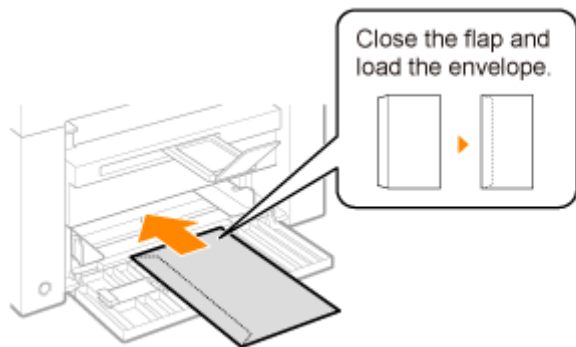





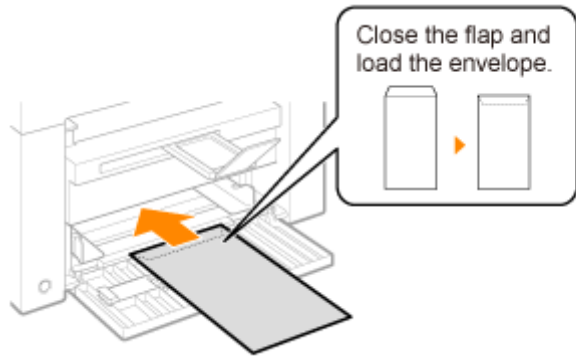



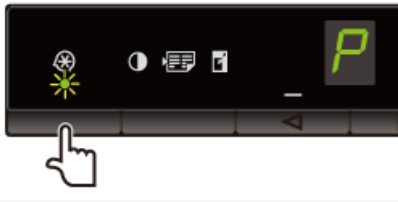

Envelope ISO-B5

Load the envelopes with the flap toward the back of the paper cassette when viewed from the front.

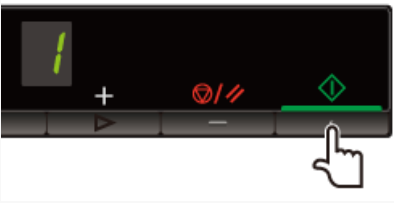

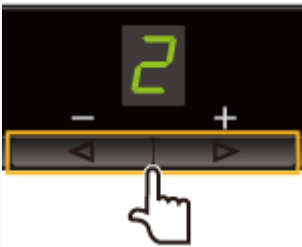
Setting a Paper Type

After loading paper in the cassette, change the menu settings according to the paper type.

	Operating results	Operating procedures																		
1		Press [] (Menu setting key), and then start the menu operation. When the menu is operating, the menu indicator blinks.																		
2		Press [] or [] until "P" is displayed.																		
3		Press [], and set the menu to be able to change the settings.																		
4		Press [] or [] to change the setting values. The display and the paper types are matched as follows.																		
		<table border="1"> <thead> <tr> <th>Display</th> <th>Paper type</th> </tr> </thead> <tbody> <tr> <td>1</td> <td>Plain paper</td> </tr> <tr> <td>+1</td> <td>Plain paper L</td> </tr> <tr> <td>2</td> <td>Heavy paper 1</td> </tr> <tr> <td>+2</td> <td>Heavy paper 2</td> </tr> <tr> <td>3</td> <td>Rough paper</td> </tr> <tr> <td>4</td> <td>Envelopes</td> </tr> <tr> <td>5</td> <td>Transparencies</td> </tr> <tr> <td>6</td> <td>Labels</td> </tr> </tbody> </table>	Display	Paper type	1	Plain paper	+1	Plain paper L	2	Heavy paper 1	+2	Heavy paper 2	3	Rough paper	4	Envelopes	5	Transparencies	6	Labels
Display	Paper type																			
1	Plain paper																			
+1	Plain paper L																			
2	Heavy paper 1																			
+2	Heavy paper 2																			
3	Rough paper																			
4	Envelopes																			
5	Transparencies																			
6	Labels																			
		▶ " Supported Paper Types(P. 70) "																		
5		Press [] to confirm the setting.																		

6











Press [] (Menu setting key) to exit the menu operation.
The menu indicator turns off.

Initializing Menus

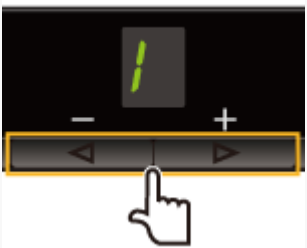
85RS-01A

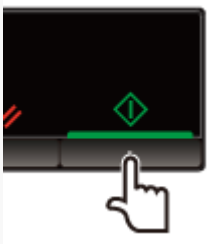
You can reset the following settings to the default value.

- Paper type settings
- Registering the quantity
- Setting copy type
- Setting sharpness
- Setting special mode
- The quantity registered in "F"









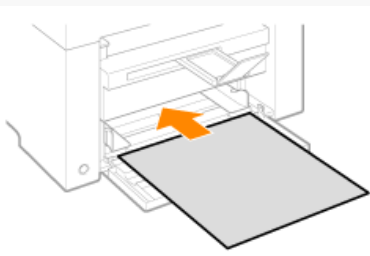
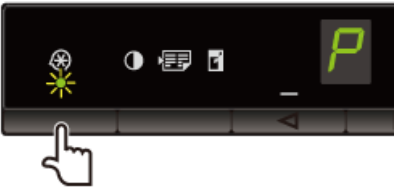

	Operating results	Operating procedures
1		Press [] (Menu setting key), and then start the menu operation. When the menu is operating, the menu indicator blinks.
2		Press [] or [] until "I" is displayed.
3		Press [] to perform initialization.
4		Press [] (Menu setting key) to exit the menu operation. The menu indicator turns off.

Printing the User Data List

85RS-01C

Print the user data list.
The following items are printed.

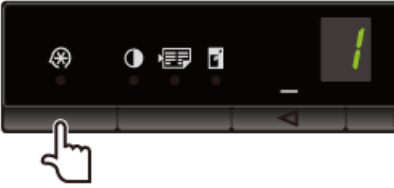
- Controller ROM version
- Country/region code
- No. of printed pages/No. of scanned pages
- Registering the quantity
- Paper type settings
- Setting copy type
- Setting sharpness
- Setting special mode

	Operating results	Operating procedures
1		Load A4 or Letter size paper. ▶ " In the Paper Cassette(P. 47) "
2		Press [] (Menu setting key), and then start the menu operation. When the menu is operating, the menu indicator blinks.
3		Press [] or [] until "U" is displayed.
4		Press [] to print the user data list. 
5		Press [] (Menu setting key) to exit the menu operation. The menu indicator turns off.







Upgrading Firmware

85RS-01E

This section describes the procedure to upgrade the printer firmware.
For details on the procedure for upgrading the firmware, see the manual supplied with the firmware.

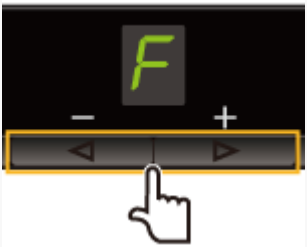
 **IMPORTANT**

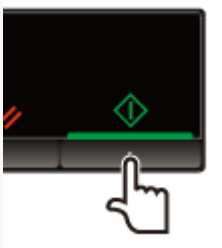
Performing only when it is necessary
Upgrade the printer firmware only when it is necessary.

	Operating results	Operating procedures
1		Press [] (Menu setting key), and then start the menu operation. When the menu is operating, the menu indicator blinks.
2		Press [] or [] until "F" is displayed.
3		When [] is pressed, the update mode for the firmware is displayed as shown below. 

Locating the Serial Number

85RS-01F

The serial number (a character string of three letters and a 5-digit number) is written on the rating label on the rear side of the machine.

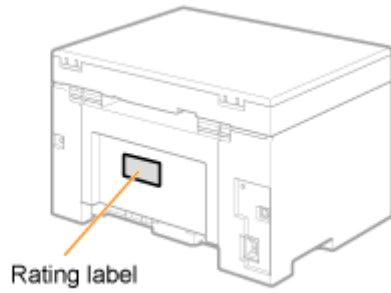

Specifications

Specifications	61
Machine Specifications	62
Copy Specifications	63
Printer Specification	64
Scanner Specifications	65
Document Type	66
Supported Document Types	67
Scan Area	68
Paper	69
Supported Paper Types	70
Printable Area	73

Specifications

85RS-01H

Note that specifications are subject to change without notice.

Machine Specifications

85RS-01J

Machine Specifications	
Type	Personal Desktop
Power Supply	110 to 127 V, 50/60 Hz (Power requirements can vary by country. They depend on where you purchased the product.)
Power Consumption	Maximum: 900 W or less Average consumption during standby mode: Approx. 2.3 W Average consumption during sleep mode: Approx. 1.2 W When the main power switch is turned OFF: 0.5 W or less
Warm-up Time	10 second or less* (Temperature: 20 °C (68 °F), humidity: 65% RH ; from when the printer is turned ON to when "1" is displayed) * Warm-up time may vary depending on the conditions of the installation environment.
Weight	Main unit (the toner cartridge included): Approx. 8.2 kg (18.1 lb)
Dimensions (W x L x H)	<ul style="list-style-type: none"> • With the paper cassette closed 372 mm x 276 mm x 254 mm (14 5/8" x 10 7/8" x 10") • With the paper cassette open 372 mm x 371 mm x 254 mm (14 5/8" x 14 5/8" x 10")
Installation Space (W x L x H)	572 mm x 632 mm x 608 mm (22 1/2" x 24 7/8" x 24")
Environmental Conditions	Temperature: 10 to 30°C (50 to 86°F) Humidity: 20% to 80% RH (no condensation)
Acceptable Documents	▶ " Supported Document Types(P. 67) "
Acceptable Paper Stock	▶ " Supported Paper Types(P. 70) "
Printable Area	▶ " Printable Area(P. 73) "
Scan Area	▶ " Scan Area(P. 68) "

Copy Specifications

85RS-01K

Copy Specifications	
Scan Resolution	<ul style="list-style-type: none"> • Speed priority: 600 dpi x 400 dpi • Resolution priority: 600 dpi x 600 dpi
Output Resolution	<ul style="list-style-type: none"> • Speed priority: 600 dpi x 400 dpi • Resolution priority: 600 dpi x 600 dpi
Copy Ratio	<ul style="list-style-type: none"> • Direct 1:1 ± 1.0 % • Zoom 0.50 to 2.00, 10 % increments
Copy Speed (Letter Plain Direct)*	19 cpm
Continuous Copying Capacity	Maximum 29 copies
First Copy Time (Letter)	11.8 seconds or less

* The copy speed on Letter size plain paper on one-side printing is measured during continuous copying. Copy speeds vary depending on the output resolution, the paper type and size, and the paper feeding direction. Copy speeds on smaller paper sizes may be slower. Plus, the machine may experience downtime or decrease the copy speed in the middle of a continuous copy run to adjust the temperature inside the machine or maintain the optimal print quality.

Printer Specification

85RS-01L

Printer Specification	
Printing Method	Indirect electrostatic system (On-demand fixing)
Paper Capacity	Approx. 150 sheets (60 to 80 g/m ² (16 to 21 lb Bond))
Output Tray Capacity (a fresh stack of Letter size paper)	Approx. 100 sheets (60 to 80 g/m ² (16 to 21 lb Bond))* ¹
Print Speed (Letter Plain Direct)* ²	19 ppm
Output Resolution	<ul style="list-style-type: none"> • Speed priority: 600 dpi x 400 dpi • Resolution priority: 1200 dpi equivalent x 600 dpi
Gradation	256 gradations
Toner Cartridges	 Toner Cartridges(P. 36) "
First Print Time (Letter)	7.7 seconds or less * ³

*¹ The actual paper capacity varies depending on the installation environment and paper type used.

*² The print speed on Letter size plain paper on one-side printing is measured during continuous printing. Print speeds vary depending on the output resolution, the paper type and size, and the paper feeding direction. Print speeds on smaller paper sizes may be slower. Plus, the machine may experience downtime or decrease the print speed in the middle of a continuous print run to adjust the temperature inside the machine or maintain the optimal print quality.

*³ May vary depending on the output environment.

Scanner Specifications

85RS-01R

Scanner Specifications	
Type	Color scanner
Maximum Scan Size	up to 216 mm x 297.0 mm (8 1/2" x 11 5/8")
Scan Resolution	<ul style="list-style-type: none"> • Optical resolution up to 600 x 600 dpi • Software interpolation resolution 9600 dpi x 9600 dpi
Scan Speed (Letter, 300 x 300 dpi)*	Color: 8 seconds/sheet Grayscale: 3 seconds/sheet
Host Interface	<ul style="list-style-type: none"> • Hi-Speed USB • USB
Operating System	Windows 7/8/10
Driver	<ul style="list-style-type: none"> • TWAIN • WIA 2.0 (Windows 7/8/10)

* Scan speeds were only measured.

Document Type

85RS-01S

- ▶ " Supported Document Types(P. 67) "
- ▶ " Scan Area(P. 68) "

Supported Document Types

85RS-01U

Type	<ul style="list-style-type: none"> • Plain paper • Heavy paper • Photograph • Small documents (for example, index cards) • Special types of paper (for example, tracing paper, transparencies, etc.)*¹ • Booklet (thickness not specified)
Size (W x L)	Maximum 216 mm x 297 mm (8 1/2" x 11 3/4")
Weight	Maximum 2 kg (4.4 lb)
Paper Capacity	1 sheet

*¹ To copy transparent documents (for example, tracing paper or transparencies), make sure to place the documents face down on the platen glass and cover them with plain white paper.

IMPORTANT

To place your document

Make sure any glue, ink, or correction fluid on the document is completely dry before placing it on the platen glass or into the feeder.

Scan Area

85RS-01W

Make sure that your scan area fits within the shaded area, as shown in the illustrations on the following page.

- ※ Note that the margins indicated in the illustrations are for your reference. Actual margins can vary.
- ※ Place the document face down.

Copy

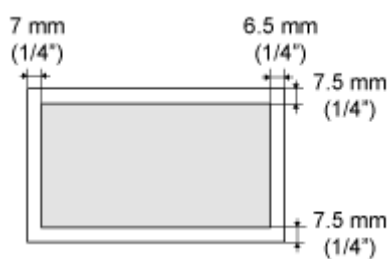

Scan

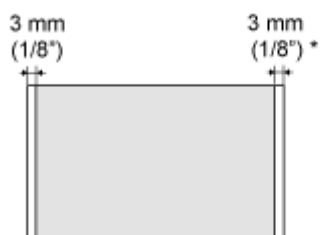

* A4 size paper only

Paper

85RS-01X

- ▶ " Supported Paper Types(P. 70) "
- ▶ " Printable Area(P. 73) "

Supported Paper Types

85RS-01Y

Paper Size

The following paper sizes are supported.

: Supported

Paper Size	Paper Source
	Paper cassette
A4 (210 mm x 297 mm (8 1/4" x 11 3/4"))	<input type="radio"/>
B5 (182 mm x 257 mm (7 1/8" x 10 1/8"))	<input type="radio"/>
A5 (148 mm x 210 mm (5 7/8" x 8 1/4"))	<input type="radio"/>
Legal (216 mm x 356 mm (8 1/2" x 14"))	<input type="radio"/>
Letter (216 mm x 279 mm (8 1/2" x 11"))	<input type="radio"/>
Statement (140 mm x 216 mm (5 1/2" x 8 1/2"))	<input type="radio"/>
Executive (184 mm x 267 mm (7 1/4" x 10 1/2"))	<input type="radio"/>
Officio (216 mm x 318 mm (8 1/2" x 12 1/2"))	<input type="radio"/>
B-officio (216 mm x 355 mm (8 1/2" x 14"))	<input type="radio"/>
M-officio (216 mm x 341 mm (8 1/2" x 13 3/8"))	<input type="radio"/>
Government - Letter (203 mm x 267 mm (8" x 10 1/2"))	<input type="radio"/>
Government - Legal (203 mm x 330 mm (8" x 13"))	<input type="radio"/>
Foolscap (216 mm x 330 mm (8 1/2" x 13"))	<input type="radio"/>
A-foolscap (206 mm x 338 mm (8 1/8" x 13 3/8"))	<input type="radio"/>
Envelope COM10 (104.7 mm x 241.3 mm (4 1/8" x 9 1/2"))* ¹	<input type="radio"/>
Envelope Monarch (98.4 mm x 190.5 mm (3 7/8" x 7 1/2"))* ¹	<input type="radio"/>
Envelope C5 (162 mm x 229 mm (6 3/8" x 9"))* ¹	<input type="radio"/>
Envelope B5 (176 mm x 250 mm (6 7/8" x 9 7/8"))* ¹	<input type="radio"/>
Envelope DL (110 mm x 220 mm (4 3/8" x 8 5/8"))* ¹	<input type="radio"/>

Specifications

Paper Size	Paper Source
	Paper cassette
Custom Paper Size* ²	

*1 Make sure the flap is folded.

*2 You can set custom paper size of Width: 127 to 356 mm (5" to 14") and Length: 76.2 to 216 mm (3" to 8 1/2").

Specify the paper size in portrait orientation (Height \geq Width) and within the range that can be defined.



Using chlorine-free paper

Chlorine-free paper can be used with this machine.

Type

The following paper types are supported.

Paper Type		Printer Driver Setting	Paper Capacity
Plain paper	60 to 80 g/m ² (16 to 21 lb Bond)	[Plain Paper]	150 sheets
	80 to 90 g/m ² (21 to 24 lb Bond)	[Plain Paper L]	120 sheets
Heavy paper	90 to 105 g/m ² (24 to 28 lb Bond)	[Heavy Paper 1]	100 sheets
	105 to 163 g/m ² (28 lb Bond to 60 lb Cover)	[Heavy Paper 2]* ¹	60 sheets
Rough paper	60 to 163 g/m ² (16 lb Bond to 60 lb Cover)	[Rough Paper]	100 sheets
Transparency* ²		[Transparency]	100 sheets
Label		[Labels]	50 sheets
Index Card		[Index Card]	Not available
Envelope		[Envelope]	10 sheets

*1 If you want to improve the fixation when printed with [Heavy Paper 1] selected, select [Heavy Paper 2].

*2 Use only the types designed for laser printers.

To prevent paper jams, do not use the following paper types.

- Wrinkled or creased paper
- Curled or rolled paper
- Torn paper
- Damp paper
- Very thin paper
- Paper printed by a thermal transfer printer (Do not copy on the reverse side.)

The following paper types do not print well:

- Highly textured paper

- Very smooth paper
- Glossy paper

Make sure that the paper is free of dust, lint, and oil stains.

Make sure to test print before purchasing large quantities of copy paper.

Keep the paper wrapped in its original package (unopened or opened) and stored in a cool, dry place until ready to use. Make sure to keep it on a flat surface.

Store paper stacks in a place where temperatures are somewhere between 18 to 24°C (64.4 to 75.2°F) and humidity is somewhere between 40 % to 60 % RH.

 **CAUTION**

To print on damp paper

The following problems may occur.

- Steam is emitted from the machine's output area.
- Water droplets form on the back side of the operation panel and in the output area.

Moisture evaporates from damp paper due to the heat generated inside the fixing unit (it is most likely to occur at low room temperatures). This is not a malfunction, but you can prevent this by using a stack of new unopened paper.

Should you smell something burning, immediately turn OFF the machine, unplug the power plug from the AC power outlet, and contact your local authorized Canon dealer or the Canon help line. Continued use may lead to a fire or electrical shock.

Printable Area

85RS-020

The shaded area in the illustration on the following page represents the printable area (A4 size paper).

Note that the margins indicated in the illustration are for your reference. Actual margins can vary.

※ When an envelope is printed, the margin is 10 mm (3/8") on top, bottom, right, and left.

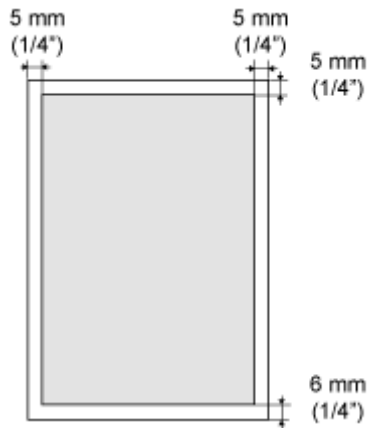

Copy

Copy	75
Basic Copy Operations	76
Registering the Quantity that You Frequently Copy (Up to Twenty-nine Copies)	78
Adjusting the Density	79
Enlarging/Reducing Copy	81
Copying Both Sides of Cards onto One Side (ID Card Copy)	83
Copying Two Documents onto One Sheet (2 on 1 Copy)	86
Selecting Copy Type (Speed Priority/Resolution Priority)	88
Emphasizing the Outline of an Image (Sharpness)	90

Copy

85RS-021

This chapter describes how to use the copy functions.

Using the copy functions for the first time	See " Basic Copy Operations(P. 76) . "
Using various copy functions	See the following sections. <ul style="list-style-type: none">• " Copying Both Sides of Cards onto One Side (ID Card Copy)(P. 83) "• " Copying Two Documents onto One Sheet (2 on 1 Copy)(P. 86) "• " Selecting Copy Type (Speed Priority/Resolution Priority)(P. 88) "• " Emphasizing the Outline of an Image (Sharpness)(P. 90) "





Basic Copy Operations

85RS-022









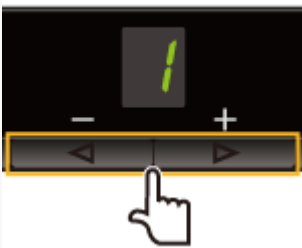

For details on each key function for the operation panel and the display, see the following items.







▶ " Operation Panel and Display(P. 25) "

<Before copying>

If the [  ] indicator is on or other than [1] is displayed, the previous copy settings are remained. In this case, press [] to reset the copy settings.

※ If a key is not pressed for 2 minutes, the copy settings will be automatically reset.

	Operating results	Operating procedures
1		<p>Place the document.</p> <p>▶ " Placing Documents(P. 43) "</p> <p>▶ " Supported Paper Types(P. 70) "</p>
2		<p>Press [◀] or [▶] to specify the copy quantity. Specify the copy quantity first.</p> <p>You can set the copy quantity to "F" or "1" to "9."</p> <p>You can register the custom copy quantity (user-defined number up to twenty-nine copies) to "F." The pre-defined settings comes useful if you copy a certain number of quantity, or want to copy more than 10 sets.</p> <p>▶ " Registering the Quantity that You Frequently Copy (Up to Twenty-nine Copies)(P. 78) "</p>
3		<p>Press [] (Menu setting key) to specify the following settings if necessary.</p> <p>▶ " Selecting Copy Type (Speed Priority/Resolution Priority)(P. 88) "</p> <p>▶ " Emphasizing the Outline of an Image (Sharpness) (P. 90) "</p>
4		<p>Press [  ] (Copy setting key) to specify the following settings if necessary.</p> <p>The indicator is moved to [] → [] → [] each time you press the key.</p> <p>[] : ▶ " Adjusting the Density(P. 79) "</p>

		<div data-bbox="742 112 1449 763" style="background-color: #e0f2e0; padding: 10px;"> <p>[] :</p> <p>[] :</p> </div> <div data-bbox="1209 120 1342 734" style="font-size: small;"> <p>▶ " Copying Both Sides of Cards onto One Side (ID Card Copy) (P. 83) "</p> <p>▶ " Copying Two Documents onto One Sheet (2 on 1 Copy) (P. 86) "</p> <p>▶ " Enlarging/Reducing Copy(P. 81) "</p> </div> <p data-bbox="703 801 1453 904"> You cannot set [] (2 on 1/ID card cop) and [] (enlarge/reduce copies) at a time. ※ ▶ " Operation Panel and Display(P. 25) " </p>
<p style="font-size: 2em; color: red;">5</p>		<p>Press [] to start copying.</p> <p><Canceling copy jobs> Press [].</p>

 **IMPORTANT**

When copying a document without margins
 Images may be partially cut off on the output.
 ▶ " Scan Area(P. 68) "

Registering the Quantity that You Frequently Copy (Up to Twenty-nine Copies)













85RS-023

You can call a registered quantity using one-touch button to copy by registering a copy quantity. You can register the copy quantity up to twenty-nine copies.

▶ " Basic Copy Operations(P. 76) "

<Before registering the copy quantity>

Register the quantity after pressing [] to reset the settings.

	<p>Press and hold [◀] more than 5 seconds. After this, "F" is on, and [  ] (Copy setting key) blinks.</p> 								
									
	<p>Press [◀] or [▶] to display the quantity that you want to register.</p> <table border="1" data-bbox="571 1124 1232 1243"> <tr> <td>The quantity that you want to register:</td> <td>1 to 9</td> <td>10 to 19</td> <td>20 to 29</td> </tr> <tr> <td>Display:</td> <td>1 to 9</td> <td>+0 to +9</td> <td>±0 to ±9</td> </tr> </table> <p>▶ " Setting List(P. 31) "</p>	The quantity that you want to register:	1 to 9	10 to 19	20 to 29	Display:	1 to 9	+0 to +9	±0 to ±9
The quantity that you want to register:	1 to 9	10 to 19	20 to 29						
Display:	1 to 9	+0 to +9	±0 to ±9						
									
	<p>Press [  ] (Copy setting key) to confirm the setting.</p> <p>→ The specified quantity is displayed after "F."</p> <p>Example) When the quantity is set to twenty-five copies</p> 								

Saving the registered quantity







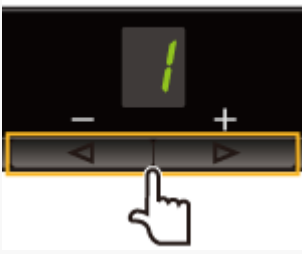

The registered quantity is saved even if you press [] or turn the power OFF.

To display "F"

When [◀] is pressed, "F" is displayed.

Adjusting the Density

85RS-024

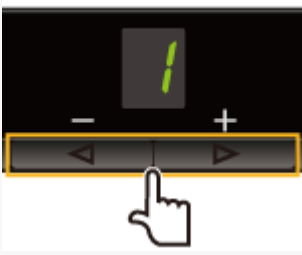
	Operating results	Operating procedures																					
1		<p>Place the document.</p> <ul style="list-style-type: none"> ▶ " Placing Documents(P. 43) " ▶ " Supported Paper Types(P. 70) " 																					
2		<p>Press [◀] or [▶] to specify the copy quantity. Specify the copy quantity first. You can set the copy quantity to "F" or "1" to "9."</p> <div style="border: 1px solid #ccc; padding: 5px; background-color: #f0f0f0;"> <p>You can register the custom copy quantity (user-defined number up to twenty-nine copies) to "F." The pre-defined settings comes useful if you copy a certain number of quantity, or want to copy more than 10 sets.</p> <ul style="list-style-type: none"> ▶ " Registering the Quantity that You Frequently Copy (Up to Twenty-nine Copies)(P. 78) " </div>																					
3		<p>Press [] (Menu setting key) to specify the following settings if necessary.</p> <div style="border: 1px solid #ccc; padding: 5px; background-color: #f0f0f0;"> <ul style="list-style-type: none"> ▶ " Selecting Copy Type (Speed Priority/Resolution Priority)(P. 88) " ▶ " Emphasizing the Outline of an Image (Sharpness) (P. 90) " </div>																					
4		<p>Press [  ] (Copy setting key) to blink the [] indicator.</p>																					
5		<p>Adjust the density.</p> <table style="width: 100%; text-align: center;"> <tr> <td>-4</td> <td>to</td> <td>A</td> <td>to</td> <td>0</td> <td>to</td> <td>+4</td> </tr> <tr> <td>[◀]</td> <td></td> <td></td> <td></td> <td>Default</td> <td></td> <td>[▶]</td> </tr> <tr> <td>(Lighter)</td> <td></td> <td></td> <td></td> <td>value</td> <td></td> <td>(Darker)</td> </tr> </table> <ul style="list-style-type: none"> ※ When setting the value to [A], the density is automatically set according to the documents. ※ [A] is the only suitable mode for text documents. <p>▶ " Setting List(P. 31) "</p>	-4	to	A	to	0	to	+4	[◀]				Default		[▶]	(Lighter)				value		(Darker)
-4	to	A	to	0	to	+4																	
[◀]				Default		[▶]																	
(Lighter)				value		(Darker)																	

6

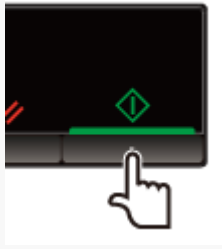

Press [] to start copying.





<Canceling copy jobs>



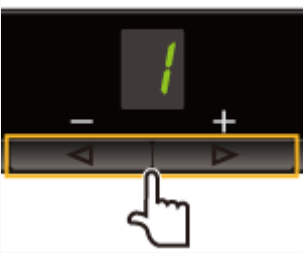

Press [].

Enlarging/Reducing Copy

85RS-025

You can specify a copy ratio (50 to 200%) in 10% increments.

	Operating results	Operating procedures
1		<p>Place the document.</p> <ul style="list-style-type: none"> ▶ " Placing Documents(P. 43) " ▶ " Supported Paper Types(P. 70) "
2		<p>Press [◀] or [▶] to specify the copy quantity. Specify the copy quantity first. You can set the copy quantity to "F" or "1" to "9."</p> <div style="background-color: #e6f2e6; padding: 10px; border: 1px solid #ccc;"> <p>You can register the custom copy quantity (user-defined number up to twenty-nine copies) to "F." The pre-defined settings comes useful if you copy a certain number of quantity, or want to copy more than 10 sets.</p> <ul style="list-style-type: none"> ▶ " Registering the Quantity that You Frequently Copy (Up to Twenty-nine Copies)(P. 78) " </div>
3		<p>Specify the following settings if necessary by pressing [] (Menu setting key).</p> <div style="background-color: #e6f2e6; padding: 10px; border: 1px solid #ccc;"> <ul style="list-style-type: none"> ▶ " Selecting Copy Type (Speed Priority/Resolution Priority)(P. 88) " ▶ " Emphasizing the Outline of an Image (Sharpness) (P. 90) " </div>
4		<p>Press [  ] (Copy setting key) to specify the density settings if necessary.</p> <ul style="list-style-type: none"> ▶ " Adjusting the Density(P. 79) "
5		<p>Press [  ] (Copy setting key) to blink the [] indicator.</p>

6		<p>Change the ratio.</p> <p>50% to 90% 100% 110% to 190% 200%</p> <p>-5 to -1 0 +1 to +9 ±9</p> <p>▶ " Setting List(P. 31) "</p>
7		<p>Press [] to start copying.</p> <p><Canceling copy jobs> Press [].</p>

※ You cannot perform the enlarged or reduced copy when combined with the following functions.





- ▶ " Copying Both Sides of Cards onto One Side (ID Card Copy)(P. 83) "
- ▶ " Copying Two Documents onto One Sheet (2 on 1 Copy)(P. 86) "

Copying Both Sides of Cards onto One Side (ID Card Copy)

85RS-026

You can copy both sides of cards onto one side.

<Before copying>

If the [  ] indicator is on or other than [1] is displayed, the previous copy settings are remained. In this case, press [] to reset the copy settings.

※ If a key is not pressed for 2 minutes, the copy settings will be automatically reset.

NOTE

You can copy with combined the functions.







- ▶ " Registering the Quantity that You Frequently Copy (Up to Twenty-nine Copies)(P. 78) "
- ▶ " Adjusting the Density(P. 79) "
- ▶ " Selecting Copy Type (Speed Priority/Resolution Priority)(P. 88) "
- ▶ " Emphasizing the Outline of an Image (Sharpness)(P. 90) "



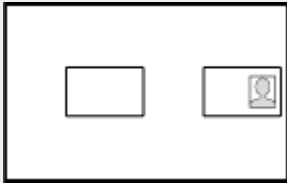
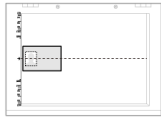
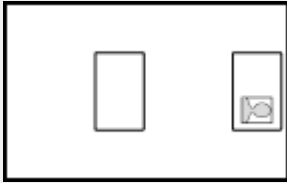

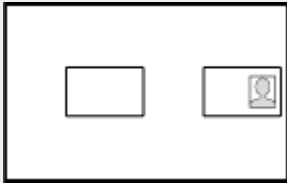
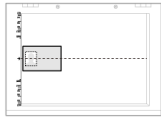
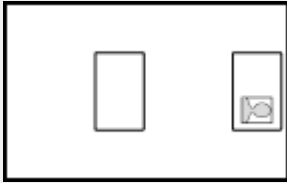

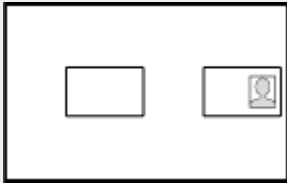
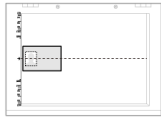
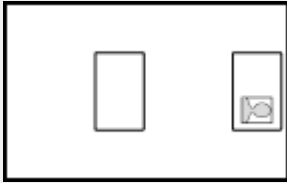
Changing the copy ratio

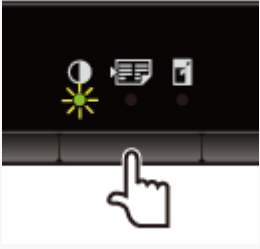

The output size is the same as the documents (100%).

Paper size requirements

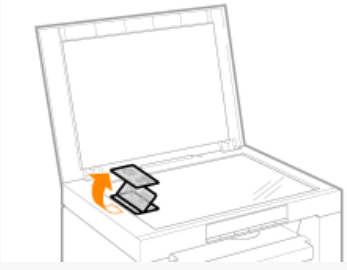
A size larger than A4 or Letter.

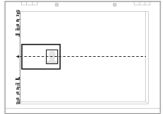
	Operating results	Operating procedures				
1		<p>Place the card on the platen glass, and then close it. Place the card to align the center of the card with the arrow mark.</p> <table border="1" data-bbox="742 1323 1471 1832"> <tr> <td data-bbox="742 1323 1278 1579"> <p>If you want to arrange the cards horizontally</p>  </td> <td data-bbox="1278 1323 1471 1579">  </td> </tr> <tr> <td data-bbox="742 1579 1278 1832"> <p>If you want to arrange the cards vertically</p>  </td> <td data-bbox="1278 1579 1471 1832">  </td> </tr> </table> <p>※ Place the card with a 5 mm space created from the left edge of the platen glass.</p> <p>※ Place the card to fit in the left half of the platen glass.</p>	<p>If you want to arrange the cards horizontally</p> 		<p>If you want to arrange the cards vertically</p> 	
<p>If you want to arrange the cards horizontally</p> 						
<p>If you want to arrange the cards vertically</p> 						

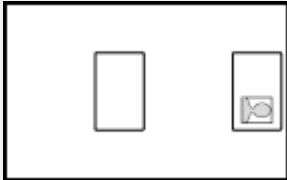
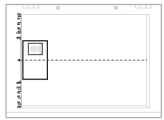
2		<p>Press [◀] or [▶] to specify the copy quantity. Specify the copy quantity first. You can set the copy quantity to "F" or "1" to "9."</p> <p>You can register the custom copy quantity (user-defined number up to twenty-nine copies) to "F." The pre-defined settings comes useful if you copy a certain number of quantity, or want to copy more than 10 sets.</p> <p>▶ " Registering the Quantity that You Frequently Copy (Up to Twenty-nine Copies)(P. 78) "</p>
3		<p>Press [☾] [📄] [📄] (Copy setting key) to specify the density settings if necessary.</p> <p>▶ " Adjusting the Density(P. 79) "</p>
4		<p>Press [☾] [📄] [📄] (Copy setting key) to to blink the [📄] indicator.</p>
5		<p>Press [◀] or [▶] to display "C".</p>
6		<p>Press [⬇]. One side of the card (the side toward the platen glass) is scanned.</p> <p>After scanning, "C" blinks.</p> 
7		<p>Turn and place the card. Place the card to align the center of the card with the arrow mark.</p> <p>If you want to arrange the cards horizontally</p>  

		<p>If you want to arrange the cards vertically</p>   <ul style="list-style-type: none">※ Place the card with a 5 mm space created from the left edge of the platen glass.※ Place the card to fit in the left half of the platen glass.
<p>8</p>		<p>Press []. The reverse side of the card is scanned. After scanning, printing starts.</p>



Copying Two Documents onto One Sheet (2 on 1 Copy)

85RS-027

You can copy the two documents onto one sheet by reducing the size.



<Before copying>

If the [] indicator is on or other than [1] is displayed, the previous copy settings are remained. In this case, Press [] and reset the settings.

※ If a key is not pressed for 2 minutes, the copy settings will be automatically reset.

NOTE

You can copy with the combined functions.







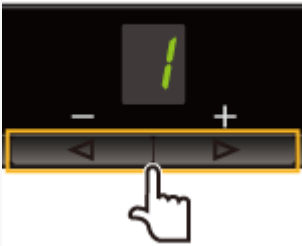









- ▶ " Registering the Quantity that You Frequently Copy (Up to Twenty-nine Copies)(P. 78) "
- ▶ " Adjusting the Density(P. 79) "
- ▶ " Selecting Copy Type (Speed Priority/Resolution Priority)(P. 88) "
- ▶ " Emphasizing the Outline of an Image (Sharpness)(P. 90) "

Paper size requirements

A size larger than A4 or Letter.

	Operating results	Operating procedures
1		<p style="text-align: center;">Place the document.</p> <ul style="list-style-type: none"> ▶ " Placing Documents(P. 43) " ▶ " Supported Paper Types(P. 70) "
2		<p style="text-align: center;">Press [◀] or [▶] to specify the copy quantity. Specify the copy quantity first.</p> <p>You can set the copy quantity to "F" or "1" to "9."</p> <div style="border: 1px solid #ccc; padding: 5px; margin-top: 10px;"> <p>You can register the custom copy quantity (user-defined number up to twenty-nine copies) to "F." The pre-defined settings comes useful if you copy a certain number of quantity, or want to copy more than 10 sets.</p> </div>

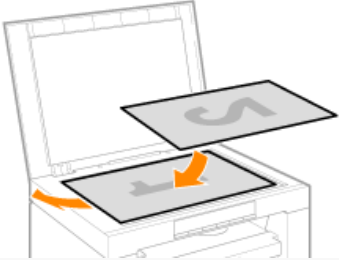





▶ "Registering the Quantity that You Frequently Copy (Up to Twenty-nine Copies)(P. 78) "



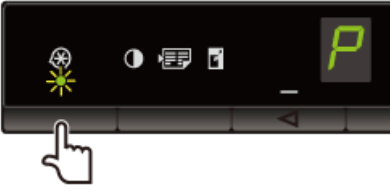

3		<p>Press [  ] (Copy setting key) to specify the density settings if necessary.</p> <p>▶ "Adjusting the Density(P. 79) "</p>
4		<p>Press [  ] (Copy setting key) to blink the [] indicator.</p>
5		<p>Press [] or [] to display "P."</p>
6		<p>Press [] to scan the first document.</p> <p>After scanning, "P" blinks.</p> 
7		<p>Place the second document.</p>
8		<p>Press [] to scan the second document.</p> <p>After scanning, printing starts.</p>

Selecting Copy Type (Speed Priority/Resolution Priority)

85RS-028

Select whether to set priority on copy speed or resolution to copy.

	Operating results	Operating procedures						
1		<p>Place the document.</p> <ul style="list-style-type: none"> ▶ " Placing Documents(P. 43) " ▶ " Supported Paper Types(P. 70) " 						
2		<p>Press [◀] or [▶] to specify the copy quantity. Specify the copy quantity first. You can set the copy quantity to "F" or "1" to "9."</p> <div style="border: 1px solid #ccc; padding: 5px; background-color: #f0f0f0;"> <p>You can register the custom copy quantity (user-defined number up to twenty-nine copies) to "F." The pre-defined settings comes useful if you copy a certain number of quantity, or want to copy more than 10 sets.</p> <ul style="list-style-type: none"> ▶ " Registering the Quantity that You Frequently Copy (Up to Twenty-nine Copies)(P. 78) " </div>						
3		<p>Press [⚙] (Menu setting key), and then start the menu operation. When the menu is operating, the menu indicator blinks.</p>						
4		<p>Press [◀] or [▶] until "E" is displayed.</p>						
5		<p>Press [⬠] to set the menu to be able to change the settings.</p>						
6		<p>Press [◀] or [▶] to change the setting values. The display and the copy type are matched as follows.</p> <table border="1" data-bbox="738 1917 1233 2085"> <thead> <tr> <th>Display</th> <th>Copy type</th> </tr> </thead> <tbody> <tr> <td>1</td> <td>Speed priority</td> </tr> <tr> <td>2</td> <td>Resolution priority</td> </tr> </tbody> </table>	Display	Copy type	1	Speed priority	2	Resolution priority
Display	Copy type							
1	Speed priority							
2	Resolution priority							





		▶ " Supported Paper Types(P. 70) "
7		Press [] to confirm the setting.
8		Press [] (Menu setting key) to exit the menu operation. The menu indicator turns off.





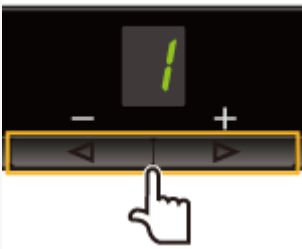





Emphasizing the Outline of an Image (Sharpness)

85RS-029

You can emphasize the outline of the image in the documents or decrease the contrast.

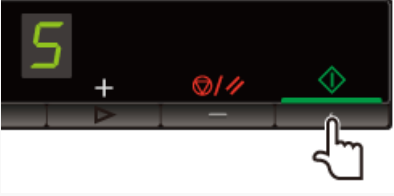

	Operating results	Operating procedures
1		<p>Place the document.</p> <ul style="list-style-type: none"> ▶ " Placing Documents(P. 43) " ▶ " Supported Paper Types(P. 70) "
2		<p>Press [◀] or [▶] to specify the copy quantity. Specify the copy quantity first.</p> <p>You can set the copy quantity to "F" or "1" to "9."</p> <div style="border: 1px solid #ccc; padding: 5px; background-color: #e6f2e6;"> <p>You can register the custom copy quantity (user-defined number up to twenty-nine copies) to "F." The pre-defined settings comes useful if you copy a certain number of quantity, or want to copy more than 10 sets.</p> <ul style="list-style-type: none"> ▶ " Registering the Quantity that You Frequently Copy (Up to Twenty-nine Copies)(P. 78) " </div>
3		<p>Press [] (Menu setting key), and then start the menu operation.</p> <p>When the menu is operating, the menu indicator blinks.</p>
4		<p>Press [◀] or [▶] until "S" is displayed.</p>

5		<p>Press [] to set the menu to be able to change the settings.</p>
6		<p>Press [] or [] to change the setting values. <Pressing [] to decrease the values> It is appropriate when you want to copy documents clearly such as photos. <Pressing [] to increase the values> It is appropriate when you want to copy text and lines clearly.</p>
7		<p>Press [] to confirm the setting.</p>
8		<p>Press [] (Menu setting key) to exit the menu operation. The menu indicator turns off.</p>

Print

Print	93
Preparing to Print from Your Computer	94
Setting Up Printer Sharing	95
Printing Fundamentals	97
Printing	98
Configuring the Default Print Settings	101
Viewing the Online Help	103
Printing on Custom Paper Size	105
Registering a Custom Paper Size	106
Canceling Print	107
Selecting and Canceling Jobs	108

Print

This chapter describes how to print from your computer to the machine.

Once you have the printer driver installed on your computer, you can print your document files to the machine efficiently. In addition, the printer driver offers various finishing options, such as scaling and gutters.

Preparing for printing

Preparing to use the print functions	See " Preparing to Print from Your Computer(P. 94) ."
Setting up printer sharing	See " Setting Up Printer Sharing(P. 95) ."

Printing

Learn about ways to print from your computer	See " Printing Fundamentals(P. 97) ."
Learning about print options	See the online help to find what you can configure in each sheet.
Using various print options	See the online help. " Viewing the Online Help(P. 103) "

Checking jobs or changing settings using the operation panel

Checking or deleting print jobs	See " Canceling Print(P. 107) ."
---------------------------------	---

Preparing to Print from Your Computer

85RS-02C

In order to print, install the printer driver in the printer.

➤ See the MF Driver Installation Guide in " **Manuals and Their Contents(P. 223)** ".

 **NOTE**

About the printer driver

The printer driver is software required for printing from an application. The printer driver will convert application software's print data to print data for the printer.

The printer driver for this machine has the following features.

- The printer driver for this machine enables you to output print data at an optimum speed by dividing the workload using a computer and the printer.
- As well as providing faster and more stable printing than conventional models, the printer driver for this machine uses less memory to operate.
- In addition to the conversion of print data, the printer driver for this machine is equipped with the functions capable of spooling print data and configuring the print condition, and various types of print finishing can be set such as scaling or gutter adjustment.

Setting Up Printer Sharing

85RS-02E

Once you have set up a print server on your network, you can efficiently manage print jobs through the print server. Additionally, you can install the alternate printer driver for the machine on your computer from the network by adding it to the print server.

IMPORTANT

You may be unable to install drivers over the network depending on the operating system and the bit architecture (32-bit or 64-bit) of the print server and client computers.

1 Open the printer folder.

 " Basic Windows Operations(P. 224) "

2 Display the [Sharing] tab.

For Windows 7:

1. Right-click the icon for the machine and select [Printer properties] from the pop-up menu.
2. Display the [Sharing] tab.

For Windows 8:

1. Right-click the icon for the machine and select [Printer properties].
2. Click the [Sharing] from the pop-up menu.

For Windows 10:

1. Right-click the icon for the machine and select [Printer properties].
2. Display the [Sharing] tab.

3 Select [Share this printer] or [Shared as] and enter the share name of the machine.

When [Change sharing options] appears

Click [Change sharing options].

When the [User Account Control] dialog box appears, click [Continue].

 Continue with the steps in the procedure below and install the alternate printer driver on your computer.

4 Insert the User Software CD-ROM into the slot on your computer and click [Additional Drivers].

5 Install the alternate printer driver.

The installation dialog box appears when the alternate printer driver is selected and [OK] is clicked. Browse to the folder where the printer driver files are stored and follow onscreen instructions.

6 Click [OK].

The procedure is complete.



To install the printer driver on another computer

1. From the [Start] menu, select [Programs] or [All Programs] -> [Accessories] -> [Windows Explorer].
2. Select the print server from [My Network Places] or [Network].
3. Double-click the shared printer or drag and drop it into the printer folder.
4. Follow the onscreen instructions to install the printer driver.

Printing Fundamentals

85RS-02F

This section explains the basic printing method using the printer driver, how to set the printer options, and how to display the online help.

 **NOTE**

To use the printer, you need an appropriate printer driver.
Refer to the MF Driver Installation Guide and install the printer driver.

- ▶ **Manuals and Their Contents(P. 223)**

- ▶ **" Printing(P. 98) "**
- ▶ **" Configuring the Default Print Settings(P. 101) "**
- ▶ **" Viewing the Online Help(P. 103) "**

Printing

85RS-02H

This section explains the basic printing method using the printer driver.

NOTE

- Printing methods may differ depending on the application you are using. For details, see the instruction manuals provided with the application.
- The display may differ according to the operating system, as well as the type and version of the printer driver.
- The machine may not be able to print data such as color photos if the data size of a single page is too large. If such is the case, reduce the data size by lowering the resolution or by changing the file format.
- If a printer icon is displayed in the task tray at the bottom right of your computer monitor, you can stop printing from your computer. Double-click the printer icon -> click the name of the file you want to stop printing -> click [Document] -> [Cancel].
- In Windows 8, when printing from the Windows Store app, if you have previously selected settings that require input or a procedure when printing such as secure printing, edit + preview, department ID management, etc., the message [The printer requires your attention. Go to the desktop to take care of it.] is displayed. If this happens, move to the desktop and follow the instructions in the displayed dialog box.

1 Open the document you want to print from the application.

2 Select [Print] from the [File] menu.

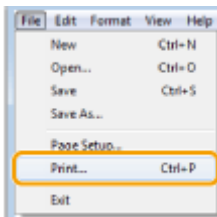

NOTE

In Windows 8, if you want to print from the Windows Store app, display the charm bar to the right of the screen, and tap [] (Devices) -> the printer you are using -> [Print]. When you print in this way, you can only set some of the print functions.

3 Select your printer from [Name] -> click [Preferences] (or [Properties]).

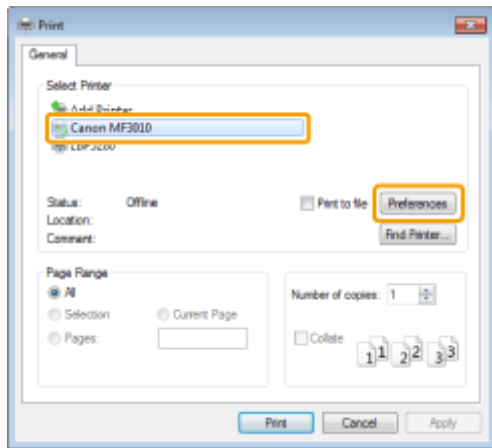

4 Specify the desired settings in the printer driver screen -> click [OK].

Click each tab and specify the desired items.

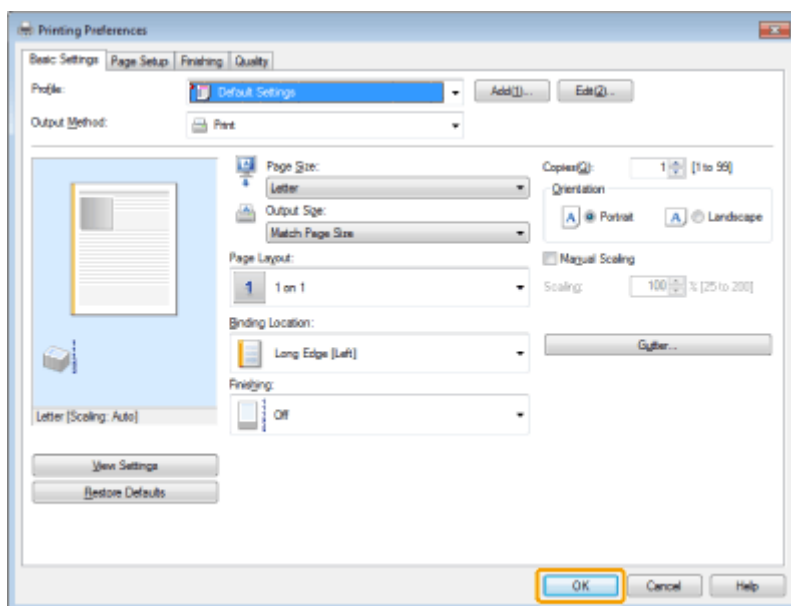

NOTE

- The [Basic Settings] tab comprises a few of the basic settings of the driver. The settings that you can configure in the [Basic Settings] tab can also be configured in other tabs.
- For information on available printing functions, view the online help to find what you can configure in each sheet. (See " **Viewing the Online Help(P. 103)** .")

5 Click [Print] (or [OK]).

Print



Printing begins.

Configuring the Default Print Settings

85RS-02J

This section describes how to access the printer setup screen from [Control Panel] and how to specify printing functions beforehand.

The printer whose settings you have specified will print with the same settings every time.

When printing, you can change the settings specified beforehand whenever required. To change the settings, configure them in the [Print] dialog box from the application (see " **Printing(P. 98)** ").

IMPORTANT

To change the default print settings, you must log on to your computer as a member of the Administrators or Power Users group.



NOTE

The display may differ according to the operating system, as well as the type and version of the printer driver.

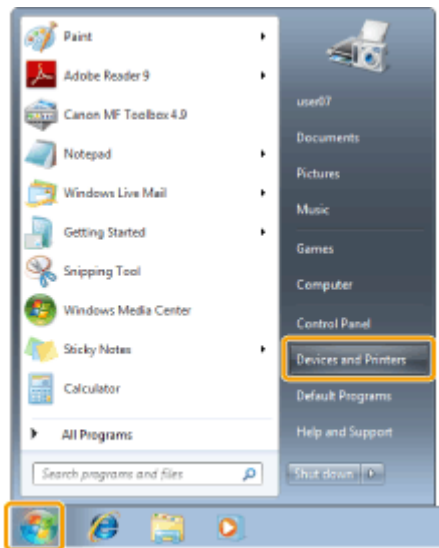
1 Click [] (Start) -> [Devices and Printers].



NOTE

- For Windows 10: Click [] (Start) -> select [Windows System] -> [Control Panel] -> [Hardware and Sound] -> [Devices and Printers].
- For Windows 8: From the desktop, display the charm bar to the right of the screen, and click or tap [] (Settings) -> [Control Panel] -> [Devices and printers].

2 Right-click the icon of the printer whose settings you want to specify -> click [Printing preferences].

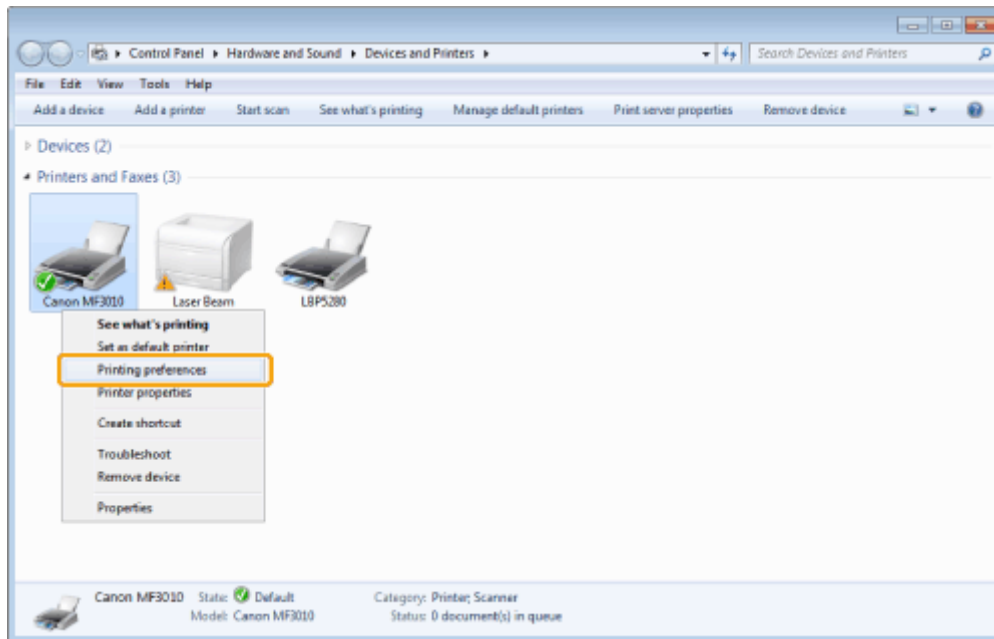

3 Specify the desired settings in the printer driver screen -> click [OK].

Click each tab and specify the desired items.

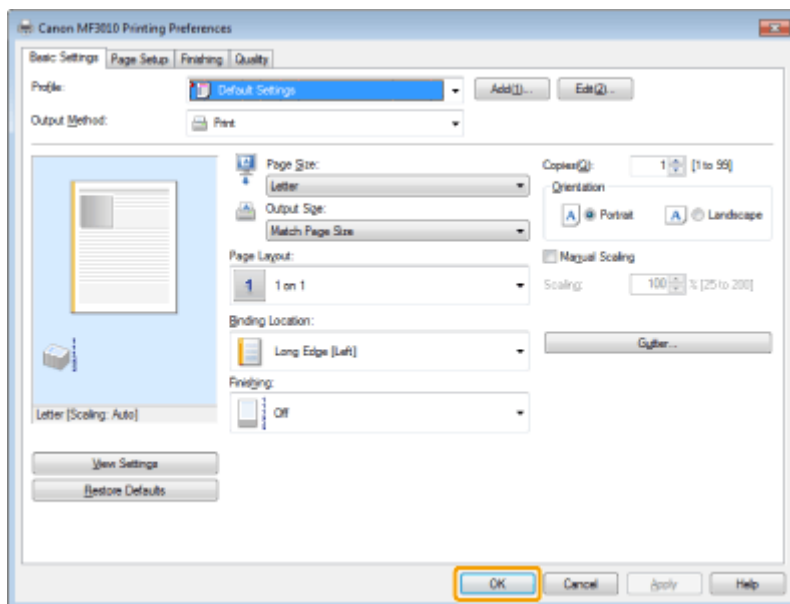

Note

- The [Basic Settings] tab comprises a few of the basic settings of the driver. The settings that you can configure in the [Basic Settings] tab can also be configured in other tabs.
- For information on available printing functions, view the online help to find what you can configure in each sheet. (See " **Viewing the Online Help(P. 103)** .")

Viewing the Online Help

85RS-02K

You can display the online help by clicking [Help] on the printer driver screen.

The online help includes additional information about each printing option. If the User's Guide does not provide the information you need, see the online help.

NOTE

The display may differ according to the operating system, as well as the type and version of the printer driver.

1 Click [Help].

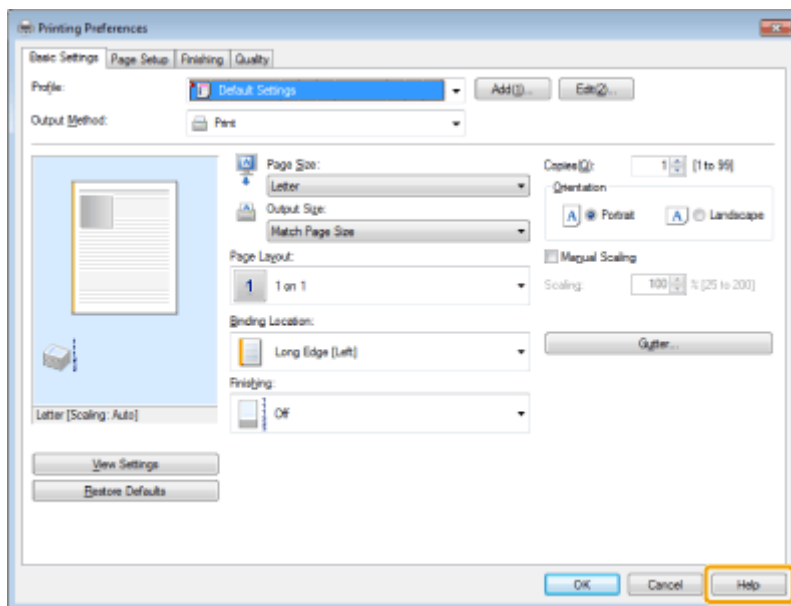

The online help is displayed.

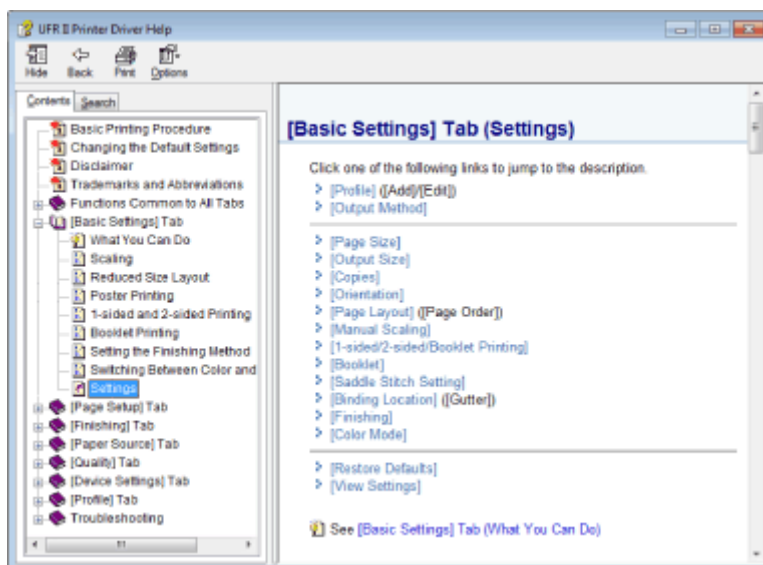

Topic pane (right side)

Displays the description of the information.

Navigation pane (left side)	Click [Contents] / [Search] to search for information.
-----------------------------	--

Printing on Custom Paper Size

85RS-02L

Checking available custom paper size

Custom paper sizes with width of 76.2 to 216.0 mm and height of 127.0 to 356.0 mm can be used with this printer.

Loading custom paper size

Load paper in the paper cassette.

▶ " **In the Paper Cassette(P. 47)** "

Registering custom paper size

When printing on custom paper size, you need to register the custom paper size in the printer driver beforehand.

▶ " **Registering a Custom Paper Size(P. 106)** "

Printing from application software

Perform printing after loading custom paper size.

▶ " **Print(P. 93)** "

Printing on heavy paper, rough paper, or labels slows down the print speed.

Registering a Custom Paper Size

Combinations of printer driver settings corresponding to a variety of printing purposes are provided with the printer driver as "profiles". This enables you to print documents according to a desired objective by simply selecting a profile from the [Profile] list.

1 Display the printer folder.

▶ " Basic Windows Operations(P. 224) "

2 Right-click the icon for this printer, and select [Printing Preferences] from the popup menu.

3 Display the [Custom Paper Size Settings] dialog box.

- (1) Display the [Page Setup] tab.
- (2) Click [Custom Paper Size].

4 Set a custom paper size.

[Name of Custom Paper Size]	Enter the register name of the custom paper size. You can enter up to thirty one characters.
[Unit]	Select the units to use when setting the custom paper size.
[Paper Size]	Set height and width ([Height] ≥ [Width]) of custom paper. Specify the paper size in portrait orientation ([Height] ≥ [Width]) and within the range that can be defined.

5 Register the custom paper size.

- (1) Click [Register].
The number of custom paper sizes that can be registered differs according to your system environment.
- (2) Check [Paper List] to make sure that the custom paper size you registered has been added.
- (3) Click [OK].

See " **Printing(P. 98)** " for basic printing procedures.

Canceling Print

85RS-02S

You can cancel the job that is currently printing.



If multiple jobs are printing, see the following to select and cancel the jobs using the print queue (Windows function).

▶ " Selecting and Canceling Jobs(P. 108) "

 NOTE

Displaying Job Processing

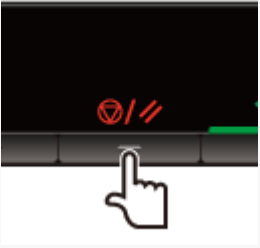

	Operating results	Operating procedures
1		<p>Press [] (Job cancel key) to cancel the job.</p> <div data-bbox="742 884 1445 1122" style="border: 1px solid #ccc; padding: 5px;"> <p> If you cannot cancel the job</p> <p>You cannot cancel pages that have already started printing. Jobs cannot be canceled if they are switched (the job when you press the key differs from the job when you release the key) while you are pressing the job cancel key.</p> </div>

Selecting and Canceling Jobs

85RS-02U

1 Display the print queue.

1. Display the printer folder.
▶ " **Basic Windows Operations(P. 224)** "
2. Double-click the icon for this printer.

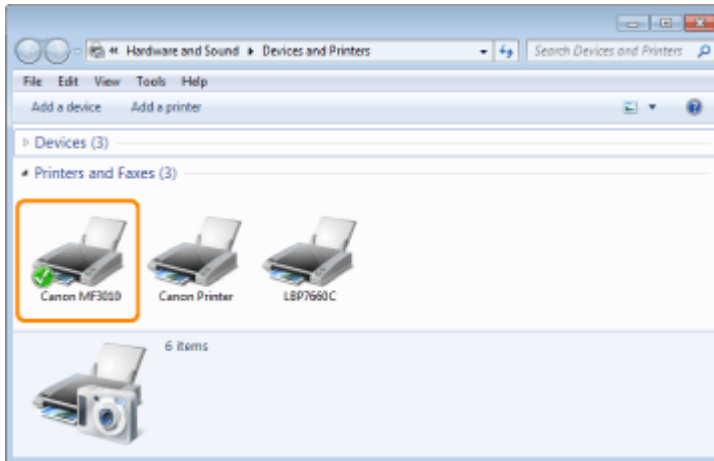

2 Right-click the job you want to cancel, and select [Cancel] from the popup menu.

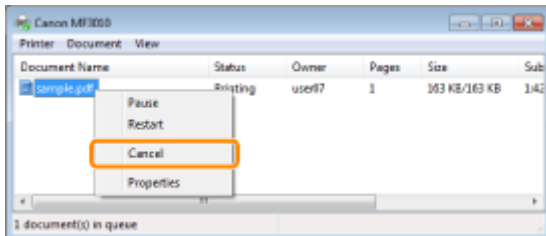

❓ If the job is not displayed

Other user's jobs are not displayed. (In a print server environment, all jobs are displayed on the print server.)

✍ NOTE

For details on the print queue

See Windows Help.

3 Clicking [Yes] cancels the print job.

❓ If you cannot cancel printing

You cannot cancel pages that have already started printing.

Scan

Scan	110
Preparing to Use the Scan Functions	111
System Requirements (Scan)	112
Basic Scan Flow	113
Scanning Using the MF Toolbox	114
Scanning an Image Using an Application	116
Scanning Using the WIA Driver	117
[New Scan] Dialog Box	121
Attention (WIA Driver)	123
Using the MF Toolbox	124
Combining Multiple Documents into One PDF File	130
Using the ScanGear MF	132
Using Simple Mode	133
Using Advanced Mode	136
Defining a Scan Area (Cropping Frame)	148
Setting Resolution	150

Scan

This chapter describes how to save scanned data to your computer.

You can easily save the documents that were scanned by computer operation.

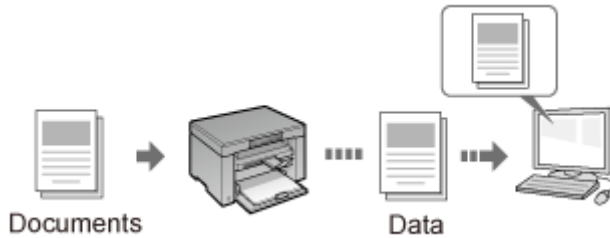

The machine provides a wide variety of scan settings for you to choose from. You can save a scanned document in the "Searchable PDF" file format, which converts scanned images to searchable text data, without having to specify advanced scan settings.

Plus, you can scan documents using the MF Toolbox available for the machine, or the WIA driver. There are many ways to convert your paper documents into electronic files. All you need to do is to select one based on your scan needs.

Preparing to scan your document

Preparing to use the scan functions	See " Preparing to Use the Scan Functions(P. 111) ."
-------------------------------------	---

Performing a scan

Learn about ways to perform a scan	See " Basic Scan Flow(P. 113) ."
Scanning using the machine's scanning software	See " Scanning Using the MF Toolbox(P. 114) ."
Scanning using an application	See " Scanning an Image Using an Application(P. 116) ."
Scanning using the WIA driver	See " Scanning Using the WIA Driver(P. 117) ."

Making best use of the scan functions

Learn how to use the MF Toolbox	See " Using the MF Toolbox(P. 124) ."
Learn how to combine multiple documents into one PDF file	See " Combining Multiple Documents into One PDF File(P. 130) ."
Learn how to use the ScanGear MF	See " Using the ScanGear MF(P. 132) ."

Preparing to Use the Scan Functions

85RS-02X

To scan documents, perform the following steps.

Step 1	Check your operating environment.	▶ " System Requirements (Scan)(P. 112) "
Step 2	Install the scanner driver.	▶ See the MF Driver Installation Guide in " Manuals and Their Contents(P. 223) " .

System Requirements (Scan)

85RS-02Y

Hardware requirements

- IBM or IBM-compatible PC
- A computer having a USB port with the USB class driver installed

Supported Operating Systems

- Windows 7 (32-bit/64-bit)
- Windows 8 (32-bit/64-bit)
- Windows 10 (32-bit/64-bit)

 **NOTE**

The following server operating systems are not supported.

- Windows Server 2012
- Windows Server 2016
- Windows Server 2019

To use a Hi-Speed USB

Make sure that your computer meets the following system requirements.

- CPU
 - Intel Pentium II or more
- RAM
 - 128 MB or more
- Operating system
 - Windows 7
 - Windows 8
 - Windows 10
- Driver
 - The Hi-Speed USB driver needs to be installed on the computer.

Basic Scan Flow

85RS-030

The following three scanning methods are available:

▶ **" Scanning Using the MF Toolbox(P. 114) "**

Scanning can be performed using the machine's available scanning software. You can fine-tune the scan settings based on your scan needs.

▶ **" Scanning an Image Using an Application(P. 116) "**

Scanning can be performed using your application. You can import scanned images directly into the application.

▶ **" Scanning Using the WIA Driver(P. 117) "**

Scanning can be performed using Windows OS drivers.

Scanning Using the MF Toolbox

1 Place your document.

- ▶ " Placing Documents(P. 43) "
- ▶ " Supported Document Types(P. 67) "

 **NOTE**

To scan from the platen glass

You can scan a multiple-page document only when

- [Save as Type] is set to [PDF (Multiple Pages)].
 - ▶ " **Combining Multiple Documents into One PDF File(P. 130) "**
- [Paper Size] in Step 6 is set to "fit the image."

2 Double-click the [Canon MF Toolbox 4.9] icon on the desktop.

The MF Toolbox starts.

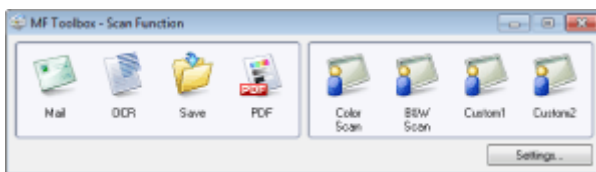

3 Click one of the MF Toolbox command buttons based on your purpose of the scan.

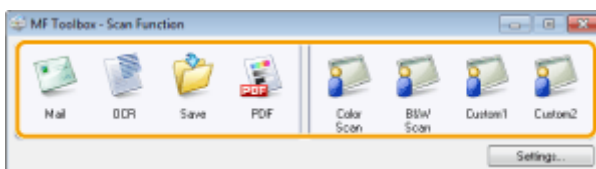

[Mail]	The document is scanned and sent as an e-mail attachment from your e-mail application.
[OCR]	The document is scanned and read by Optical Character Recognition (OCR) software.
[Save]	The document is scanned and saved.
[PDF]	The document is scanned and saved as a PDF file.
[Color Scan] [B&W Scan] [Custom 1] [Custom 2]	The document is scanned and displayed in the registered application. A dialog box appears for each of the buttons.

4 Specify the scanner settings as needed.

Click [Apply] to save the settings.

See " Using the MF Toolbox(P. 124) " for more information.

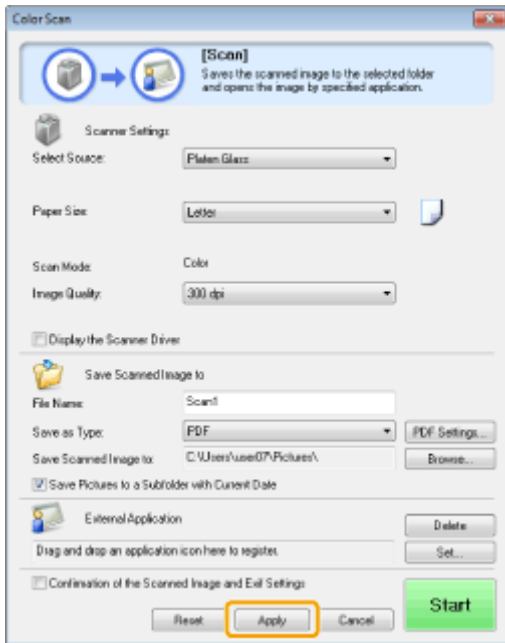

5 Click [Start].

Scanning starts.

When the [Display the Scanner Driver] check box is selected in Step 4(P. 114) :

The [ScanGear MF] dialog box appears.

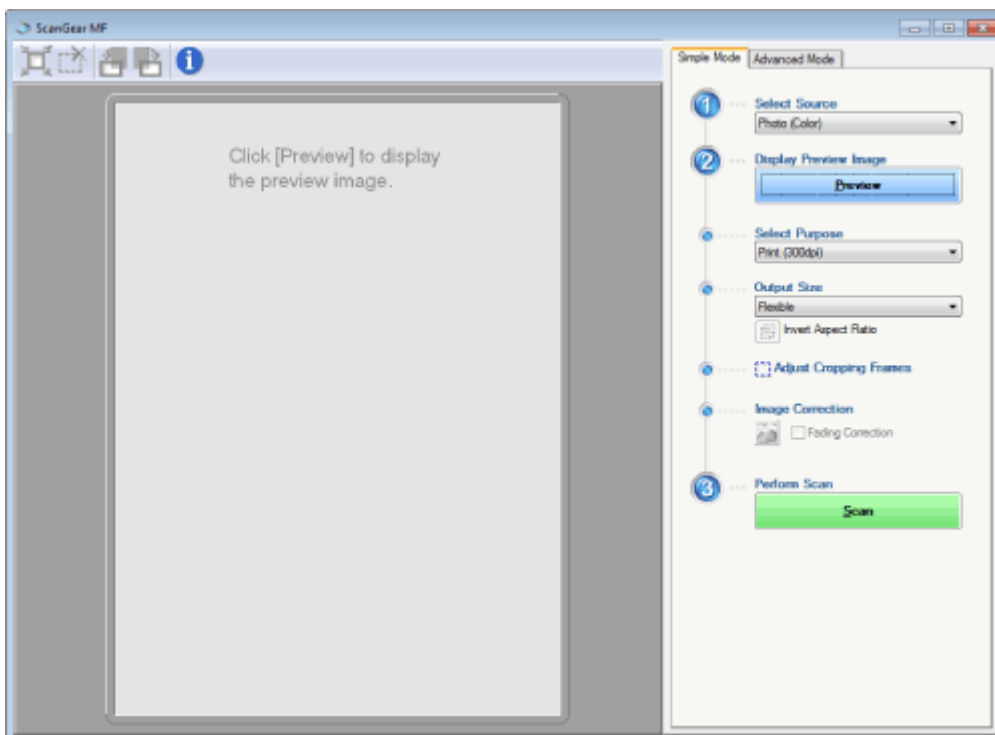

- (1) Specify the settings as needed.
See " **Using the ScanGear MF(P. 132)** " for more information.
- (2) Click [Scan].
Scanning starts.

Scanning an Image Using an Application

85RS-032

You can scan an image from a TWAIN- or WIA- compliant application and use the image in that application. The procedure varies depending on the application. This section shows an example.

1 Place your document.

- ▶ " [Placing Documents\(P. 43\)](#) "
- ▶ " [Supported Document Types\(P. 67\)](#) "

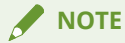

When scanning from the platen glass

Scanning multiple pages is not available when scanning from the platen glass.

2 Start the application to be used.

3 Select a scan command.

4 Select a scanner driver.

5 Specify the scanner settings as needed and click [Scan].

Scanning starts.

See the following sections for more information.

- ▶ " [Using the ScanGear MF\(P. 132\)](#) "
- ▶ " [Scanning Using the WIA Driver\(P. 117\)](#) "

Scanning Using the WIA Driver

85RS-033

Before scanning with the WIA driver, see " **Attention (WIA Driver)(P. 123)** ."

This section describes how to scan documents using the WIA driver.

- ▶ **Scanning from the [Windows Fax and Scan] dialog box(P. 117)**
- ▶ **Scanning Using Windows Live Photo Gallery (Windows 7/8 only)(P. 118)**
- ▶ **Scanning using an application(P. 119)**

You can fine tune settings for each scan.

- ▶ " **[New Scan] Dialog Box(P. 121)** "

Scanning from the [Windows Fax and Scan] dialog box

1 Place your document.

- ▶ " **Placing Documents(P. 43)** "
- ▶ " **Supported Document Types(P. 67)** "



NOTE

To scan from the platen glass

You cannot scan more than one document at a time.

2 Open the [Windows Fax and Scan] dialog box.

- ▶ " **Basic Windows Operations(P. 224)** "

3 Click [New Scan] on the toolbar.

4 Double-click the scanner icon when the following screen appears.

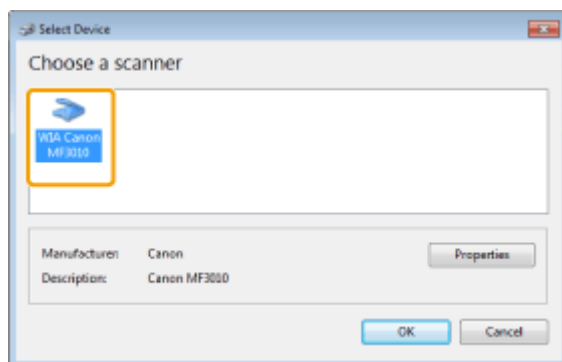

5 Specify the scan settings.

See " [New Scan] Dialog Box(P. 121) " for more information.

6 Click [Scan].

Scanning Using Windows Live Photo Gallery (Windows 7/8 only)

1 Place your document.

- ▶ " Placing Documents(P. 43) "
- ▶ " Supported Document Types(P. 67) "



NOTE

To scan from the platen glass

You cannot scan more than one document at a time.

2 Start [Windows Live Photo Gallery].

From the [Start] menu, select [All Programs] -> [Windows Live] -> [Windows Live Photo Gallery].

3 Open the [Import Pictures and Videos] dialog box.

From the [File] menu, select [Import from camera or scanner].

4 Double-click the scanner icon.

5 Specify the scan settings.

See " [New Scan] Dialog Box(P. 121) " for more information.

6 Click [Scan].

7 Click [Import].

- [Tag these pictures (optional)]
You can classify the scanned image by typing a tag.

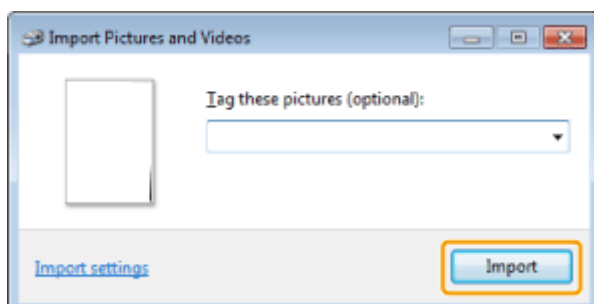

Scanning using an application

When the WIA driver is displayed, use the following steps. For the instructions on how to display the WIA driver, see " **Scanning an Image Using an Application(P. 116)** ".

1 Place your document.

- ▶ " **Placing Documents(P. 43)** "
- ▶ " **Supported Document Types(P. 67)** "

 **NOTE**

To scan from the platen glass
 You cannot scan more than one document at a time.

2 Select a picture type.

Select one of the following types.

- [Color picture]
- [Grayscale picture]
- [Black and white picture or text]
- [Custom settings]

3 Click [Adjust the quality of the scanned picture] as needed.

The [Advanced Properties] dialog box appears.

4 Adjust the image quality and click [OK].

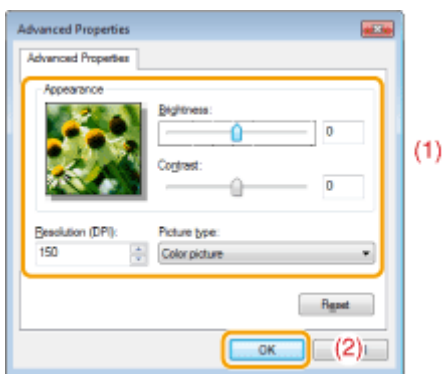

[Appearance]	A sample image is displayed.
[Brightness]	Specify the brightness (-127 to 127).
[Contrast]	Specify the contrast (-127 to 127) (only for color or grayscale scans).
[Resolution (DPI)]	Supported resolutions vary, depending on the operating system or the selected [Paper source] setting.
[Picture type]	Specify the color type.

[Reset]	Restore all the settings to the defaults.
---------	---

 NOTE

The options that are displayed in the [Advanced Properties] tab and their default values.

These vary across the selected image type.

5 Click [Preview] and drag to specify the scanning area.

6 Click [Scan].

[New Scan] Dialog Box

85RS-034

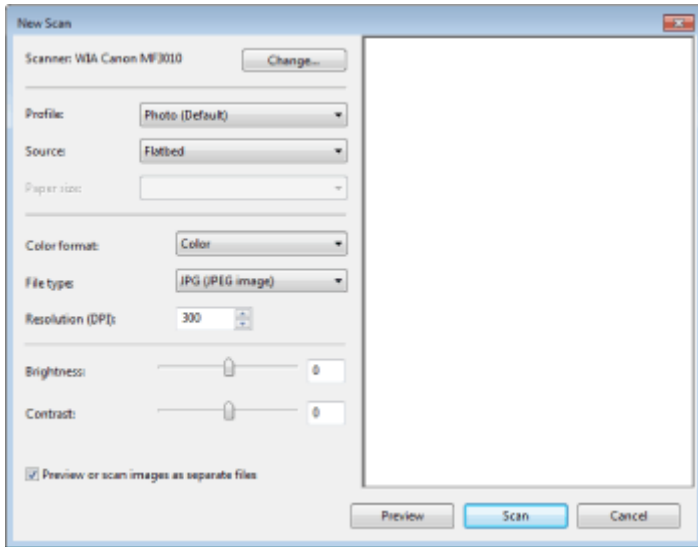

[Scanner]	Display a list of available scanners. Click [Change] and select the scanner.
[Profile]	<p>Select one of the following document types.</p> <ul style="list-style-type: none"> • [Add profile] • [Documents] • [Last used settings] • [Photo (Default)] <div style="border: 1px solid #ccc; background-color: #e6f2e6; padding: 10px; margin-top: 10px;"> <p> NOTE</p> <p>When [Add profile] is selected</p> <p>Add new profiles in the [Add New Profile] dialog box. Once these profiles have been added, you can delete or edit these profiles using [Scan Profiles] in the [Scanners and Cameras] folder. See the Windows documentation for more information.</p> </div>
[Source]	Select the location where documents are set. Click [Preview], and the drag [] to specify the scanning area.
[Color format]	<p>Select one of the following color types.</p> <ul style="list-style-type: none"> • [Color] • [Grayscale] • [Black and white]
[File type]	<p>Select one of the following file formats.</p> <ul style="list-style-type: none"> • [BMP (Bitmap image)] • [JPG (JPEG image)] • [PNG (PNG image)] • [TIF (TIFF image)]
[Resolution (DPI)]	Specify the scanning resolution in dpi (50 to 600 dpi).
[Brightness]	Specify the brightness (-100 to 100).

Scan

[Contrast]	Specify the contrast (-100 to 100) (only for color or grayscale scans).
[Preview or scan images as separate files]	The images scanned from [Flatbed] (the platen glass) are automatically cropped and saved as separate files.

Attention (WIA Driver)

85RS-035

Scanning from the [Windows Fax and Scan] dialog box

 NOTE

When scanning is complete

The scanned images are displayed within the [Windows Fax and Scan] folder.

File name and location where the scanned images are saved

Sequential numbers are automatically added to the end of the file names, and the files are saved in the [Scanned Documents] folder within the [Document] folder. You can change the file name later.

Scanning from Windows Live Photo Gallery (Windows 7/8 only)

 NOTE

To save the scanned image without a tag

The scanned image is saved in a new folder bearing the scanning date within the [Pictures] folder.

File name

Sequential numbers are automatically added. You can change the file name later.

Scanning from an application

 NOTE

About the displayed screen

The displayed screen varies across the operating system, as well as the type and version of the scanner driver.

Using the MF Toolbox

The following can be specified in the MF Toolbox:

- ▶ **Specifying scan settings(P. 124)**
- ▶ **Saving scanned images(P. 125)**
- ▶ **Configuring an application (an e-mail client application)(P. 126)**
- ▶ **Previewing the scanned image and entering Exif information (Viewing the scanned image)(P. 128)**

Specifying scan settings

You can specify the scan mode, resolution, original document size, and file size of the scanned images.

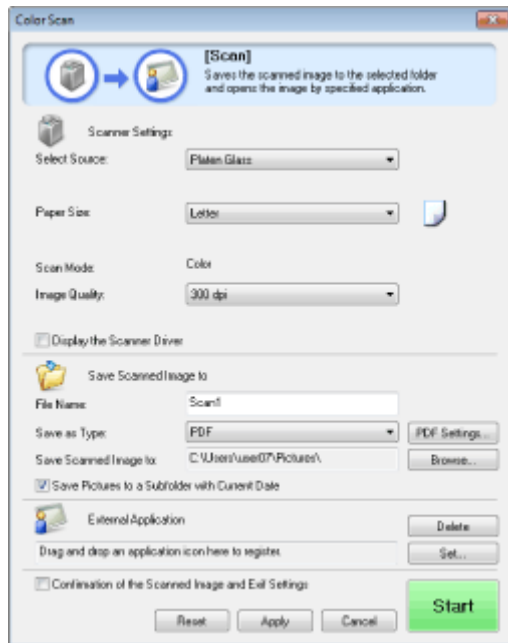

[Paper Size]	Specifies the original document size. When [Custom] is selected, the [Paper Size Settings] dialog box appears for you to specify a custom size.
[Scan Mode]	Select the scan mode. The modes selectable vary depending on the MF Toolbox command button clicked. <ul style="list-style-type: none"> • [Black and White] Scan a document as a black-and-white image. • [Black and White (OCR)] Scan a document as a black-and-white image which can be read by OCR software. • [Grayscale] Scan a document as a grayscale image (equivalent to a monochrome printed image). This mode is best suited for scanning photos. • [Color] Scan a document as a color image. • [Color (Magazine)] Scan a document in color using the descreening function. This mode helps reduce uneven gradation and striped patterns (moiré patterns) generated when scanning printed images. Scanning takes longer than usual.
[Image Quality]	Select the scan resolution. Available resolution varies depending on the [Select Source] or [Save as Type] settings.

	<table border="1"> <thead> <tr> <th>File Type</th> <th>Settable Resolution</th> </tr> </thead> <tbody> <tr> <td>BMP JPEG/EXIF TIFF</td> <td>75 to 600 dpi</td> </tr> <tr> <td>PDF PDF (1 page) PDF (multiple pages) PDF (additional pages)</td> <td>75 to 400 dpi</td> </tr> </tbody> </table> <p>※ When [Mail] is selected, supported resolutions vary, depending on the [Upper Limit of Attached File] setting specified.</p>	File Type	Settable Resolution	BMP JPEG/EXIF TIFF	75 to 600 dpi	PDF PDF (1 page) PDF (multiple pages) PDF (additional pages)	75 to 400 dpi
File Type	Settable Resolution						
BMP JPEG/EXIF TIFF	75 to 600 dpi						
PDF PDF (1 page) PDF (multiple pages) PDF (additional pages)	75 to 400 dpi						
[Display the Scanner Driver]	<p>When this check box is checked, the settings for [Scanner Settings] are unselectable.</p> <p>When [Start] is clicked, the [ScanGear MF] dialog box appears for you to specify advanced scan settings.</p> <p>This option is inaccessible when scanning using the [OCR] command button.</p>						

Saving scanned images

You can specify the file name, file format, and location where the scanned images are saved.

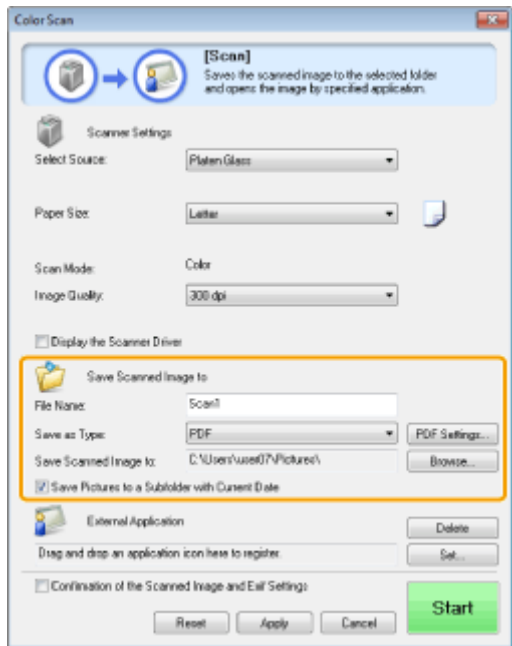

[File Name]	<p>Enter the file name of the scanned image.</p> <p>If there has already been a file saved under the same name, a four-digit number is automatically added to the end of the file name. The number starts with [0001].</p>
[Save as Type]	<p>Specify the file type to save the scanned image in.</p> <ul style="list-style-type: none"> • [BMP] Bitmap format • [JPEG/Exif] JPEG/Exif format (This option is selectable only when [Grayscale], [Color] or [Color (Magazine)] is selected for [Scan Mode].) • [TIFF] TIFF format • [PDF] PDF format (multiple pages or single page) • [PDF (Single Page)] Create a single-page PDF file.

- [PDF (Multiple Pages)]
Combine multiple documents into one PDF file.
- ▶ **" Combining Multiple Documents into One PDF File(P. 130) "**
- [PDF (Add Page)]
Add the scanned image to the last page of a PDF file created by the MF Toolbox.

 **NOTE**

File formats supported by command buttons

	BMP	JPEG/ Exif *	TIFF	PDF	PDF (Single Page)	PDF (Multiple Pages)	PDF (Add Page)
[Mail]	•	●	•	•	●	●	●
[OCR]	●	●	●	•	•	•	•
[Save]	●	●	●	•	●	●	●
[PDF]	•	•	•	•	●	●	●
[Color Scan]	●	●	●	●	•	•	•
[B&W Scan]	●	•	●	●	•	•	•
[Custom 1]	●	●	●	●	•	•	•
[Custom 2]	●	●	●	●	•	•	•

* You can select the option when [Scan Mode] is set to [Grayscale], [Color], or [Color (Magazine)].

When [PDF], [PDF (Single Page)], [PDF (Multiple Pages)] or [PDF (Add Page)] is selected

The error message <Image size is too large to create File.> may appear. If this happens, specify a smaller size for [Paper Size] and a lower quality level for [Image Quality] to reduce the data size of the scanned image.

[PDF Settings]	When [PDF], [PDF (Single Page)], [PDF (Multiple Pages)] or [PDF (Add Page)] is selected for [Save as Type], you can specify advanced file settings.
[Save Scanned Image to]	Display the location where the scanned image is saved when a setting other than [PDF (Add Page)] is selected for [Save as Type]. To save the image in a different location, click [Browse], select a folder, and click [OK].
[Add Scanned Image to]	This item appears instead of [Save Scanned Image to] when [PDF (Add Page)] is selected in [Save as Type]. You can select a PDF file to which the scanned image is added. However, you may only add scanned images to PDF files that have been created using MF Toolbox. You may not add scanned images to PDF files that have been created using other applications.
[Save Pictures to a Subfolder with Current Date]	Create a folder bearing the current date in the specified location to save the scanned image in this folder.

Configuring an application (an e-mail client application)

You can specify a host application to view the scanned image.

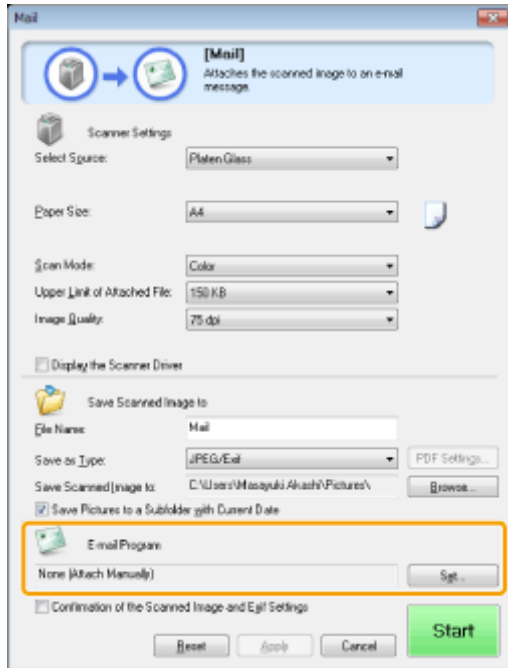

Click [Set], select an e-mail program to be used and click [OK]. (You can specify an application other than e-mail programs by dragging and dropping the application icon directly onto the dialog box.) For [Settings for E-mail Program], you can enter an e-mail address by clicking [Address Settings].

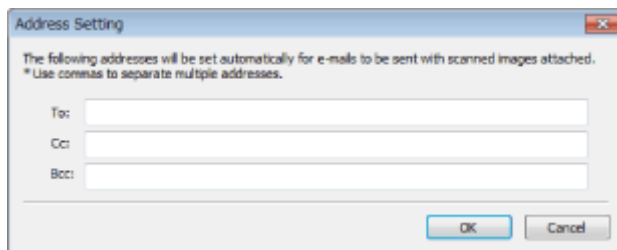
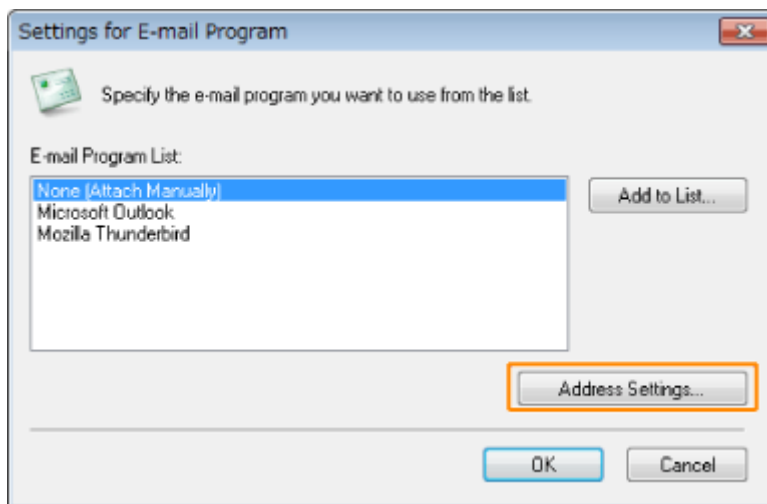

NOTE

When scanning using the [Mail] command button

The MF Toolbox supports the following e-mail applications.

- Microsoft Outlook Express
- Microsoft Outlook
- Microsoft Exchange

- EUDORA
- Netscape Messenger
- Windows Mail
- Becky! Ver.2
- Mozilla Thunderbird

Previewing the scanned image and entering Exif information (Viewing the scanned image)

Follow the steps in the procedure below to display a thumbnail preview of the scanned image before specifying the file format and location where the scanned image is saved.

- (1) Select the [Confirmation of the Scanned Image and Exif Settings] ([Confirm the Scanned Image] for the [PDF] button) check box.

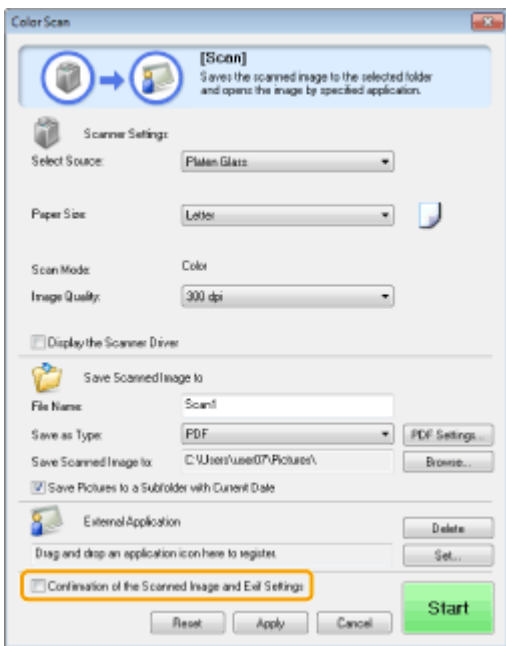

- (2) Press [Start].
The scanned image is displayed in the [Scanned Image] dialog box. See the following instructions to specify the file format and location where the image is saved.

NOTE

When scanning using the [OCR] command button
This check box is unselectable.

When scanning using the [PDF] command button
You can only preview the scanned image and specify the location where the image is saved.

[Save as Type]	Specify the file format to save the scanned image in.
[Exif Settings]	When [JPEG/EXIF] is selected for [Save as Type], display the [Exif Settings] dialog box for you to enter the Exif information. You can add such information as comments and the scanning date to the JPEG file. Choose a file from the drop-down list and add information. <ul style="list-style-type: none"> ● [Basic Information] Display the information acquired automatically when the image was scanned.

Scan

	<ul style="list-style-type: none"> • [Advanced Information] Display the newly added information. • [Apply the Same Setting of Input Items Automatically] When the check box is checked, the last specified scan settings are applied.
[PDF Settings]	When [PDF], [PDF (Single Page)], [PDF (Multiple Pages)] or [PDF (Add Page)] is selected for [Save as Type], you can specify advanced file settings.
[Save Scanned Image to]	Specify the location where the scanned image is saved.
[Add Scanned Image to]	This option appears instead of [Save Scanned Image to] when [PDF (Add Page)] is selected for [Save as Type]. Select a PDF file to which the scanned image is added. Note that you may not be able to add scanned images to PDF files, if the images are scanned using different applications.
[Save Pictures to a Subfolder with Current Date]	Create a folder bearing the current date in the specified location to save the scanned image in this folder. This option is unselectable when [Save as Type] is set to [PDF (Add Page)].
[Save]	Save the scanned image in the specified location.
[Forward]	This button appears instead of [Save] when an application is selected for [Mail Program] or the [External Application]. You can forward the scanned image to the application.
[Cancel]	Undo any changes made within the dialog box and return to the previous screen. All scanned images are deleted.

Combining Multiple Documents into One PDF File

85RS-037

You can combine multiple documents into one PDF file.

1 Place your documents on.

- ▶ " Placing Documents(P. 43) "
- ▶ " Supported Document Types(P. 67) "

2 Double-click the [Canon MF Toolbox 4.9] icon on the desktop.

The MF Toolbox starts.

3 Click [PDF].

4 Select [PDF (Multiple Pages)] for [Save as Type].

5 Specify the required settings as needed and click [PDF Settings].

The [PDF Settings] dialog box appears.

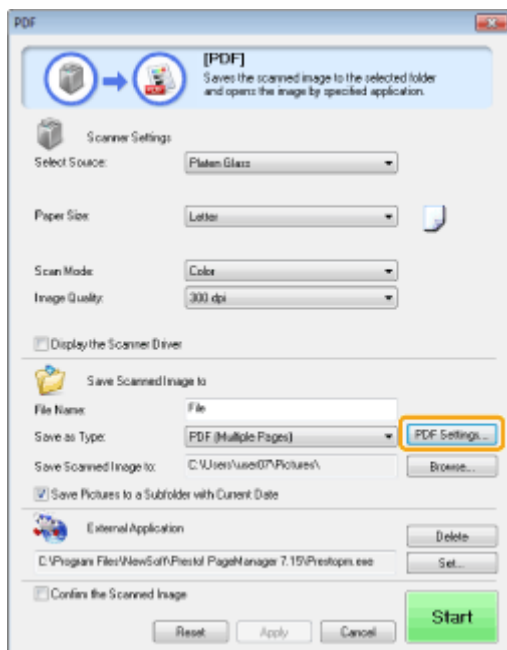

6 Specify the required settings as needed and click [OK].

[Create Searchable PDF]	Convert character data within the document to text data to create a searchable PDF file.
[Text Language]	Select the document language. When you select [English] from the drop-down list and set [Image Quality] to [300 dpi] or a higher dpi for [Scanner Settings], character data can be more accurately scanned.

[PDF Compression]	Select [High] to compress photos and illustrations to reduce the file size.
-------------------	---

7 Click [Start].

8 Place the next page and click [Next].

9 When scanning is complete, click [Finish].

Using the ScanGear MF

85RS-038

Using the ScanGear MF, you can display previews of images and specify advanced scan settings before performing scans.

- ▶ " **Using Simple Mode(P. 133) "**
- ▶ " **Using Advanced Mode(P. 136) "**
- ▶ " **Defining a Scan Area (Cropping Frame)(P. 148) "**
- ▶ " **Setting Resolution(P. 150) "**

Using Simple Mode

85RS-039

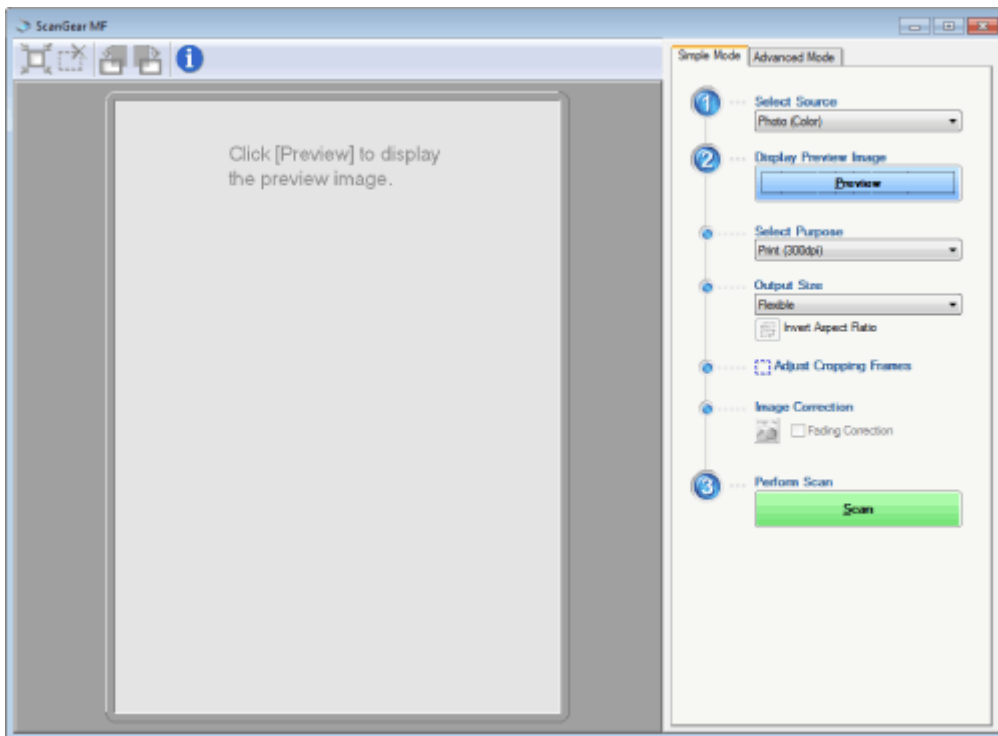

- ▶ Scanning in simple mode(P. 133)
- ▶ Simple mode toolbar(P. 134)
- ▶ Adding/Deleting the output size(P. 135)

Scanning in simple mode

1 Display the ScanGear MF.

Start the ScanGear MF using either of the following methods.

- Selecting [Display the Scanner Driver] in the MF Toolbox
- Starting from an application

2 Select a document type for [Select Source].

When selecting a document type other than [Newspaper (B&W)], the automatic color adjustment function is activated.

See " **Using Advanced Mode(P. 136)** " for the instructions on how to cancel this function.

[Photo (Color)]	Select when scanning color photos.
[Magazine (Color)]	Select when scanning color magazines (the Descreening function supported).
[Newspaper (B&W)]	Select when scanning text and line drawings.
[Document (Grayscale)]	Select when scanning color photos or documents in monochrome. This option is best suited for scanning high-resolution monochrome images.

3 Click [Preview].

The preview of the image is displayed.

4 Select the purpose of the scan for [Select Purpose].

- [Print (300dpi)]
- [Image Display (150dpi)]
- [OCR (300dpi)]
- ▶ " **Setting Resolution(P. 150)** "

5 Select the output size of the scanned image.

The options displayed in the window vary depending on the purpose of the scan specified in Step 4(P. 134) .

Click [] to choose the orientation of the output size between landscape and portrait.

6 Adjust the cropping frames as needed.

- ▶ " **Defining a Scan Area (Cropping Frame)(P. 148)** "





7 Select [Fading Correction] as needed.

- It can only be selected when color documents are scanned.
- It cannot be specified when the image is not displayed in the preview area.

8 Click [Scan].

Simple mode toolbar



[] (Auto Crop)	Specify scan areas (cropping frames) automatically. See " Defining a Scan Area (Cropping Frame)(P. 148) " for more information.
[] (Remove Cropping Frame)	Delete the selected cropping frames.
[] (Left Rotate)	Rotate the image 90 degrees to the left.
[] (Right Rotate)	Rotate the image 90 degrees to the right.
[] (Information)	Display the information of the scanned image.

Adding/Deleting the output size

The [Add/Delete the Output Size] dialog box appears when [Add/Delete] for [Output Size] is selected. You can add or delete output sizes within this dialog box.

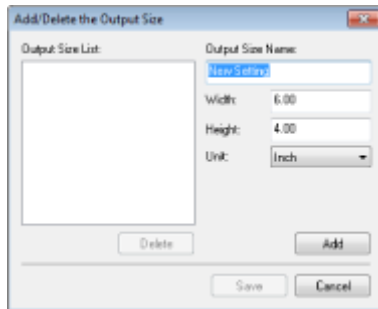

[Output Size List]	Display the registered output size name.
[Output Size Name]	Enter the output size name you want to register.
[Width]	Specify the width of the output size.
[Height]	Specify the height of the output size.
[Unit]	Select the unit of measurement for the output size.
[Add]	Add the specified output size to [Output Size List].
[Delete]	Delete the selected output size from [Output Size List].
[Save]	Save the settings specified within the dialog box.

Using Advanced Mode

85RS-03A

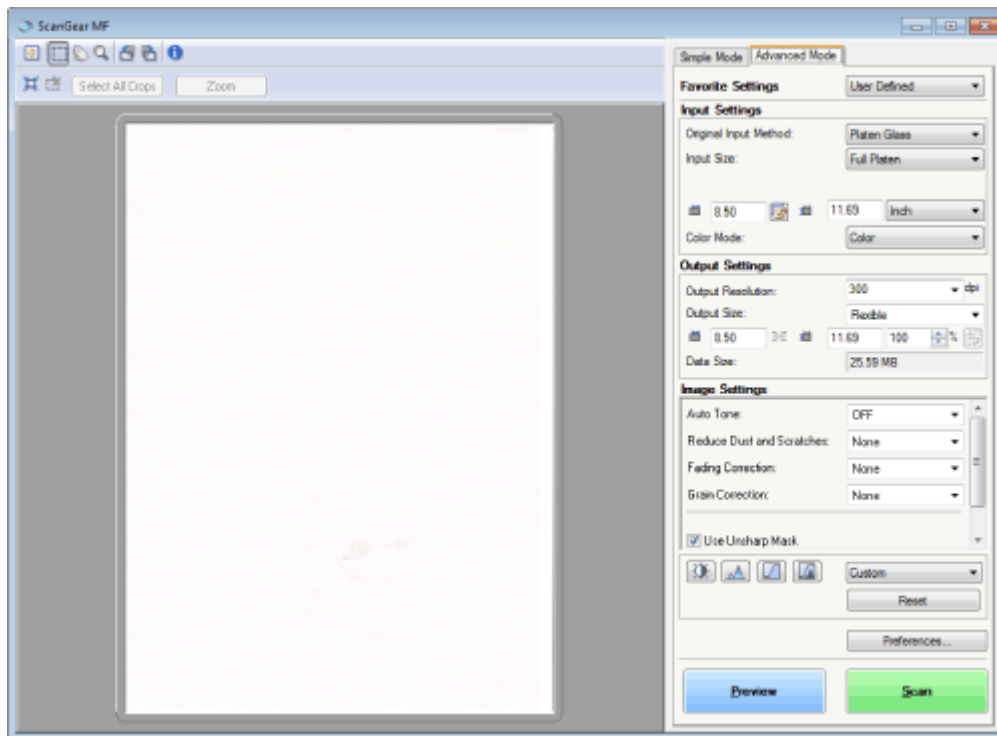

- ▶ Scanning in advanced mode(P. 136)
- ▶ Advanced mode toolbar(P. 137)
- ▶ Advanced mode settings(P. 138)

Scanning in advanced mode

1 Display the ScanGear MF.

Start the ScanGear MF using either of the following methods.

- Selecting [Display the Scanner Driver] in the MF Toolbox
- Starting from an application

2 Click [Advanced Mode].

3 Specify the settings.

- ▶ Favorite Settings(P. 138)
- ▶ Input Settings(P. 138)
- ▶ Output Settings(P. 139)
- ▶ Image Settings(P. 139)
- ▶ Color Settings(P. 141)
- ▶ Preferences(P. 144)

4 Click [Preview].

The preview of the image is displayed.

5 Specify scan areas if you want to scan specific areas within the document.









▶ " Defining a Scan Area (Cropping Frame)(P. 148) "

6 Click [Scan].

Advanced mode toolbar



※ To perform all tasks using commands available on the toolbar, you need to display the image in the preview area.

[] (Clear)	Delete the preview image. The settings specified using the toolbar commands as well as color settings are all cleared.
[] (Crop)	Specify the scan area.
[] (Move)	Move the enlarged image.
[] (Zoom)	Enlarge or reduces the preview image. <ul style="list-style-type: none"> • Left-clicking Enlarges the image. • Right-clicking Reduces the image.
[] (Left Rotate)	Rotate the image 90 degrees to the left.
[] (Right Rotate)	Rotate the image 90 degrees to the right.
[] (Information)	Display the information of the scanned image.
[] (Auto Crop)	Select the scan area within the image automatically. ▶ " Defining a Scan Area (Cropping Frame)(P. 148) "
[] (Remove Cropping Frame)	Delete the selected cropping frames.
[Select All Crops]	The settings specified within the [Advanced Mode] tab are applied to all cropping frames.
[Zoom]	Enlarge and scan the scan area specified within the preview image. When this button is clicked, it changes to [Undo].

Advanced mode settings

Favorite Settings

You can register frequently used input settings, output settings, image settings, color settings, and preferences as favorite settings. Once these settings have been registered as favorite settings, you can apply them to the entire image or specific scan areas of the image displayed in the preview area.



 **IMPORTANT**

The following cannot be registered as favorite settings:

- Width and height values set for [Input Settings] and [Output Settings]
- The [] button's enabled state (to allow maintaining height-width proportions) for [Input Settings]
- [%] values (Scale) set for [Output Settings]

[User Defined]	Enter and specify each setting.
[Default]	Restore all current settings to default settings. The image in the preview area is deleted accordingly.
[Add/Delete]	Display the [Add/Delete Favorite Settings] dialog box. You can register the current settings set for the image in the preview area under a specified name. This option is not displayed when no image is displayed in the preview area.

Input Settings

[Original Input Method]	[Platen Glass] is selected.
[Input Size]	<p>Select the document size.</p> <div data-bbox="606 1429 1417 1608" style="background-color: #e6f2e6; padding: 10px; margin: 10px 0;"> <p> NOTE</p> <p>If you modified the setting after previewing the image The image is deleted from the preview area.</p> </div> <ul style="list-style-type: none"> • Width: Specify the width of the input size. • Height: Specify the height of the input size. <div data-bbox="606 1794 1445 2056" style="background-color: #e6f2e6; padding: 10px; margin: 10px 0;"> <p> NOTE</p> <p>To change the unit of measurement Select [Pixel], [Inch], or [Millimeter] from the drop-down list on the right.</p> <p>The data size limit Some applications have the data size limit for scanning images. If the size exceeds 21,000 x 30,000 pixels, the image cannot be scanned.</p> </div>

	<p>The smallest data size The smallest data size is 4 by 4 pixels size. (It can be specified when [Output Resolution] is set to 25 dpi.)</p> <p>To maintain the current height-width proportions Click [].</p>
[Color Mode]	<p>Select the document type and scan mode.</p> <ul style="list-style-type: none"> • [Black and White] Select to output documents in black and white. The image is expressed in black and white based on the threshold value specified. See " Color Settings(P. 141) " for the instruction on how to specify a threshold value. • [Grayscale] Select to scan black and white printed photos or scan printed photos in black and white. The image is expressed in 256 shades, from 0 up to 255. • [Color] Select to scan color printed photos. The image is expressed in 256 colors (8 bits) for each R(ed), G(reen) and B(lue) color channel. • [Color (Documents)] Select when scanning documents that contain text or tables. The image is expressed in 256 levels (8-bit) of R(ed), G(reen), and B(lue). • [Text Enhanced] Select to capture text clearly. This mode is suited for reading text using OCR software. The image is expressed in black and white.

Output Settings











[Output Resolution]	<p>Select the scan resolution from the drop-down list or manually enter a value from 25 up to 9600 dpi.</p> <p> " Setting Resolution(P. 150) "</p>
[Output Size]	<p>Select the output size of the scanned image.</p> <ul style="list-style-type: none"> • When [Add/Delete] is selected The [Add/Delete the Output Size] dialog box appears. You can add or delete output sizes within this dialog box. •  " Using Simple Mode(P. 133) " • When [Flexible] is selected Enter width, height , or [%] (Scale) values. The ratio of width and height is proportional to the width and height set for [Input Settings]. The scan resolution switches based on the [%] (Scale) value specified. Values can be from 25 up to 38,400. Note that the upper value limit varies depending on the value set for [Output Resolution]. <p>Click [] to change the orientation of the output size between landscape and portrait. This button is inaccessible when [Flexible] is selected.</p>
[Data Size]	<p>Display the data size of the image scanned using the specified settings.</p>

Image Settings

[Auto Tone]	<p>When [On] is selected, the colors of the image are automatically adjusted. This setting has no effect when no image is displayed in the preview area.</p>
-------------	--

	<div style="background-color: #e1f5fe; padding: 10px; border: 1px solid #ccc;"> <p> NOTE</p> <p>Condition to specify the settings This setting is available when [Color], [Color (Documents)], or [Grayscale] is selected in [Color Mode].</p> </div>
<p>[Reduce Dust and Scratches]</p>	<p>Minimize dust and scratches of the photo.</p> <ul style="list-style-type: none"> • [None] No dust and scratches are minimized. • [Low] Remove only a small amount of dust and scratches. • [Medium] This setting is best recommended in most cases. • [High] Remove large dust spots and scratches of the photo. Note that this setting may remove subtle details of the image. <div style="background-color: #e1f5fe; padding: 10px; border: 1px solid #ccc; margin-top: 10px;"> <p> NOTE</p> <p>Condition to specify the settings This setting can be enabled when: [Color], [Color (Documents)], or [Grayscale] is selected for [Color Mode].</p> </div>
<p>[Fading Correction]</p>	<p>Correct the fading of the image, as well as increase saturation to enhance obscure, tinted images. This setting is unselectable when no image is displayed in the preview area.</p> <ul style="list-style-type: none"> • [None] No fading correction is made. • [Low] Make low-level fading correction. • [Medium] This setting is best recommended in most cases. • [High] Make extensive fading correction. Note that this setting may change the tone of the image. <div style="background-color: #e1f5fe; padding: 10px; border: 1px solid #ccc; margin-top: 10px;"> <p> NOTE</p> <p>Condition to specify the settings This setting can be enabled when: [Color] or [Color (Documents)] is selected for [Color Mode], and [Recommended] or [Color Matching] is selected for [Color Correction] within the [Preferences] dialog box.  Preferences(P. 144)</p> </div>
<p>[Grain Correction]</p>	<p>Smooth the film grain of the image shot on fast film, to make sure excellent image quality and smooth gradation.</p> <ul style="list-style-type: none"> • [None] No film grain correction is made. • [Low] This setting is best recommended for images showing little noticeable banding. • [Medium] This setting is best recommended in most cases. • [High] Smooth the film grain extensively. Note that this setting may deteriorate image sharpness and quality.

	<p> NOTE</p> <p>Condition to specify the settings This setting can be enabled when: [Color], [Color (Documents)], or [Grayscale] is selected for [Color Mode].</p> <p>In the preview area This setting is not reflected to the image displayed in the preview area.</p>
[Use Unsharp Mask]	<p>If this option is selected, outline of the image is emphasized, making it sharp. It is effective for scanning photos etc., which have a soft focus.</p> <p> NOTE</p> <p>Condition to specify the settings This setting can be enabled when: [Color], [Color (Documents)], or [Grayscale] is selected for [Color Mode].</p>
[Use Descreen]	<p>Select to reduce the distorted pattern (moire) when scanning printed photographs and pictures.</p> <p> NOTE</p> <p>Condition to specify the settings This setting can be enabled when: [Color], [Color (Documents)], or [Grayscale] is selected for [Color Mode].</p> <p>When [Use Unsharp Mask] is set to [ON] Some moiré patterns may be generated if [Use Descreen] is set to [ON]. If this happens, set [Use Unsharp Mask] to [OFF].</p> <p>To reflect the changes Scan the document again.</p>

Color Settings

Using Color Settings command buttons, you can adjust the brightness and contrast of the entire image, specify highlights and shadows, and adjust the contrast and color balance of the image.

The displayed command buttons vary depending on the setting selected for [Color Mode]. When [Text Enhanced] is selected, no command button is displayed.

When the tone curve/threshold drop-down list is clicked, the dialog box appears to specify the corresponding option. When [Reset] is clicked, all current settings are restored to default settings.

- When [Color], [Color (Documents)], or [Grayscale] is selected for [Color Mode]:

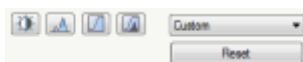

- When [Black and White] is selected for [Color Mode]:

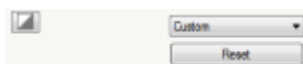



When you select [Add/Delete] from the drop-down menu, you can register a set of color settings. See " **Tone curve/threshold drop-down list(P. 144)** " for more information.

Brightness/Contrast

You can adjust the brightness and contrast level in this dialog box.

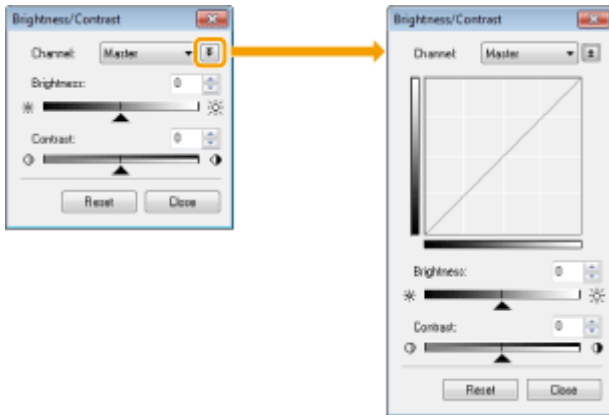
Click [] to adjust the brightness and contrast using the curve on the graph.







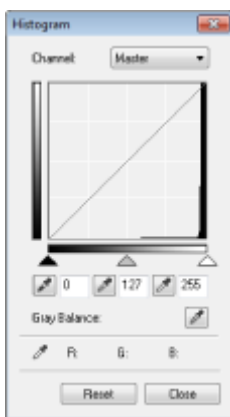

[Channel]	Select [Red], [Green], or [Blue] to adjust each color, or select [Master] to adjust all three colors when [Color] or [Color (Documents)] is selected for [Color Mode]. Adjust gray when [Grayscale] is selected for [Color Mode].
[Brightness]	Adjust the brightness by moving [] on the slider or manually entering values from -127 up to 127.
[Contrast]	Adjust the contrast by moving [] on the slider or manually entering values from -127 up to 127.
[Reset]	Restore all current settings to default settings.

Histogram

You can visually confirm which parts of the image are darker or lighter. You can eliminate the darkest and lightest parts to increase the halftone tonal range.



[Channel]	Select [Red], [Green], or [Blue] to adjust each color, or select [Master] to adjust all three colors when [Color] or [Color (Documents)] is selected for [Color Mode]. Adjust gray when [Grayscale] is selected for [Color Mode].
[] (Black-point eyedropper tool)	Click to move the tool to the part of the image (or the selected scan area) in the preview area that you want to be the darkest part. You can also manually enter a value from 0 up to 245 or move [] on the slider.

[] (Mid-point eyedropper tool)	Click to move the tool to the part of the image (or the selected scan area) in the preview area that you want to be halftone. You can also manually enter a value from 5 up to 250 or move [] on the slider.
[] (White-point eyedropper tool)	Click to move the tool to the part of the image (or the selected scan area) in the preview area that you want to be the lightest part. You can also manually enter a value from 10 up to 255 or move [] on the slider.
[] (Gray Balance eyedropper tool)	For color images, click to move the tool to the part of the image (or the selected scan area) in the preview area that you want to adjust gray balance. Grays in the scanned image become halftone, while other original colors are faithfully reproduced.
[Reset]	Restore all current settings to default settings.

Tone Curve Settings

You can adjust the brightness of a specific part of the image by selecting your choice of tone curve in this dialog box.

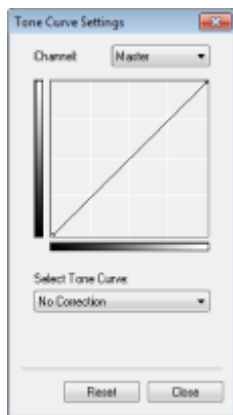

[Channel]	Select [Red], [Green], or [Blue] to adjust each color, or select [Master] to adjust all three colors when [Color] or [Color (Documents)] is selected for [Color Mode]. Adjust gray when [Grayscale] is selected for [Color Mode].
[Select Tone Curve]	Select the tone curve type from [No Correction], [Over Exposure], [Under Exposure], [High Contrast], and [Invert the Negative/Positive Image].
[Reset]	Restore all current settings to default settings.

Final Review

You can confirm all the specified color settings in this dialog box.

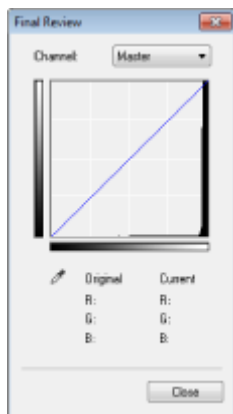

Threshold

You can adjust the threshold setting. By adjusting the threshold, you can sharpen text within the document and reduce print-through that often happens to newspapers.

NOTE

Threshold

The brightness of color and gray images can be specified as a value from 0 up to 255, while the brightness of black and white images is expressed in black and white including all shades between black and white. A threshold is the boundary to define whether images are black or white.



[Threshold Level]	Adjust the threshold level by moving [▲] on the slider or manually entering a value from 0 up to 255.
[Reset]	Restore all current settings to default settings.

Tone curve/threshold drop-down list

You can save the color settings specified for scan areas. If there are no specific scan areas, the settings specified for the entire image displayed in the preview area are saved. You can also recall the saved settings to apply to the selected scan area.

[Custom]	You can custom-define each setting. The settings can be modified after these settings were applied to the image.
[Add/Delete]	Display the [Add/Delete Threshold Settings] dialog box when [Black and White] is selected for [Color Mode] in the [Add/Delete Tone Curve Settings] dialog box. You can register the current settings set for the image in the preview area under a specified name.

Preferences

The [Preferences] dialog box appears when [Preferences] is clicked in the [Advanced Mode] tab. You can change the scan and preview settings within this dialog box.

[Preview] tab

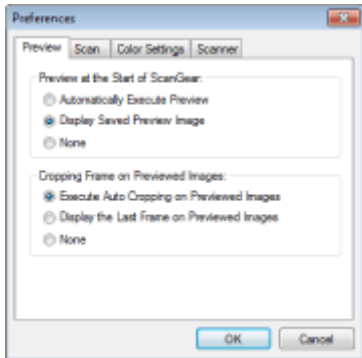

<p>[Preview at the Start of ScanGear]</p>	<p>Select the preview mode when you start the ScanGear MF.</p> <ul style="list-style-type: none"> • [Automatically Execute Preview] The preview starts automatically when the ScanGear MF is started. • [Display Saved Preview Image] Display the last previewed image. • [None] No preview image is displayed.
<p>[Cropping Frame on Previewed Images]</p>	<p>Specify how you want the scan area displayed within the image displayed in the preview area.</p> <ul style="list-style-type: none"> • [Execute Auto Cropping on Previewed Images] The scan area is automatically selected and scaled to fit to the document size. • [Display the Last Frame on Previewed Images] Display the scan area last defined. • [None] No frame is displayed.

[Scan] tab

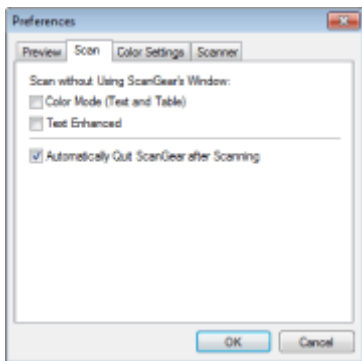

<p>[Scan without Using ScanGear's Window]</p>	<p>Documents are scanned using application-defined settings when scanning using applications such as OCR software that performs scans without opening the ScanGear MF main window. To perform a scan in a specific color mode instead of using the application-defined settings, specify this option.</p> <ul style="list-style-type: none"> • [Color Mode (Text and Table)] The document is scanned in [Color (Documents)] mode. Application-defined settings are disregarded. • [Text Enhanced] The document is scanned in [Text Enhanced] mode. Application-defined settings are disregarded.
---	--

<p>[Automatically Quit ScanGear after Scanning]</p>	<p>When this setting is selected, the [ScanGear MF] dialog box closes automatically when scanning is complete. Depending on the application in use, the ScanGear MF closes automatically when scanning is complete, irrespective of application-defined settings.</p>
---	---

[Color Settings] tab

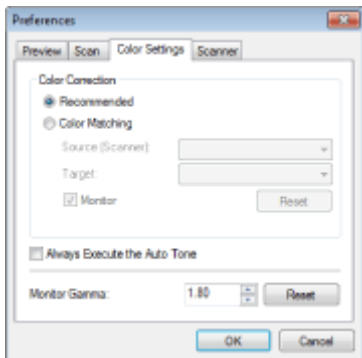

<p>[Color Correction]</p>	<p>Select the color correction type.</p> <ul style="list-style-type: none"> • [Recommended] Reproduce vividly the colors of a document displayed on the screen. • [Color Matching] Automatically match the colors of the image to those of the scanner, monitor, and color printer. When this option is selected, the color command buttons in the [Advanced Mode] tab are disabled. This setting is selectable only when [Color] or [Color (Documents)] is selected for [Color Mode].
<p>[Always Execute the Auto Tone]</p>	<p>Always correct the colors of the image automatically. This setting is selectable only when [Color], [Color (Documents)] or [Grayscale] is selected for [Color Mode].</p>
<p>[Monitor Gamma]</p>	<p>Adjust the gamma. You can specify the gamma value from 0.10 up to 10.00 for the monitor which displays the scanned image. This setting is not reflected to the scan result when [Black and White] is selected for [Color Mode].</p> <div style="background-color: #e0f0e0; padding: 10px; margin-top: 10px;"> <p> NOTE</p> <p>When [Color Matching] is selected for [Color Correction] The value specified in the profile is applied to scanning results.</p> </div>

[Scanner] tab

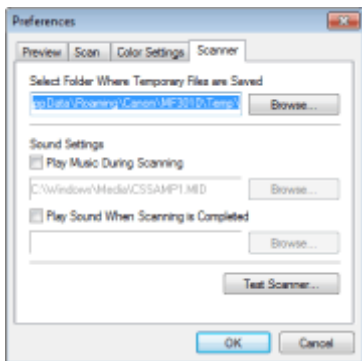

<p>[Select Folder Where Temporary Files are Saved]</p>	<p>Specify the folder where scanned images are temporarily saved. Click [Browse] to specify the folder.</p>
--	---

Scan

[Sound Settings]	<p>Set the scanner to play music during scanning or when scanning is complete.</p> <ul style="list-style-type: none">• [Play Music During Scanning] Music is played during scanning. Click [Browse] and specify the sound file.• [Play Sound When Scanning is Completed] Music is played when scanning is completed. Click [Browse] and specify the sound file. <p>The following file formats are supported:</p> <ul style="list-style-type: none">• MIDI files (*.mid, *.rmi, *.midi)• Audio files (*.wav, *.aif, *.aiff)• MP3 file (*.mp3)
[Test Scanner]	<p>You can check to see if the scanner is functioning properly. The [Scanner Diagnostics] dialog box appears when this button is clicked. Click [Start].</p>

Defining a Scan Area (Cropping Frame)

You can select or deselect scan frames (cropping areas) for images displayed in the preview area.

- ▶ **Selecting the cropping area automatically(P. 148)**
- ▶ **Defining a cropping frame(P. 148)**
- ▶ **Defining multiple cropping frames(P. 148)**
- ▶ **Deleting cropping frames(P. 149)**

Selecting the cropping area automatically

- 1 Display the preview.**
- 2 Click [] (Auto Crop) on the toolbar.**

Every time this button is clicked, the selected cropping frame becomes smaller.

Defining a cropping frame

- 1 Display the image in the preview area.**
- 2 Click [] (Crop) on the toolbar.**
- 3 Click on the preview image and drag around the contours/border of the area you want to select.**
 - To adjust the selected area
Drag around the contours/border of the area or manually enter the width and height for [Input Settings] in the [Advanced Mode] tab.
 - To move the scan area
Click the inside rim of the scan area and drag it.

NOTE

To maintain height-width proportions of the original image

Click [] in [Input Settings].

When scanning from the feeder

The current cropping frame is deleted when new one is defined.

Defining multiple cropping frames

You can define multiple cropping frames.

- 1 Display the image in the preview area.**
- 2 Click  (Crop) on the toolbar.**
- 3 Click on the preview image and drag around the contours/border of the area you want to select.**
- 4 Click the outer rim of the cropping frame already defined and drag the frame to add.**

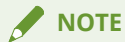
**NOTE****The number of cropping frames that can be specified**

Up to 10 cropping frames can be specified.

5 Adjust the cropping frames as needed.

Click to select the cropping frames you want to adjust.

Deleting cropping frames

To delete a cropping frame, click the outer rim of the cropping frame already defined and drag the frame to add.

- Press [Delete] on the keyboard.
- Click  (Remove Cropping Frame) on the toolbar.
- Right-click on the cropping frame and select [Delete].
- Hold down [Ctrl] on the keyboard, right-click the outer rim of the cropping frame, and select [Delete].

Setting Resolution

85RS-03E

A scanned image is a group of dots which contain color and brightness information. The density of these dots is called the "resolution". The "dpi (dots per inch)" means the maximum dots a printer can print per inch. Set the resolution by specifying the following options.

MF Toolbox -> [Image Quality]

ScanGearMF -> the advanced mode tab -> [Output Resolution]

To display the scanned image on a monitor

Images are scanned at a resolution of 75 dpi, which is a typical monitor resolution.

To print from the printer

Scan the document at the printer's resolution.

IMPORTANT

To print the scanned image by scaling (enlarging/reducing)

If you print the scanned image by doubling its current size, for example, the actual resolution decreases by half. To maintain sufficient print quality, you need to double the resolution, and vice versa.

Resolution and data size

If the resolution is doubled, the image size becomes four times larger. If the data size becomes too large, it may take considerably longer to process the image, consequently causing an insufficient memory error as well as other unexpected errors. To prevent this from happening, specify the minimum allowable resolution based on your purpose of the scan.

NOTE

When printing the scanned image from a color printer

As a color printer uses several different color inks to reproduce colors, the resolution can be decreased by half.

About the scanning resolution

The maximum resolution is as following.

- Optical resolution: 600 dpi
- Software interpolated resolution: 9600 dpi

Troubleshooting

Troubleshooting	152
Clearing Jams	153
Removing Jammed Paper	155
Troubleshooting	160
Paper Feeding Problems	162
Cannot Print, or the Images on Printouts are Spotted or Distorted	163
Copying Problems	164
The Copy Output is Hardly Readable and Copied Poorly	165
Printing Problems	166
Cannot Print Documents from a Computer	167
Scanning Problems	168
Cannot Scan a Document	170
Installation and Uninstallation Problems	172
Miscellaneous Problems	173
Printing Results are Not Good	174
Paper Curls	175
Paper Creases	176
Printing is Uneven	177
White Specks or Spots Appear on the Printout	178
The Toner does Not Flow Well into the Paper	179
Vertical Streaks Appear on the Output	180
Toner Smudges and Spatters Appear around Text and Images	181
The Printout is Too Dark	182
Printed Bar Codes Cannot be Scanned	183
Images may be partially cut off on the output	184
Uninstalling the Software	185
When a Service Error Has Occurred	188
When a Problem cannot be Resolved	189

Troubleshooting

85RS-03F

This chapter describes how to handle paper jams and printout problems.

Clearing jams	See " Clearing Jams(P. 153) ."
When a problem has occurred (Read this section before requesting service.)	See " Troubleshooting(P. 160) ."
When print quality is not good	See " Printing Results are Not Good(P. 174) ."
When you want to uninstall the software	See " Uninstalling the Software(P. 185) ."
When the problem cannot be resolved after referring to the appropriate trouble shooting section	See " When a Problem cannot be Resolved(P. 189) ."

Clearing Jams

85RS-03H

If the [] indicator is blinking, a paper jam occurs inside the printer. Follow the procedures in this section to remove the jammed paper.

▶ " Removing Jammed Paper(P. 155) "

⚠ WARNING

When removing the jammed paper

Use caution to avoid cutting your hands.

When removing jammed paper or when inspecting the inside of the machine

Do not allow necklaces, bracelets, or other metal objects to touch the inside of the machine, as this may result in burns or electrical shock.

⚠ CAUTION

If loose toner comes into contact with your skin or clothing

Wash with cold water only. Avoid warm water, as this will set the toner and cause it to stain your skin or clothing.

When removing the jammed paper

- Remove the paper carefully so that no paper fragments remain inside the machine. Also, do not put your hands in areas other than those described in the procedure. Doing so may result in injury or burns.
- Do not forcibly remove the jammed paper from the machine. Forcibly removing the paper may result in personal injury or damage parts of the machine.
 - If you cannot remove the paper, contact your local authorized Canon dealer.
- When all paper jams have been cleared, immediately remove your hands from the machine so that your clothing and hands do not get caught in the rollers.

Do not touch the fixing unit (A).

Touching the fixing unit (A) may cause burns as it becomes very hot during use.

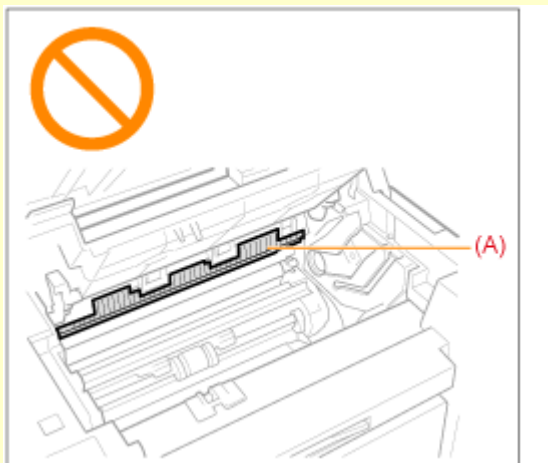

 **IMPORTANT**

Cautions when clearing paper jams

- When clearing paper jams, do not turn the power OFF. Data being printed is erased when you turn the power OFF.
- When the paper gets torn, be sure to remove it so that no pieces remain.

If the jammed paper is torn

Remove all torn pieces of paper to avoid further jams.

If paper jams occur repeatedly

Check the following.

- Fan the paper stack and tap the edge on a flat surface to align the paper before loading it into the machine.
- Make sure that the paper you are using meets the requirements for use.
- ▶ **" Supported Paper Types(P. 70) "**
- Make sure that you have removed all scraps of paper from the inside of the machine.

Do not touch the transfer roller (A).

Touching the transfer roller (A) may damage the machine.

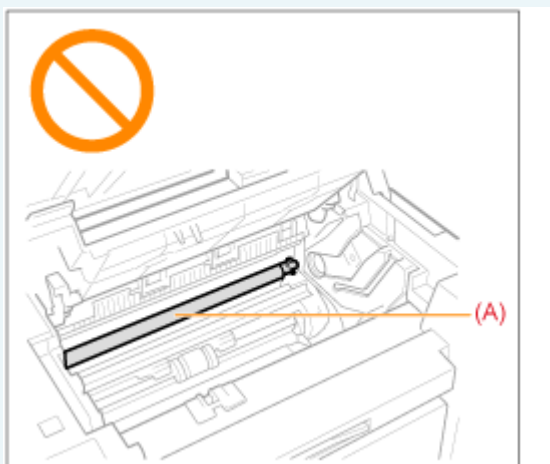
 **NOTE**

Do not force the jammed paper out of the machine.

Contact your local authorized Canon dealer or the Canon help line for assistance, if needed.

Removing Jammed Paper

85RS-03J

Follow onscreen instructions to remove jammed paper.

Inside the printer

1 Hold the operation panel.

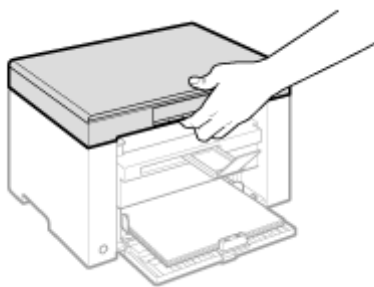

2 Lift the scanning platform.

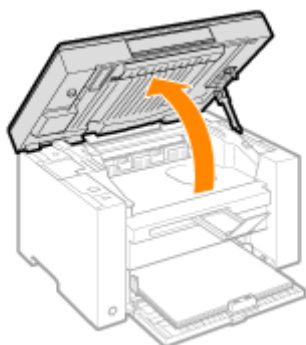

When you cannot lift the scanning platform

Make sure that the platen glass is completely closed.

Do not try to forcefully lift the scanning platform, as this may damage the machine.

- ※ The platen glass may not be completely closed when a thick document such as books is placed inside. In such case, remove it from the platen glass.

3 Hold the grip on the left front side of the toner cover.

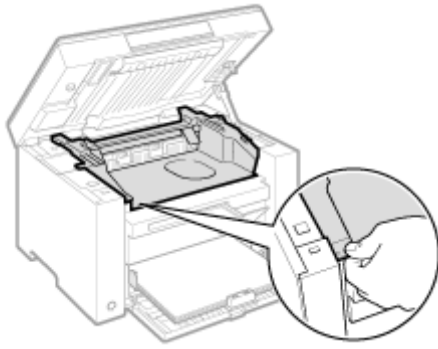

4 Open the toner cover.

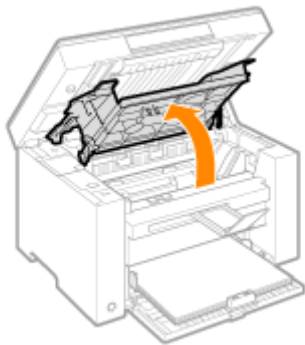

5 Remove the toner cartridge.

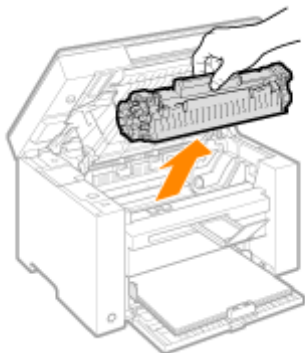

6 Remove the jammed paper by pulling it out gently.

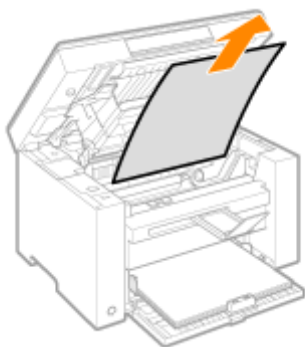

When the leading edge of the jammed paper is not visible

Do not pull out the paper forcibly and proceed to Step 7(P. 157) .

7 Remove the jammed paper by pulling it out gently.

- (1) Gently pull any jammed paper downward from the space between the fixing unit (A) and roller (B) until the leading edge emerges from the machine.

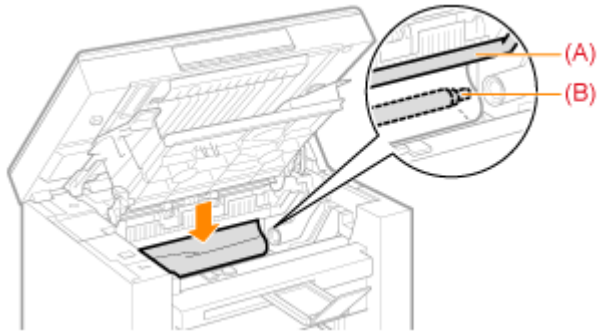

- (2) When the leading edge emerges, hold both sides of the jammed paper and carefully pull it out.

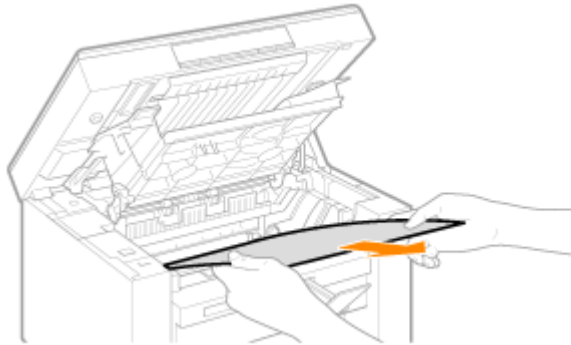

8 Reload paper into the paper cassette.

9 Insert the toner cartridge.

Fit the protrusions (A) on both sides of the toner cartridge into the guides located on both sides of the machine and slide the toner cartridge into the machine until the toner cartridge comes to rest and is held against the back of the machine.

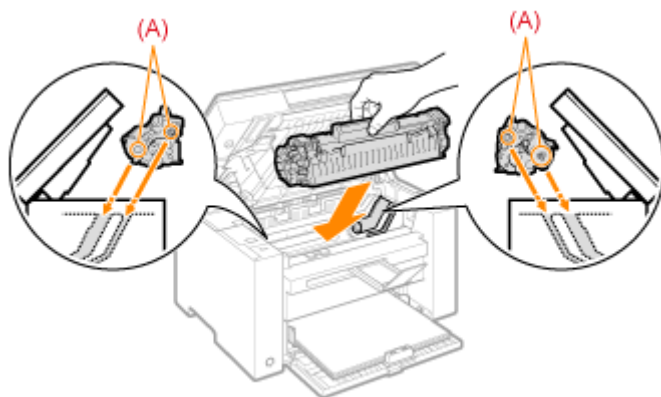

10 Close the toner cover.

When you cannot close the toner cover

Make sure that the toner cartridge is properly set inside the machine.
Do not try to forcefully close the toner cover, as this may damage the machine.

11 Lower the scanning platform.

The machine is ready to print.

Paper cassette

1 Remove the paper loaded in the paper cassette.

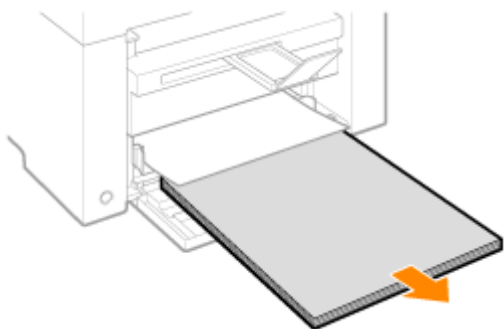

2 Remove the jammed paper by pulling it out gently.

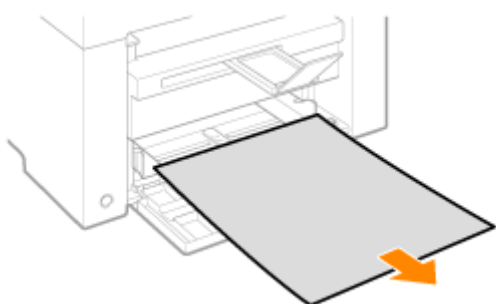

3 Load paper in the paper cassette.

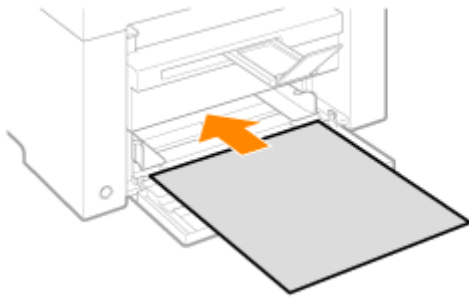

Troubleshooting

85RS-03K

If a problem occurs while the machine is in use, try the actions suggested in this section before contacting technical support.

Check the following first.

- ▶ **Is the power switched ON?(P. 160)**
- ▶ **Has the power switch been just turned ON?(P. 160)**
- ▶ **Is the machine in the sleep mode?(P. 160)**
- ▶ **Are the [Paper Jam] or [Paper] Indicators blinking?(P. 160)**
- ▶ **Is anything other than "1" displayed?(P. 161)**
- ▶ **Do an "E" and a subsequent three-digit number repeatedly appear on the display?(P. 161)**

Is the power switched ON?

Make sure that the power cord is securely plugged into the machine and into the wall outlet.

▶ See the Starter Guide.

Make sure that electricity is supplied from the power cord.

Use another power cord or check to see if the cord is broken using a voltmeter.

Turn OFF and ON the power switch.

▶ See the Starter Guide.

If this works, proceed to " **Has the power switch been just turned ON?(P. 160)** "

Has the power switch been just turned ON?

Wait a few seconds until the machine starts and warms up.

If this works, proceed to " **Is the machine in the sleep mode?(P. 160)** "

Is the machine in the sleep mode?

Press any key on the operation panel to return from the sleep mode.

If this works, proceed to " **Are the [Paper Jam] or [Paper] Indicators blinking?(P. 160)** "

Are the [Paper Jam] or [Paper] Indicators blinking?

Make sure that paper is loaded properly in the paper cassette.

▶ " **Loading Paper(P. 46)** "

Check to see if there is a jam somewhere inside the machine.

▶ " **Clearing Jams(P. 153)** "

If this works, proceed to " **Is anything other than "1" displayed?(P. 161)** "

Is anything other than "1" displayed?

See the following section and check the display contents and the actions.

▶ " **Operation Panel and Display(P. 25)** "

Do an "E" and a subsequent three-digit number repeatedly appear on the display?

Some sort of error has occurred in the printer.

Turn OFF the power switch, wait at least 10 seconds, and then turn it ON again. If the problem is not solved, write down the three-digit number that is displayed, turn OFF the main power switch, disconnect the power cord, and contact the Canon help line.

If you continue to experience problems after trying the actions suggested in this section, see the following sections to solve the problems.

- ▶ " **Paper Feeding Problems(P. 162)** "
- ▶ " **Copying Problems(P. 164)** "
- ▶ " **Printing Problems(P. 166)** "
- ▶ " **Scanning Problems(P. 168)** "
- ▶ " **Installation and Uninstallation Problems(P. 172)** "
- ▶ " **Miscellaneous Problems(P. 173)** "

Paper Feeding Problems

85RS-03L

- ▶ Paper is not fed at all, or more than one sheet is fed simultaneously (multi-feeds).(P. 162)
- ▶ Paper jams occur repeatedly.(P. 162)

Paper is not fed at all, or more than one sheet is fed simultaneously (multi-feeds).

Make sure that the paper is properly loaded.

▶ " Loading Paper(P. 46) "

Make sure that the number of sheets or the paper type loaded in the paper cassette meets the paper specifications.

▶ " Supported Paper Types(P. 70) "

Make sure to load the same size and type of paper into the paper cassette.

Paper jams occur repeatedly.

Make sure that the paper is properly loaded.

▶ " Loading Paper(P. 46) "

Make sure that the number of sheets or the paper type loaded in the paper cassette meets the paper specifications.

▶ " Supported Paper Types(P. 70) "

Make sure that the scanning platform is fully closed.

Cannot Print, or the Images on Printouts are Spotted or Distorted

85RS-03R

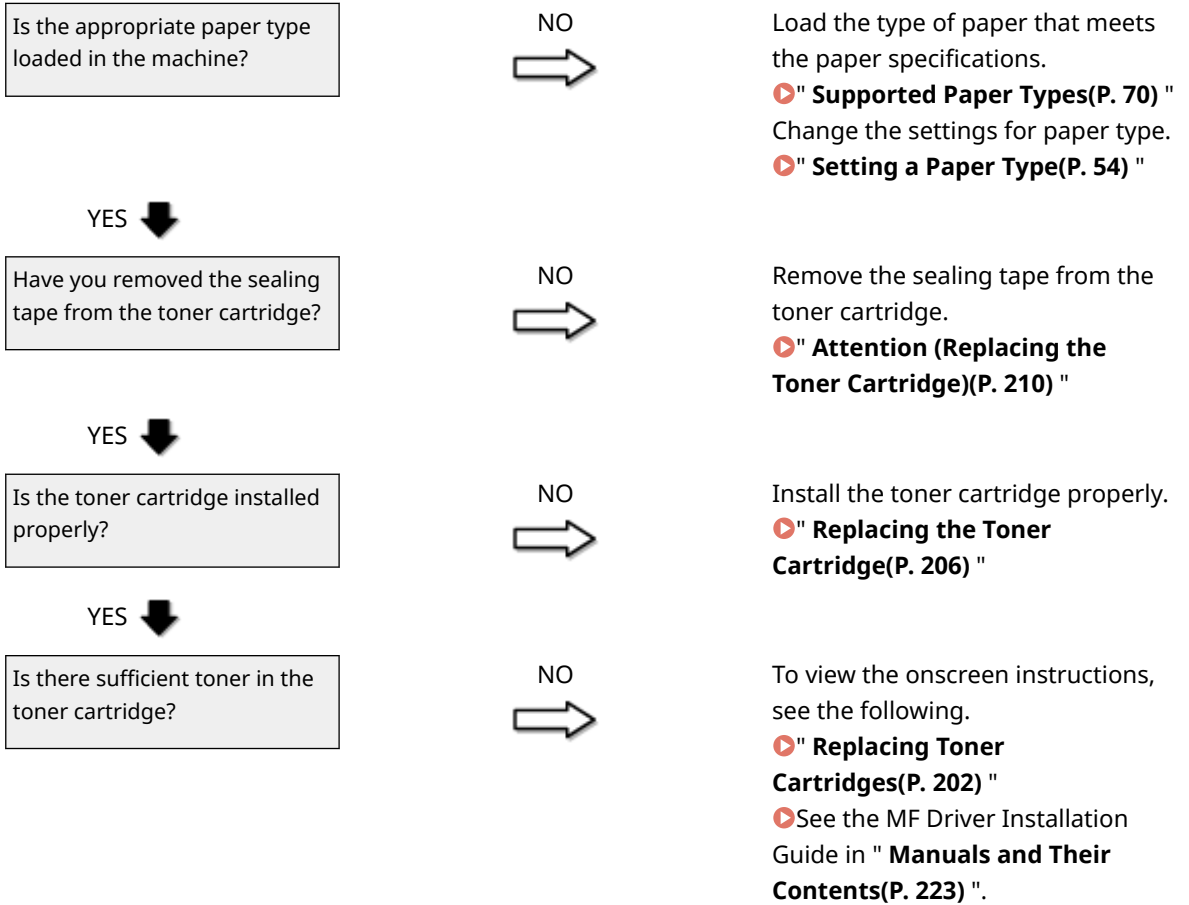

Copying Problems

85RS-03S

See the following sections.

- ▶ **The copy output is hardly readable and copied poorly.(P. 164)**
- ▶ **The copy output is askew.(P. 164)**

The copy output is hardly readable and copied poorly.

- The copy output is too light or has uneven density.
- Vertical white streaks appear on the copy output.
- The copy output has spots and is dirty.
- The copy output is askew.
- Toner does not fix onto paper well.

See the following section.

- ▶ **" The Copy Output is Hardly Readable and Copied Poorly(P. 165) "**

The copy output is askew.

Make sure that the number of sheets or the paper type loaded in the paper cassette meets the paper specifications.

- ▶ **" Supported Paper Types(P. 70) "**

Adjust the paper guides to the paper width without space. If the problem persists, load paper with the other side face up, or in an opposite orientation.

- ▶ **" Loading Paper(P. 46) "**

Make sure that the output tray is not full.

The Copy Output is Hardly Readable and Copied Poorly

85RS-03U

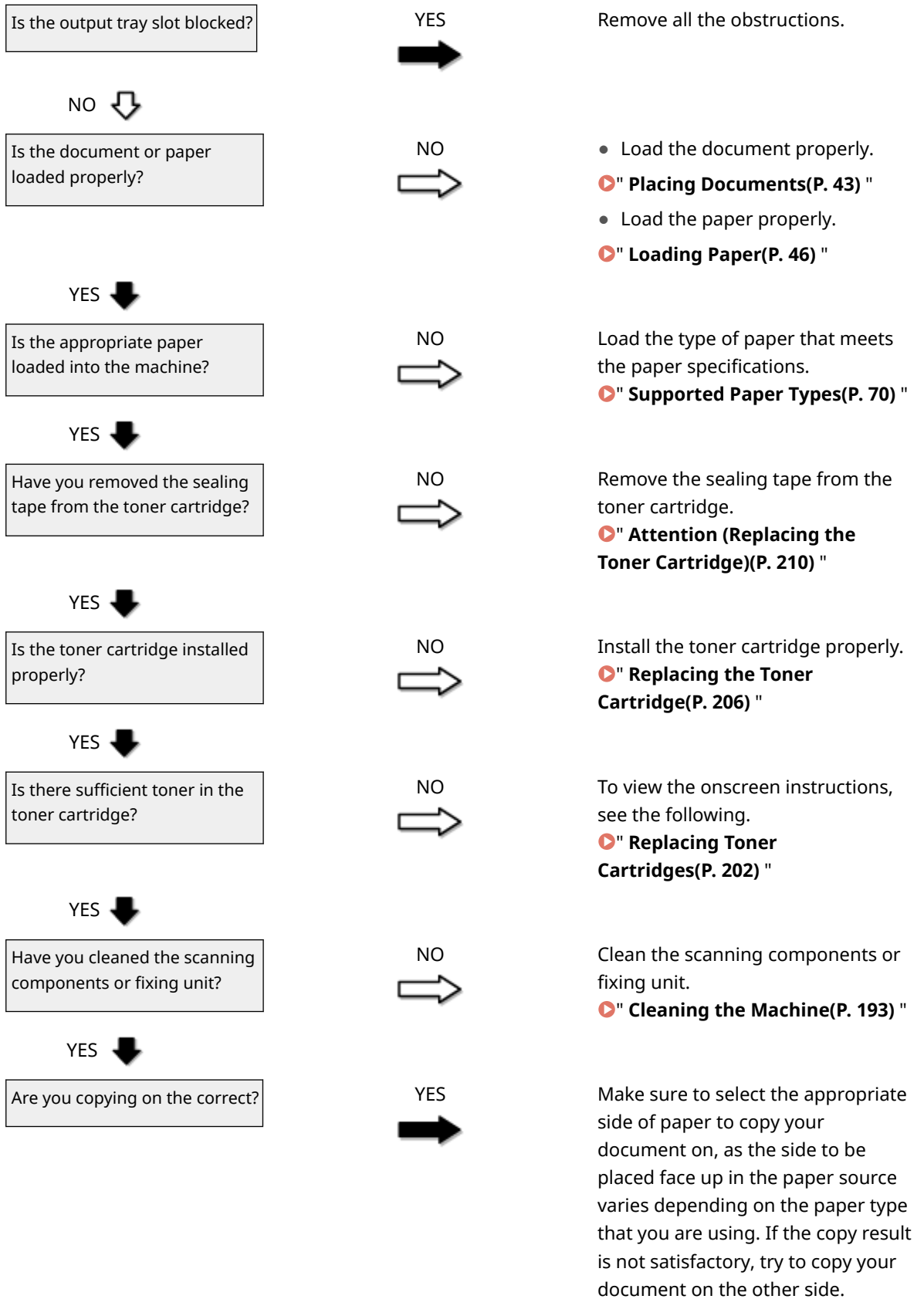

Printing Problems

85RS-03W

See the following sections.

- ▶ **The printout is hardly readable and printed poorly.(P. 166)**
- ▶ **The printout is printed askew.(P. 166)**
- ▶ **Cannot print documents from a computer.(P. 166)**

The printout is hardly readable and printed poorly.

- The printout is too light or has uneven density.
- Vertical white streaks appear on the printout.
- The printout has spots and is dirty.
- The printout is askew.
- The toner does not flow well into the paper.

See the following section:

- ▶ **" The Copy Output is Hardly Readable and Copied Poorly(P. 165) "**

The printout is printed askew.

Make sure that the number of sheets or the paper type loaded in the paper cassette meets the paper specifications.

- ▶ **Supported Paper Types(P. 70)**

Adjust the paper guides to the paper width without space. If the problem persists, load paper with the other side face up, or in an opposite orientation.

- ▶ **Loading Paper(P. 46)**

Make sure that the output tray is not full.

Cannot print documents from a computer.

See the following section:

- ▶ **" Cannot Print Documents from a Computer(P. 167) "**

Cannot Print Documents from a Computer

85RS-03X

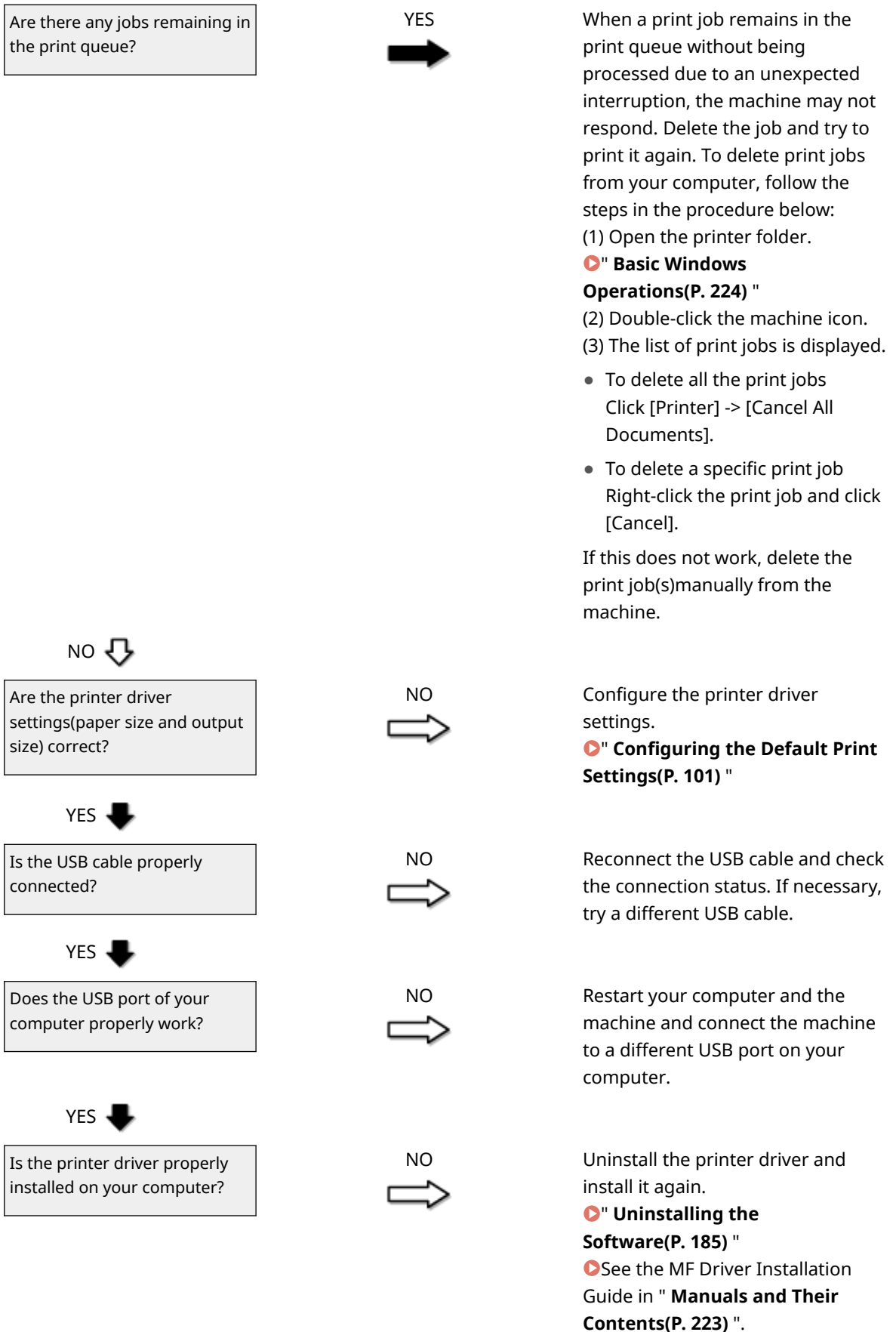

Scanning Problems

85RS-03Y

See the following sections.

- ▶ **Cannot scan a document.(P. 168)**
- ▶ **Cannot scan multiple documents to create a combined multi-page PDF file.(P. 168)**
- ▶ **During scanning, a computer connected to the machine freezes or is disconnected.(P. 168)**
- ▶ **In the event that applications installed from the User Software CD-ROM that comes with the machine are not properly registered in the MF Toolbox.(P. 169)**
- ▶ **A different application opens when you want to scan a document.(P. 169)**
- ▶ **Scanned images are spotted or distorted.(P. 169)**
- ▶ **A scanned image is displayed larger (or smaller) than its actual size on the computer screen.(P. 169)**
- ▶ **Cannot scan highlighting marks.(P. 169)**

Cannot scan a document.

Refer to the following section:

- ▶ **" Cannot Scan a Document(P. 170) "**

Cannot scan multiple documents to create a combined multi-page PDF file.

Start ScanGear MF, access the Preferences dialog box, and clear the check box next to [Automatically Quit ScanGear after Scanning] before you perform a scan. When this check box is selected, you can only perform a scan from the platen glass.

During scanning, a computer connected to the machine freezes or is disconnected.

Quit all running applications to increase the memory usage.

Make sure that the machine has sufficient free hard disk space when scanning documents at a high resolution. To scan an A4-sized document at a resolution of 600 dpi in full color, for example, a minimum of 300 MB of free space is required.

If an error occurs while scanning a specific image for Photoshop, access the [Edit] menu, select [Preferences], and click [Memory & Image Cache]. Set [Memory Usage] somewhere between 50 and 60 %.

The scanner driver may not be installed properly. Uninstall the software and install it again.

- ▶ **Uninstalling the Software(P. 185) "**
- ▶ See the MF Driver Installation Guide in **" Manuals and Their Contents(P. 223) "**.

In the event that applications installed from the User Software CD-ROM that comes with the machine are not properly registered in the MF Toolbox.

Applications are automatically registered to the MF Toolbox once they have been installed. They are not, however, if installed while the MF Toolbox is open. To access these applications from the toolbox, you need to manually register them to the toolbox.

▶ **" Using the MF Toolbox(P. 124) "**

A different application opens when you want to scan a document.

Register the appropriate application in the MF Toolbox.

▶ **" Using the MF Toolbox(P. 124) "**

Scanned images are spotted or distorted.

Clean the platen glass and feeder's scanning area.

Scanned images cannot be displayed correctly if displayed smaller than the actual size, depending on the application. Scale the images to 100 %.

Set the display colors to "High Color (16-bit or 24-bit)" or higher in [Display Properties].

A scanned image is displayed larger (or smaller) than its actual size on the computer screen.

Try one of the following to set the appropriate resolution.

- Enlarge or reduce the image size in the application that you are using. In an application such as MS Paint or Imaging, an image may be displayed larger than its actual size and cannot be scaled down.
- To solve this problem, scan the image again at a different resolution. If scanned at a higher resolution, the image is displayed larger than its actual size, and vice versa.

▶ **" Setting Resolution(P. 150) "**

Cannot scan highlighting marks.

Start the ScanGear MF, access [Advanced Mode], and set [Color Correction] to [Color Matching].

▶ **" Using Advanced Mode(P. 136) "**

Cannot Scan a Document

85RS-040

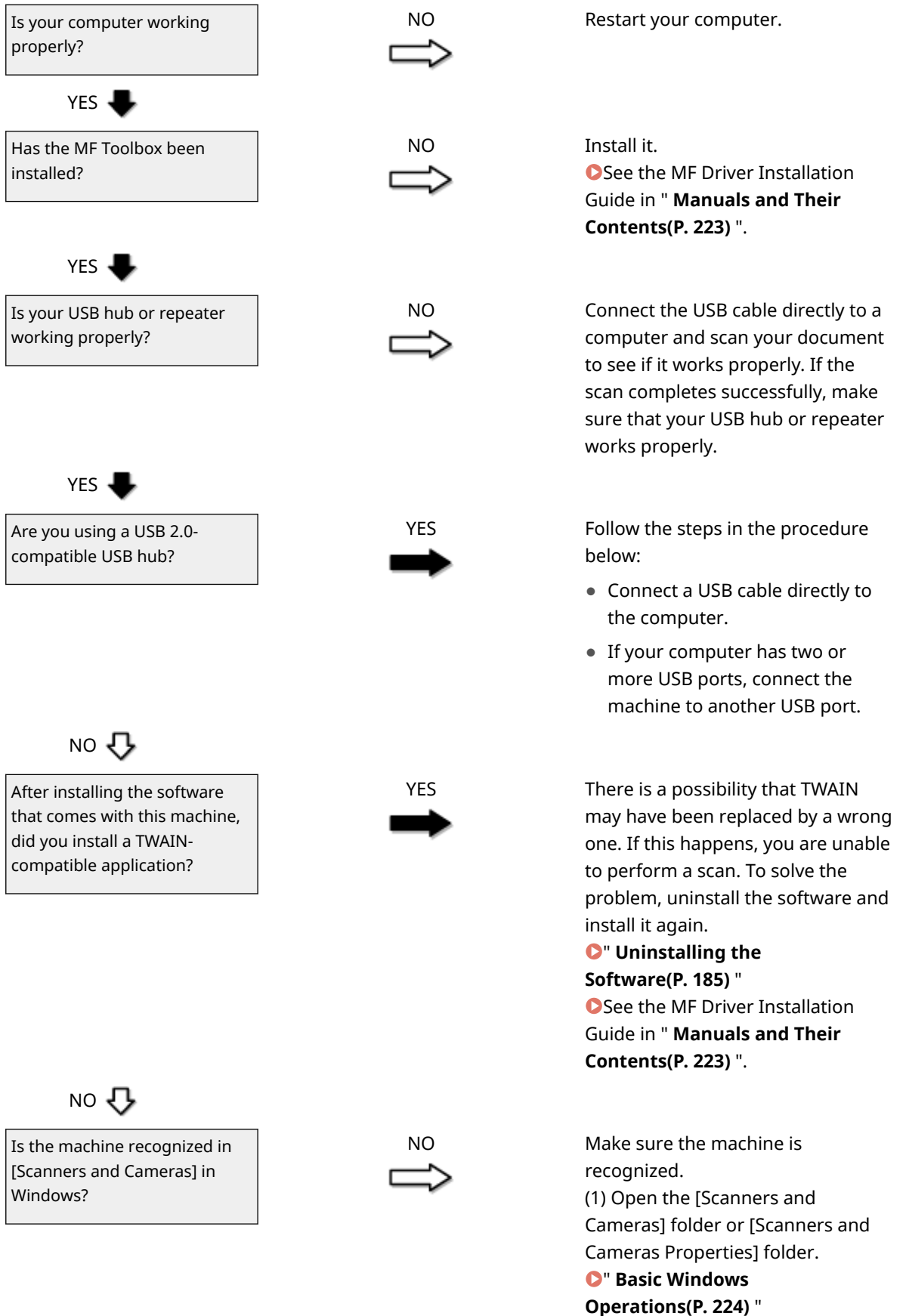

(2) The machine is recognized when the driver for the machine is displayed. If not, uninstall the software and install it again.

▶ **" Uninstalling the Software(P. 185) "**

▶ See the MF Driver Installation Guide in **" Manuals and Their Contents(P. 223) "**.

Installation and Uninstallation Problems

85RS-041

See the following sections.

- ▶ **Cannot install the software.(P. 172)**
- ▶ **The [Canon] folder remains in the Start menu after the software has been uninstalled.(P. 172)**
- ▶ **Cannot use the software after upgrading the operating system.(P. 172)**

Cannot install the software.

Follow the onscreen instructions to install the software. If an error occurs during the installation, uninstall the software, restart your computer, and install it again.

- ▶ **" Uninstalling the Software(P. 185) "**
- ▶ See the MF Driver Installation Guide in " **Manuals and Their Contents(P. 223) "**.

Quit all running applications and install the software again.

The [Canon] folder remains in the Start menu after the software has been uninstalled.

Uninstall the MF Toolbox first before uninstalling the MF drivers. If you uninstall the MF drivers first, the [Canon] folder may remain after the MF Toolbox has been uninstalled. Follow the steps in the procedure below to remove the folder:

- **For Windows 7**
 - Delete the [Canon] folder in [All Programs] under the [Start] menu.

Cannot use the software after upgrading the operating system.

Uninstall the software for this machine before upgrading the operating system on your computer. Once the upgrade has been complete, reinstall the software.

- ▶ **" Uninstalling the Software(P. 185) "**
- ▶ See the MF Driver Installation Guide in " **Manuals and Their Contents(P. 223) "**.

Miscellaneous Problems

85RS-042

See the following sections.

- ▶ **Steam is emitted from the machine's output area.(P. 173)**
- ▶ **Water droplets form on the back side of the operation panel and in the output area.(P. 173)**
- ▶ **The settings that you specified are not enabled or saved.(P. 173)**

Steam is emitted from the machine's output area.

Use only in the machine. Moisture evaporates from damp paper due to the heat generated inside the fixing unit (it is most likely to occur at low room temperatures). This is not a malfunction, but you can prevent this by using a stack of new unopened paper.

Should you smell something burning, immediately turn OFF the machine, unplug the power plug from the AC power outlet, and contact your local authorized Canon dealer or the Canon help line. Continued use may lead to a fire or electrical shock.

Water droplets form on the back side of the operation panel and in the output area.

Use only in the machine. Moisture evaporates from damp paper due to the heat generated inside the fixing unit (it is most likely to occur at low room temperatures). This is not a malfunction, but you can prevent this by using a stack of new unopened paper.

Should you smell something burning, immediately turn off the machine, unplug the power plug from the AC power outlet, and contact your local authorized Canon dealer or the Canon help line. Continued use may lead to a fire or electrical shock.

The settings that you specified are not enabled or saved.

If the machine is turned OFF immediately after changes have been made to the settings from the operation panel, the changes may not be saved on the machine.

Wait for approximately five seconds after changes have been made to the settings and turn OFF the machine.

Printing Results are Not Good

85RS-043



Paper curls or creases.

- ▶ " Paper Curls(P. 175) "
- ▶ " Paper Creases(P. 176) "



Unevenness or smudge marks appears.

- ▶ " Printing is Uneven(P. 177) "
- ▶ " White Specks or Spots Appear on the Printout(P. 178) "
- ▶ " The Toner does Not Flow Well into the Paper(P. 179) "
- ▶ " Vertical Streaks Appear on the Output(P. 180) "
- ▶ " Toner Smudges and Spatters Appear around Text and Images(P. 181) "
- ▶ " The Printout is Too Dark(P. 182) "



Others

- ▶ " Printed Bar Codes Cannot be Scanned(P. 183) "
- ▶ " Images may be partially cut off on the output(P. 184) "

NOTE

To contact your local authorized Canon dealer

When a problem occurs that is not suggested in the User's Guide, or a problem persists if you follow the instructions, or you cannot determine the nature of the problem, contact your local authorized Canon dealer.

Paper Curls

85RS-044



Try one of the following to solve the problem.

<Cause 1> Damp paper is used.

Solution 1	Replace the paper stack with new unopened one. ● " Supported Paper Types(P. 70) "
Solution 2	Follow the steps in the procedure below when plain paper (60 to 90 g/m ² (16 to 24 lb Bond)) is loaded. <ol style="list-style-type: none"> 1. Access the [Page Setup] tab. 2. Set [Paper Type] to [Plain Paper L].
Solution 3	Change the <Special Mode d> setting from the operation panel. ● " Special Mode(P. 213) "

<Cause 2> The paper type loaded is not appropriate.

Solution	Make sure that the number of sheets or the paper type loaded in the paper cassette meets the paper specifications. ● " Supported Paper Types(P. 70) "
-----------------	---

Paper Creases

85RS-045



Try one of the following to solve the problem.

<Cause 1> The paper stack is not loaded correctly.

Solution	Load the paper stack is not loaded correctly. Ⓞ " Loading Paper(P. 46) "
-----------------	--

<Cause 2> Damp paper is used.

Solution	Replace the paper stack with new unopened one. Ⓞ " Supported Paper Types(P. 70) "
-----------------	---

<Cause 3> The paper type loaded is not appropriate.

Solution	Make sure that the number of sheets or the paper type loaded in the paper cassette meets the paper specifications. Ⓞ " Supported Paper Types(P. 70) "
-----------------	---

<Cause 4> There is a foreign object inside the machine.

Solution	Remove the foreign object from the machine.
-----------------	---

<Cause 5> Paper creases due to the paper type used or usage conditions of the machine.

Solution	Change the <Special Mode d> setting from the operation panel. Ⓞ " Special Mode(P. 213) "
-----------------	--

Printing is Uneven

85RS-046



Try one of the following to solve the problem.

<Cause 1> Paper is too moist or Too dry.

Solution	Replace the paper stack with new unopened one. ▶ " Supported Paper Types(P. 70) "
-----------------	--

<Cause 2> Toner is nearly empty.

Solution	To view the onscreen instructions, see the following. ▶ " Replacing the Toner Cartridge(P. 206) "
-----------------	--

<Cause 3> The drum in the toner cartridge is deteriorated.

Solution	Replace the toner cartridge with new one. ▶ " Replacing the Toner Cartridge(P. 206) "
-----------------	--

White Specks or Spots Appear on the Printout

85RS-047



Try one of the following to solve the problem.

<Cause 1> The paper type loaded is not appropriate.

Solution	Make sure that the number of sheets or the paper type loaded in the paper cassette meets the paper specifications. ● " Supported Paper Types(P. 70) "
-----------------	---

<Cause 2> Damp paper is used.

Solution	Replace the paper stack with new unopened one. ● " Supported Paper Types(P. 70) "
-----------------	---

<Cause 3> The drum in the toner cartridge is deteriorated.

Solution	Replace the toner cartridge with new one. ● " Replacing the Toner Cartridge(P. 206) "
-----------------	---

<Cause 4> White specks or spots appear around text and images when a high-contrast document is printed.

Solution	Change the [Special Print Mode] setting to [Special Settings 2] in the printer driver. ● " Special Mode(P. 213) " ※ The density becomes lower with [Special Settings 2] than with [Off] or [Special Settings 1]. Additionally, text and lines may be reproduced less clearly.
-----------------	--

The Toner does Not Flow Well into the Paper

85RS-048



Try one of the following to solve the problem.

<Cause 1> The paper type setting specified is not appropriate.

Solution	Select the appropriate paper type setting. ▶ " Setting a Paper Type(P. 54) "
-----------------	---

<Cause 2> The paper type loaded is not appropriate.

Solution	Make sure that the number of sheets or the paper type loaded in the paper cassette meets the paper specifications. ▶ " Supported Paper Types(P. 70) "
-----------------	--

Vertical Streaks Appear on the Output

85RS-049



Try one of the following to solve the problem.

<Cause 1> Due to the paper type or usage conditions, vertical streaks appear on the output.

Solution 1	Replace the paper stack with new unopened one. Ⓞ " Supported Paper Types(P. 70) "
Solution 2	<p>To copy or print Change the <Special Mode b> setting from the operation panel. Ⓞ " Special Mode(P. 213) "</p> <p>To print from a computer Change the [Special Print Adjustment] setting in the print driver. Ⓞ " Special Mode(P. 213) "</p>

<Cause 2> The toner cartridge was replaced recently, or the machine has not printed anything for an extended period of time.

Solution	Change the <Special Mode c> setting from the operation panel. Ⓞ " Special Mode(P. 213) "
-----------------	--

Toner Smudges and Spatters Appear around Text and Images

85RS-04A



Try one of the following to solve the problem.

<Cause 1> The paper type loaded is not appropriate.

<p>Solution</p>	<p>Make sure that the number of sheets or the paper type loaded in the paper cassette meets the paper specifications. 🔴 " Supported Paper Types(P. 70) "</p>
------------------------	--

The Printout is Too Dark

85RS-04C



Try one of the following to solve the problem.

<Cause 1> The copy density setting specified is not appropriate.

Solution	Adjust the <Density> or <Correct Density> to a lower level from the operation panel. Ⓞ " Adjusting the Density(P. 79) "
-----------------	---

<Cause 2> The machine is exposed to direct sunlight or strong light

Solution	Relocate the machine. Ⓞ " Relocating the Machine(P. 216) "
-----------------	--

<Cause 3> The size of the paper loaded in the paper cassette does not match the documents.

Solution	Perform cleaning the fixing unit in <Special Mode C> using the operation panel. Ⓞ " Special Mode(P. 213) " Ⓞ " Cleaning the Fixing Unit(P. 198) "
-----------------	---

Printed Bar Codes Cannot be Scanned

85RS-04E



Try one of the following to solve the problem.

<Cause> A bar code cannot be scanned correctly when printing it using the default print settings.

Solution	Change the [Special Print Mode] setting to [Special Settings 1] in the print driver. ● " Special Mode(P. 213) " ※ The density becomes lower with [Special Settings 1] than with [Off]. Additionally, text and lines may be reproduced less clearly. ※ If [Special Settings 1] is specified, the print speed slows down slower than default settings.
-----------------	--

Images may be partially cut off on the output

85RS-04F



Try one of the following to solve the problem.

<Cause> The print speed is prioritized, and [Output Adjustment Mode] is set to [Off].

Solution	Change the settings for [Output Adjustment Mode] to [On] in the printer driver. ● " Viewing the Online Help(P. 103) " ※ Changing to [On] slows down the print speed.
-----------------	---

Uninstalling the Software

85RS-04H

Follow the steps in the procedure below to uninstall the printer driver, scanner driver, MF Toolbox , or Product Extended Survey Program if you do not need them installed on your computer.

IMPORTANT

Be aware of the following before uninstalling the software.

- Log on to your computer with administrator privileges.
- Have the installation software ready in case you want to re-install the drivers).
- Quit all running applications on your computer.

To uninstall the printer/scanner driver

1 Open [Programs and Features].

For Windows 7

1. From the [Start] menu, select [Control Panel].
2. Click [Uninstall a Program] or double-click [Programs and Features].

For Windows 8

Right-click the lower-left corner of the screen and select [Programs and Features].

For Windows 10

1. From the [Start] menu, select [Windows System], and click [Control Panel].
2. Click [Programs] and click [Programs and Features].

2 Select [Canon MF3010], and then click [Uninstall/Change].

3 Click [Delete].

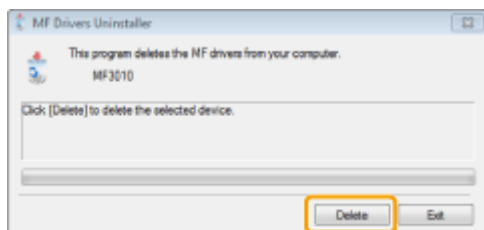

4 Click [Yes] to confirm the uninstallation.

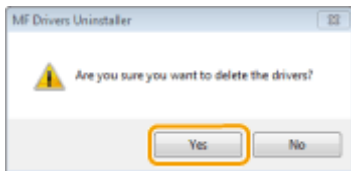

5 Click [Exit] (or [Restart]).



To uninstall the MF Toolbox

1 Open [Programs and Features].

For Windows 7

1. From the [Start] menu, select [Control Panel].
2. Click [Uninstall a Program] or double-click [Programs and Features].

For Windows 8

Right-click the lower-left corner of the screen and select [Programs and Features].

For Windows 10

1. From the [Start] menu, select [Windows System], and click [Control Panel].
2. Click [Programs] and click [Programs and Features].

2 Select [Canon MF Toolbox 4.9], and then click [Uninstall].

3 Click [Remove].

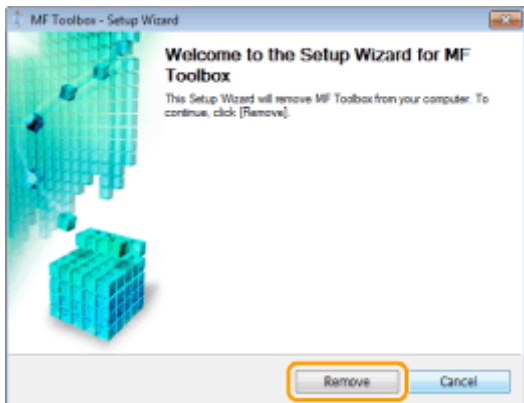

4 Click [Exit].

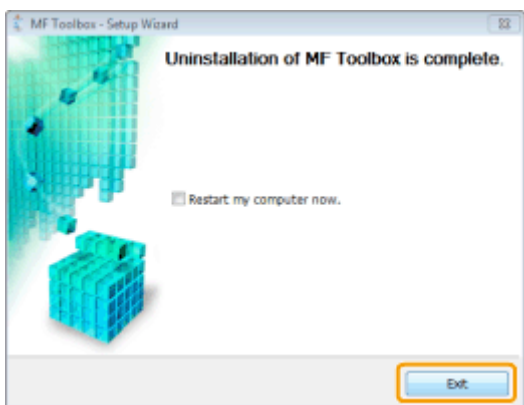

To uninstall the Product Extended Survey Program

1 Open [Programs and Features].

For Windows 7

1. From the [Start] menu, select [Control Panel].
2. Click [Uninstall a program] or double-click [Programs and Features].

For Windows 8

Right-click the lower-left corner of the screen and select [Programs and Features].

For Windows 10



1. From the [Start] menu, select [Windows System], and click [Control Panel].
2. Click [Programs] and click [Programs and Features].

2 Select [Canon Laser Printer/Scanner/Fax Extended Survey Program], and then click [Uninstall].

3 Follow the on-screen instructions.

When a Service Error Has Occurred

85RS-04J

The service error has occurred when the error number appears on the display and [] indicator and [] indicator light up.

NOTE

Error numbers

The error number appears on the display and switches in order of "E" → "x" → "x" → "x" ("xxx" represents a three-digit number).

When a Problem cannot be Resolved

85RS-04K

Customer Support (U.S.A.)

If you cannot solve a problem by referring to the information in this chapter, for the fastest resolution, please refer to available support materials (including the Knowledgebase FAQs and How to Video material) for your product at www.usa.canon.com.

Please have the following information ready when contacting the Canon Customer Care Center:

- Product name (imageCLASS MF3010 / MF3010VP)
- Serial number (a character string of three letters and a 5-digit number; located on the rating label on the rear side of the machine)

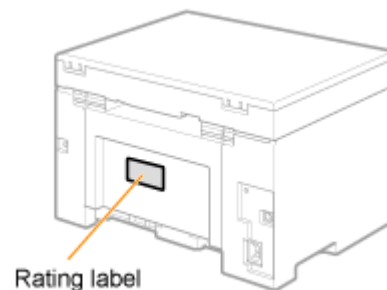

- Place of purchase
- Nature of the problem
- Steps you have taken to solve the problem and the results

WARNING

If the machine makes strange noises or emits smoke or an odd odor

Turn OFF the power switch immediately, disconnect the power cord, and contact the Canon Customer Care Center. Do not attempt to disassemble or repair the machine yourself.

IMPORTANT

If you attempt to fix the machine yourself

It may void the limited warranty.

Customer Support (Canada)

If you cannot solve a problem by referring to the information in this chapter, for the fastest resolution, please refer to available support materials (including the Knowledgebase FAQs and How to Video material) for your product at www.canon.ca/support.

Please have the following information ready when contacting the Canon Customer Care Center:

- Product name (imageCLASS MF3010 / MF3010VP)
- Serial number (a character string of three letters and a 5-digit number; located on the rating label on the rear side of the machine)

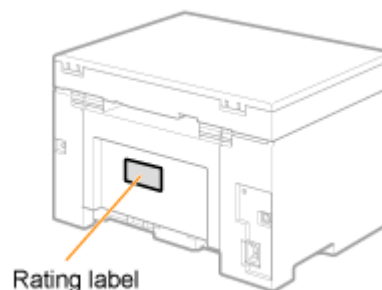

- Place of purchase
- Nature of the problem
- Steps you have taken to solve the problem and the results

⚠ WARNING

If the machine makes strange noises or emits smoke or an odd odor

Turn OFF the power switch immediately, disconnect the power cord, and contact the Canon Customer Care Center. Do not attempt to disassemble or repair the machine yourself.

💡 IMPORTANT

If you attempt to fix the machine yourself

It may void the limited warranty.

Maintenance

Maintenance	192
Cleaning the Machine	193
Cleaning the Exterior	194
Cleaning the Inside of the Machine	195
Cleaning the Fixing Unit	198
Cleaning the Platen Glass	199
Attention (Cleaning the Machine)	200
Replacing Toner Cartridges	202
Before Replacing the Toner Cartridge	203
Replacing the Toner Cartridge	206
Attention (Replacing the Toner Cartridge)	210
Special Mode	213
Relocating the Machine	216
Attention (Relocating the Machine)	219

Maintenance

85RS-04L

This chapter describes how to clean the machine, replace toner cartridges, make adjustments, and transport the machine.

Cleaning the machine	<ul style="list-style-type: none"> • When the machine is dirty See " Cleaning the Exterior(P. 194) ." • When the inside of the machine is dirty See " Cleaning the Inside of the Machine(P. 195) ." • When black streaks appear on the output See " Cleaning the Fixing Unit(P. 198) ." • When the platen glass is dirty See " Cleaning the Platen Glass(P. 199) ."
Replacing the toner cartridge	See " Replacing Toner Cartridges(P. 202) ."
Adjusting the Machine	See " Special Mode(P. 213) ."
Relocating the machine	See " Relocating the Machine(P. 216) ."

Cleaning the Machine

85RS-04R

See following sections to clean the components of the machine.

- ▶ " **Cleaning the Exterior(P. 194) "**
- ▶ " **Cleaning the Inside of the Machine(P. 195) "**
- ▶ " **Cleaning the Fixing Unit(P. 198) "**
- ▶ " **Cleaning the Platen Glass(P. 199) "**

Cleaning the Exterior

85RS-04S

See " **Attention (Cleaning the Machine)(P. 200)** " in advance.

Clean the exterior of the machine and ventilation slots.

- 1 Turn OFF the power switch and disconnect the power cord.**
- 2 Clean the exterior of the machine with a soft, well wrung out cloth dampened with water or a mild detergent diluted with water.**



- 3 Wait for the machine to dry completely before reconnecting the power cord and turn ON the power.**

Cleaning the Inside of the Machine

85RS-04U

See " **Attention (Cleaning the Machine)(P. 200)** " in advance.

Clean the machine's print area at regular intervals so that toner powder, as well as paper dust and other debris, do not accumulate inside the machine.

1 Turn OFF the power switch and disconnect the power cord.

2 Hold the operation panel.

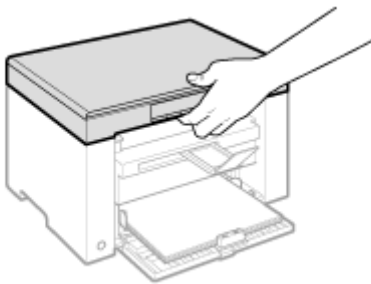

3 Lift the scanning platform.

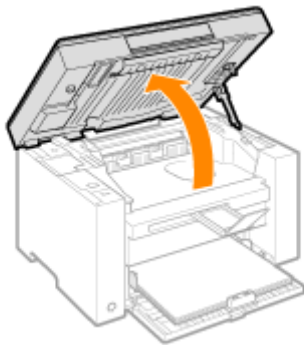

? When you cannot lift the scanning platform

Make sure that the platen glass is completely closed.

Do not try to forcefully lift the scanning platform, as this may damage the machine.

- ※ The platen glass may not be completely closed when a thick document such as books is placed inside. In such case, remove it from the platen glass.

4 Hold the grip on the left front side of the toner cover.

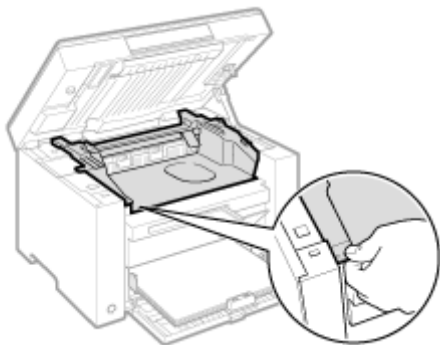

5 Open the toner cover.

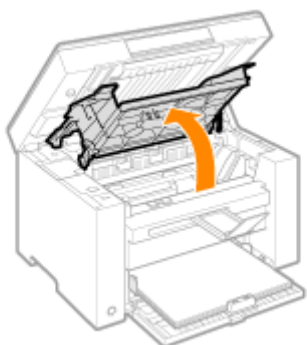

6 Remove the toner cartridge.

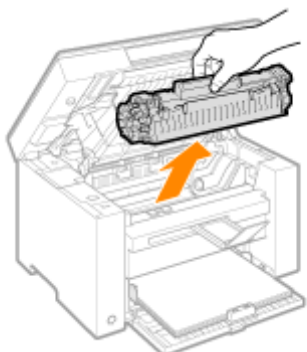

7 Remove toner powder, as well as paper dust and other debris from the inside of the machine, using a clean, soft, dry, and lint-free cloth.

8 Insert the toner cartridge.

Fit the protrusions (A) on both sides of the toner cartridge into the guides located on both sides of the machine and slide the toner cartridge into the machine until the toner cartridge comes to rest and is held against the back of the machine.

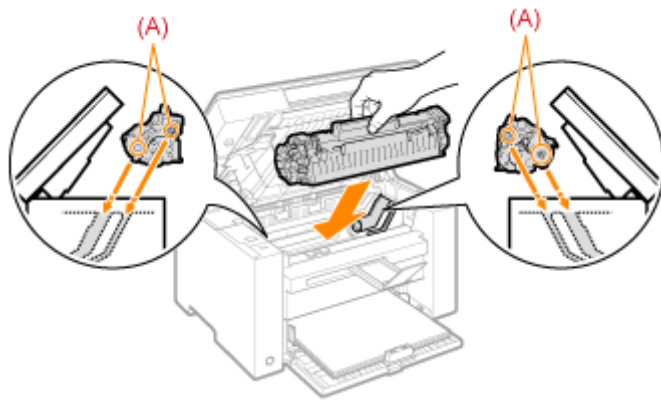

9 Close the toner cover.

? When you cannot close the toner cover

Make sure that the toner cartridge is properly set inside the machine.
Do not try to forcefully close the toner cover, as this may damage the machine.







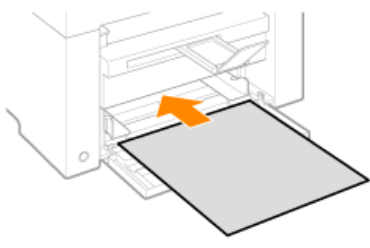
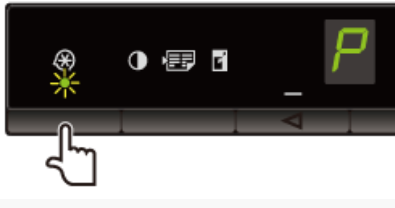

10 Lower the scanning platform.

11 Connect the power cord and turn ON the power switch.

Cleaning the Fixing Unit

The fixing unit may be dirty under the following conditions. Clean the fixing unit.

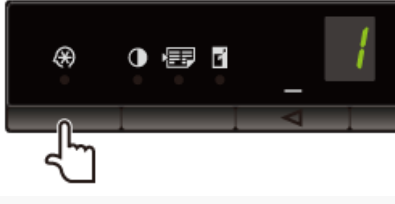
- When black streaks appear on the output
- When replacing the toner cartridge

	Operating results	Operating results
1		<p>Load A4 or Letter size plain paper.</p> <p>▶ " In the Paper Cassette(P. 47) "</p>
2		<p>Press [] (Menu setting key), and then start the menu operation.</p> <p>When the menu is operating, the menu indicator blinks.</p>
3		<p>Press [] or [] until "C" is displayed.</p>
4		<p>When [] is pressed, cleaning starts.</p> <p>It takes approximately 140 seconds.</p> <ul style="list-style-type: none"> ※ We recommend that plain paper be loaded when cleaning the fixing unit. ※ You cannot perform cleaning when jobs are stored in the memory.
5		<p>Press [] (Menu setting key) to exit the menu operation.</p> <p>The menu indicator turns off.</p>

Cleaning the Platen Glass

85RS-04X

See " **Attention (Cleaning the Machine)(P. 200)** " in advance.

Follow the steps in the procedure below to clean the platen glass and the under surface of the platen glass cover.

1 Turn OFF the power switch and disconnect the power cord.

2 Open the platen glass.



3 Clean the platen glass and the under surface of the platen glass cover.

(1) Clean the areas with a cloth dampened with water.

(2) Wipe the areas with a soft, dry cloth.



4 Close the platen glass.

5 Connect the power cord and turn ON the power switch.

Attention (Cleaning the Machine)

85RS-04Y

See " **Maintenance and Inspections(P. 10)** " in "Important Safety Instructions".

Before cleaning the machine, note the following.

- Use a soft cloth to avoid scratching the components.
- Do not clean the machine components with tissue paper, paper towels, or similar materials. These materials tend to stick to the components or generate static charges.

CAUTION

Precautions to take when closing the platen glass

Be careful not to get your fingers caught.

Do not touch the fixing unit (A).

Touching the fixing unit (A) may cause burns as it becomes very hot while the machine is in operation.

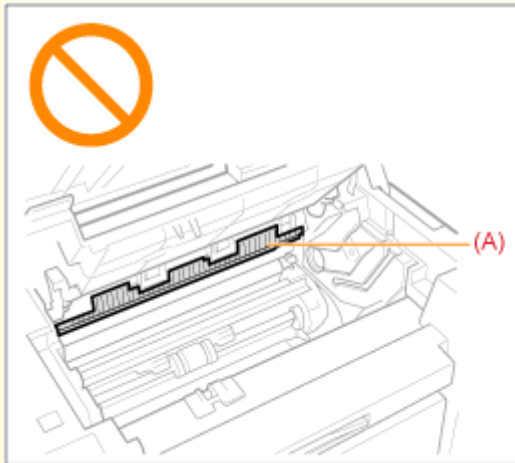

Precautions to take when you get toner onto your hands or into clothing

If toner comes in contact with your hands or clothing, wash them immediately in cold water. Do not use warm water, as it will set the toner and make it difficult to remove the toner stains.

IMPORTANT

Do not touch the transfer roller (A).

The act may damage the machine.

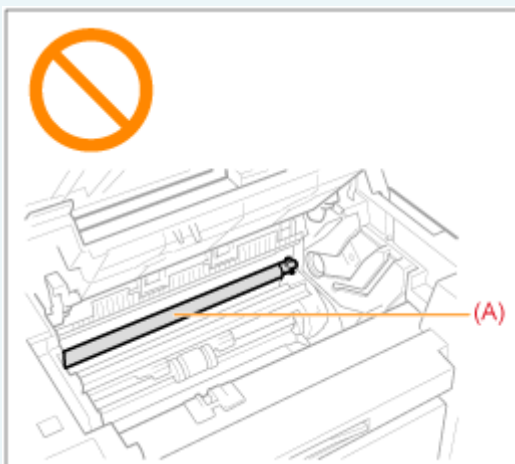



NOTE

When a job is waiting to be printed

The job is deleted when you turn OFF the power switch.

Replacing Toner Cartridges

85RS-050

When the toner nearly runs out, white streaks appear on the output, or the output is partially faded.

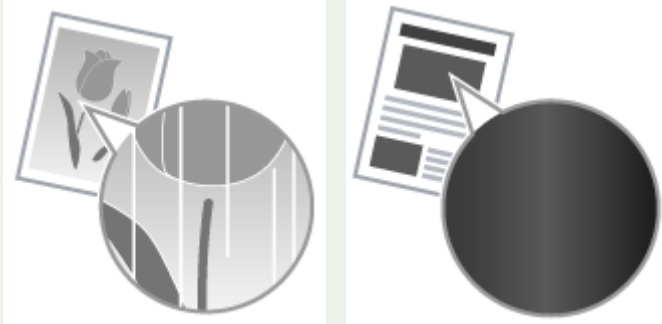

- ※ No message appears on the screen, if the toner nearly runs out. Replace the toner cartridge when white streaks appear on the output, or the output is partially faded.

▼ When this problem occurs

Follow the steps in the procedure below before replacing the toner cartridge. The machine continues printing until the toner runs out completely.

- ▶ **Before Replacing the Toner Cartridge(P. 203) "**

▼ When the print quality is still unacceptable

If the problem persists after you have followed the steps in the procedure below, replace the toner cartridge.

- ▶ **Replacing the Toner Cartridge(P. 206) "**

! IMPORTANT

About toner cartridges

For more information on toner cartridges, see the following sections.

- ▶ **About the Supplied Toner Cartridge(P. 37) "**
- ▶ **About Replacement Toner Cartridges(P. 38) "**
- ▶ **Handling Toner Cartridges(P. 39) "**
- ▶ **Purchasing Consumables(P. 42) "**

- ※ The average yield of replacement toner cartridges varies from that of the supplied toner cartridge.

Before Replacing the Toner Cartridge

85RS-051

See " **Attention (Replacing the Toner Cartridge)(P. 210)** " in advance.

When the toner nearly runs out, follow the steps in the procedure below before replacing the toner cartridge. The machine continues printing until the toner runs out completely.

1 Hold the operation panel.

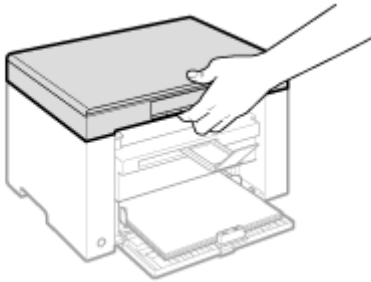

2 Lift the scanning platform.

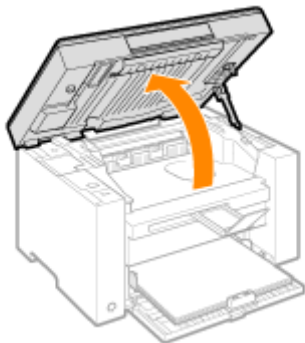

When you cannot lift the scanning platform

Make sure that the platen glass is completely closed.

Do not try to forcefully lift the scanning platform, as this may damage the machine.

- ※ The platen glass may not be completely closed when a thick document such as books is placed inside. In such case, remove it from the platen glass.

3 Hold the grip on the left front side of the toner cover.

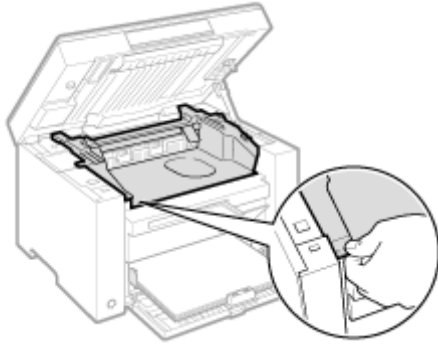

4 Open the toner cover.

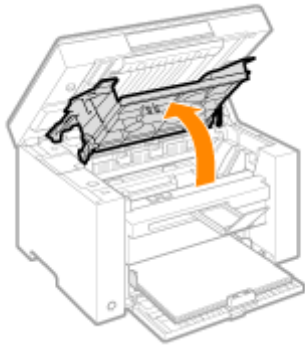

5 Remove the toner cartridge.

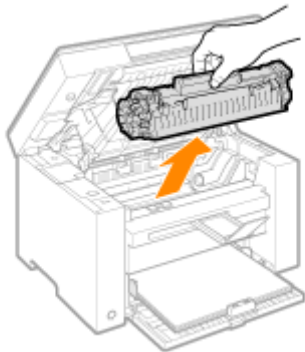

6 Gently shake the toner cartridge five or six times to evenly distribute the toner inside the cartridge.



7 Insert the toner cartridge.

Fit the protrusions (A) on both sides of the toner cartridge into the guides located on both sides of the machine and slide the toner cartridge into the machine until the toner cartridge comes to rest and is held against the back of the machine.

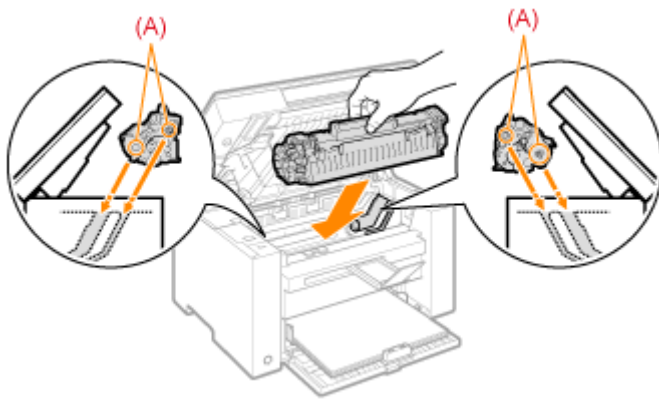

8 Close the toner cover.

When you cannot close the toner cover

Make sure that the toner cartridge is properly set in the machine.
Do not try to forcefully close the toner cover, as this may damage the machine.

9 Lower the scanning platform.

Replacing the Toner Cartridge

85RS-052

See " **Attention (Replacing the Toner Cartridge)(P. 210)** " in advance.

1 Hold the operation panel.

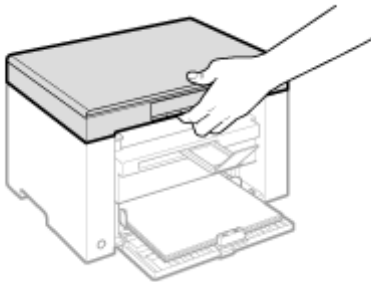

2 Lift the scanning platform.

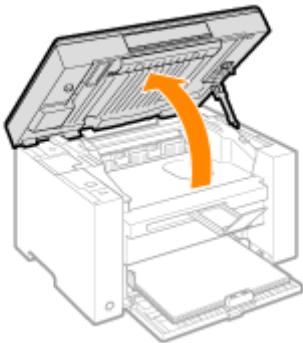

? When you cannot lift the scanning platform

Make sure that the platen glass is completely closed.

Do not try to forcefully lift the scanning platform, as this may damage the machine.

- ※ The platen glass may not be completely closed when a thick document such as books is placed inside. In such case, remove it from the platen glass.

3 Hold the grip on the left front side of the toner cover.

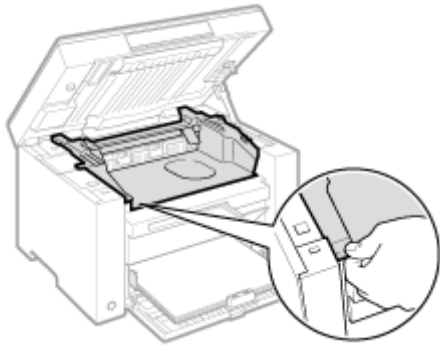

4 Open the toner cover.

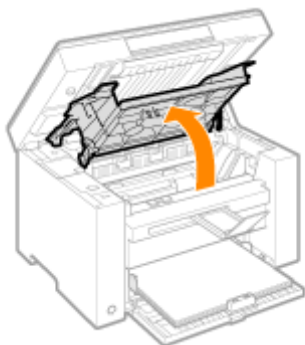

5 Remove the toner cartridge.

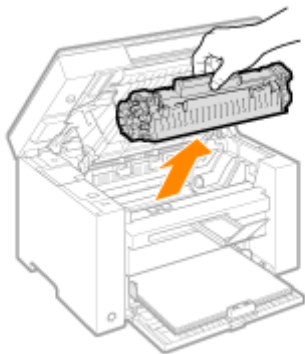

6 Take out the new toner cartridge from the protective bag.

Tear the notch with both hands to open the protective bag.



- 7 Gently shake the toner cartridge five or six times to evenly distribute the toner inside the cartridge.**

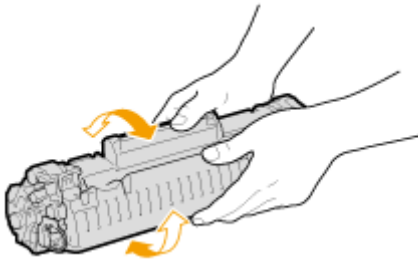

- 8 Place the toner cartridge on a flat surface, lift the tab, and gently pull the sealing tape completely out.**

The full length of the sealing tape is approximately 50 cm (20").

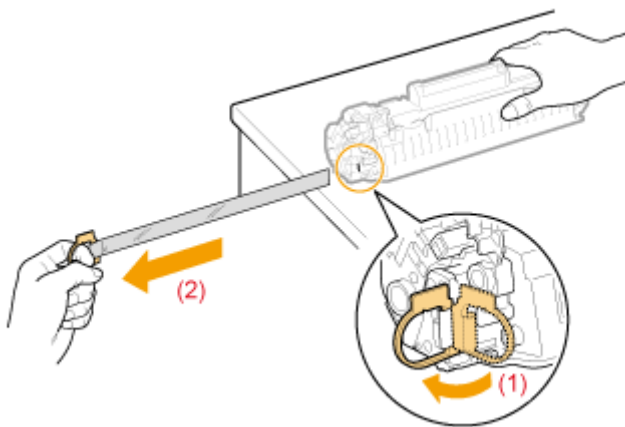

- 9 Insert the toner cartridge.**

Fit the protrusions (A) on both sides of the toner cartridge into the guides located on both sides of the machine and slide the toner cartridge into the machine until the toner cartridge comes to rest and is held against the back of the machine.

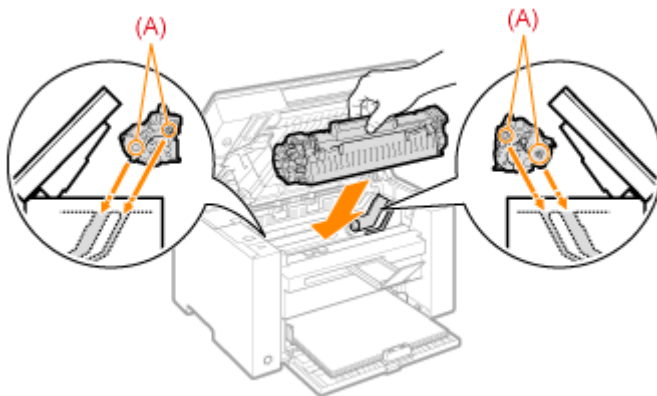

- 10 Close the toner cover.**

 **When you cannot close the toner cover**

Make sure that the toner cartridge is properly set in the machine.

Do not try to forcefully close the toner cover, as this may damage the machine.

11 Lower the scanning platform.

Attention (Replacing the Toner Cartridge)

85RS-053

See " **Maintenance and Inspections(P. 10)** " in "Important Safety Instructions".

WARNING

Do not dispose of a used toner cartridge in an open flame.

This may ignite the toner remaining inside the cartridge, resulting in burns or fire.

When cleaning up spilled or scattered toner

If you accidentally spill or scatter toner, carefully gather the toner particles together or wipe them up with a soft, damp cloth in a way that prevents inhalation.

Never use a vacuum cleaner that does not have safeguards against dust explosions to clean up spilled toner. Doing so may cause a malfunction in the vacuum cleaner, or result in a dust explosion due to static discharge.

CAUTION

Precautions to take when you get toner onto your hands or into clothing

If toner comes in contact with your hands or clothing, wash them immediately in cold water. Do not use warm water, as it will set the toner and make it difficult to remove the toner stains.

Do not allow the toner to scatter.

Do not pull out the sealing tape forcefully or stop pulling the tape halfway, as this may cause toner to spill out. If toner gets into your eyes or mouth, flush them immediately with cold water and consult a physician.

Use caution when lowering the scanning platform

Keep your fingers clear of the scanning platform to avoid injury.

IMPORTANT

About replacement toner cartridges

For optimum print quality, using Canon genuine toner cartridges is recommended.

Model Name	Supported Canon Genuine Toner Cartridge
MF3010 / MF3010VP	Canon Cartridge 125

Be careful of counterfeit toner cartridges.

Please be aware that there are counterfeit Canon toner cartridges in the marketplace.

Use of counterfeit toner cartridge may result in poor print quality or machine performance.

Canon is not responsible for any malfunction, accident or damage caused by the use of counterfeit toner cartridge.

For more information, see <http://www.canon.com/counterfeit>.

Shake the toner cartridge before replacement.

If the toner is not distributed evenly inside the cartridge, this may cause poor print quality.

Hold the toner cartridges properly.

When handling the toner cartridge, hold it properly, as shown in the illustration below. Do not stand it vertically or hold it upside down.

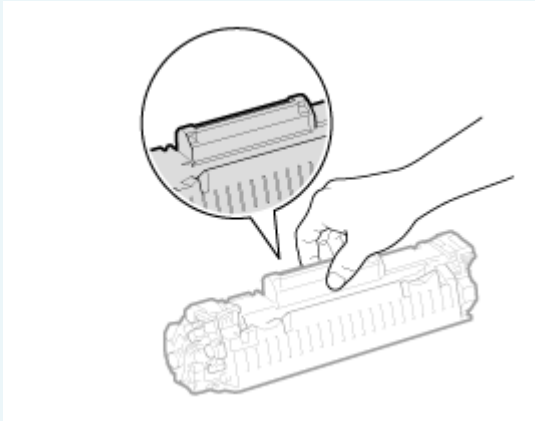

Do not touch the toner cartridge memory (A) or the electrical contacts (B).

This may result in damage to the cartridge.

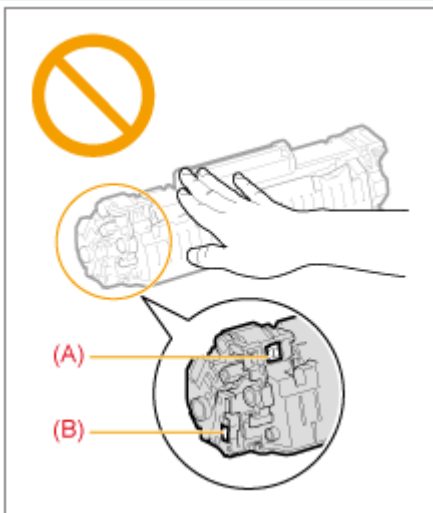

Do not open the drum protective shutter (A).

Print quality may deteriorate if you touch or damage the drum inside the drum protective shutter (A). Do not touch or open the drum protective shutter (A).

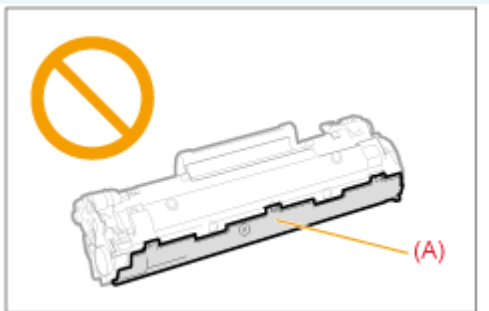

When pulling out the sealing tape

- Do not pull the sealing tape at an angle or sideways. If the tape breaks, the tape may not be pulled out completely.

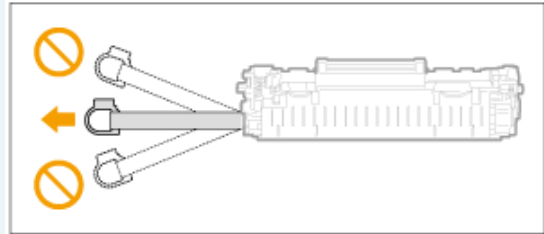

- If the sealing tape is still hanging outside the toner cartridge, pull it out completely.
- If the tape remains inside the toner cartridge, this may cause poor print quality.

When disposing of the removed sealing tape

Dispose of the packing materials in accordance with local regulations.

Keep the protective bag.

Keep the protective bag for storing the toner cartridge. You will need it when you remove the toner cartridge for machine maintenance or other purposes.

Do not touch the high-voltage contacts (A).

This may result in damage to the machine.

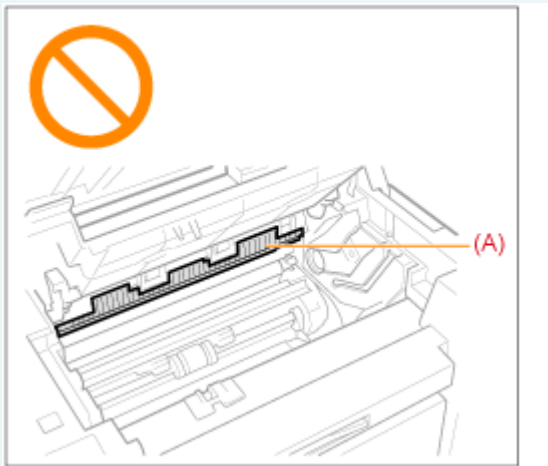

Do not leave the toner cover open for an extended period of time when the toner cartridge is installed.

This may result in print quality deterioration.

 **NOTE**

About the packing materials

The packing materials are subject to change in form or placement, or may be added or removed without notice.

Special Mode

85RS-060

Use the Special Mode settings to fix print quality problems.

Read the following carefully before changing the settings.

IMPORTANT

Use default settings in normal operation

Change the settings only when the problems noted below occur.

Settings That Can Be Specified From the Operation Panel

Settings

※ Default settings are highlighted in bold.

Special mode	Options	Details
Special Mode b	0 Off	<p>Due to the paper type or usage conditions, vertical streaks appear on the output. When this occurs, change this setting.</p> <p>The effect becomes greater as the number goes up.</p> <p style="text-align: center;"><Off> -> <Mode 1> -> <Mode 2> -> <Mode 3> -> <Mode 4></p> <p style="text-align: center;">(low) (high)</p> <p>※ Streaks can be minimized by changing the paper type or usage conditions, without needing to change the setting.</p> <p>The more effective the setting, the lower the density becomes.</p> <p>※ Additionally, the outline of text and images may be reproduced less clearly, and images may appear slightly jagged.</p>
	1 Mode 1	
	2 Mode 2	
	3 Mode 3	
	4 Mode 4	
Special Mode c	0 Off	<p>Vertical streaks appear on the output after the toner cartridge was replaced recently, or the machine has not printed anything for an extended period of time. When this occurs, change this setting.</p> <p>The effect becomes greater as the number goes up.</p> <p style="text-align: center;"><Off> -> <Mode 1> -> <Mode 2> -> <Mode 3></p> <p style="text-align: center;">(low) (high)</p> <p>※ Streaks can be minimized by changing the paper type or usage conditions, without needing to change the setting.</p> <p>※ The more effective the setting becomes, the slower the print speed.</p>
	1 Mode 1	
	2 Mode 2	
Special Mode d	3 Mode 3	<p>Due to the paper type or usage conditions, paper curls or creases. When this occurs, change this setting.</p> <p>The effect becomes greater as the number goes up.</p> <p style="text-align: center;"><Off> -> <Mode 1> -> <Mode 2></p> <p style="text-align: center;">(low) (high)</p> <p>※ Paper curls and creases can be minimized by changing the paper type and usage conditions, without needing to change the setting.</p> <p>※ This setting can be selected when</p>
	0 Off	
	1 Mode 1	
	2 Mode 2	

Special mode	Options	Details
		<ul style="list-style-type: none"> • Paper Type is set to Plain paper, Plain paper L, Heavy paper 1, Rough paper, Label, or Envelope. ※ The more effective the setting becomes, the slower the print speed.
Special Mode h	0 Off	Due to the paper type (for example, heavy paper) or usage conditions (for example, dry conditions), toner smudges and spatters appear on the output. When this occurs, set this setting to <On>.
	1 On	The print quality may become lower when this setting is enabled, <ul style="list-style-type: none"> ※ depending on the paper type used (for example, thin paper) or usage conditions (humid conditions).
Special Mode C	C	Perform cleaning when black streaks appear on the output or toner cartridges are replaced. <ul style="list-style-type: none"> ※ Set the setting for this item to <"C">. <p>▶ "Cleaning the Fixing Unit(P. 198)"</p>

Settings That Can Be Specified In the Printer Driver

Settings

※ Default settings are highlighted in bold.

Special mode	Setting options	Details
Special Print Adjustment	Off, Mode 1, Mode 2 , Mode 3, Mode 4	<p>Due to the paper type or usage conditions, vertical streaks appear on the output. When this occurs, change this setting. The effect becomes greater as the number goes up.</p> <p style="text-align: center;">[Off] -> [Mode 1] -> [Mode 2] -> [Mode 3] -> [Mode 4] (low) (high)</p> <ul style="list-style-type: none"> ※ Streaks can be minimized by changing the paper type or usage conditions, without needing to change the setting. The more effective the setting, the lower the density becomes. ※ Additionally, the outline of text and images may be reproduced less clearly, and images may appear slightly jagged.
Special Print Mode	Off , Special Settings 1, Special Settings 2	<p>[Off] The special print mode is disabled and has no effect.</p> <p>[Special Settings 1] If a printed barcode is hardly readable when using the default print settings, set this setting to [Special Settings 1].</p> <ul style="list-style-type: none"> ※ The density becomes lower with [Special Settings 1] than with [Off]. Additionally, text and lines may be reproduced less clearly. ※ If [Special Settings 1] is specified, the print speed slows down slower than default settings. <p>[Special Settings 2] If white specks or spots appear around text and images when a high-contrast document is printed, set this setting to [Special Settings 2].</p>

Special mode	Setting options	Details
		The density becomes lower with [Special Settings 2] than with [Off] or ※ [Special Settings 1]. Additionally, text and lines may be reproduced less clearly.

Specifying Special Mode Settings In the Printer Driver

- 1 Click the [Finishing] tab.

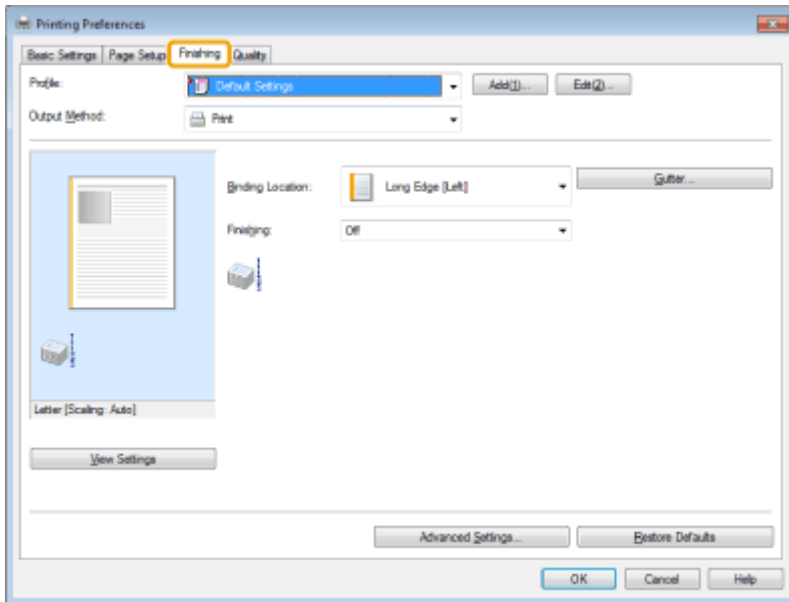

 **NOTE**

For the instructions on how to access the printer driver screen, see " **Printing(P. 98)** " and " **Configuring the Default Print Settings(P. 101)** ."

- 2 Click [Advanced Settings].

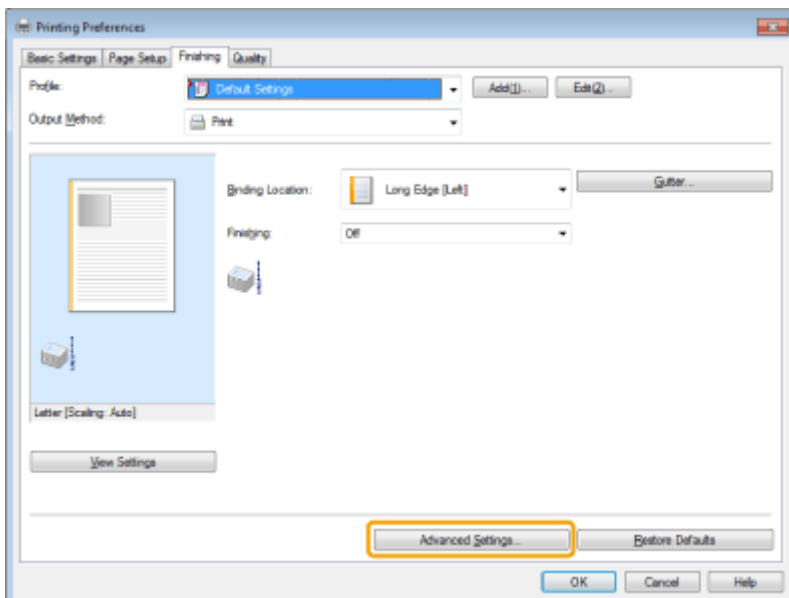

Relocating the Machine

See " **Attention (Relocating the Machine)(P. 219)** " in advance.

Follow the steps in the procedure below to relocate the machine somewhere else for maintenance and other purposes.

1 Turn OFF the machine and all the computers connected to the machine.

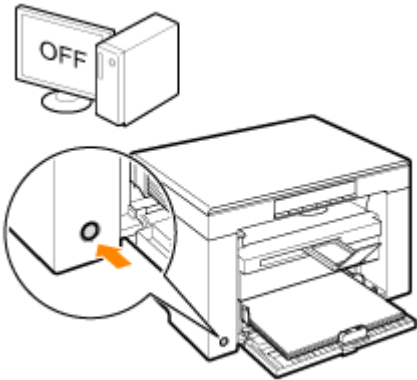

2 Disconnect all cables and the power cord from the machine.

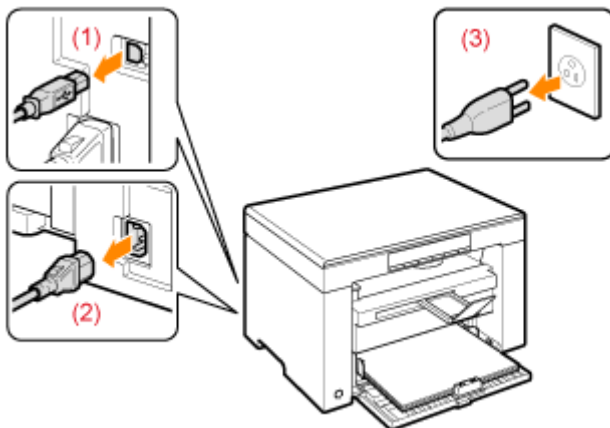

How to remove the cables and power cord

USB cable	(1) Remove it from the machine.
Power cord	(2) Unplug the power plug from the AC power outlet. (3) Remove it from the machine.

3 Fold the paper stopper and push the output tray extension into the machine.

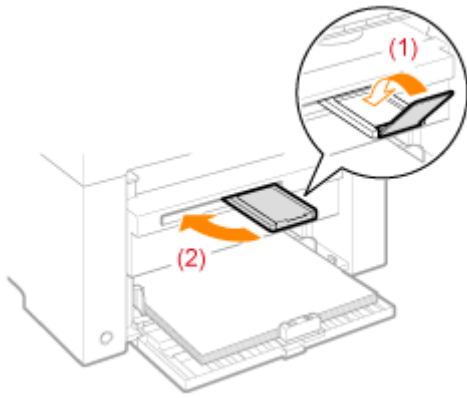

 NOTE

When paper is left in the output tray

Remove the paper from the output tray.

4 Remove the paper stack from the paper cassette.

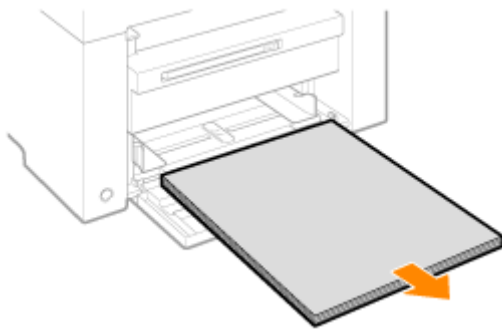

 NOTE

When the front paper guide is pulled out from the paper cassette

Push the guide into the paper cassette.

5 Lower the dust cover.

6 Close the paper cassette.

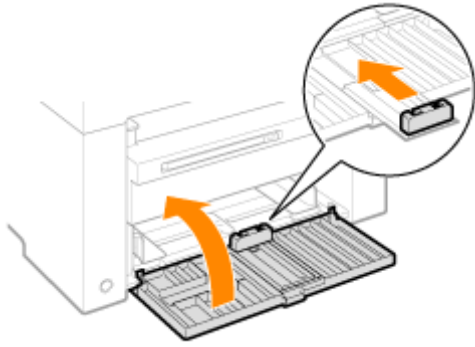

7 Relocate the machine.

Make sure that all the covers and trays are closed and hold the lift handles with the front side of the machine facing you.

Check the weight of the machine before lifting, carrying, and relocating it.

☛ " Machine Specifications(P. 62) "

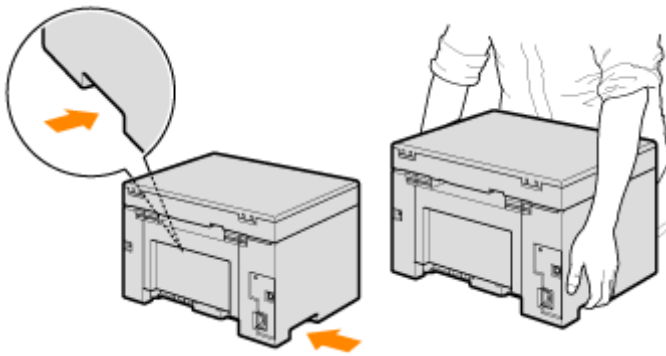

8 Carefully set the machine down at the new installation site.

NOTE

When reinstalling the machine

See the Starter Guide that comes with the machine.

When relocating the machine to a far-off place

To prevent damage to the machine when relocating the machine to a far-off place, note the following.

- Remove the toner cartridge.
- Securely pack the machine in its original box with the original packing materials.

※ When the original box and packing materials cannot be found, find an appropriate box and packing materials to pack the machine and the parts properly.

Attention (Relocating the Machine)

85RS-056

 **WARNING****When relocating the machine**

Be sure to turn OFF the power switch on the machine and your computer, and unplug the power plug and interface cables.

Failure to do so can damage the cables or cords, resulting in a fire or electrical shock.

 **CAUTION****Set the machine down slowly and carefully.**

Be careful not to hurt your hands or fingers.

 **IMPORTANT****Do not carry the machine with the covers or trays open.**

Make sure that the scanning platform and paper cassette are closed before lifting, carrying, and relocating the machine.

Appendix

Appendix	221
Third Party Software	222
Manuals and Their Contents	223
Basic Windows Operations	224
Disclaimers	227
Copyright	228
Trademarks	229

Appendix

85RS-057

- ▶ " Third Party Software(P. 222) "
- ▶ " Manuals and Their Contents(P. 223) "
- ▶ " Basic Windows Operations(P. 224) "
- ▶ " Disclaimers(P. 227) "
- ▶ " Copyright(P. 228) "
- ▶ " Trademarks(P. 229) "

Third Party Software

85RS-06A

For information related to third-party software, click the following icon(s).

Third-Party Services





Third-party Software Included in this Manual



Manuals and Their Contents

85RS-061

The manuals listed below are included with the machine. Refer to them as necessary.

Starter Guide	<p>Read this manual first. This manual describes the installation of the machine, the settings, and a caution. Be sure to read this manual before using the machine.</p> 
MF Driver Installation Guide	<p>This manual describes how to install the MF drivers, MF Toolbox, and the supplied software.</p> 
Quick Reference Guide	<p>This manual describes the basic use of the machine. Place this guide near the printer for effective usage.</p> <p>▶ " Using the Quick Reference Guide(P. 27) "</p>
User's Guide (This Manual)	<p>This manual describes all the functions of the machine. You can browse information by category or enter a keyword to search for pages on a specific topic.</p> <p>▶ " Using User's Guide(P. 231) "</p>

V_211026

Basic Windows Operations

85RS-058

- ▶ How to Open the Printer Folder(P. 224)
- ▶ How to Display the [Scanners and Cameras] Screen(P. 224)
- ▶ How to Display [Windows Fax & Scan] Screen(P. 225)
- ▶ How to Display the Top Screen of CD-ROM(P. 225)
- ▶ How to Check the Windows Process Version (P. 225)

How to Open the Printer Folder

Windows 7

From the [Start] menu, select [Devices and Printers].

Windows 8

Right-click the lower-left corner of the screen, select [Control Panel], and then click [View devices and printers].

Windows 10

1. From the [Start] menu, select [Windows System], and click [Control Panel].
2. Click [Hardware and Sound] and click [Devices and Printers].

How to Display the [Scanners and Cameras] Screen

Windows 7

1. Enter "scanner" in [Search programs and files] under the [Start] menu.
2. Click [View scanners and cameras].

Windows 8

1. Right-click the lower-left corner of the screen and click [Control Panel].
2. Enter "scanner" in [Search Control Panel] on the upper-right corner of the window.
3. Click [View scanners and cameras].

Windows 10

1. From the [Start] menu, select [Windows System], and click [Control Panel].
2. Enter "scanner" in [Search Control Panel] on the upper-right corner of the window.
3. Click [View scanners and cameras].

How to Display [Windows Fax & Scan] Screen

Windows 7

From the [Start] menu, select [All Programs] -> [Windows Fax and Scan].

Windows 8

1. Right-click the lower-left corner of the screen and select [Search].
2. Enter "scan" and click [Windows Fax & Scan].

Windows 10

1. Enter "scan" in the search box.
2. Click [Windows Fax and Scan] displayed as the search result.

How to Display the Top Screen of CD-ROM

If you cannot display the top screen when setting CD-ROM, perform the following operations.

- ※ The CD-ROM drive name is indicated as "D:" in this manual. The CD-ROM drive name may differ depending on the computer you are using.

Windows 7

1. Enter "D:\Minst.exe" in [Search programs and files] (or [Start Search]) under the [Start] menu.
2. Press the [ENTER] key on the keyboard.

Windows 8

1. Right-click the lower-left corner of the screen and select [Run].
2. Enter "D:\MInst.exe", and then click [OK].

Windows 10

1. Enter "D:\MInst.exe" in the search box.
2. Click [D:\MInst.exe] displayed as the search result.

How to Check the Windows Process Version

- 1** Open [Control Panel].

Windows 7

Select [Control Panel] from [Start] menu.

Windows 8

Right-click the lower-left corner of the screen and select [Control Panel].

Windows 10

Proceed to step 2.

2 Display [System].

Windows 7, 8

Click [System and Maintenance] or [System and Security] -> [System].

Windows 10

1. Select [⚙️] (Settings) from the [Start] menu.
2. Click [System] and select [About].

3 Check the process version.

For 32-bit versions

[32-bit Operating System] is displayed.

For 64-bit versions

[64-bit Operating System] is displayed.

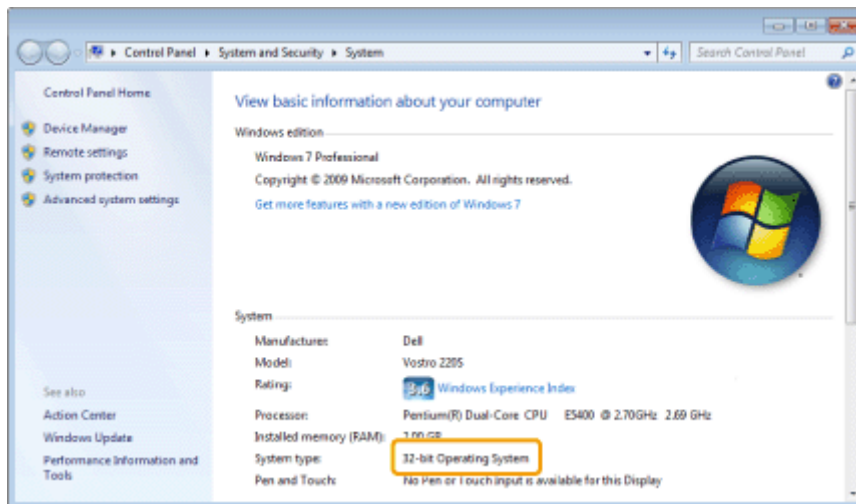

Disclaimers

85RS-059

- The information in this document is subject to change without notice.
- CANON INC. MAKES NO WARRANTY OF ANY KIND WITH REGARD TO THIS MATERIAL, EITHER EXPRESS OR IMPLIED, EXCEPT AS PROVIDED HEREIN, INCLUDING WITHOUT LIMITATION, THEREOF, WARRANTIES AS TO MARKETABILITY, MERCHANTABILITY, FITNESS FOR A PARTICULAR PURPOSE OF USE, OR NON-INFRINGEMENT. CANON INC. SHALL NOT BE LIABLE FOR ANY DIRECT, INCIDENTAL, OR CONSEQUENTIAL DAMAGES OF ANY NATURE, OR LOSSES OR EXPENSES RESULTING FROM THE USE OF THIS MATERIAL.
- If you are unable to view the manual in PDF format, download Adobe Acrobat Reader from the Adobe Systems website (<https://get.adobe.com/reader/>).

Copyright

85RS-05A

Copyright CANON INC. 2022

No part of this publication may be reproduced, transmitted, transcribed, stored in a retrieval system, or translated into any language or computer language in any form or by any means, electronic, mechanical, magnetic, optical, chemical, manual, or otherwise, without the prior written permission of Canon Inc.

Trademarks

85RS-05C

Canon, the Canon logo, and imageCLASS are registered trademarks of Canon Inc. in the United States and may also be trademarks or registered trademarks in other countries.

Adobe, Acrobat and Reader are registered trademarks of Adobe Systems Incorporated in the United States and/or other countries.

Apple, Mac, macOS and OS X are trademarks of Apple Inc.

All other trademarks are the property of their respective owners.

All other product and brand names are registered trademarks, trademarks or service marks of their respective owners.

Using User's Guide

Using User's Guide	231
Screen Layout of the User's Guide	232
Top Page	233
Topic Page	235
Search Method	236
Viewing the User's Guide	237

Using User's Guide

85RS-069

The User's Guide is a manual that can be viewed on your computer or mobile device and it describes all of the functions of the machine. You can search from your intended use or enter a keyword to quickly find the page you are looking for. The section describes the screen layout of the User's Guide and how to read the Guide. You can specify how the appearance of the User's Guide looks.

Screen Layout of User's Guide

This section describes the screens configuring the User's Guide and how to use the on-screen buttons.

- ▶ **Screen Layout of the User's Guide(P. 232)**

Viewing User's Guide

This section describes the meaning of the marks used in the User's Guide, how the keys on the operation panel and the buttons on the computer display are represented, and other matters that help you understand the information contained in the User's Guide.

- ▶ **Viewing the User's Guide(P. 237)**

Specifying How the Appearance of the User's Guide Looks

You can change the character size used in the User's Guide, and switch the screen layout to fit to the device you use to view the User's Guide.

How to Find the Topic You Are Looking for

Search the contents

You can find the page you are looking for by selecting the topic from the "Contents" on the left side of the screen.

Search by keyword

Perform a search by entering a keyword, such as "envelope" or "toner cartridge," and the pages containing the keyword are displayed. You can find the page you are looking for from those results. You can also enter phrases such as "adjusting the density." The keyword search also supports the AND Boolean to search for multiple keywords. For the organization of the search screen and how to operate the search screen, see **Search Method(P. 236)** .

Screen Layout of the User's Guide

85RS-068

This section describes the screen layout of the User's Guide.

The page displayed right after the User's Guide starts is called "Top Page" and the manual description is called "Topic Page" in this section.

The search panel is used to make search through the User's Guide.

The screen layout is different for each page, so click the following links to see the instruction.

➤ **[Top Page\(P. 233\)](#)**

➤ **[Topic Page\(P. 235\)](#)**

➤ **[Search Method\(P. 236\)](#)**

Top Page

85RS-063

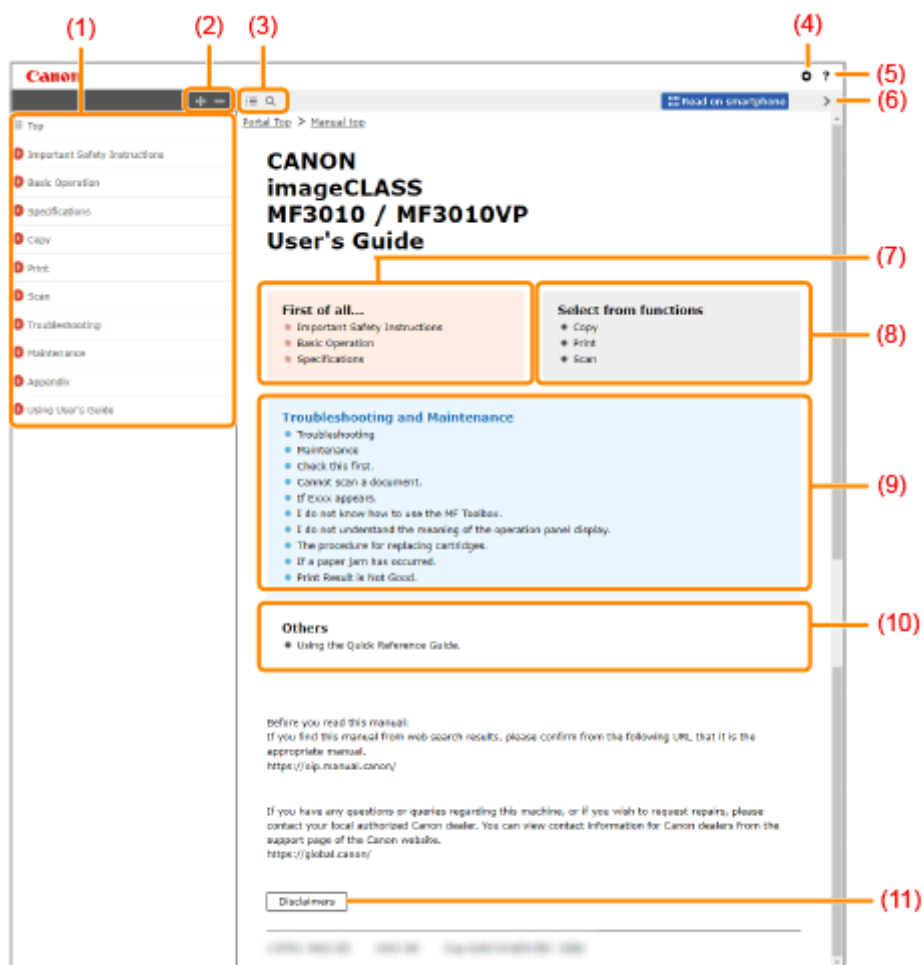

Appears when the User's Guide starts.



(1) Table of Contents

Chapter titles are displayed.

(2)

Click  to display all items, including those nested underneath other items. Click  to return to the original list.

(3)

Click to switch between the table of contents and the search display.

(4)

Click to specify settings such as text size, layout, and display method for the User's Guide.

(5)

Click to display information on how to view the User's Guide, how to perform a search, and other information.

(6)

Click to display the previous or following topic.

(7) [First of all...]

Provide a link to the selected content, to describe the safety instructions, features of the machine, and how to configure and use the machine efficiently (for example, loading paper and using the sleep mode.)

(8) [Select from functions]

Provide a link to the selected content, to let you to learn how to use the functions of the machine.

(9) [Troubleshooting and Maintenance]

Provide a link to the selected content, to describe how to troubleshoot problems and maintain the machine.

(10) [Others]

The Quick Reference Guide offers handy instructions to operate the machine.

(11) [Disclaimers]

The disclaimers are displayed.

Topic Page

85RS-064

Contains information about how to configure and use the machine.

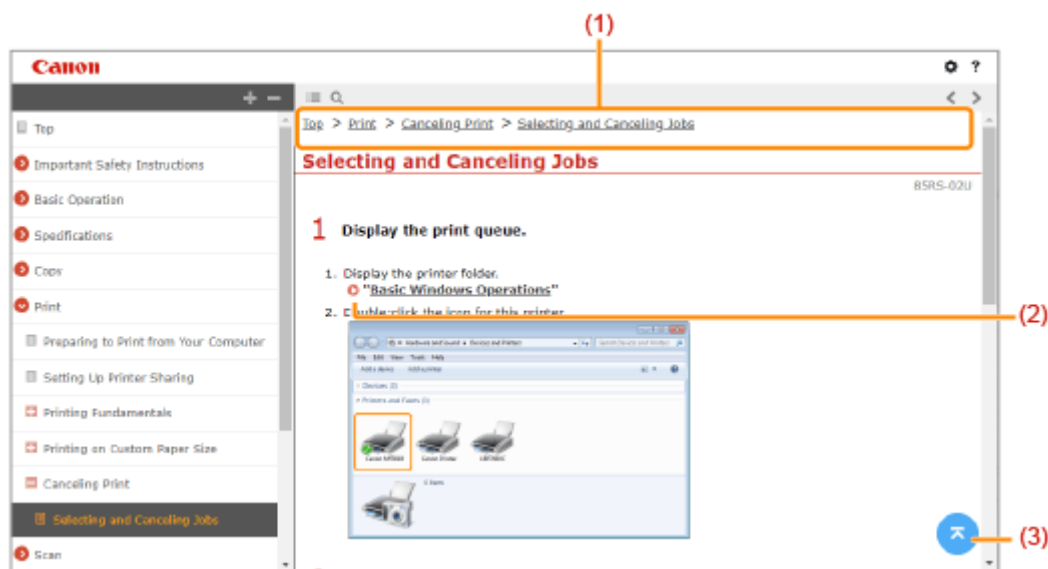

(1) Navigation

See what chapter topic you are currently viewing.

(2)

Click to go to the corresponding page. To return to the previous page, click "Back" on your Web browser.

(3)

Click to return to the page top.

Search Method

85RS-065

Click  to display the search screen. Contains a text box to perform a search by keyword and find the page you are looking for.

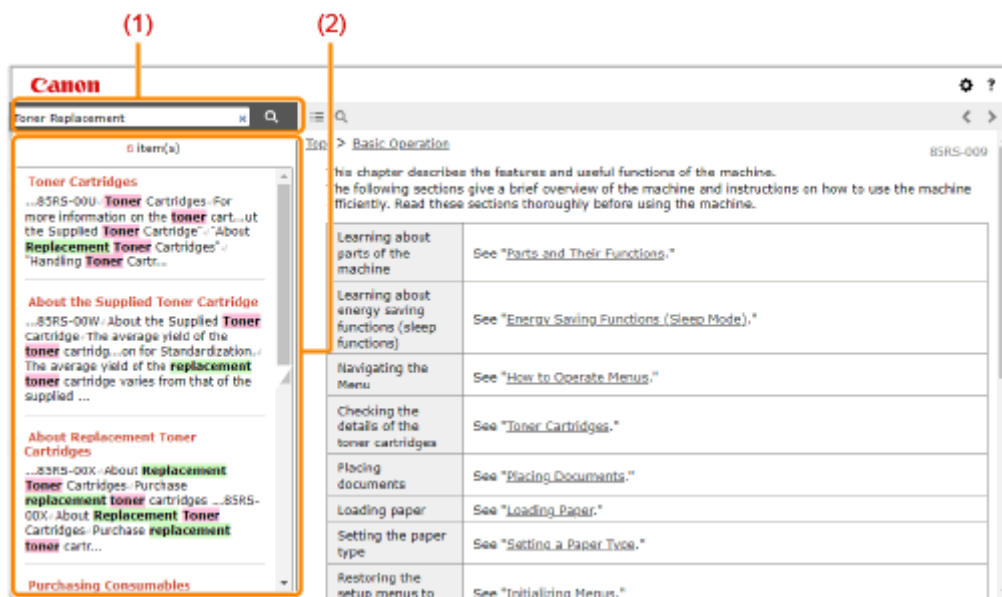

(1) [Enter keyword(s) here]

Enter a keyword or keywords and click  to display the search results. Search for pages containing all keywords by spacing keywords apart. Search for only pages with exact matches by enclosing keyword phrases in double quotation marks.

(2) Search result

Displays the search results of the pages that contain the specified keywords. From the results, locate the page you are looking for and click the topic title of the page.

NOTE

- Specified keywords appear in bold in search results.

Viewing the User's Guide

85RS-066

Symbols Used in the User's Guide

The following are descriptions of warnings and cautions used in the User's Guide to explain handling restrictions, precautions, and instructions that should be observed for your safety.

WARNING

Indicates a warning concerning operations that may lead to death or injury to persons if not performed correctly. To use the machine safely, always pay attention to these warnings.

CAUTION

Indicates a caution concerning operations that may lead to injury to persons if not performed correctly. To use the machine safely, always pay attention to these cautions.

IMPORTANT

Indicates operational requirements and restrictions. Be sure to read these items carefully to operate the machine correctly, and avoid damage to the machine or property.

NOTE

Indicates a clarification of an operation, or contains additional explanations for a procedure. Reading these notes is highly recommended.



Indicates an operation that must not be performed. Read these items carefully, and make sure not to perform the described operations.

Keys and Buttons Used in This Manual

The following are examples of how operation panel keys and on-screen buttons are depicted in the User's Guide.

Type	Depiction in the User's Guide	Example
Operation Panel keys	[Key icon]	[]
Buttons on computer operation screen and so on	[Button name and so on]	[Preferences]

Screenshots Used in the User's Guide

The contents of the screenshots used in the User's Guide are the default settings.

Depending on the system configuration, the contents of the screenshots may partly differ.

※ The functions of the printer driver may be changed due to upgrade.

This Font Software is licensed under the SIL Open Font License, Version 1.1.

This license is copied below, and is also available with a FAQ at: <http://scripts.sil.org/OFL>

SIL OPEN FONT LICENSE Version 1.1 - 26 February 2007

PREAMBLE

The goals of the Open Font License (OFL) are to stimulate worldwide development of collaborative font projects, to support the font creation efforts of academic and linguistic communities, and to provide a free and open framework in which fonts may be shared and improved in partnership with others.

The OFL allows the licensed fonts to be used, studied, modified and redistributed freely as long as they are not sold by themselves. The fonts, including any derivative works, can be bundled, embedded, redistributed and/or sold with any software provided that any reserved names are not used by derivative works. The fonts and derivatives, however, cannot be released under any other type of license. The requirement for fonts to remain under this license does not apply to any document created using the fonts or their derivatives.

DEFINITIONS

"Font Software" refers to the set of files released by the Copyright Holder(s) under this license and clearly marked as such. This may include source files, build scripts and documentation.

"Reserved Font Name" refers to any names specified as such after the copyright statement(s).

"Original Version" refers to the collection of Font Software components as distributed by the Copyright Holder(s).

"Modified Version" refers to any derivative made by adding to, deleting, or substituting -- in part or in whole -- any of the components of the Original Version, by changing formats or by porting the Font Software to a new environment.

"Author" refers to any designer, engineer, programmer, technical writer or other person who contributed to the Font Software.

PERMISSION & CONDITIONS

Permission is hereby granted, free of charge, to any person obtaining a copy of the Font Software, to use, study, copy, merge, embed, modify, redistribute, and sell modified and unmodified copies of the Font Software, subject to the following conditions:

- 1) Neither the Font Software nor any of its individual components, in Original or Modified Versions, may be sold by itself.
- 2) Original or Modified Versions of the Font Software may be bundled, redistributed and/or sold with any software, provided that each copy contains the above copyright notice and this license. These can be included either as stand-alone text files, human-readable headers or in the appropriate machine-readable metadata fields within text or binary files as long as those fields can be easily viewed by the user.
- 3) No Modified Version of the Font Software may use the Reserved Font Name(s) unless explicit written permission is granted by the corresponding Copyright Holder. This restriction only applies to the primary font name as presented to the users.
- 4) The name(s) of the Copyright Holder(s) or the Author(s) of the Font Software shall not be used to promote, endorse or advertise any Modified Version, except to acknowledge the contribution(s) of the Copyright Holder(s) and the Author(s) or with their explicit written permission.
- 5) The Font Software, modified or unmodified, in part or in whole, must be distributed entirely under this license, and must not be distributed under any other license. The requirement for fonts to remain under this license does not apply to any document created using the Font Software.

TERMINATION

This license becomes null and void if any of the above conditions are not met.

DISCLAIMER

THE FONT SOFTWARE IS PROVIDED "AS IS", WITHOUT WARRANTY OF ANY KIND, EXPRESS OR IMPLIED, INCLUDING BUT NOT LIMITED TO ANY WARRANTIES OF MERCHANTABILITY, FITNESS FOR A PARTICULAR PURPOSE AND NONINFRINGEMENT OF COPYRIGHT, PATENT, TRADEMARK, OR OTHER RIGHT. IN NO EVENT SHALL THE COPYRIGHT HOLDER BE LIABLE FOR ANY CLAIM, DAMAGES OR OTHER LIABILITY, INCLUDING ANY GENERAL, SPECIAL, INDIRECT, INCIDENTAL, OR CONSEQUENTIAL DAMAGES, WHETHER IN AN ACTION OF CONTRACT, TORT OR OTHERWISE, ARISING FROM, OUT OF THE USE OR INABILITY TO USE THE FONT SOFTWARE OR FROM OTHER DEALINGS IN THE FONT SOFTWARE.

Third Party Software

This Canon product (the "PRODUCT") includes third-party software modules. Use and distribution of these software modules (the "SOFTWARE") are subject to the conditions below.

- (1) You agree that you will comply with any applicable export control laws, restrictions or regulations of the countries involved in the event that this product including the SOFTWARE is shipped, transferred or exported into any country.
- (2) Rights holders of the SOFTWARE retain in all respects the title, ownership and intellectual property rights in and to the SOFTWARE. Except as expressly provided herein, no license or right, expressed or implied, is hereby conveyed or granted by rights holders of the SOFTWARE to you for any intellectual property of rights holders of the SOFTWARE.
- (3) You may use the SOFTWARE solely for use with the PRODUCT.
- (4) You may not assign, sublicense, market, distribute, or transfer the SOFTWARE to any third party without prior written consent of rights holders of the SOFTWARE.
- (5) Notwithstanding the foregoing, you may transfer the SOFTWARE only when (a) you assign to a transferee all of your rights to the PRODUCT and all rights and obligations under the conditions governing the SOFTWARE and PRODUCT and (b) such transferee agrees in writing to be bound by all these conditions.
- (6) You may not decrypt, decompile, reverse engineer, disassemble or otherwise reduce the code of the SOFTWARE to human readable form.
- (7) You may not modify, adapt, translate, rent, lease or loan the SOFTWARE or create derivative works based on the SOFTWARE.
- (8) You are not entitled to remove or make separate copies of the SOFTWARE from the PRODUCT.
- (9) The human-readable portion (the source code) of the SOFTWARE is not licensed to you.

ACCEPTANCE

THE TERMS OF THIS THIRD PARTY SOFTWARE STATED HERE OR IN RELATED WARRANTY PROVISIONS SHALL BE DEEMED ACCEPTED UPON YOUR USE OF THE PRODUCT FOR ONE OR MORE OF ITS NORMAL PURPOSES, IF THERE HAS BEEN NO OTHER PRIOR EXPRESS ACCEPTANCE.

THE TERMS OF THIS THIRD PARTY SOFTWARE GOVERN THE THIRD PARTY SOFTWARE AS DELIVERED WITH THE PRODUCT AND ALL UPDATED VERSIONS OF THE THIRD PARTY SOFTWARE PROVIDED UNDER MAINTENANCE AGREEMENTS OR OTHER SERVICE ARRANGEMENTS FOR THE PRODUCT WITH CANON USA OR CANON CANADA OR THEIR RESPECTIVE AUTHORIZED SERVICE ORGANIZATIONS.