

KODAK HERO 9.1 All-in-One Printer



Extended User Guide

Kodak

Eastman Kodak Company
Rochester, NY 14650

© Eastman Kodak Company, 2011

Kodak, EasyShare, Hero, and Perfect Touch are trademarks of Eastman Kodak Company.

Specifications subject to change without notice.

P/N 1K5928

August 2011

Table of contents

1 Printer Overview

Components.....	1
Control panel.....	2
Using the LCD touch screen	3
Home Screen Menu	3
Home Screen Status Icons	4
Home Center Software	6
Ordering supplies.....	7
Configuring printer settings	8

2 Networking Your Printer

Connecting to a wireless network	9
Before you connect	9
Connecting to a wireless network using the Wi-Fi Setup Wizard	10
Setting up an IP Address.....	13
Viewing the network configuration.....	14
Printing the network configuration	14
Installing your printer on additional computers on the network.....	15
Connecting to another KODAK All-in-One Printer	15
Connecting to an Ethernet network	16
Adding a wireless network connection to a USB-connected computer	17
Changing from USB to a wireless connection	17
Changing from USB to an Ethernet connection	18

3 Online Printer Management Tool

Accessing the Online Printer Management Tool	20
Using the Online Printer Management Tool.....	21
Configuring printer settings.....	21
Changing the printer name	22
Adjusting fax settings.....	23
Setting up Scan To Email	25
Setting up Scan To Network Folder	31
Adding a GOOGLE Cloud Print Account.....	35
Adding a KODAK Email Print Account	38
Changing printer settings for copying and printing	39

4 Handling Paper

Paper types.....	42
Paper sizes.....	43
Envelope sizes.....	44
Loading paper	44
Loading paper in the main paper tray.....	44
Loading the photo paper tray	47

Loading envelopes.....	49
Loading originals.....	51
Using the scanner glass.....	51
Using the Automatic Document Feeder (ADF).....	52
5 Printing	
Manually selecting paper trays.....	53
Printing documents.....	54
Printing two-sided documents.....	54
Printing forms from the control panel.....	56
Printing pictures.....	57
Viewing pictures on a memory card or USB-connected device.....	57
Printing from a memory card or USB-connected device.....	58
Printing from a wireless device.....	65
Transferring pictures to a computer.....	65
Transferring pictures to a computer with WINDOWS OS.....	65
Transferring pictures to a computer with MAC OS.....	66
6 Mobile Printing	
Printing from an iPhone, iPad, or iPod Touch.....	67
Printing from a BLACKBERRY Device.....	67
Printing from an ANDROID OS Device.....	68
7 Copying	
Loading originals for copying.....	69
Copying a document.....	69
Using the default settings to copy a document.....	69
Adjusting the settings and copying a document.....	70
Changing the number of copies of a document.....	71
Enlarging or reducing the size of a copy.....	71
Darkening or lightening a copy.....	71
Two-sided copying.....	72
Manual two-sided copying.....	72
Copying a photo.....	73
Using the default settings to copy a photo.....	73
Adjusting the settings and copying a photo.....	74
Changing the number of copies of a photo.....	76
Enlarging or reducing the size of a copy of a photo.....	77
Darkening or lightening a copy of a photo.....	78
8 Scanning	
Before you begin scanning.....	79
Changing the scan settings for scanning from the control panel.....	80
Loading originals for scanning.....	82
Scanning from the control panel.....	82

Scanning to a computer	83
Scanning to a memory card or USB flash drive.....	85
Scanning to email	87
Scanning to network folder	88
Scanning from the computer	89
Scanning multiple pictures simultaneously	90
Scanning from the Online Printer Management Tool	91
9 Faxing	
Before you begin faxing.....	92
Connecting the printer for faxing	92
Entering fax sender information	96
Selecting fax settings.....	97
Working with the phonebook.....	100
Preparing a fax for transmission	102
Printing a fax cover page	102
Loading originals for faxing.....	102
Changing resolution, brightness, and color mode.....	103
Sending a fax	104
Using the phonebook to send a fax.....	104
Using Quick Dial to send a fax	104
Using the numeric keypad to send a fax.....	104
Dialing a recently faxed number.....	105
Sending a fax from your computer.....	105
Receiving a fax	106
Receiving a fax automatically	106
Receiving a fax manually	106
Printing fax reports.....	107
Fax settings report.....	107
Fax confirmation page.....	107
Fax activity log.....	108
Canceling a fax	108
10 Maintaining Your Printer	
General care and cleaning	109
Cleaning the scanner glass and document backing.....	110
Replacing ink cartridges	112
Replacing the printhead	115
Updating the software and printer firmware.....	119
Updating if your printer is connected to a computer with WINDOWS OS	119
Updating if your printer is connected to a computer with MAC OS.....	120
Monitoring and adjusting printer performance	120
Checking ink levels	120
Checking paper levels.....	121

Resetting factory defaults	121
11 Troubleshooting	
Basic troubleshooting	122
Getting help on the Web	124
Status lights.....	125
Power status light.....	125
Wi-Fi status light	125
12 Product and Safety Specifications	
Features and Specifications	126
Print Performance	126
Photo Printing Features.....	126
Copy document features.....	127
Copy photo features	127
Scanning features	127
Main paper tray	127
Photo paper tray	128
Output paper tray	128
Paper types supported	128
Paper sizes supported	128
Ink cartridges	129
Connectivity.....	129
Software support	130
Digital image sources	130
Physical specifications	130
Warranty	131
System requirements	131
Safety information	132
LCD touch screen safety	133
Ink cartridge safety	133
Regulatory Compliance.....	134
FCC Statement.....	134
Canadian Statements	135
European Compliance Statement	135
German compliance statement	135
REACH Article 33 Declarations.....	136
Waste Electrical and Electronic Equipment Labeling	136
ENERGY STAR® Qualified.....	136
Warranty Information	137
Declaration of Conformity.....	138

1

Printer Overview

This printer lets you print, copy, scan and fax pictures and documents. In addition, this printer supports networking, letting you access the printer over a wireless (Wi-Fi) or Ethernet network.

Components



- | | | | |
|----|---|----|--------------------------------------|
| 1 | Control panel | 12 | Front USB port |
| 2 | Automatic Document Feeder (ADF) paper edge guides | 13 | Memory card slot |
| 3 | ADF | 14 | Output tray extender with paper stop |
| 4 | Power cord port | 15 | Scanner glass |
| 5 | USB port | 16 | Scanner lid |
| 6 | Line In phone port | 17 | Front paper-edge guides |
| 7 | Ethernet port | 18 | Paper tray extender |
| 8 | Ext out phone port | 19 | Paper tray |
| 9 | Duplexer | 20 | Left paper-edge guides |
| 10 | Access door | 21 | Photo paper tray |
| 11 | Printhead with ink cartridges installed | | |



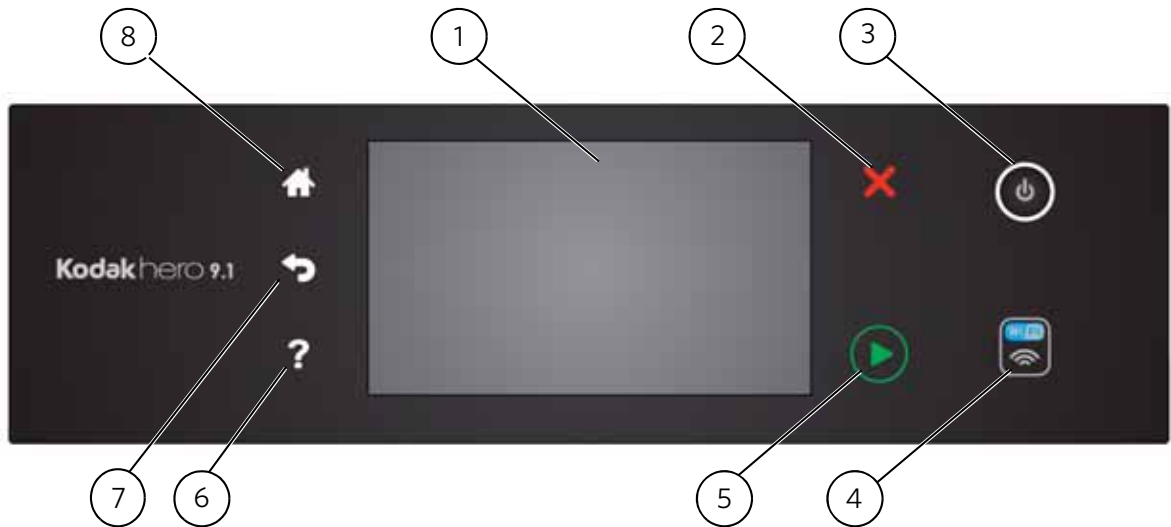



Control panel





Feature	Description
1 LCD touch screen	Displays pictures, messages, and menus
2 Cancel button	Stops the current operation and returns to the previous menu, and closes the Help screen
3 Power button	Turns the printer on or off
4 Wi-Fi connectivity LED	When lit, signals that the printer is connected to a wireless (Wi-Fi) network; blinks when searching for an available Wi-Fi network
5 Start button	Begins copying, scanning, printing, maintenance tasks, and file transfer
6 Help button	Displays context-sensitive help
7 Back button	Displays the previous screen or the next highest screen in the menu hierarchy
8 Home button	Displays the main menu

Using the LCD touch screen

Home Screen Menu

Feature Icon	Displays...
	Copy Document settings and options
	Copy Photo settings and options
	View and Print Photos options and settings
	List of scan to options: Scan to Computer, Memory, USB Flash Drive, Email, and Network Folder. Touching a scan-to option displays settings for that option.
	The list of forms that you can print from the control panel.
	Fax options and settings
	Network settings

Feature Icon	Displays...
	Printer settings
	Cloud Printing options
	Maintenance options

IMPORTANT: Use only your finger to touch the screen; other objects can damage the surface.

- To select a feature, touch the icon.
- To view the features, use the scroll bar:
 - Touch an arrow to scroll in that direction.
 - Touch the scroll bar to move to a different location.

Home Screen Status Icons

Three status icons appear on the Home Screen:



Paper Levels



Ink Levels



Wi-Fi Status

- Touch the Paper or Ink Levels status icons to see information regarding those items.
- Touch the Wi-Fi icon to open the Networking Menu.
- Touch **OK** or  (back) to dismiss the screen.

If an item requires attention, the attention graphic appears on the corresponding status icon. For example, if the level of black ink is low, the attention graphic appears on the ink icon:



Touch the icon to display instructions.

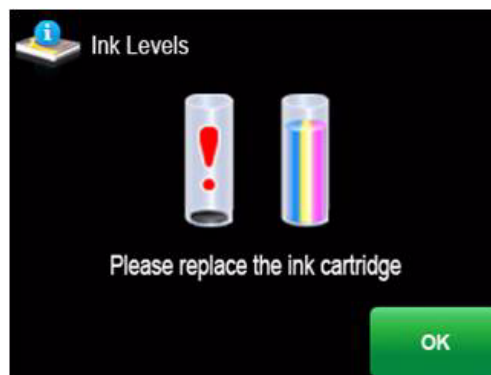

Touch **OK** to return to the Home Screen.

Home Center Software

KODAK Home Center Software is installed with your KODAK All-in-One Printer Software, unless you choose otherwise. The Home Center icon will appear on your desktop.



NOTE: You can choose to install the KODAK AiO Printer Software Essentials, which include the drivers and Printer Tools only.

On a computer with WINDOWS Operating System (OS), you can use Home Center Software to:

- browse, crop, enhance, and edit pictures
- print and scan
- make 3D pictures (from picture pairs taken to create 3D pictures)
- print from video
- send images to or print images from KODAK Gallery
- send images to or print images from FACEBOOK Social Network, FLICKR, PHOTOBUCKET, PICASA, SMILEBOX Photo Management Systems, and GOOGLE Docs
- configure your printer
- install new network printers
- upgrade to the latest printer software and firmware
- order supplies
- access the KODAK Tips and Projects Center
- access the KODAK Online Printer Management Tool

On a computer with MAC OS, you can use Home Center Software to:

- scan
- configure your printer
- upgrade to the latest printer software and firmware
- order supplies
- see the status of your printer
- access the KODAK Online Printer Management Tool

Ordering supplies

You can order ink cartridges, paper, and accessories online. An Internet connection is required.

To order supplies directly from Home Center Software:

1. Open Home Center Software.
2. Select **Order Supplies** (on a computer with WINDOWS OS) or select the **Tools** tab, then click **Order Supplies** (on a computer with MAC OS).
3. Select the item(s) you want to buy, then follow the on-screen instructions.





To order supplies from the Web:

- Ink: www.kodak.com/go/printingsupplies
- Paper: www.kodak.com/go/inkjetpaper

Configuring printer settings

NOTE: When you first power on the printer, the LCD prompts you to select the **Language** and **Country/Region**.





To set or change basic printer settings:

1. Press .
2. Touch , then touch **Printer Settings**.
3. Touch the following settings:
 - **Date and Time**
 - Touch  or  to select **Year, Month, Day, Hour,** or **Minute**. Touch each setting to change the values; touch  when you are done.

NOTE: You can also synchronize the printer date and time to your computer using Home Center Software.

- **Button Sounds**
 - Touch **On, Off, Soft,** or **Loud** to set.
- **Time to Low Power**

To conserve energy, you can set your printer to go into a low-power mode after a set amount of time.

- Touch the time to low power (select from 1 to 4 hours in 0.5 hour increments). After the time to low power, the printer enters a low-power (sleep) mode.
- **Tagged Images Printing**
 - Touch **On** or **Off** to set.
- **Language**
 - Touch  or  to scroll through the languages, then touch a selection.
- **Country/Region**
 - Touch  or  to scroll through the countries or regions, then touch a selection.
- **Reset All Settings** (see [Resetting factory defaults, page 121](#))

NOTE: Resetting factory defaults does not change the date and time, language, country/region, or network settings.

- **Printer Info**
 - Touch to display the version of firmware currently running on your printer.
 - **Features Demonstration**
 - This feature is typically used by retailers to demonstrate the printer's features.
4. Press  to return to the Home Screen.

2

Networking Your Printer

This section explains how to configure or change your network settings.

Connecting to a wireless network

To connect your printer to an 802.11 wireless (Wi-Fi) network, use the following procedures.

Before you connect

You need:

- a wireless router.
- to determine whether your wireless router supports Wi-Fi Protected Setup (WPS).

NOTE: If you have specific questions about your router, see your router manufacturer's documentation for more information.

Connecting to a wireless network using the Wi-Fi Setup Wizard

You can use the Wi-Fi Setup Wizard on the printer to connect to your wireless network. Use the procedure that is appropriate for your network setup.

Connecting to a non-WPS wireless router

To connect to your wireless network, you need to know the network name, also called the Service Set Identifier (SSID). You can obtain your network name from the wireless router. See the manufacturer's documentation for more information.

If you have enabled security on your network, you also need to know the security string, which may be a Wired Equivalent Privacy (WEP) or a Wi-Fi Protected Access (WPA/WPA2) passphrase.

Record your network information using the correct uppercase and lowercase letters.

Network Name (SSID): _____



Security String (case-sensitive): _____

1. Press .
2. Touch , then touch **Network Settings**.
3. Touch **Wi-Fi Setup Wizard**.

NOTE: The Wi-Fi radio turns on automatically when you select Wi-Fi Setup Wizard.

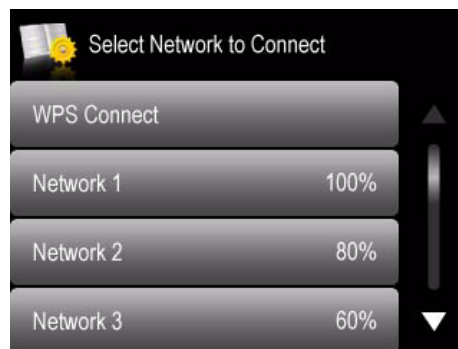
The Wi-Fi connectivity LED blinks as the printer searches for available wireless networks within range, then displays the list in order of signal strength. For example:



If there are additional networks that can be shown on the LCD, touch  or  to view them.

4. Touch your network name.

If you don't see your network in the list, or you want to change your network, touch **Rescan for Wireless Networks**.

NOTE: If the name of your network is not listed, make sure your wireless router is turned on and within range.

5. If your network requires a password, use the LCD keyboard to enter your Security String. The Security String is case-sensitive. When you are finished, touch **OK**.



6. When the confirmation message appears, touch **OK**.



When the printer is successfully connected, the Wi-Fi connectivity LED will stop blinking and remain lit.

The printer with a wireless connection is listed as the name of the printer plus a number (for example, KodakHERO9.1+0229)

7. If you haven't installed the KODAK All-in-One Printer Software:
 - a. Go to www.kodak.com/go/aiodownloads.
 - b. In the results list, click the link for KODAK All-in-One Printer Software for your computer's operating system.
 - c. Follow the on-screen instructions.

Connecting to a WPS wireless router

If your router supports Wi-Fi Protected Setup (WPS), use WPS Connect. WPS lets you configure your printer for a wireless network by pressing buttons or entering a PIN.

To connect to a network using WPS:

1. Press .
2. Touch , then touch **Network Settings**.
3. Touch **Wi-Fi Setup Wizard**.

NOTE: The Wi-Fi radio turns on automatically when you select Wi-Fi Setup Wizard.

4. Touch **WPS Connect**.

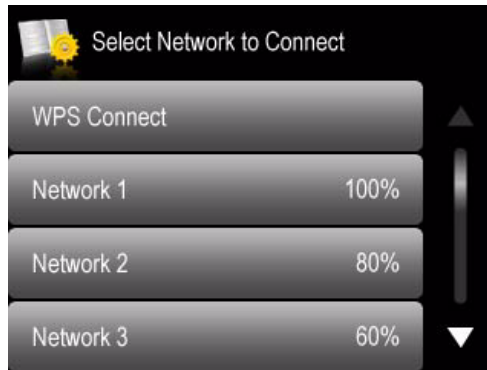

5. Select one of two methods of connecting:

IMPORTANT: Before you make a selection on the printer, make sure you know where the router's push button is, or where to enter the generated PIN. If necessary, consult your Internet Service Provider or router device manufacturer's documentation for more information.



Pressing a button	Entering a PIN
<p>NOTE: You will have two minutes to press or select the WPS button. It may be a button on the device or a virtual button in the device's software.</p> <ol style="list-style-type: none"> a Touch Push Button Configuration. b Press or select the WPS button for your wireless router. c Touch OK on the control panel. 	<ol style="list-style-type: none"> a Touch Generate WPS PIN. b In your wireless router's software, locate the PIN screen. c Enter the PIN you received on the LCD into the PIN screen, then follow the router's instructions. d Touch OK on the control panel.

6. When the confirmation message appears, touch **OK**.
When the printer is successfully connected, the Wi-Fi connectivity LED stops blinking and remains lit.
The printer with a wireless connection is listed as the name of the printer plus a number (for example, KodakHERO9.1+0229).
7. If you haven't installed the KODAK All-in-One Printer Software:
 - a. Go to www.kodak.com/go/aiodownloads.
 - b. In the results list, click the link for KODAK All-in-One Printer Software for your computer's operating system.
 - c. Follow the on-screen instructions.

Setting up an IP Address

IMPORTANT: *You should only need to set up an IP Address for your printer if you are having a problem connecting your printer to a wireless network. Typically, it is not necessary to set up an IP Address. This procedure is for advanced users who know how to obtain the IP Address for the printer.*

To set up your IP Address on the printer:

1. Press .
2. Touch , then touch **Network Settings**.
3. Touch **Advanced IP Address Setup**.
4. Touch **Yes** to continue.
5. Touch one of the following:
 - **Dynamic (DHCP)**
 - **Manual (Static)**
6. If you selected **Manual (Static)**, you are prompted to enter an IP Address, a Subnet Mask, a Gateway Address, and a DNS Server address. Touch **OK** after each entry. Use the LCD keyboard to enter each digit of the numbers.
Consult your Internet Service Provider or network administrator for more information.

Viewing the network configuration

To view the network configuration and verify that you are connected to your wireless network:

1. Press .
2. Touch , then touch **Network Settings**.
3. Touch **View Network Configuration**.

The wireless or Ethernet network settings appear on the LCD, including:



- Printer Hostname
- Connection
- Speed
- IP Address
- IP Address Type
- Network Subnet
- Connected Network SSID
- Security
- Authentication
- Channel
- Region
- Radio (on/off)
- MAC Address

When the printer is connected to your network, you will see the network name and the word CONNECTED.

4. To scroll through the information, touch .
5. When you are done viewing your configuration, touch **OK**.

Printing the network configuration

To print the current network configuration:

1. Load plain paper into the printer. (See [Loading paper in the main paper tray, page 44.](#))
2. Press .
3. Touch , then touch **Network Settings**.
4. Touch **Print Network Configuration**.

Installing your printer on additional computers on the network

To add your printer to another computer(s) on your network, install the KODAK All-in-One Printer Software on each computer.

1. Go to www.kodak.com/go/aiodownloads.
2. In the results list, click the link for KODAK All-in-One Printer Software for your computer's operating system.
3. Follow the on-screen instructions.

Connecting to another KODAK All-in-One Printer

If you are connecting to a newer model printer (for example, you have an ESP 9250 Printer and now you are adding a HERO 9.1 Printer), you must install the KODAK All-in-One Printer Software for the newer model.

NOTE: When you install the new software, the printer driver for the ESP 9250 Printer will be uninstalled, and updates for the ESP 9250 Printer will be installed in addition to the driver for the HERO 9.1 Printer.

On a computer with WINDOWS OS:

1. Select **Start > All Programs > Kodak > KODAK Printer Network Setup Utility**.
 - If your wireless printer (example: KodakHERO9.1+0229) **is not** listed:
 - a. Select **No, my printer is not listed**, then click **Next**.
 - b. From the drop-down list, select your printer.
 - c. Select **Network - Wireless/Wi-Fi**, then click **Next**.
When your printer is detected, driver installation begins.
 - If your wireless printer (example: KodakHERO9.1+0229) **is** listed:
 - a. Select the printer that is connected to your network.
 - b. Select **Yes, my printer is listed**, then click **Next**.
When your printer is detected, driver installation begins.
2. When driver installation is complete, click **Done**.

On a computer with MAC OS:

1. Select **Apple > System Preferences**.
2. Under Hardware, select **Print & Fax** or **Print & Scan**.
3. Click **+** in the dialog box.
4. Select your printer from the list.
5. Click **Add**, if required.

Connecting to an Ethernet network

Before you connect, you need:

- an Ethernet network that includes a router, switch, or hub with an Ethernet port.
- a Category 5 (or higher) Ethernet cable.
- to temporarily disable your firewall until the printer is successfully installed and communicating.

To connect to an Ethernet network:

1. Connect the Ethernet cable to the Ethernet port on the back of the printer.

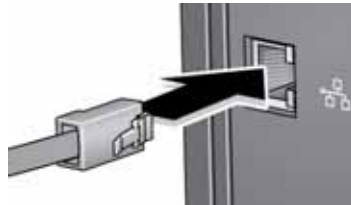

2. Connect the other end of the Ethernet cable to an available Ethernet port on your router, switch, or hub.
3. If you haven't installed the KODAK All-in-One Printer Software:
 - a. Go to www.kodak.com/go/aiodownloads.
 - b. In the results list, click the link for KODAK All-in-One Software for your computer's operating system.
 - c. Follow the on-screen instructions.

Adding a wireless network connection to a USB-connected computer

You can change the way you connect to your printer at any time.

Changing from USB to a wireless connection

To change the printer connection type from USB to a wireless (Wi-Fi) network:

If your printer is connected to a computer with WINDOWS OS:

1. Disconnect the USB cable from your printer and computer.
2. If you have not already done so, connect your printer to your wireless network. See [Connecting to a wireless network, page 9](#).
3. On your computer, disable any firewall you have installed until you have successfully completed the installation.
4. Select **Start > All Programs > Kodak > KODAK Printer Network Setup Utility**.
 - If your wireless printer (example: Kodak HERO 9.1+0229) **is not** listed:
 - a. Select **No, my printer is not listed**, then click **Next**.
 - b. Select your printer from the list, then click **Next**.
 - c. Select **Network - Wireless/Wi-Fi**, then click **Next**.
When your printer is detected, driver installation begins.
 - If your wireless printer (example: Kodak HERO 9.1+0229) **is** listed:
 - a. Select the printer that is connected to your network.
 - b. Select **Yes, my printer is listed**, then click **Next**.
When your printer is detected, driver installation begins.
5. When driver installation is complete, click **Done**.

The printer with a wireless connection is listed as the name of the printer plus a number (for example, Kodak HERO 9.1+0229).

If your printer is connected to a computer with MAC OS:

1. Disconnect the USB cable from your printer and computer.
2. If you have not already done so, connect your printer to your wireless network. See [Connecting to a wireless network, page 9](#).
3. Select **Apple > System Preferences**.
4. Under Hardware, select **Print & Fax** or **Print & Scan**.
5. Click **+** in the dialog box.
6. Select your printer from the list.
7. Click **Add**, if required.

The printer with a wireless connection is listed as the name of the printer plus a number (for example, Kodak HERO 9.1+0229).

Changing from USB to an Ethernet connection

Before you connect, you need:

- an Ethernet network that includes a router, switch, or hub with an Ethernet port.
- a Category 5 (or higher) Ethernet cable.
- to temporarily disable your firewall until the printer is successfully installed and communicating.

To change from a USB connection to an Ethernet network connection:

1. Disconnect the USB cable from your printer and computer.
2. Connect the Ethernet cable to the Ethernet port on the back of the printer.

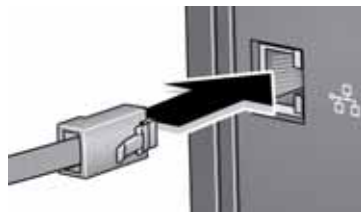

3. Connect the other end of the Ethernet cable to an available Ethernet port on your router, switch, or hub.

If your printer is connected to a computer with WINDOWS OS:

1. Select **Start > All Programs > Kodak > KODAK Printer Network Setup Utility**.
2. Select **No, my printer is not listed**, then click **Next**.
3. Select **HERO 9.1** from the printer drop-down list.
4. Select **Network - Ethernet cable**, then click **Next**.

The Printer Setup Utility searches for your printer and connects automatically.

5. Click **Done**.

If your printer is connected to a computer with MAC OS:

1. Select **Apple > System Preferences**.
2. Under Hardware, select **Print & Fax** or **Print & Scan**.
3. Click **+** in the dialog box.
4. Select your printer from the list.
5. Click **Add**, if required.

Online Printer Management Tool

The KODAK Online Printer Management Tool lets you access your printer through an Internet browser (such as, INTERNET EXPLORER, FIREFOX, SAFARI, CHROME) on any computer that is on the same network as your printer.

IMPORTANT: *Your computer and your printer must be on the same wireless or Ethernet network. The Online Printer Management Tool is not available if your printer is connected to a computer with a USB cable.*

With the Online Printer Management Tool, you can:

- view printer status
- configure (or change) printer settings
- change fax settings and add entries to the Fax phone book
- create Scan to Email and Scan to Network Folder profiles (that you can access from the printer control panel)
- add entries to the Email Address book
- set up accounts for GOOGLE Cloud Print Service and KODAK Email Print Service

Kodak KODAK HERO 9.1 AiO

Home Device Settings Network Applications Links

Welcome to the KODAK Online Printer Management Tool

This tool helps you manage the printer from your computer using a Web browser. You can use it to view status information and change settings.

Device Information

Product Name	KODAK HERO 9.1 AiO
KODAK Service Number	ZDV3241
Firmware Version	FC11.08.01, ENGR

Printer Image Ink Levels Paper Level(s)

Status: Ready



Accessing the Online Printer Management Tool

Access the Online Printer Management Tool in one of the ways described below.

Directly from Home Center Software v7.x or higher:

1. Open Home Center Software.
2. Select **Printer Tools** on a computer with WINDOWS OS, or **Tools** on a computer with MAC OS.
3. Under **Online Printer Tools**, select **Online Printer Management**.
The Online Printer Management Tool will open.

On any printer-supported computer:

1. Get the IP Address of your wirelessly connected printer:
 - a. On your printer control panel, press .
 - b. Touch , then touch **Network Settings**.
 - c. Touch **View Network Configuration**, then touch  until you see your printer IP Address in the format xxx.xxx.xxx.xxx. (See [Viewing the network configuration, page 14](#)).

NOTE: To print the Network Configuration, touch **OK**, then touch **Print Network Configuration**. A Test Page prints, including the IP Address in the format xxx.xxx.xxx.xxx.

2. On your computer, open your preferred Internet browser (such as, INTERNET EXPLORER, FIREFOX, SAFARI, CHROME).
3. Type the printer IP Address in the browser address (URL) bar, then press **Enter**.
The Online Printer Management Tool will open in the browser window.

Using the Online Printer Management Tool

Configuring printer settings

Change the standby time, volume of the button sound, date and time, or reset the setting to the factory defaults.

1. Open the Online Printer Management Tool (see [Accessing the Online Printer Management Tool, page 20](#)).
2. Select the **Settings** tab.
3. Select **Device**.
4. Select **General**, **Date & Time**, or **Reset**, and make any necessary changes.

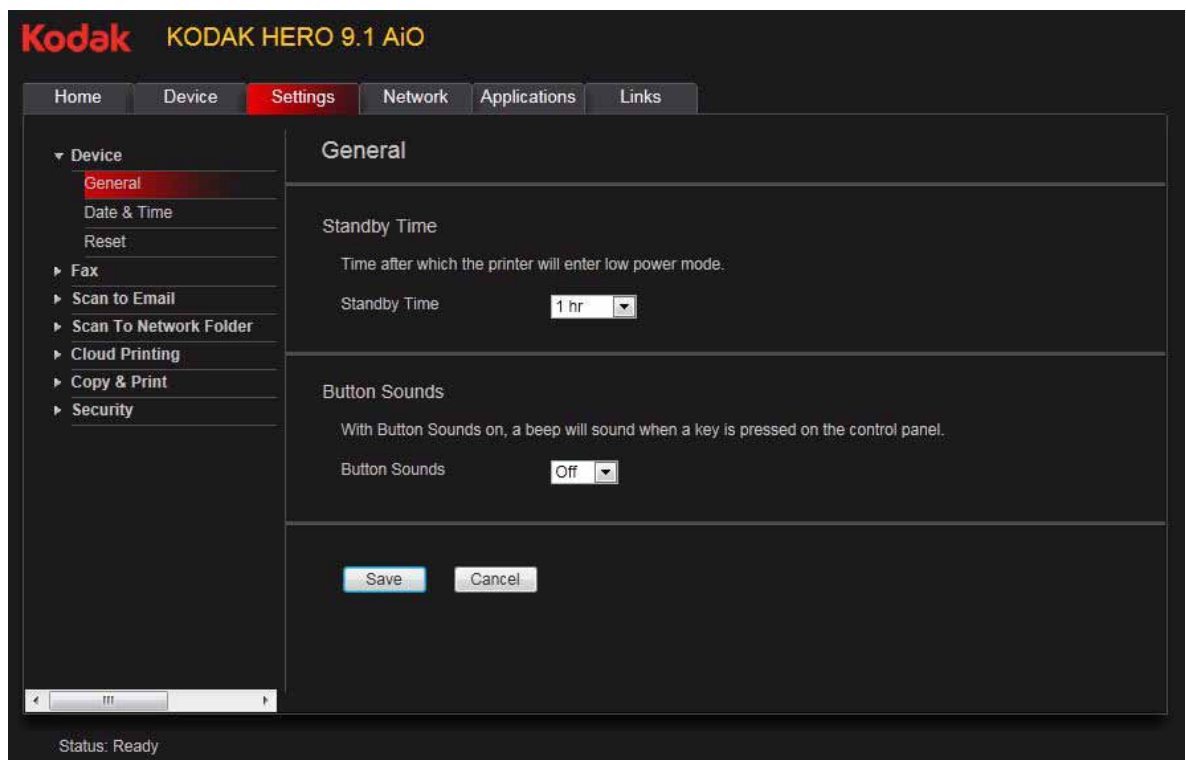

5. Click **Save**.

Changing the printer name

1. Open the Online Printer Management Tool (see [Accessing the Online Printer Management Tool, page 20](#)).
2. Select the **Network** tab.
3. Select **General**, then **Friendly name**, if necessary.
4. Highlight the text in the **Friendly name** field and type the name you want, then click **Save**.

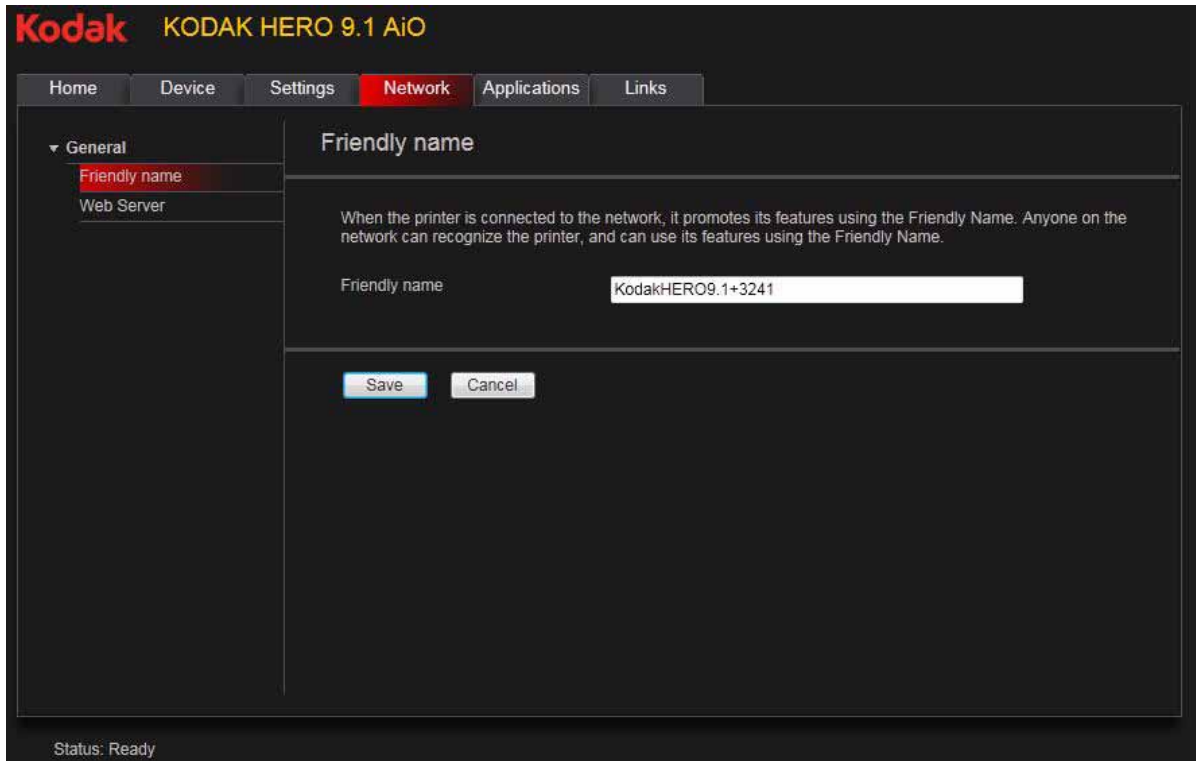

Adjusting fax settings

Edit your phone book, or change the fax settings.

Editing the fax phone book

To edit the fax phone book:

1. Open the Online Printer Management Tool (see [Accessing the Online Printer Management Tool, page 20](#)).
2. Select the **Settings** tab.
3. Select **Fax > Phone Book** in the left pane.

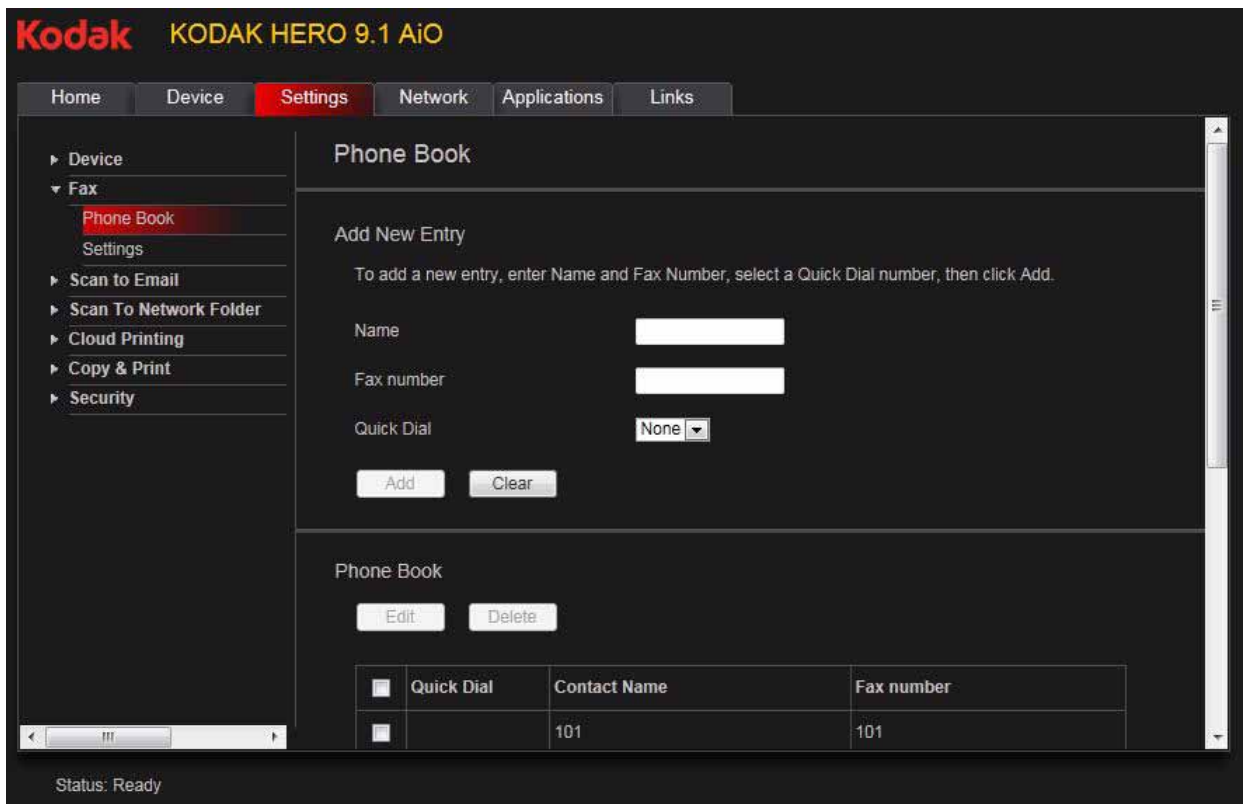

To add a phone book entry:

1. Type the name and fax number, and, optionally, select a quick dial number for your fax entry.
2. Click **Add**.

To edit a phone book entry:

1. Select the check box for an existing entry in the **Phone Book**.
2. Click **Edit**.
3. Make the changes.
4. Click **Save**, then click **OK**.

To delete a phone book entry:

1. Select the check box for an existing entry in the **Phone Book**.
2. Click **Delete**, then click **Yes**.

Changing fax settings

To change fax settings:

1. Open the Online Printer Management Tool (see [Accessing the Online Printer Management Tool, page 20](#)).
2. Select the **Settings** tab.
3. Select **Fax > Settings** in the left pane.

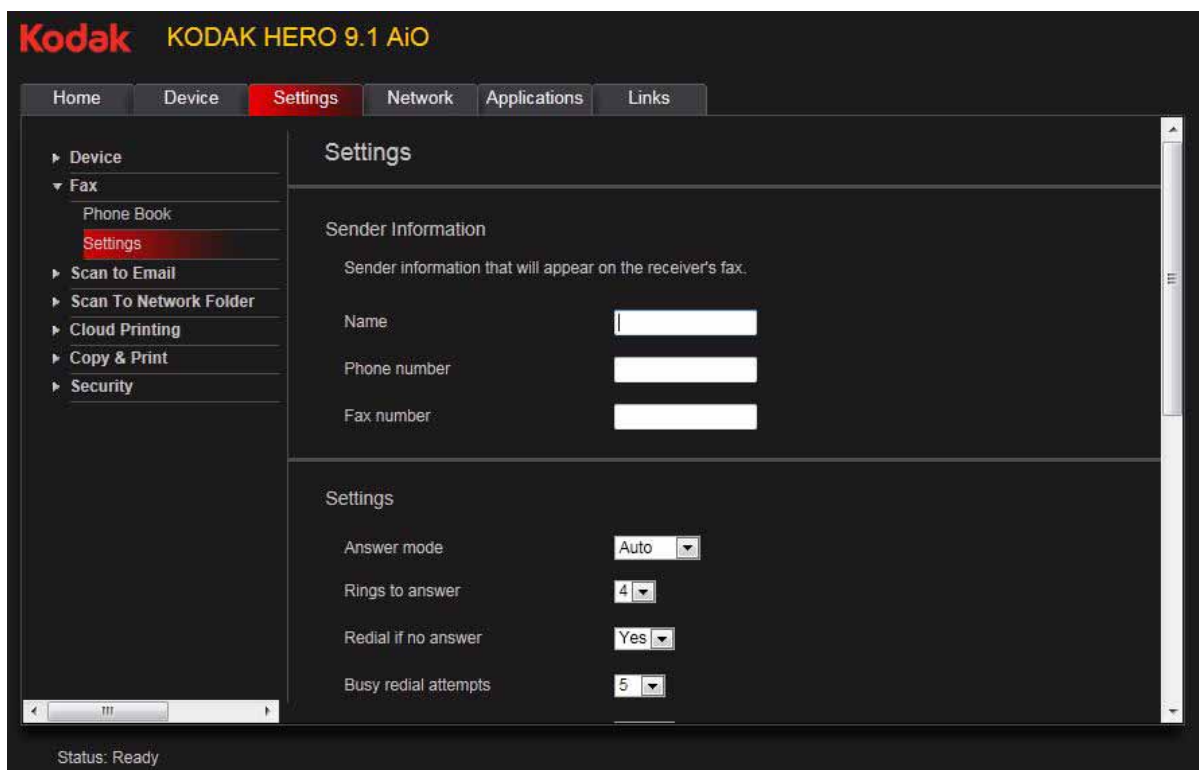

4. Enter the sender information.
This information appears in the header of faxes you send from your printer. (For more information about sender information, see [Entering fax sender information, page 86.](#))
5. Adjust fax any settings, as necessary. (For more information about settings, see [Selecting fax settings, page 87.](#))
6. Click **Save**.

Setting up Scan To Email

When you scan with your printer, you can send the scans directly from the printer to an email recipient. To do so, you must first set up a profile for yourself, and define the email address(es) to which you want to send scans.

Adding an outgoing email profile

1. Open the Online Printer Management Tool (see [Accessing the Online Printer Management Tool, page 20.](#))
2. Select the **Settings** tab.
3. Select **Scan To Email > Email Profile**.

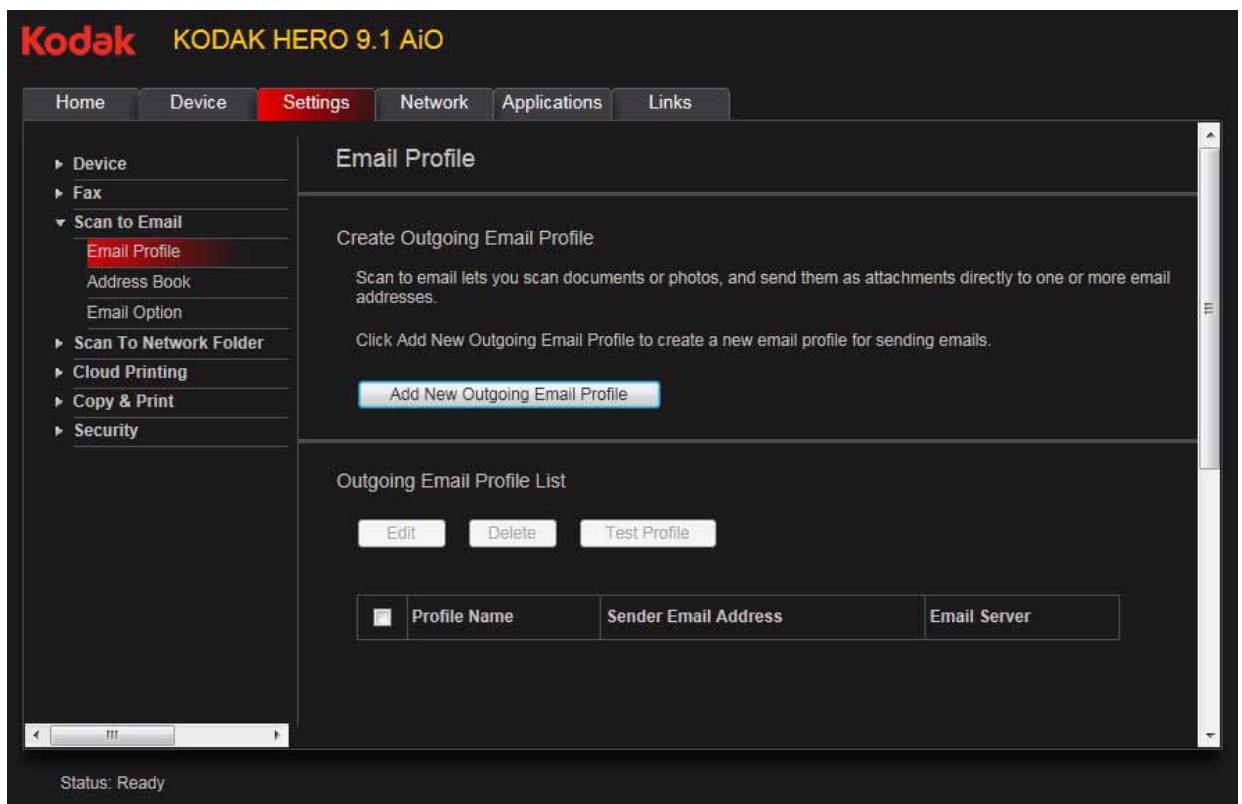

4. Click **Add New Outgoing Email Profile**.

- In the **Profile Name** field, type a name that has meaning to you; for example, your initials and your email provider, such as LR Hotmail or LR Gmail.
This name will appear on the printer control panel when you start a scan to be sent through email.

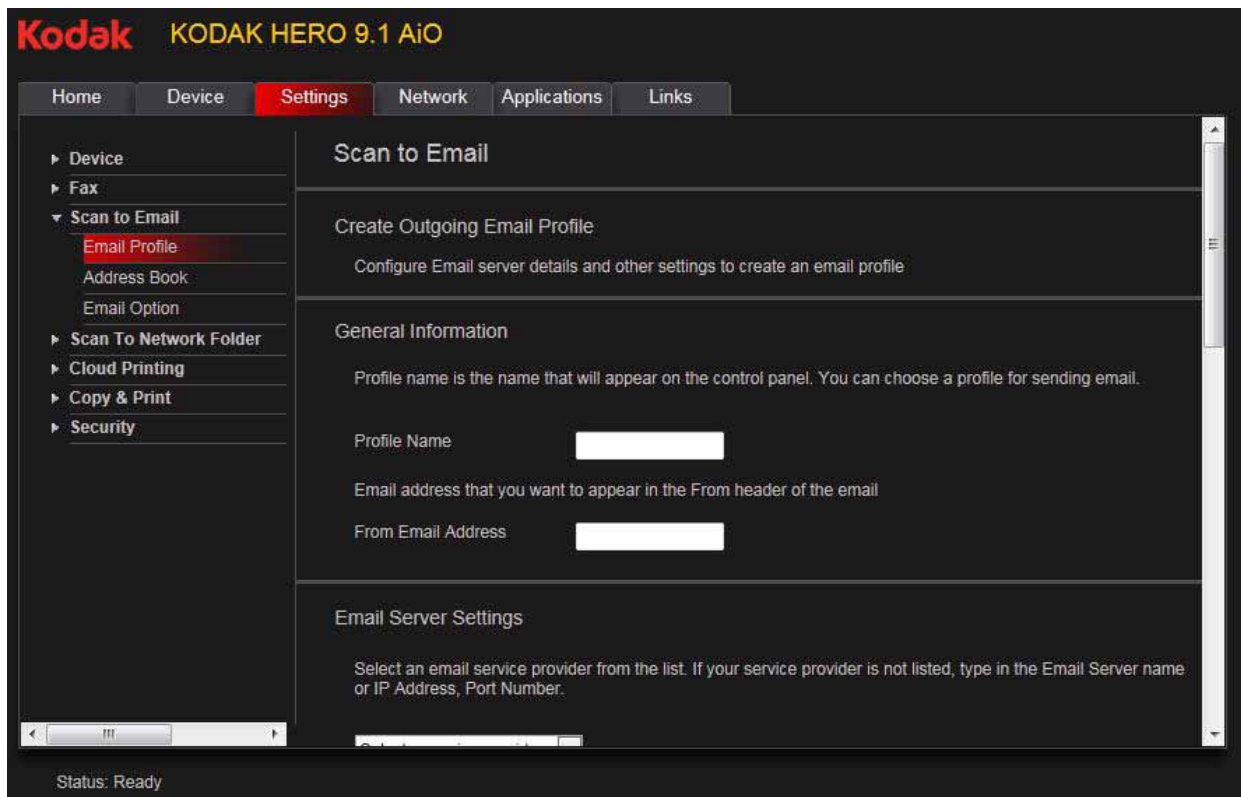

- In the **From Email Address** field, type your email address.
Although the email will be sent from the printer, any replies will go to this email address.

7. Under Email Server Settings, enter your email service provider.
 - If your email service provider is Gmail, Yahoo, AOL, or Hotmail, select your services from the drop-down menu. The Email Service and Port Number fields fill in automatically.
 - If your email service provider is not in the drop-down menu:
 - a. Type the email server name or IP Address of your email service provider in the **Email Server** field.
 - b. Type the port number of your email server in the **Port Number** field.

NOTE: Locate this information in the email account properties fields in your email application.

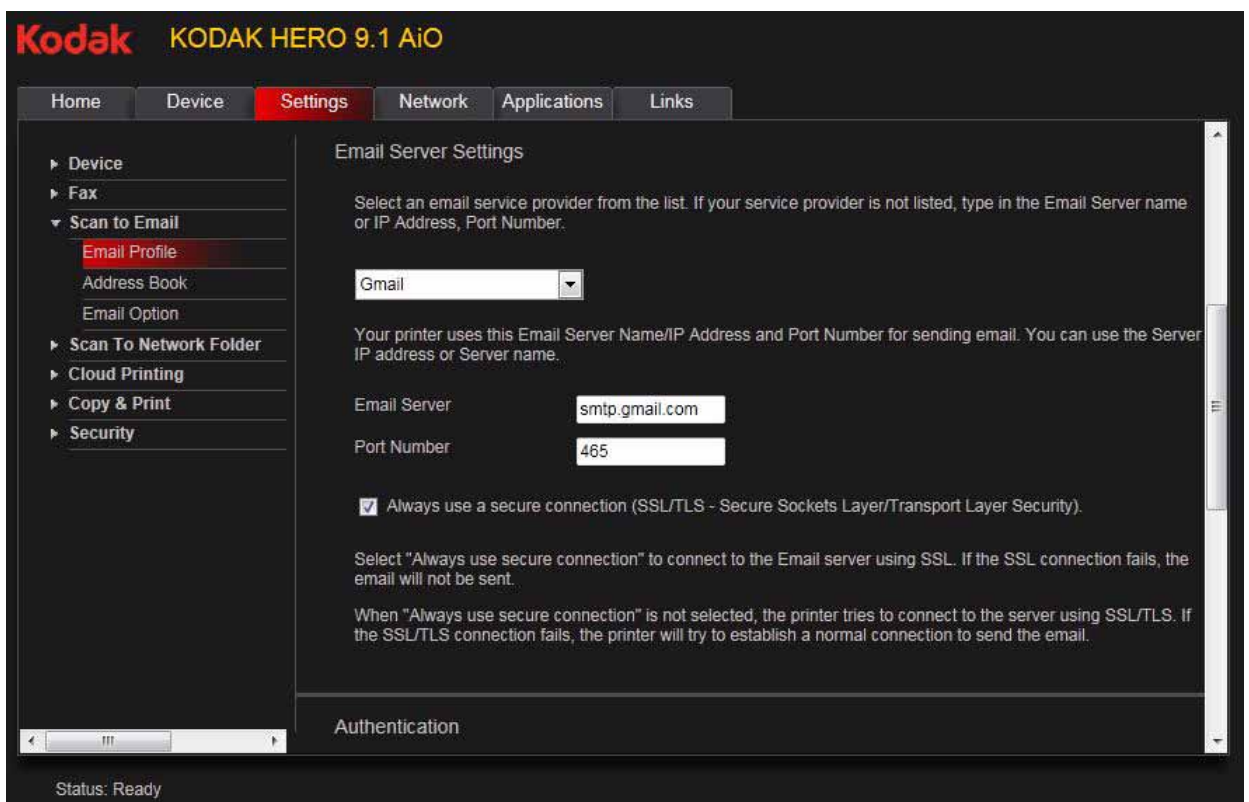

8. If your mail server supports secure connection mode, select the **Always use secure connection** check box.
9. If your email server requires authentication for sending emails:
 - a. Select the **The email server requires authentication for outgoing email** check box.
 - b. Type the **User ID** and **Password** for your email account.

10. If you want to limit who uses your profile (that appears on the printer LCD) to send scans:
 - a. Select the **Enable Access PIN** check box.
 - b. Type a 4-digit numeric **PIN** (your choice). You will need to enter this PIN each time you access your profile when scanning to an email address.
11. If you want a copy of all email messages, select the **Copy sender for all email messages sent from the printer** check box.
12. Click **Test Profile** to confirm that the printer can access your account.
 - If the printer can access your account, "Test profile: Successful" appears. Click **OK**.
 - If the printer cannot access your account, "Test Profile: Failed" appears. Click **OK**, then make changes to your profile.

Setting up the email address book

Enter email addresses of people to whom you want to send scans by email.

1. Open the Online Printer Management Tool (see [Accessing the Online Printer Management Tool, page 20](#)).
2. Select the **Settings** tab.
3. Select **Scan To Email > Address Book**.

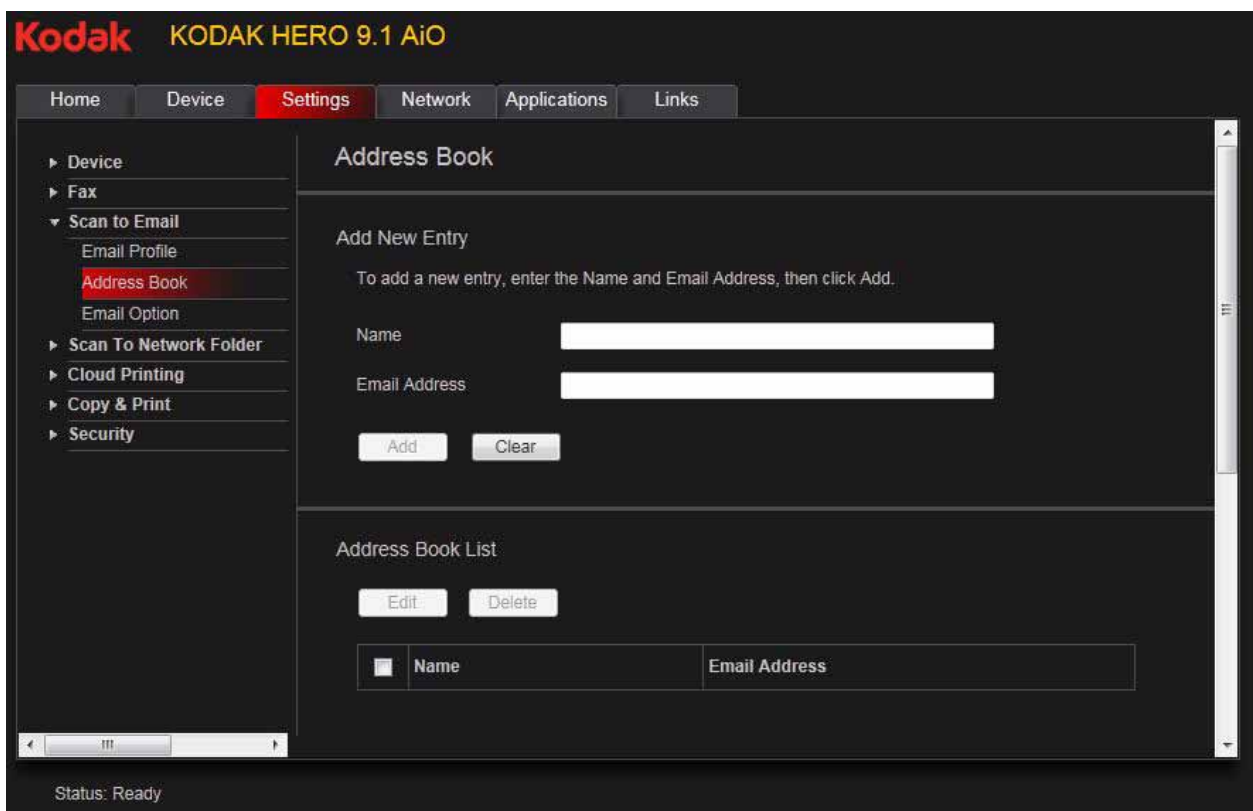

4. For each person:
 - a. Type the person's **Name**.
 - b. Type the person's **Email Address**.
 - c. Click **Add**.
5. When you are finished adding email addresses, click **OK**.

Setting options for scan to email

When you send a scan to an email address, the printer uses defaults — subject line, body, and scan settings — that you set up under email options.

1. Open the Online Printer Management Tool (see [Accessing the Online Printer Management Tool, page 20](#)).
2. Select the **Settings** tab.
3. Select **Scan To Email > Email Option**.

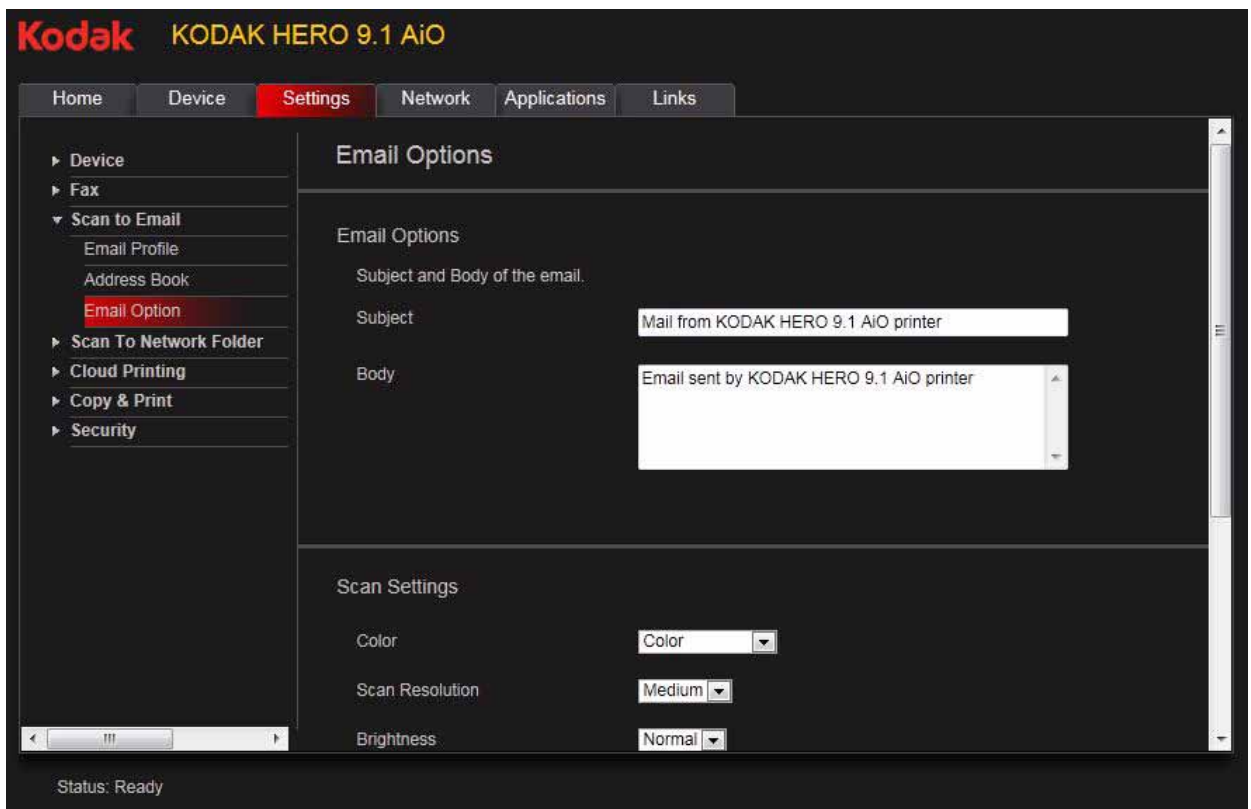

4. Select and replace the default subject line and body text, if necessary.
This subject line and body text will be included with every scan you send to an email address.

5. Select the scan settings that will be used for all scans sent to email:

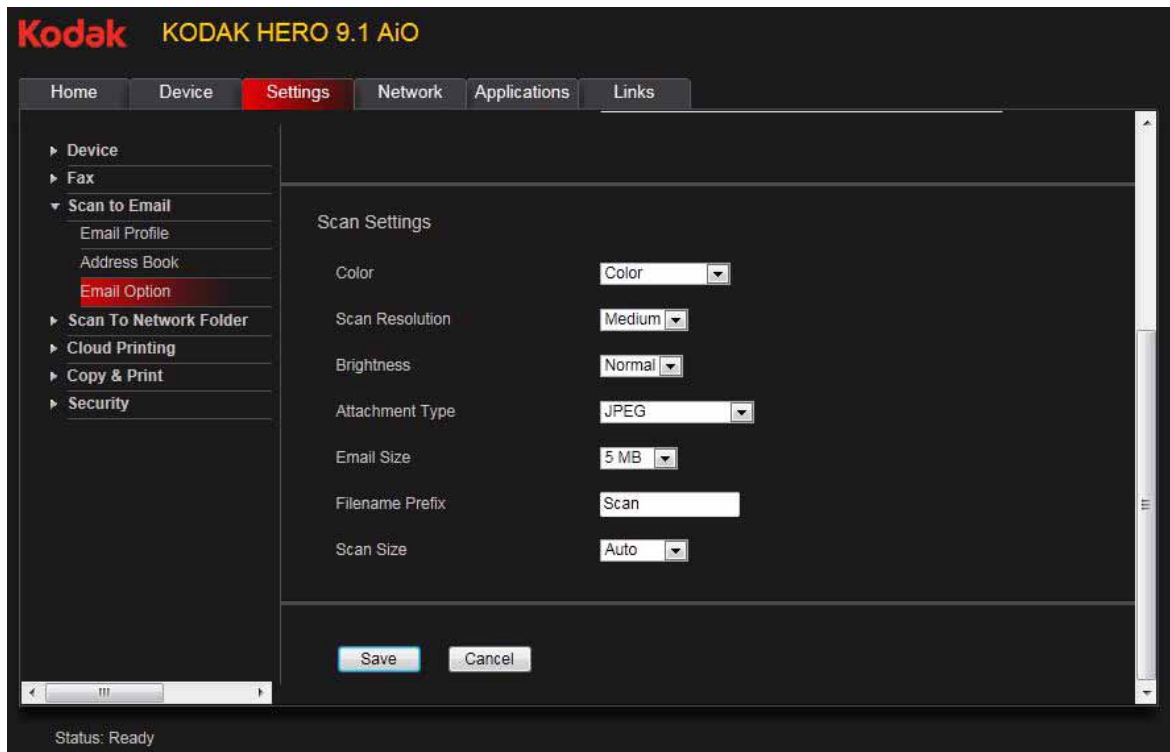

NOTE: You can enter a Filename Prefix of your choice.

6. Click **Save**, then click **OK**.

You can now send a scan to an email address from the control panel. See [Scanning from the control panel, page 82](#).

Setting up Scan To Network Folder

You can scan documents or photos directly to a file in a shared folder on your network.

Before you create a network folder profile

You must identify or create a network shared folder on a computer connected to the same network as your printer before you can create a network folder profile. Note the network name of the folder, including the path information, and the name of the computer where it is located.

To learn more about sharing folders, see the information in the links below.

- For computers with WINDOWS XP OS, see www.microsoft.com/windowsxp/using/networking/maintain/share.mspix
- For computers with WINDOWS VISTA OS, see technet.microsoft.com/en-us/library/bb727037.aspx
- For computers with WINDOWS 7 OS, see windows.microsoft.com/en-US/windows7/File-sharing-essentials
- For computers with MAC OS 10.4, see docs.info.apple.com/article.html?path=Mac/10.4/en/mh1161.html
- For computers with MAC OS 10.5 or later, see support.apple.com/kb/ht1549

Adding a network folder profile

To add a network folder profile that you can access from the control panel:

1. Open the Online Printer Management Tool (see [Accessing the Online Printer Management Tool, page 20](#)).
2. Select the **Settings** tab.
3. Select **Scan To Network Folder > Network Folder Profile**.
4. Click **Add New Network Folder Profile**.

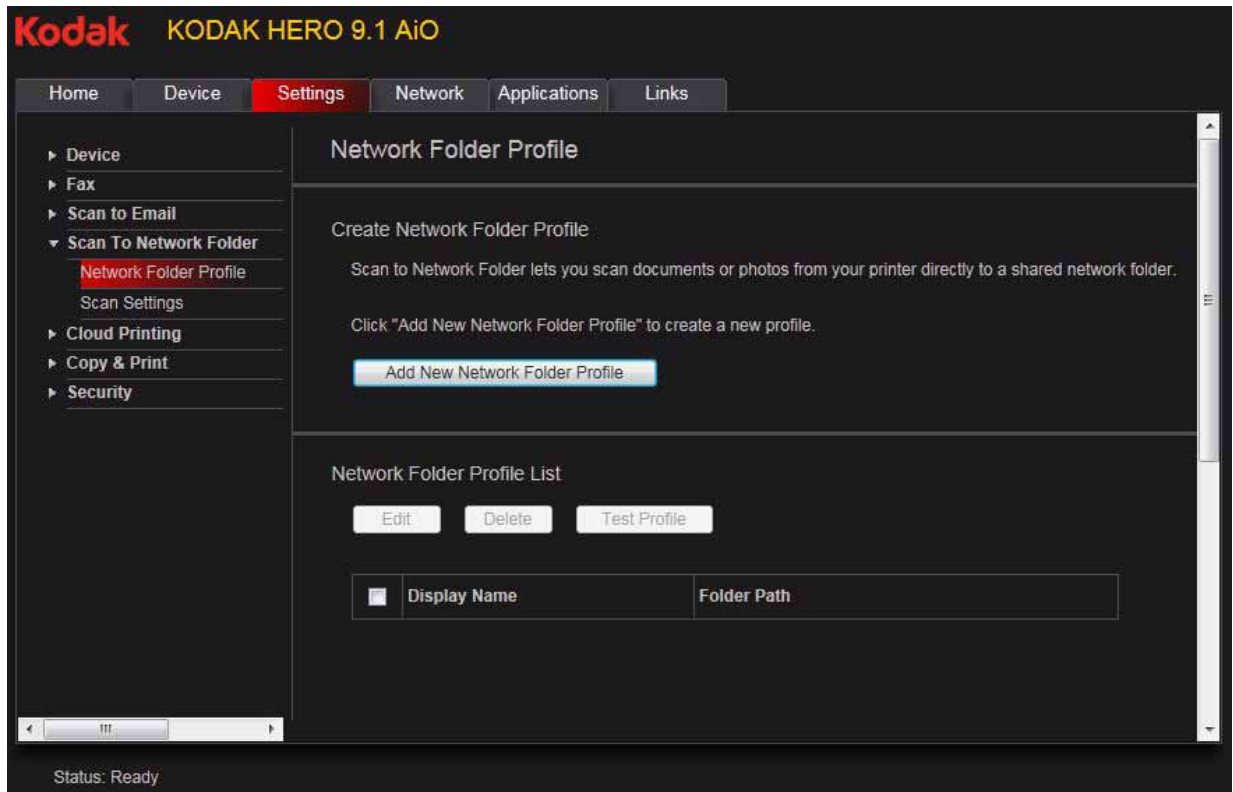

5. Type:
- **Profile Name**
 - **Folder Path**

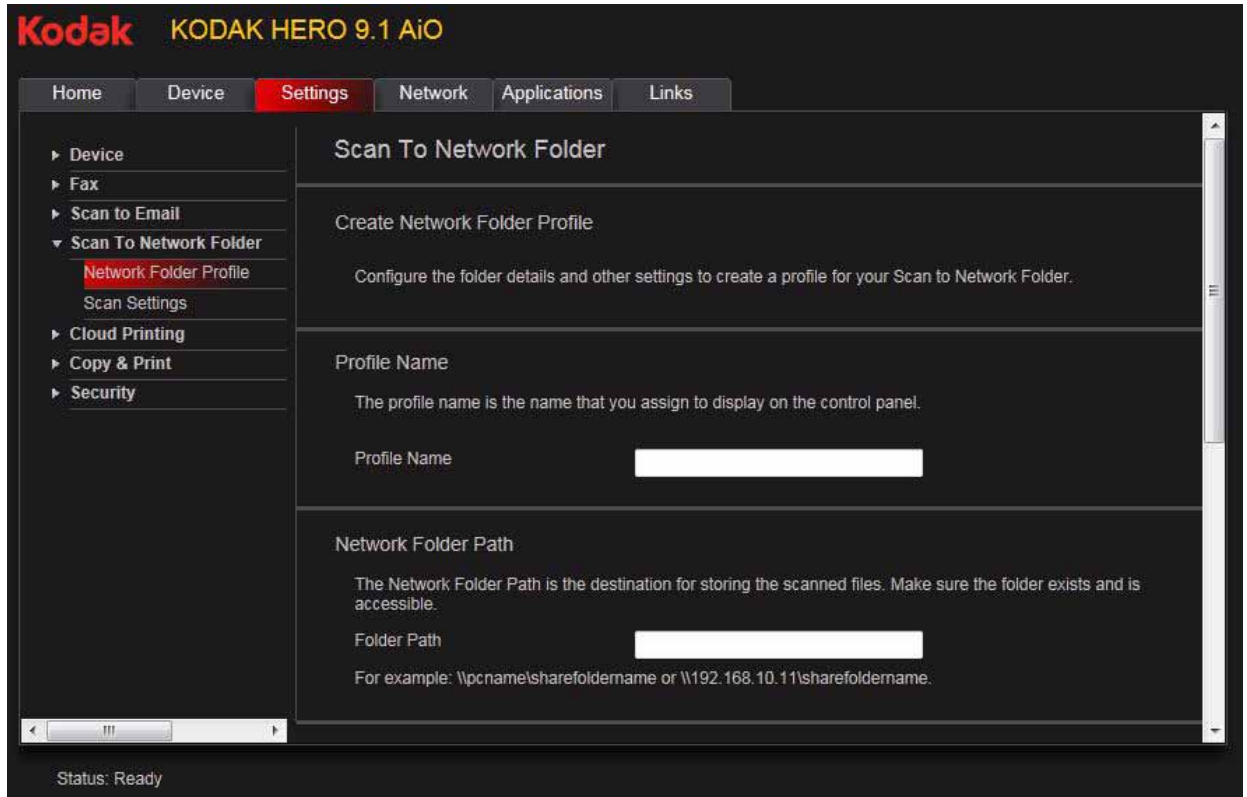

6. If the computer where the folder is located requires authentication to access its shared folders, type the network login **User Name** and **Password**.
7. If you want to limit who uses your profile to scan documents to your network folder:
 - a. Select the **Enable Access PIN** check box.
 - b. Type a 4-digit numeric **PIN** (your choice). You will need to enter this PIN each time you access your profile when scanning to a network folder.
8. Click **Test Profile** to confirm that the printer can access the network folder.
 - If the printer can access the network folder, "Test profile: Successful" appears. Click **OK**.
 - If the printer cannot access the network folder, "Test Profile: Failed" appears. Click **OK**, then make changes to the network folder profile.

You are now ready to scan a document or photo to your network folder from the control panel. See [Scanning from the control panel, page 82](#).

Setting scan settings for scan to network folder

When you send a scan to a network folder, the printer uses defaults that you set up under scan settings.

1. Select **Scan To Network Folder > Scan Settings**.

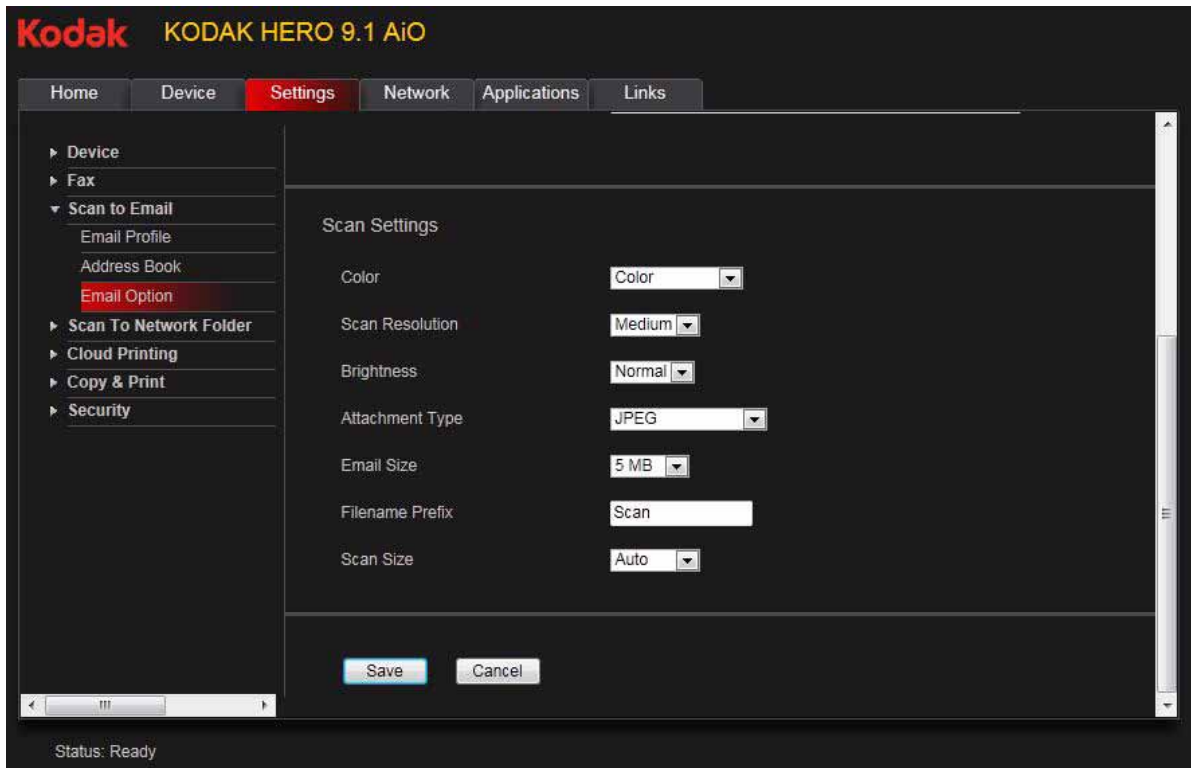

2. Select the scan settings that will be used for all scans sent to a network folder.
NOTE: You can enter a Filename of your choice.

3. Click **Save**.

You can now send a scan to a network folder from the printer control panel. See [Scanning from the control panel, page 82](#).

Adding a GOOGLE Cloud Print Account

Your printer lets you print from anywhere in the world using your smartphone, tablet, or computer that uses GOOGLE Cloud Print enabled apps. You must register your printer with a GOOGLE Account to enable this feature.

1. Open the Online Printer Management Tool (see [Accessing the Online Printer Management Tool, page 20](#)).
2. Select the **Settings** tab.
3. Select **Cloud Printing** > **Google Cloud Print**.
4. Click **Register Printer**.
5. In the **Printer Description** field, type a name that has meaning for you; for example, your initials and your location, such as LR Home or LR Office.

The Friendly Name field is automatically filled in with the printer model number as it appears in the software. You can change your printer name at any time (see [Changing the printer name, page 22](#)).

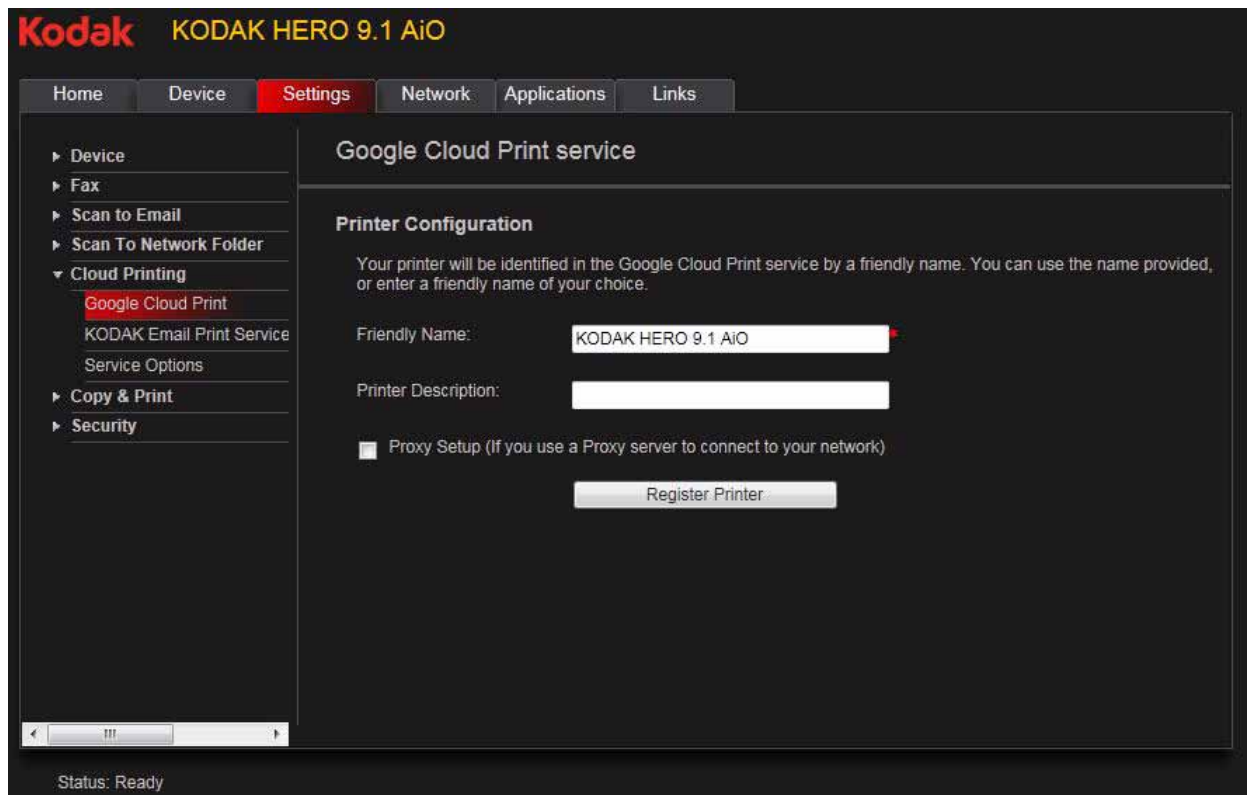

6. If you use a Proxy server to connect to your network:
 - a. Select the **Proxy Setup** check box.
 - b. In the **HTTP Proxy** field, type the Proxy server URL.
7. Click **Register Printer**.

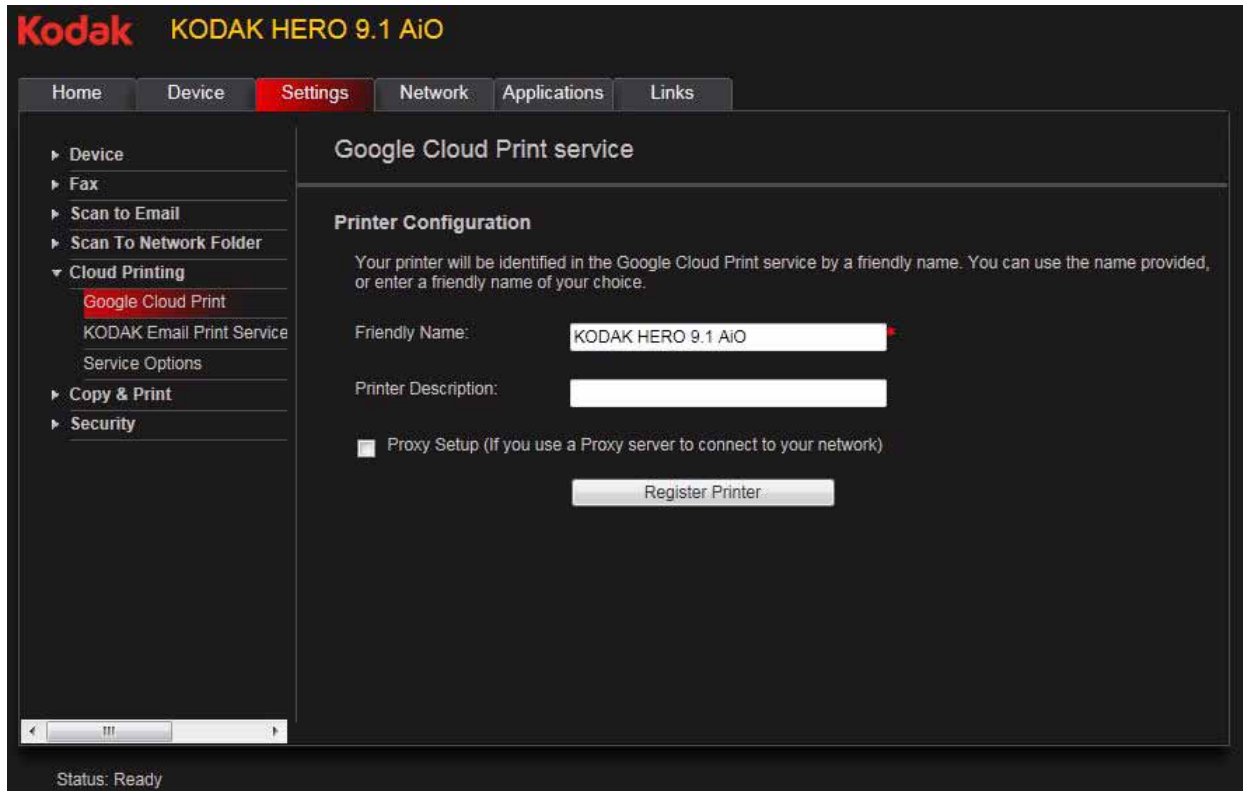

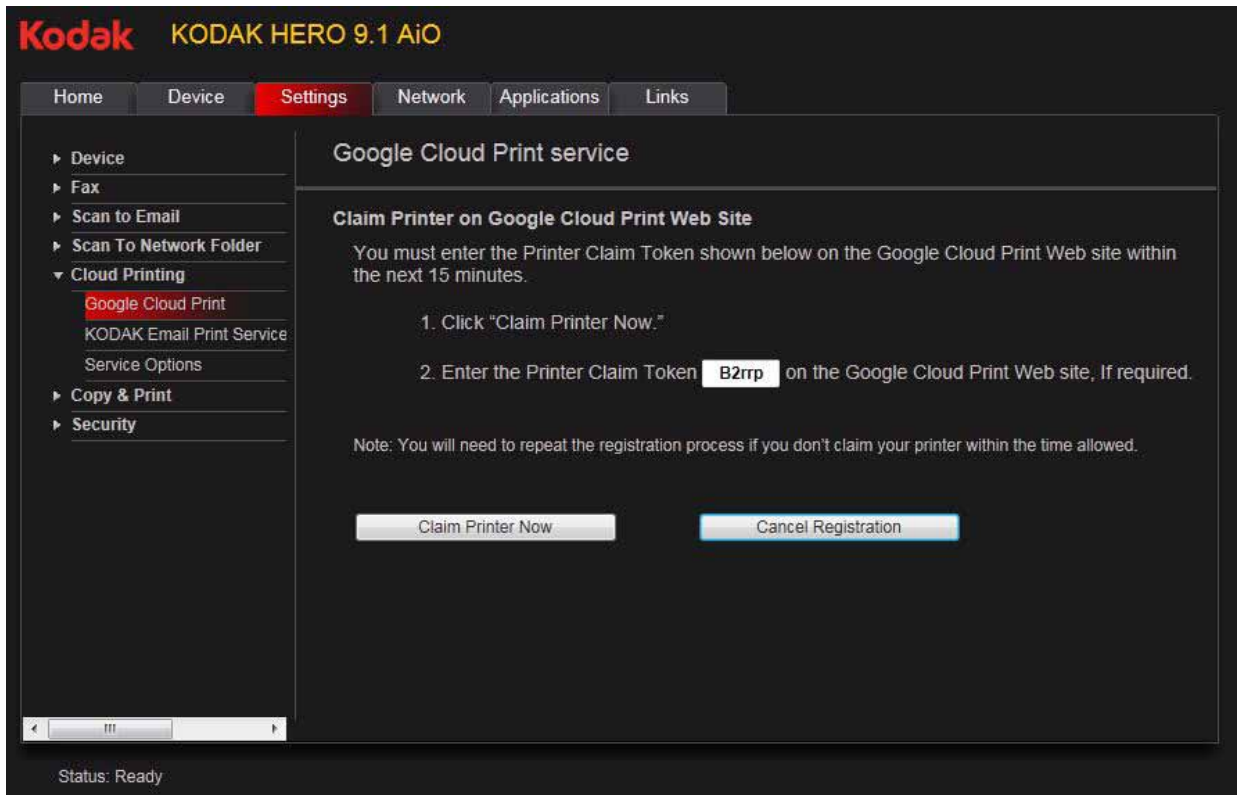
8. Click **Claim Printer Now**.

9. Sign into your GOOGLE Account.

You will be redirected to the GOOGLE Cloud Print Web site. There is no need to manually enter the Printer Claim Token, or click Claim. Your printer will register automatically.

10. Close the browser window.

NOTE: It may take a few seconds for your printer to finish registering. When registration completes, a **Registration Successful** message appears.

Editing a GOOGLE Cloud Print Account

Once you have successfully created an account with Google, you can make edits to various fields.

1. Open the Online Printer Management Tool (see [Accessing the Online Printer Management Tool, page 20](#)).
2. Select the **Settings** tab.
3. Select **Cloud Printing** > **Google Cloud Print**.
4. Click **Edit Settings**.
5. Make the changes you want in the appropriate fields, then click **Save**.

Adding a KODAK Email Print Account

KODAK Email Print lets you send emails and attachments to your printer using any email account. You must sign in with the account you used to set up GOOGLE Cloud Print (see [Adding a GOOGLE Cloud Print Account, page 35](#)).

1. Open the Online Printer Management Tool (see [Accessing the Online Printer Management Tool, page 20](#)).
2. Select the **Settings** tab.
3. Select **Cloud Printing > KODAK Email Print Service**.
4. Click **Get Email Address for KODAK Printer**.

You will be redirected to the KODAK Email Print Service Web site. A page will automatically print with the printer email address and MICROSOFT Tag for adding the email address to your device contacts. Follow the instructions on the screen or on the printed page to scan the tag.

5. Click **Sign In with Google**, if necessary.
6. If you want to control who can send emails to your KODAK Printer email address:
 - a. Next to **Access Control**, click **Edit**.
 - b. Select **Control who can send email (by email or domain)**.
 - c. To add a specific email address, click **Add new Email/Domain**.
 - d. Type the correct information for the email or domain, then click **Save**.
 - e. To delete an email or domain, click **Delete**.

Changing printer settings for copying and printing

You can change the default printer settings for copying documents and photos, and for printing photos.

Changing Copy Document and Copy Photo settings

To change the default printer settings for copying documents:

1. Open the Online Printer Management Tool (see [Accessing the Online Printer Management Tool, page 20](#)).
2. Select the **Settings** tab.
3. Select **Copy & Print > Copy Documents** or **Copy Photo**.
4. Make the changes you want in the appropriate fields, then click **Save**.

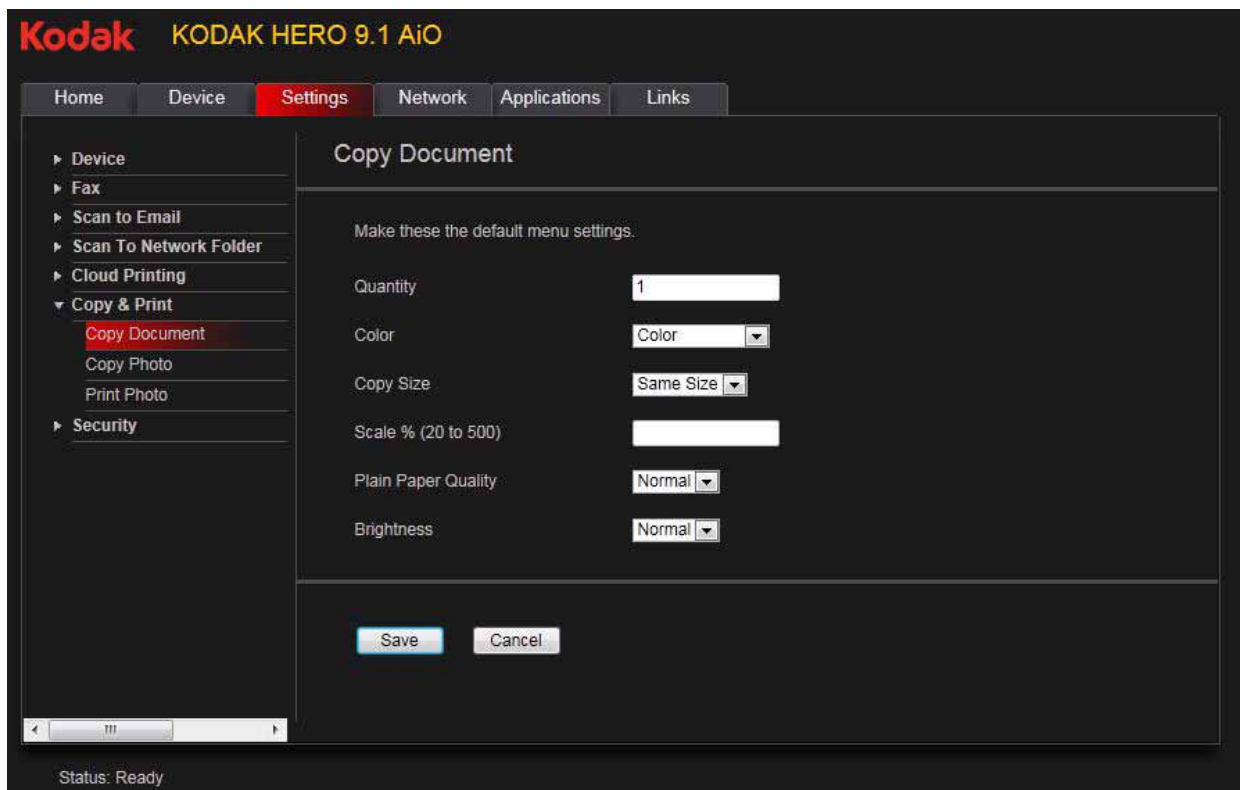

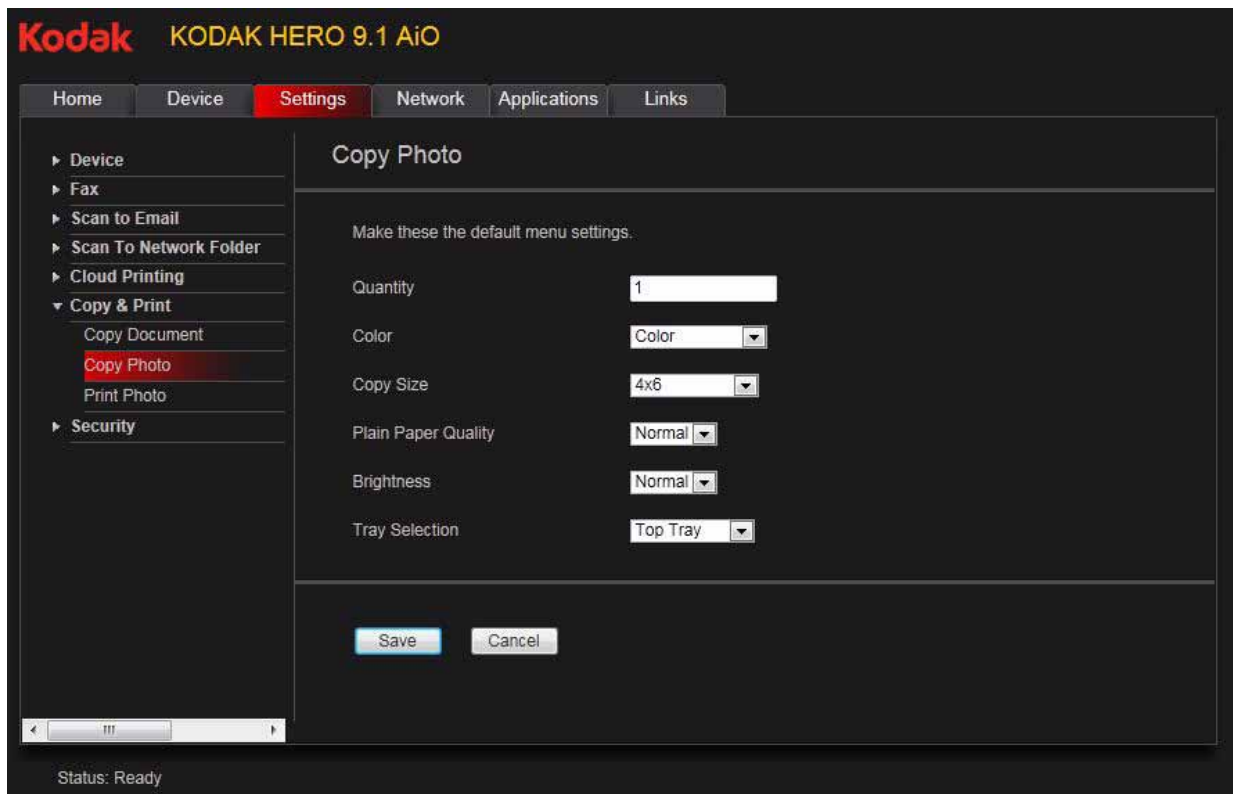

Changing Print Photo settings

To change the default printer settings for printing photos:

1. Open the Online Printer Management Tool (see [Accessing the Online Printer Management Tool, page 20](#)).
2. Select the **Settings** tab.
3. Select **Copy & Print > Print Photo**.
4. Make the changes you want in the appropriate fields, then click **Save**.

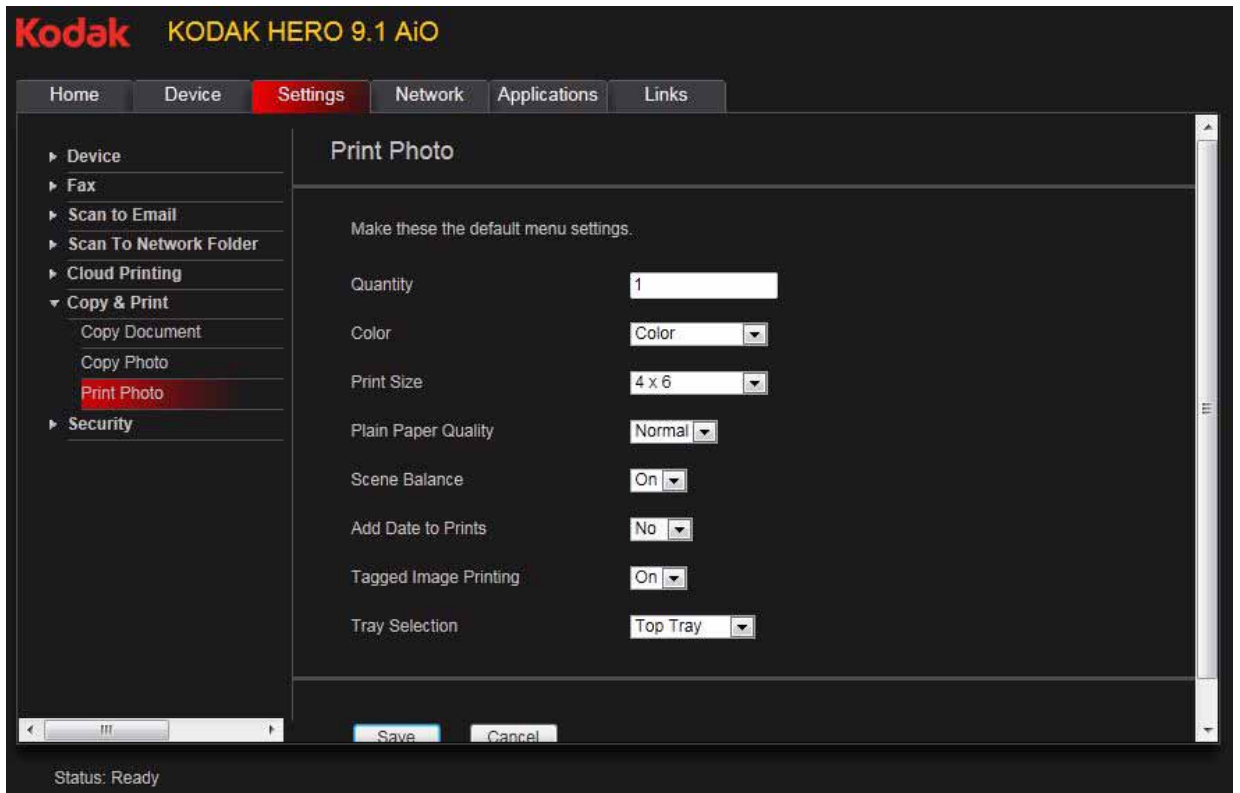

Handling Paper

For the best document printing results, use KODAK Document Papers or a paper with the COLORLOK Technology logo on the package. Use only paper that is designed for inkjet printers.

For the best photo printing results, use KODAK Photo Papers, which are optimized to work with KODAK All-in-One Printers, or photo papers designed for use on pigment-based inkjet printers.

When handling photo paper:

- Hold the paper by the edges; avoid placing your fingerprints on it.
- Do not touch the glossy side of photo paper.
- Store paper flat, away from direct sunlight and heat.

Paper types

You can use:

- Plain paper — 16 to 24 lb / 60 to 90 gsm
- Photo paper — 7 to 12 mils / 290 gsm, maximum
- Card stock — 110 lb / 200 gsm, maximum
- Envelopes — 20 to 24 lb / 75 to 90 gsm
- Transparencies — all commercially available inkjet varieties (with a white stripe on the short edge)
- Labels — all commercially available inkjet varieties on 8.5 x 11-in. or A4 sheets
- Iron-on transfers — all commercially available inkjet varieties on 8.5 x 11 in. or A4 sheets

Paper sizes

This printer has two paper trays, which accept different paper sizes.



The main (bottom) paper tray accepts the following paper sizes:

- 4 x 6 in. / 10 x 15 cm
- 4 x 7 in. / 10 x 18 cm
- 4 x 8 in. / 10 x 20 cm
- 4 x 12 in. / 10 x 31 cm
- 5 x 7 in. / 13 x 18 cm
- 7 x 10 in. / 18 x 25 cm
- US Executive (7.3 x 10.5 in. / 18 x 27 cm)
- 8 x 10 in. / 20 x 25 cm
- US Letter (8.5 x 11 in. / 22 x 28 cm)
- Legal (8.5 x 14 in. / 22 x 36 cm)
- A4 (8.3 x 11.7 in. / 21 x 30 cm)
- A5 (5.8 x 8.3 in. / 15 x 21 cm)
- A6 (4.1 x 5.8 in. / 11 x 15 cm)
- B5 (6.9 x 9.8 in. / 18 x 25 cm)

The photo (top) paper tray accepts the following paper sizes:

- 4 x 6 in. / 10 x 15 cm
- 4 x 7 in. / 10 x 18 cm
- 5 x 7 in. / 13 x 18 cm
- A6 (4.1 x 5.8 in. / 11 x 15 cm)

NOTE: Do not load paper smaller than 4 x 6 in. / 10 x 15 cm in either paper tray.

Envelope sizes

The printer accepts the following envelope sizes (in the main paper tray):

- C5 (6.4 x 9 in. / 16 x 23 cm)
- C6 (4.5 x 6.4 in. / 11.5 x 16 cm)
- DL (4.3 x 8.7 in. / 11 x 22 cm)
- US #7¾ (3.9 x 7.5 in. / 10 x 19 cm)
- US #9 (3.9 x 8.9 in. / 10 x 23 cm)
- US #10 (4.1 x 9.5 in. / 11 x 24 cm)

IMPORTANT: *Do not load envelopes with cutout or clear windows.*

Loading paper

Loading paper in the main paper tray

The main (bottom) paper tray capacity is 100 sheets of plain paper.

1. Raise the output tray, and pull out the main paper tray.



2. Move the left paper-edge guide to the far left.
3. Move the front paper-edge guide forward.



4. Fan and stack the paper, then insert it into the tray.
5. Move the paper forward until it stops.
6. Move both the left and front paper-edge guides until they touch the paper.



7. Push in the main paper tray until it clicks into place, and lower the output tray.



8. Pull out the output tray extender until it is fully extended.
9. Lift the paper stop.

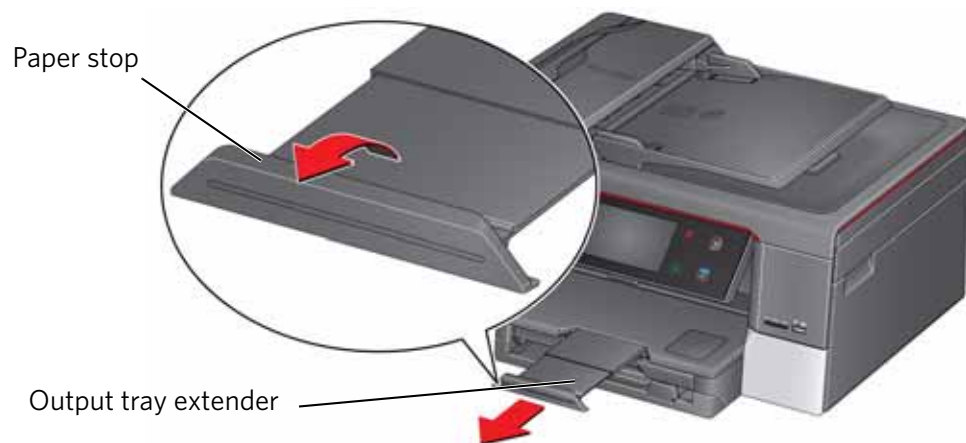

NOTES:

- You can also load photo paper as small as 4 x 6 in. / 10 x 15 cm in the main paper tray.
- When you use legal-size paper, pull out the output tray extender until it is fully extended, but do not lift the paper stop.

Loading the photo paper tray

The photo (top) paper tray capacity is 40 sheets of photo paper.

1. Raise the output tray, and pull out the photo paper tray.



2. Move the left paper-edge guide to the far left.
3. Move the front paper-edge guide forward.



4. Insert photo paper (short side first) up against the right side of the tray with the **logo side facing up** and the glossy side down.

IMPORTANT: *If the photo paper is loaded the wrong way, the ink on your pictures will be wet and the image quality will be affected.*

5. Move the paper forward until it stops.
6. Move both the left and front paper-edge guides until they touch the paper.



7. Push in the photo paper tray until it clicks into place, and lower the output tray.



Loading envelopes

The main (bottom) paper tray capacity is 20 envelopes.

IMPORTANT: *Do not load envelopes with cutout or clear windows.*

1. Raise the output tray, and pull out the main paper tray.



2. Remove any paper from the tray.
3. Move the left paper-edge guide to the far left.
4. Move the front paper-edge guide forward.



5. Insert the envelopes with the flap up and against the right side of the tray.
6. Move the envelopes forward until they stop.
7. Move both the left and front paper-edge guides until they touch the envelopes.



8. Push in the main paper tray until it clicks into place, and lower the output tray.



Loading originals

You can place originals for copying, scanning, or faxing on the scanner glass or in the Automatic Document Feeder (ADF). The ADF automatically feeds the originals into the printer when you begin copying, scanning, or faxing.

NOTE: Keep the scanner glass clean. Any dirt or smudges on the glass will appear as marks on the copy. See [Cleaning the scanner glass and document backing, page 110](#).

Using the scanner glass

To place an original on the scanner glass:

1. Remove any originals from the Automatic Document Feeder (ADF).
2. Lift the scanner lid, and place the document or picture face down in the right-front corner.



3. Close the scanner lid.

Using the Automatic Document Feeder (ADF)

You can load up to 35 originals (20 to 24 lb / 75 to 90 gsm plain paper) in the Automatic Document Feeder (ADF).

The ADF accepts originals in the following sizes:

	Minimum size	Maximum size
English units	6.9 x 9.8 in.	8.5 x 14 in.
Metric units	17.5 x 24.9 cm	21.6 x 35.6 cm

IMPORTANT: *Do not load photographs, cards, or any paper stock heavier than 24 lb / 90 gsm or lighter than 16 lb / 60 gsm in the ADF.*

1. Remove any originals from the scanner glass.
2. Move the ADF paper-edge guides outward.



3. Fan and stack the originals, then insert them face up in the ADF.
IMPORTANT: *Remove all paper clips and staples from the originals.*



4. Move the ADF paper-edge guides until they touch the paper.

The ADF automatically feeds the originals into the printer when you begin copying, scanning, or faxing.

Print documents and lab-quality pictures on your printer.

Manually selecting paper trays

The printer has two paper trays. When you print documents, the printer automatically selects paper from the main (bottom) paper tray. When you print photos, the printer automatically selects paper from the photo (top) paper tray.





To manually select a paper tray when printing from a computer with WINDOWS OS:

1. Open the document you want to print, then select **File > Print**.
2. In the Print dialog box, make sure that **KODAK HERO 9.1 AiO** is selected, then click **Properties**.
3. Select the **General** tab, then in the **Paper settings** field from the **Tray** drop-down list, select **Top tray** or **Bottom tray**.
4. Click **OK** to close the Properties dialog box.
5. Click **OK** to begin printing.

To manually select a paper tray when printing from a computer with MAC OS:

1. Open the document you want to print, then select **File > Print**.
2. In the Print dialog box, make sure that **Eastman Kodak Company HERO 9.1 AiO** is selected.
3. From the **Copies & Pages** drop-down list, select **Printer Options**.
4. From the **Paper Tray** drop-down list, select **Top tray** or **Bottom tray**.
5. Click **Print**.

To manually select a paper tray when printing from the control panel:

1. Press .
2. Touch , then touch **Copy Photo** or **View and Print Photos**.
3. Touch **Options**, then touch  and touch **Tray Selection**.
NOTE: The Top Tray is the default when printing pictures.
4. Touch **Bottom Tray** to select.
5. Press  (Start) to print.

Printing documents

To print a document from your computer:

1. Open the document.
2. Select **File > Print**.
3. In the Print dialog box, select your KODAK Printer.
4. Choose the pages to print, number of copies, etc, then click **OK** (on a computer with WINDOWS OS) or **Print** (on a computer with MAC OS).

Printing two-sided documents

You can print two-sided documents automatically with the built-in duplexer or manually by rotating and reloading the paper after the first side is printed.

Automatic two-sided printing

The duplexer can print two-sided documents automatically on plain paper in standard sizes:

- letter (8.5 x 11 in. / 22 x 28 cm)
- A4 (8.3 x 11.7 in. / 21 x 30 cm)
- B5 (6.9 x 9.8 in. / 18 x 25 cm)

NOTE: The paper width must be 3.9 to 8.5 in. / 10 to 22 cm. The paper length must be 7 to 11.7 in. / 18 to 30 cm.

The duplexer *cannot* print:

- borderless prints
- poster layout

Automatic two-sided printing from a computer with WINDOWS OS

To print two-sided documents from a computer with WINDOWS OS using the duplexer:

1. Load plain paper into the paper tray.
2. Open the document you want to print, then select **File > Print**.
3. In the Print dialog box, make sure that **KODAK HERO 9.1 AiO** is selected (printers with a wireless connection have a 4-digit number added to the end of the name), then click **Properties**.
4. Select the **Layout** tab.
5. In the Two-sided printing field, select **Automatic**.

NOTE: You can also select automatic two-sided printing from the **General** tab under the **Job settings** field.

6. Under "Flip on:", select **Long edge** or **Short edge**, then click **OK**.

7. Click **OK** to start the print request.

Automatic two-sided printing from a computer with MAC OS

To print two-sided documents from a computer with MAC OS using the duplexer:

1. Load plain paper into the paper tray.
2. Open the document you want to print, then select **File > Print**.
3. In the Print dialog box, make sure that **Eastman Kodak Company HERO 9.1 AiO** is selected (printers with a wireless connection have a 4-digit number added to the end of the name).
4. In the **Copies & Pages** drop-down list, select **Layout**.
5. In the **Two-Sided** drop-down list, select either **Long-Edge binding** or **Short-Edge binding**.
6. Click **Print**.

Manual two-sided printing

You can print two-sided documents on any size paper that the printer accepts (see [Paper sizes, page 43](#)) when you rotate the paper manually.

IMPORTANT: *Two-sided printing can only be done on media that can absorb ink on both sides, such as plain paper or two-sided photo paper. Do not print two-sided on bar-coded photo paper (the bar code is on the back side).*

Manual two-sided printing from a computer with WINDOWS OS

To print two-sided documents from a computer with WINDOWS OS:

1. Load paper into the paper tray.
 2. Open the document you want to print, then select **File > Print**.
 3. In the Print dialog box, make sure that **KODAK HERO 9.1 AiO** is selected (printers with a wireless connection have a 4-digit number added to the end of the name), then click **Properties**.
 4. Select the **Layout** tab.
 5. In the Two-sided printing field, select **Manual**, then click **OK**.
- NOTE:** You can also select manual two-sided printing from the **General** tab under the **Job settings** field.
6. Under "Flip on:", select **Long edge** or **Short edge**, then click **OK**.
 7. Click **OK** to start the print request.
 8. When a message appears on your computer and control panel, remove the printed pages from the output tray, then follow the instructions on the control panel.
 9. Press  on the control panel.

Manual two-sided printing from a computer with MAC OS

To print two-sided documents from a computer with MAC OS:



1. Load paper into the paper tray.
2. Open the document you want to print, then select **File > Print**.
3. In the Print dialog box, make sure that **Eastman Kodak Company HERO 9.1 AiO** is selected (printers with a wireless connection have a 4-digit number added to the end of the name).
4. In the Print dialog box, select the **two-sided** check box.
5. Click **Print**.
6. When the even pages have finished printing, follow the instructions on the control panel to reload the printed pages in the paper input tray.
7. Press  on the control panel to print the odd numbered pages.

Printing forms from the control panel

You can print the following forms from the control panel:

- Graph paper
- Wide ruled
- Narrow ruled
- Grocery list
- Reminder list
- Tic-tac-toe
- Sheet music (portrait)
- Sheet music (landscape)

To print a form:

1. Press .
2. Touch , then touch **Forms**.
3. Touch a form type to select it.
4. Use the LCD keyboard to type a quantity, then touch **OK**.
5. Press  on the control panel.

Printing pictures

You can print pictures with your all-in-one printer from:

- A memory card inserted into a memory card slot
- A storage device (such as a flash drive) or camera connected to the front USB port with a USB cable
- An iPhone, iPod touch, iPad, BLACKBERRY Device, or an ANDROID OS Device (may not be available with all models). For information, go to www.kodak.com/go/mobile.

You can also print pictures using Home Center Software from your computer with WINDOWS OS. Home Center Software lets you edit and enhance your pictures quickly. Open Home Center Software, select **Edit and Print Pictures**, then follow the on-screen instructions.

On a computer with either MAC OS or WINDOWS OS, you can print pictures from KODAK EASYSHARE Software or any picture-editing or photo-management software.

Viewing pictures on a memory card or USB-connected device

When you insert a memory card into the card slot on your printer, or connect a USB Device to the front USB port, touch **View Photos** and touch ◀ or ▶ to scroll through the pictures.

Finding pictures on a memory card or USB-connected device

Your printer can help you locate pictures on a memory card or USB-connected device by the date the picture was taken or last saved.

To locate pictures:

1. Insert the memory card into the memory card slot or connect the USB device to the USB port.
2. Touch **Find Photo**.
3. Touch **Year**, **Month**, and **Day** to select a specific year, month, or day.
4. Touch **OK** to view the pictures.

Printing from a memory card or USB-connected device

You can print pictures from the following cards or USB-connected devices:

MS SD/HC MMC Card slot	Front USB port
<ul style="list-style-type: none"> ▪ MULTIMEDIA Card (MMC) ▪ SECURE DIGITAL (SD) Card ▪ SECURE DIGITAL High Capacity (SDHC) Card ▪ Variations of the memory cards above that require an adapter (for example, MEMORY STICK Duo, miniSD, microSD, and T-Flash) 	<ul style="list-style-type: none"> ▪ PICTBRIDGE Technology enabled camera ▪ Flash drive ▪ MSC Cameras (cameras as USB storage device)

IMPORTANT: *If you use a memory card with an adapter, make sure you insert and remove the adapter and the memory card as a unit; do not remove the memory card while leaving the adapter in the printer.*

Using default settings to print a picture

Unless you change the default settings, the default for printing pictures is one 4 x 6 in. / 10 x 15 cm picture. (To change the default settings, see [Save as Defaults](#), page 61.)

To print a picture from a memory card or USB-connected device using the default settings:

1. Insert the memory card into the appropriate slot, or connect the digital camera or portable drive to the front USB port, then touch **View Photos**.

IMPORTANT: Use only one slot or port at a time.



2. Touch ◀ or ▶ to locate the picture you want to print.
3. Press ▶ to begin printing.

The printer prints a single 4 x 6 in. / 10 x 15 cm picture.

IMPORTANT: To prevent loss of data from your memory card, do not remove it from the printer while printing.

Changing the settings and printing pictures

You can change the print photos options for an individual picture or group of pictures, or you can change the settings and save them as the default.

To print a picture or pictures using settings other than the default settings:

1. Load photo paper with the logo side facing up (see [Loading the photo paper tray, page 47](#)), and move the paper edge guides until they touch the paper.
2. Insert the memory card into the appropriate slot, or connect the digital camera or portable drive to the front USB port, then touch **View Photos**.

IMPORTANT: Use only one slot or port at a time.



3. Touch ◀ or ▶ to locate the picture you want to print, then touch ▲ or ▼ to select a quantity.
4. Repeat step 2 for each picture you want to print.
5. Press ↶.
6. Touch ▲ or ▼ and touch the setting you want to change.

Print Photos Option	Settings	Description
Quantity	1 (default) to 99	The number of copies that print.
Color	Color (default)	Prints full color.
	Black & White	Prints black and white (gray scale).

Print Photos Option	Settings	Description
Print Size	4 x 6 (default) 4 x 7 5 x 7 If the bottom tray is selected, the following choices also appear: 4 x 8 4 x 12 8 x 10 8.5 x 11 or A4	If the selected print size is smaller than the paper in the paper tray, the printer automatically arranges the pictures to best fit the paper size.
Tray Selection	Top Tray (default)	Picture prints on the paper in the top tray.
	Bottom Tray	Picture prints on the paper in the bottom tray.
Quality	Best (default)	The printer detects when you load photo paper and sets Best quality automatically.
Scene Balance	On (default) / Off	Adjusts the image brightness to correct for underexposure and reduces the variation in contrast in different areas of the picture.
Add Date to Prints	No (default) / Yes	Prints the date the picture was taken or last edited in a corner of the print.
Transfer All to PC		Your printer and computer must be connected with a USB cable. To transfer all the pictures on the memory card to your computer, press  on the control panel.
<ul style="list-style-type: none"> Save as Defaults 	No (default) / Yes	To save settings as the new default, touch Yes .

NOTE: You can also adjust the print photo options using the Online Printer Management Tool. When viewing the tool in your browser (see [Accessing the Online Printer Management Tool, page 20](#)), select the **Settings** tab, then select **Copy & Print > Print Photo**.

7. When you have finished changing settings, press  to begin printing.

IMPORTANT: To prevent loss of data from your memory card, camera, or portable drive, do not remove it from the printer while printing.

Printing tagged pictures

Some digital cameras let you tag (or “mark”) pictures on the memory card for printing. This creates a tag that is recognized by the printer. If you choose to print tagged pictures, they will be printed according to the default settings on your printer (unless otherwise specified by the tag from the camera).

NOTE: Refer to your camera user guide to determine whether your camera supports tagged pictures (may also be called “marked” or “DPOF”) functionality.

To print tagged pictures:

NOTE: Make sure Tagged Images Printing is On (see [Configuring printer settings, page 8](#)).

1. Insert the memory card or connect a camera to the front USB port.

IMPORTANT: *Use only one slot or port at a time.*



2. When the “Print tagged images?” message appears, press .

Printing panoramic pictures

To print a panoramic picture, load 4 x 12 in. / 10 x 31 cm paper, or 8.5 x 11 in. / 22 x 28 cm or A4 paper in the main paper tray.

1. Insert the memory card into the memory card slot, or connect a camera or storage device (such as a flash drive) to the front USB port, then touch **View Photos**.

IMPORTANT: Use only one slot or port at a time.



2. Touch ◀ or ▶ to locate the picture you want to print, then press ▶.
3. Press 🏠.
4. Touch ▶, then touch **View and Print Photos**.
5. Touch **Options, Tray Selection**, then **Bottom Tray**.
6. Touch **Print Size**, then touch ▼ and touch **4 x 12** to select.
7. Press ▶ to begin printing.

IMPORTANT: To prevent loss of data from your memory card, camera, or portable drive, do not remove it from the printer while printing.

Zooming and cropping pictures

Use the zoom buttons to select a portion of your picture for printing.

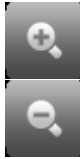

To zoom and crop a picture:

1. Insert the memory card into the appropriate slot, or connect the digital camera or portable drive to the front USB port, then touch **View Photos**.

IMPORTANT: Use only one slot or port at a time.

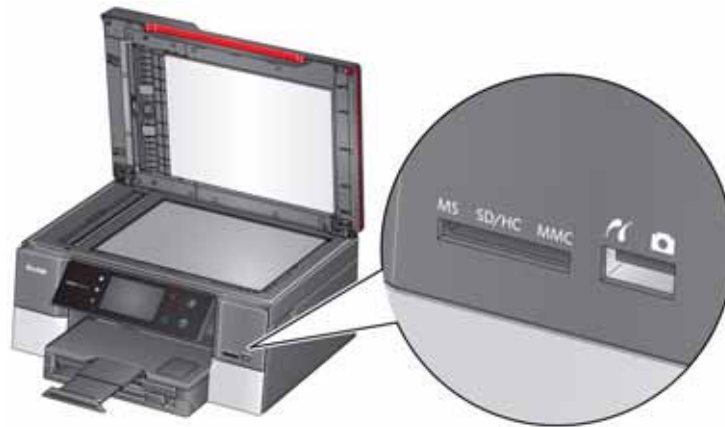



2. Touch ◀ or ▶ to locate the picture you want to crop, then touch .
3. Press **Zoom +** to enlarge the picture. A red box shows the area that will be printed.

NOTE: You can press **Zoom +** repeatedly to enlarge the picture in increments of 0.25 up to a magnification of 5X. Press **Zoom -** to decrease the magnification in increments of 0.25 down to 1X.

4. Use the navigation buttons to move the picture on the LCD up, down, left, or right. Only the part of the picture in the red box will print. The crop window matches the aspect ratio of the selected output print size.

NOTE: Zooming and cropping does not change the saved picture on the memory card.

5. When you are satisfied with the picture, press . The picture appears in the original view with a red box around the portion of the picture that will print.
6. Press  to begin printing.

Printing from a wireless device

You can print pictures wirelessly at the touch of a button from:

- iPhone (iOS 3.0 or later)
- iPod touch (2nd generation)
- iPad
- BLACKBERRY Device (software v4.5 or later)
- a device running ANDROID OS v2.0 or later

For more information, see [Mobile Printing, page 67](#).

Transferring pictures to a computer

You can transfer your pictures from a memory card or USB-connected device in the printer to your computer. To transfer these files, the printer **must** be connected to your computer with a USB cable, and Home Center Software must be installed on your computer.

NOTE: If you have large video files or a large number of pictures (400 or more), we recommend that you use a memory card reader attached directly to your computer to transfer them.

Transferring pictures to a computer with WINDOWS OS

1. Insert the memory card into the memory card slot on the printer.
2. Touch **Options**.
3. Touch **Transfer All to PC**.
4. Press .
5. If your computer is connected to a wireless network and with a USB cable, select the USB-connected printer (no number after the printer name).
6. Follow the on-screen instructions on your computer.

NOTE: You can adjust the Photo print settings using the Online Printer Management Tool. When viewing the tool in your browser (see [Accessing the Online Printer Management Tool, page 20](#)), select the **Settings** tab, then select **Copy & Print > Print Photo**.

Transferring pictures to a computer with MAC OS

1. Insert the memory card into the memory card slot on the printer.
2. Touch **Options**.
3. Touch **Transfer All to PC**.
4. Press .
5. If your computer is connected to a wireless network and with a USB cable, select the USB-connected printer (no number after the printer name).
6. Use iPhoto or Image Capture on your computer to complete the transfer.

NOTE: You can adjust the Photo print settings using the Online Printer Management Tool. When viewing the tool in your browser (see [Accessing the Online Printer Management Tool, page 20](#)), select the **Settings** tab, then select **Copy & Print > Print Photo**.

Mobile Printing

You can print pictures wirelessly with your all-in-one printer from:

- An iPhone / iPad / iPod Touch (may not be available with all models); for information, go to www.kodak.com/go/picflick.
- BLACKBERRY Devices; for information, go to www.kodak.com/go/blackberry.
- ANDROID OS Devices; for information, go to www.kodak.com/go/android.

Download the KODAK Pic Flick App from the App Store directly from your device. Follow the procedure for your device.

Printing from an iPhone, iPad, or iPod Touch

IMPORTANT: Compatible with iPhone, iPad, and iPod Touch (2nd generation). Requires iOS 3.0 or later.

1. Make sure your device is connected to the same Wi-Fi network as your printer.
2. Open the KODAK Pic Flick application on your device.
3. Select the picture(s) you want to print, then select **Choose Device**.
4. Select your KODAK All-in-One Printer from the list of available devices.
5. Select **Send**.

Printing from a BLACKBERRY Device

1. Make sure your BLACKBERRY Device is connected to the same Wi-Fi network as your printer.
2. Open the KODAK Pic Flick application on your smartphone.
3. Select the picture(s) you want to print.
4. Press the **Menu** key.
5. Select **Print**.
6. Select your KODAK All-in-One Printer from the list of available devices.
NOTE: It may take a few minutes for the printer to appear in the Available Printers list.
7. Select the print size and enter the number of copies.
8. Select **Print**.

Printing from an **ANDROID OS Device**

1. Make sure your device is connected to the same Wi-Fi network as your printer.
2. Open the KODAK Pic Flick application on your phone.
3. Select the picture(s) you want to print.
4. Select **View/Edit** to edit the picture(s), or go to the next step.
 - a. Press and hold the screen to enter the edit mode.
 - b. Rotate, move, pan, zoom, or crop the picture.
5. Press **Select Device**, then select your KODAK All-in-One Printer.
6. Choose the print size.
7. Select **Back**.
8. Select **Send**.

You can copy documents and photographs with your all-in-one printer. The printer produces high-quality color or black and white copies on a variety of paper types (see [Paper types, page 42](#)).

Loading originals for copying

You can copy multiple-page documents automatically by loading the originals (up to 35 pages) face up in the Automatic Document Feeder (ADF).

IMPORTANT: *The ADF accepts plain paper originals from 6.9 to 8.5 in. (18 to 22 cm) wide and 9.8 to 14 in. (25 to 36 cm) long.*

To copy a photo, documents on thick paper, or a document that is too small or too large to fit in the ADF, place the original face down on the scanner glass.

For more information on loading originals, see [Loading originals, page 51](#).



Copying a document

You can copy a document using the default settings, or you can make adjustments to the quantity, size, quality, and brightness of your copies. When you copy a document, the printer will always use paper from the main (bottom) paper tray.

Using the default settings to copy a document



The default settings are either the factory default settings (see [Resetting factory defaults, page 121](#)), or defaults that you have set on the printer (see [Save as defaults, page 70](#)).

To copy a document using the current default settings:

1. Place the original document in the ADF or on the scanner glass (see [Loading originals, page 51](#)).
2. Press .
3. Touch **Copy Document**.
4. Press  to begin copying.

NOTE: If you load the original document in the ADF, the ADF automatically feeds the document into the printer when you begin copying.





Adjusting the settings and copying a document

1. Place the original document in the ADF or on the scanner glass (see [Loading originals, page 51](#)).
2. Press .
3. Touch **Copy Document**, then touch **Options**.
4. Touch  or , then touch the setting you want to change.



Copy Document Option	Setting	Description
Quantity	1 (default) to 99	The number of copies that print.
Color Mode	Color (default)	Prints full color.
	Black & White	Prints black and white (gray scale).
Copy Size	Same Size (default)	The copy is the same size as the original.
	Fit to Page	The printer detects the size of the original on the scanner glass and the size of the paper in the paper tray, and automatically reduces or enlarges the original so that the copy fits on the paper.
	Choose Percentage	Reduces to 20% or enlarges to 500% of the original size.
Lighter/Darker	Normal, -3 to +3 (Normal is default)	Lightens or darkens the copy. Normal is no change from the original; -3 is the darkest; +3 is the lightest.
Quality	Normal (default)	Good quality output; prints faster than Best.
	Best	The highest quality, but the slowest print speed; eliminates the banding effect that sometimes occurs when printing Draft or Normal.
	Draft	The fastest print speed, but the lowest quality.
Save as defaults	No / Yes	To save settings as the new default, touch Yes .

5. Press  to begin copying.





Changing the number of copies of a document

1. Place the original document in the ADF or on the scanner glass (see [Loading originals, page 51](#)).
2. Press .
3. Touch **Copy Document**.
4. Touch  or  to select a number.
5. Press  to begin copying.

Enlarging or reducing the size of a copy

1. Place the original document in the ADF or on the scanner glass (see [Loading originals, page 51](#)).
2. Press .
3. Touch **Copy Document**, then touch **Options**.
4. Touch **Copy Size**.
5. Touch an enlargement or reduction selection.
6. Press  to begin copying.

Darkening or lightening a copy



1. Place the original document in the ADF or on the scanner glass (see [Loading originals, page 51](#)).
2. Press .
3. Touch **Copy Document**, then touch **Options**.
4. Touch , then touch **Lighter/Darker**.
5. Touch  to select a number below zero for a darker copy, or press  to select a number above zero for a lighter copy.
6. Press  to begin copying.

Two-sided copying

Manual two-sided copying

If the original is not on letter or A4-sized plain paper, or if you want the copy to be on paper other than letter or A4-sized plain paper, you can make two-sided copies manually.

To make a two-sided copy:

1. Load the paper into the paper tray.
2. Place your original on the scanner glass (see [Using the scanner glass, page 51](#)).
3. Press .
4. Touch **Copy Document**.
5. If necessary, touch **Options** to make changes to the copy settings.
6. Press  to begin copying.
7. Remove the printed page from the output tray and rotate it 180 degrees, then place the page into the paper tray (printed side up).
8. Place the next original on the scanner glass.
9. If necessary, touch **Options** to make changes to the copy settings.
10. Press  to begin copying.

Copying a photo

You can copy a photo using the default settings, or you can make adjustments to the quantity, size, quality, and brightness of your copies. When you copy a photo, the printer will use paper from the top paper tray, unless you specify otherwise.

Using the default settings to copy a photo



The default settings are either the factory default settings (see [Resetting factory defaults, page 121](#)), or defaults that you have set on the printer (see [Save as Defaults, page 75](#)).

To copy a photo using the current default settings:

1. Lift the scanner lid, and place the photo face down in the right-front corner of the scanner glass.



IMPORTANT: Do not load photos in the Automatic Document Feeder (ADF).



2. Close the lid.
3. Press .
4. Touch **Copy Photo**.
5. Press  to begin copying.

Adjusting the settings and copying a photo

1. Lift the scanner lid, and place the photo face down in the right-front corner of the scanner glass.



IMPORTANT: Do not load photos in the Automatic Document Feeder (ADF).

2. Close the lid.
3. Press .
4. Touch **Copy Photo**, then touch **Options**.
5. Touch  or , then touch the setting you want to change.

Copy Photo Option	Setting	Description
Quantity	1 (default) to 99	The number of copies that print.
Color Mode	Color (default)	Prints full color.
	Black & White	Prints black and white (gray scale).
Tray Selection	Top Tray (default)	Copy is made on the paper in the top tray.
	Bottom Tray	Copy is made on the paper in the bottom tray.

Copy Photo Option	Setting	Description
Copy Size	2 x 3 3.5 x 5 4 x 6 (default) 4 x 7 5 x 7 If the bottom tray is selected, the following choices also appear: 4 x 8 4 x 12 8 x 10 8.5 x 11 or A4	The printer enlarges or reduces the original to make it the copy size you select. If the selected copy size is smaller than the paper in the paper tray, the printer automatically arranges the pictures to best fit the paper size.
Lighter/Darker	Normal, -3 to +3 (Normal is default)	Lightens or darkens the copy. Normal is no change from the original; -3 is the darkest; +3 is the lightest.
Quality (available only if bottom tray is selected)	Normal (default)	Good quality output; prints faster than Best.
	Best (when the top tray is selected)	The printer detects photo paper in the paper tray and sets Best quality automatically.
	Draft	The fastest print speed, but the lowest quality.
Save as Defaults	No / Yes	To save settings as the new default touch Yes .

6. Press  to begin copying.

Changing the number of copies of a photo

1. Lift the scanner lid, and place the photo face down in the right-front corner of the scanner glass.



IMPORTANT: *Do not load photos in the Automatic Document Feeder (ADF).*



2. Close the lid.
3. Press .
4. Touch **Copy Photo**.
5. Touch  or  to select a number.
6. Press  to begin copying.

Enlarging or reducing the size of a copy of a photo

1. Lift the scanner lid, and place the photo face down in the right-front corner of the scanner glass.



IMPORTANT: Do not load photos in the Automatic Document Feeder (ADF).

2. Close the lid.
3. Press .
4. Touch **Copy Photo**, then touch **Options**.
5. Touch **Copy Size**.
6. Touch  or , then touch a size selection.

NOTE: If you select a copy size larger than 5 x 7 in. / 13 x 18 cm, touch **Tray Selection**, then select **Bottom Tray**. Make sure that the paper in the bottom tray is the size and type (plain paper, photo paper, etc) that you want.





7. Press  to begin copying.

Darkening or lightening a copy of a photo

1. Lift the scanner lid, and place the photo face down in the right-front corner of the scanner glass.



IMPORTANT: Do not load photos in the Automatic Document Feeder (ADF).

2. Close the lid.
3. Press .
4. Touch **Copy Photo**, then touch **Options**.
5. Touch , then touch **Lighter/Darker**.
6. Touch  to select a number below zero for a darker copy, or touch  to select a number above zero for a lighter copy.
7. Press  to begin copying.

Scanning digitizes documents and pictures, and sends the digital files to your computer, memory card, email, network folder, or USB flash drive.

To scan to a computer, the Home Center Software must be installed on that computer, unless you are using the Online Printer Management Tool. (See [Scanning from the Online Printer Management Tool, page 91.](#))

When you scan, the digital file can:

- open in Home Center Software (when Home Center Software is loaded and the printer is connected to a computer with WINDOWS OS).
- open in a third-party scanner software.
- be saved in a format and location that you determine (see [Changing the scan settings for scanning from the control panel, page 80.](#))

Scanning from a software program on the computer (such as Home Center Software) gives you more options, but you can also scan from the printer control panel.

Before you begin scanning

If you are scanning to a computer, make sure that the printer is connected to a computer using a USB cable, Ethernet cable, or wireless network (see [Networking Your Printer, page 9.](#))

If you want to scan to an email address or to a shared network folder, you need to:

- make sure the printer is connected to a computer using a wireless or Ethernet connection.
- set up a profile using the Online Printer Management Tool (see [Setting up Scan To Email, page 25](#) and [Setting up Scan To Network Folder, page 31.](#))

Changing the scan settings for scanning from the control panel

If you want to adjust settings that the printer uses, do so before you scan from the printer control panel.

NOTE: These settings do not apply to Scan to Email or Scan to Network Folder. To change scan settings for scanning to email or to network folder, see [Setting options for scan to email, page 29](#), or [Setting scan settings for scan to network folder, page 34](#).

1. Open Home Center Software, then open the **Printer Tools** (WINDOWS OS) or **Tools** (MAC OS) window.

NOTE: To get to Printer Tools without Home Center Software (WINDOWS OS only), select **Start > All Programs > Kodak > KODAK AiO Printer Tools**.

2. Under the Tools heading, select **Printer Scan Settings**.
3. Adjust settings for scanning documents and pictures:
 - a. To select a program that your scanned images or documents will appear in when you scan from the printer control panel:
 - (1) Select the **General** tab.
 - (2) Under the Program List heading, click ▼ next to the currently selected program.
 - (3) From the list, select the program in which you want the scanned files to open.
 - b. To adjust settings for scanning documents, select the **Document** tab, then select an option for each setting:

Setting	Options
File format	.pdf .rtf (available only when connected to a computer with WINDOWS OS) .tif .jpg .bmp (available only when connected to a computer with MAC OS)
Resolution (dpi)	75 150 200 300
File Save	Prompt for File Name and Location Automatically Save-specify: <ul style="list-style-type: none"> ▪ Base name; by default, scanned files are named "scan1", "scan2", and so on. ▪ Location (folder) where the scanned files will be saved

- c. To adjust settings for scanning pictures, select the **Picture** tab, then select an option for each setting:

Setting	Options
File format	.jpg .bmp .tif
Resolution (dpi)	75 150 200 300 600
Quality	When connected to a computer with WINDOWS OS: <ul style="list-style-type: none"> ▪ Best for E-mail ▪ Normal ▪ High ▪ Maximum When connected to a computer with MAC OS, a slider bar with: <ul style="list-style-type: none"> ▪ Least ▪ Medium ▪ Best
Automatically Detect Pictures (when connected to a computer with WINDOWS OS) or Auto Crop (when connected to a computer with MAC OS)	When selected, multiple pictures placed on the scanner glass are saved as separate files.
File Save	Prompt for File Name and Location Automatically Save - specify: <ul style="list-style-type: none"> ▪ Base name; by default, scanned files are names "scan1", "scan2", and so on. ▪ Location (folder) where the scanned files will be saved

NOTE: Before you save a scanned file in Home Center Software, you can preview, crop, and sharpen the image, and adjust the color. On a computer with WINDOWS OS, see the Home Center Software Help (? icon) for instructions.

4. When you are finished making selections, click **OK** on the bottom right of the Printer Scan Settings window.
5. Close the Printer Tools window.

Loading originals for scanning

You can scan multiple-page documents automatically by loading the originals (up to 35 pages) face up in the Automatic Document Feeder (ADF).

IMPORTANT: *The ADF accepts plain paper originals from 6.9 to 8.5 in. (18 to 22 cm) wide and 9.8 to 14 in. (25 to 36 cm) long.*

To scan a photo, documents on thick or thin paper, or a document that is too small or too large to fit in the ADF, place the original face down on the scanner glass.

For more information on loading originals, [see Loading originals, page 46](#).

Scanning from the control panel

When you scan a document or picture(s) from the control panel, you have the following options:

- **Scan to Computer** - scans to a file or to Home Center Software on your computer
- **Scan to Memory Card** - scans to a memory card in the memory card slot
- **Scan to USB Flash Drive** - scans to a flash drive attached to the front USB port
- **Scan to Email**^{*} - scans to an email address that you select from the Email Profile you set up in the Online Printer Management Tool
- **Scan to Network Folder**^{*} - scans to a shared network folder that you designated in the Online Printer Management Tool

^{*} Before you can use these options, you must set up Scan to Email (see [Setting up Scan To Email, page 25](#)) and Scan to Network Folder (see [Setting up Scan To Network Folder, page 31](#)) from the Online Printer Management Tool.

Scanning to a computer

To scan to a computer:

1. Lift the scanner lid, and place the original face down in the right-front corner of the scanner glass, then close the lid.



2. Close the lid.
3. Press .
4. Touch **Scan**.
5. Touch **Scan to Computer** or **Wi-Fi Computer**, then touch the setting/option you want to change.

Scan Option	Settings	Description
Scan To	USB-connected Computer (default)	The scanned file is sent to the USB-connected computer.
	Name of computer (only if a computer is connected by wireless or Ethernet network)	The scanned file is sent to the computer on the wireless or Ethernet network.
Scan What	Document (default)	Sets the scan settings for scanning a document (see Changing the scan settings for scanning from the control panel, page 80).
	Photo	Sets the scan settings for scanning a picture (see Changing the scan settings for scanning from the control panel, page 80).

Scan Option	Settings	Description
Scan Action	File (default)	Sends the scanned file in the format and to the location on your computer that you designate.
	Application (available only when Home Center Software is installed on computer)	Sends the scanned file to Home Center Software.
Save as Defaults	No / Yes	To save the settings as the new default, press OK . With Yes selected, press OK .

6. Press  to begin scanning.
The scanned file appears at the destination you specified.
7. When the message "Scan complete" appears, touch **OK**.

Scanning to a memory card or USB flash drive

To scan to a memory card or USB flash drive:

1. Lift the scanner lid, and place the original face down in the right-front corner of the scanner glass, then close the lid.



2. Close the lid.
3. Press .
4. Touch **Scan**.
5. Touch **Memory Card** or **USB Flash Drive**, then touch the setting/option you want to change.

Scan Option	Settings	Description
Scan What	Photo (default)	Sets the scan settings for scanning a picture (see Changing the scan settings for scanning from the control panel, page 80).
	Document	Sets the scan settings for scanning a document (see Changing the scan settings for scanning from the control panel, page 80).
File Type	JPG (default)	The scanned file is saved as a JPG.
	Single-page PDF	The scanned file is saved as a single-page PDF.
	Multi-page PDF	The scanned file is saved as a multiple-page PDF.

Scan Option	Settings	Description
Scan Size	Auto (default) 2 x 3 3.5 x 5 4 x 6 4 x 7 4 x 8 5 x 7 4 x 12 8 x 10 8.5 x 11 A4 8.5 x 14	Determines the size that is scanned.
Save as Defaults	No / Yes	To save the settings as the new default, press OK . With Yes selected, press OK .

- Press  to begin scanning.
The scanned file appears at the destination you specified.
- When the message "Scan complete" appears, touch **OK**.



Scanning to email

You can scan your original and immediately send the scanned file by email to one or more recipients directly from the printer.

NOTE: You must first use the Online Printer Management Tool to set up scanning to email options (see [Setting up Scan To Email, page 25](#)).

1. Lift the scanner lid, and place the original face down in the right-front corner of the scanner glass, then close the lid.



2. Close the lid.
3. Press .
4. Touch **Scan**.
5. Touch **Email**.
6. Select an outgoing email profile (the person from whom the email with the scan attachment is sent), then press **OK**.
7. If necessary, enter the 4-digit PIN number (see [page 28](#)), select **Done**, then press **OK**.
8. Select an email recipient, then press **OK**.
9. Repeat step 8 for each recipient.
10. Press  to begin scanning.
The scanned file appears at the destination you specified.
11. When the message "Scan complete" appears, touch **OK**.



Scanning to network folder

You can scan your original and immediately send the scanned file to a network folder directly from the printer.

NOTE: You must first use the Online Printer Management Tool to set up scanning to network folder options (see [Setting up Scan To Network Folder, page 31](#)).

1. Lift the scanner lid, and place the original face down in the right-front corner of the scanner glass, then close the lid.



2. Close the lid.
3. Press .
4. Touch **Scan**.
5. Touch **Scan to Network Folder**.
6. Touch **Sharing folder**.
7. If necessary, enter the 4-digit PIN number (see [page 33](#)), then touch **OK**.
8. Press  to begin scanning.
The scanned file appears at the destination you specified.
9. When the message "Scan complete" appears, touch **OK**.

Scanning from the computer

1. Lift the scanner lid, and place the original face down in the right-front corner of the scanner glass.



2. Close the lid.
3. Open Home Center Software, then:
 - On a computer with WINDOWS OS, select **Scan Documents and Pictures**, then follow the on-screen instructions.
 - On a computer with MAC OS, select the **Tools** tab, click **Scan Application**, then follow the on-screen instructions.

NOTE: If you are not using Home Center Software, open a program that allows you to scan, then follow the instructions.

Scanning multiple pictures simultaneously

Using Home Center Software, you can scan multiple pictures simultaneously and save them as separate files.

When scanning multiple pictures, leave space between the pictures so that the printer can detect the individual pictures. Any pictures that overlap are interpreted as a single picture.

Scanning multiple pictures when connected to a computer with WINDOWS OS

To scan multiple pictures simultaneously, and save them as separate files:

1. Lift the scanner lid, and place the pictures face down on the glass, leaving space between the pictures.
2. Close the lid.
3. Open Home Center Software, then select **Printer Tools**.
4. Select **Printer Scan Settings**, then select the **Picture** tab.
5. Select **Automatically Detect Pictures**, if it is not selected, then click **OK**.
6. Click the Home icon in the top right corner, then select **Scan Documents and Pictures**.
7. Make sure that **Picture** is selected and **Collage - Combine all pictures** is cleared, then follow the on-screen instructions.

NOTE: Click Help (? icon) for additional instructions.

Scanning multiple pictures when connected to a computer with MAC OS

To scan multiple pictures simultaneously, and save them as separate files:

1. Lift the scanner lid, and place the pictures face down on the glass, leaving space between the pictures.
2. Close the lid.
3. Open Home Center Software, then select your printer.
4. Select the **Tools** tab.
5. Click **Scan Application**.
6. Select **Color Picture** or **Black and White Picture**.
7. Select **Automatically detect multiple pictures**, if it is not selected.
8. Click **Preview** or **Scan All**, and follow the on-screen instructions.

NOTE: Click Help (? icon) for additional instructions.

Scanning from the Online Printer Management Tool

You can use an Internet browser to initiate a scan from the Online Printer Management Tool on a computer that is connected to the same network as the printer.

1. Open the Online Printer Management Tool (see [Accessing the Online Printer Management Tool, page 20](#)).
2. Select the **Applications** tab.
3. Select **Applications > Webscan**.

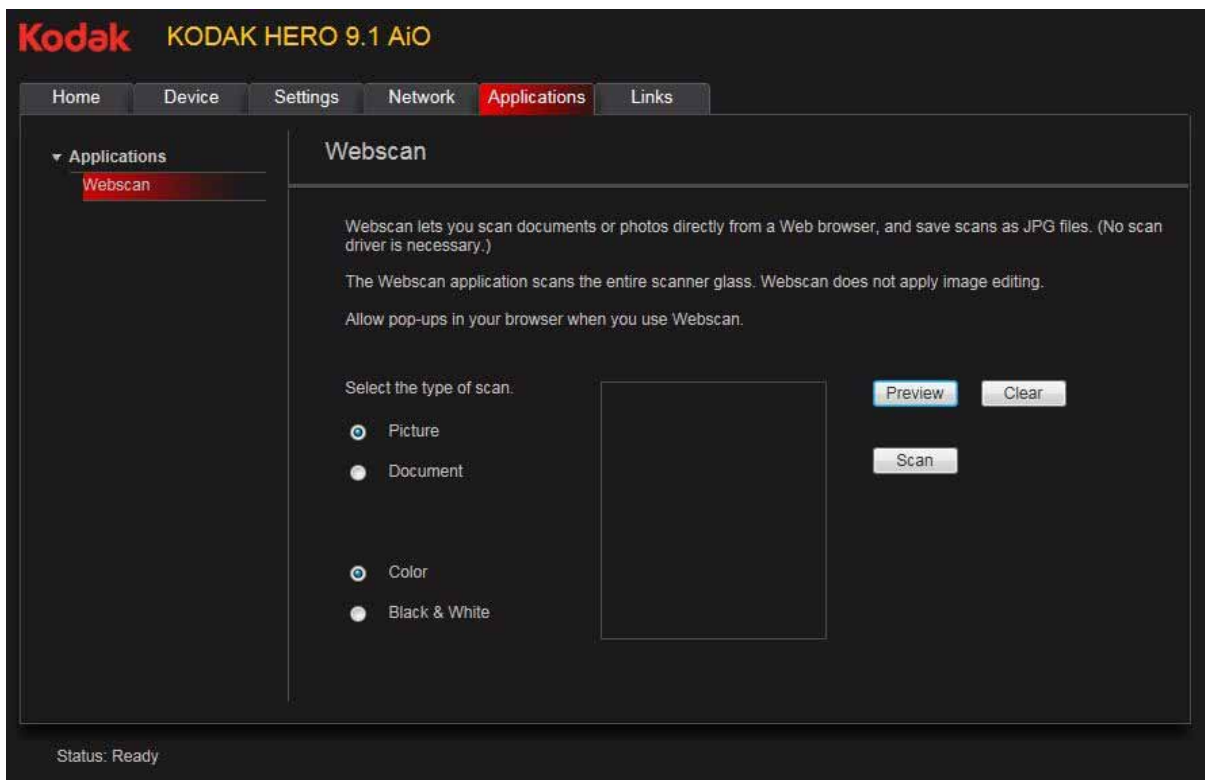

4. Select the type of scan you want, and place the original on the scanner glass.
5. Click **Preview** to see what will be scanned.
 - If needed, click **Clear** to reposition the original.
6. When you are satisfied with the preview, click **Scan**. The scanned file will display in a new browser window.
7. In the new browser window, select **File > Save As** to save the file as a JPEG image on your computer.

Your printer can send and receive faxes in either black and white or color.

Before you begin faxing





Before you can send or receive faxes, you must connect your printer and set up the fax options.

Connecting the printer for faxing

Selecting the country/region

For the fax to work properly, the country or region selected on the printer must match your location. This setting determines how your faxes are sent and received.

To set the correct country or region:

1. Press .
2. Touch , then touch **Printer Settings**.
3. Touch , then touch **Country/Region**.
4. Touch  to scroll through the selections, then touch your country or region to select it.

Determining your telephone system type

The instructions for setting up your printer for faxing differ depending on the type of telephone service you have. Determine the type of telephone service you have, and connect your printer accordingly.

IMPORTANT: *Use the phone cord that was provided with the printer. If you use any other phone cord, you may not be able to send or receive faxes successfully.*

- **Standard telephone service** — telephone service that uses dedicated telephone wiring to transmit only phone signals
- **Cable telephone service** — telephone service that is delivered by a cable television service
- **Digital Subscriber Line (DSL)** — telephone service that uses the wires of a local telephone network to transmit digital data over cables
- **Internet telephone service** (Voice-Over-Internet-Protocol or VOIP) — telephone service delivered by an Internet Service Provider

Connecting to a standard telephone service

If you have a standard telephone service, connect one end of the phone cord that came with the printer into the LINE IN port on the back of the printer and the other end into the wall phone jack.

**Connecting to a Digital Subscriber Line (DSL)**

If you have a DSL telephone service, connect one end of the phone cord that came with the printer into the LINE IN port on the back of the printer and the other end into the DSL filter (available from your DSL provider), which is connected to the wall phone jack.

NOTE: You must use a DSL filter to transmit fax signals properly to your printer.



Connecting to an Internet or cable telephone service (Voice-Over-Internet Protocol or VOIP)

If you have an Internet or cable (Voice-Over-Internet Protocol or VOIP) telephone service, you should already have a cable modem/router connected to the cable outlet with a coaxial cable. You will also need an Analog Telephone Adapter (ATA) to connect your printer for faxing.

NOTE: Sometimes the cable modem/router has a built-in ATA. Contact your cable telephone service provider for more information.

1. Connect an RJ-45 (also called CAT 5) cable from the cable modem/router to the WAN port on the Analog Telephone Adapter (ATA).
2. Connect one end of the phone cord that came with the printer (RJ-11 telephone cord) to one of the phone input ports on the ATA and the other end to the LINE IN port on the back of your printer.

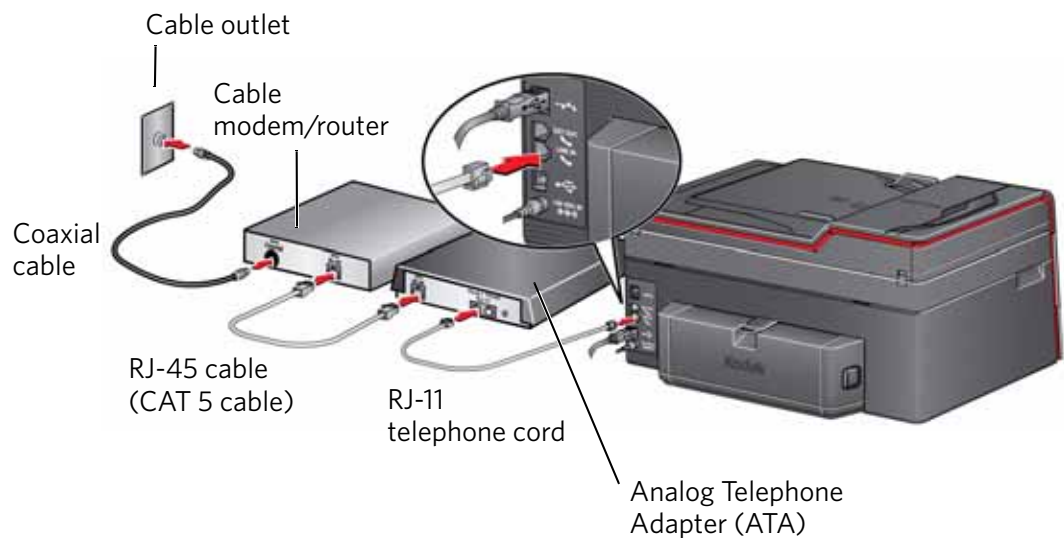

Determining whether your phone line is dedicated or shared

To connect your printer for faxing correctly, you need to determine whether your phone line is shared or dedicated.

- A **dedicated phone line** is one that has *only this printer* and no other devices connected to it. If you have a dedicated line, connect your printer as described for your type of phone service (see [Connecting to a standard telephone service, page 93](#), [Connecting to a Digital Subscriber Line \(DSL\), page 93](#), or [Connecting to an Internet or cable telephone service \(Voice-Over-Internet Protocol or VOIP\), page 94](#)).
- A **shared phone line** is one that has several devices connected to it, such as a phone and/or answering machine as well as the printer. If you have a shared line, connect your printer in one of the following ways, based on the devices you have connected to the same phone line.

If you share the line with an answering machine or telephone:

1. Connect one end of the phone cord that came with the printer into the LINE IN phone port on the back of the printer.
2. Connect the other end of the phone cord into either a wall phone jack or a DSL filter, depending on the type of telephone service you use.
3. Connect one end of the phone cord for your answering machine into the EXT OUT phone port on the back of the printer.
4. Connect the other end of the phone cord into the answering machine or telephone.

NOTE: If you have an answering machine, set the number of rings to answer on the printer to a *higher number* than the rings to answer for the answering machine (see [Rings to Answer, page 97](#)).

Configuration for connecting an answering machine with a standard telephone service

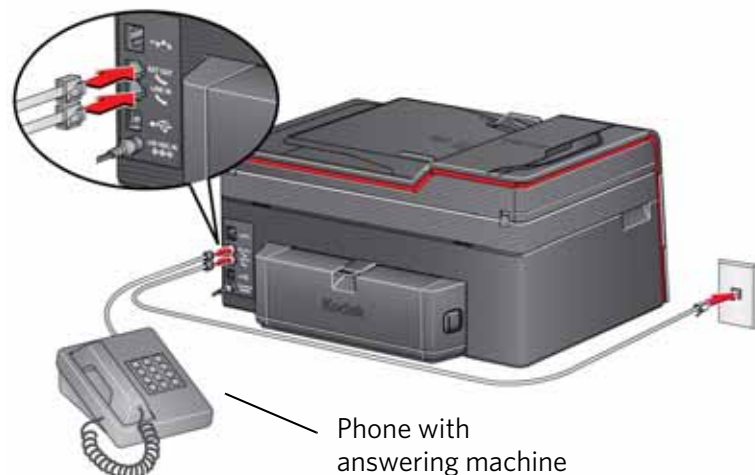

If you have an answering service:

If you have an answering service that uses a computerized system for recording messages remotely for the same phone line that you use for your all-in-one printer, then you can set up a distinctive ring to receive faxes automatically (see [Distinctive Ring, page 98](#)).



If you do not set up a distinctive ring, you can still receive faxes manually (see [Receiving a fax manually, page 106](#)).

Entering fax sender information

Fax sender information appears in the header of any fax that you send from your all-in-one printer. Typically this is your name or your business name and your fax number.



NOTE: If you do not enter fax sender information, the header on faxes that you send will be blank.

To enter fax sender information:

1. Press .
2. Touch , then touch **Fax**.
3. Touch **Fax Settings**, touch **Fax Sender Information**, then touch a field to enter:
 - your name or business name
 - your fax number
4. Press **OK** to save the information.



Selecting fax settings

Before sending or receiving faxes, select the fax settings.

1. Press .
2. Touch , then touch **Fax**.
3. Touch **Fax Settings**, touch  or  to scroll through the settings, then touch a setting to make a change.

Fax Setting	Options	Description
Fax Sender Information	--	This information appears on the faxes you send. Touch a field and use the LCD keyboard to enter your name and fax number. Touch OK to save.
Fax Auto-Answer	On (default) / Off	When there is an incoming call, the printer will display the name and number of the caller. When Auto-Answer is on, the printer will automatically receive the call, or you can touch Answer now to answer the call manually.
Rings to Answer	1 to 6 (default is 4)	The number of times that your phone will ring before the printer picks up the call. If you use a dedicated phone line for your printer, set the Rings to Answer to any setting. If the printer shares the phone line with an answering machine, set the Rings to Answer to a higher number (5 or 6) than the rings to answer for the answering machine (typically 4 rings). This allows the answering machine to pick up phone calls. The printer will monitor the line after the answering machine picks up, and, if set to Auto Answer, will detect an incoming fax and receive it.
Fax Speed	Fast (33.6K) (default) Medium (14.4K) Slow (9.6K)	Use this setting to reduce the fax transmission speed of your printer if you have difficulty with faxing at higher speeds.
Redial if No Answer	Yes (default) / No	If the fax number you call does not answer, the printer will redial the number automatically one time.

Fax Setting	Options	Description
Busy Redial Attempts	0 to 12 (default is 5)	The number of times that the fax will attempt to redial a busy number.
Disable Call Waiting	No (default) / Yes	<p>If you have call-waiting service on your phone line, you can disable it so that an incoming call does not interrupt your fax transmission.</p> <p>Select Yes to disable call waiting, then enter the Call-Waiting Disable Code (below).</p> <p>NOTE: You must enable call waiting manually after your fax transmission.</p>
Call-Waiting Disable Code	*70 (default)	<p>The printer automatically dials the Call-Waiting Disable Code before dialing the number to which you are sending a fax. This code disables call waiting for the duration of the fax, preventing incoming calls from interrupting your fax transmission.</p> <p>The usual code to disable call waiting is the default *70. If the call waiting disable code is different in your area, touch Call-Waiting Disable Code, then touch the backspace button to erase the current code. Use the keypad to enter the correct code, then press OK.</p>
Distinctive Ring	Any ring (default) / Single Ring / Double Ring / Triple Ring	<p>This service, available from most phone companies, adds multiple phone numbers to one phone line. Each phone number then has a distinctive ring pattern (single, double, or triple ring) to let you know which number is ringing.</p> <p>Select the ring pattern assigned to the phone number for the printer so the printer can receive faxes automatically.</p>
Fax Speaker	On (default) / Off	The fax speaker allows you to hear the dial tone and initial fax tones when sending faxes.
Print Fax Confirmation Page	After Failure Only (default) / Never / Always	The Fax Confirmation Page contains the time and date, the number you called, the number you called from, and whether the transmission was successful.

Fax Setting	Options	Description
Print Fax Settings	--	To print the current fax settings, load letter or A4 paper, then press  .
Print Fax Cover Page	--	The Fax Cover Page shows the date and headings for To and From information for your fax. Use this cover page, if needed, when sending a fax. To print a Fax Cover Page, load letter or A4 paper, then press  .
Print Fax Activity Log	--	The Fax Activity Log contains information (date, time, duration, to/from, number of pages, and more) about the last 30 faxes sent and/or received. To print a Fax Activity Log, load letter or A4 paper, then press  .
Dialing Mode	Tone (default) / Pulse	Determines how the printer dials a fax number. Tone dialing (the more common method) uses tones to dial a phone number. It is faster and more reliable than pulse dialing, which uses a series of pulses to dial a phone number. Traditionally, pulse dialing was used by rotary phones; tone dialing is used by touch-tone phones.
Error Correction	On (default) / Off	Error correction is applied only when sending black and white faxes. It reduces the loss of data, which can occur on poor quality phone lines. Error correction increases the send time on poor quality phone lines, but the transmission is more reliable. (Error correction does not apply to faxes being received.)



To adjust fax settings from the Online Printer Management Tool:

1. Open the Online Printer Management Tool (see [Accessing the Online Printer Management Tool, page 20](#)).
2. Select the **Settings** tab, then select **Fax > Settings**.
3. Change the **Sender Information** and/or fax **Settings** as needed.
4. Click **Save** to update the settings.

Setting the answer mode (auto answer or manual)

The default setting for Auto-Answer is on. When Auto-Answer is on, the printer picks up all incoming faxes automatically.

To answer calls manually, touch **Answer now** on the LCD or turn off Auto-Answer (see also [Receiving a fax manually, page 106](#)):

1. Press .
2. Touch , then touch **Fax**.
3. Touch **Fax Settings**, then touch **Fax Auto-Answer**.
4. Touch **Off** to turn Auto-Answer off.

Working with the phonebook

You can enter up to 60 fax numbers in the phonebook.

You can create and manage the phonebook from the printer LCD or, if your printer is connected to a computer with WINDOWS OS, you can use Home Center Software.

You can also use the Online Printer Management Tool to edit the Fax Phone Book. See [page 102](#).

Using symbols in phonebook entries



You can use the following symbols in phonebook entries:

Symbol	Description	Response by fax
0 - 9	numbers	Dials the number
*	star	Used for special features (for example, *70 is used to deactivate call waiting)
#	pound	Used for special features (for example, # at the end of a number signifies the completion of the number sequence)

Touch **Pause** to add a comma. This causes a 2-second delay before dialing the remaining numbers.





Adding a new phonebook entry

To add a new phonebook entry:

1. Press .
2. Touch , then touch **Fax**.
3. Touch **Phonebook**.
4. Touch **Add New**.
5. Touch the fields to enter the name and number for a recipient. Touch **OK** to save the information.
6. Optional: Assign a Quick Dial number.
You can set up your ten most frequently used fax numbers as Quick Dial numbers. You will be able to dial them quickly, and they will be displayed at the top of your phonebook.
 - a. Touch **Quick Dial**, then select an available number to assign to the contact.
 - b. Touch **OK** to finish.
7. When you have finished, touch **OK** to save.





Editing a phonebook entry

To edit a phonebook entry:

1. Press .
2. Touch , then touch **Fax**.
3. Touch **Phonebook**.
4. Touch  or  to scroll through the contacts, then touch the entry you want to edit.
5. Touch the fields you want to change, then touch **OK** to save.
6. Repeat steps 4-5 to edit more entries; when you are finished, press .

Deleting a phonebook entry

To delete a phonebook entry:

1. Press .
2. Touch , then touch **Fax**.
3. Touch **Phonebook**.
4. Touch  or  to scroll through the numbers, then touch the entry you want to delete.
5. Touch **Delete**, then touch **Yes**.
The entry is deleted from the phonebook.
NOTE: If you do not want to delete the entry, touch **No**.
6. Repeat steps 4-5 to delete more entries; when you are finished, press .

Using the Online Printer Management Tool to edit the Fax Phonebook

You may use the Online Printer Management Tool to edit your fax phonebook. See [Editing the fax phone book, page 23](#)).





Preparing a fax for transmission

Before you send a fax, prepare a cover page (if needed), load the original(s), and change the resolution and brightness (if needed).

Printing a fax cover page

If you need a fax cover page, you can print one with your printer, then manually complete the information (person to whom you are sending, fax number, your name, etc).

To print a fax cover page:

1. Press .
2. Touch , then touch **Fax**.
3. Touch **Fax Settings**, touch , then touch **Print Fax Cover Page**.
4. Load letter or A4 paper, then press .

Loading originals for faxing

To fax documents (up to 35 pages) that are on plain paper, load the original(s) face up in the Automatic Document Feeder (ADF).

IMPORTANT: *The ADF accepts plain paper originals from 6.9 to 8.5 in. (18 to 22 cm) wide and 9.8 to 14 in. (25 to 36 cm) long.*



To fax a photo, documents on thick or thin paper, or a document that is too small or too large to fit in the ADF, place the original face down on the scanner glass. You can fax only one page at a time from the scanner glass.

For more information on loading originals, see [Loading originals, page 51](#).

Changing resolution, brightness, and color mode

Before sending a fax, change the resolution, brightness and color settings, as needed, based on your original.

To modify settings before sending a fax:

1. Press .
2. Touch , then touch **Fax**.
3. Touch **Fax**, then touch **Options**.
4. Touch the option you would like to change:

Fax Option	Setting	Description
Resolution	Standard (default) Fine Photo	The resolution setting determines the amount of detail that is transmitted. Standard is the default for most documents. Use Fine for documents with fine print. Use Photo for photos.
Lighter/Darker	Normal (default) -3 to +3	Adjust the brightness setting according to the brightness of your original. Normal is no change from the original; -3 is the darkest; +3 is the lightest.
Color Mode	Black & White (default) Color	The color mode determines if your fax is sent in black and white or color. If the receiver's fax machine is not set up to print color, the fax will print in black and white.
Save as Defaults	No / Yes	To save settings as the new default, touch Yes .

Sending a fax



You can send a fax in several ways. You can use:

- the phonebook
- Quick Dial
- the numeric keypad
- recently dialed numbers
- your computer

NOTE: If the receiver's fax machine is not set up to print color, the fax will print in black and white.



Using the phonebook to send a fax

To send a fax using the phonebook:

1. Press .
2. Touch , then touch **Fax**.
3. Touch **Phonebook**.
4. Touch the name for the intended recipient number.
5. Press  to begin faxing.



Using Quick Dial to send a fax

To send a fax using Quick Dial:

1. Press .
2. Touch , then touch **Fax**.
3. Press **Phonebook**.
4. Touch the number on the numeric keypad that corresponds to the desired Quick Dial entry.
5. Press  to begin faxing.



Using the numeric keypad to send a fax

To send a fax using the numeric keypad:

1. Press .
2. Touch , then touch **Fax**.
3. Enter a fax number using the numeric keypad.
4. Press  to begin faxing.

Dialing a recently faxed number

To send a fax to a recently dialed number:

1. Press .
2. Touch , then touch **Fax**.
3. Touch **Recent**.
4. Touch to select an entry.
5. Touch  to begin faxing.

If there is no number to redial, touch **OK**. The phonebook opens.

Sending a fax from your computer

To send a fax from your computer, you must have Home Center Software installed on your computer.

Sending a fax from a computer running WINDOWS OS:

1. Open the document you want to fax, then select **File > Print**.
2. In the print dialog box, make sure that **KODAK HERO 9.1 AiO Fax Driver** is selected, then click **Properties** or **Preferences**.
3. Select a paper size (letter or A4) from the drop-down menu, then select a resolution and orientation as needed.
4. Enter the fax number in the **Enter Fax Number** field, then click **OK**.
5. Click **OK** to send the fax.

Sending a fax from a computer running MAC OS:

To send a fax from a computer running MAC OS:

1. Open the document you want to fax, then select **File > Print**.
2. Expand the print dialog box, if necessary.
3. Select **Fax Options** from the drop-down menu.
4. Select a paper size (US Letter or A4 only) from the drop-down menu, then select an orientation if needed.
5. Check the Send as Fax check box, then enter the fax number in the **To** field.
6. Select a fax quality (Standard or Best).
7. Click **Print** to send the fax.

Receiving a fax

You can set up your printer to receive faxes automatically or manually. Even if your printer is set up to receive faxes automatically, you can still receive them manually at any time.

Receiving a fax automatically

To receive faxes automatically:

1. Load letter (8.5 x 11 in. / 22 x 28 cm) or A4 (8.3 x 11.7 in. / 21 x 30 cm) plain paper into the main paper tray (see [Loading paper in the main paper tray, page 44](#)).
2. Make sure the Auto-Answer is set to On (see [Setting the answer mode \(auto answer or manual\), page 100](#)).

The printer will receive all incoming faxes automatically.

IMPORTANT: *Whenever there is an incoming fax, the printer LCD shows the message, "Incoming Call. (Name and number if available)." When Auto-Answer is turned on, you do not need to touch Answer now on the LCD to receive the fax. The printer will automatically receive the fax after the number of rings that you selected (see [Rings to Answer, page 97](#)). However, you may choose to receive the fax sooner by touching Answer now on the LCD. (Whether the fax is color or black and white is determined by the sender.)*

Receiving a fax manually

If Auto-Answer is turned off, you can receive incoming faxes manually. You can receive any incoming fax manually, even if Auto-Answer is turned on.

To receive a fax manually:

- When you hear the phone ring, touch **Answer now** on the LCD.

If your printer is connected to the same phone line as another telephone and you are using tone dialing (see [Dialing Mode, page 99](#)), you can receive an incoming fax manually from another phone. When you hear the distinctive ring of your fax line or know that the incoming call is a fax:





- Pick up any phone and dial **234** (the remote access code).

Printing fax reports

You can set up the printer to print certain reports automatically, or you can print reports manually at any time.

Fax settings report



To print the current fax settings:

1. Press .
2. Touch , then touch **Fax**.
3. Touch **Fax Settings**.
4. Touch , then touch **Print Fax Settings**.
5. Load letter (8.5 x 11 in. / 22 x 28 cm) or A4 (8.3 x 11.7 in. / 21 x 30 cm) plain paper into the main paper tray (see [Loading paper in the main paper tray, page 44](#)), then press .

Fax confirmation page

The Fax Confirmation Page contains the time and date of transmission, the number that you called and the number you called from, and whether the transmission was successful. To print the Fax Confirmation Page, you must select the option to print it before you transmit the fax. The default setting is to never print the Fax Confirmation Page.

To print the Fax Confirmation Page for future faxes:





1. Press .
2. Touch , then touch **Fax**.
3. Touch **Fax Settings**, then press **OK**.
4. Touch , then touch **Print Fax Confirmation Page**.
5. Touch **Always** (to print a confirmation page after sending every fax), **After Fail Only** (default) to print only if the fax transmission fails, or **Never**.

NOTE: The name and fax number of receivers will not appear on your confirmation page if the receivers have not set up that information on their fax machines.

Fax activity log

The Fax Activity Log provides detailed information for approximately the last 30 faxes sent or received. The log contains information such as date, time, duration of transmission, to/from, and number of pages.

To print a Fax Activity Log:

1. Press .
2. Touch , then touch **Fax**.
3. Touch **Fax Settings**, then press **OK**.
4. Touch , then touch **Print Fax Activity Log**.
5. Load letter (8.5 x 11 in. / 22 x 28 cm) or A4 (8.3 x 11.7 in. / 21 x 30 cm) plain paper into the main paper tray (see [Loading paper in the main paper tray, page 44](#)), then press .

NOTE: The name and fax number of receivers will not appear on your Fax Activity Log if the receivers have not set up that information on their fax machines.

Canceling a fax

You can cancel a fax that you are sending or receiving at any time.

To cancel sending or receiving a fax, press .

Maintaining Your Printer

Your printer requires little maintenance. However, Kodak recommends cleaning the scanner glass and lid regularly to remove dust and fingerprints, which affect the quality and accuracy of scanning and copying.

Except while cleaning the printer, keep the printer plugged into an AC power outlet. If you use a power strip, don't turn off the power strip. (The printer does not necessarily have to be turned on, but should be plugged in.)

Keep the printhead and ink cartridges in the printer at all times to help prevent damage to the printhead.

For recycling and/or disposal information, contact your local authorities. In the US, go to the Electronics Industry Alliance at www.eia.org or go to www.kodak.com/go/recycle.

General care and cleaning

 CAUTION:

Always disconnect the power to the printer before cleaning it. Do not use harsh or abrasive cleaners on any part of the printer.

- To clean the printer, wipe the outside with a clean, dry cloth.
- Keep the surrounding area vacuumed and litter-free.
- Protect the printer from tobacco smoke, dust, and liquid spills.
- Do not place objects on the printer.
- Keep the paper tray free of dust, dirt, and other foreign objects.
- Keep the printer supplies away from direct sunlight and out of high-temperature environments.
- Do not allow chemicals to come into contact with the printer.

Cleaning the scanner glass and document backing

The scanner glass can get smudged and minor debris can accumulate on the white document backing under the scanner lid. Periodically clean the scanner glass and document backing.

⚠ CAUTION:

Do not use harsh or abrasive cleaners on any part of the printer.

Do not spray liquid directly on the glass.

Do not use paper-based wipes on the document backing as they can scratch it.

1. Turn off the printer and unplug it from the power outlet.
2. Lift the scanner lid.

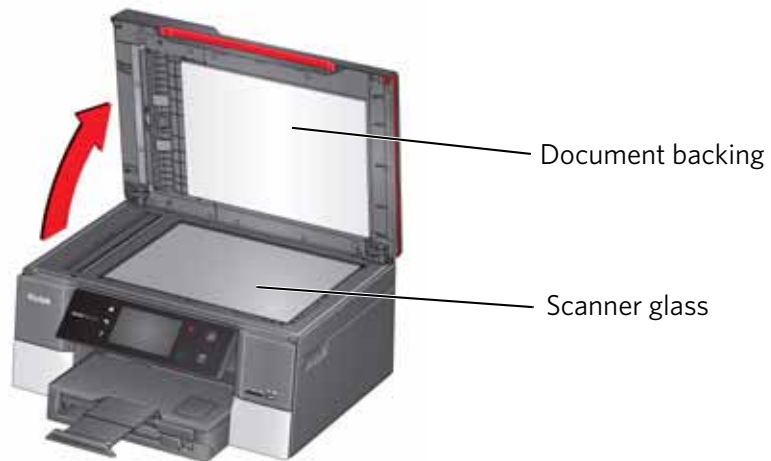

3. Wipe the glass with a soft cloth or sponge, slightly moistened with a nonabrasive glass cleaner.



4. Dry the glass with a lint-free cloth.
5. Gently clean the document backing with a soft cloth or sponge, slightly moistened with mild soap and warm water.



6. Dry the document backing with a chamois or soft, lint-free cloth.
- NOTE: If the document backing needs further cleaning, use isopropyl (rubbing) alcohol on a soft cloth, then wipe thoroughly with a cloth moistened with water to remove any residual alcohol.
7. When you finish cleaning, plug in the printer.

Replacing ink cartridges

Your printer uses black and color ink cartridges. You can check the approximate ink levels on the LCD (see [Checking ink levels, page 120](#)) or in Home Center Software. When an ink cartridge is out of ink, the control panel displays a message stating that the black or color ink cartridge needs replacing.

IMPORTANT: *Do not use non-Kodak brand or refilled ink cartridges.*

1. Make sure the printer is on.
2. Lift the access door, and wait for the carriage to move to the access position.



The ink cartridges are located in the printhead.



3. Pinch the tab on the ink cartridge and lift it out of the printhead.

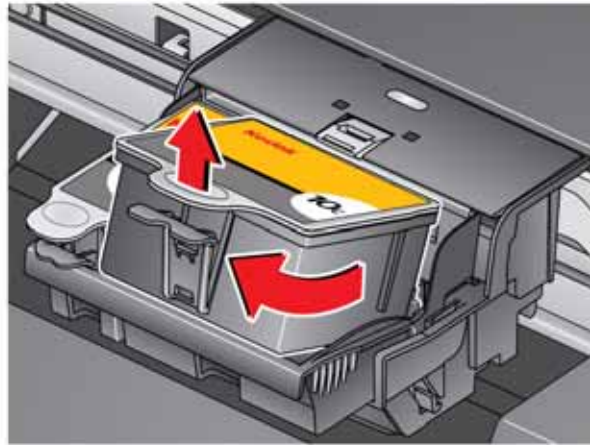

4. Remove the new ink cartridge from its bag.



IMPORTANT: *To prevent the printhead from drying out, insert the ink cartridge into the printhead immediately.*

5. Remove the cap.

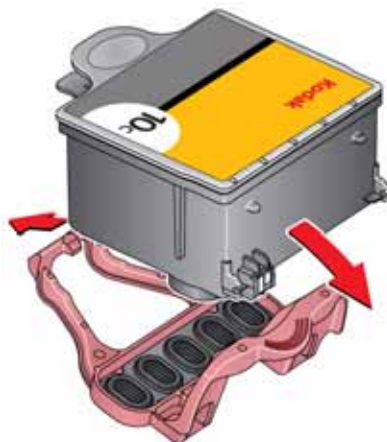

6. Insert the ink cartridge into the printhead.

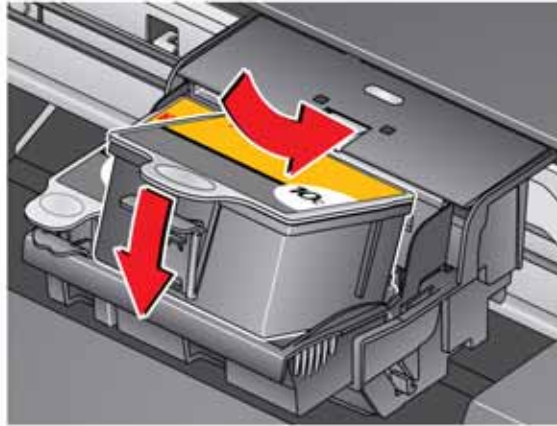

7. Press down on the ink cartridge tab until you hear a click.

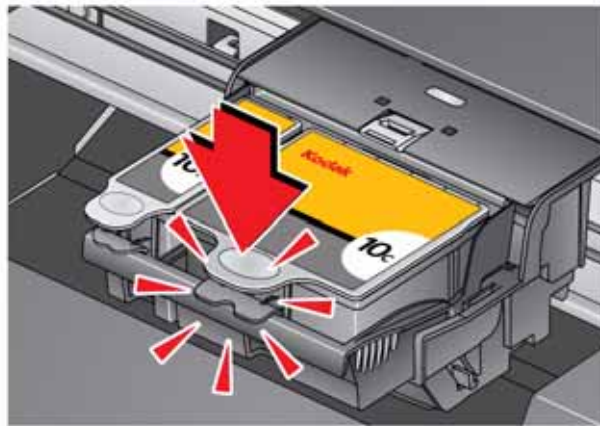

8. Close the access door.

Replacing the printhead

IMPORTANT: *Replacing the printhead is not a regular maintenance procedure. Replace the printhead only if you receive a new printhead from Kodak.*

1. Make sure the printer is on.
2. Lift the access door, and wait for the carriage to move to the access position.



3. Remove both ink cartridges and set them aside.

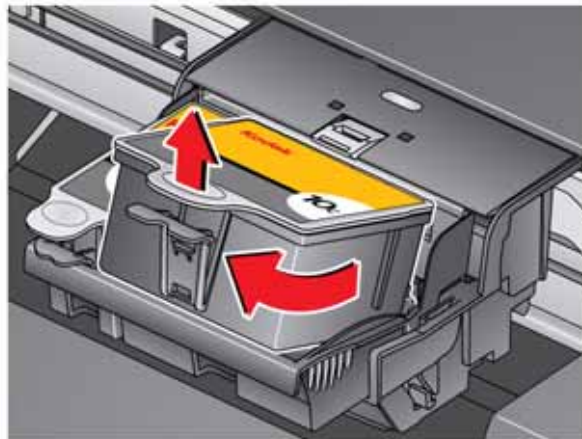

4. Unlatch the existing printhead by lifting the button.

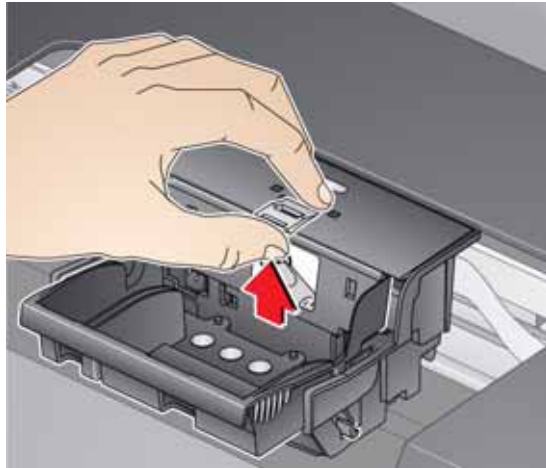

5. Lift the printhead out of the carriage.

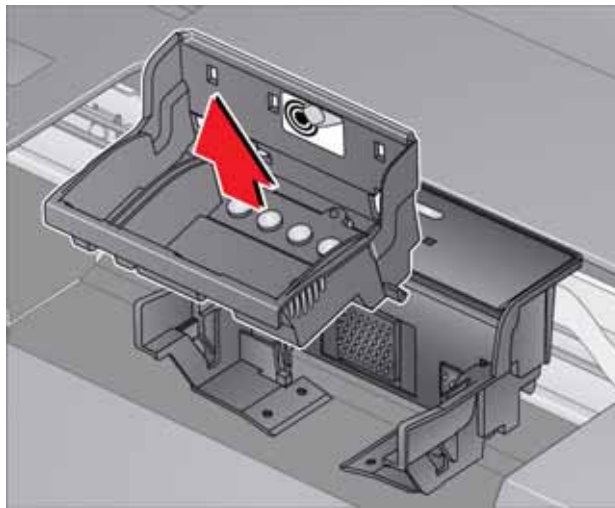

6. Remove the new printhead from its bag.



⚠ CAUTION:
Do not touch the gold contacts on the printhead, as doing so may damage it.

7. Remove the two plastic caps.

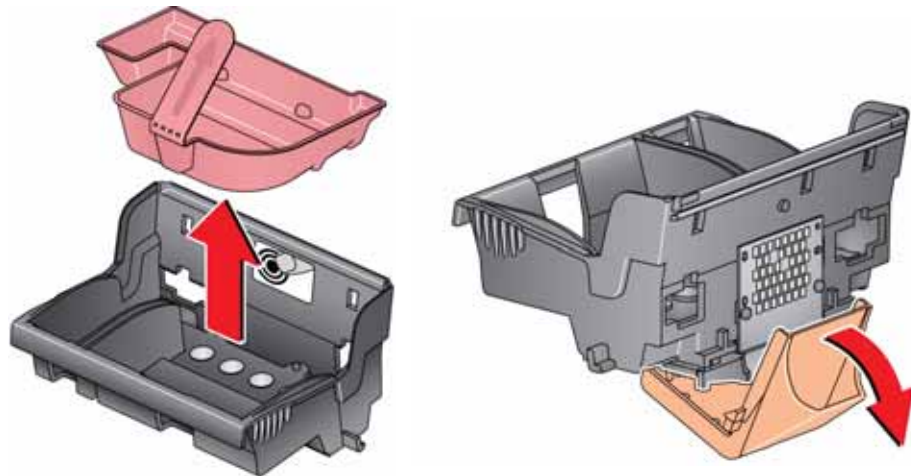

8. Install the new printhead in the carriage.

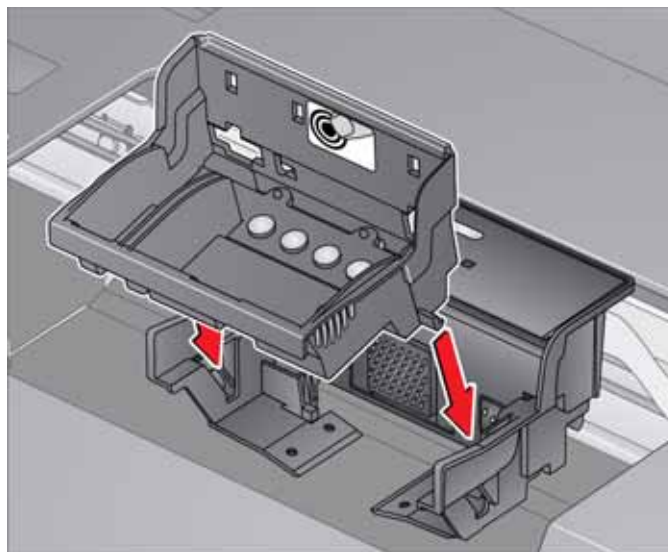

9. Push firmly against the target label on the printhead until you hear a click.



10. Insert the black ink cartridge into the printhead.

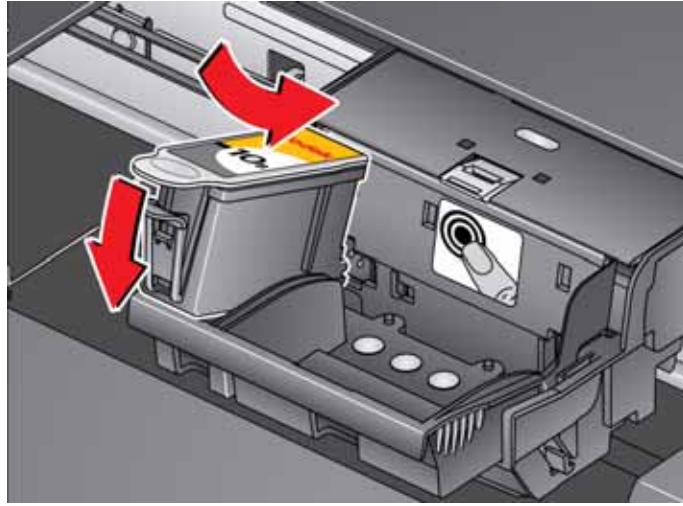

11. Press down on the ink cartridge tab until you hear a click.

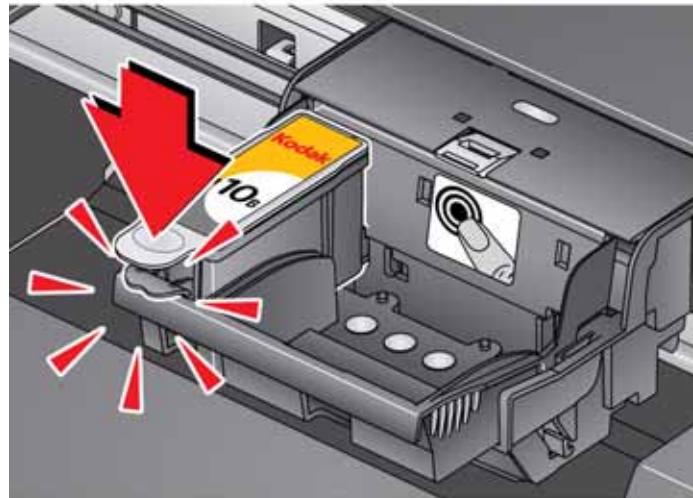

12. Repeat steps 10 - 11 for the color ink cartridge.

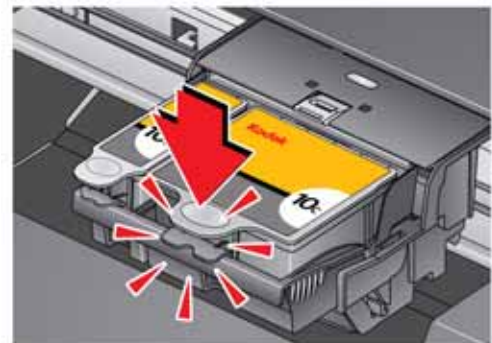
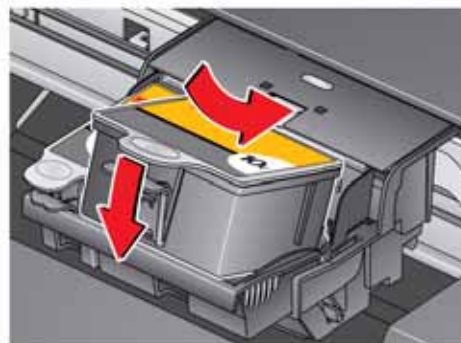

13. Close the access door.

The printer detects the new printhead. Follow the instructions on the control panel to calibrate your printer.

Updating the software and printer firmware

Using the latest software and firmware helps ensure optimal performance of your printer.

NOTE: Firmware is the software that runs on the printer.

Although there is an automatic check for software and firmware updates when your computer is connected to the Internet, you can update manually using the following procedure.

Updating if your printer is connected to a computer with WINDOWS OS

To update the software:

1. Make sure your computer is connected to the Internet.
2. Open Home Center Software, then select **Printer Tools**.

NOTE: If you do not have Home Center Software, select **Start > All Programs > Kodak > KODAK AiO Printer Tools**.

3. Under Printer Resources, click **Check for Software Updates** to check whether software updates are available.
4. If there are updates, click **Next** and follow the on-screen instructions.

To update the printer firmware:

1. Make sure your computer is connected to the Internet.
2. Connect the printer to the computer with a USB cable, Ethernet cable, or wirelessly (if not currently connected).
3. Open Home Center Software, then select **Printer Tools**.
4. Make sure that **KodakHERO9.1+xxxx - Connected** (or a similar name with **Connected**) appears in the lower left corner of the Printer Tools window.

NOTE: If **KodakHERO9.1+xxxx - Connected** does not appear in the lower left corner, click **Select**, click **Refresh List** and choose your printer from the list; click **OK** and follow the on-screen instructions.

5. Under Printer Resources, click **Check for Printer (Firmware) Updates**.
6. If there are updates, click **Next** and follow the on-screen instructions.

IMPORTANT: *Do not turn off or disconnect your printer or your computer during the update. Doing so may cause the printer to become inoperable. If the printer is connected wirelessly, make sure you have a stable connection when you perform the update. During the upgrade, your printer will restart. Wait for the message, "Update complete! You may now use your Kodak Printer" to appear on your computer.*

Updating if your printer is connected to a computer with MAC OS

To update the software:

1. Make sure your computer is connected to the Internet.
2. Open Home Center Software.
3. Select the **Tools** tab.
4. Click **Check for Software Updates**.
5. If there are updates, follow the on-screen instructions.

To update the firmware:

1. Make sure your computer is connected to the Internet.
2. Connect the printer to the computer with a USB cable, Ethernet cable, or wirelessly (if not currently connected).
3. Open Home Center Software.
4. Select the **Tools** tab.
5. Click **Check for Printer (Firmware) Updates**.
6. If there are updates, follow the on-screen instructions.



IMPORTANT: *Do not turn off or disconnect your printer or your computer during the update. Doing so may cause the printer to become inoperable. Your printer will restart during the upgrade.*

Monitoring and adjusting printer performance

From the control panel, you can perform tasks to help keep the printer functioning well.

Checking ink levels

To check the ink levels:



1. Press .
2. Touch , then touch **Maintenance**.
3. Touch **Check Ink Levels**.

The LCD shows approximate levels of ink in the cartridges so you know when it's time to order replacement cartridges. Use 10 Series ink cartridges.

NOTE: You can order ink cartridges online. Go to www.kodak.com/go/printingsupplies.

Checking paper levels

To check the paper levels:



1. Press .
2. Touch , then touch **Maintenance**.
3. Touch **Check Paper Levels**.

The LCD shows approximate levels of paper in each paper tray so you know when it's time to add more paper.

NOTE: You can order paper online. Go to www.kodak.com/go/inkjetpaper.

Resetting factory defaults

To reset defaults to the factory default settings:



1. Press .
2. Touch , then touch **Printer Settings**.
3. Touch , then touch **Reset All Settings**.
4. When you see the message, "This will reset printer settings to factory defaults," touch **Yes**.





NOTE: Resetting factory defaults does not change the date and time, language, or country/region.

Basic troubleshooting

If you experience a problem with your printer, restarting it will sometimes fix the problem. Turn off your printer, wait five seconds, then turn on your printer.

If you are still experiencing a problem, use the following information to troubleshoot your printer.

Problem	Possible Solutions
Printer does not power on	<ul style="list-style-type: none"> • Make sure you are using the power cord that came with your printer. • Make sure the power cord is connected to the AC adapter and is plugged into an outlet or power strip, and that the LED on the AC adapter is lit. • Make sure that the power cord is securely connected to the power cord port in the back of the printer.
Printer not detected	<ul style="list-style-type: none"> • Make sure your printer is plugged in and turned on. • If you are using a USB cable, make sure: <ul style="list-style-type: none"> - it is a USB 2.0 high-speed cable. - it is connected to both your printer and your computer. - you restart the computer if the USB cable was disconnected from the printer then reconnected, or if power to the printer was interrupted. • If you are using a wireless connection, make sure: <ul style="list-style-type: none"> - the Wi-Fi connectivity LED remains lit. - the printer is connected to your wireless network. <p>To check:</p> <ol style="list-style-type: none"> a. On the printer, press . b. Touch , then touch Network Settings. c. Touch View Network Configuration. Make sure that the Active Connection Type is Wi-Fi, and that the IP Address is not all zeros. <ul style="list-style-type: none"> - your router is transmitting data. - the firewall (excluding WINDOWS Firewall) is allowing the services needed for your printer. <p>For additional information, go to www.kodak.com/go/inkjetnetworking.</p>
Wireless connectivity	For wireless connectivity issues, go to www.kodak.com/go/inkjetnetworking .
Carriage jam	<ul style="list-style-type: none"> • Open the access door and clear any obstructions. • Make sure the printhead and ink cartridges are installed correctly. (The printhead and ink cartridges are installed correctly when you hear them click into place.)
Ink cartridge errors	<ul style="list-style-type: none"> • Make sure KODAK Ink Cartridges are installed. Do not use non-Kodak brand or refilled ink cartridges. • Remove, then install the cartridges again. Make sure the cartridges click into place.

Problem	Possible Solutions
Too much paper curl after printing	<ul style="list-style-type: none"> ▪ If you are printing pictures or documents with large areas of image content, try increasing the top and bottom margins when printing in portrait mode or the left and right margins when printing in landscape mode. Start with a 1-inch margin on top and bottom and a 0.25-in. (0.62-cm) margin on the sides. The larger the margin, the less potential there is for curl. ▪ Print on a higher weight paper, such as 24 lb (90 gsm) paper or use KODAK Ultimate Paper. ▪ Apply a border rather than printing in a borderless mode. ▪ If the paper is not stacking properly in the output tray, remove the pages as they exit.
Print quality	<ul style="list-style-type: none"> ▪ For best results, use KODAK Paper or a paper with the COLORLOK Technology logo on the package. ▪ Make sure the paper is loaded correctly (see Loading paper, page 44). ▪ Clean the printhead: <ul style="list-style-type: none"> - Press . - Touch , then touch Maintenance. - Touch Clean Printhead. ▪ Calibrate the printer: <ul style="list-style-type: none"> - Press . - Touch , then touch Maintenance. - Touch Calibrate Printer. <p>For more information, go to www.kodak.com/go/hero7_1support, then type the problem in the search field.</p>
Paper jam	<ul style="list-style-type: none"> ▪ Check for paper behind the duplexer in the cleanout area. ▪ Make sure the paper in the tray is free of tears or creases. ▪ Make sure you do not overload the paper tray. ▪ For more information, go to www.kodak.com/go/hero7_1support, then type jam in the search field.
Error codes/messages or other problems you cannot resolve	<ul style="list-style-type: none"> ▪ Go to www.kodak.com/go/hero7_1support, then type your error code or message. If you need to contact Kodak (see www.kodak.com/go/contact), have the following information available: <ul style="list-style-type: none"> ▪ Kodak Service Number (located inside the printer when you open the access door) ▪ Printer model number (located on the control panel) ▪ Computer model, operating system, and version of Home Center Software ▪ Exact wording of any error message(s) and the error code

Getting help on the Web

For more troubleshooting information:

Get help with wireless networking.	www.kodak.com/go/inkjetnetworking
Search our knowledge base of Answers to Questions.	www.kodak.com/go/hero7_1support
Download the latest firmware and software for optimal printer performance.	www.kodak.com/go/hero7_1downloads
Check the Extended User Guide for detailed instructions and the recommended system requirements.	www.kodak.com/go/hero7_1manuals
Get help with problems you cannot resolve.	<p>Contact Kodak at www.kodak.com/go/contact and have the following information available:</p> <ul style="list-style-type: none"> - Kodak Service Number (located inside the printer when you open the access door) - Printer model number (located on the control panel) - Computer model, operating system, and version of Home Center Software

Status lights

The status lights indicate the condition of the printer. There are two status lights on the printer: one that indicates power, the other indicates Wi-Fi status.

Power status light

Power light	What it means
Off	<ul style="list-style-type: none"> ▪ The printer is turned off. <ul style="list-style-type: none"> - Press the on/off button to turn on power. ▪ The printer does not have power. <ul style="list-style-type: none"> - Make sure that the power cord is plugged into the back of the printer and into an electrical outlet, and that the electrical outlet has power.
Blinking	<p>The printer is busy.</p> <ul style="list-style-type: none"> ▪ Wait for the printer to finish the task.
On	The printer is ready.

Wi-Fi status light

Wi-Fi status light	What it means
Off	The Wi-Fi radio is either turned off or is turned on but not connected to a wireless network.
Blinks continuously	The Wi-Fi radio is turned on and the printer is searching for available wireless networks within range.
Blinks intermittently	The Wi-Fi radio is turned on and the printer cannot find any available wireless networks within range, or the Wi-Fi radio connection has been interrupted or is too weak to send signals. To find and connect to an available wireless network within range, turn the Wi-Fi radio off, and run the Wi-Fi Setup Wizard (see Connecting to a wireless network, page 9).
On	The Wi-Fi radio is turned on and there is a working connection between the printer and a wireless network.

Product and Safety Specifications

The following specifications are subject to change without notice.

Features and Specifications

Print Performance

Black print speed	8.5 images per minute
Color print speed	5.5 images per minute
Print technology	Continuous-tone, thermal inkjet
Print quality modes	Draft, Normal, and Best on plain paper Best on photo paper

Photo Printing Features

Quantity	1 to 99
Print sizes	2 x 3 in. / 5 x 8 cm 3.5 x 5 in. / 9 x 13 cm 4 x 6 in. / 10 x 15 cm 4 x 7 in. / 10 x 18 cm 4 x 8 in. / 10 x 20 cm 4 x 12 in. / 10 x 30 cm (Panoramic) 5 x 7 in. / 13 x 18 cm 7 x 10 in. / 18 x 25 cm 8 x 10 in. / 20 x 25 cm US Letter (8.5 x 11 in. / 22 x 28 cm) A4 (8.3 x 11.7 in. / 21 x 30 cm)
Quality	Best, Normal, Draft modes on plain paper Best on photo paper
Auto-detect media	Auto-detect plain paper and photo papers Optimize image quality for KODAK Photo Papers with barcode
Image enhancement	KODAK PERFECT TOUCH Technology with Home Center Software (from WINDOWS OS only)
Color	Black and white or color
Scene balance	On (default), Off

Copy document features

- Color** Black and white or color
- Quantity** 1 to 99 copies
- Copy sizes** Same Size, Fit to Page, 20 to 500%
- Plain paper quality** Best, Normal, Draft
- Brightness** -3 to +3

Copy photo features

- Color** Black and white or color
- Quantity** 1 to 99
- Copy sizes** 4 x 6 in. / 10 x 15 cm
4 x 7 in. / 10 x 18 cm
4 x 8 in. / 10 x 20 cm
4 x 12 in. / 10 x 30 cm (Panoramic)
5 x 7 in. / 13 x 18 cm
7 x 10 in. / 18 x 25 cm
8 x 10 in. / 20 x 25 cm
US Letter (8.5 x 11 in. / 22 x 28 cm)
A4 (8.3 x 11.7 in. / 21 x 30 cm)
- Quality** Automatic
- Brightness** -3 to +3

Scanning features

- Scanner type** Contact Image Sensor (CIS)
- Scan sizes** Maximum size of original scanned from scanner glass:
8.5 x 11.7 in. / 22 x 30 cm
- Resolution and Bit Depth** Supports native scan resolution of 2400 dpi
Scans at 8 bits per channel, with 3-color scans at 24 bits/pixel
- Functions** Segmentation scanning
Auto-destination
Optical Character Recognition (OCR)

Main paper tray

- Paper capacity** 100 sheets of 16 to 24 lb (60 to 75 gsm) plain paper
20 envelopes (20 to 24 lb / 75 to 90 gsm)
- Paper size** 4 x 6 in. to 8.5 x 14 in. / 10 x 15 cm to 22 x 36 cm

Photo paper tray

Paper capacity 40 sheets of 20-mil photo paper
7 to 12 mils / 290 gsm, maximum

Paper size 4 x 6 in. to 5 x 7 in. / 10 x 15 cm to 13 x 18 cm

Output paper tray

Paper capacity 50 sheets of 16 to 24 lb (60 to 90 gsm) plain paper
20 sheets of photo paper (7 to 12 mil / 290 gsm, maximum)
20 envelopes (20 to 24 lb / 75 to 90 gsm)

Paper types supported

Plain paper 16 to 24 lb (60 to 90 gsm)

Photo paper 7 to 12 mil / 290 gsm, maximum

Card stock 110 lb / 200 gsm index, maximum

Envelopes 20 to 24 lb (75 to 90 gsm)

Transparencies All commercially available inkjet varieties (with a white stripe on the short edge)

Labels All commercially available inkjet varieties on
8.5 x 11 in. / 22 x 28 cm and A4 (8.3 x 11.7 in. / 21 x 30 cm) size sheets

Iron-on transfers All commercially available inkjet varieties on 8.5 x 11 in. and A4 size sheets

Paper sizes supported

Plain paper	A4 (8.3 x 11.7 in. / 21 x 30 cm) A5 (5.8 x 8.3 in. / 15 x 21 cm) A6 (4.1 x 5.8 in. / 11 x 15 cm) B5 (6.9 x 9.8 in. / 18 x 25 cm) US Executive (7.3 x 10.5 in. / 18 x 27 cm) US Letter (8.5 x 11 in. / 22 x 28 cm) US Legal (8.5 x 14 in. / 22 x 36 cm) Custom sizes from 4 to 8.5 in. / 10 to 22 cm wide and 6 to 14 in. / 15 to 36 cm long
Labels	A4 (8.3 x 11.7 in. / 21 x 30 cm) US Letter (8.5 x 11 in. / 22 x 28 cm)
Index card stock	4 x 6 in. index cards (10 x 15 cm) 5 x 7 in. index cards (13 x 18 cm)

Transparencies and iron-on transfers	A4 (210 x 297 mm) US Letter (8.5 x 11 in.) (216 x 280 mm)
Envelopes	C5 (6.4 x 9 in. / 16 x 23 cm) C6 (4.5 x 6.4 in. / 11.5 x 16 cm) DL (designated long) 4.3 x 8.7 in. / 11 x 22 cm US #7¾ (3.9 x 7.5 in. / 10 x 19 cm) US #9 (3.9 x 8.9 in. / 10 x 23 cm) US #10 (4.1 x 9.5 in / 11 x 24 cm)
Photos	4 x 6 in. / 10 x 15 cm 4 x 7 in. / 10 x 18 cm 4 x 8 in. / 10 x 20 cm 4 x 12 in. / 10 x 31 cm 5 x 7 in. / 13 x 18 cm 7 x 10 in. / 18 x 25 cm 8 x 10 in. / 20 x 25 cm US Letter (8.5 x 11 in. / 22 x 28 cm) A4 (8.3 x 11.7 in. / 21 x 30 cm)

Ink cartridges

Ink handling	2-cartridge, 5-ink system
Ink life	1-year warranty from date of purchase

Connectivity

Protocols supported	USB 2.0 High Speed; DPOF
Devices supported	WINDOWS OS-based and MAC OS Computers, memory cards (SD, MS/Duo, MMC, SDHC), USB devices (flash drives, cameras), PictBridge
Image formats supported	Image printing supports JPEG (EXIF v2.21 non-progressive); does not support progressive JPEG format; image scanning supports scanning to JPEG and non-searchable PDF
Number of USB ports	One USB 2.0 high-speed port on the back for connecting the printer to the computer (as needed), and one on the front for connecting USB devices
Wi-Fi technology supported	802.11b/g/n, WPA/WPA2, WPS, and WEP

Software support

- Application support** Third-party image-management software; optical character reader (OCR) support for documents
- Media support** Plain paper, photo paper, envelopes, greeting cards, card stock, labels, and transparencies
- Scanner support** TWAIN and WIA, WIA2 (VISTA and WINDOWS 7 OS), ICA (MAC OS) and TWAIN, including segmentation scanning
- Update support** Software and firmware updates available through Web support

Digital image sources

- Removable memory card support** Offers selecting, viewing, editing, and printing of images from memory cards for printing purposes only
- USB digital input device support** Supports a USB 2.0 high speed device port on the back of the printer, and a USB 2.0 high speed embedded host port on the front of the printer
- PictBridge support** Supports PictBridge CIPA-DC-001-2003 features (Ref 8) through the front panel USB host port

Physical specifications

- Power** Input: 100–240 V AC, 50–60 Hz
The printer should only be used with the provided switching adapter.
Output: 36 V DC at 1.1 A
- Storage dimensions** 44.5 cm (17.5 in.) long x 43.18 cm (17.0 in.) wide x 23.11 cm (9.1 in.) high with input and output trays closed
- Weight** 8.5 kg (18.7 lb) with power supply, printhead, and ink cartridges
- Operating range** 5 to 35°C (41 to 95°F), 15 to 85% RH
- Full image quality environmental range** 15 to 30°C (59 to 86°F), and 20 to 80% RH
- Energy efficiency** ENERGY STAR® Qualified

Warranty

Product	One year from purchase (with proof of purchase)
Printhead	One year from purchase (with proof of purchase)

System requirements

Computer with WINDOWS OS

Computer Minimum

Operating System	WINDOWS 7, VISTA, or XP (SP2 or later)
CPU	INTEL CELERON Processor
Clock speed	1.2 GHz
Memory	512 MB RAM
Available hard disk space	500 MB available
Interface	USB 2.0 High Speed
Removable drive	CD-ROM

Computer with MAC OS

Computer Minimum

Operating System	MAC OS X 10.5 or later
CPU	PowerPC G4, G5, or INTEL-based MACINTOSH
Clock speed	1.2 GHz
Memory	512 MB RAM
Available hard disk space	200 MB available
Interface	USB 2.0 High Speed
Removable drive	CD-ROM

Safety information

KODAK HERO 9.1 All-in-One Printer is a Class 1 LED Product.

- Always follow all warnings and instructions marked on the product.
- Use only a Hipro HP-A0601R3 or Flextronics VP-09500084-000 certified external power supply (provided with the product).
- Use only the power cord that comes with the product (or an approved power cord greater than or equal to H05W-F, 2G, 0.75 mm²). Using another power cord may cause fire and/or shock. Do not use the included power cord with any other equipment.
- If you do not use this product for a long period of time, unplug it from the electrical outlet.
- Always turn this product off by using the On/Off button. Wait until the On/Off button stops flashing before removing the power plug from the outlet.
- Do not allow the power cord to become damaged or frayed.
- If you need to use an extension cord with this product, make sure that the ampere rating of the product does not exceed the ampere rating of the extension cord.
- Place the product on a flat, stable surface that extends beyond the product's base in all directions. This product will not operate properly if tilted or at an angle.
- When storing or transporting this product, do not tilt or stand it on its side. Never turn this product upside down (ink can leak out of the product).
- Avoid placing this product in an environment that is subject to rapid changes in temperature or humidity, mechanical shocks, vibration, or dust. Do not place near radiators, heating vents, or in direct sunlight.
- Leave enough room around this product for sufficient ventilation.
- Do not block this product's covers or openings, or insert any objects through slots.
- Do not use aerosol products inside or around this product.
- Do not spill any liquid on this product.
- Do not attempt to repair or service this product.
- If the power cord or plug is damaged, if any liquid has been spilled onto the product, if the product has been dropped or the case damaged, if the product does not operate normally or exhibits a major change in performance level, unplug this product and contact Kodak at www.kodak.com/go/contact.

For Service Personnel:



CAUTION:

Risk of explosion if battery is replaced by an incorrect type. Dispose of used batteries according to local instructions.

LCD touch screen safety

- Use only a dry, soft cloth to clean the LCD screen. Do not use any liquid or chemical cleaners.
- If the LCD touch screen is damaged, contact Kodak immediately. If any of the solution from the display gets on your hands, wash them thoroughly with soap and water.

Ink cartridge safety

- Keep all ink cartridges out of the reach of children.
- If ink gets on your skin, wash with soap and water. If ink gets into your eyes, flush immediately with water. If any discomfort or change in vision persists after washing, seek medical attention immediately.
- For MSDS information on inks, go to www.kodak.com/go/MSDS.

NOTE: You will need the Catalog number from the ink package.

Regulatory Compliance

FCC Statement

The United States Federal Communications Commission (in CFR 47 Part 15.105) has specified that the following notice be brought to the attention of the users of this product:

NOTE: This equipment has been tested and found to comply with the limits for a Class B digital device, pursuant to part 15 of the FCC Rules. These limits are designed to provide reasonable protection against harmful interference in a residential installation. This equipment generates, uses, and can radiate radio frequency energy and, if not installed and used in accordance with the instructions, may cause harmful interference to radio communications. However, there is no guarantee that interference will not occur in a particular installation. If this equipment does cause harmful interference to radio or television reception, which can be determined by turning the equipment off and on, the user is encouraged to try to correct the interference by one or more of the following measures:

- Reorient or relocate the receiving antenna.
- Increase the separation between the equipment and receiver.
- Connect the product into an outlet on a circuit different from that to which the receiver is connected.
- Consult the dealer or an experienced radio/TV technician for help.

 CAUTION:

Pursuant to Part 15.21 of the FCC Rules, any changes or modifications to this product not expressly approved by Eastman Kodak Company might cause harmful interference and void the FCC authorization to operate this product.

The radiated energy from this product is well below the FCC radio frequency exposure limits. Nevertheless, the product shall be used in such a manner that the potential for human contact during normal operation is minimized. This product and any attached external antenna, if supported, shall be placed in such a manner to minimize the potential for human contact during normal operation. In order to avoid the possibility of exceeding the FCC exposure limits, human proximity shall not be less than 20 cm (8 inches) during normal operation.

Canadian Statements

This product meets the applicable Industry Canada technical specifications.

Operation is subject to the following two conditions: (1) this device may not cause interference, and (2) this device must accept any interference, including interference that may cause undesired operation of the device.

This Class B digital apparatus complies with Canadian ICES-003.

Industry Canada (IC) Radiation Exposure Statement

This equipment complies with IC radiation exposure limits set forth for an uncontrolled environment. This equipment should be installed and operated with a minimum distance of 20 cm between the radiator and your person.

European Compliance Statement



Hereby, Eastman Kodak Company declares that this Kodak all-in-one wireless printer is in compliance with the essential requirements and other relevant provisions of Directive 1999/5/EC.

German compliance statement



CAUTION:

This device is not intended for use in the direct field of view at visual display workplaces. To avoid incommoding reflections at visual display workplaces this device must not be placed in the direct field of view.



CAUTION:

Das Gerät ist nicht für die Benutzung im unmittelbaren Gesichtsfeld am Bildschirmarbeitsplatz vorgesehen. Um störende Reflexionen am Bildschirmarbeitsplatz zu vermeiden, darf dieses Produkt nicht im unmittelbaren Gesichtsfeld platziert werden.

Noise emissions for this equipment do not exceed 70 dB(A).

This equipment is not intended for use in the workplace in accordance with Bildschirmarbeitsplatz regulations.

Das Gerät ist nicht für die Benutzung am Bildschirmarbeitsplatz gemäß Bildschirmarbeitsplatz vorgesehene.

REACH Article 33 Declarations

Go to www.kodak.com/go/REACH for information about the presence of substances included on the candidate list according to article 59(1) of Regulation (EC) No. 1907/2006 (REACH).

Waste Electrical and Electronic Equipment Labeling

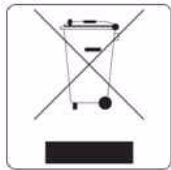

In the European Union, do not discard this product as unsorted municipal waste. Contact your local authorities or go to www.kodak.com/go/recycle for recycling program information.

ENERGY STAR® Qualified

To conserve energy, this printer will enter a reduced power (sleep) mode automatically after 1 hour. You can adjust the delay time (in 0.5 hour increments) up to 4 hours. Increasing the delay time may result in reduced energy savings.



ENERGY STAR and the ENERGY STAR mark are registered U.S. service marks. As an ENERGY STAR partner, Kodak has determined that this product meets ENERGY STAR Guidelines for energy efficiency. For more information on the ENERGY STAR program, see www.energystar.gov.

Warranty Information

Limited Warranty

Kodak warrants Kodak consumer electronic products and accessories ("Products"), excluding batteries, to be free from malfunctions and defects in both materials and workmanship for one year from the date of purchase. Retain the original dated sales receipt. Proof of the date of purchase will be required with any request for warranty repair.

Limited Warranty Coverage

Warranty service is only available from within the country where the Products were originally purchased. You may be required to send Products, at your expense, to the authorized service facility for the country where the Products were purchased. Kodak will repair or replace Products if they fail to function properly during the warranty period, subject to any conditions and/or limitations stated herein. Warranty service will include all labor as well as any necessary adjustments and/or replacement parts. If Kodak is unable to repair or replace a Product, Kodak will, at its option, refund the purchase price paid for the Product provided the Product has been returned to Kodak together with proof of the purchase price paid. Repair, replacement, or refund of the purchase price are the sole remedies under this warranty. If replacement parts are used in making repairs, those parts may be remanufactured or may contain remanufactured materials. If it is necessary to replace the entire Product, it may be replaced with a remanufactured Product. Remanufactured Products, parts and materials are warranted for the remaining warranty term of the original Product, or 90 days after the date of repair or replacement, whichever is longer.

Limitations

This warranty does not cover circumstances beyond Kodak's control. This warranty does not apply when failure is due to shipping damage, accident, alteration, modification, unauthorized service, misuse, abuse, use with incompatible accessories or attachments (such as third party ink or ink tanks), failure to follow Kodak's operation, maintenance or repacking instructions, failure to use items supplied by Kodak (such as adapters and cables), or claims made after the duration of this warranty. KODAK MAKES NO OTHER EXPRESS OR IMPLIED WARRANTY FOR THIS PRODUCT, AND DISCLAIMS THE IMPLIED WARRANTIES AND CONDITIONS OF MERCHANTABILITY AND FITNESS FOR A PARTICULAR PURPOSE. In the event that the exclusion of any implied warranty is ineffective under the law, the duration of the implied warranty will be one year from the purchase date or such longer period as required by law. The option of repair, replacement, or refund is Kodak's only obligation. Kodak will not be responsible for any special, consequential or incidental damages resulting from the sale, purchase, or use of this product regardless of the cause. Liability for any special, consequential or incidental damages (including but not limited to loss of revenue or profit, downtime costs, loss of the use of the equipment, cost of substitute equipment, facilities or services or claims of your customers for such damages resulting from the purchase, use or failure of the Product), regardless of cause, or for breach of any written or implied warranty is expressly disclaimed.

Your Rights

Some states or jurisdictions do not allow exclusion or limitation of incidental or consequential damages, so the above limitation or exclusion may not apply to you. Some states or jurisdictions do not allow limitations on how long an implied warranty lasts, so the above limitation may not apply to you. This warranty gives you specific rights, and you may have other rights which vary from state to state or by jurisdiction. Your statutory rights are not affected.

Outside the United States and Canada

In countries other than the United States and Canada, the terms and conditions of this warranty may be different. Unless a specific Kodak warranty is communicated to the purchaser in writing by a Kodak company, no warranty or liability exists beyond any minimum requirements imposed by law, even though defect, damage, or loss may be by negligence or other act.

Declaration of Conformity

See www.kodak.com/go/declarationofconformity.