

Please do not send products or other correspondences to this address

First-Class Postage Required Post Office will not deliver without proper postage.



201 West Garvey Ave., Suite 102-168
Monterey Park CA 91754-7418

WARRANTY REGISTRATION FOR



RETURN THIS CARD NOW FOR:

- **Product Protection**

By providing your product and purchase information, we can confirm the date of purchase to secure your warranty. This confirmation serves as security in the event that your original proof of purchase is lost, or in case your unit needs any servicing in the future.

- **Proof of Ownership**

Your model number, serial number, and other information will be kept in our files. Please complete and return this registration within 30 days from purchase in order to receive our 5 Year Limited Warranty.

Or register online at: www.RabbitAir.com

Copyright © 2007 All Rights Reserved
Please fold and seal with tape before mailing. Do not staple.



Air Purifier User's Guide

www.RabbitAir.com

Model No. SPA-780A



SAFETY INSTRUCTIONS

WARNING: When using electrical appliances, basic precautions should always be followed to reduce the risk of fire, electric shock, and injury to persons, including the following:



General Safety Instructions

- ⚠ To reduce the risk of electric shock, do not touch the RabbitAir MinusA2™ Air Purifier or its power plug with wet hands.

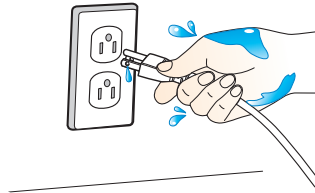

- ⚠ Do not unplug the RabbitAir MinusA2™ Air Purifier by pulling its power cord. Remove the power plug from its outlet by grasping the plug itself and pulling gently.

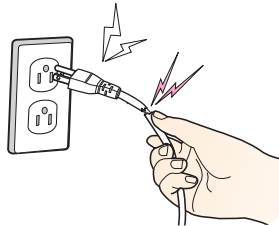

- ⚠ Do not repeatedly plug in and out the RabbitAir MinusA2™ Air Purifier.

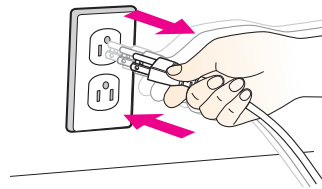

- ⚠ Read all instructions before using the RabbitAir MinusA2™ Air Purifier.
- ⚠ RabbitAir MinusA2™ Air Purifier operates at 120V AC and 60Hz only.

- ⚠ Do not operate RabbitAir MinusA2™ Air Purifier if the plug or cord appears damaged or is damaged. Return the unit to authorized service facility for examination and repair.

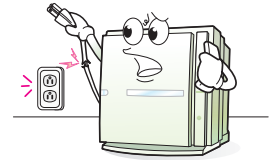

- ⚠ The RabbitAir MinusA2™ Air Purifier is for indoor use only.

- ⚠ Any attempts to open or repair the RabbitAir MinusA2™ Air Purifier without written permission from Rabbit Air will void the warranty and could cause serious personal injury to the user and/or result in severe damage to the unit.

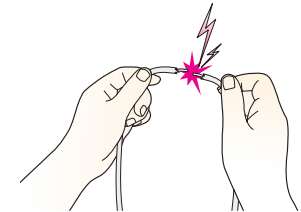

- ⚠ Use only as directed by the RabbitAir MinusA2™ Air Purifier user's guide. To reduce the risk of electric shock, do not attempt to service the product in any way other than in the manner described in this user's guide.

- ⚠ Always unplug the RabbitAir MinusA2™ Air Purifier from power outlet when not in use and before servicing or cleaning the unit.



SAFETY INSTRUCTIONS

WARNING: When using electrical appliances, basic precautions should always be followed to reduce the risk of fire, electric shock, and injury to persons, including the following:



General Safety Instructions

- ⚠ Do not place heavy objects on top of power cord.



- ⚠ To reduce the risk of electric shock, the RabbitAir MinusA2™ Air Purifier has a polarized plug. There is only one way for the plug to fit into a polarized outlet. If the plug does not fit into the outlet, reverse the plug. If it still does not fit, contact qualified personnel to install the proper outlet. Do not alter the plug in any way.

- ⚠ Always keep the plug clean. Do NOT use Benzene or gasoline to clean the plug.

- ⚠ Do not use the power cord to lift, pull, carry or drag the RabbitAir MinusA2™ Air Purifier. Avoid pulling the power cord against or around sharp corners or edges.



- ⚠ Always unplug the RabbitAir MinusA2™ Air Purifier before cleaning it.

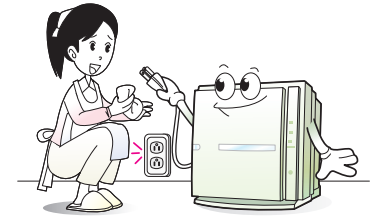

Installation Guidelines

- ⚠ The RabbitAir MinusA2™ Air Purifier is not intended for use in bathrooms, laundry areas and other damp indoor environments. Keep the Air Purifier away from water at all times. Never place the unit anywhere near bathtubs or sinks.

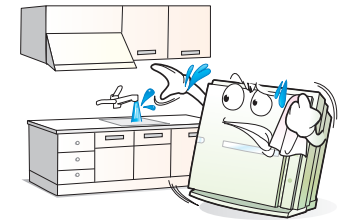

- ⚠ Do not place the RabbitAir MinusA2™ Air Purifier on top of ANY electrical appliances.

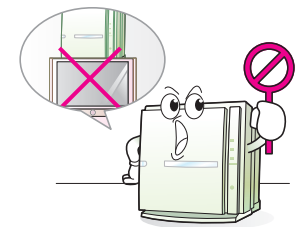

SAFETY INSTRUCTIONS

WARNING: When using electrical appliances, basic precautions should always be followed to reduce the risk of fire, electric shock, and injury to persons, including the following:



Installation Guidelines

- ⚠ Do not install the RabbitAir MinusA2™ Air Purifier in places that tend to produce oily residue such as kitchens.

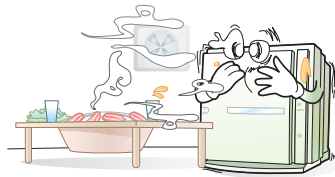

- ⚠ Do not expose the RabbitAir MinusA2™ Air Purifier to direct sunlight. Avoid leaving the remote control in direct sunlight. Heat may interfere with remote control signals.

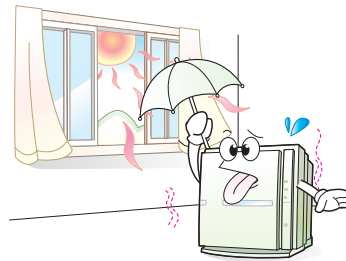

- ⚠ Leave at least 2 inches of space between the wall and the RabbitAir MinusA2™ Air Purifier. Leave at least 2 feet of space between the ceiling and the RabbitAir MinusA2™ Air Purifier.

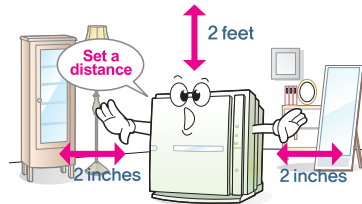

- ⚠ Place the unit on a level area. Do not apply force to the unit.

- ⚠ Do not use the unit on its side.

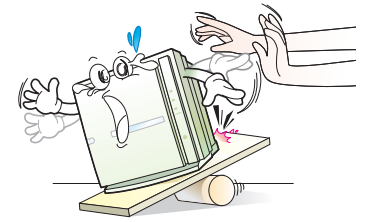

Cautions Concerning the Operation of RabbitAir MinusA2™ Air Purifier.

- ⚠ Unplug the RabbitAir MinusA2™ Air Purifier immediately if it makes a strange noise or produces an odd smell. Contact Rabbit Air for assistance.



- ⚠ Do not block the intake and air outlet.

- ⚠ Do not use the unit on or around hot objects such as stoves and heating vents.

- ⚠ Do not use the unit where it may come into contact with steam.





SAFETY INSTRUCTIONS

WARNING: When using electrical appliances, basic precautions should always be followed to reduce the risk of fire, electric shock, and injury to persons, including the following:

Cautions Concerning the Operation of RabbitAir MinusA2™ Air Purifier.

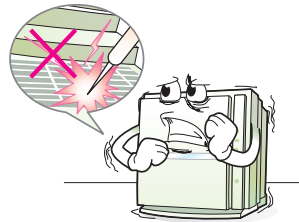
-  When the RabbitAir MinusA2™ Air Purifier is turned on, do not put anything in the opening of the unit. Keep your body parts, hair, jewelry, or any parts of your clothing away from the opening.





-  Please observe extreme caution when the RabbitAir MinusA2™ Air Purifier is used by or near children.

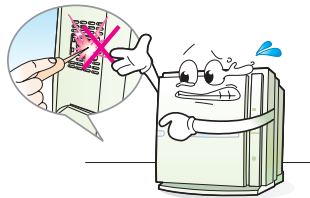

-  Do not insert fingers or foreign objects into the particle sensor.



-  Do not operate the unit without the filters. Do not wash & reuse any filters except for the electrostatic pre-filter. When transporting the unit, always hold the handle on the back of the unit.

-  Do not use the RabbitAir MinusA2™ Air Purifier near fireplaces or in areas where flammable or combustible products or vapors may be present.

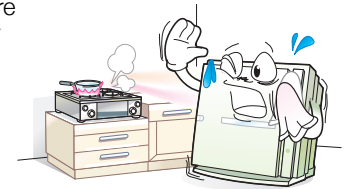

-  Do not use detergent or soap to clean the unit.



FEATURES

1 Excellent Air Purification

6-Stages of air purification. RabbitAir MinusA2™ Air Purifier is effective against allergens, mold, bacteria & viruses.

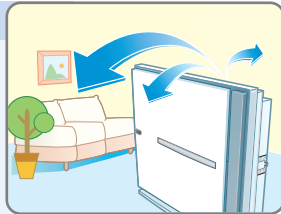

2 Strong Deodorization

Charcoal based Activated Carbon Filters capture airborne chemicals, VOCs (Volatile Organic Compounds) and odors. VOCs are often generated by off-gassing from carpets, composite wood, furniture and other materials in the home.

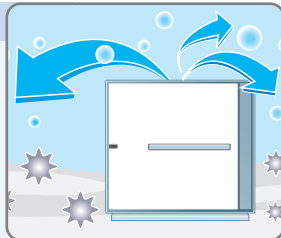

3 Negative Ion Generation

RabbitAir MinusA2™ Air Purifier produces millions of healthy "negative ions," present in natural environments such as forests and mountains, to improve and freshen the air you breathe.



4 Auto Mode Operation

In Auto Mode, the speed of the fan automatically changes to a higher speed when the particle sensor detects impurities in the air.

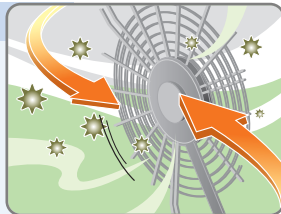

5 Remote Control

Using this sleek remote control, you can conveniently manage the air purifier from wherever you are in the house.

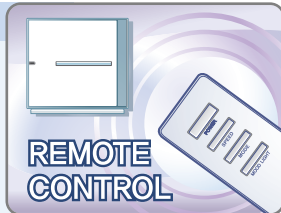

6 Wall-Mountable Design (Optional)

The RabbitAir MinusA2™ Air Purifier is wall-mountable.



7 Pollen Mode

Pollen Mode is designed for optimal indoor air circulation and the rapid removal of pollutants. Specially designed for people who are sensitive to allergy triggers such as pollen, dust and other allergens in the air. Particularly effective when high levels of pollen are present, such as in the springtime.

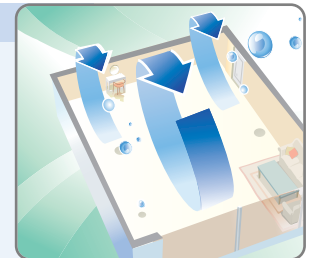

8 Silent Mode

A light sensor on the unit detects when your house is dark and automatically switches into Silent (Sleep) Mode.

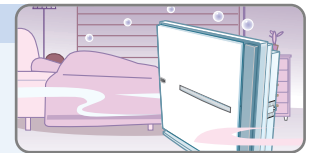

9 Safety Design

For safety purposes, the unit automatically switches off when the front panel is removed.

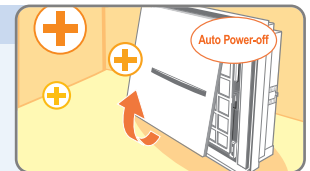

10 Mood Light

Mood Light helps to normalize blood pressure, pulse, and facilitate deep breathing, which puts a person in a state of long-lasting calm & relaxation.

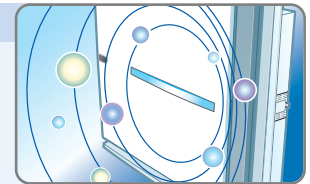

11 Quiet Mode

To reduce noise level, the fan functions at its lowest speed in Quiet Mode.



PART NAMES

Front View of Air Purifier

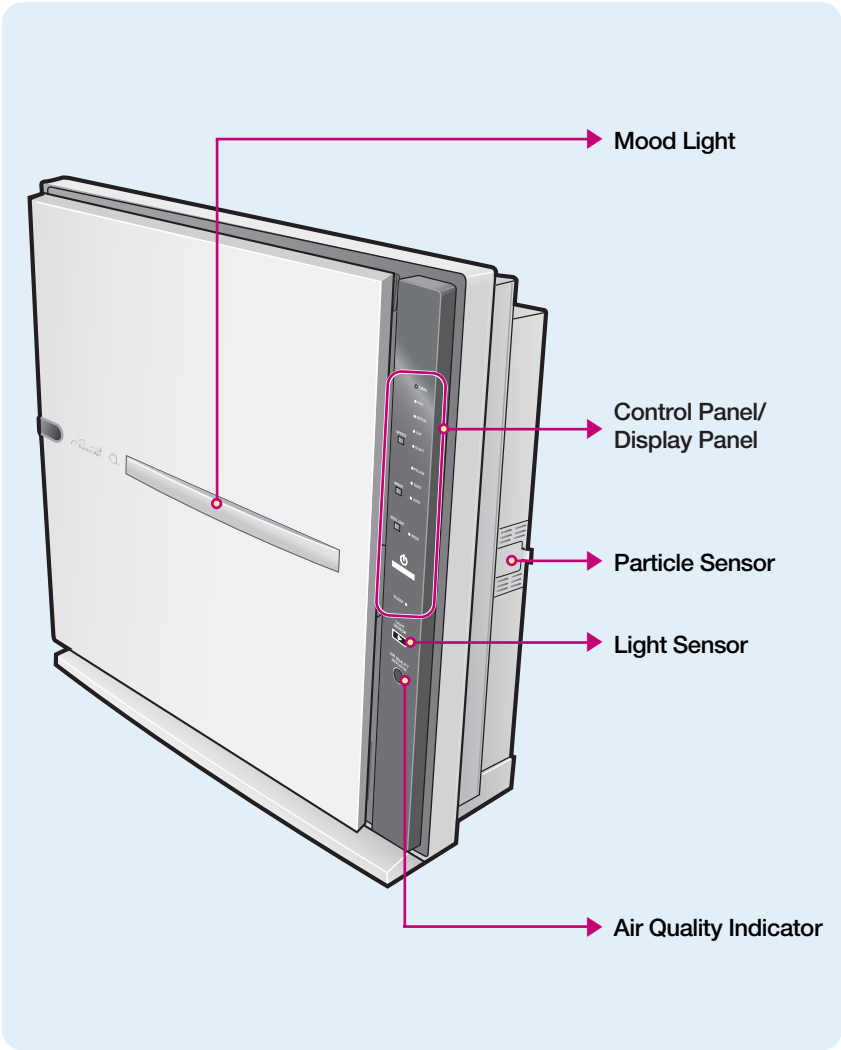

Back View of Air Purifier

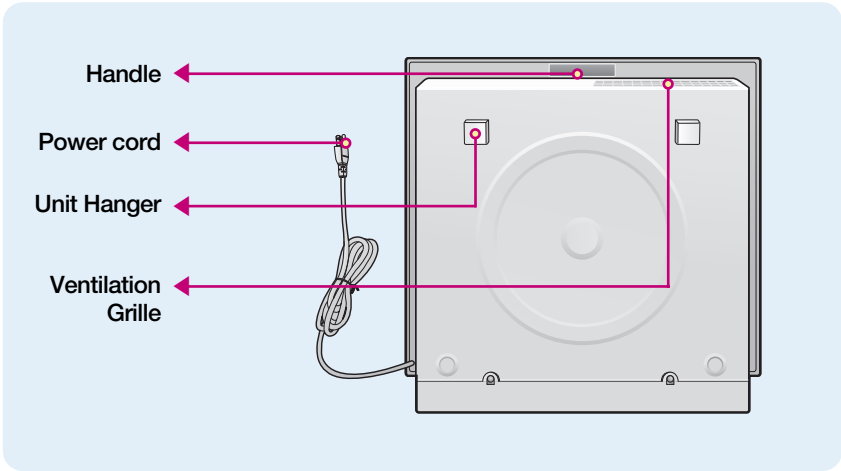

Remote control

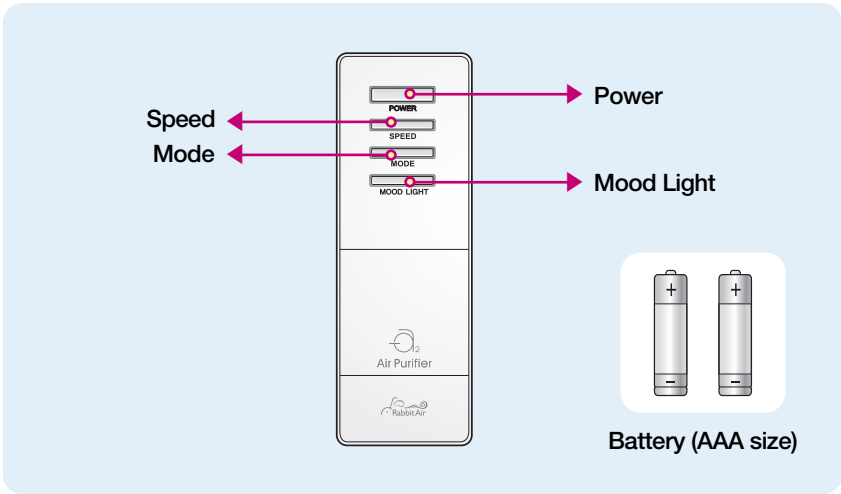

OPERATION PART

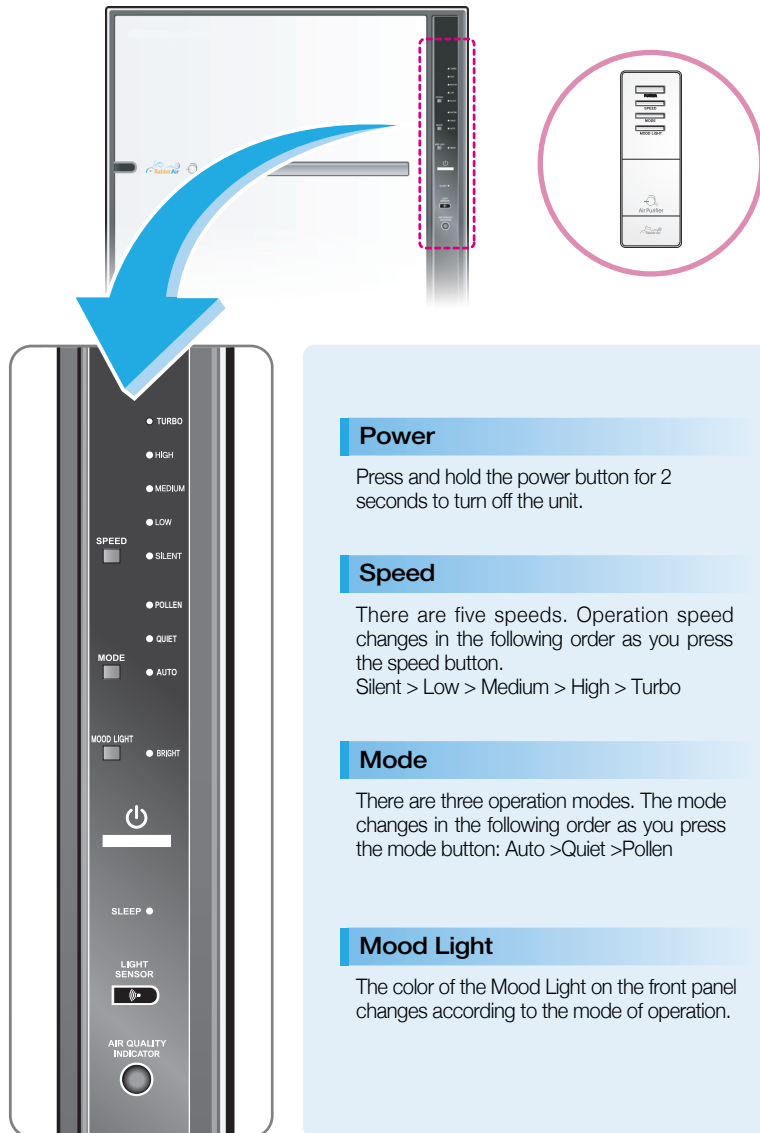

Power

Press and hold the power button for 2 seconds to turn off the unit.

Speed

There are five speeds. Operation speed changes in the following order as you press the speed button.
Silent > Low > Medium > High > Turbo

Mode

There are three operation modes. The mode changes in the following order as you press the mode button: Auto > Quiet > Pollen

Mood Light

The color of the Mood Light on the front panel changes according to the mode of operation.

INDICATION PART

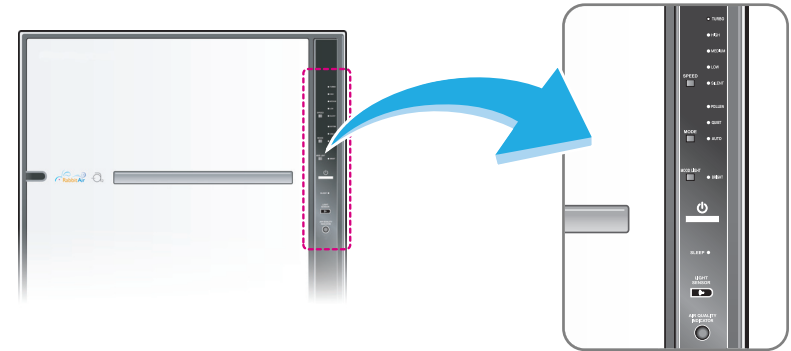

TURBO Fan Speed Indicator

- HIGH Indicates the fan speed of the Air Purifier.
- MEDIUM The lowest speed is Silent.
- LOW The highest speed is Turbo.
- SILENT
- POLLEN

Pollen Mode Indicator

When Pollen Mode is selected, the fan speed of the air purifier changes fan speeds (silent>low>medium>high) every 70 seconds, while the mood light changes in the following pattern blue>purple>light purple>pink every second.

Quiet Mode Indicator

When Quiet Mode is selected, the fan speed of the air purifier automatically switches to the lowest setting and the Mood Light turns purple.

Mood Light

The Mood Light has four colors: blue, purple, light purple and pink.

AUTO Auto Mode indicator

When Auto Mode is selected, the fan speed of the air purifier changes automatically depending on the amount of impurities in the air as detected by the particle sensors and the mood light turns blue.

BRIGHT Brightness Indicator

When the Brightness Indicator and the Sleep Mode are both on, the Mood Light turns off automatically. When the Brightness Indicator is off and the Sleep Mode is on, the Mood Light shines half as bright.

SLEEP Sleep Mode Indicator

This indicates that the unit is operating in the silent mode.

AIR QUALITY INDICATOR Air Quality Indicator

This indicates the current level of air quality in the room. The colors representing the air quality level are blue>purple>light purple>red. Blue represents good air quality, while red represents poor air quality.

NAMES OF INTERNAL FILTERS

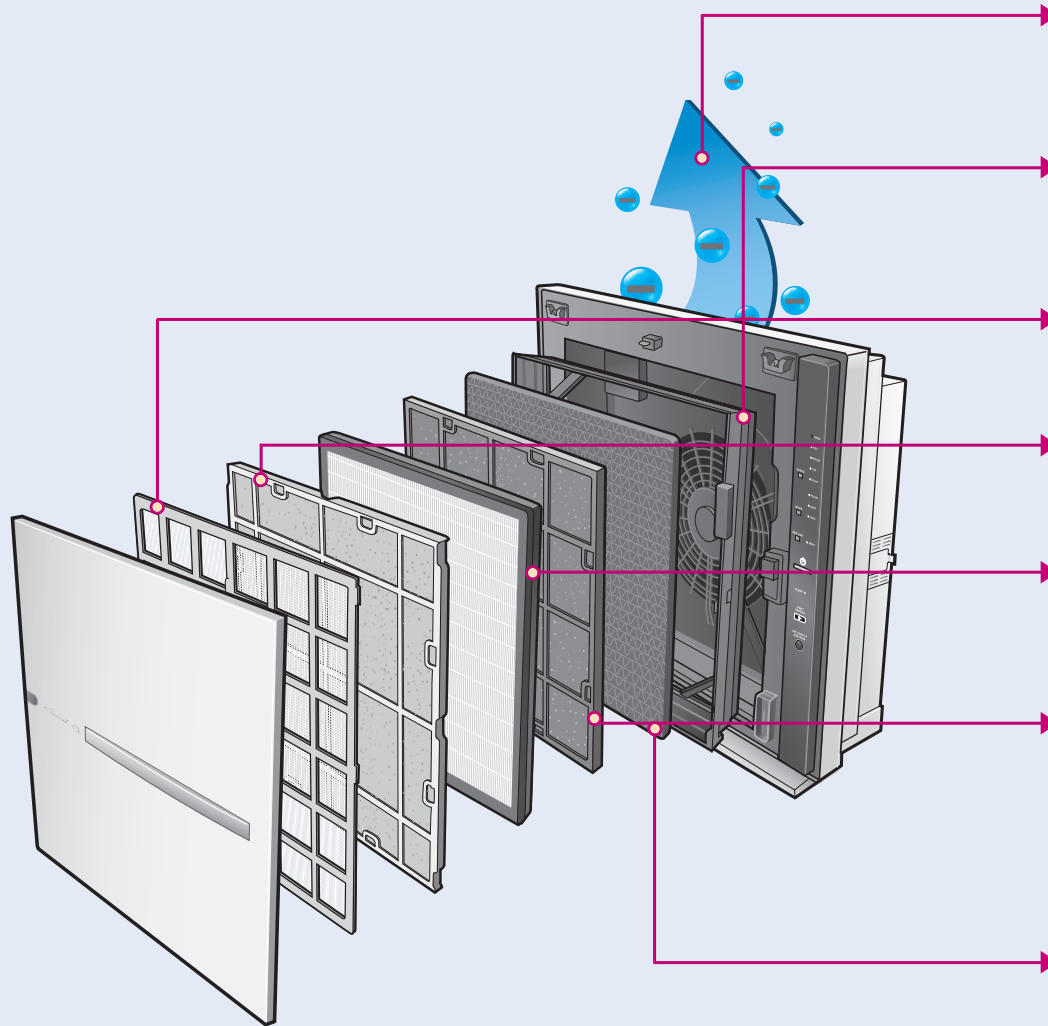

● Negative Ions

The air purifier produces millions of healthy "negative ions" to improve the air you breathe and freshen your indoor environment through the use of an ion generator inside of the unit.

● Filter Case

The filter case is designed to hold the Nano-Silver Pre-Filter, Medium Filter, BioGS™ HEPA Filter, Customized Filter and Charcoal-based Activated Carbon Filter.

● Nano-Silver Pre-Filter

The Nano-Silver Pre-Filter destroys germs and collects pet hair, large allergens and dust.

● Anti-Bacterial Medium Filter

The anti-bacterial Medium Filter traps particles, mold, and bacteria larger than 1 μm . It also extends the lifespan of the HEPA Filter.

● BioGS™ HEPA Filter

"Next Generation" HEPA Filter made from bio-engineered fiber traps and destroys the allergens such as pet dander, dust mite and pollen which accumulate on the filter.

● Customized Filters

There are three customized filters designed for specific needs.

- Toxin Absorber - eliminates toxic formaldehyde & offgassing from materials such as new furniture, carpet & paint.
- Germ Defense - protects against germs, mold, and bacteria such as Legionella.
- Pet Allergy- traps pet dander, destroys influenza virus & bacteria.

● Charcoal Based Activated Carbon Filter

The Charcoal-based Activated Carbon Filter efficiently removes VOC's, common household odors and chemicals.

PREPARATIONS

- ⚠ RabbitAir MinusA2™ Air Purifier is designed for residential use only.
- ⚠ To maintain the quality of the filters, they are packaged in plastic. Please remove the filters from the plastic bags before using the unit.
- ⚠ Lock the filter case in place on the unit.
- ⚠ Attach the Pre - Filter to the filter case by aligning the filter with the hooks of the case.
- ⚠ The non-woven fabric of the Customized Filter should face the front of the unit.

- 1 To remove the filter case, pull the bottom of the front panel and lift. Then take out the filter case.

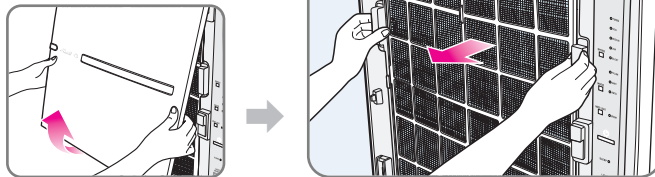

- 2 Remove the packing materials from the filters and reload the filters in the following order: Nano-Silver Pre-Filter, Medium Filter, BioGS™ HEPA filter, Customized Filter and Charcoal AC Filter.

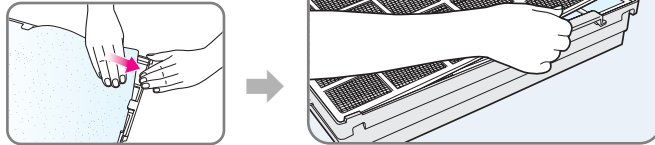

- 3 To place filter case back into the unit, lock the bottom of the filter case into the unit first and then the top. Finally, place the front panel back to the unit with the top first.

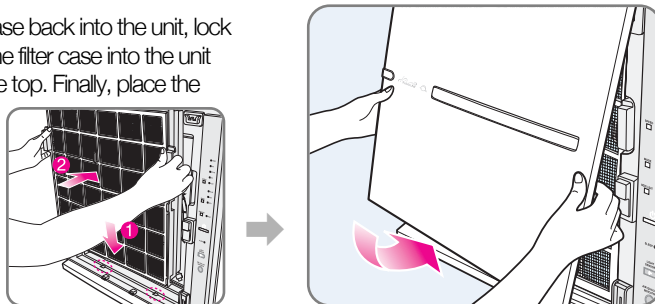

OPERATION

- ⚠ This unit is designed for residential use only.

Auto Mode Operation

Press the power button, the auto mode would turn on and mood light turns blue.

- 1 Plug the unit into a 110/120V outlet.

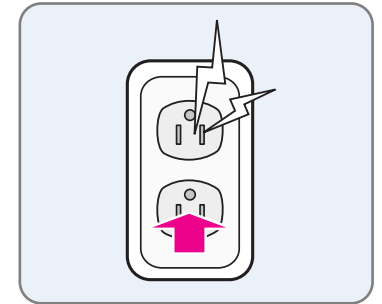

- 2 Press the power button, the air purifier is now in auto mode.

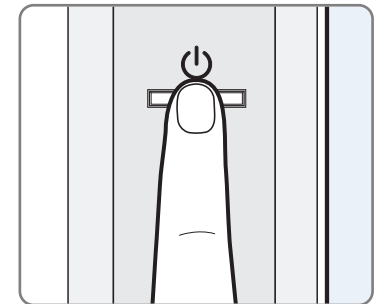

- 3 The Air Quality Indicator changes based on the amount of impurities in the air and the fan speed adjusts accordingly.

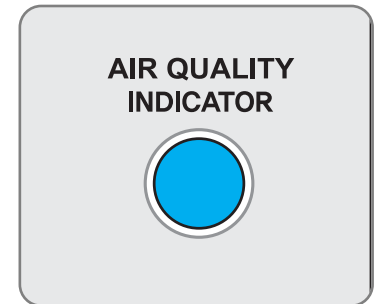

OPERATION

Manual Operation

To operate the unit manually, press the speed button after turning on the unit.

- 1 Plug the unit into a 110/120V outlet.

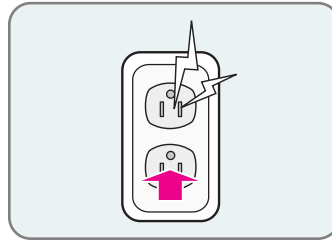

- 2 Press the power button, the air purifier should be in auto mode the first time it's plugged in.

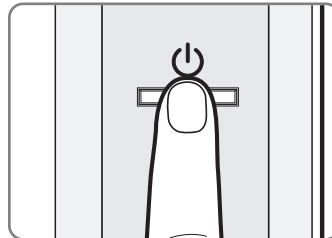

- 3 Press the speed button to change the speed. The speed will not change until you adjust it.

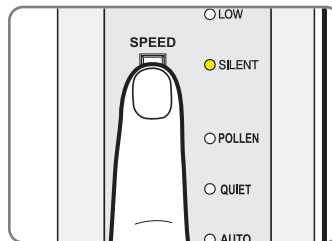

- 4 Press the button to select the speed. There are five speeds to choose from, Silent, Low, Medium, High and Turbo.

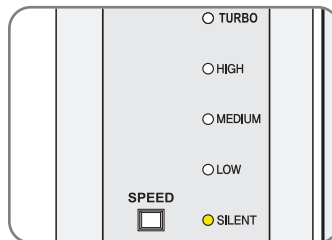
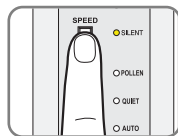

Mode Operation

After turning on the unit, press the mode button

- 1 Plug the unit into a 110/120V outlet.

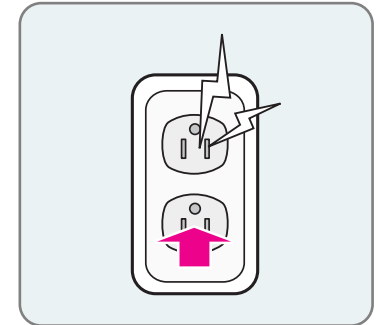

- 2 Press the power button to turn on the unit. The unit stays in the same mode it was in the last time the unit was turned off.

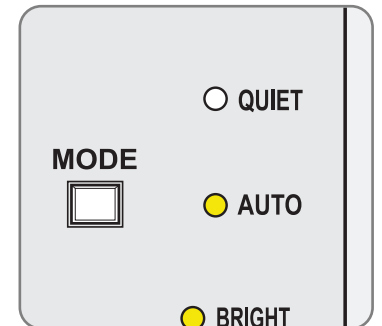
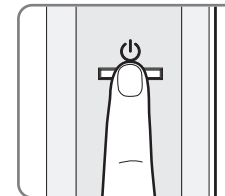

- 3 The 3 modes of operation are: Pollen, Quiet and Auto.

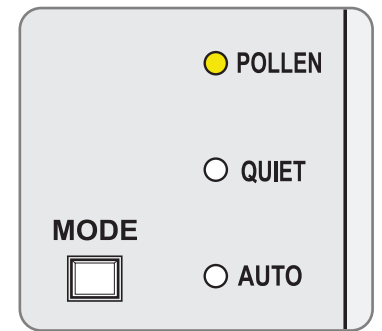
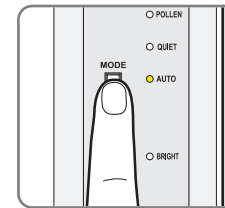

OPERATION

How Does Sleep Mode Work?



When the Silent Mode is turned on, the fan speed of the Air Purifier automatically changes to lowest, which minimizes the energy consumption and noise level.

- Light sensor detects the brightness of the surrounding room. Unit automatically switches to Silent Mode three minutes after darkness is detected.

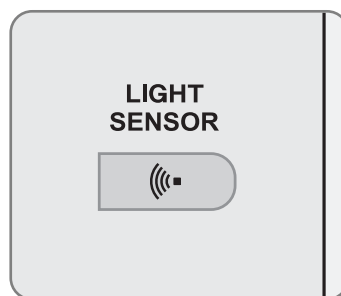

- In order to operate in Silent Mode, the Unit must be switched to Auto or Quiet Mode.

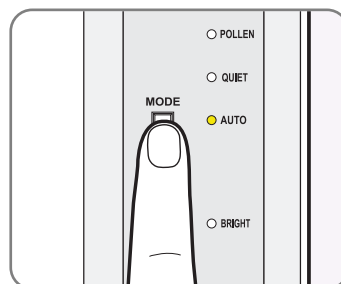

- Sleep Mode Indicator turns on in Silent Mode, which automatically switches off Mood Light and Air Quality Indicator.



How Do I Change the Particle Sensitivity Level?



You may need to adjust the sensitivity level if the air quality indicator is BLUE (good air quality) when the air in the room does not seem good or RED (bad air quality) even after 2 hours of operation.

- Press and hold both the speed and mode button for 3 seconds.

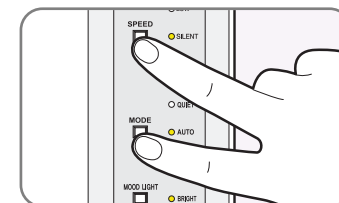

- The Air Quality Indicator and Auto Mode Indicator will blink.

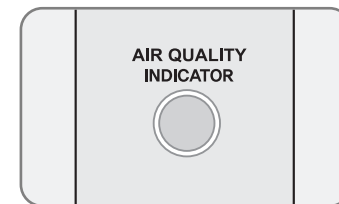

- Press and hold the speed button to choose the sensitivity level.

Pollen : Low
Quiet : Standard (Default)
Auto : High

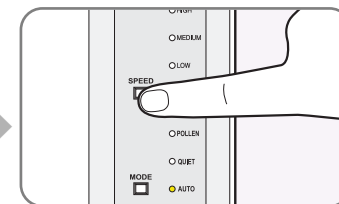
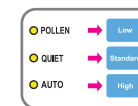

- Press and hold the speed and mode button for 3 seconds to save the sensitivity level. If no action is taken for 10 seconds, the sensitivity level saves itself automatically.

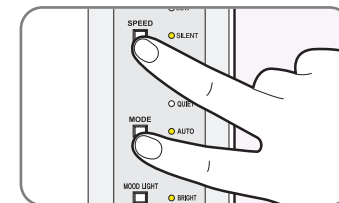

OPERATION

Mood Light



Mood light not only changes colors, but it also indicates the current operation mode.

- The mood light turns on automatically when the unit is turned on. Press the mood light button to turn on/off the mood light.

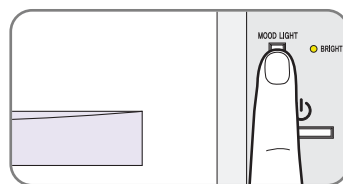

- Press and hold the Mood Light button for 2 seconds, the Brightness Indicator turns on and the Mood Light turns off.

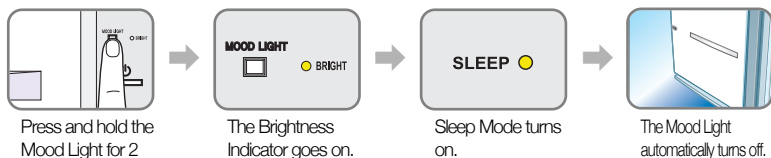

→ Press the mood light button for 2 seconds, the Indicator turns off and the Silent Mode resumes.

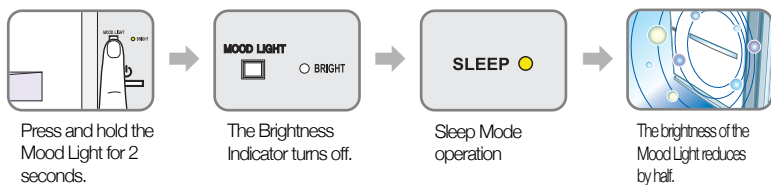

- The color of the Mood Light changes according to different mode.

Auto: Blue	Quiet : Purple
Pollen : Blue-Purple-Light Purple-Pink.	

* The mood light darkens when the Silent Mode turns on.

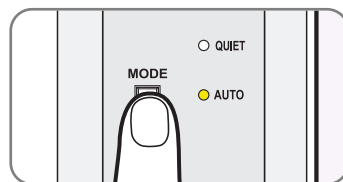

CLEANING and MAINTENANCE

Always unplug the unit before cleaning.

Cleaning the Particle Sensor

- Recommend cleaning particle sensor every 3 to 6 month.
- Clean the air inlet and outlet using a vacuum cleaner or soft brush.
- Open the particle sensor cover on the right side of the unit (when facing the unit). Use a wet cotton swab to clean and dry the lens, dust inlet and dust outlet.

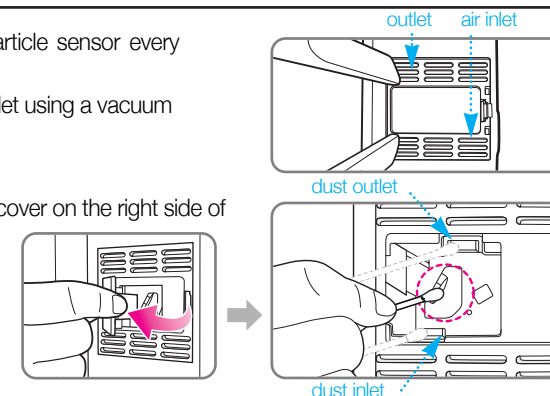

Cleaning the Air Intake and Outlet

- Clean the air intake and outlet with a soft brush.
- Be careful not to drop the brush into the unit.

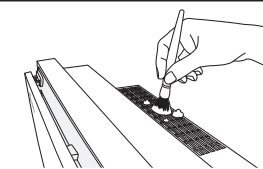

Cleaning the Negative Ion Generator

- Use a dry cotton swab to remove dust on the plate.
- Be careful not to drop the cotton swab into the unit.



Cleaning the Front Panel

- Remove the front panel from the unit and use a dry cloth or soft brush to dust it off.
- Use a wet cloth if necessary but do not use a polisher.

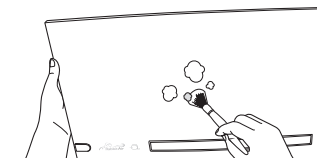

CLEANING and MAINTENANCE

Cleaning the Lens on the Back of the Front Panel

- Remove the front panel from the unit and use a dry cloth, soft brush, or cotton swab to dust off the mood light on the back of the panel.

Use a wet cloth if necessary but do not use a polisher.

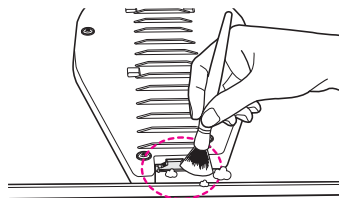

Cleaning the Unit

- Use a dry and soft cloth to clean the unit.

Use a wet cloth if necessary but do not use a polisher.



Cleaning the Nano-Silver Pre-Filter

- Pull the bottom of the front panel to remove it from the unit.

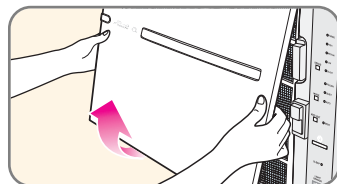

- Pull the filter out as shown on the picture at the right.

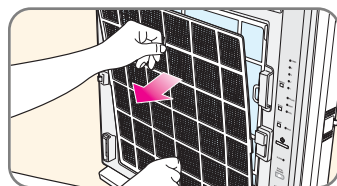

- Run a vacuum cleaner with a nozzle or brush attachment on low power setting along the Pre-Filter to pick up the dust and particles.

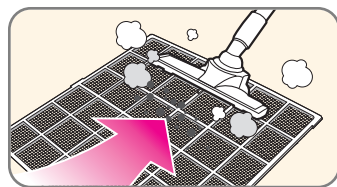

FILTER REPLACEMENT

- Always unplug the unit before cleaning/replacing the filters.
- Depending on the amount of pollutants in your indoor environment, the frequency of replacing the filter varies.
- When placing the filter case back into unit, make sure the bottom of the case goes into the unit first, and then follows the top.

- Dry the filter completely before attaching it to the filter case. Load the case onto the unit again.

Attach the pre filter to the filter case by aligning the filter with the hooks of the case.

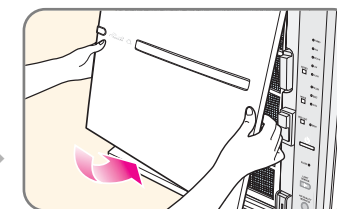
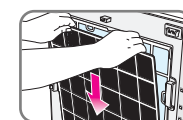

Replacing the Medium Filter (Every 12 Months)

- Remove the filter from the filter case. Do NOT discard the filter holder.

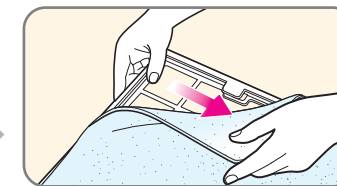
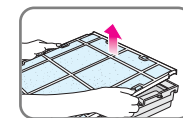

- To replace the medium filter, remove the new filter from the plastic bag, attach it to the filter holder, and place it back into the filter case.

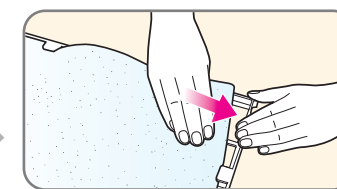
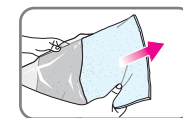

Replacing the BioGS™ HEPA Filter (Every 12 Months)

- Remove the front panel and then the BioGS™ HEPA filter.

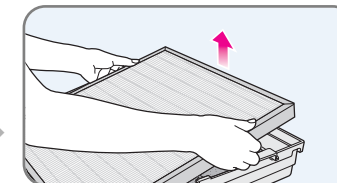
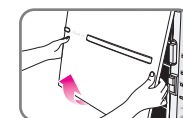

FILTER REPLACEMENT

- 2 Take out the new HEPA Filter from the plastic bag and put it into the filter case.

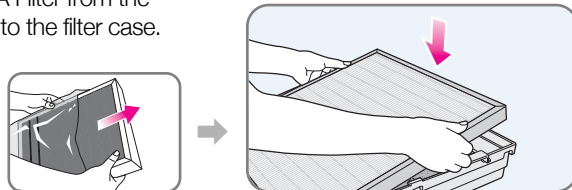

Replacing the Customized Filter (Every 12 Months)

- 1 Remove the new Customized Filter from the filter case. Do not discard the filter holder. Discard the old Customized Filter and do not store for re-use.

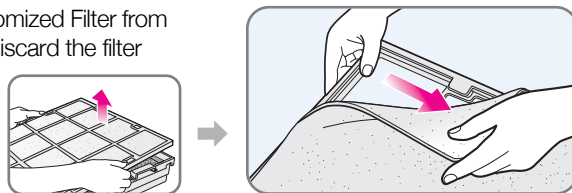

- 2 Remove the Customized Filter from the plastic bag. Attach the new Filter onto the filter holder and place it back into the filter case.

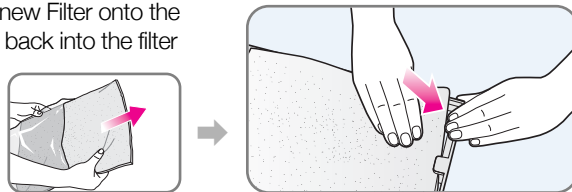

Replacing the Charcoal based Activated Carbon Filter (Every 12 Months)

- 1 Remove the old Charcoal-based Activated Carbon Filter from the filter case. Discard the old AC Filter and do not store for re-use.

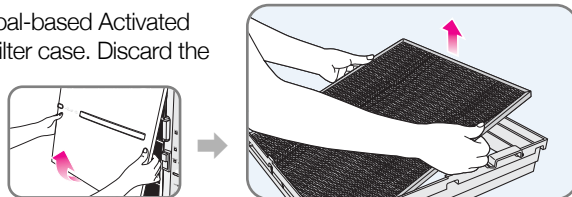

- 2 Remove the new Charcoal-based Activated Carbon Filter from the plastic bag, and place the filter back into the filter case.

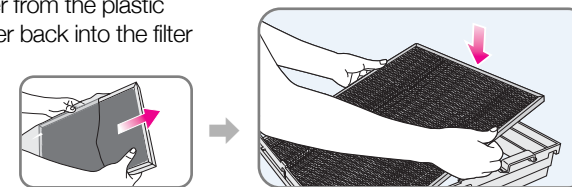

Note: Place the filters in the following order Pre-Filter (top), Medium, HEPA, Customized, and AC Filter.

Cleaning and replacement schedule

Filters	Replacement	Cleaning
Nano-Silver Pre-Filter	Permanent/Washable	Every Month
Medium	Every 12 Months	Not required
BioGS™ HEPA	Every 12 Months	Not required
Customized Filter	Every 12 Months	Not required
Charcoal based Activated Carbon	Every 12 Months	Not required

* Based on 24/7 operation.

Identify front side of custom Filter

Filter		Toxin Absorber	Germ Defense	Pet Allergy
Color	Front(Fabric)	Purple	Purple	Purple
	Back	Black	Yellow	Orange

► Wall-Mountable (Optional)

Use the optional wall-mount kit to install the air purifier.

<Installation>

Place the unit at some certain distance away from the ceiling and the other walls as shown on the picture at the right.

- Be careful not to drop the front panel or filter case when replacing the filters.
- Do not pull on the power cord.

▲ Drive in the screws of the hanger very tightly so that the unit will not fall off.

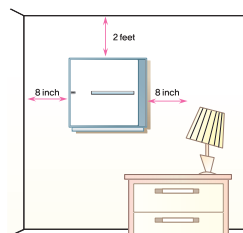

Disclaimer for installing wall mounted object

Do not attempt to install this product if you do not understand the instructions. Contact a qualified contractor to install the mounting brackets and call 1-888-866-8862 if you have any questions. You risk the possibility of damaging the Air Purifier, damaging other property and personal injury if the mounting brackets are not installed properly. Check to make sure there are no missing or defective parts. Do not attempt to assemble the mounting brackets if there are missing or defective parts. Contact Rabbit Air and replacement parts will be shipped to you immediately. Rabbit Air is not liable for damage or injury caused by incorrect mounting, incorrect assembly or incorrect usage.

- After installing the wall mount, make sure it is firmly in place before putting the air purifier on it.
- The biggest concern mounting on the wall is wiring in the wall. It's hard to be sure, but be careful not to drill or screw into any wiring.

Correct installation is extremely essential, and falls outside the scope of responsibility of Rabbit Air. The fastening material provided is exclusively intended for installation on walls made of solid wood, bricks, concrete or solidwood columns with a maximum of 3 mm wall finishing. For walls made of other materials, for example hollow bricks, please consult your installer and/or specialist supplier. Maximum weight of air purifier SPA-780A: 9.1 kg/20lbs.

TROUBLESHOOTING

Before calling for repair or replacement, or technical support, please review the list below. The problem may not be due to unit malfunction. If your problem is still unresolved after reviewing this guide, please call Rabbit Air Technical Support Team.

Symptom	Check	Solution
The unit does not operate.	<ul style="list-style-type: none"> • Is the unit plugged in? • Are the lights on display panel off? • Is the electricity cut off? 	<p>Plug the unit into a 110/120V outlet.</p> <p>Press the power and mode button.</p> <p>Operate the unit after electricity is resumed.</p>
Speed will not change.	<ul style="list-style-type: none"> • Has the auto mode been selected? • Is the room dark? 	<p>You can't select the speed when the auto mode is set.</p> <p>You can't select the speed when the silent mode is on.</p>
Air Quality Indicator does not change when cigarette smoke is in the air or when the air is highly polluted.	<ul style="list-style-type: none"> • Is the Particle Sensor clean? • Does it continually indicate 'Not Clean'? • Does it continually indicate 'Very Clean'? 	<p>Clean the lens. (Page 24)</p> <p>Lower the sensitivity. (Page 22)</p> <p>Raise the sensitivity. (Page 22)</p>
Speed is too slow.	<ul style="list-style-type: none"> • Have you cleaned or replaced the filters yet? 	<p>Check the cleaning and replacement schedule.</p>

Symptom	Check	Solution
There's odor from the air outlet.	<ul style="list-style-type: none"> Have you cleaned or replaced the filters yet? 	Check the cleaning and replacement schedule.
Air Quality Indicator blinks.	<ul style="list-style-type: none"> Call Rabbit Air Technical Support Team. 	
Other problems	<ul style="list-style-type: none"> Unplug the unit and call Rabbit Air Technical Support Team. 	

The Energy Star Label and disclaimer:



This product earned the ENERGY STAR by meeting strict energy efficiency guidelines set by the US EPA. US EPA does not endorse any manufacturer claims of healthier indoor air from the use of this product.

The energy efficiency of this ENERGY STAR qualified model is measured based on a ratio between the model's CADR for Dust and the electrical energy it consumes, or CADR/Watt.

LIMITED WARRANTY

Rabbit Air warrants that your Air Purifier will be free from defects in material or workmanship for a period of Five (5) years from the date of purchase. To activate the warranty, please complete and return your warranty registration within 30 days of purchase of your Air Purifier to Rabbit Air. In order to ensure unit performance, the filters should be replaced with original replacement filters as recommended in this manual (the 'Limited Warranty'). Otherwise the standard warranty time in your country applies.

Within the first 30 days of purchase, Rabbit Air will replace the defective unit at no additional cost and reimburse any shipping charges. After 30 days, Rabbit Air's obligation and liability under this Limited Warranty is limited to repairing or replacing (at its sole discretion) the defective unit. The Limited Warranty does not cover replacement filters.

In the event of a malfunction or failure of your Rabbit Air Air Purifier, please contact Rabbit Air to obtain a return authorization number and the address of the service center. The return authorization number must be clearly written on the outside of the shipping box or the shipment may be refused.

Your Limited Warranty remains in effect only if your Air Purifier:

- Is operated in accordance with the instruction provided.
- Is connected to a proper power supply (see voltage label on machine).
- There is no evidence of tampering, mishandling, neglect, accidental damage, modification, and/or repair done to the Air Purifier by anyone other than authorized service personnel.
- Your warranty registration has been completed and returned to Rabbit Air.

LIMITED AND EXCLUSIONS

There are no express warranties except as listed above.

THE WARRANTOR SHALL NOT BE LIABLE FOR INCIDENTAL OR CONSEQUENTIAL DAMAGES RESULTING FROM THE USE OF THIS PRODUCT, OR ARISING OUT OF ANY BREACH OF THIS WARRANTY. ALL EXPRESS AND IMPLIED WARRANTIES, INCLUDING THE WARRANTIES OF MERCHANTABILITY, AND FITNESS FOR A PARTICULAR PURPOSE, ARE LIMITED TO THE APPLICABLE WARRANTY PERIOD SET FORTH ABOVE.

Some states do not allow the exclusion or limitation of incidental or consequential damages, or limitation of incidental or consequential damages, or limitations on how long an implied warranty lasts, so the above exclusions or limitations may not apply to you.

This warranty gives you specific legal rights and you may also have other rights which vary from state to state.

If a problem with the product develops during the warranty period, we will repair or replace it without charge to you. A shipping and processing fee may apply. To obtain service under warranty, please contact Rabbit Air at 1-888-866-8862 or by email at products@RabbitAir.com

1. Mr. 2. Mrs. 3. Ms. 4. Miss

First Name Initial Last Name

Street Apt. No.

City State/Province ZIP/Postal Code Country

E-mail

2. Your date of birth: / /

6. Style/appearance
7. Product availability
8. Advertisement
9. Other

3. Marital status: 1. Married 2. Single

4. Date of purchase: / /

11. What is the primary reason you purchased this product? (Check only one)

1. Relieve Allergy or Asthma Symptoms
2. Improve Air Quality for Kids
3. Improve Home Comfort in general
4. Germicidal Protection/Relieve Cold & Flu Symptoms.
5. Reduce Smoking Odors in House
6. Reduce Pet Odors
7. Reduce Cooking Odors
8. Other

5. Model number: (please refer to owner's manual or the back of your product to locate the model number)

6. Serial number:

12. Where do you plan to use this Rabbit Air product? (Check all that apply)

1. Living Room 6. Office
2. Bedroom 7. Hallway
3. Child's Room 8. Bathroom
4. Family Room 9. Home workshop area
5. Kitchen 10. Other

8. Do you own a house or rent?
 Own Rent

9. Where did you first learn about Rabbit Air products?

1. Received as a gift
2. Newspaper
3. Salesperson
4. Friend/Relative
5. Online
6. Magazine
7. Prior experience with Rabbit Air brand
8. TV
9. Other _____

13. Which group describes your annual family income?

1. Under \$29,999 7. \$100,000-\$124,999
2. \$30,000-\$39,999 8. \$125,000-\$149,999
3. \$40,000-\$49,999 9. \$150,000-\$174,999
4. \$50,000-\$59,999 10. \$175,000-\$199,999
5. \$60,000-\$74,999 11. \$200,000-\$249,999
6. \$75,000-\$99,999 12. \$250,000 & over

10. What factors most influenced your decision to purchase this Rabbit Air product? (check up to 3)

1. Rabbit Air reputation
2. Prior experience with Rabbit Air
3. Value for the price
4. Quality
5. Size/dimension

14. Level of education: (check highest level completed)

1. Completed High School
2. Completed College
3. Completed Graduate School

15. If this product was available in different color, which color would you prefer? _____

16. Are there other features that you would like to see on this product? _____

