

Register your MBR900 Mobile Broadband N Router Today!

~ YOU WILL RECEIVE ~

- FREE Technical Support
- FREE Firmware Upgrades
- New Product Information
- Special Offers & Promotions

cradlepoint.com/register

What's Included In The Box

- Mobile Broadband N Router
- Ethernet Cable
- Quick Start Guide
- Power Adapter

cradlepoint
TECHNOLOGY

wiipe
POWERED

MBR900 Mobile Broadband N Router

3G/4G Ready



big WiFi n
CERTIFIED

There Are Two Ways To Set Up An MBR900 Router:

1) Wireless Setup using a Mobile Broadband (cellular) Data Modem

Connect Power Supply and insert USB modem.*
Then, follow the instructions below to establish an wireless internet connection.

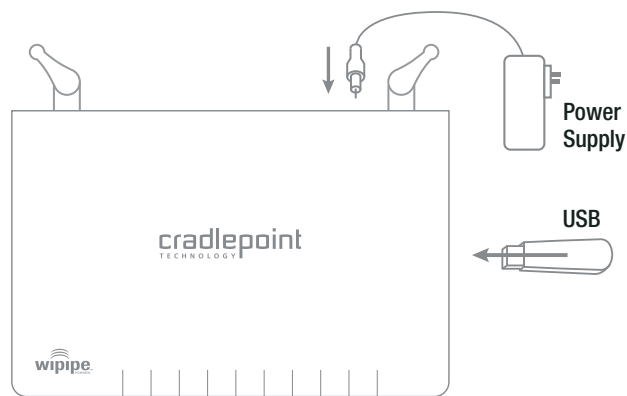

* Mobile Broadband Card not included.
See your Mobile Broadband Service Provider for details.

2) Wired Connection using Cable/DSL Internet Service

Connect power and insert one end of your Ethernet cable to the WAN port. Insert the other end of the Ethernet cable into your Internet service provider's modem. It may take a minute or two for the MBR1000 to initialize. Open your web browser. **You can now access the Internet.**

Note: CradlePoint recommends that WiFi security be setup at this point. See the "Setting WiFi security on your CradlePoint Router" section of this guide.

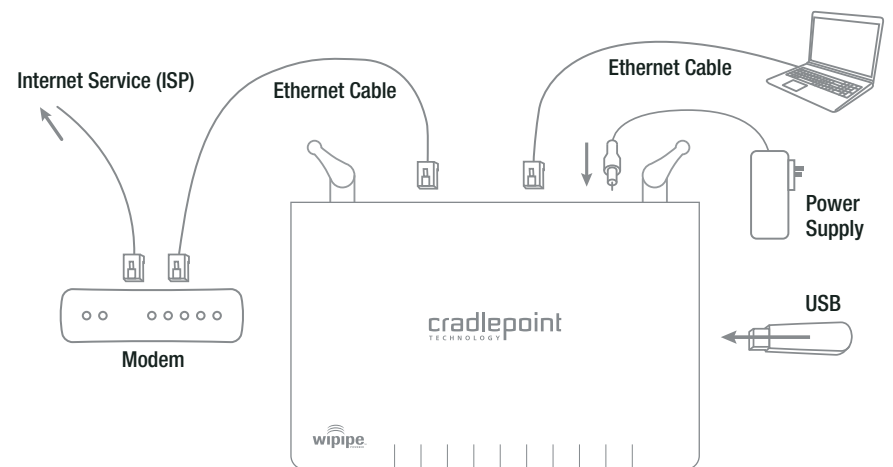

Establishing a Wireless Internet Connection

1) Identify the MBR900

Windows XP

Open your computer's **WIRELESS NETWORK CONNECTION** to associate with the router's Wireless Access Point. This is typically completed by opening **VIEW AVAILABLE NETWORKS** window. After you have highlighted the **MBR900-xxx**, click **CONNECT**.

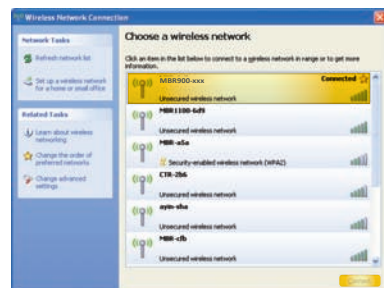

Windows Vista

Open **CONNECT TO A NETWORK** by clicking the Start button, and then click **CONNECT TO**. You'll see a list of the wireless networks currently available. Click on the **MBR900-xxx** network, and then click **CONNECT**.

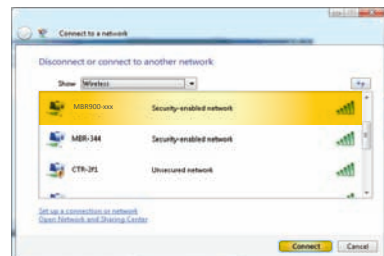

Mac

Open your wireless connection list by clicking the **AIRPORT** wireless icon on your menu bar. Click the **MBR900-xxx**.

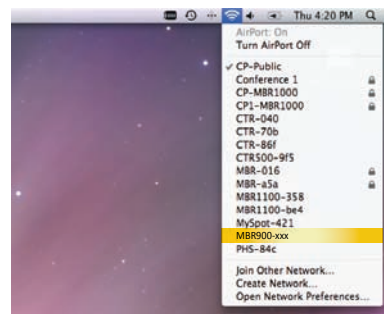

2) Connect To the Internet

- Using either a Windows or Mac platform, open a browser window. A default CradlePoint page will appear asking for a password.
- The **password is the last six digits of the MAC address** shown on the box label and on the bottom of the router. This is a unique number identifying your router.
- Once you have correctly entered your password, click "OK". **You can now access the Internet.**

Note: CradlePoint recommends that WiFi security be setup at this point. See the "Setting WiFi security on your CradlePoint Router" section of this guide.



Port Panel

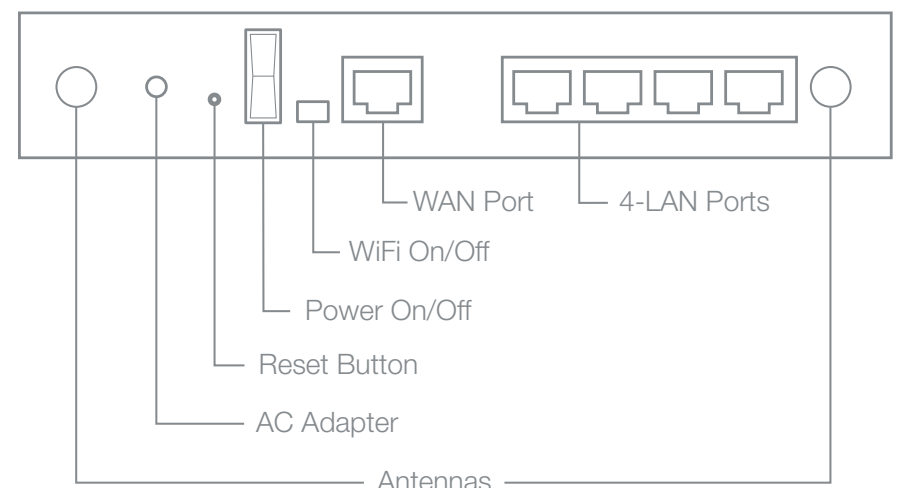

LED Status Lights

- Signifies the MBR1000 has power.
- Signifies the routers WiFi radio is "On". Blinking indicates traffic.
- Signifies that a connection is made on respective LAN port. Blinking indicates traffic over the port.
- Signifies that a connection is made on the WAN port. Blinking indicates traffic over the port.
Note: The WAN port will turn on even if plugged into a computer. It is for Internet connections only (i.e. DSL/Cable modems).
- Stands for "WiFi Protected Setup." When you push it, the router goes into setup mode for 90 seconds; in which time, it looks for other WPS devices that are also in setup mode. When they find each other, they setup WPA-Personal Security between the 2 WiFi devices.
Note: While in SGML mode, you are still able to enter WPS mode, but the WPS LED will not be used. Also, if you enter SGML mode while in WPS mode, WPS will continue normally but the WPS LED will not be used.
- Indicates a recognizable cellular device is connected to the router.
Red No Connection is being Attempted or Device not Recognized or Supported
Orange (Blinking) Modem is Dialing
Orange (Solid) Modem is Recognized
Green (Blinking) Modem is Negotiating
Green (Solid) Modem is Connected
- While in Signal Strength button is pressed, the WAN, WiFi, WPS and Modem LEDs display the strength of the Mobile Broadband Modem signal.

TECHNICAL INFORMATION FOR THE MBR900

Setting WiFi Security on your CradlePoint Router

WiFi security is highly recommended by CradlePoint. *WiFi Security is separate from the User Login Page.* Setting "WiFi Security" on your router prevents users from connecting their computers to your router unless they have your wireless security password.

Follow The Steps Below To Set The WiFi Security:

- 1) Access your router administration page by opening your browser and typing **http://192.168.0.1** in the address bar.
- 2) Enter your **DEFAULT ADMINISTRATIVE PASSWORD**. This password is the **last six digits of the MAC address** found on the label on the bottom of your router.
- 3) Once you are connected, click on the **BASIC** tab, click **SETUP WIZARD**, click **NEXT**.
- 4) You will see a summary of the upcoming Setup Wizard Steps, click **NEXT**.
- 5) The default Administrative password should appear. Select your TIME ZONE, click **NEXT**.

- 6) One option to establish network security is by selecting **REQUIRE USER LOG-IN**. By using this setting, you will force every user of the router to log-in using the User Login Password (*Set in a separate location in the User Interface*). By turning **OFF** the Require User Log-In, you will still be able to secure your network using the settings below.
- 7) The next option is to select an appropriate **LEVEL OF WIFI SECURITY**. This will allow you to create an encrypted security key for your network based on the security mode you select. Choose the security mode that best fits your needs: **GOOD** for WEP, **BETTER** for WPA and **BEST** for WPA2. (*Make sure your PC or other devices support the mode you choose.*) Choose a personalized **SECURITY PASSWORD**. This password will be used to re-connect your devices to the router once the security settings have been changed. Click **NEXT**.
- 9) Record the setup information shown on the final summary page, then click **CONNECT**. This will save your new settings and apply them to your router. If you are using WiFi, you will need to re-connect to the router using the password you've just established in step 7.

You've now secured your CradlePoint router from unintended WiFi access.

Your USB Modem or Phone Does Not Work With the Router

- 1) If your USB data modem or phone is not working with the router, check the list of supported devices to ensure you are using a supported device and carrier. The device you're using must be supported on the carrier network providing your cellular service or it's considered an unsupported device, even if it is supported on another carrier's network.

CradlePoint's supported device list changes regularly. We update our supported device list after a device is certified and approved. If the device you have is NOT on the list, that means we do not support it at this time.

The SUPPORTED DEVICE list can be found at: cradlepoint.com/support/MBR900

- 2) Sometimes a USB data modem needs to be updated or have other configurations set correctly in order to make a connection through the router. If your USB Modem has not been updated recently, it is recommended that you do so if it is having trouble connecting to the MBR900. Simply insert your USB data modem into your PC and using the software provided by your cellular carrier, access the Internet. Follow the directions provided to complete the update. Once you have updated your USB data modem, reconnect the cellular device to your CradlePoint router and connect to the Internet.

If, after following the above directions, you are still unable to access the Internet, contact CradlePoint Technical Support for further assistance.

My WiFi-enabled Devices Can't Get Past The Login Page

Some electronic devices may experience problems handling the Internet Access User Login setting. Devices that commonly have trouble are, but not limited to:

- iPod Touch
- iPhone
- Wireless VoIP Phones
- Wireless Printers
- most WiFi-enabled Video Game Systems
- most WiFi-enabled Devices that are not PCs or Macs





To Allow These Devices Access, follow the instructions below to disable the user login.

- 1) Access your router administration page by opening your browser and typing **http://192.168.0.1** in the address bar.
- 2) Go to the **TOOLS** tab on the top navigation, then the **USER LOGIN** menu on the left panel.
- 3) Uncheck the **REQUIRE USER LOGIN** check box.
- 4) Scroll to the top of the page and click **SAVE THE SETTINGS**, which will save and reboot the router with your new configuration.

Note: Because the User Login page adds security and access control to others connected to your router, you may need to enable additional security features such as WEP, WPA, or MAC Address Filtering (if you are not already doing so) when turning off the User Login Page. See the "Setting WiFi Security on your CradlePoint Router" section of this guide for details.

You are Connected to the Router but Cannot Connect to the Internet

The status LEDs of your router will give you an indication whether or not a proper connection is being made. See the LED STATUS definitions below:

-  The MBR900 must be powered using an approved power adapter.
Green The MBR900 is powered on.
No Light The MBR900 is not connected to power. Check that the unit is connected to an outlet.
-  When your MBR900 is up and running, it creates a shareable wireless signal (WLAN).
Green The Wireless LAN is active and available to share.
No Light The Wireless LAN is not active.
-  You may connect the MBR900 via an Ethernet cable to your Cable or DSL Modem.
Green Connected to an active Ethernet Connection.
No Light Not connected to Ethernet, the connection is not configured correctly, or Cable or DSL modem is not configured correctly (or turned on).
-  The MBR900 works with USB, ExpressCard, or PC Card Mobile Broadband Modems with active data plans.
Green Data connection has been established with your cellular network.
No Light Cellular network is unavailable or connection is still in progress. Standard connection time is 15-30 seconds.

If the USB Data Modem LEDs are not illuminated, your modem is not connected and online. You may need to update firmware. Refer to "Your USB Modem or Phone Does Not Work With The Router." If, after updating, you are still not online, call CradlePoint Technical Support for further assistance.

I Need To Update My Firmware

To support the latest features, modems, and phones, follow the directions below:

- 1) Access your router administration page by opening your browser and typing **http://192.168.0.1** in the address bar.
- 2) Select the **TOOLS** tab on the top navigation, then the **FIRMWARE** menu on the left.
- 3) Select **ONE-BUTTON FIRMWARE UPDATE** for easy firmware updates.

If you experience problems, you can also install the firmware manually.

- 1) Download the new firmware by going to cradlepoint.com/support/MBR900.
- 2) Select the **TOOLS** tab on the top navigation, then the **FIRMWARE** menu on the left.
- 3) In the **FIRMWARE UPGRADE** section, click **BROWSE**.
- 4) Browse for the new firmware file you downloaded in Step 1 and click **OPEN**.
- 5) Click the **UPLOAD** button. The upgrade process can take a minute or two.

DO NOT TURN OFF OR UNPLUG THE DEVICE WHILE IT IS UPGRADING!

Regulatory Information

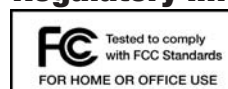

This equipment has been tested and found to comply with the limits for a Class B digital device, pursuant to Part 15 of the FCC Rules. These limits are designed to provide reasonable protection against harmful interference in a residential installation. This equipment generates, uses, and can radiate radio frequency energy and, if not installed and used in accordance with the instructions, may cause harmful interference to radio communications. This device must accept any interference received, including interference that may cause undesired operation. However, there is no guarantee that interference will not occur in a particular installation. If this equipment does cause harmful interference to radio or television reception, which can be determined by turning the equipment off and on, the user is encouraged to try and correct the interference by one or more of the following measures:

- Reorient or relocate the receiving antenna.
 - Increase the separation between the equipment and receiver.
 - Connect the equipment into an outlet on a circuit different from that to which the receiver is connected.
 - Consult the dealer or an experienced radio or television technician for help.
- Changes or modifications not expressly approved by CradlePoint, Inc. could void the user's authority to operate the product.

Radio Frequency Interference Requirement - Canada

This Class B digital apparatus complies with Canadian ICES-003. Cet appareil numérique de la classe B est conforme à la norme NMB-003 du Canada.

Warranty Information

CradlePoint, Inc. warrants this product against defects in materials and workmanship to the original purchaser (or the first purchaser in the case of resale by an authorized distributor) for a period of one (1) year from the date of shipment. This warranty is limited to a repair or replacement of the product, at CradlePoint's discretion.

Within thirty (30) days of receipt should the product fail for any reason other than damage due to customer negligence, purchaser may return the product to the point of purchase for a full refund of the purchase price.

If the purchaser wishes to upgrade or convert to another CradlePoint, Inc. product within the thirty (30) day period, purchaser may return the product and apply the full purchase price toward the purchase of the other product. Any other return will be subject to CradlePoint, Inc.'s existing return policy.

Still Have Questions??

visit
cradlepoint.com/knowledge-base

or

EMAIL support@cradlepoint.com

CHAT cradlepoint.com/content/chat-support

CALL (208) 424-5054 Option #2
Monday-Friday 7:00am to 7:00pm MST