

## INTELLIGENT UPS SERIES

### OR1500LCDRTL2U / OR2200LCDRTL2U

# USER MANUAL

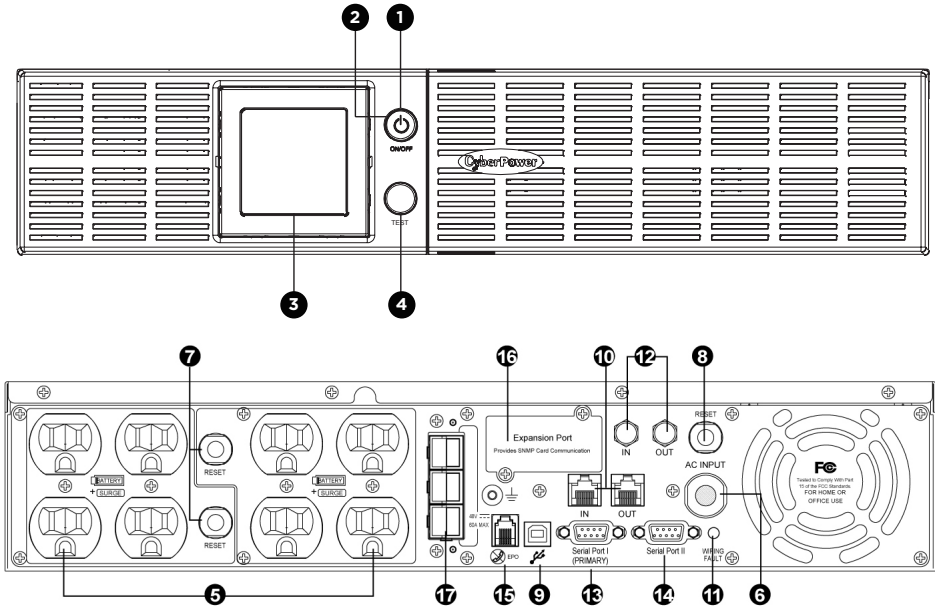

## FEATURES

1. Power Switch
2. Power On Indicator (Blue)
3. LCD Module Display
4. LCD Function Selection Switch
5. 8 Full-Time Battery Powered and Surge Protected Outlets
6. AC Power Cord
7. Output Circuit Breaker
8. Input Circuit Breaker
9. USB Port
10. Communication Protection Ports RJ45
11. Wiring Fault Indicator (Red)
12. Coax / Cable / DSS Surge Protection
13. Serial Port I (Primary)
14. Serial Port II (Dry Contact)
15. EPO (Emergency Power Off) Port
16. SNMP / HTTP Network Slot
17. External Battery Pack Connector

Cyber Power Systems (USA), Inc.

---

## PRODUCT REGISTRATION

Thank you for purchasing a CyberPower product. This UPS is designed to provide unsurpassed power protection, operation, and performance during the lifetime of the product. Please take a few minutes to register your product at: [www.CyberPowerSystems.com/registration](http://www.CyberPowerSystems.com/registration). Registration certifies your product's warranty, confirms your ownership in the event of a product loss or theft, and entitles you to free technical support. Register your product now to receive the benefits of CyberPower ownership.

---

## IMPORTANT SAFETY WARNINGS (SAVE THESE INSTRUCTIONS)

This manual contains important safety instructions. Please read and follow all instructions carefully during installation and operation of the unit. Read this manual thoroughly before attempting to unpack, install, or operate your UPS.

**CAUTION!** To prevent the risk of fire or electric shock, install in a temperature and humidity controlled indoor area free of conductive contaminants. (Please see specifications for acceptable temperature and humidity range).

**CAUTION!** To reduce the risk of electric shock, do not remove the cover except to service the battery. Turn off and unplug the unit before servicing the batteries. There are no user serviceable parts inside except for the battery.

**CAUTION!** Hazardous live parts inside can be energized by the battery even when the AC input power is disconnected.

**CAUTION!** The UPS must be connected to an AC power outlet with fuse or circuit breaker protection. Do not plug into an outlet that is not grounded. If you need to de-energize this equipment, turn off and unplug the unit.

**CAUTION!** To avoid electric shock, turn off the unit and unplug it from the AC power source before installing a computer component.

**CAUTION!** To reduce the risk of fire, connect only to a circuit provided with 20 amperes maximum branch circuit over current protection in accordance with the National Electric Code, ANSI/NFPA 70.

**CAUTION!** Not for use in a computer room as defined in the Standard for the Protection of Electronic Computer/Data Processing Equipment, ANSI/NFPA 75.

**CAUTION!** Do not dispose of batteries in a fire. The batteries may explode.

**CAUTION!** Do not open or mutilate batteries. Released electrolyte is harmful to the skin and eyes. It may be toxic.

### **DO NOT USE FOR MEDICAL OR LIFE SUPPORT EQUIPMENT!**

CyberPower Systems does not sell products for life support or medical applications. DO NOT use in any circumstance that would affect operation and safety of life support equipment, any medical applications or patient care.

### **DO NOT USE WITH OR NEAR AQUARIUMS!**

To reduce the risk of fire or electric shock, do not use with or near an aquarium. Condensation from the aquarium can cause the unit to short out.

### **DO NOT USE THE UPS ON ANY TRANSPORTATION!**

To reduce the risk of fire or electric shock, do not use the unit on any transportation such as airplanes or ships. The effect of shock or vibration caused during transit and the damp environment can cause the unit to short out.

# INSTALLING YOUR UPS SYSTEM

## UNPACKING

Inspect the UPS upon receipt.

The box should contain the following:

- (a) UPS unit
- (b) User's manual
- (c) Rack mount brackets x 2
- (d) Stands x 2
- (e) Telephone cable
- (f) Emergency power off cable (gray)
- (g) Serial cable x 2
- (h) USB A+B type cable

PowerPanel® Business Edition software is available on our website. Please visit [www.cyberpowersystems.com](http://www.cyberpowersystems.com) and go to the Software Section for a free download.

## OVERVIEW

The OR1500LCDRTXL2U/OR2200LCDRTXL2U provides complete power protection from utility power that is not always consistent. The OR1500LCDRTXL2U features 1840 Joules of surge protection and the OR2200LCDRTXL2U features 2060 Joules of surge protection. Both units provide long lasting battery backup during power outages with maintenance free batteries. The OR1500LCDRTXL2U/OR2200LCDRTXL2U ensure consistent power to your computer system and include software that will automatically save your open files and shutdown your computer system during a utility power loss.

## AUTOMATIC VOLTAGE REGULATOR

The OR1500LCDRTXL2U/OR2200LCDRTXL2U stabilizes inconsistent utility power voltage to nominal levels that are safe for equipment. Inconsistent incoming utility power may be damaging to important data files and hardware, but with Automatic Voltage Regulation (AVR), damaging voltage levels are corrected to safe levels. AVR automatically increases low utility power and decreases high utility power to a consistent and safe 110/120 volts. If incoming utility voltage drops below 90 volts, or exceeds 140 volts the units automatically switch to battery back-up power.

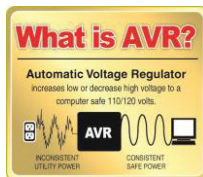

## DETERMINE THE POWER REQUIREMENTS OF YOUR EQUIPMENT

1. Ensure that the equipment plugged into the outlet does not exceed the UPS unit's rated capacity (1500VA/1125W for OR1500LCDRTXL2U, 2190VA/1650W for OR2200LCDRTXL2U). If the rated capacities of the unit are exceeded, an overload condition may occur and cause the UPS unit to shut down or the circuit breaker to trip.
2. There are many factors that can affect the amount of power that your computer system will require. It is suggested that the load placed on the battery outlets not exceed 80% of the unit's capacity.

## HARDWARE INSTALLATION GUIDE

1. Your new UPS may be used immediately upon receipt. However, recharging the battery for at least 8 hours is highly recommended to ensure that the battery's maximum charge capacity is achieved. A loss of charge may occur during shipping and storage. To recharge the battery, simply leave the unit plugged into an AC outlet.

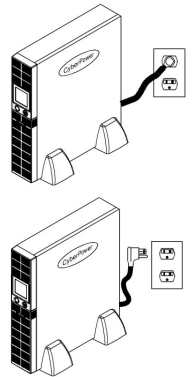

2. With the UPS unit turned off and unplugged, connect your computer, monitor, and any other peripherals requiring battery backup into the battery power supplied outlets. Plug the other peripheral equipments (printer, scanner, speakers) into the full-time surge protection outlets. DO NOT plug a laser printer, paper shredder, copier, space heater, vacuum, sump pump or other large electrical devices into the UPS. The power demands of these devices will overload and possibly damage the unit.

-continued

## INSTALLING YOUR UPS SYSTEM - continued

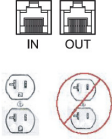
- To protect a fax, phone or modem, connect a telephone cable or network cable from the wall jack outlet to the IN jack of the UPS. Connect a telephone cable or network cable from the OUT jack of the UPS to a fax machine, telephone, modem, or network devices.
- Plug the UPS into a 2-pole, 3-wire grounded receptacle (wall outlet). Make sure the wall branch outlet is protected by a fuse or circuit breaker and does not service equipment with large electrical demands (e.g. air conditioner, refrigerator, copier, etc.). The warranty prohibits the use of extension cords, outlet strips, and surge strips.
- Press the power switch to turn the unit on. The Power On indicator light will illuminate and the unit will "beep". If an overload is detected, an audible alarm will sound and the unit will emit one long beep. To correct this, turn the UPS off and unplug at least one piece of equipment from the battery power supplied outlets. Make sure the circuit breaker is depressed and then turn the UPS on.
- To maintain optimal battery charge, leave the UPS plugged into an AC outlet at all times.
- To store the UPS for an extended period, cover it and store with the battery fully charged. While in storage, recharge the battery every three months to ensure battery life.
- To use PowerPanel® Business Edition software, connect the serial cable to the serial port or the USB port on the UPS and the computer. These OR units include one serial port, one dry contact, and one USB port to allow connection and communication between the UPS and computers. Serial port II produces basic information for equipment that can utilize a dry contact UPS. The primary computer (with PowerPanel® Business Edition installed) is the computer that you will use to control the UPS and make changes to the operation of the UPS. When there is a power failure, the computer connected to the Primary port will start to shut down after a user controlled delay. PowerPanel® Business Edition will save and close any open files prior to shutting down the system.

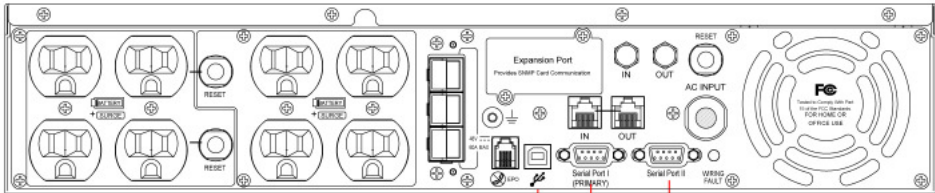

Primary Computer-  
Install PowerPanel  
Business Edition



Primary Computer-  
Install PowerPanel  
Business Edition



The equipment that  
can read information  
from dry contact

## BASIC OPERATION

### 1. Power Switch

Master on/off switch for equipment connected to the UPS.

### 2. Power On Indicator (blue)

This LED is illuminated when the utility power is normal and the UPS outlets are providing power, free of surges and spikes.

### 3. LCD module display

Crystal Blue intelligent LCD panel shows all the UPS information using icons and messages. For more information please review the “Definitions for Illuminated LCD Indicators” section below.

### 4. LCD function selection switch

The switch can be used to select the LCD display contents including input/output voltage and estimated run time, etc.

### 5. 8 Full Time Battery Powered and Surge Protected Outlets

The unit has eight battery powered/surge suppression outlets for connected equipments to ensure temporary uninterrupted operation of your equipment during a power failure. **(DO NOT plug a laser printer, paper shredder, copier, space heater, vacuum, sump pump or other large electrical devices into the UPS. The power demands of these devices will overload and possibly damage the unit.)**

### 6. AC Input Power Cord

Heavy-duty, extra long power cord.

### 7. Output Circuit Breaker

Resettable circuit breakers provide output optimal overload protection.

### 8. Input Circuit Breaker

Resettable circuit breakers provide input optimal overload protection.

### 9. USB Port

The USB port allows connection and communication between the USB port on the computer and the UPS unit.

### 10. Communication Protection Ports

Communication protection ports will protect any standard modem, fax, telephone line, network or Ethernet connection (RJ11/RJ45).

### 11. Wiring Fault Indicator (red)

This LED indicator will illuminate to warn the user that a wiring problem exists, such as bad ground, missing ground or reversed wiring. If this is illuminated, disconnect all electrical equipments from the outlet and have an electrician verify the outlet is properly wired. The unit will not provide surge protection without being plugged into a grounded and properly wired wall outlet.

### 12. Coax/Cable/DSS Surge Protection

The Coax/Cable/DSS surge protection ports will protect any cable modem, CATV converter, or DSS receiver.

### 13. Serial Port I (Primary)

The serial port allows connection and communication between the UPS and the computer.

### 14. Serial Port II (Dry Contact)

Dry contact produces information for equipment that can utilize dry contact signals.

### 15. EPO (Emergency Power Off) Port:

Use the provided gray cable to connect to a special EPO contact switch. Follow the appropriate circuit diagram below to wire the cable to your EPO configuration. The EPO remote switch is a switch installed in an outside area, connected to the unit via the Emergency Power Off cable. In case of an emergency, it can be used to immediately cut-off power from the UPS.

### 16. SNMP/HTTP Network Slot:

Remove the cover panel to install an optional RMCARD provides remote monitoring and management of your UPS over a network.

### 17. External Battery Pack Connector

Use to connect the optional CyberPower external battery packs for extended runtime.

#### OPTION 1: USER SUPPLIED NORMALLY CLOSED SWITCH



#### OPTION 2: USER SUPPLIED NORMALLY OPEN SWITCH

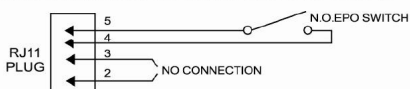

## REPLACING THE BATTERY

Read and follow the IMPORTANT SAFETY INSTRUCTIONS before servicing the battery. Service the battery under the supervision of personnel knowledgeable of batteries and their precautions. CAUTION! Servicing of the battery should only be performed by trained personnel familiar with batteries and their precautions. For more information on battery replacement, contact your dealer or call the number on this manual.

Replacement of batteries located in an OPERATOR ACCESS AREA.

1. When replacing batteries, replace with the same number of the following battery: CyberPower RBP834 for the OR1500LCDRTXL2U; CyberPower RBP844 for the OR2200LCDRTXL2U.

2. **CAUTION!** Risk of Energy Hazard, 12 V, maximum 7(for the OR1500LCDRTXL2U) or 9 (for the OR2200LCDRTXL2U) Ampere-hour battery. Before replacing batteries, remove conductive jewelry such as chains, wrist watches, and rings. High energy conducted through these materials could cause severe burns;
3. **CAUTION!** Do not dispose of batteries in a fire. The batteries may explode;
4. **CAUTION!** Do not open or mutilate batteries. Released material is harmful to the skin and eyes. It may be toxic.

**CAUTION - RISK OF EXPLOSION IF BATTERY IS REPLACED BY AN INCORRECT TYPE. DISPOSE OF USED BATTERIES ACCORDING TO LOCAL REGULATIONS**

### BATTERY REPLACEMENT PROCEDURE:

1. Remove the right side front panel.
2. Remove the three retaining screws of the cable protection cover then remove the cover.
3. Remove the two retaining screws of the cable connectors.
4. Disconnect the black and red cable
5. Remove the four retaining screws.
6. Insert the new battery pack. Assemble the screws, cover, cable and front panel in the reverse sequence of above steps. Recharge the unit for 4-8 hours to ensure the UPS performs expected runtime.

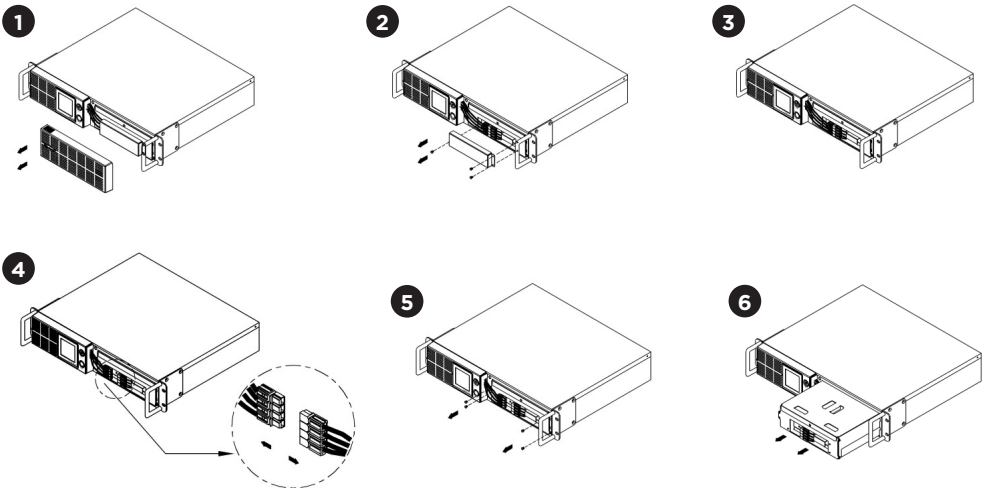

**REMINDER:** Batteries are considered **HAZARDOUS WASTE** and must be disposed of properly. Most retailers that sell lead-acid batteries collect used batteries for recycling, as required by local regulations.

# DEFINITIONS FOR ILLUMINATED LCD INDICATORS

**1. INPUT Voltage Meter:** This meter measures the AC voltage that the UPS system is receiving from the utility wall outlet. The UPS is designed, through the use of automatic voltage regulation, to continuously correct output voltage to connected equipment to a safe 110/120 voltage output range. In the event of a complete power loss, severe brownout, or over-voltage, the UPS relies on its internal battery to supply consistent 110/120 output voltage. The INPUT voltage meter can be used as a diagnostic tool to identify poor-quality input power.

**2. OUTPUT Voltage Meter:** This meter measures, in real time, the AC voltage that the UPS system is providing to the computer, such as normal line mode, AVR mode, and battery backup mode. (Note: The OUTPUT voltage meter shows the status of the battery backup outlets.)

**3. ESTIMATED Run Time:** This displays the run time estimate of the UPS with current battery capacity and load.

**4. NORMAL Icon:** This icon appears when the UPS is working under normal conditions.

**5. BATTERY Icon:** During a severe brown-out or blackout, this icon appears and an alarm sounds (two short beeps followed by a pause) to indicate the UPS is operating from its internal batteries. During a prolonged brownout or blackout, the alarm will beep rapidly every 1/2 second (and

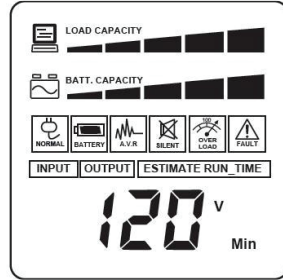

The LCD screen indicates a variety of UPS operational conditions. All descriptions apply when the UPS is plugged into an AC outlet and turned on or when the UPS is on battery.





the BATT.CAPACITY meter shows one 20% capacity segment shaded) to indicate the UPS's batteries are nearly out of power. You should save files and turn off your equipment immediately.

**6. AVR (Automatic Voltage Regulation) Icon:** This icon appears whenever your UPS is automatically correcting low AC line voltage without using battery power. This is a normal, automatic operation of your UPS, and no action is required on your part.

**7. SILENT MODE Icon:** This icon appears whenever the UPS is in silent mode. The buzzer does not beep during silent mode until the battery reaches low capacity.

**8. OVER LOAD Icon:** This icon appears and an alarm sounds to indicate the battery-supplied outlets are overloaded. To clear the

*-continued*

 NORMAL	 BATTERY	 OVER LOAD	 ALARM	CONDITION
On	Off	Off	Off	Normal
Off	On	Off	Beep twice every 30 seconds	<b>Utility Failure</b> - The UPS is providing power to battery power-supplied outlets from its battery.
Off	On	Off	Rapid beeping every 1/2 second	<b>Utility Failure</b> - The UPS is providing battery power. Rapid beeping indicates the unit will run out of power soon
Off	On	On	Constant tone	<b>Battery Overload</b> - Occurs when connected equipment exceeds the listed capacity of the UPS. Turn the UPS off, unplug at least one piece of equipment from battery outlets, wait 10 seconds, reset the circuit breaker and turn the unit on.

## DEFINITIONS FOR ILLUMINATED LCD INDICATORS - continued

overload, unplug some of your equipment from the battery-supplied outlets until the icon turns off and the alarm stops.

**9. FAULT icon:** This icon appears if there is a problem with the UPS, Contact CyberPower Systems at [tech@cyberpowersystems.com](mailto:tech@cyberpowersystems.com) for further help and support.

**10. BATT. CAPACITY meter:** This meter displays the approximate charge level (in 20%

increments) of the UPS's internal battery. During a blackout or severe brownout, the UPS switches to battery power, the BATTERY icon appears, and the charge level decreases.

**11. LOAD CAPACITY meter:** This meter displays the approximate output load level (in 20% increments) of the UPS battery outlets.

## TROUBLESHOOTING

Problem	Possible Cause	Solution
Full-time surge protection outlets stop providing power to equipment.	Circuit breaker has been tripped due to an overload.	Turn the UPS off and unplug at least one piece of equipment. Wait 10 seconds, reset the circuit breaker by depressing the button, and then turn the UPS on.
The UPS does not perform expected runtime.	Battery not fully charged.	Recharge the battery by leaving the UPS plugged in.
	Battery is worn out.	Contact CyberPower Systems about replacement batteries at: <a href="http://cyberpowersystems.com/support">cyberpowersystems.com/support</a> .
The UPS will not turn on.	The on/off switch is designed to prevent damage from rapidly turning it off and on.	Turn the UPS off. Wait 10 seconds and then turn the UPS on.
	The unit is not connected to an AC outlet.	The unit must be connected to a 110/120V 60Hz outlet.
	The battery is worn out.	Contact CyberPower Systems about replacement batteries at: <a href="http://cyberpowersystems.com/support">cyberpowersystems.com/support</a> .
	Mechanical problem.	Contact CyberPower Systems at: <a href="http://cyberpowersystems.com/support">cyberpowersystems.com/support</a> .
PowerPanel® Business Edition is inactive (all icons are gray).	The USB/Serial cable is not connected.	Connect the USB/serial cable to the UPS unit and an open USB/serial port on the back of the computer. You must use the cable that came with the unit.
	The USB/serial cable is connected to the wrong port.	Check the back of the computer for an additional USB/serial port. Move the cable to this port.
	The unit is not providing battery power.	Shutdown your computer and turn the UPS off. Wait 10 seconds and turn the UPS back on. This should reset the unit.
	The serial cable is not the cable that came with the unit.	Please use the serial cable that came with the unit for the software.



## TECHNICAL SPECIFICATIONS

Model	OR1500LCDRTL2U	OR2200LCDRTL2U
Capacity	1500VA / 1125W	2190VA / 1650W
Input Voltage or Utility	90V to 140V	
Input Frequency	47 Hz +/- 63 Hz (Auto-sensing)	
On-Battery Output Voltage	120Vac +/- 5%	
Transfer Time	4 ms Typical	
Max Load for UPS Outlets (8 Outlets)	1500VA / 1125W	2190VA / 1650W
On-Battery Output Wave Form	Simulated Sine Wave Form	
Operating Temperature	+ 32°F to 104° F / 0° C to 40° C	
Operating Relative Humidity	0 to 90% non-condensing	
Size (L x W x H)	433 x 478 x 88 mm (2U Rack) / 17 x 18.8 x 3.5 in.	
Net Weight	59.5 lbs. / 27 kg	66.1 lbs. / 30 kg
Battery Type	CyberPower / RBP834	CyberPower / RBP844
Typical Battery Recharge Time	8 hours	
Typical Battery Life	3 to 6 years, depending on number of discharge/recharge cycles	
Recommended Battery	Sealed Maintenance Free Lead Acid Battery	
Safety Approvals	UL1778, CSA C22.2 No 107.3, FCC/DoC Class B	

## SYSTEM FUNCTION BLOCK DIAGRAM

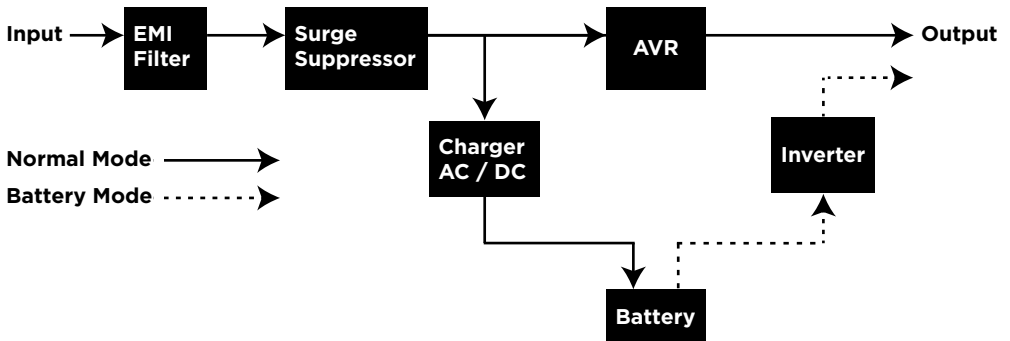

---

# CYBERPOWER GREENPOWER UPS™ TECHNOLOGY

## Advanced Energy-Saving Patented Bypass Technology

CyberPower's patented GreenPower UPS™ with Bypass Technology reduces UPS energy costs by up to 75% compared to conventional UPS models. Even when utility power is normal, conventional UPS models constantly pass power through a transformer. By contrast, under normal conditions the advanced circuitry of a GreenPower UPS™ bypasses the transformer. As a result, the power efficiency is significantly increased while decreasing waste heat, using less energy, and reducing energy costs. When an abnormal power condition occurs, the GreenPower UPS™ automatically runs power through its transformer to regulate voltage and provide "safe" power. Since utility power is normal over 88% of the time, the GreenPower UPS™ operates primarily in its efficient bypass mode. The GreenPower UPS™ is also manufactured in accordance with the Restriction on Hazardous Substances (RoHS) directive making it one of the most environmentally-friendly on the market today.



**GREENPOWER UPS™**  
Energy-Saving Technology

---

## FCC COMPLIANCE STATEMENT

This device complies with part 15 of the FCC rules. Operation is subject to the following two conditions: (1) this device may not cause harmful interference, and (2) this device must accept any interference received, including interference that may cause undesired operation.

Note: This equipment has been tested and found to comply with the limits for a Class B digital device, pursuant to part 15 of the FCC Rules. These limits are designed to provide reasonable protection against harmful interference in a residential installation. This equipment generates, uses, and can radiate radio frequency energy and, if not installed and used in accordance with the instructions, may cause harmful interference to radio communications. However, there is no guarantee that interference will not occur in a particular installation. If this equipment does cause harmful interference to radio or television reception, which can be determined by turning the equipment off and on, the user is encouraged to try to correct the interference by one or more of the following measures:

- Reorient or relocate the receiving antenna.
- Increase the separation between the equipment and receiver.
- Connect the equipment to an outlet on a circuit different from that to which the receiver is connected.
- Consult the dealer or an experienced radio/TV technician for help.

Warning: Changes or modifications not expressly approved by the party responsible for compliance could void the user's authority to operate the equipment.



### Canadian Compliance Statement

CAN ICES-3 (B)/NMB-3(B)

---

## LIMITED WARRANTY AND CONNECTED EQUIPMENT GUARANTEE

Please visit [www.CyberPowerSystems.com](http://www.CyberPowerSystems.com) for a copy of the Limited Warranty and Connected Equipment Guarantee.

### Where Can I Get More Information?

The application of the United Nations Convention of Contracts for the International Sale of Goods is expressly excluded. CyberPower is the warrantor under this Limited Warranty.

For further information please feel free to contact CyberPower at:

Cyber Power Systems (USA), Inc. 4241 12th Ave E., STE 400, Shakopee, MN 55379;

call us at **(877) 297-6937**; or submit a web ticket online at [cyberpowersystems.com/support](http://cyberpowersystems.com/support).

Cyber Power Systems (USA), Inc. encourages environmentally sound methods for disposal and recycling of its UPS products. Please dispose and/or recycle your UPS and batteries in accordance to the local regulations of your state.

**WARNING:** This product can expose you to chemicals including bisphenol A (BPA) and styrene, which is known to the State of California to cause reproductive harm and cancer. For more information, go to [www.P65Warnings.ca.gov](http://www.P65Warnings.ca.gov).