

**PowerScan™ PBT7100 Cordless
Industrial Handheld Linear Imaging Bar Code Reader
with Bluetooth® Wireless Technology**



Product Reference Guide

Datalogic Scanning, Inc.

959 Terry Street

Eugene, Oregon 97402

Telephone: (541) 683-5700

Fax: (541) 345-7140

An Unpublished Work - All rights reserved. No part of the contents of this documentation or the procedures described therein may be reproduced or transmitted in any form or by any means without prior written permission of Datalogic Scanning, Inc. or its subsidiaries or affiliates ("Datalogic" or "Datalogic Scanning"). Owners of Datalogic products are hereby granted a non-exclusive, revocable license to reproduce and transmit this documentation for the purchaser's own internal business purposes. Purchaser shall not remove or alter any proprietary notices, including copyright notices, contained in this documentation and shall ensure that all notices appear on any reproductions of the documentation.

Should future revisions of this manual be published, you can acquire printed versions by contacting your Datalogic representative. Electronic versions may either be downloadable from the Datalogic website (www.scanning.datalogic.com) or provided on appropriate media. If you visit our website and would like to make comments or suggestions about this or other Datalogic publications, please let us know via the "Contact Datalogic" page.

Disclaimer

Datalogic has taken reasonable measures to provide information in this manual that is complete and accurate, however, Datalogic reserves the right to change any specification at any time without prior notice.

Datalogic and the Datalogic logo are registered trademarks of Datalogic S.p.A. in many countries, including the U.S.A. and the E.U. All other brand and product names may be trademarks of their respective owners.

PowerScan is a registered trademark of Datalogic Scanning, Inc. in many countries, including the U.S.A. and the E.U.

This product may be covered by one or more of the following patents: 4603262 • 4639606 • 4652750 • 4672215 • 4699447 • 4709369 • 4749879 • 4786798 • 4792666 • 4794240 • 4798943 • 4799164 • 4820911 • 4845349 • 4861972 • 4861973 • 4866257 • 4868836 • 4879456 • 4939355 • 4939356 • 4943127 • 4963719 • 4971176 • 4971177 • 4991692 • 5001406 • 5015831 • 5019697 • 5019698 • 5086879 • 5115120 • 5144118 • 5146463 • 5179270 • 5198649 • 5200597 • 5202784 • 5208449 • 5210397 • 5212371 • 5212372 • 5214270 • 5229590 • 5231293 • 5232185 • 5233169 • 5235168 • 5237161 • 5237162 • 5239165 • 5247161 • 5256864 • 5258604 • 5258699 • 5260554 • 5274219 • 5296689 • 5298728 • 5311000 • 5327451 • 5329103 • 5330370 • 5347113 • 5347121 • 5371361 • 5382783 • 5386105 • 5389917 • 5410108 • 5420410 • 5422472 • 5426507 • 5438187 • 5440110 • 5440111 • 5446271 • 5446749 • 5448050 • 5463211 • 5475206 • 5475207 • 5479011 • 5481098 • 5491328 • 5493108 • 5504350 • 5508505 • 5512740 • 5541397 • 5552593 • 5557095 • 5563402 • 5565668 • 5576531 • 5581707 • 5594231 • 5594441 • 5598070 • 5602376 • 5608201 • 5608399 • 5612529 • 5629510 • 5635699 • 5641958 • 5646391 • 5661435 • 5664231 • 5666045 • 5671374 • 5675138 • 5682028 • 5686716 • 5696370 • 5703347 • 5705802 • 5714750 • 5717194 • 5723852 • 5750976 • 5767502 • 5770847 • 5786581 • 5786585 • 5787103 • 5789732 • 5796222 • 5804809 • 5814803 • 5814804 • 5821721 • 5822343 • 5825009 • 5834708 • 5834750 • 5837983 • 5837988 • 5852286 • 5864129 • 5869827 • 5874722 • 5883370 • 5905249 • 5907147 • 5923023 • 5925868 • 5929421 • 5945670 • 5959284 • 5962838 • 5979769 • 6000619 • 6006991 • 6012639 • 6016135 • 6024284 • 6041374 • 6042012 • 6045044 • 6047889 • 6047894 • 6056198 • 6065676 • 6069696 • 6073849 • 6073851 • 6094288 • 6112993 • 6129279 • 6129282 • 6134039 • 6142376 • 6152368 • 6152372 • 6155488 • 6166375 • 6169614 • 6173894 • 6176429 • 6188500 • 6189784 • 6213397 • 6223986 • 6230975 • 6230976 • 6244510 • 6259545 • 6260763 • 6266175 • 6273336 • 6276605 • 6279829 • 6290134 • 6290135 • 6293467 • 6303927 • 6311895 • 6318634 • 6328216 • 6332576 • 6332577 • 6343741 • 6454168 • 6478224 • 6568598 • 6578765 • 6705527 • 6857567 • 6974084 • 6991169 • 7051940 • 7170414 • 7172123 • 7201322 • 7204422 • 7215493 • 7224540 • 7234641 • 7243850 • 7374092 • 7407096 • 601 26 118.6 • AU703547 • D312631 • D313590 • D320011 • D320012 • D323492 • D330707 • D330708 • D349109 • D350127 • D350735 • D351149 • D351150 • D352936 • D352937 • D352938 • D352939 • D358588 • D361565 • D372234 • D374630 • D374869 • D375493 • D376357 • D377345 • D377346 • D377347 • D377348 • D388075 • D446524 • EP0256296 • EP0260155 • EP0260156 • EP0295936 • EP0325469 • EP0349770 • EP0368254 • EP0442215 • EP0498366 • EP0531645 • EP0663643 • EP0698251 • EP01330772 • GB2252333 • GB2284086 • GB2301691 • GB2304954 • GB2307093 • GB2308267 • GB2308678 • GB2319103 • GB2333163 • GB2343079 • GB2344486 • GB2345568 • GB2354340 • ISR107546 • ISR118507 • ISR118508 • JP1962823 • JP1971216 • JP2513442 • JP2732459 • JP2829331 • JP2953593 • JP2964278 • MEX185552 • MEX187245 • RE37166 • RE40.071 • Other Patents Pending

Table of Contents

Chapter 1. Introduction	1
About this Guide	1
Manual Overview	1
Manual Conventions	2
References	2
Technical Support	3
Datalogic Website Support	3
Reseller Technical Support	3
Telephone Technical Support	3
Chapter 2. Getting Started	5
About the Reader	5
Unpacking	5
Setting Up the Reader and Base Station	6
Install the Battery in the Reader	6
Connect the Base Station	6
Linking the Reader to a Base Station	7
Optional: Linking the Reader to a PC in Server Mode	8
Optional: Linking the Reader to a PC in Client Mode	9
Paging Feature	9
Programming	9
Using the Programming Barcodes	9
Select the Interface Type	10
Configure Interface Settings	10
Configure Other Features	10
Software Version Transmission	10
Resetting the Product Configuration to Defaults	11
Chapter 3. Interfaces	13
Interface Selection	13
Configuring the Interface	13
Global Interface Features	17
Host Commands — Obey/Ignore	17
USB Suspend Mode	18
Chapter 4. General Features	19
Double Read Timeout	19
Label Gone Timeout	21
Sleep Mode Timeout	23
LED and Beeper Indicators	25
Power On Alert	25
Good Read: When to Indicate	26
Good Read Beep Type	27
Good Read Beep Frequency	28
Good Read Beep Length	28
Good Read Beep Volume	30
Good Read LED Duration	31
Scanning Features	33
Scan Mode	33
Stand Mode Triggered Timeout	35
Scanning Active Time	37

Flash On Time	39
Flash Off Time	41
Stand Mode Sensitivity	43
Laser Pointer Control	44
Laser Pointer Period	45
Green Spot Duration	46
Chapter 5. RS-232 ONLY Interface.....	47
Introduction	47
RS-232 Standard Factory Settings	47
Baud Rate	47
Data Bits	49
Stop Bits	50
Parity	51
Handshaking Control	52
Chapter 6. RS-232/USB-Com Interfaces	53
Introduction	53
Standard Factory Settings	53
Intercharacter Delay	54
Beep On ASCII BEL	56
Beep On Not on File	56
ACK NAK Options	57
ACK Character	58
NAK Character	60
ACK NAK Timeout Value	62
ACK NAK Retry Count	64
ACK NAK Error Handling	66
Indicate Transmission Failure	67
Disable Character	68
Enable Character	70
Chapter 7. Keyboard Interface.....	73
Introduction	73
Standard Factory Settings	73
Scancode Tables	73
Country Mode	74
Caps Lock State	77
Numlock	77
Send Control Characters	78
Wedge Quiet Interval	79
Intercharacter Delay	81
Intercode Delay	83
USB Keyboard Speed	85
Chapter 8. USB-OEM Interface	87
Introduction	87
Standard Factory Settings	87
USB-OEM Device Usage	88
USB-OEM Interface Options	89
Chapter 9. IBM 46XX Interface.....	91
Introduction	91
IBM Standard Factory Settings	91
46xx Number of Host Resets	92
Transmit Labels in Code 39 Format	95
IBM 46XX Interface Options	96

Chapter 10. Wand Emulation Interface	97
Introduction	97
Wand Emulation Standard Factory Settings	97
Wand Idle State	97
Wand Polarity	98
Wand Signal Speed	99
Label Symbology Conversion	100
Transmit Noise	101
Chapter 11. Data Editing.....	103
Data Editing Overview	103
Please Keep In Mind... ..	104
Global Prefix/Suffix	104
Example: Setting a Prefix	104
Global AIM ID	106
GS1-128 AIM ID	108
Label ID	109
Label ID: Pre-loaded Sets	109
Label ID: Set Individually Per Symbology	112
Label ID Control	114
Label ID Symbology Selection	115
Case Conversion	123
Character Conversion	124
Chapter 12. Symbologies.....	127
Introduction	127
Symbologies	127
Standard Factory Settings for Symbologies	128
Disable All Symbologies	128
Coupon Control	129
UPC-A	130
UPC-A Enable/Disable	130
UPC-A Check Character Transmission	130
Expand UPC-A to EAN-13	131
UPC-A Number System Character Transmission	131
In-Store Minimum Reads	132
UPC-E	133
UPC-E Enable/Disable	133
UPC-E Check Character Transmission	133
Expand UPC-E to EAN-13	134
Expand UPC-E to UPC-A	134
UPC-E Number System Character Transmission	135
UPC-E Minimum Reads	136
GTIN Formatting	137
EAN 13	138
EAN 13 Enable/Disable	138
EAN 13 Check Character Transmission	138
EAN-13 Flag 1 Character	139
EAN-13 ISBN Conversion	140
ISSN Enable/Disable	140
EAN 13 Minimum Reads	141
EAN 8	142
EAN 8 Enable/Disable	142
EAN 8 Check Character Transmission	142
Expand EAN 8 to EAN 13	143
EAN 8 Minimum Reads	144
UPC/EAN Global Settings	145
UPC/EAN Decoding Level	145
UPC/EAN Correlation	147

UPC/EAN Reconstruction	147
UPC/EAN Price Weight Check	148
UPC-A Minimum Reads	149
Add-Ons	150
Optional Add-ons	150
Optional Add-On Timer	152
Optional GS1-128 Add-On Timer	155
P2 Add-Ons Minimum Reads	158
P5 Add-Ons Minimum Reads	159
GS1-128 Add-Ons Minimum Reads	160
GS1 DataBar™ Omnidirectional	161
GS1 DataBar Omnidirectional Enable/Disable	161
GS1 DataBar Omnidirectional GS1-128 Emulation	161
GS1 DataBar Omnidirectional Minimum Reads	162
GS1 DataBar™ Expanded	163
GS1 DataBar Expanded Enable/Disable	163
GS1 DataBar Expanded GS1-128 Emulation	163
GS1 DataBar Expanded Minimum Reads	164
GS1 DataBar Expanded Length Control	165
GS1 DataBar Expanded Set Length 1	166
GS1 DataBar Expanded Set Length 2	168
GS1 DataBar™ Limited	170
GS1 DataBar Limited Enable/Disable	170
GS1 DataBar Limited GS1-128 Emulation	170
GS1 DataBar Limited Minimum Reads	171
Code 39	172
Code 39 Enable/Disable	172
Code 39 Check Character Calculation	173
Code 39 Check Character Transmission	174
Code 39 Start/Stop Character Transmission	174
Code 39 Full ASCII	175
Code 39 Quiet Zones	176
Code 39 Minimum Reads	177
Code 39 Decoding Level	178
Code 39 Length Control	180
Code 39 Set Length 1	181
Code 39 Set Length 2	183
Code 39 Interdigit Ratio	185
Code 39 Character Correlation	187
Code 39 Stitching	188
Code 32 (Italian Pharmaceutical)	189
Code 32 Enable/Disable	189
Code 32 Feature Setting Exceptions	189
Code 32 Check Character Transmission	190
Code 32 Start/Stop Character Transmission	190
Code 39 CIP (French Pharmaceutical)	191
Code 39 CIP Enable/Disable	191
Code 128	191
Code 128 Enable/Disable	191
Expand Code 128 to Code 39	192
Code 128 Check Character Transmission	192
Code 128 Function Character Transmission	193
Code 128 Sub-Code Change Transmission	194
Code 128 Quiet Zones	195
Code 128 Minimum Reads	196
Code 128 Decoding Level	197
Code 128 Length Control	199
Code 128 Set Length 1	200
Code 128 Set Length 2	202
Code 128 Character Correlation	204

Code 128 Stitching	205
GS1-128	206
GS1-128 Enable	206
Interleaved 2 of 5 (I 2 of 5)	207
I 2 of 5 Enable/Disable	207
I 2 of 5 Check Character Calculation	208
I 2 of 5 Check Character Transmission	209
I 2 of 5 Minimum Reads	210
I 2 of 5 Decoding Level	211
I 2 of 5 Length Control	213
I 2 of 5 Set Length 1	214
I 2 of 5 Set Length 2	216
I 2 of 5 Character Correlation	218
I 2 of 5 Stitching	219
Interleaved 2 of 5 CIP HR	220
Interleaved 2 of 5 CIP HR Enable/Disable	220
Datalogic 2 of 5	220
Datalogic 2 of 5 Enable/Disable	220
Datalogic 2 of 5 Check Character Calculation	221
Datalogic 2 of 5 Minimum Reads	222
Datalogic 2 of 5 Decoding Level	222
Datalogic 2 of 5 Length Control	223
Datalogic 2 of 5 Set Length 1	224
Datalogic 2 of 5 Set Length 2	226
Datalogic 2 of 5 Interdigit Maximum Ratio	228
Datalogic 2 of 5 Character Correlation	230
Datalogic 2 of 5 Stitching	231
Codabar	232
Codabar Enable/Disable	232
Codabar Check Character Calculation	233
Codabar Check Character Transmission	234
Codabar Start/Stop Character Transmission	234
Codabar Start/Stop Character Set	235
Codabar Start/Stop Character Match	236
Codabar Quiet Zones	237
Codabar Minimum Reads	238
Codabar Decoding Level	239
Codabar Length Control	241
Codabar Set Length 1	242
Codabar Set Length 2	244
Codabar Interdigit Ratio	246
Codabar Character Correlation	248
Codabar Stitching	249
ABC Codabar	250
ABC Codabar Enable/Disable	250
ABC Codabar Concatenation Mode	250
ABC Codabar Dynamic Concatenation Timeout	251
ABC Codabar Force Concatenation	252
Code 11	253
Code 11 Enable/Disable	253
Code 11 Check Character Calculation	254
Code 11 Check Character Transmission	255
Code 11 Minimum Reads	256
Code 11 Length Control	257
Code 11 Set Length 1	258
Code 11 Set Length 2	260
Code 11 Interdigit Ratio	262
Code 11 Decoding Level	264
Code 11 Character Correlation	266
Code 11 Stitching	267

Standard 2 of 5	268
Standard 2 of 5 Enable/Disable	268
Standard 2 of 5 Check Character Calculation	269
Standard 2 of 5 Check Character Transmission	269
Standard 2 of 5 Minimum Reads	270
Standard 2 of 5 Decoding Level	270
Standard 2 of 5 Length Control	271
Standard 2 of 5 Set Length 1	272
Standard 2 of 5 Set Length 2	274
Standard 2 of 5 Character Correlation	276
Standard 2 of 5 Stitching	277
Industrial 2 of 5	278
Industrial 2 of 5 Enable/Disable	278
Industrial 2 of 5 Check Character Calculation	278
Industrial 2 of 5 Check Character Transmission	279
Industrial 2 of 5 Length Control	280
Industrial 2 of 5 Set Length 1	281
Industrial 2 of 5 Set Length 2	283
Industrial 2 of 5 Minimum Reads	285
Industrial 2 of 5 Stitching	286
Industrial 2 of 5 Character Correlation	286
IATA	287
IATA Enable/Disable	287
IATA Check Character Transmission	287
ISBT 128	288
ISBT 128 Concatenation	288
ISBT 128 Concatenation Mode	289
ISBT 128 Dynamic Concatenation Timeout	290
ISBT 128 Force Concatenation	291
ISBT 128 Advanced Concatenation Options	291
MSI	292
MSI Enable/Disable	292
MSI Check Character Calculation	293
MSI Check Character Transmission	294
MSI Length Control	294
MSI Set Length 1	295
MSI Set Length 2	297
MSI Minimum Reads	299
MSI Decoding Level	300
Plessey	302
Plessey Enable/Disable	302
Plessey Check Character Calculation	303
Plessey Check Character Transmission	304
Plessey Length Control	304
Plessey Set Length 1	305
Plessey Set Length 2	307
Plessey Minimum Reads	309
Plessey Decoding Level	310
Plessey Stitching	311
Plessey Character Correlation	312
Code 93	312
Code 93 Enable/Disable	312
Code 93 Check Character Calculation	313
Code 93 Check Character Transmission	314
Code 93 Length Control	314
Code 93 Set Length 1	315
Code 93 Set Length 2	317
Code 93 Minimum Reads	319
Code 93 Decoding Level	320
Code 93 Quiet Zones	322

Code 93 Stitching	323
Code 93 Character Correlation	323
Codablock F	324
Codablock F Enable/Disable	324
Codablock F EAN Enable/Disable	325
Codablock F AIM Check	325
Codablock F Length Control	326
Codablock F Set Length 1	327
Codablock F Set Length 2	329
Code 4	331
Code 4 Enable/Disable	331
Code 4 Check Character Transmission	332
Code 4 Hex to Decimal Conversion	332
Code 5	333
Code 5 Enable/Disable	333
Code 5 Check Character Transmission	334
Code 5 Hex to Decimal Conversion	334
Code 4 and Code 5 Common Configuration Items	335
Code 4 and 5 Decoding Level	335
Code 4 and Code 5 Minimum Reads	337
Follett 2 of 5	338
Follett 2 of 5 Enable/Disable	338
Chapter 13. BT Features.....	339
Introduction	339
Standard Factory Settings	339
BT Beeper Features	340
ACK Beep	340
Beep Frequency	341
Beep Duration	342
Beep Volume	344
BT Base Station Beep	345
Disconnect Beep	345
BT Leash Alarm	346
Flash Update	348
BT Automatic Flash Update	348
Request Flash Update	348
Configuration Update	349
Automatic Configuration Update	349
Configuration Update From Base Station to Handheld	349
Copy Configuration From Handheld to Base Station	350
Battery Charge Mode	351
Powerdown Timeout	352
BT Poll Rate	354
Batch Features	356
Batch Mode	356
Send Batch	357
Erase Batch Memory	357
BT Batch Mode Transmit Delay	358
BT Security Features	359
BT Pin Code	359
BT Security Mode	362
Linking the Reader	363
Optional: Linking a PowerScan 7000 Reader to a PBT7100 Base Station	363
BT Address Stamping	364
Source Radio Address Transmission	364
Source Radio Address Delimiter Character	365
Appendix A. Technical Specifications	367

Standard Cable Pinouts	370
Appendix B. Standard Defaults	371
Appendix C. LED and Beeper Indications	385
General Functions — LED and Beeper Indications	386
BT Beeper Indications	387
BT LED Indications	388
Error Codes	389
Appendix D. Sample Barcodes	391
UPC-A	391
Interleaved 2 of 5	391
Codabar	392
Code 11	392
DataBar (RSS)	393
DataBar-14	393
Appendix E. Keypad	395
Appendix F. Scancode Tables	399
Control Character Emulation	399
Single Press and Release Keys	399
Interface Type PC AT PS/2 or USB-Keyboard	400
Interface type PC AT PS/2 Alt Mode or USB-Keyboard Alt Mode	402
Digital Interface	404
IBM31xx 102-key	406
IBM XT	408
Microsoft Windows Codepage 1252	410
Index	411

Chapter 1

Introduction

About this Guide

This Product Reference Guide (PRG) is provided for users seeking advanced technical information, including connection, programming, maintenance and specifications. The Quick Reference Guide (QRG) and other publications associated with this product are downloadable free of charge from the website listed on the back cover of this manual.

Typically, units are factory-programmed for the most common terminal and communications settings. If you need to modify any programmable settings, custom configuration can be accomplished by scanning the programming barcodes within this guide.

Programming can alternatively be performed using the Datalogic Aladdin™ Configuration application which is downloadable from the Datalogic website listed on the back cover of this manual. This multi-platform utility program allows device configuration using a PC. It communicates to the device using a serial or USB cable and can also create configuration barcodes to print.

Manual Overview

[Chapter 1, Introduction](#) provides a product overview, unpacking instructions, and cable connection information.

[Chapter 2, Getting Started](#) presents information about unpacking and setting up the reader.

[Chapter 3, Interfaces](#) consists of interface configuration barcodes and details.

[Chapter 4, General Features](#) includes programming barcodes for selecting common features for the reader and general use barcodes to customize how the data is transmitted to the host device.

[Chapter 5, RS-232 ONLY Interface](#) supplies information about setting up the reader for RS-232 operation.

[Chapter 6, RS-232/USB-Com Interfaces](#) features information about options involving both the RS-232 and USB-Com interfaces.

[Chapter 7, Keyboard Interface](#) discusses how to set up the reader for Keyboard Wedge operation.

[Chapter 8, USB-OEM Interface](#) explains how to set the reader up for USB operation.

[Chapter 9, IBM 46XX Interface](#) is a resource for setting up an IBM interface.

[Chapter 11, Data Editing](#) offers advanced configuration options for customization of scanned data output.

[Chapter 12, Symbologies](#) defines options for all symbologies and provides the programming barcodes necessary for configuring these features.

[Appendix A, Technical Specifications](#) lists physical and performance characteristics, as well as environmental and regulatory specifications. It also provides standard cable pin-outs.

[Appendix B, Standard Defaults](#) references common factory default settings for reader features and options.

[Appendix C, LED and Beeper Indications](#) supplies tables containing descriptions of the functions and behaviors of the reader's LED and Beeper indicators.

[Appendix D, Sample Barcodes](#) offers sample barcodes of several common symbologies.

[Appendix E, Keypad](#) includes numeric barcodes to be scanned for certain parameter settings.

[Appendix F, Scancode Tables](#) lists control character emulation information for Wedge and USB Keyboard interfaces.

Manual Conventions

The following conventions are used in this document:

The symbols listed below are used in this manual to notify the reader of key issues or procedures that must be observed when using the reader:



NOTE

Notes contain information necessary for properly diagnosing, repairing and operating the reader.



CAUTION

The CAUTION symbol advises you of actions that could damage equipment or property.

References

Current versions of the Product Reference Guide (PRG), Quick Reference Guide (QRG), the Datalogic Aladdin™ Configuration application, and any other manuals, instruction sheets and utilities for this product can be downloaded from the website listed on the back cover of this manual. Alternatively, printed copies or product support CDs can be purchased through your Datalogic reseller.

Technical Support

Datalogic Website Support

The Datalogic website (www.scanning.datalogic.com) is the complete source for technical support and information for Datalogic products. The site offers product support, product registration, warranty information, product manuals, product tech notes, software updates, demos, and instructions for returning products for repair.

Reseller Technical Support

An excellent source for technical assistance and information is an authorized Datalogic reseller. A reseller is acquainted with specific types of businesses, application software, and computer systems and can provide individualized assistance.

Telephone Technical Support

If you do not have internet or email access, you may contact Datalogic technical support at (541) 349-8283 or check the back cover of your manual for more contact information.

NOTES

Chapter 2

Getting Started

About the Reader

Advancements in the LED technology used in this reader significantly improve the illumination of the target field of view, resulting in higher scan efficiency. Whether used in Single Trigger or Continuous Mode, the ergonomic design of the reader will help to promote comfortable handling during extended periods of use.

The reader/Base Station can communicate using the following interfaces:

RS-232 — The reader can communicate with a standard or Wincor-Nixdorf (W-N) RS-232 host.

RS-232 OPOS — This interface is used for OPOS/UPOS/JavaPOS systems.

Keyboard Wedge (KBW) — When connected using this interface, the host interprets scanned data as keystrokes and supports several international keyboards (for the Windows® environment). See [Country Mode on page 74](#) for a full listing.

USB — Select to communicate either by USB OEM, USB COM, USB Keyboard interface or USB POS types by scanning the appropriate interface type barcodes available in this manual. The default interface is USB-KBD for Wedge models (7230) and USB-OEM for IBM models (7210).

IBM — IBM Port 5B or Port 9B are selectable interface options.

Wand Emulation — This interface produces an electrical signal that represents the bars and spaces of a label.

Unpacking

Check carefully to ensure the reader, Base Station and any accessories ordered are present and undamaged. If any damage occurred during shipment, contact [Technical Support on page 3](#).

KEEP THE PACKAGING. Should the unit ever require service, it should be returned in its original shipping container.

Setting Up the Reader and Base Station

Follow the steps provided in this section to connect and get your reader up and communicating with its host:

1. [Install the Battery in the Reader](#)
2. [Connect the Base Station](#)
3. [Select the Interface Type](#)
4. [Configure Interface Settings](#) (only if not using factory settings for that interface)
5. [Configure Other Features](#) (if modifications are needed from factory settings)

Install the Battery in the Reader

Follow the instructions in the Quick Reference Guide (QRG) to install the battery pack and verify reader operation.

Connect the Base Station

[Figure 1](#) shows how to connect the Base Station to a terminal, PC or other host device. Turn off the host before connection and consult the manual for that equipment (if necessary) before proceeding. Connect the interface cable before applying power to the Base Station.

Base Station Connection and Routing — Fully insert the Power Cable and Interface (I/F) Cable connectors into their respective ports in the underside of the Base Station (see [Figure 1](#)), then plug the Base Station AC Adapter into the AC outlet. Alternatively, you can either loop the cables around the routing clips and back through the routing channel to the front of the Base Station as shown, or the cables can be fed directly out the back of the Base Station via the routing clips.

Figure 1. Connecting the Base Station

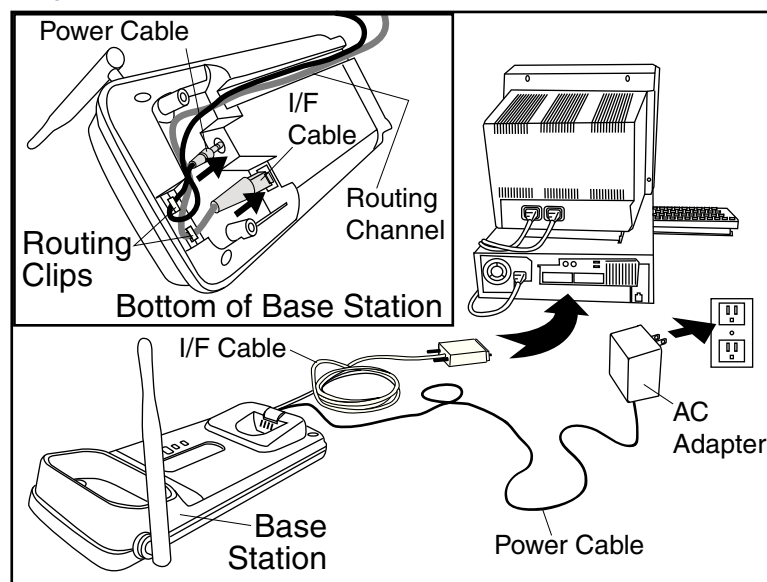

Host Connection — The interface type was specified at the time your reader was ordered, however you should verify before connection that the reader's cable type is compatible with your host equipment. Most connections plug directly into the host device as shown in [Figure 2](#). Keyboard Wedge interface cables have a 'Y' connection where its female end mates with the male end of the cable from the keyboard and the remaining end at the keyboard port on the terminal/PC.

Figure 2. Connecting to the Host

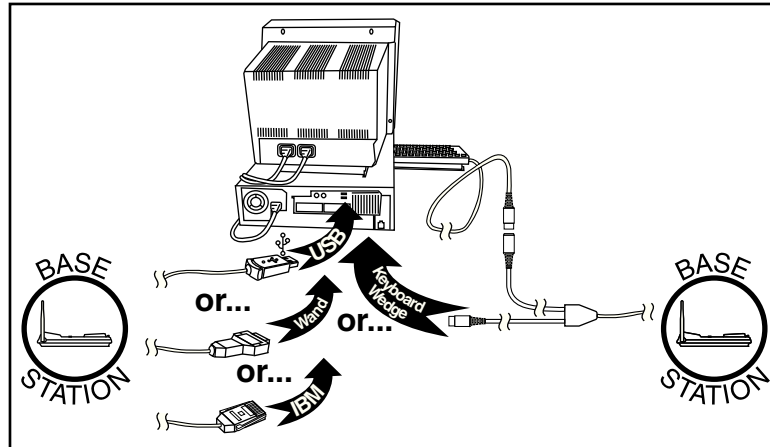

Power Connection — Plug the AC Adapter in to an approved AC wall socket with the cable facing downwards (as shown in [Figure 1](#)) to prevent undue strain on the socket.

Linking the Reader to a Base Station

To link a reader to a Base Station, press the Link Button (see [Figure 3](#)) on the Base Station for at least one second to place the base in "Link Mode," then scan the barcode below or the Link barcode located on the Base Station using the reader to be linked. The Link barcode on the Base Station contains an identifier that is unique to that Base Station. This enables the reader to quickly find and link to that Base Station.

A successful link is indicated by three ascending tones from the reader. A high-low-high-low tone indicates the link attempt was unsuccessful. A single green LED flash during this tone indicates no Base Station was discovered. Two green LED flashes during this tone indicates that more than one Base Station was discovered and the reader did not link. Three LED flashes during this tone indicate a security error.

Figure 3. Labeling and Nomenclature

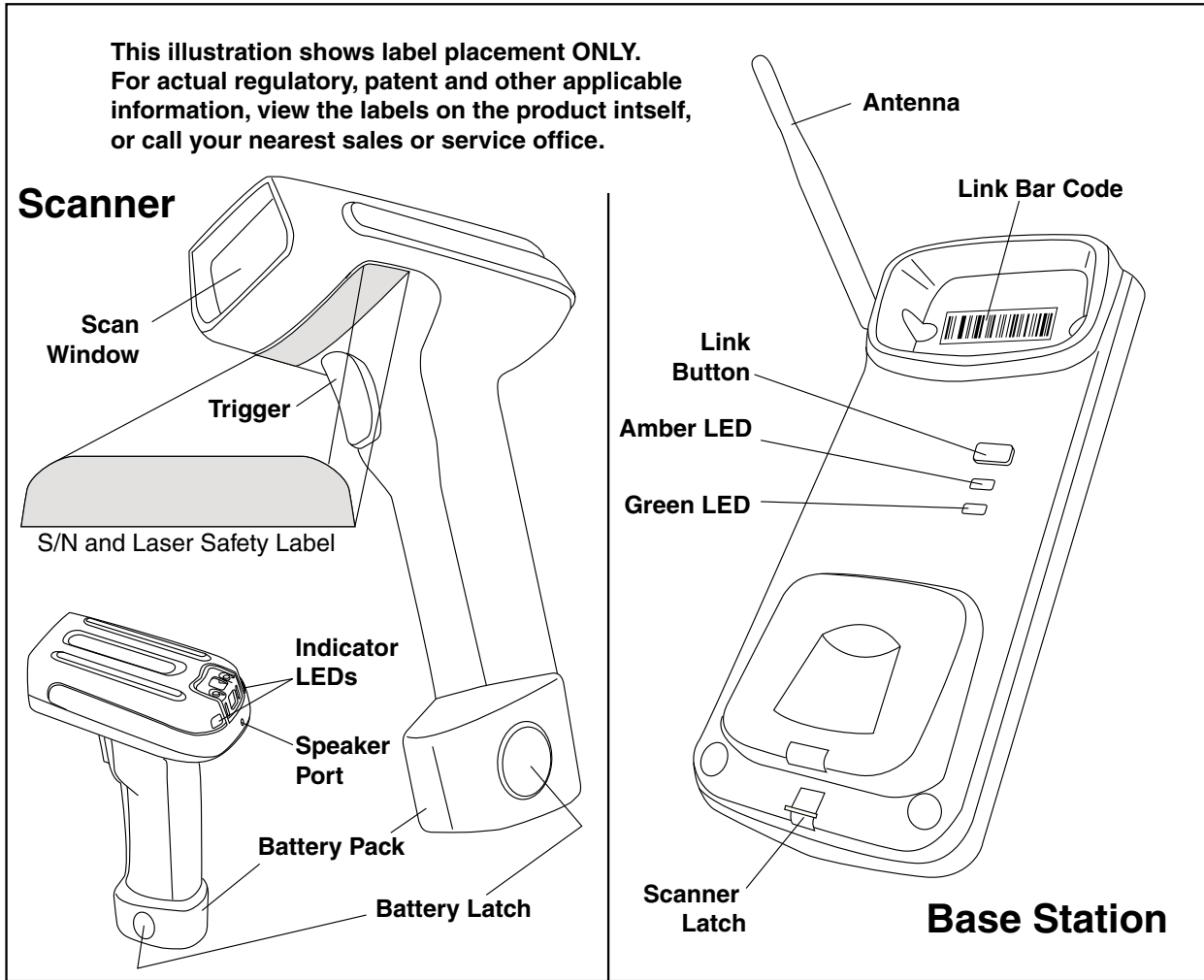

Optional: Linking the Reader to a PC in Server Mode

A reader can optionally be linked in server mode to a Bluetooth-enabled PC with the serial port profile.

To do this, follow these steps:

1. Ensure the PC or terminal can network with Bluetooth devices and that it is powered on.
2. Scan the “Link to a PC” barcode below.

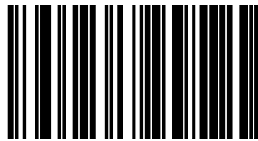

Link to a PC in Server Mode

3. On the PC, scan for network devices.
4. Select the “Datalogic PBT7100 Reader.” Make sure “Secure Connection” is disabled.
5. Select “connect” on the PC to link the reader to the PC.

Optional: Linking the Reader to a PC in Client Mode

A reader can optionally be linked in client mode to a Bluetooth-enabled PC with the serial port profile.

To do this, follow these steps:

1. Ensure the PC or terminal can network with Bluetooth devices and that it is powered on.
2. Ensure that a COM port is assigned under Services within the bluetooth setup menu.
3. Create a Link label that contains the address of the PC bluetooth adapter.



The bluetooth address can be found under "Properties" within in the bluetooth setup menu.

NOTE

The link label is a Code 128 function 3 label with the following format:
<FN3 char>LnkB<12 character bluetooth address>

4. Scan the link label created in step 3.

Paging Feature

To help locate a missing reader, press the Base Station Link Button momentarily (less than one second). This will cause the reader to beep five times at its loudest volume setting.

Programming

The reader is typically factory-configured with a set of default features. After scanning the interface barcode from the [Interfaces](#) section, you can select other options and customize your reader through use of the instructions and programming barcodes available in the corresponding features section for your interface and also the [Data Editing](#) and [Symbologies](#) chapters of this manual.

Using the Programming Barcodes

This manual contains feature descriptions and barcodes which allow you to reconfigure your reader and Base Station. Some programming barcode labels, like the [Resetting the Product Configuration to Defaults on page 11](#), require only the scan of that single label to enact the change. Most of the programming labels in this manual, however, require the reader to be placed in Programming Mode prior to scanning them. Scan an ENTER/EXIT barcode once to enter Programming Mode. Once the reader is in Programming Mode, you can scan a number of parameter settings before scanning the ENTER/EXIT barcode a second time, which will then accept your changes, exit Programming Mode and return the reader to normal operation.



There are some exceptions to the typical programming sequence described above. Please read the description and setting instructions carefully when configuring each given programmable feature.

NOTE

Select the Interface Type

Upon completing the physical connection between the Base Station and the host, proceed directly to [Interfaces on page 13](#) for information and programming for the interface type the Base Station is connected to (for example: RS-232, Keyboard Wedge, USB, etc.) and scan the appropriate barcode in that section to select your system's correct interface type.

Configure Interface Settings

Each interface type is associated to a specific set of default features. If after scanning the interface barcode from the [Interfaces](#) section, your installation requires you to select options to further customize your reader, turn to the appropriate section for your interface type as listed below:

- [RS-232 ONLY Interface, starting on page 47](#)
- [RS-232/USB-Com Interfaces, starting on page 53](#)
- [Keyboard Interface, starting on page 73](#)
- [USB-OEM Interface, starting on page 87](#)
- [IBM 46XX Interface, starting on page 91](#)
- [Wand Emulation Interface, starting on page 97](#)

Configure Other Features

If your installation requires different programming than the standard factory default settings, the following sections of this manual allow configuration of non-interface-specific settings you might require:

[General Features](#) — General Features includes programming for scanning, beeper and LED indicators and other such universal settings.

[Symbologies](#) — Includes options concerning the barcode label types (symbologies). These settings allow you to enable/disable symbologies, set label lengths, require check digit, etc.

Software Version Transmission

The software version of the device can be transmitted over the RS-232 and Keyboard interfaces by scanning the following label.



Transmit Software Version

Resetting the Product Configuration to Defaults

If you aren't sure what programming options are in your imager, or you've changed some options and want to restore the Custom Default Configuration that may have been saved in the imager, scan the [Restore Custom Default Configuration](#) barcode below. This will restore the custom configuration for the currently active interface.



NOTE

Custom defaults are based on the interface type. Configure the imager for the correct interface before scanning this label.

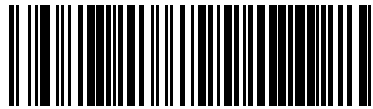

Restore Custom Default Configuration

If you aren't sure what programming options are in your imager, or you've changed some options and want to restore the Factory Configuration, you have two options. You can scan the [Restore USA Factory Configuration](#) bar code or the [Restore EU Factory Configuration](#) bar code below. Both labels restore the imager configuration to the factory settings including the interface type. The USA label restores Label IDs to those historically used in the USA. The EU label restores Label IDs to those historically used in Europe. The Label ID sets for USA and EU are shown in the Label ID section of this manual.



Restore USA Factory Configuration

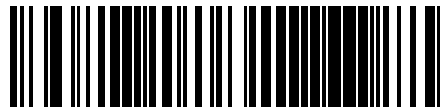

Restore EU Factory Configuration

The programming section lists the factory default settings for each of the menu commands (indicated by shaded blocks and bold text) on the following pages.

NOTES

Chapter 3

Interfaces

Interface Selection

Each reader model will support one of the following sets of host interfaces:

General Purpose Models (5 volt supply)

RS-232
RS-232 OPOS
USB
Keyboard Wedge
Wand Emulation

Retail Point of Sale Models (4 to 14 volt supply)

RS-232
RS-232 OPOS
USB
IBM 46XX

Configuring the Interface

Scan the programming barcode from this section which selects the appropriate interface type matching the system the reader will be connected to. Next, proceed to the corresponding chapter in this manual (also listed in [Table 1](#)) to configure any desired settings and features associated with that interface.



NOTE

Unlike some other programming features and options, interface selections require that you scan only one programming barcode label. **DO NOT** scan an ENTER/EXIT barcode prior to scanning an interface selection barcode.

Some interfaces require the scanner to start in the disabled state when powered up. If additional scanner configuration is desired while in this state, pull the trigger and hold it for five seconds. The scanner will change to a state that allows programming with barcodes.

Table 1. Available Interfaces

RS-232		FEATURES
RS-232 standard interface	 Select RS232-STD	Set RS-232 Interface Features starting on page 47
 Select RS232-WN	RS-232 Wincor-Nixdorf	
RS-232 for use with OPOS/UPOS/JavaPOS	 Select RS-232 OPOS	
 Select USB-COM-STD ^a	USB Com to simulate RS-232 standard interface	
IBM		FEATURES
 Select IBM-P5B	IBM-46xx Port 5B reader interface	Set IBM Interface Features starting on page 91
IBM-46xx Port 9B reader interface	 Select IBM-P9B	
USB-OEM		FEATURES
 Select USB-OEM	USB-OEM (can be used for OPOS/UPOS/JavaPOS)	Set USB-OEM Interface Features starting on page 87

^a. Download the correct USB Com driver from www.datalogic.com

KEYBOARD	FEATURES
<p>AT, PS/2 25-286, 30-286, 50, 50Z, 60, 70, 80, 90 & 95 w/Standard Key Encoding</p>  <p>Select KBD-AT</p>	<p>Set KEYBOARD WEDGE Interface Features starting on page 73</p>
 <p>Select KBD-AT-NK</p> <p>Keyboard Wedge for IBM AT PS2 with standard key encoding but without external keyboard</p>	
<p>AT, PS/2 25-286, 30-286, 50, 50Z, 60, 70, 80, 90 & 95 w/Alternate Key</p>  <p>Select KBD-AT-ALT</p>	
 <p>Select KBD-AT-ALT-NK</p> <p>Keyboard Wedge for IBM AT PS2 with alternate key encoding but without external keyboard</p>	
<p>PC/XT w/Standard Key Encoding</p>  <p>Select KBD-XT</p>	
 <p>Select KBD-IBM-3153</p> <p>Keyboard Wedge for IBM Terminal 3153</p>	

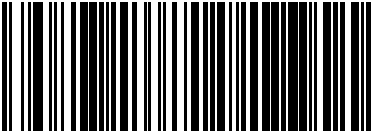
KEYBOARD — cont.	FEATURES
<p>Keyboard Wedge for IBM Terminals 31xx, 32xx, 34xx, 37xx make only keyboard</p>  <p>Select KBD-IBM-M</p>	<p>Set KEYBOARD WEDGE Interface Features starting on page 73</p>
 <p>Select KBD-IBM-MB</p> <p>Keyboard Wedge for IBM Terminals 31xx, 32xx, 34xx, 37xx make break keyboard</p>	
<p>Keyboard Wedge for DIGITAL Terminals VT2xx, VT3xx, VT4xx</p>  <p>Select KBD-DIG-VT</p>	
 <p>Select USB Keyboard</p> <p>USB Keyboard with standard key encoding</p>	
<p>USB Keyboard with alternate key encoding</p>  <p>Select USB Alternate Keyboard</p>	
 <p>Select USB-KBD-APPLE</p> <p>USB Keyboard for Apple computers</p>	
WAND EMULATION	FEATURES
<p>Wand Emulation</p>  <p>Select WAND</p>	<p>Set WAND Interface Features starting on page 97</p>

Global Interface Features

The following interface features are configurable by all interface types. To set features specific to your interface, turn to that section of this manual:

- [RS-232 ONLY Interface on page 47](#)
- [Keyboard Interface on page 73](#)
- [USB-OEM Interface on page 87](#)
- [IBM 46XX Interface on page 91](#)

Host Commands — Obey/Ignore

This option specifies whether the reader will obey or ignore host commands. When set to ignore, the reader will ignore all host commands except for those necessary for:

- service mode
- flash programming mode
- keeping the interface active
- transmission of labels.



USB Suspend Mode

This setting enables/disables the ability of USB interfaces to enter suspend mode.



Chapter 4

General Features

Double Read Timeout

To prevent a double read of the same label, the Double Read Timeout sets the minimum time allowed between reads of labels of the same symbology and data. If the unit reads a label and sees the same label again within the Double Read Timeout, the second read of the label will be ignored. Double Read Timeout does not apply to scan modes that require a trigger pull for each label that is read.

 ENTER/EXIT PROGRAMMING MODE	
	 Double Read Timeout = 0.1 Second
 Double Read Timeout = 0.2 Second	
	 Double Read Timeout = 0.3 Second
 Double Read Timeout = 0.4 Second	

Double Read Timeout – continued

 ENTER/EXIT PROGRAMMING MODE	
	 Double Read Timeout = 0.5 Second
 Double Read Timeout = 0.6 Second	
	 Double Read Timeout = 0.7 Second
 Double Read Timeout = 0.8 Second	
	 Double Read Timeout = 0.9 Second
 Double Read Timeout = 1 Second	

Label Gone Timeout

This feature sets the time after the last label segment is seen before the reader prepares for a new label. The timeout can be set within a range of 10 milliseconds to 2,550 milliseconds (2.55 seconds) in 10ms increments.

Follow these instructions to set this feature:

1. Determine the desired setting in milliseconds.
2. Divide the desired setting by 10 (setting is in 10ms increments). Pad the result with leading zeroes to yield three digits. For example: 0 = 000, 5 = 005, 20 = 020, etc.
3. Scan the ENTER/EXIT PROGRAMMING MODE barcode to enter Programming Mode.
4. Scan the barcode: SELECT LABEL GONE TIMEOUT SETTING.
5. Scan the appropriate three alpha-numeric characters from the keypad in [Appendix E, Keypad](#) representing the duration which was determined in the steps above. You will hear a two-beep indication after the last character.



If you make a mistake before the last character, scan the CANCEL barcode to abort and not save the entry string. You can then start again at the beginning.

NOTE

6. Scan the ENTER/EXIT PROGRAMMING MODE barcode to exit Programming Mode.

This completes the procedure. See [Table 2](#) for some examples of how to set this feature.

Table 2. Timeout Setting Examples

STEP	ACTION	EXAMPLES			
1	Desired Setting	50ms	150ms	1800ms (1.8 sec.)	2550ms (2.55 sec.)
2	Divide by 10 (and pad with leading zeroes)	005	015	180	255
3	Scan ENTER/EXIT PROGRAMMING MODE				
4	Scan SELECT LABEL GONE TIMEOUT SETTING				
5	Scan Three Characters From Appendix E, Keypad	'0', '0' and '5'	'0', '1' and '5'	'1', '8' and '0'	"2", '5' and '5'
6	Scan ENTER/EXIT PROGRAMMING MODE				

Label Gone Timeout – cont.

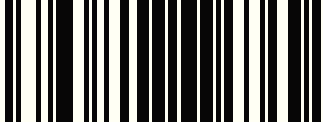
 ENTER/EXIT PROGRAMMING MODE
--

 Select Label Gone Timeout Setting
--

--



Make a mistake? Scan the CANCEL barcode to abort and not save the entry string. You can then start again at the beginning.

 CANCEL

 016 = Timeout of 160 ms

Sleep Mode Timeout

Specifies the timeout value for the reader to enter low power Sleep Mode.

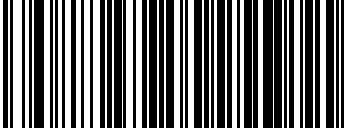
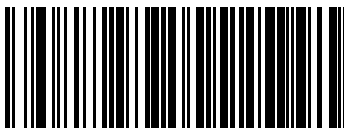
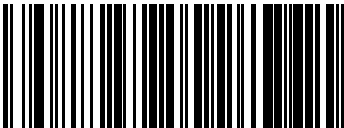
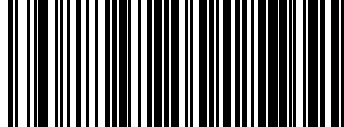
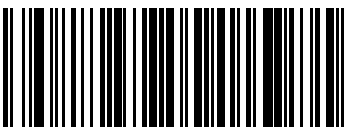
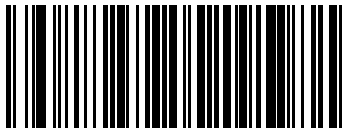
 ENTER/EXIT PROGRAMMING MODE	
	 Sleep Mode Timeout = Disable
 Sleep Mode Timeout = 500ms	
	 Sleep Mode Timeout = 1 Second
 Sleep Mode Timeout = 2 Seconds	
	 Sleep Mode Timeout = 3 Seconds
 Sleep Mode Timeout = 4 Seconds	



Sleep Mode Timeout – continued

 ENTER/EXIT PROGRAMMING MODE	
	 Sleep Mode Timeout = 5 Seconds
 Sleep Mode Timeout = 6 Seconds	
	 Sleep Mode Timeout = 7 Seconds
 Sleep Mode Timeout = 8 Seconds	
	 Sleep Mode Timeout = 9 Seconds
 Sleep Mode Timeout = 9.9 Seconds (9,900ms max.)	

LED and Beeper Indicators

Power On Alert

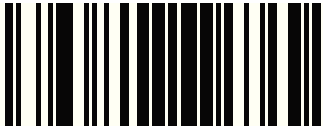
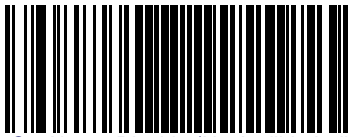
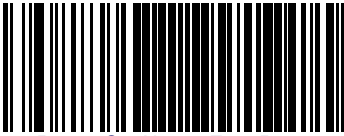
Disables or enables the indication (from the Beeper) that the reader is receiving power.

 ENTER/EXIT PROGRAMMING MODE	
	 Power On Alert = Disable (No Audible Indication)
 Power On Alert = Four Beeps	

Good Read: When to Indicate

This feature specifies when the reader will provide indication (beep and/or flash its green LED) upon successfully reading a barcode. Choices are:

- Good Read = Indicate after decode
- Good Read = Indicate after transmit
- Good Read = Indicate after CTS goes inactive, then active



This option, which uses CTS, is only valid for RS-232 interfaces.

NOTE



Good Read Beep Type

Specifies whether the good read beep has a mono or bitonal beep sound.

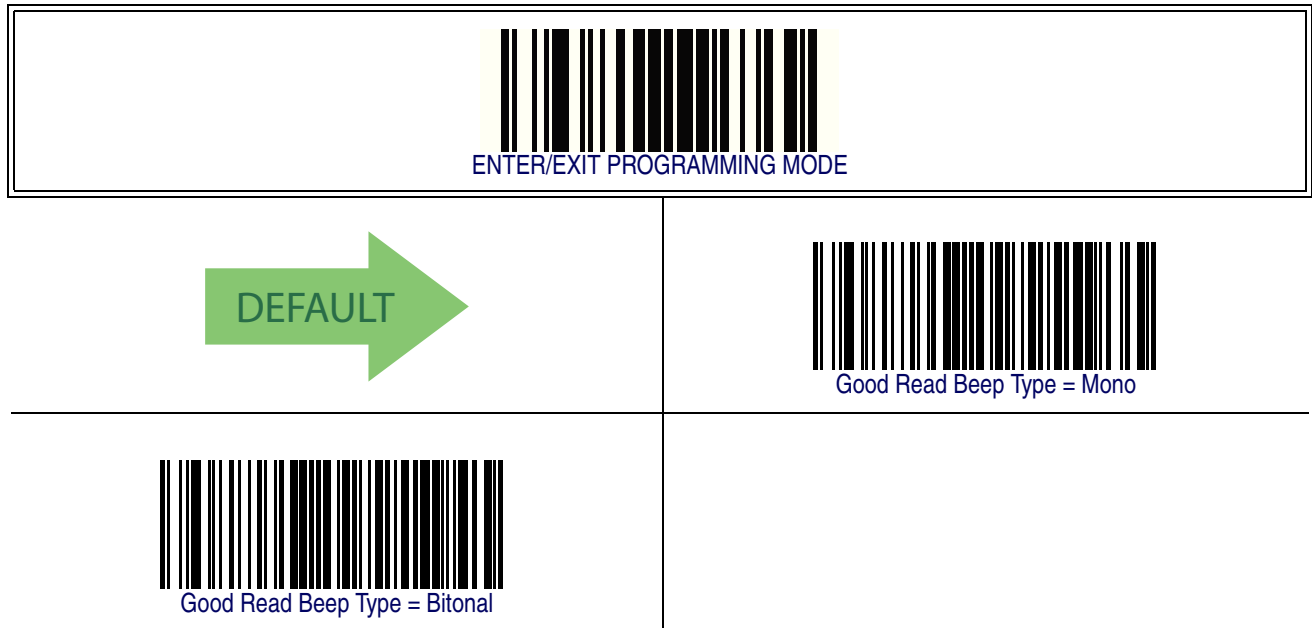

Good Read Beep Frequency

Adjusts the good read beep to sound at a selectable low, medium or high frequency, selectable from the list below. (Controls the beeper's pitch/tone.)

 ENTER/EXIT PROGRAMMING MODE	
	 Good Read Beep Frequency = Low
 Good Read Beep Frequency = Medium	
 DEFAULT	 Good Read Beep Frequency = High

Good Read Beep Length

Specifies the duration of a good read beep.

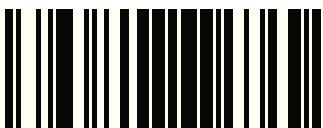
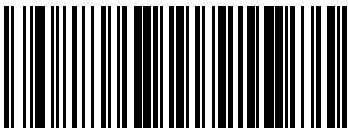
 ENTER/EXIT PROGRAMMING MODE	
	 Good Read Beep Length = 60 msec

Good Read Beep Length — continued

 ENTER/EXIT PROGRAMMING MODE	
 Good Read Beep Length = 80 msec	
	 Good Read Beep Length = 100 msec
 Good Read Beep Length = 120 msec	
	 Good Read Beep Length = 140 msec
 Good Read Beep Length = 160 msec	
	 Good Read Beep Length = 180 msec
 Good Read Beep Length = 200 msec	

Good Read Beep Volume

Selects the beeper volume (loudness) upon a good read beep. There are three selectable volume levels.

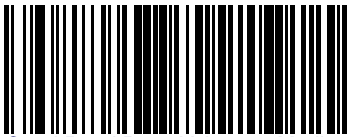
 ENTER/EXIT PROGRAMMING MODE	
	 Good Read Beep Volume = Beeper Off
 Good Read Beep Volume = Low	
	 Good Read Beep Volume = Medium
 Good Read Beep Volume = High	 DEFAULT

Good Read LED Duration

This feature specifies the amount of time that the Good Read LED remains on following a good read. The good read LED on time can be set within a range of 100 milliseconds to 25,500 milliseconds (0.1 to 25.5 seconds) in 100ms increments.

Follow these instructions to set this feature:

1. Determine the desired setting in milliseconds. A setting of 0 means that the good read LED stays on until the next time the trigger is pulled.
2. Divide the desired setting by 100 (setting is in 100 ms increments). Pad the result with leading zeroes to yield three digits. For example: 0 = 000, 5 = 005, 20 = 020, etc.
3. Scan the ENTER/EXIT PROGRAMMING MODE barcode to enter Programming Mode.
4. Scan the barcode: SELECT GOOD READ LED DURATION SETTING.
5. Scan the appropriate three digits from the keypad in [Appendix E, Keypad](#) representing the duration which was determined in the steps above. You will hear a two-beep indication after the last character.



If you make a mistake before the last character, scan the CANCEL barcode to abort and not save the entry string. You can then start again at the beginning.

NOTE

6. Scan the ENTER/EXIT PROGRAMMING MODE barcode to exit Programming Mode.

This completes the procedure. See [Table 3](#) for some examples of how to set this feature.

Table 3. Good Read LED Duration Setting Examples

STEP	ACTION	EXAMPLES			
1	Desired Setting	Good Read LED stays on until next trigger pull (000)	200ms	1500ms	25,500ms (25.5 sec.)
2	Divide by 10 (and pad with leading zeroes)	000	002	015	255
3	Scan ENTER/EXIT PROGRAMMING MODE				
4	Scan SELECT LABEL GONE TIMEOUT SETTING				
5	Scan Three Characters From Appendix E, Keypad	'0', '0' and '0'	'0', '0' and '2'	'0', '1' and '5'	'2', '5' and '5'
6	Scan ENTER/EXIT PROGRAMMING MODE				

Good Read LED Duration – cont.

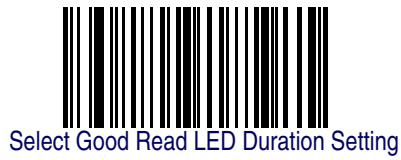
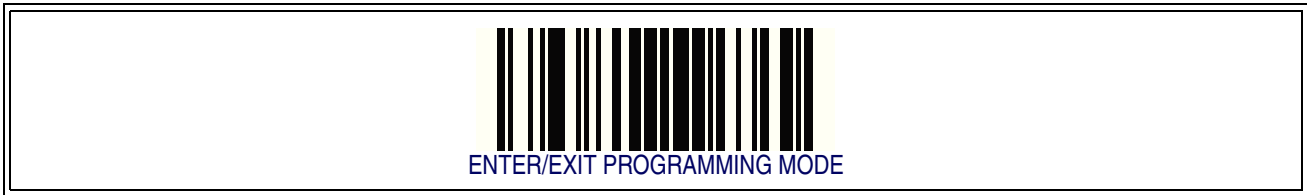

Make a mistake? Scan the CANCEL barcode to abort and not save the entry string. You can then start again at the beginning.

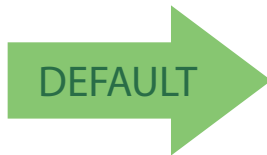

020 = Good Read LED stays on for 2 seconds.



Indicators are dimmed during sleep.

NOTE

Scanning Features

Scan Mode

Selects the scan operating mode for the reader. Selections are:

Trigger Single — When the trigger is pulled, scanning is activated until one of the following occurs:

- [Scanning Active Time](#) has elapsed
- a label has been read
- the trigger is released

This mode is associated with typical handheld reader operation: when the trigger is pulled, scanning starts and the product scans until the trigger is released, or a label is read, or the maximum [Scanning Active Time](#) has elapsed.

Trigger Hold Multiple — When the trigger is pulled, scanning starts and the product scans until the trigger is released or [Scanning Active Time](#) has elapsed. Reading a label does not disable scanning. [Double Read Timeout](#) prevents undesired multiple reads of the same label while in this mode.

Trigger Pulse Multiple — When the trigger is pulled, continuous scanning is activated until [Scanning Active Time](#) has elapsed or the trigger has been released and pulled again. [Double Read Timeout](#)¹ prevents undesired multiple reads of the same label while in this mode.

Flashing — The reader flashes¹ on and off regardless of the trigger status. Flash rate is controlled by [Flash On Time](#) and [Flash Off Time](#).

Always On — No trigger pull is required to read a barcode. Scanning is continually on. If the trigger is pulled, the reader acts as if it is in [Trigger Single Mode](#). [Double Read Timeout](#)¹ prevents undesired multiple reads of the same label while in this mode.

Stand Mode — No trigger pull is required to read a barcode. Scanning is turned on automatically when an item is placed in reader's field of view. If the trigger is pulled, the reader acts as if it is in single read mode. [Double Read Timeout](#)¹ prevents undesired multiple reads of the same label while in this mode.

Trigger Object Sense — This mode is similar to Stand Mode, except that a trigger pull is required to activate the decoder.

1. Controlled by [Flash On Time](#).

Scan Mode – continued

 ENTER/EXIT PROGRAMMING MODE	
 Scan Mode = Trigger Single	
	 Scan Mode = Trigger Hold Multiple
 Scan Mode = Trigger Pulse Multiple	
	 Scan Mode = Flashing
 Scan Mode = Always On	
	 Scan Mode = Stand Mode
 Scan Mode = Trigger Object Sense	

Stand Mode Triggered Timeout

This feature specifies the time to remain in **Trigger Single** mode after the trigger is pulled while in **Stand Mode**.



This timeout is only used when the Scan Mode is configured as **Stand Mode**.

NOTE

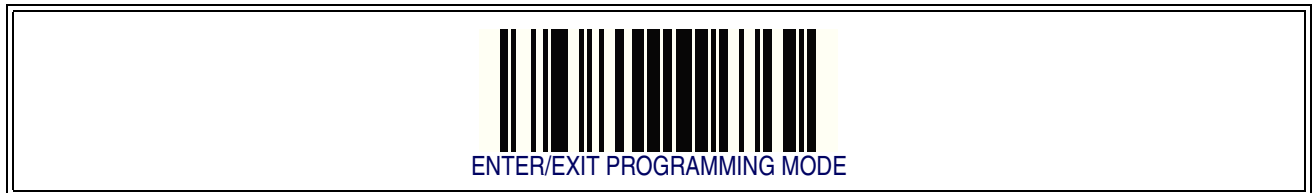

<p>Stand Mode Triggered Timeout = 0.5 Seconds</p>	
	<p>Stand Mode Triggered Timeout = 1.5 Seconds</p>
<p>Stand Mode Triggered Timeout = 2 Seconds</p>	
	<p>Stand Mode Triggered Timeout = 3 Seconds</p>
<p>Stand Mode Triggered Timeout = 4 Seconds</p>	

Stand Mode Triggered Timeout – continued

 ENTER/EXIT PROGRAMMING MODE	
	 Stand Mode Triggered Timeout = 6 Seconds
 Stand Mode Triggered Timeout = 8 Seconds	
	 Stand Mode Triggered Timeout = Switch back to Trigger Single on trigger pull

Scanning Active Time

This setting specifies the amount of time that the reader stays in scan ON state once the state is entered. The range for this setting is from 1 to 255 seconds in 1-second increments.

Follow these instructions to set this feature:

1. Determine the desired setting.
2. Pad the result with leading zeroes to yield three digits. For example: 0 = 000, 5 = 005, 20 = 020, etc.
3. Scan the ENTER/EXIT PROGRAMMING MODE barcode to enter Programming Mode.
4. Scan the barcode: SELECT SCANNING ACTIVE TIME SETTING.
5. Scan the appropriate three digits from the keypad in [Appendix E, Keypad](#), that represent the duration which was determined in the steps above. You will hear a two-beep indication after the last character.



If you make a mistake before the last character, scan the CANCEL barcode to abort and not save the entry string. You can then start again at the beginning.

NOTE

6. Scan the ENTER/EXIT PROGRAMMING MODE barcode to exit Programming Mode.

This completes the procedure. See [Table 4](#) for some examples of how to set this feature.

Table 4. Scanning Active Time Setting Examples

STEP	ACTION	EXAMPLES			
1	Desired Setting	1 Second	90 Sec. (1.5 min.)	180 Sec. (3 min.)	255 Seconds (4.25 min.)
2	Pad leading zero(es)	001	090	180	255
3	Scan ENTER/EXIT PROGRAMMING MODE				
4	Scan SELECT SCANNING ACTIVE TIME SETTING				
5	Scan Three Characters From Appendix E, Keypad	'0', '0' and '1'	'0', '9' and '0'	'1', '8' and '0'	'2', '5' and '5'
6	Scan ENTER/EXIT PROGRAMMING MODE				

Scanning Active Time – cont.

 ENTER/EXIT PROGRAMMING MODE
--

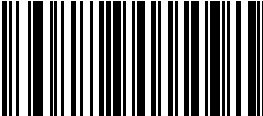
 Select Scanning Active Time Setting	
--	--

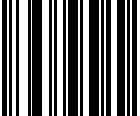
Make a mistake? Scan the CANCEL barcode to abort and not save the entry string. You can then start again at the beginning.	 CANCEL
--	---

 005 = Scanning is active for 5 Seconds

Flash On Time

This feature specifies the ON time for the indicator LED while in Flash Mode. The selectable range is 100 to 9,900 milliseconds (0.1 to 9.9 seconds), in 100 millisecond increments.

Follow these instructions to set this feature.

1. Determine the desired setting in milliseconds.
2. Divide the desired setting by 100 (setting is in 100ms increments). Pad the result with leading zeroes to yield two digits. For example: 0 = 00, 5 = 05, 20 = 20, etc.
3. Scan the ENTER/EXIT PROGRAMMING MODE barcode to enter Programming Mode.
4. Scan the barcode: SELECT FLASH ON TIME SETTING.
5. Scan the appropriate two digits from the keypad in [Appendix E, Keypad](#) representing the duration which was determined in the steps above. You will hear a two-beep indication after the last character.



If you make a mistake before the last character, scan the CANCEL barcode to abort and not save the entry string. You can then start again at the beginning.

NOTE

6. Scan the ENTER/EXIT PROGRAMMING MODE barcode to exit Programming Mode.

This completes the procedure. See [Table 5](#) for some examples of how to set this feature.

Table 5. Flash On Time Setting Examples

STEP	ACTION	EXAMPLES			
1	Desired Setting	500ms	1,000ms (1 sec.)	5200ms (5.2 sec.)	9,900ms (9.9 sec.)
2	Divide by 100 (and pad with leading zeroes to yield two digits)	05	10	52	99
3	Scan ENTER/EXIT PROGRAMMING MODE				
4	Scan SELECT FLASH OFF TIME SETTING				
5	Scan Two Characters From Appendix E, Keypad	'0' and '5'	'1' and '0'	'5' and '2'	'9' and '9'
6	Scan ENTER/EXIT PROGRAMMING MODE				

Flash On Time – cont.

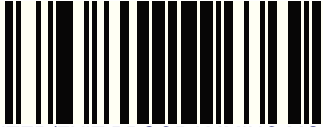
 ENTER/EXIT PROGRAMMING MODE
--

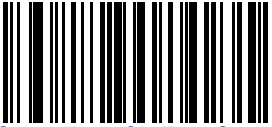
 Select Flash ON Time Setting

Make a mistake? Scan the CANCEL barcode to abort and not save the entry string. You can then start again at the beginning.

 CANCEL

 10 = Flash is ON for 1 Second

Flash Off Time

This feature specifies the OFF time for the indicator LED while in Flash Mode. The selectable range is 100 to 9,900 milliseconds (0.1 to 9.9 seconds), in 100 millisecond increments.

Follow these instructions to set this feature.

1. Determine the desired setting in milliseconds.
2. Divide the desired setting by 100 (setting is in 100ms increments). Pad the result with leading zeroes to yield two digits. For example: 0 = 00, 5 = 05, 20 = 20, etc.
3. Scan the ENTER/EXIT PROGRAMMING MODE barcode to enter Programming Mode.
4. Scan the barcode: SELECT FLASH OFF TIME SETTING.
5. Scan the appropriate two digits from the keypad in [Appendix E, Keypad](#), that represent the duration which was determined in the steps above. You will hear a two-beep indication after the last character.



If you make a mistake before the last character, scan the CANCEL barcode to abort and not save the entry string. You can then start again at the beginning.

NOTE

6. Scan the ENTER/EXIT PROGRAMMING MODE barcode to exit Programming Mode.

This completes the procedure. See [Table 6](#) for some examples of how to set this feature.

Table 6. Flash Off Time Setting Examples

STEP	ACTION	EXAMPLES			
1	Desired Setting	500ms	1,000ms (1 sec.)	5200ms (5.2 sec.)	9,900ms (9.9 sec.)
2	Divide by 100 (and pad with leading zeroes to yield two digits)	05	10	52	99
3	Scan ENTER/EXIT PROGRAMMING MODE				
4	Scan SELECT FLASH OFF TIME SETTING				
5	Scan Two Characters From Appendix E, Keypad	'0' and '5'	'1' and '0'	'5' and '2'	'9' and '9'
6	Scan ENTER/EXIT PROGRAMMING MODE				

Flash Off Time – cont.

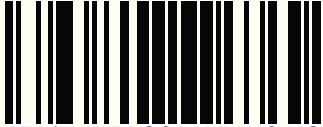
 ENTER/EXIT PROGRAMMING MODE
--

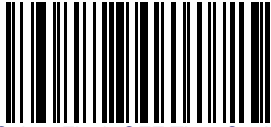
 Select Flash OFF Time Setting
--

Make a mistake? Scan the CANCEL barcode to abort and not save the entry string. You can then start again at the beginning.

 CANCEL

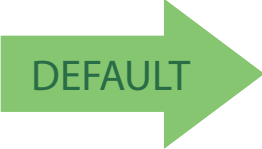
 06 = Flash is OFF for 600ms

Stand Mode Sensitivity

Sets the sensitivity level for stand mode wakeup. Choices are low, medium and high.

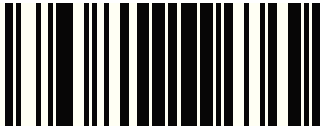
 ENTER/EXIT PROGRAMMING MODE	
	 Stand Mode Sensitivity = Low
 Stand Mode Sensitivity = Medium	 DEFAULT
	 Stand Mode Sensitivity = High







Laser Pointer Control

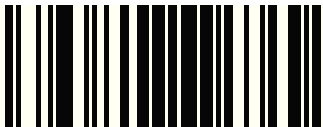

The Laser Pointer is a value-added option which might not have been included when your reader was ordered.

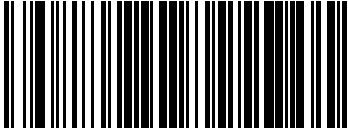
NOTE

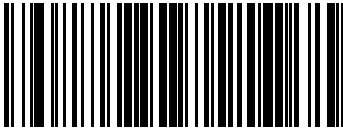
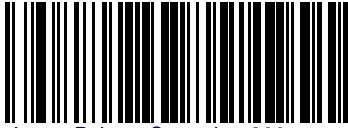
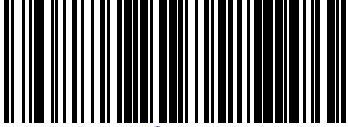
Specifies the amount of time that the laser pointer is turned on preliminary to scanning. When the trigger is pressed in Trigger Single Mode, the laser pointer will be activated for the time period configured by this feature. Immediately following this, the reader will start scanning.

 ENTER/EXIT PROGRAMMING MODE	
	 Laser Pointer Control = 0 msec (No preliminary pointer — i.e. start scanning immediately after trigger)
 Laser Pointer Control = 100 msec	
	 Laser Pointer Control = 200 msec
 Laser Pointer Control = 300 msec	
	 Laser Pointer Control = 400 msec
 Laser Pointer Control = 500 msec	

Laser Pointer Period

This option specifies the period of the laser pointer blink during scanning. The laser pointer will be activated for the time specified by **Laser Pointer Control** then start blinking OFF then ON at a 50% duty cycle and a repeating period set by **Laser Pointer Period**.

 ENTER/EXIT PROGRAMMING MODE	
	 Laser Pointer Period = Laser Pointer Blinking Off
 Laser Pointer Period = 500 ms	
	 Laser Pointer Period = 1 Second
 Laser Pointer Period = 1.5 Seconds	
	 Laser Pointer Period = 2 Seconds

Green Spot Duration

Specifies the duration of the good read pointer beam after a good read.

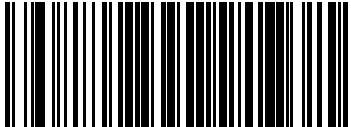
 ENTER/EXIT PROGRAMMING MODE	
	 Green Spot Duration = Disable (Green Spot is Off)
 Green Spot Duration = Short (300 msec)	 DEFAULT
	 Green Spot Duration = Medium (500 msec)
 Green Spot Duration = Long (800 msec)	

Chapter 5

RS-232 ONLY Interface

Introduction

Use the programming barcodes in this chapter if modifications to the standard RS-232 interface settings are necessary to meet your system's requirements. Additional settings which apply to both the RS-232 and USB interfaces are available in [Chapter 6, RS-232/USB-Com Interfaces](#).

RS-232 Standard Factory Settings

Reference [Appendix B, Standard Defaults](#) for a listing of standard factory settings.

Baud Rate

Baud rate is the number of bits of data transmitted per second. Set the reader's baud rate to match the baud rate setting of the host device. With an improper baud rate setting, data may not reach the host correctly.

 ENTER/EXIT PROGRAMMING MODE	
	 Baud Rate = 1200
 Baud Rate = 2400	
	 Baud Rate = 4800

Baud Rate — continued

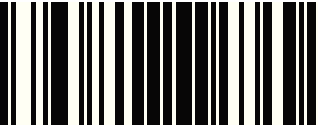
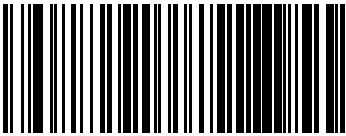
 ENTER/EXIT PROGRAMMING MODE	
 Baud Rate = 9600	
	 Baud Rate = 19,200
 Baud Rate = 38,400	
	 Baud Rate = 57,600
 Baud Rate = 115,200	

Data Bits

This parameter allows the reader to interface with devices requiring a 7-bit or 8-bit ASCII protocol for sending and receiving data.



Stop Bits

The stop bit(s) at the end of each transmitted character marks the end of transmission of one character and prepares the receiving device for the next character in the serial data stream. The number of stop bits selected (one or two) depends on the number the receiving terminal is programmed to accommodate. Set the number of stop bits to match host device requirements.

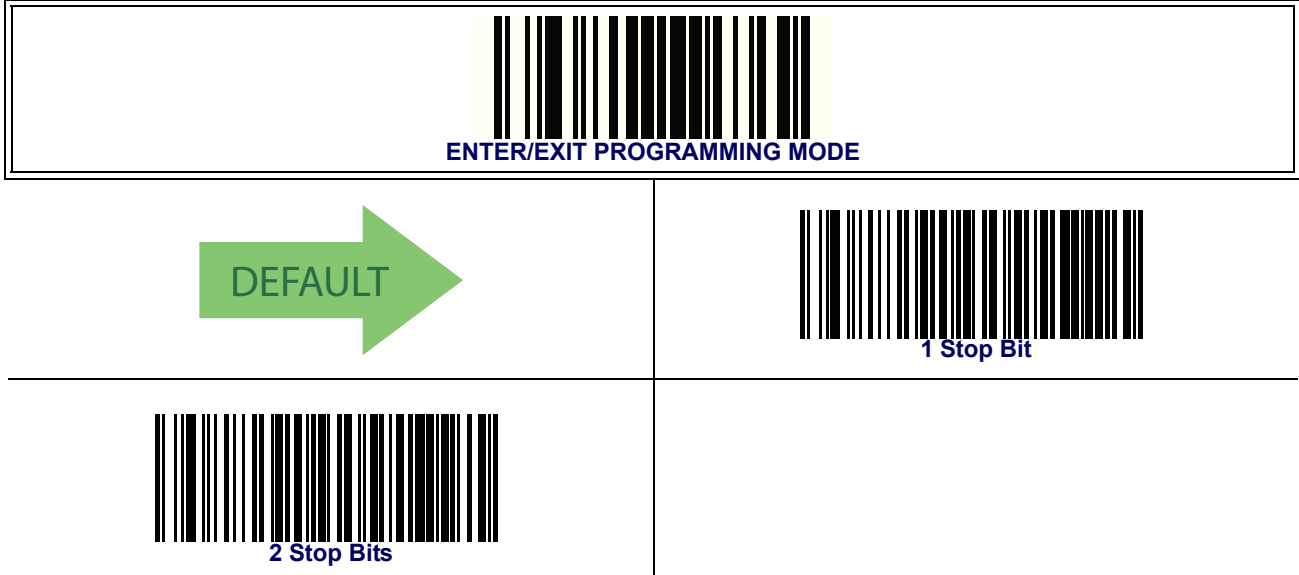

Parity

This feature specifies parity required for sending and receiving data. A parity check bit is the most significant bit of each ASCII coded character. Select the parity type according to host device requirements.

- Select None when no parity bit is required.
- Select Odd parity and the parity bit value is set to 0 or 1, based on data, to ensure that an odd number of 1 bits are contained in the coded character.
- Select Even parity and the parity bit value is set to 0 or 1, based on data, to ensure that an even number of 1 bits are contained in the coded character.



Handshaking Control

The data interface consists of an RS-232 port designed to operate either with or without the hardware handshaking lines, *Request to Send* (RTS), and *Clear to Send* (CTS). Handshaking Control includes the following options:

- RTS — RTS is asserted during transmissions. CTS is ignored.
- RTS/CTS — RTS is asserted during transmissions. CTS gates transmissions.
- RTS/XON/XOFF — RTS is asserted during transmissions. CTS is ignored. XON and XOFF gate transmissions.
- RTS On/CTS — RTS is always asserted. CTS gates transmissions.
- RTS/CTS Scan Control — RTS is asserted during transmissions. CTS gates transmissions and controls enable and disable state of scanner.

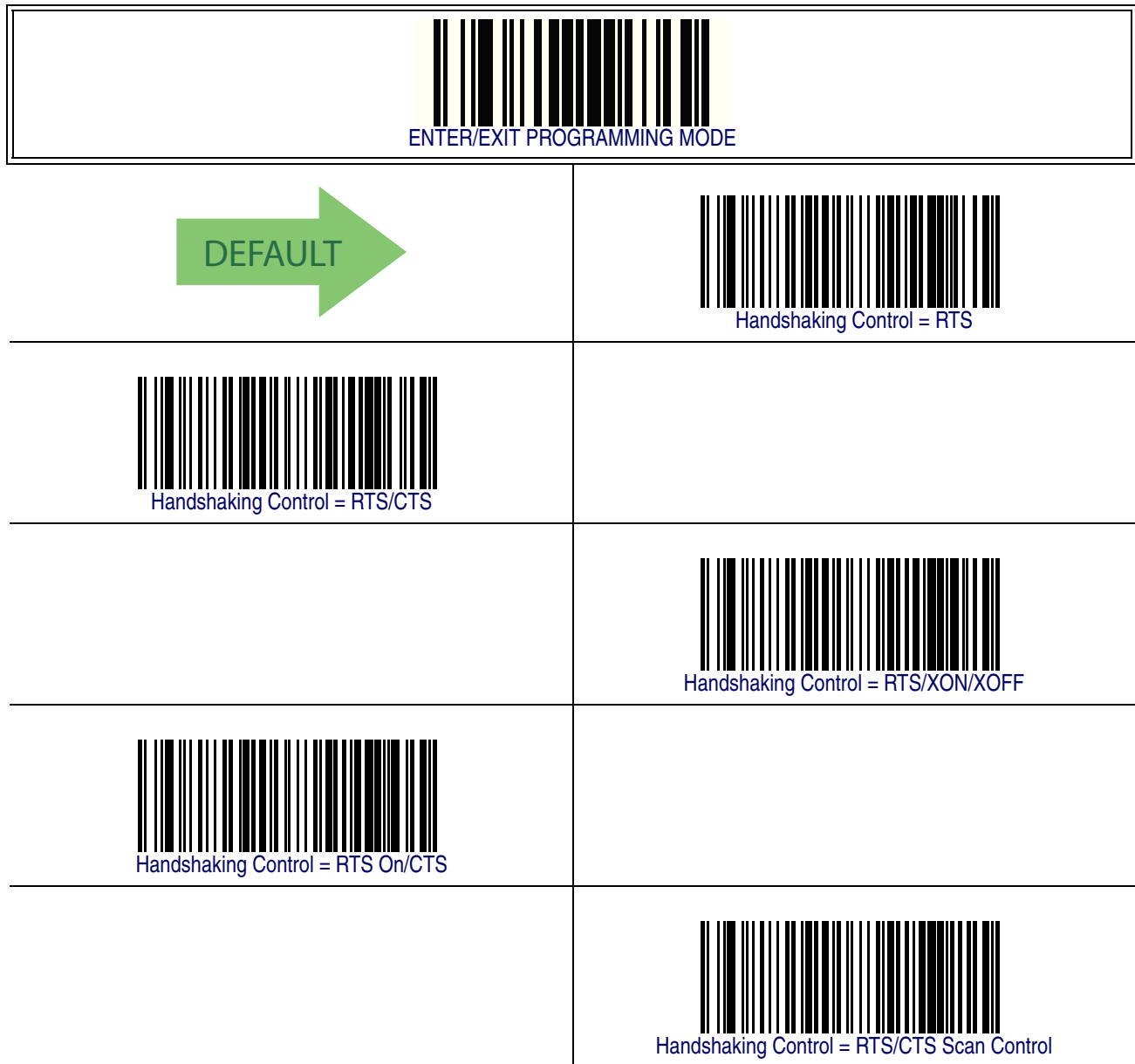

Chapter 6

RS-232/USB-Com Interfaces

Introduction

The programming barcodes in this chapter allow modifications to the standard RS-232 and USB-Com interfaces.

Standard Factory Settings

Reference [Appendix B, Standard Defaults](#) for a listing of standard factory settings.

Intercharacter Delay

This parameter specifies the intercharacter delay between the end of one character and the beginning of the next. The delay can be set within a range of zero (0) to 990 milliseconds in 10ms increments. A setting of zero specifies no delay.

To set the delay:

1. Determine the desired setting in milliseconds.
2. Divide the desired setting by 10 (setting is in 10ms increments). Pad the result with leading zeroes to yield two digits. For example: 0 = 00, 5 = 05, 20 = 20, etc.
3. Scan the ENTER/EXIT PROGRAMMING MODE barcode to enter Programming Mode.
4. Scan the barcode: SELECT INTERCHARACTER DELAY SETTING.
5. Scan the appropriate two digits from the keypad in [Appendix E, Keypad](#), that represent the duration which was determined in the steps above. You will hear a two-beep indication after the last character.



If you make a mistake before the last character, scan the CANCEL barcode to abort and not save the entry string. You can then start again at the beginning.

NOTE

6. Scan the ENTER/EXIT PROGRAMMING MODE barcode to exit Programming Mode.

This completes the procedure. See [Table 7](#) for some examples of how to set this feature.

Table 7. Intercharacter Delay Setting Examples

STEP	ACTION	EXAMPLES			
1	Desired Setting	50ms	150ms	600ms	850ms
2	Divide by 10 (and pad with leading zeroes to yield two-digits)	05	15	60	85
3	Scan ENTER/EXIT PROGRAMMING MODE				
4	Scan SELECT INTERCHARACTER DELAY SETTING				
5	Scan Two Characters From Appendix E, Keypad	'0' and '5'	'5' and '0'	0' and '0'	'8' and '5'
6	Scan ENTER/EXIT PROGRAMMING MODE				

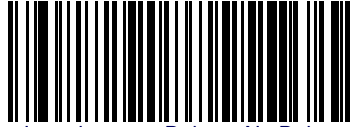

Intercharacter Delay – cont.

 ENTER/EXIT PROGRAMMING MODE	
	 Intercharacter Delay = No Delay
 Select Intercharacter Delay Setting	
<p>Make a mistake? Scan the CANCEL barcode to abort and not save the entry string. You can then start again at the beginning.</p>	 CANCEL

 00 = No Intercharacter Delay

Beep On ASCII BEL

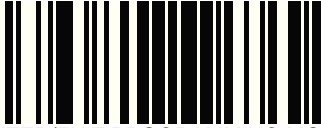
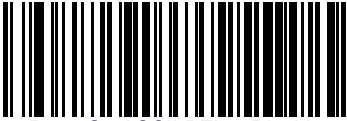
When this parameter is enabled, the reader issues a beep when a <BEL> character is detected on the RS-232 serial line. <BEL> is issued to gain a user's attention to an illegal entry or other important event.

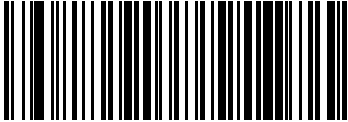
 ENTER/EXIT PROGRAMMING MODE	
 Beep On ASCII BEL = Disable	 DEFAULT
 Beep On ASCII BEL = Enable	

Beep On Not on File

This option enables/disables the action of the reader to sound a three beep sequence upon receiving a Not-On-File (NOF) host command.

 ENTER/EXIT PROGRAMMING MODE	
 Beep On Not On File = Disable	
 DEFAULT	 Beep On Not On File = Enable

ACK NAK Options

This enables/disables the ability of the reader to support the RS-232 ACK/NAK protocol. When configured, the reader and/or host sends an “ACK” when it receives data properly, and sends “NAK” when the data is in error.

Options are:

- Disable
- Enable for label transmission — The reader expects an ACK/NAK response from the host when a label is sent.
- Enable for host-command acknowledge — The reader will respond with ACK/NAK when the host sends a command.
- Enable for label transmission and host-command acknowledge

 ENTER/EXIT PROGRAMMING MODE	
 DEFAULT	 ACK/NAK Protocol = Disable ACK/NAK
 ACK/NAK Protocol = Enable for label transmission	
	 ACK/NAK Protocol = Enable for host-command acknowledge
 ACK/NAK Protocol = Enable for label transmission and host-com- mand acknowledge	

ACK Character

This setting specifies an ASCII character or hex value to be used as the ACK character. ASCII characters or any hex value from 0 to 0xFF can be selected.



NOTE

Setting to previously defined characters such as XON, XOFF, or host commands conflicts with normal operation of these characters. 8-bit data is not recognized when the option **Data Bits** has been set as 7 Data Bits.

To set this feature:

1. Determine the desired character or value.
2. Use the [ASCII Chart](#) on the inside back cover of this manual to find the hex equivalent for the desired character/value.
3. Scan the ENTER/EXIT PROGRAMMING MODE barcode to enter Programming Mode.
4. Scan the barcode: SELECT ACK CHARACTER SETTING.
5. Scan the appropriate two alpha-numeric characters from the keypad in [Appendix E, Keypad](#), that represent the desired character/value in step 1 above. The second character will cause a two-beep indication.
6. Scan the ENTER/EXIT PROGRAMMING MODE barcode to exit Programming Mode.

This completes the procedure. See [Table 8](#) for some examples of how to set this feature.

Table 8. ACK Character Setting Examples

STEP	ACTION	EXAMPLES			
1	Desired Character/Value	ACK	\$	@	>
2	Hex equivalent	0x06	0x24	0x40	0x3E
3	Scan ENTER/EXIT PROGRAMMING MODE				
4	Scan SELECT ACK CHARACTER SETTING				
5	Scan Two Characters From Appendix E, Keypad	'0' and '6'	'2' and '4'	'4' and '0'	'3' AND 'E'
6	Scan ENTER/EXIT PROGRAMMING MODE				

ACK Character — cont.

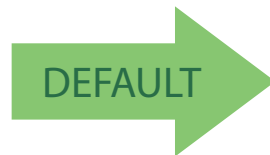
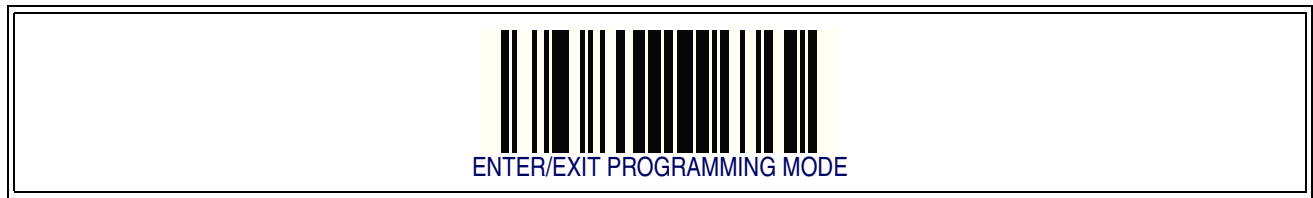

0x06 'ACK' Character

NAK Character

This setting specifies an ASCII character or hex value to be used as the NAK character. ASCII characters or any hex value from 0 to 0xFF can be selected.



NOTE

Setting to previously defined characters such as XON, XOFF, or host commands conflicts with normal operation of these characters. 8-bit data is not recognized when the option **Data Bits** has been set as 7 Data Bits.

To set this feature:

1. Determine the desired character or value.
2. Use the [ASCII Chart](#) on the inside back cover of this manual to find the hex equivalent for the desired character/value.
3. Scan the ENTER/EXIT PROGRAMMING MODE barcode to enter Programming Mode.
4. Scan the barcode: SELECT NAK CHARACTER SETTING.
5. Scan the appropriate two alpha-numeric characters from the keypad in [Appendix E, Keypad](#), that represent the desired character/value in step 1 above. The second character will cause a two-beep indication.
6. Scan the ENTER/EXIT PROGRAMMING MODE barcode to exit Programming Mode.

This completes the procedure. See [Table 9](#) for some examples of how to set this feature.

Table 9. NAK Character Setting Examples

STEP	ACTION	EXAMPLES			
1	Desired Character/Value	NAK	\$	@	>
2	Hex equivalent	0x15	0x24	0x40	0x3E
3	Scan ENTER/EXIT PROGRAMMING MODE				
4	Scan SELECT ACK CHARACTER SETTING				
5	Scan Two Characters From Appendix E, Keypad	'1' and '5'	'2' and '4'	'4' and '0'	'3' AND 'E'
6	Scan ENTER/EXIT PROGRAMMING MODE				

NAK Character – cont.

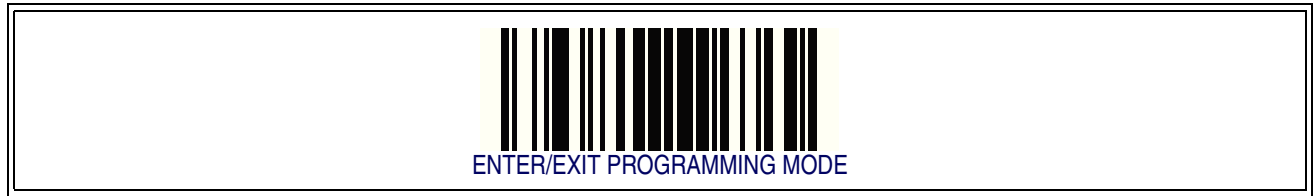

0x15 'NAK' Character

ACK NAK Timeout Value

This option specifies the amount of time the reader waits for an ACK character from the host following label transmission. The selectable timeout range is 200 milliseconds to 15,000ms (15 seconds) in 200ms increments. A selection of 0 disables the timeout.

To set this value:

1. Determine the desired setting in milliseconds.
2. Divide the desired setting by 200 (setting is in 200ms increments). Pad the result with leading zeroes to yield two digits. For example: 0 = 00, 5 = 05, 20 = 20, etc.
3. Scan the ENTER/EXIT PROGRAMMING MODE barcode to enter Programming Mode.
4. Scan the barcode: SELECT ACK NAK TIMEOUT VALUE SETTING.
5. Scan the appropriate two digits from the keypad in [Appendix E, Keypad](#), that represent the duration which was determined in the steps above. You will hear a two-beep indication after the last character.



If you make a mistake before the last character, scan the CANCEL barcode to abort and not save the entry string. You can then start again at the beginning.

NOTE

6. Scan the ENTER/EXIT PROGRAMMING MODE barcode to exit Programming Mode.

This completes the procedure. See [Table 10](#) for some examples of how to set this feature.

Table 10. ACK NAK Timeout Value Setting Examples

STEP	ACTION	EXAMPLES			
1	Desired Setting	200ms	1,000ms (1 sec.)	5200ms (5.2 sec.)	15,000ms (1 sec.)
2	Divide by 200	01	05	26	75
3	Scan ENTER/EXIT PROGRAMMING MODE				
4	Scan SELECT ACK NAK TIMEOUT VALUE SETTING				
5	Scan Two Characters From Appendix E, Keypad	'0' and '1'	'0' and '5'	'2' and '6'	'7' and '5'
7	Scan ENTER/EXIT PROGRAMMING MODE				

ACK NAK Timeout Value – cont.

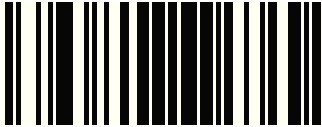
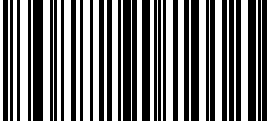
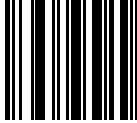
 ENTER/EXIT PROGRAMMING MODE	
 Select ACK NAK Timeout Value Setting	
Make a mistake? Scan the CANCEL barcode to abort and not save the entry string. You can then start again at the beginning.	 CANCEL



01 ACK NAK Timeout value is 200ms

ACK NAK Retry Count

This feature specifies the number of times the reader retries a label transmission due to a retry condition. The selectable range is from 1 to 254 retries. A selection of 0 disables the count, and a selection of 255 specifies unlimited retries.

To set this feature:

1. Determine the desired setting.
2. Pad the number with leading zeroes to yield three digits. For example: 0 = 000, 5 = 005, 20 = 020, etc.
3. Scan the ENTER/EXIT PROGRAMMING MODE barcode to enter Programming Mode.
4. Scan the barcode: SELECT ACK NAK RETRY COUNT SETTING.
5. Scan the appropriate three digits from the keypad in [Appendix E, Keypad](#), that represent the number which was determined in the steps above. You will hear a two-beep indication after the last character.



If you make a mistake before the last character, scan the CANCEL barcode to abort and not save the entry string. You can then start again at the beginning.

NOTE

6. Scan the ENTER/EXIT PROGRAMMING MODE barcode to exit Programming Mode.

This completes the procedure. See [Table 11](#) for some examples of how to set this feature.

Table 11. ACK NAK Retry Count Setting Examples

STEP	ACTION	EXAMPLES			
1	Desired Setting	Disable Retry Count	3 Retries	54 Retries	Unlimited Retries
2	Pad with leading zero(es)	000	003	054	255
3	Scan ENTER/EXIT PROGRAMMING MODE				
4	Scan SELECT ACK NAK RETRY COUNT SETTING				
5	Scan Three Characters From Appendix E, Keypad	'0', '0' and '0'	'0', '0' and '3'	'0', '5' and '4'	'2', '5' and '5'
6	Scan ENTER/EXIT PROGRAMMING MODE				

ACK NAK Retry Count — cont.

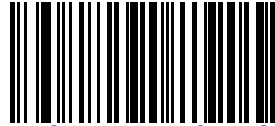
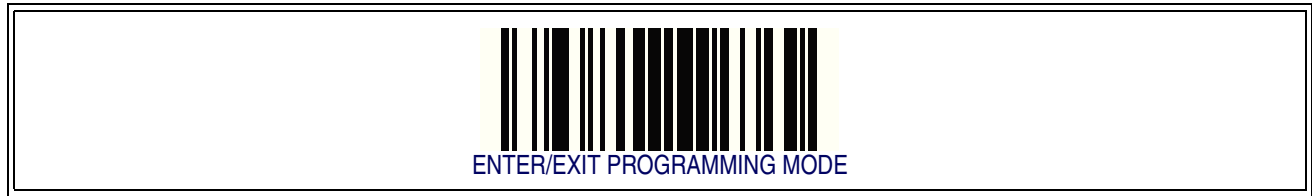

Select ACK NAK Retry Count Setting

Make a mistake? Scan the CANCEL barcode to abort and not save the entry string. You can then start again at the beginning.

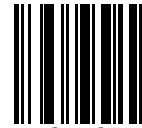

CANCEL



003 = 3 Retries

ACK NAK Error Handling

This feature specifies the method the reader uses to handle receive errors detected while waiting for an ACK character from the host.

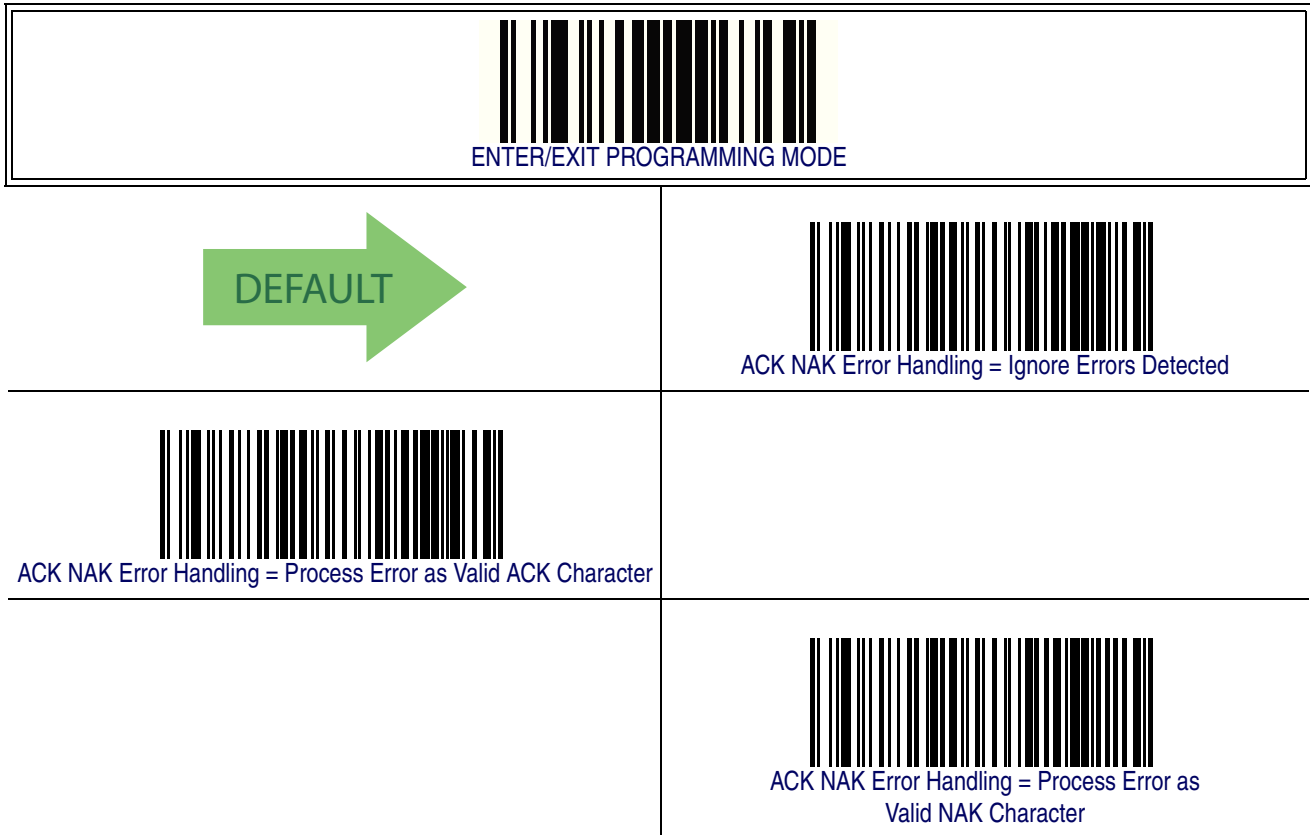

Options are:

- Ignore errors detected
- Process error as valid ACK character
- Process error as valid NAK character

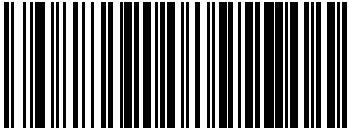
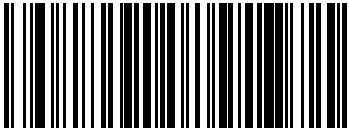

Indicate Transmission Failure

This option enables/disables the reader's ability to sound an error beep to indicate a transmission failure while in ACK/NAK mode.

 ENTER/EXIT PROGRAMMING MODE	
	 Indicate Transmission Failure = Disable Indication
 Indicate Transmission Failure = Enable Indication	

Disable Character

Specifies the value of the RS-232 host command used to disable the reader. ASCII characters or any hex value from 0 to 0xFF can be selected.



NOTE

Setting to previously defined characters such as XON, XOFF, or host commands conflicts with normal operation of these characters. 8-bit data is not recognized when the option [Data Bits](#) has been set as 7 Data Bits.

To set the value:

1. Determine the desired character or value. A setting of 0xFF indicates the the Disable Character is not used (not available).
2. Use the [ASCII Chart](#) on the inside back cover of this manual to find the hex equivalent for the desired character/value.
3. Scan the ENTER/EXIT PROGRAMMING MODE barcode to enter Programming Mode.
4. Scan the barcode: SELECT DISABLE CHARACTER SETTING.
5. Scan the appropriate two alpha-numeric characters from the keypad in [Appendix E, Keypad](#), that represent the desired character/value in step 1 above. The second character will cause a two-beep indication.
6. Scan the ENTER/EXIT PROGRAMMING MODE barcode to exit Programming Mode.

This completes the procedure. See [Table 12](#) for some examples of how to set this feature.

Table 12. Disable Character Setting Examples

STEP	ACTION	EXAMPLES			
1	Desired character/value	'd'	'j'	'D'	Disable Command Not Used
2	Hex equivalent	0x64	0x7D	0x44	0xFF
3	Scan ENTER/EXIT PROGRAMMING MODE				
4	Scan SELECT DISABLE CHARACTER VALUE SETTING				
5	Scan Two Characters From Appendix E, Keypad	'6' and '4'	'7' and 'D'	'4' and '4'	'F' AND 'F'
6	Scan ENTER/EXIT PROGRAMMING MODE				

Disable Character – cont.

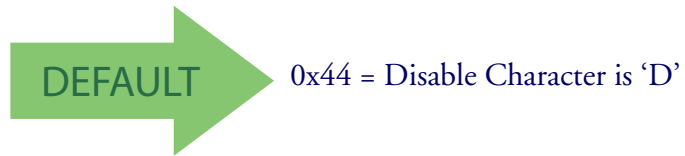
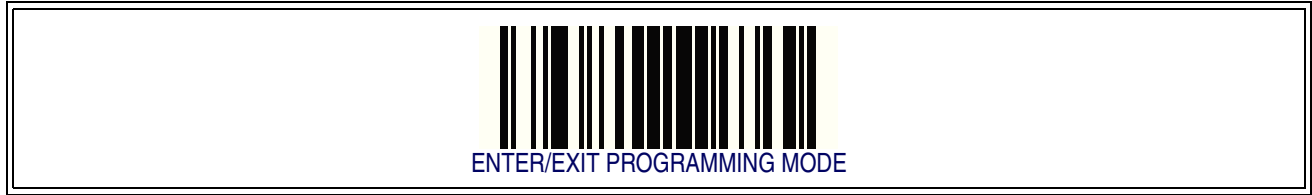

Enable Character

Specifies the value of the RS-232 host command used to enable the reader. ASCII characters or any hex value from 0 to 0xFF can be selected.



NOTE

Setting to previously defined characters such as XON, XOFF, or host commands conflicts with normal operation of these characters. 8-bit data is not recognized when the option [Data Bits](#) has been set as 7 Data Bits.

To set this feature:

Determine the desired character or value. A setting of 0xFF indicates the the Enable Character is not used (not available).

1. Determine the desired character or value.
2. Use the [ASCII Chart](#) on the inside back cover of this manual to find the hex equivalent for the desired character/value.
3. Scan the ENTER/EXIT PROGRAMMING MODE barcode to enter Programming Mode.
4. Scan the barcode: SELECT ENABLE CHARACTER SETTING.
5. Scan the appropriate two alpha-numeric characters from the keypad in [Appendix E, Keypad](#), that represent the desired character/value in step 2 above. The second character will cause a two-beep indication.
6. Scan the ENTER/EXIT PROGRAMMING MODE barcode to exit Programming Mode.

This completes the procedure. See [Table 13](#) for some examples of how to set this feature.

Table 13. Enable Character Setting Examples

STEP	ACTION	EXAMPLES			
1	Desired character/value	'e'	'}'	'E'	Enable Command Not Used
2	Hex equivalent	0x65	0x7D	0x45	0xFF
3	Scan ENTER/EXIT PROGRAMMING MODE				
4	Scan SELECT DISABLE CHARACTER VALUE SETTING				
5	Scan Two Characters From Appendix E, Keypad	'6' and '5'	'7' and 'D'	'4' and '5'	'F' AND 'F'
6	Scan ENTER/EXIT PROGRAMMING MODE				

Enable Character – cont.

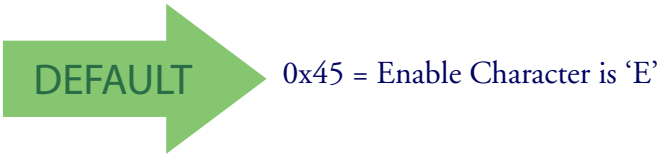
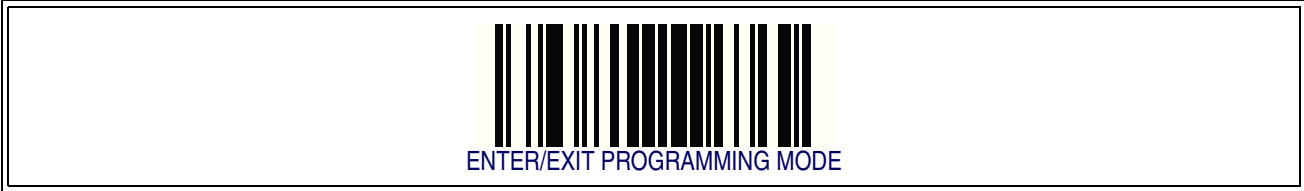

NOTES

Chapter 7

Keyboard Interface

Introduction

Use the programming barcodes in this chapter to select options for USB Keyboard and Wedge Interfaces.

Standard Factory Settings

Reference [Appendix B, Standard Defaults](#) for a listing of standard factory settings.

Scancode Tables

Information about control character emulation which applies to keyboard interfaces is listed in [Appendix F, Scancode Tables](#).

Country Mode

This feature specifies the country/language supported by the keyboard. Only the following interfaces support ALL Country Modes.

- USB Keyboard (without alternate key encoding)
- AT, PS/2 25-286, 30-286, 50, 50Z, 60, 70, 80, 90 & 95 w/Std Key Encoding
- Keyboard Wedge for IBM AT PS2 with standard key encoding but without external keyboard
- AT, PS/2 25-286, 30-286, 50, 50Z, 60, 70, 80, 90 & 95 without Alternate Key
- Keyboard Wedge for IBM AT PS2 without alternate key encoding but without external keyboard

All other interfaces support ONLY the following Country Modes: U.S., Belgium, Britain, France, Germany, Italy, Spain, Sweden.

 ENTER/EXIT PROGRAMMING MODE	
	 Country Mode = U.S.
 Country Mode = Belgium	
	 Country Mode = Britain
 Country Mode = Croatia	Supports only the interfaces listed in theCountry Mode feature description.
Supports only the interfaces listed in theCountry Mode feature description.	 Country Mode = Czechoslovakia

Country Mode — continued

 ENTER/EXIT PROGRAMMING MODE	
 Country Mode = Denmark	Supports only the interfaces listed in theCountry Mode feature description.
	 Country Mode = France
 Country Mode = Germany	
Supports only the interfaces listed in theCountry Mode feature description.	 Country Mode = Hungary
 Country Mode = Italy	
Supports only the interfaces listed in theCountry Mode feature description.	 Country Mode = Japanese 106-key
 Country Mode = Norway	Supports only the interfaces listed in theCountry Mode feature description.

Country Mode – continued

 ENTER/EXIT PROGRAMMING MODE	
 Country Mode = Poland	Supports only the interfaces listed in theCountry Mode feature description.
Supports only the interfaces listed in theCountry Mode feature description.	 Country Mode = Portugal
 Country Mode = Romania	Supports only the interfaces listed in theCountry Mode feature description.
Supports only the interfaces listed in theCountry Mode feature description.	 Country Mode = Slovakia
 Country Mode = Spain	
	 Country Mode = Sweden
 Country Mode = Switzerland	Supports only the interfaces listed in theCountry Mode feature description.

Caps Lock State

This option specifies the format in which the reader sends character data. This applies to keyboard wedge interfaces. This does not apply when an alternate key encoding keyboard is selected.

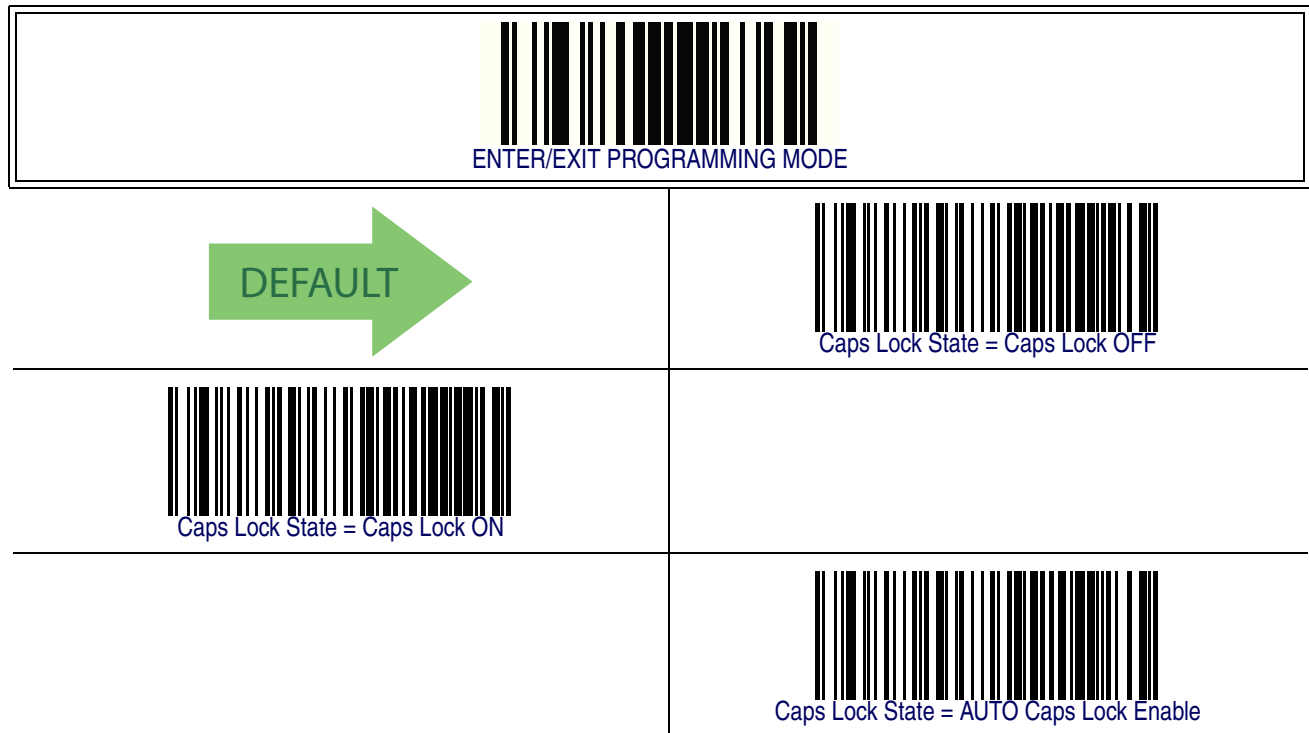

Numlock

This option specifies the setting of the Numbers Lock (Numlock) key while in keyboard wedge interface. This only applies to alternate key encoding interfaces. It does not apply to USB keyboard.

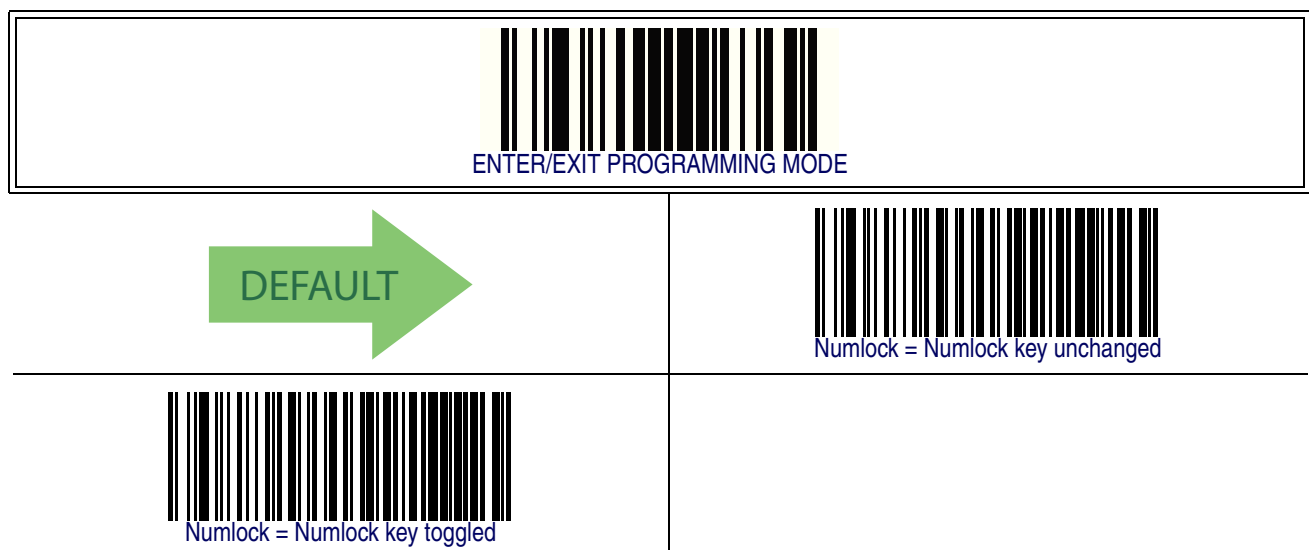

Send Control Characters

This feature Specifies how the reader transmits ASCII control characters to the host. Reference [Appendix F, Scancode Tables](#) for more information about control characters.

Options are as follows:

Control Character 00 – Characters from 00 to 0x1F are sent as control character Ctrl+Keys, special keys are located from 0x80 to 0xA1.

Control Character 01 – Characters from 00 to 0x1F are sent as control character Ctrl+Capital Key, special keys are located from 0x80 to 0xA1.

Control Character 02 – Special keys are located from 00 to 0x1F and characters from 0x80 to 0xFE are intended as an extended ASCII table (Microsoft Windows Codepage 1252 — see [Microsoft Windows Codepage 1252 on page 410](#)).



Wedge Quiet Interval

This option specifies the amount of time to look for keyboard activity before the reader breaks the keyboard connection in order to transmit data to host. The selectable range for this feature is from 0 to 990ms in 10ms increments.



This feature applies **ONLY** to the Keyboard Wedge interface.

NOTE

Follow these instructions to set this feature:

1. Determine the desired setting in milliseconds.
2. Divide the desired setting by 10 (setting is in 10ms increments). Pad the result with leading zeroes to yield two digits. For example: 0 = 00, 5 = 05, 20 = 20, etc.
3. Scan the ENTER/EXIT PROGRAMMING MODE barcode to enter Programming Mode.
4. Scan the barcode: SELECT WEDGE QUIET INTERVAL SETTING.
5. Scan the appropriate two digits from the keypad in [Appendix E, Keypad](#), that represent the duration which was determined in the steps above. You will hear a two-beep indication after the last character.



If you make a mistake before the last character, scan the **CANCEL** barcode to abort and not save the entry string. You can then start again at the beginning.

NOTE

6. Scan the ENTER/EXIT PROGRAMMING MODE barcode to exit Programming Mode.

This completes the procedure to set the Wedge Quiet Interval. See [Table 14](#) for some examples of how to set this feature.

Table 14. Timeout Setting Examples

STEP	ACTION	EXAMPLES			
1	Desired Setting	10ms	150ms	600ms	850ms
2	Divide by 10 (and pad with leading zeroes)	01	15	60	85
3	Scan ENTER/EXIT PROGRAMMING MODE				
4	Scan SELECT WEDGE QUIET INTERVAL SETTING				
5	Scan Two Characters From Appendix E, Keypad	'0' and '1'	'1' and '5'	'6' and '0'	'8' and '5'
6	Scan ENTER/EXIT PROGRAMMING MODE				

Wedge Quiet Interval – cont.

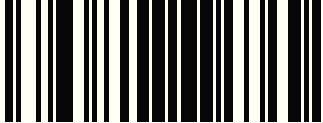
 ENTER/EXIT PROGRAMMING MODE
--

 Select Wedge Quiet Interval Setting
--

--

Make a mistake? Scan the CANCEL barcode to abort and not save the entry string. You can then start again at the beginning.

 CANCEL

 10 = Quiet Interval of 100 ms

Intercharacter Delay

This parameter specifies the intercharacter delay between the end of one character and the beginning of the next. The delay can be set within a range of zero (0) to 990 milliseconds in 10ms increments. A setting of zero specifies no delay.



This feature applies **ONLY** to the Keyboard Wedge interface.

NOTE

To set the delay:

1. Determine the desired setting in milliseconds.
2. Divide the desired setting by 10 (setting is in 10ms increments). Pad the result with leading zeroes to yield two digits. For example: 0 = 00, 5 = 05, 20 = 20, etc.
3. Scan the ENTER/EXIT PROGRAMMING MODE barcode to enter Programming Mode.
4. Scan the barcode: SELECT INTERCHARACTER DELAY SETTING.
5. Scan the appropriate two digits from the keypad in [Appendix E, Keypad](#), that represent the duration which was determined in the steps above. You will hear a two-beep indication after the last character.



If you make a mistake before the last character, scan the **CANCEL** barcode to abort and not save the entry string. You can then start again at the beginning.

NOTE



6. Scan the ENTER/EXIT PROGRAMMING MODE barcode to exit Programming Mode.

This completes the procedure. See [Table 14](#) for some examples of how to set this feature.

Table 15. Intercharacter Delay Setting Examples

STEP	ACTION	EXAMPLES			
1	Desired Setting	50ms	150ms	600ms	850ms
2	Divide by 10 (and pad with leading zeroes to yield two-digits)	05	15	60	85
3	Scan ENTER/EXIT PROGRAMMING MODE				
4	Scan SELECT INTERCHARACTER DELAY SETTING				
5	Scan Two Characters From Appendix E, Keypad	'0' and '5'	'1' and '5'	'6' and '0'	'8' and '5'
6	Scan ENTER/EXIT PROGRAMMING MODE				

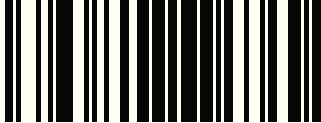
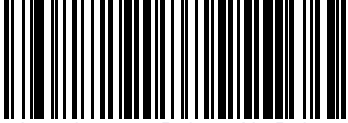
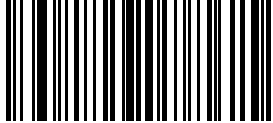
Intercharacter Delay – cont.

 ENTER/EXIT PROGRAMMING MODE	
	 Intercharacter Delay = No Delay
 Select Intercharacter Delay Setting	
Make a mistake? Scan the CANCEL barcode to abort and not save the entry string. You can then start again at the beginning.	 CANCEL

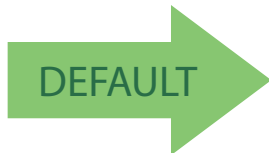

00 = No Intercharacter Delay

Intercode Delay

Specifies the delay between labels transmitted to the host for this interface. The selectable range for this feature is from 0 to 99 seconds.

Follow these instructions to set this feature:

1. Determine the desired setting.
2. Pad the number with leading zeroes to yield two digits. For example: 0 = 00, 5 = 05, 20 = 20, etc
3. Scan the ENTER/EXIT PROGRAMMING MODE barcode to enter Programming Mode.
4. Scan the barcode: SELECT INTERCODE DELAY SETTING.
5. Scan the appropriate two digits from the keypad in [Appendix E, Keypad](#), that represent the duration which was determined in the steps above. You will hear a two-beep indication after the last character.



If you make a mistake before the last character, scan the CANCEL barcode to abort and not save the entry string. You can then start again at the beginning.

NOTE

6. Scan the ENTER/EXIT PROGRAMMING MODE barcode to exit Programming Mode.

This completes the procedure. See [Table 16](#) for some examples of how to set this feature.

Table 16. Wedge Intercode Delay Examples

STEP	ACTION	EXAMPLES			
1	Desired Setting	No Delay	5 Seconds	60 Seconds	99 Seconds
2	Pad with leading zero(es)	00	05	60	99
3	Scan ENTER/EXIT PROGRAMMING MODE				
4	Scan SELECT INTERCODE DELAY SETTING				
5	Scan Two Characters From Appendix E, Keypad	'0' and '0'	'0' and '5'	'6' and '0'	'9' AND '9'
7	Scan ENTER/EXIT PROGRAMMING MODE				

Intercode Delay – cont.

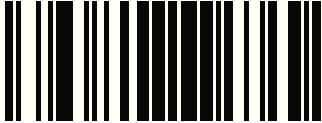
 ENTER/EXIT PROGRAMMING MODE
--

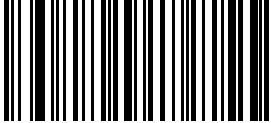
 Set Intercode Delay	
--	--

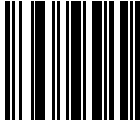
Make a mistake? Scan the CANCEL barcode to abort and not save the entry string. You can then start again at the beginning.	 CANCEL
--	---

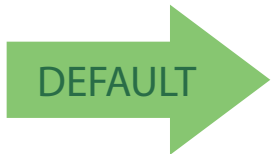
 00 = No Wedge Intercode Delay

USB Keyboard Speed

This option specifies the USB poll rate for a USB keyboard.





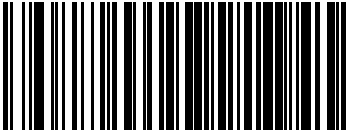

This feature applies **ONLY** to the USB Keyboard interface.

NOTE

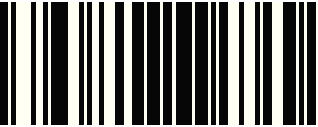
 ENTER/EXIT PROGRAMMING MODE	
 DEFAULT	 USB Keyboard Speed = 1ms
 USB Keyboard Speed = 2ms	
	 USB Keyboard Speed = 3ms
 USB Keyboard Speed = 4ms	
	 USB Keyboard Speed = 5ms

USB Keyboard Speed – continued

 ENTER/EXIT PROGRAMMING MODE	
 USB Keyboard Speed = 6ms	
	 USB Keyboard Speed = 7ms
 USB Keyboard Speed = 8ms	
	 USB Keyboard Speed = 9ms
 USB Keyboard Speed = 10ms	

Chapter 8

USB-OEM Interface

Introduction

Feature settings for USB interfaces differ depending upon which host type the reader will be connected with. Use the feature settings in this chapter and [Chapter 9, IBM 46XX Interface](#) to specifically configure for the USB-OEM interface. Other USB interfaces are included in the appropriate chapter for their host type.

Standard Factory Settings

Reference [Appendix B, Standard Defaults](#) for a listing of standard factory settings.

USB-OEM Device Usage

The USB-OEM protocol allows for the reader to be identified as one of two different types of barcode scanners. Depending on what other scanners you may already have connected to a USB-OEM POS, you may need to change this setting to enable all devices to communicate.

Options are:

- Table Top Scanner
- Handheld Scanner



It may be necessary to switch device usage when connecting two readers/scanners of the same type to a POS system.

NOTE



USB-OEM Interface Options

This setting provides for an interface specific control mechanism..
Options are:

- Obey — Obey Scanner Configuration Host Commands
- Ignore — Ignore Scanner Configuration Host Commands



NOTES

Chapter 9

IBM 46XX Interface

Introduction

Use the barcodes in this section to configure programmable features for available IBM 46XX interfaces.

IBM Standard Factory Settings





Reference [Appendix B, Standard Defaults](#) for a listing of standard factory settings.

46xx Number of Host Resets

Specifies how many consecutive resets are processed before the reader starts a five-second period to allow the user to enter Programming Mode and configure the reader. The configurable range for this feature is 1 to 15 resets.

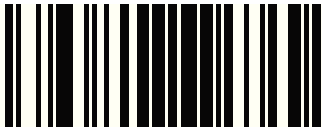
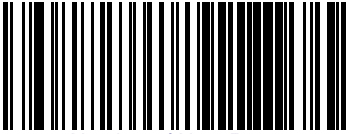
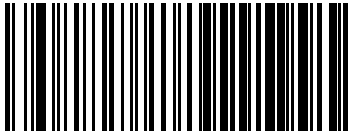
 ENTER/EXIT PROGRAMMING MODE	
	 46xx Number of Host Resets = 1
 46xx Number of Host Resets = 2	
	 46xx Number of Host Resets = 3
 46xx Number of Host Resets = 4	
	 46xx Number of Host Resets = 5
 46xx Number of Host Resets = 6	 DEFAULT

46xx Number of Host Resets – cont.

 ENTER/EXIT PROGRAMMING MODE	
	 46xx Number of Host Resets = 7
 46xx Number of Host Resets = 8	
	 46xx Number of Host Resets = 9
 46xx Number of Host Resets = 10	
	 46xx Number of Host Resets = 11
 46xx Number of Host Resets = 12	

46xx Number of Host Resets – cont.

 ENTER/EXIT PROGRAMMING MODE	
	 46xx Number of Host Resets = 13
 46xx Number of Host Resets = 14	
	 46xx Number of Host Resets = 15

Transmit Labels in Code 39 Format

This feature enable/disables translation to Code 39 before transmitting label data to an IBM-46XX or a USB-OEM host. Only the symbology identifier is modified for the translation. The data is not converted to Code 39 or verified to be valid for Code 39.

Options are:

IBM Standard Format – Send labels in standard IBM format.

Code 39 Format – Translate the following symbologies to Code 39:

- USB-OEM: Code128, Code 93, and Codabar
- IBM-Port 5B: Code 128, Code 93, and Codabar
- IBM-Port 9B: Code 93 and Codabar

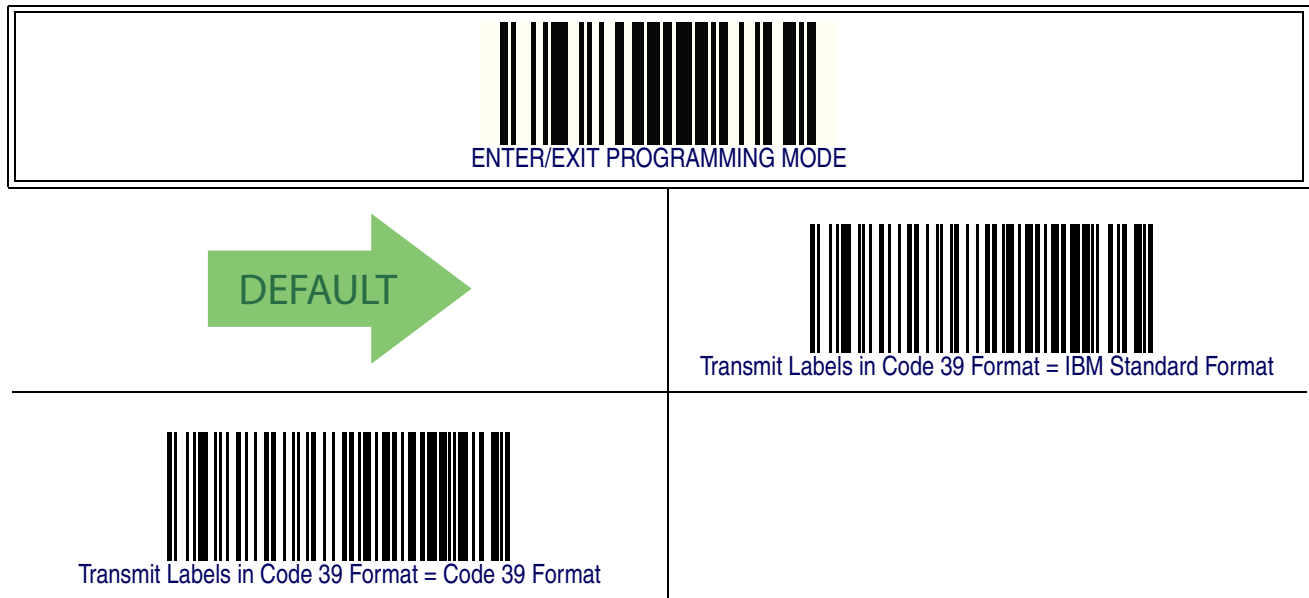

IBM 46XX Interface Options

This setting provides for an interface specific control mechanism..
Options are:

- Obey — Obey Scanner Configuration Host Commands
- Ignore — Ignore Scanner Configuration Host Commands



Chapter 10

Wand Emulation Interface

Introduction

This chapter provides feature/settings configuration for the Wand Emulation interface.

Wand Emulation Standard Factory Settings

Reference [Appendix B, Standard Defaults](#) for a listing of standard factory settings.

Wand Idle State

This feature specifies the level of the Wand output signal when the reader is idle.



NOTE

TTL logic levels:
0V <= Low <= 0.7V
2.4V <= High <= 5.25V

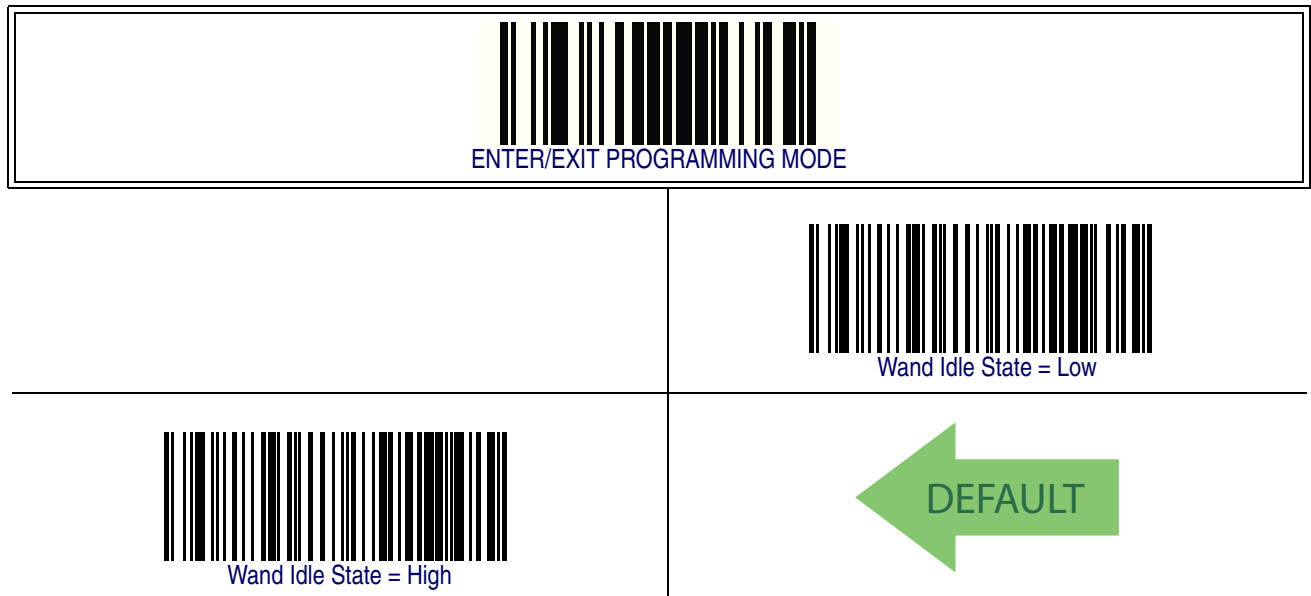

Wand Polarity

This option specifies the polarity of the Wand output signal. Choices are:

- Quiet zones and spaces are high, bars are low
- Quiet zones and spaces are low, bars are high



NOTE

TTL logic levels:
0V <= Low <= 0.7V
2.4V <= High <= 5.25V

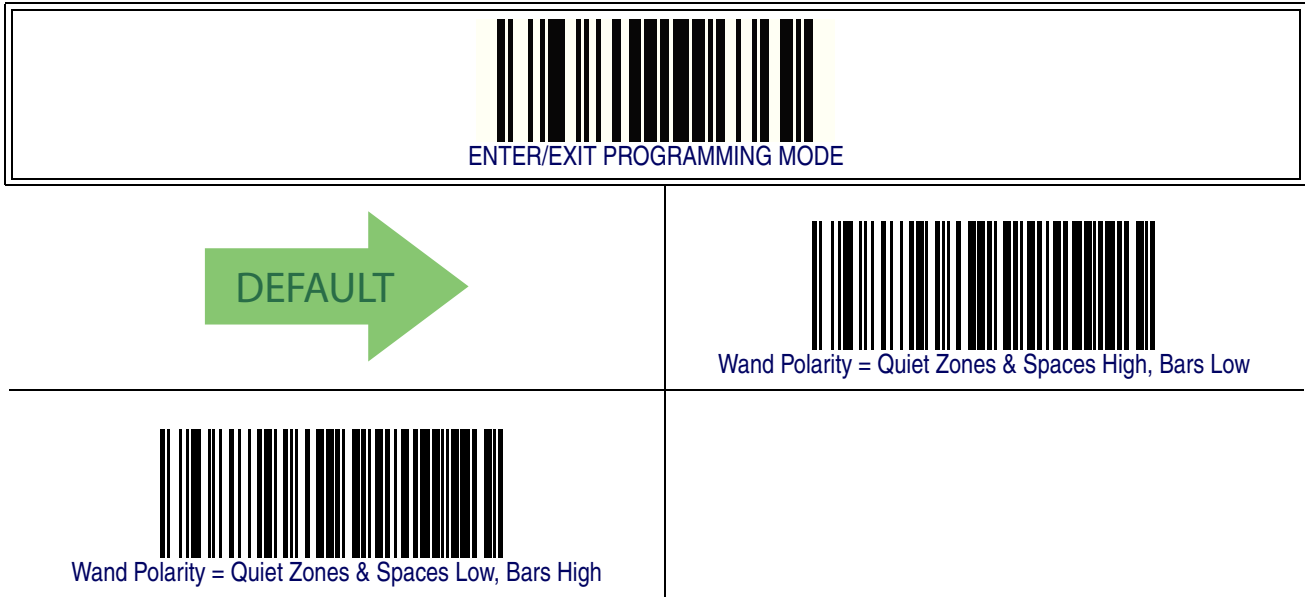

Wand Signal Speed

This feature specifies the speed of the Wand output signal per nominal bar or space. Choices are:

- 330 microseconds
- 660 microseconds



Label Symbology Conversion

When this feature is enabled for the Wand Emulation interface, all barcode labels are converted to a single symbology.

Options are:

- No conversion
- Convert to Code 39 symbology
- Convert to Code 39 Full ASCII
- Convert to Code 128 symbology



Transmit Noise

This option specifies the leading/trailing noise for the Wand interface.
 Choices are:

- Disable (no leading/trailing noise)
- Enable leading noise
- Enable trailing noise
- Enable leading and trailing noise



NOTES

Chapter 11

Data Editing

Data Editing Overview



It is not recommended to use these features with IBM interfaces.

CAUTION

When a barcode is scanned, additional information can be sent to the host computer along with the barcode data. This combination of barcode data and supplementary user-defined data is called a “message string.” The features in this chapter can be used to build specific user-defined data into a message string.

There are several types of selectable data characters that can be sent before and after scanned data. You can specify if they should be sent with all symbologies, or only with specific symbologies. [Figure 4](#) shows the available elements you can add to a message string:

Figure 4. Breakdown of a Message String

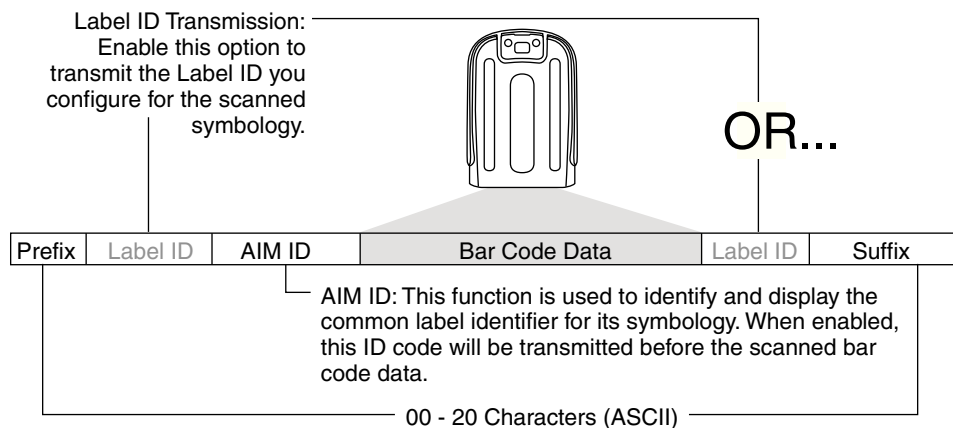

NOTE

Additional advanced editing is available. See the Advanced Formatting features in the Datalogic Aladdin Configuration Application or contact [Technical Support](#) on [page 3](#) for more information.

Please Keep In Mind...

- Modifying a message string is not a mandatory requirement. Data editing is sophisticated feature allowing highly customizable output for advanced users. Factory default settings for data editing is typically set to NONE.
- A prefix or suffix may be applied (reference the [Symbologies](#) chapter for these settings) across all symbologies (set via the Global features in this chapter).
- You can add any character from the [ASCII Chart](#) (from 00-FF) on the inside back cover of this manual as a prefix, suffix or Label ID.
- Enter prefixes and suffixes in the order in which you want them to appear on the output.

Global Prefix/Suffix

Up to 20 ASCII characters may be added as a prefix (in a position before the barcode data) and/or as a suffix (in a position following the barcode data) as indicated in [Figure 5](#).

Figure 5. Prefix and Suffix Positions

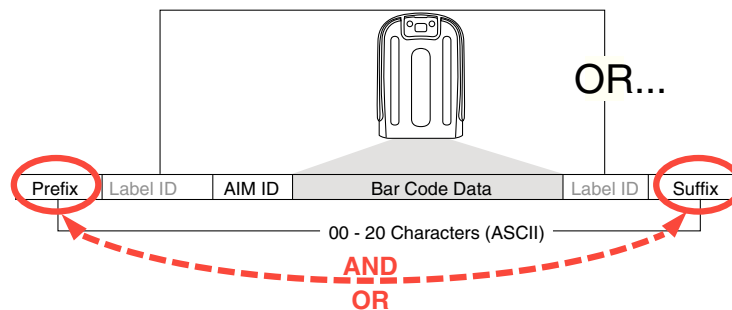

Example: Setting a Prefix

In this example, we'll set a prefix for all symbologies.

1. Determine which ASCII character(s) are to be added to scanned barcode data. In this example, we'll add a dollar sign ('\$') as a prefix.
2. Scan the ENTER/EXIT barcode.
3. Scan the SET GLOBAL PREFIX barcode.
4. Reference the ASCII Chart on the inside back cover of this manual, to find the hex value assigned to the desired character. The corresponding hex number for the '\$' character is 24. To enter this selection code, scan the '2' and '4' barcodes from [Appendix E, Keypad](#).



NOTE

If you make a mistake before the last character, scan the CANCEL barcode to abort and not save the entry string. You can then start again at the beginning.



5. If less than the expected string of 20 characters are selected, scan the ENTER/EXIT barcode to terminate the string.

6. Scan the ENTER/EXIT barcode once again to exit Programming Mode.
7. The resulting message string would appear as follows:

Scanned barcode data:12345

Resulting message string output: \$12345

This option sets up to 20 characters each from the set of ASCII characters or any hex value from 00 to FF. To configure this feature, scan the ENTER/EXIT barcode to place the unit in Programming Mode, then the “Set Global Prefix” or “Set Global Suffix,” barcode followed by the digits (in hex) from the Alphanumeric characters in [Appendix E, Keypad](#) representing your desired character(s). If less than the expected string of 20 characters are selected, scan the ENTER/EXIT barcode to terminate the string. Reference the section, [Example: Setting a Prefix on page 104](#), for more information. Exit programming mode by scanning the ENTER/EXIT barcode once again.

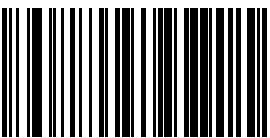
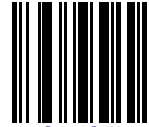
 ENTER/EXIT PROGRAMMING MODE	
	 Set Global Prefix
 Set Global Suffix	
<p>Make a mistake? Scan the CANCEL barcode to abort and not save the entry string. You can then start again at the beginning.</p>	
 CANCEL	

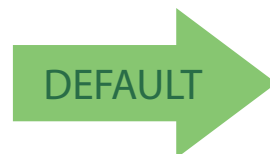

No Global Prefix
Global Suffix = 0x0D (CR)

Global AIM ID



This feature enables/disables addition of AIM IDs for all symbology types.

NOTE

AIM label identifiers (as opposed to custom characters you select yourself as with label identifiers) can be included with scanned barcode data. AIM label identifiers consist of three characters as follows:

- A close brace character (ASCII '['), followed by...
- A code character (see the table below), followed by...
- A modifier character (the modifier character is symbol dependent).

SYMBOLGY	CHAR	SYMBOLGY	CHAR
UPC/EAN	E ^a	Code 128/GS1-128	C
Code 39 and Code 32	A	GS1 DataBar Omnidirectional, GS1 DataBar Expanded	e
Codabar	F	Standard 2 of 5	S
Interleaved 2 of 5	I	ISBN	X ^b
Code 93	G	Code 11	H

^{a.} UPC-A and UPC-E labels are converted to EAN 13 when adding AIM IDs.

^{b.} ISBN (X with a 0 modifier character)

Figure 6. AIM ID

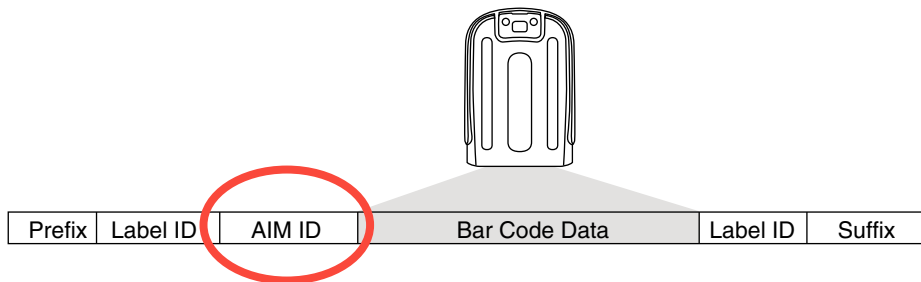

Global AIM ID – continued

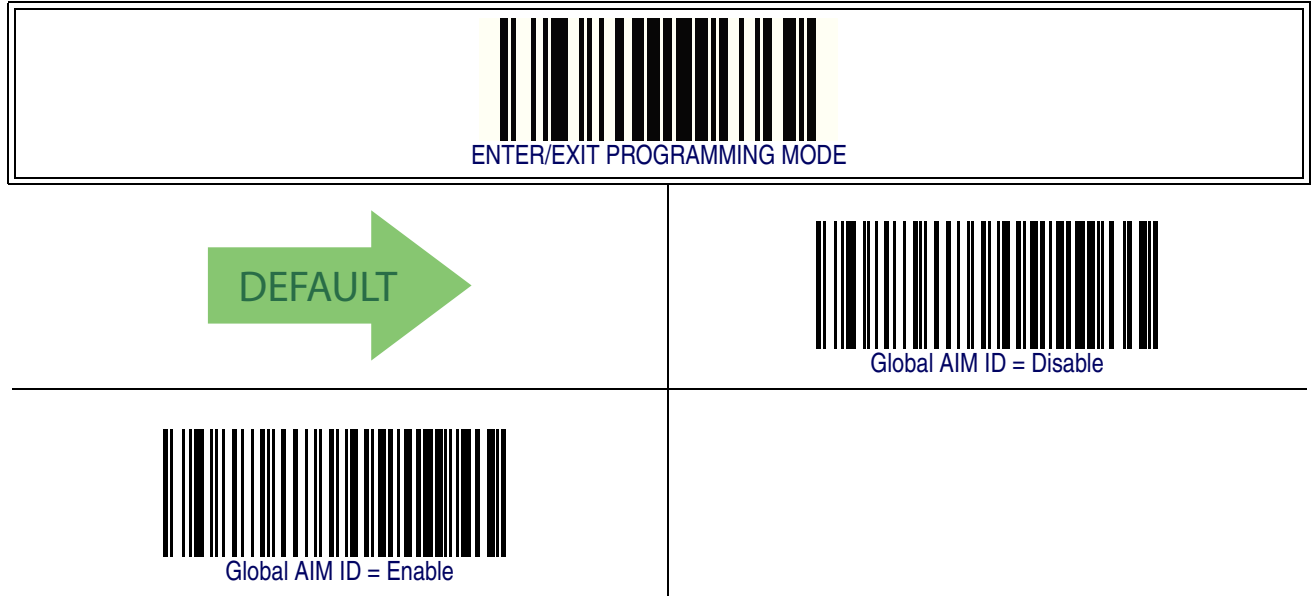

GS1-128 AIM ID

If Global AIM ID is disabled, the AIM ID for GS1-128 can be enabled/disabled independently. The AIM ID for GS1-128 is a]C1,]C2 or]C3. AIM IDs for other symbologies can be enabled/disabled independently as well. Contact Customer Support for assistance.



Label ID

A Label ID is a customizable code of up to three ASCII characters (each can be one of hex 0x01-0xFF), used to identify a barcode (symbology) type. It can be appended previous to or following the transmitted barcode data depending upon how this option is enabled. This feature provides options for configuring custom Label IDs as a pre-loaded set (see [Label ID Pre-loaded Sets on page 110](#)) or individually per symbology (see [Label ID: Set Individually Per Symbology on page 112](#)). If you wish to program the reader to always include an industry standard label identifier for ALL symbology types, see the previous feature [Global AIM ID on page 106](#).

Label ID: Pre-loaded Sets

The reader supports two pre-loaded sets of Label IDs. [Table 17](#) shows the USA set and the EU set.



CAUTION

When changing from one Label ID set to another, all other imager configuration settings, including the host interface type, will be erased and set to the factory defaults. Any custom configuration or custom defaults will be lost.

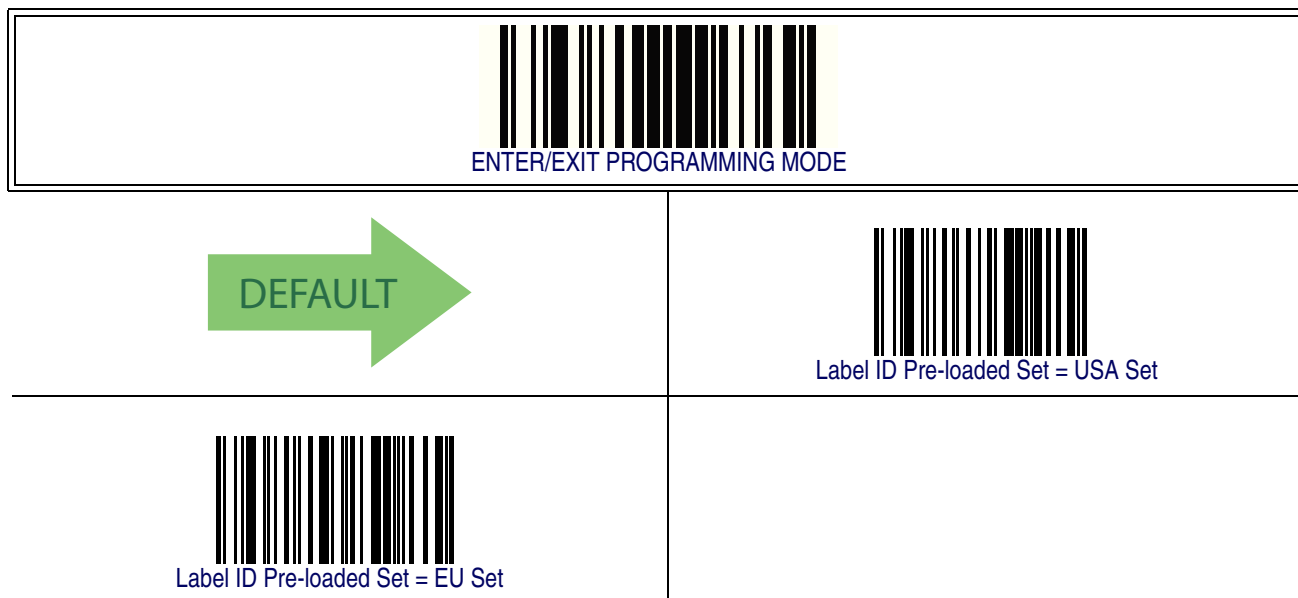

Table 17. Label ID Pre-loaded Sets

Symbology	USA Label ID set		EU Label ID set	
	ASCII character	Hex value	ASCII character	Hexidecimal value
ABC Codabar	S	530000	S	530000
Anker Plessey	o	6F0000	o	6F0000
CODABAR	%	250000	R	520000
Codablock F	l	6C0000	m	6D0000
Code 39 CIP	Y	590000	Y	590000
Code 93	&	260000	U	550000
CODE11	CE	434500	b	620000
CODE128	#	230000	T	540000
CODE32	A	410000	X	580000
CODE39	*	2A0000	V	560000
CODE4	4	340000	4	340000
CODE5	j	6A0000	j	6A0000
CODE93	&	260000	U	550000
DATALOGIC 2OF5	s	730000	s	730000
EAN13	F	460000	B	420000
EAN13 P2	F	460000	L	4C0000
EAN13 P5	F	460000	M	4D0000
EAN13 P8	F	460000	#	230000
EAN8	FF	464600	A	410000
EAN8 P2	FF	464600	J	4A0000
EAN8 P5	FF	464600	K	4B0000
EAN8 P8	FF	464600	*	2A0000
FOLLETT 2OF5	O	4F0000	O	4F0000
GS1 DATABAR EXPANDED	RX	525800	t	740000
GS1 DATABAR LIMITED	RL	524C00	v	760000
GS1 DATABAR OMNIDIRECTIONAL	R4	523400	u	750000
GS1-128		000000	k	6B0000
GTIN	G	470000	\$A	244100
GTIN2	G2	473200	\$B	244200

Symbology	USA Label ID set		EU Label ID set	
GTIN5	G5	473500	\$C	244300
GTIN8	G8	473800	\$D	244400
I2OF5	i	690000	N	4E0000
IATA	IA	494100	&	260000
Industrial 2 of 5	W	570000	W	570000
Interleaved 2 of 5 CIP HR	e	650000	e	650000
ISBN	l	490000	@	400000
ISBT128	f	660000	f	660000
ISSN	n	6E0000	n	6E0000
MSI	@	400000	Z	5A0000
Plessey	a	610000	a	610000
S25	s	730000	P	500000
UPCA	A	410000	C	430000
UPCA P2	A	410000	F	460000
UPCA P5	A	410000	G	470000
UPCA P8	A	410000	Q	510000
UPCE	E	450000	D	440000
UPCE P2	E	450000	H	480000
UPCE P5	E	450000	I	490000
UPCE P8	E	450000	E	450000

Label ID: Set Individually Per Symbology

To configure a Label ID individually for a single symbology:

1. Scan the ENTER/EXIT barcode.
2. Select Label ID position as either BEFORE (Enable as Prefix) or AFTER (Enable as suffix) by scanning the appropriate barcode in the section [Label ID Control on page 114](#). Reference [Figure 7](#) for Label ID positioning options if multiple identification features are enabled.
3. Scan a barcode to select the symbology for which you wish to configure a custom Label ID from the section [Label ID Symbology Selection, starting on page 115](#).
4. Determine the desired character(s) (you may choose up to three) which will represent the Label ID for the selected symbology.
5. Turn to the [ASCII Chart](#) on the inside back cover of this manual and find the equivalent hex digits associated with your choice of Label ID. For example, if you wish to select an equal sign (=) as a Label ID, the chart indicates its associated hex characters as 3D. Turn to [Keypad, starting on page 395](#) and scan the barcodes representing the hex characters determined. For the example given, the characters '3' and 'D' would be scanned. More examples of Label ID settings are provided in [Table 18](#).



If you make a mistake before the last character, scan the CANCEL barcode to abort and not save the entry string. You can then start again at the beginning.

NOTE

6. Scan the ENTER/EXIT barcode to exit Label ID entry.
7. Scan the ENTER/EXIT barcode once again to exit Programming Mode.

This completes the steps to configure a Label ID for a given symbology.

Figure 7. Label ID Position Options

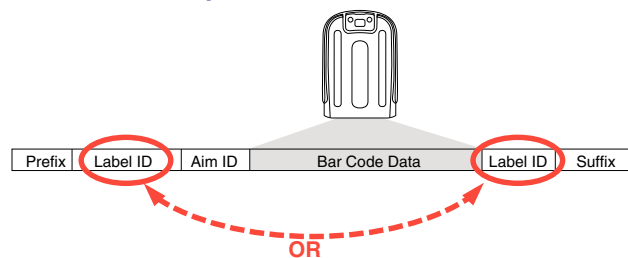

Label ID – continued

Table 18. Label ID Examples

STEP	ACTION	EXAMPLES			
1.	Scan the ENTER/EXIT barcode	(Scanner enters Programming Mode)			
2.	Determine placement of the Label ID characters BEFORE or AFTER with regard to scanned data using Label ID Control on page 114	Enable as Prefix	Enable as Suffix	Enable as Prefix	Enable as Suffix
3.	Scan the barcode selecting the symbology type you wish to designate label ID characters for using Label ID Symbology Selection, starting on page 115.	GS1 DataBar Omnidirectional	Code 39	Interleaved 2 of 5	Code 32
4.	Custom Label ID example (desired characters):	D B *	= C 3	+	P H
5.	Find hex equivalents from the ASCII table (inside back cover), then scan in these digits/characters using the barcodes in the section: Keypad, starting on page 395. If you make a mistake before the last character, scan the CANCEL barcode to abort and not save the entry string. You can then start again at the beginning.	44 42 2A	3D 43 33	2B	50 48
6.	Scan the ENTER/EXIT barcode	(Scanner exits Label ID entry)			
7.	Scan the ENTER/EXIT barcode once again	(Scanner exits Programming Mode)			
Result:		DB*[barcode data]	[barcode data]=C3	+[barcode data]	[barcode data]PH

Label ID – continued

Label ID Control

This option controls whether a Label ID is disabled, or sent as a prefix or suffix for a given symbology type.

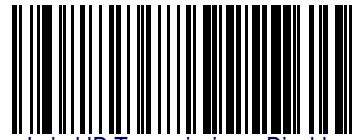
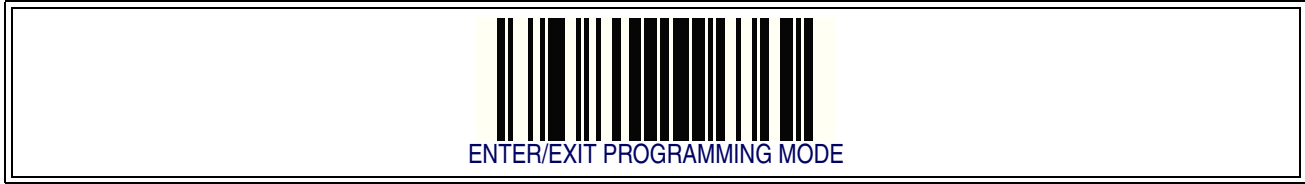

Label ID Transmission = Disable

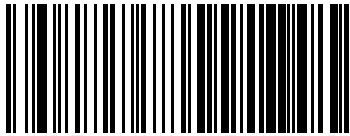

Label ID Transmission = Enable as Prefix

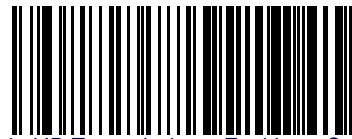

Label ID Transmission = Enable as Suffix

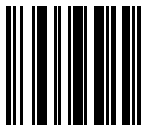

CANCEL

Make a mistake? Scan the CANCEL barcode to abort and not save the entry string. You can then start again at the beginning.

Label ID – continued

Label ID Symbology Selection

This option selects the symbology for which a Label ID is to be configured. See [Label ID on page 109](#) for full instructions.

 ENTER/EXIT PROGRAMMING MODE	
	 Set UPC-A Label ID Character(s)
 Set UPC-A/P2 Label ID Character(s)	
	 Set UPC-A/P5 Label ID Character(s)
 Set UPC-A/GS1-128 Label ID Character(s)	
	 Set UPC-E Label ID Character(s)
 Set UPC-E/P2 Label ID Character(s)	

Label ID – continued

Label ID Symbology Selection – continued

This option selects the symbology for which a Label ID is to be configured. See [Label ID on page 109](#) for full instructions.

 ENTER/EXIT PROGRAMMING MODE	
	 Set UPC-E/P5 Label ID Character(s)
 Set UPC-E/GS1-128 Label ID Character(s)	
	 Set EAN 13 Label ID Character(s)
 Set EAN 13/P2 Label ID Character(s)	
	 Set EAN 13/P5 Label ID Character(s)
 Set EAN 13/GS1-128 Label ID Character(s)	

Label ID – continued

Label ID Symbology Selection – continued

This option selects the symbology for which a Label ID is to be configured. See [Label ID on page 109](#) for full instructions.

 ENTER/EXIT PROGRAMMING MODE	
	 Set EAN 8 Label ID Character(s)
 Set EAN 8/P2 Label ID Character(s)	
	 Set EAN 8/P5 Label ID Character(s)
 Set EAN 8/GS1-128 Label ID Character(s)	
	 Set GTIN Label ID Character(s)
 Set GTIN/P2 Label ID Character(s)	

Label ID – continued

Label ID Symbology Selection – continued

This option selects the symbology for which a Label ID is to be configured. See [Label ID on page 109](#) for full instructions.

 ENTER/EXIT PROGRAMMING MODE	
	 Set GTIN/P5 Label ID Character(s)
 Set GTIN/GS1-128 Label ID Character(s)	
	 Set GS1 DataBar Omnidirectional Label ID Character(s)
 Set GS1 DataBar Expanded Label ID Character(s)	
	 Set GS1 DataBar Limited Label ID Character(s)
 Set Code 39 Label ID Character(s)	

Label ID – continued

Label ID Symbology Selection – continued

This option selects the symbology for which a Label ID is to be configured. See [Label ID on page 109](#) for full instructions.

 ENTER/EXIT PROGRAMMING MODE	
 Set Code 32 Label ID Character(s)	
	 Set Code 39 CIP Label ID Character(s)
 Set Code 128 Label ID Character(s)	
	 Set GS1-128 Label ID Character(s)
 Set Interleaved 2 of 5 Label ID Character(s)	
	 Set Interleaved 2 of 5 CIP HR Label ID Character(s)
 Set Datalogic 2 of 5 Label ID Character(s)	

Label ID — continued

Label ID Symbology Selection — continued

This option selects the symbology for which a Label ID is to be configured. See [Label ID on page 109](#) for full instructions.

 ENTER/EXIT PROGRAMMING MODE	
	 Set Codabar Label ID Character(s)
 Set ABC Codabar Label ID Character(s)	
	 Set Code 11 Label ID Character(s)
 Set Standard 2 of 5 Label ID Character(s)	
	 Set Industrial 2 of 5 Label ID Character(s)
 Set ISSN Label ID Character(s)	

Label ID – continued

Label ID Symbology Selection – continued

This option selects the symbology for which a Label ID is to be configured. See [Label ID on page 109](#) for full instructions.

 ENTER/EXIT PROGRAMMING MODE	
 Set IATA Label ID Character(s)	
	 Set Concatinated ISBT 128 Label ID Character(s)
 Set MSI Label ID Character(s)	
	 Set Plessey Label ID Character(s)
 Set Anker Plessey Label ID Character(s)	
	 Set Code 93 Label ID Character(s)

Label ID – continued

Label ID Symbology Selection – continued

This option selects the symbology for which a Label ID is to be configured. See [Label ID on page 109](#) for full instructions.

 ENTER/EXIT PROGRAMMING MODE	
 Set Codablock F Label ID Character(s)	
	 Set Code 4 Label ID Character(s)
 Set Code 5 Label ID Character(s)	
	 Set Follett 2 of 5 Label ID Character(s)

Case Conversion

This feature allows conversion of the case of all alphabetic characters to upper or lower case.



Case conversion affects **ONLY** scanned barcode data, and does not affect Label ID, Prefix, Suffix, or other appended data.

NOTE

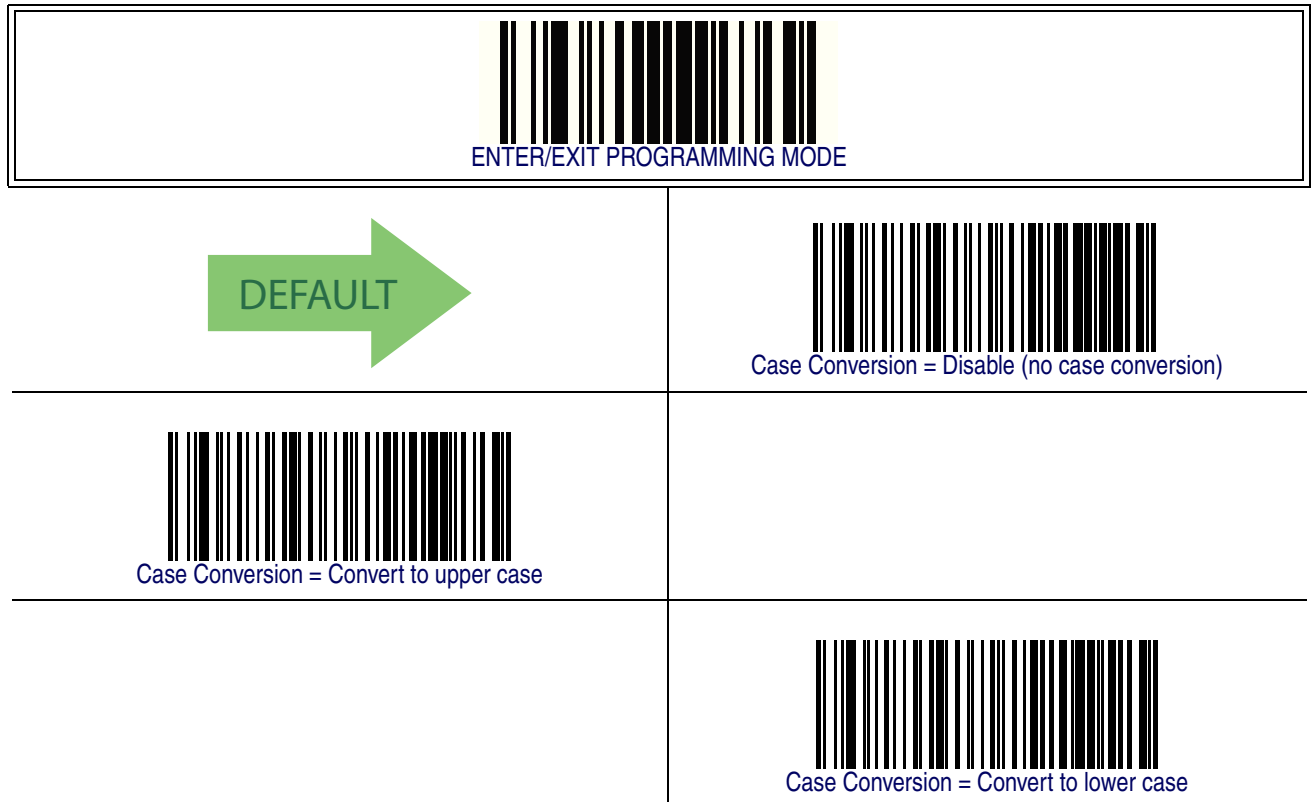

Character Conversion

Character conversion is an eight byte configuration item. The eight bytes are 4 character pairs represented in hexadecimal ASCII values. The first character in the pair is the character that will be converted. The second character in the pair is the character to convert to. If the character to convert in a pair is FF, then no conversion is done.

For example, if you have the character conversion configuration item set to the following: 41423132FFFFFF

The first pair is 4142 or AB (41 hex is an ASCII capital A, 42 hex is an ASCII capital B) and the second pair is 3132 or 12 (31 hex is an ASCII 1, 32 is an ASCII 2). The other two pairs are FFFF and FFFF.

With the label, AB12BA21, it would look as follows after the character conversion: BB22BB22.

The A characters were converted to B characters and the 1 characters were converted to 2 characters. Nothing is done with the last two character pairs, since they are all FF.

To set Character Conversion:

1. Scan the ENTER/EXIT barcode.
2. Scan the “Configure Character Conversion” barcode.
3. Determine the desired string. Sixteen positions must be determined as in the above example. Next, turn to the ASCII Chart on the inside back cover of this manual and find the equivalent hex digits needed to fulfill the string.
4. Turn to [Appendix E, Keypad](#) and scan the barcodes representing the hex characters determined in the previous step.
5. Scan the ENTER/EXIT barcode to exit Programming Mode.



NOTE

If less than the expected string of 16 characters are selected, scan the ENTER/EXIT barcode twice to accept the selections and exit Programming Mode.

Character Conversion – continued

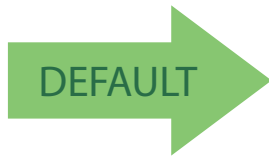
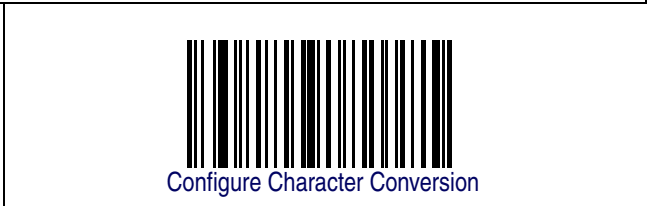
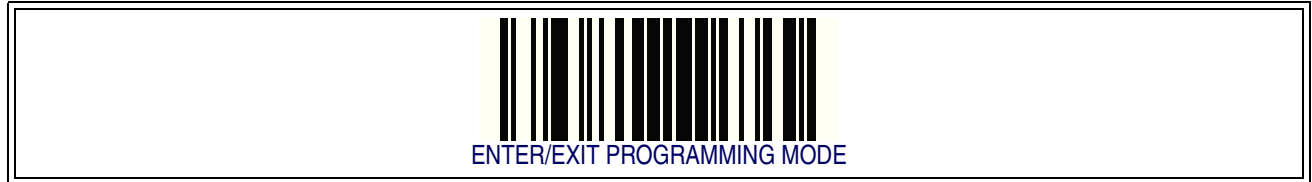

0xFFFFFFFFFFFFFFFF
(No character conversion)

NOTES

Chapter 12

Symbologies

Introduction

The reader supports the following symbologies (barcode types). Options for each symbology are included in this chapter.

Symbologies

- UPC-A
- UPC-E
- GTIN Formatting
- EAN 13 (JAN 13)
- EAN 8 (JAN 8)
- Add-Ons
- GS1 DataBar™ Omnidirectional
- GS1 DataBar™ Expanded
- GS1 DataBar™ Limited
- Code 39
- Code 32 (Italian Pharmaceutical)
- Code 39 CIP (French Pharmaceutical)
- Code 128
- GS1-128
- Interleaved 2 of 5 (I 2 of 5)
- Interleaved 2 of 5 CIP HR
- Datalogic 2 of 5
- Codabar
- ABC Codabar
- Code 11
- Standard 2 of 5
- Industrial 2 of 5
- IATA
- ISBT 128
- MSI
- Plessey
- Code 93
- Codablock F
- Code 4
- Code 5
- Follett 2 of 5

Standard Factory Settings for Symbologies

Default settings are indicated at each feature/option with a green arrow. Also reference [Appendix B, Standard Defaults](#) for a listing of the most widely used set of standard factory settings. That section also provides space to record any custom settings needed or implemented for your system.

Disable All Symbologies

Scan this label to disable all symbologies.

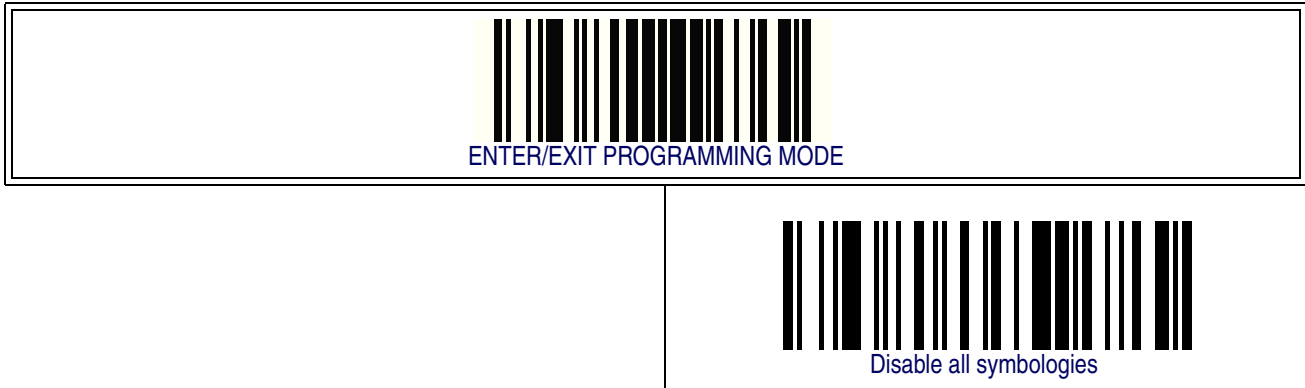

Coupon Control

This feature is used to control the method of processing coupon labels.

Options are:

- Allow all — allow all coupon barcodes to be decoded
- Enable only UPC/EAN — enables only UPC/EAN coupon decoding
- Enable only GS1 DataBar — enables only GS1 DataBar coupon decoding

To set this feature:

1. Scan the SWITCH bar code.
2. Scan either the enable or disable bar code below. You'll need to cover any unused barcodes on this and the facing page to ensure that the reader sees only the barcode you intend to scan.
3. Complete the programming sequence by scanning the SWITCH barcode.

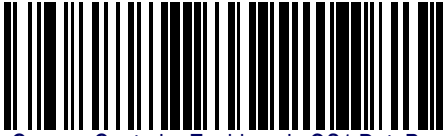

 ENTER/EXIT PROGRAMMING MODE	
	 Coupon Control = Allow all
 Coupon Control = Enable only UPC/EAN	
	 Coupon Control = Enable only GS1 DataBar

UPC-A

The following options apply to the UPC-A symbology.



UPC-A Enable/Disable

When disabled, the reader will not read UPC-A barcodes.

 ENTER/EXIT PROGRAMMING MODE	
	 UPC-A = Disable
 UPC-A = Enable	 DEFAULT

UPC-A Check Character Transmission

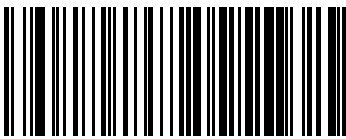
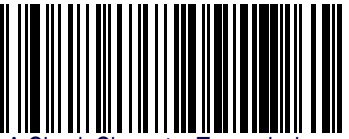
Enable this option to transmit the check character along with UPC-A barcode data.

 ENTER/EXIT PROGRAMMING MODE	
	 UPC-A Check Character Transmission = Don't Send
 UPC-A Check Character Transmission = Send	 DEFAULT

UPC-A – cont.

Expand UPC-A to EAN-13

Expands UPC-A data to the EAN-13 data format. Selecting this feature also changes the symbology ID to match those required for EAN-13.

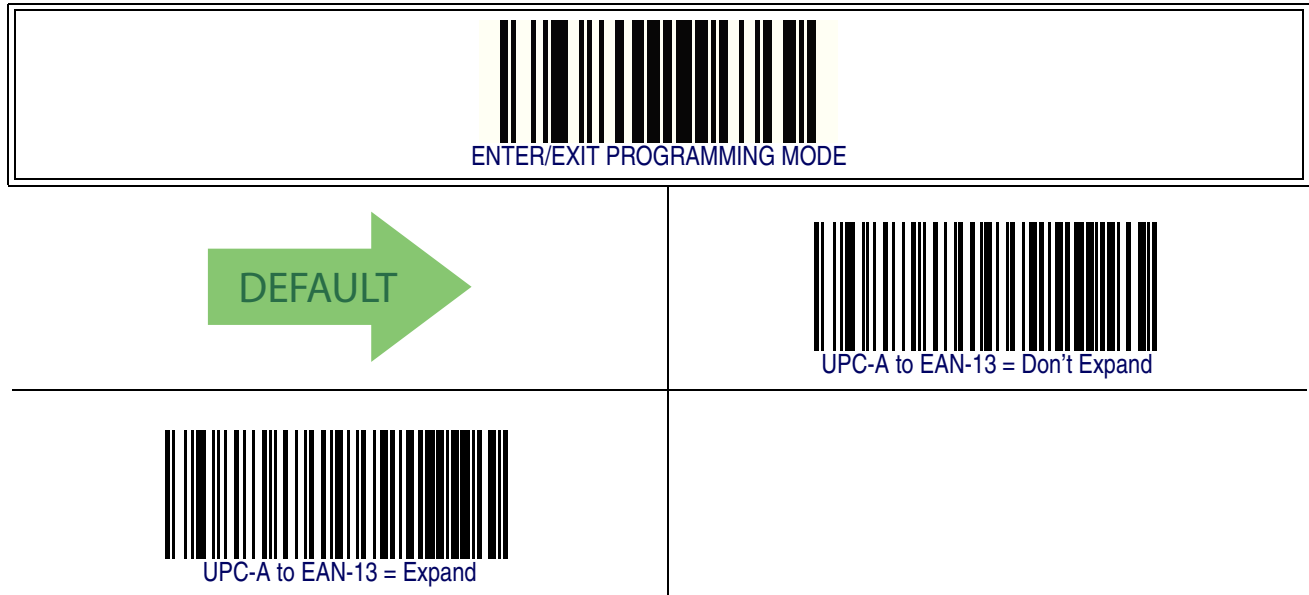

UPC-A Number System Character Transmission

This feature enables/disables transmission of the UPC-A number system character.

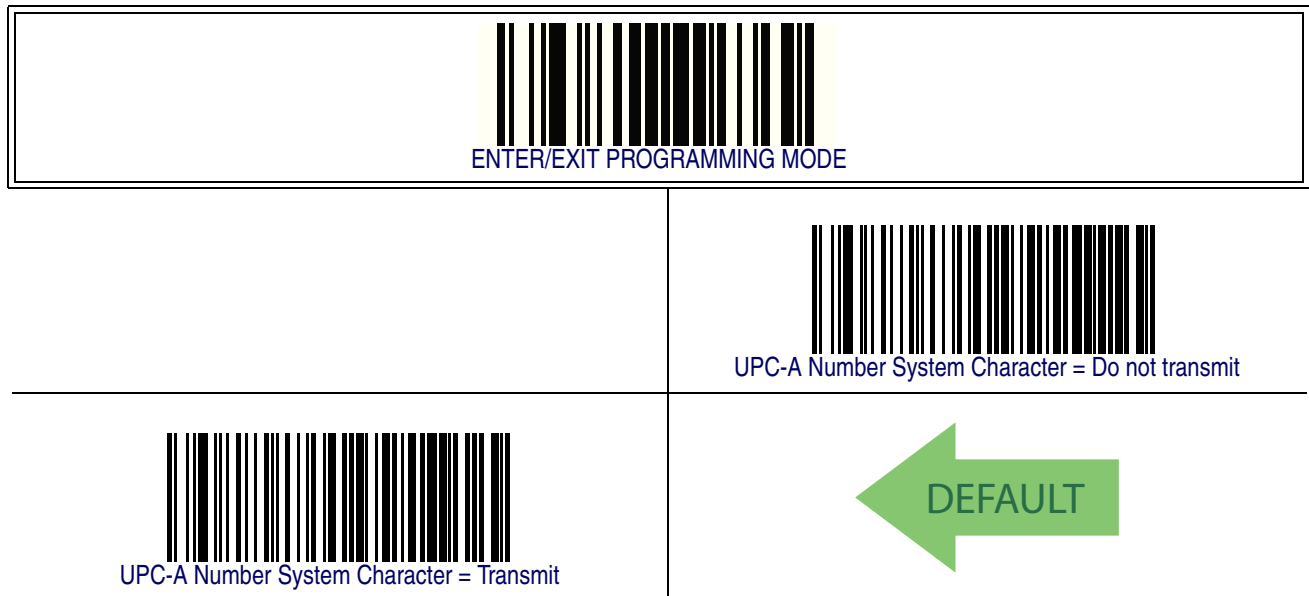

UPC-A – cont.

In-Store Minimum Reads

This feature specifies the minimum number of consecutive times an in-store label must be decoded before it is accepted as good read.

In-store labels are defined as UPC-A labels with a number-system character of 2 or 4 as well as EAN 8 and EAN 13 labels with a Flag1 character of 2 or an EAN 13 label starting with the three characters '980'.

 ENTER/EXIT PROGRAMMING MODE	
	 In-Store Minimum Reads = 1
 In-Store Minimum Reads = 2	
	 In-Store Minimum Reads = 3
 In-Store Minimum Reads = 4	

UPC-E

The following options apply to the UPC-E symbology.

UPC-E Enable/Disable

When disabled, the reader will not read UPC-E barcodes.

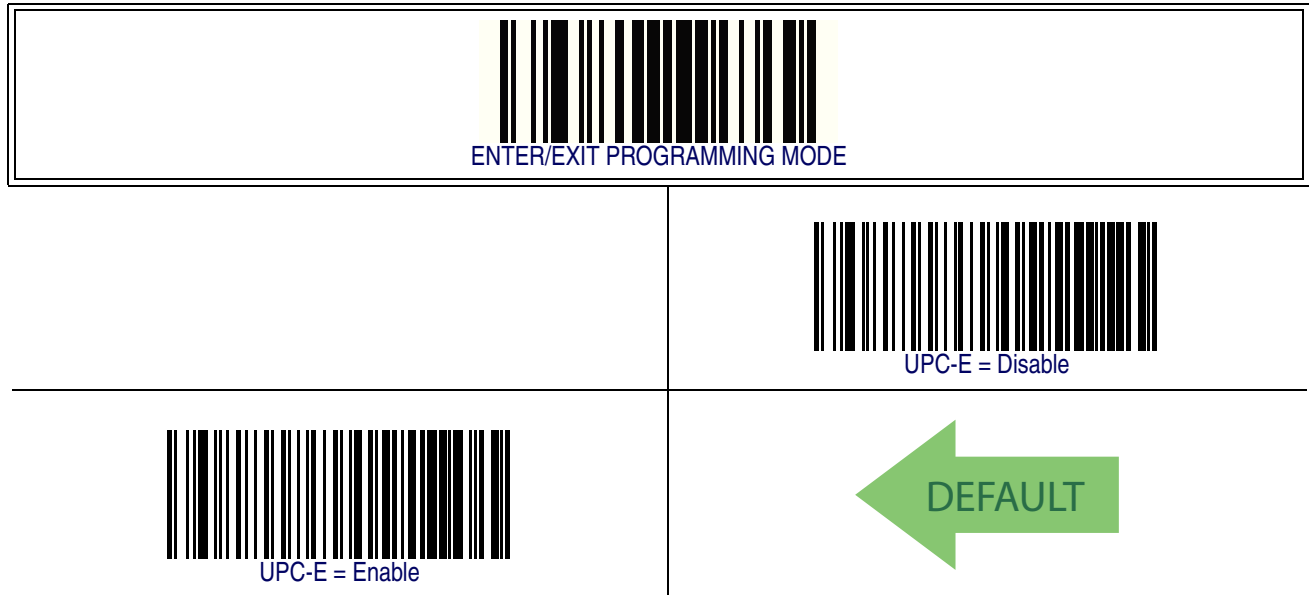

UPC-E Check Character Transmission

Enable this option to transmit the check character along with UPC-E barcode data.

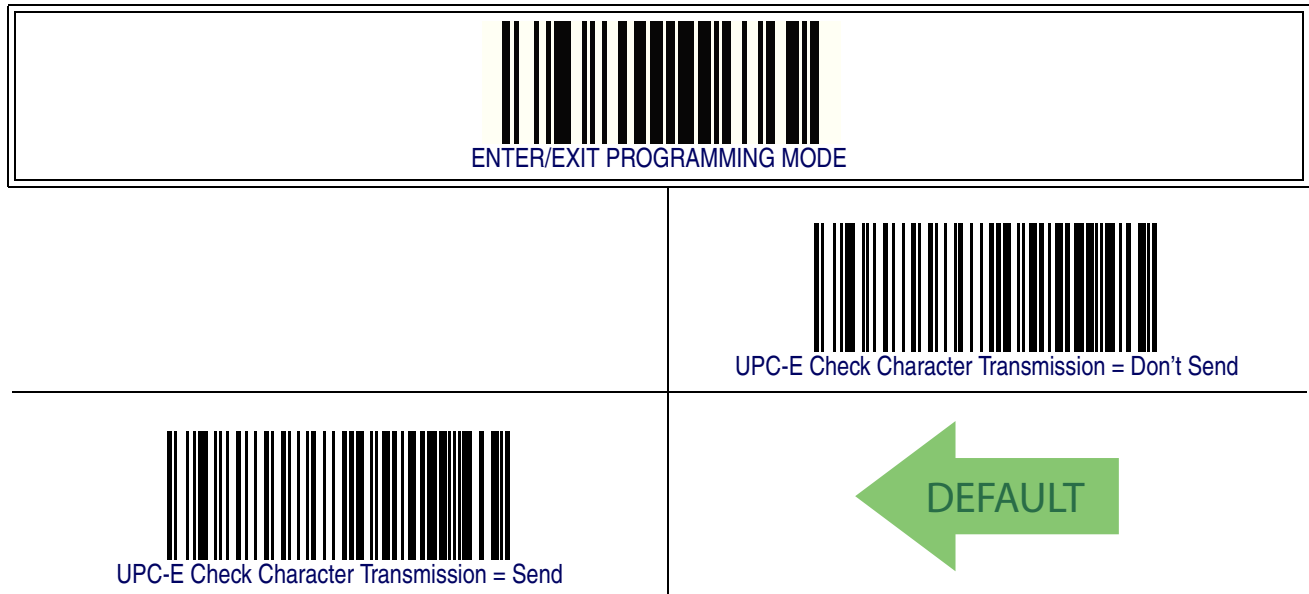

UPC-E — cont.

Expand UPC-E to EAN-13

Expands UPC-E data to the EAN-13 data format. Selecting this feature also changes the symbology ID to match those required for EAN-13.

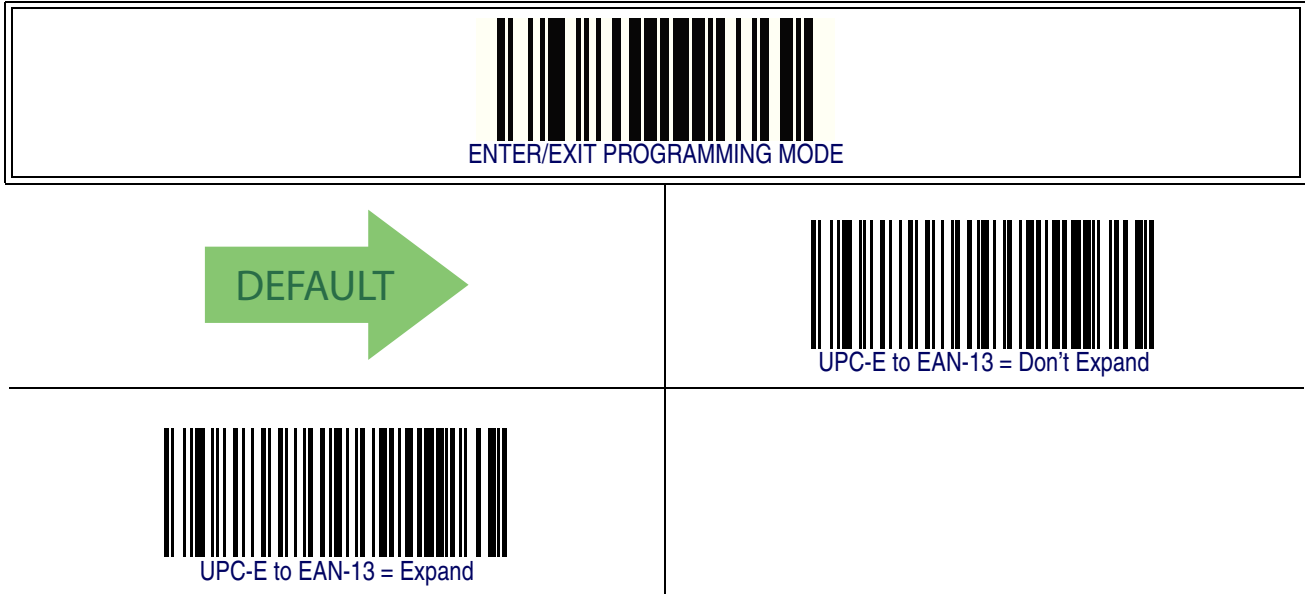

Expand UPC-E to UPC-A

Expands UPC-E data to the UPC-A data format.

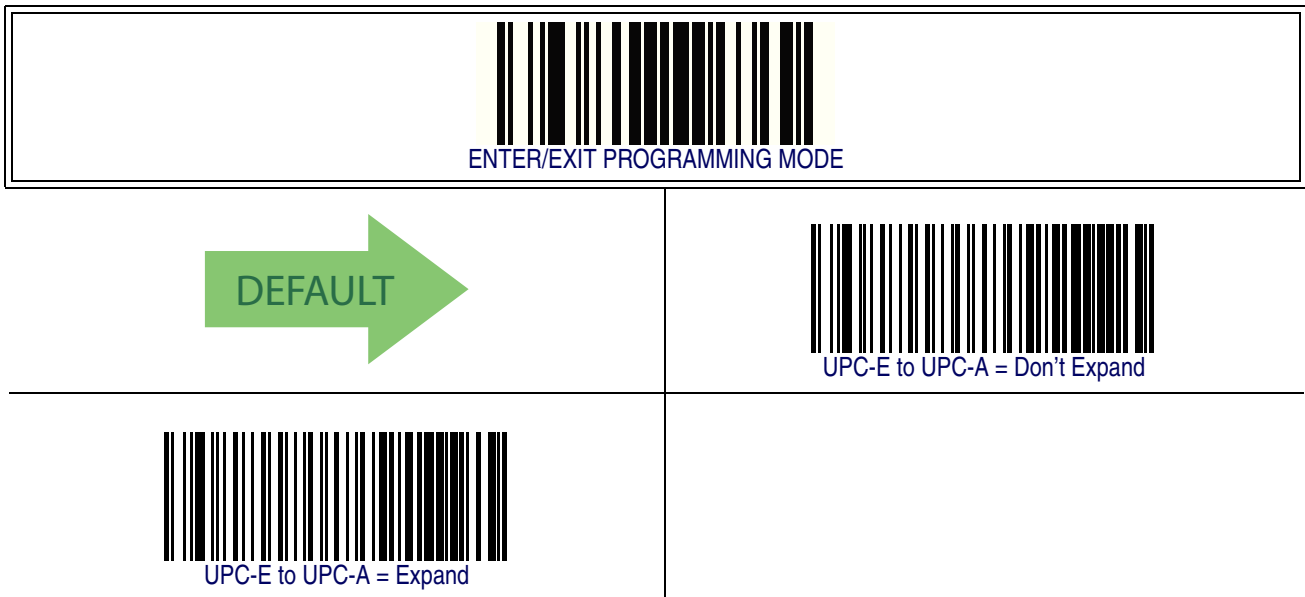

UPC-E – cont.

UPC-E Number System Character Transmission



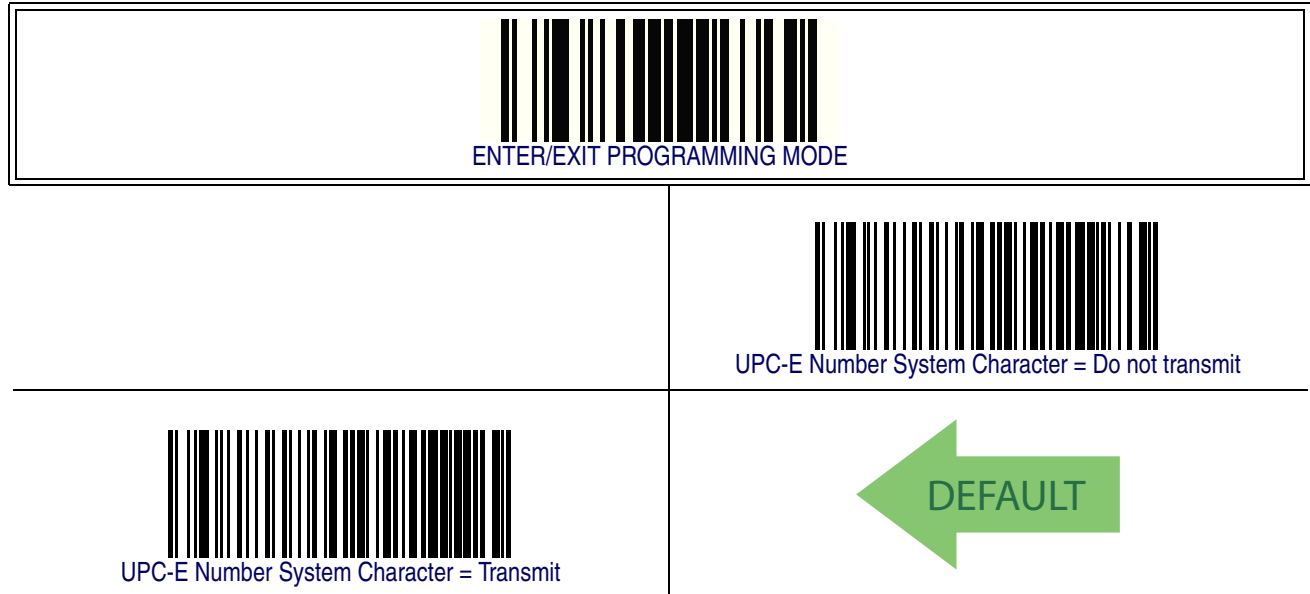

This feature enables/disables transmission of the UPC-E system number character.

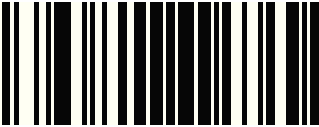
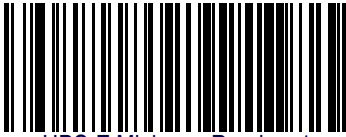

UPC-E — cont.

UPC-E Minimum Reads

This feature specifies the minimum number of consecutive times a UPC-E label must be decoded before it is accepted as good read..

 ENTER/EXIT PROGRAMMING MODE	
	 UPC-E Minimum Reads = 1
 UPC-E Minimum Reads = 2	 DEFAULT
	 UPC-E Minimum Reads = 3
 UPC-E Minimum Reads = 4	

GTIN Formatting

This feature enables/disables the ability to convert UPC-E, UPC-A, EAN 8, and EAN 13 labels into the GTIN 14-character format.



NOTE

If add-on information is present on the base label prior to the conversion taking place, the add-on information will be appended to the converted GTIN label.

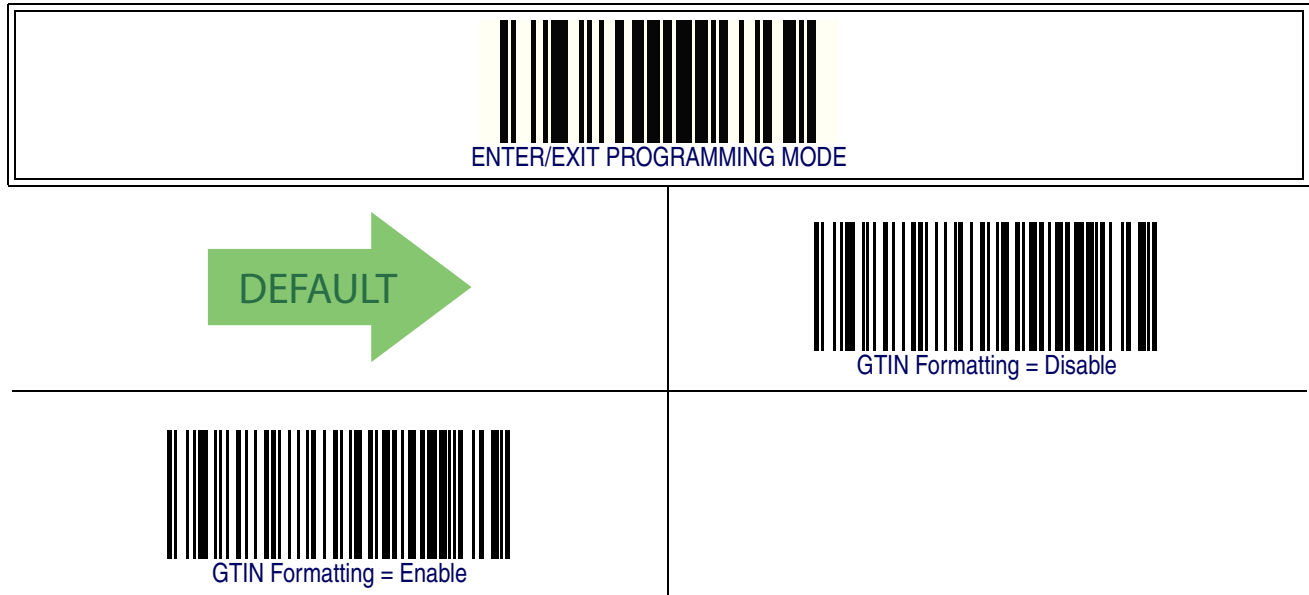

EAN 13

The following options apply to the EAN 13 (Jan 13) symbology.





EAN 13 Enable/Disable

When disabled, the reader will not read EAN 13/JAN 13 barcodes.

 ENTER/EXIT PROGRAMMING MODE	
	 EAN 13 = Disable
 EAN 13 = Enable	 DEFAULT

EAN 13 Check Character Transmission

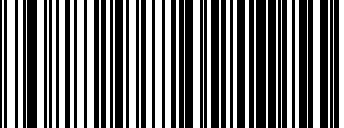
Enable this option to transmit the check character along with EAN 13 barcode data.

 ENTER/EXIT PROGRAMMING MODE	
	 EAN 13 Check Character Transmission = Don't Send
 EAN 13 Check Character Transmission = Send	 DEFAULT

EAN 13 – cont.

EAN-13 Flag 1 Character

Enables/disables transmission of an EAN/JAN13 Flag1 character. The Flag 1 character is the first character of the label.

 ENTER/EXIT PROGRAMMING MODE	
	 EAN-13 Flag 1 Char= Don't transmit
 EAN-13 Flag 1 Char= Transmit	 DEFAULT

EAN-13 ISBN Conversion

This option enables/disables conversion of EAN 13/JAN 13 Bookland labels starting with 978 to ISBN labels.

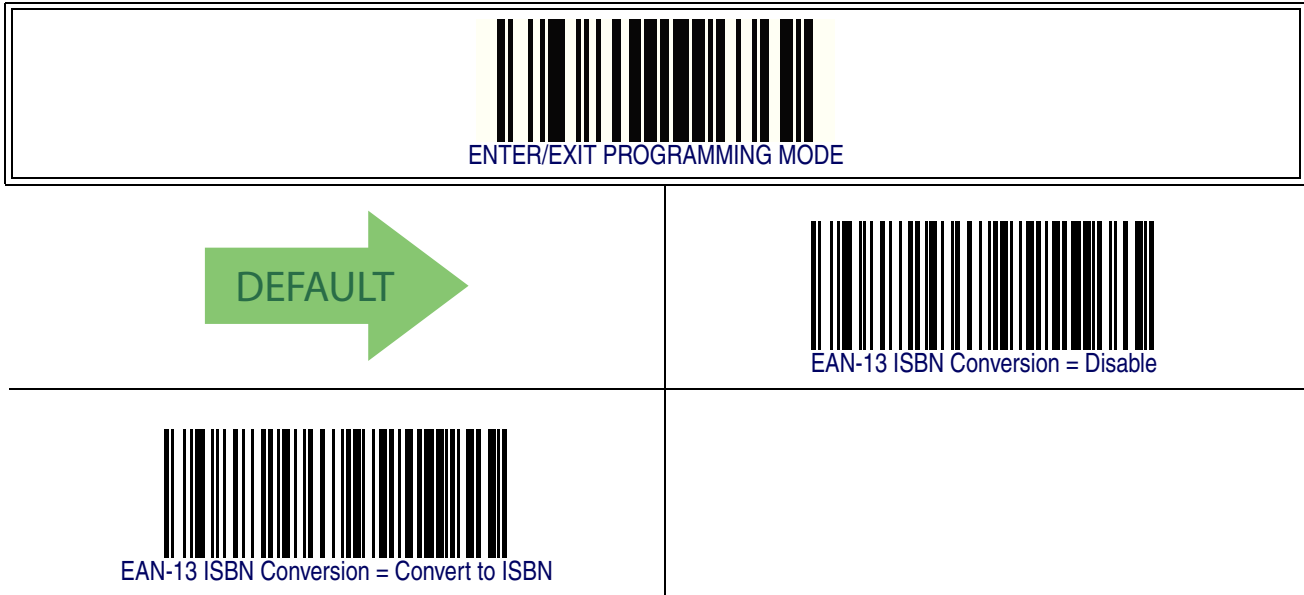

ISSN Enable/Disable

Enables/disables conversion of EAN/JAN13 Bookland labels starting with 977 to ISSN labels.



EAN 13 – cont.

EAN 13 Minimum Reads

This feature specifies the minimum number of consecutive times an EAN 13 label must be decoded before it is accepted as good read..



EAN 8

The following options apply to the EAN 8 (Jan 8) symbology.

EAN 8 Enable/Disable

When disabled, the reader will not read EAN 8/JAN 8 barcodes.

 ENTER/EXIT PROGRAMMING MODE	
	 EAN 8 = Disable
 EAN 8 = Enable	 DEFAULT

EAN 8 Check Character Transmission

Enable this option to transmit the check character along with EAN 8 barcode data.

 ENTER/EXIT PROGRAMMING MODE	
	 EAN 8 Check Character Transmission = Don't Send
 EAN 8 Check Character Transmission = Send	 DEFAULT

EAN 8 – cont.

Expand EAN 8 to EAN 13

Enable this option to expand EAN 8/JAN 8 labels to EAN 13/JAN 13.



EAN 8 – cont.

EAN 8 Minimum Reads

This feature specifies the minimum number of consecutive times an EAN 8 (Jan 8) label must be decoded before it is accepted as good read..



UPC/EAN Global Settings

This section provides configuration settings for UPC-A, UPC-E, EAN 13 and EAN 8 symbologies, and affects all of these unless otherwise marked for each feature description.

UPC/EAN Decoding Level

Decoding Levels are used to configure a barcode symbology decoder to be very aggressive to very conservative depending on a particular customer's needs.

- Choosing Level 1 results in a very conservative decoder at the expense of not being able to read poorly printed or damaged labels.
- Choosing Level 5 results in a very aggressive decoder. This aggressive behavior allows decoding of poorly printed and damaged labels at the expense of increasing the likelihood of decoding errors.
- Choosing Level 3, which is the default setting, allows the majority of product labels to be decoded.

There are many factors that determine when to change the decoding level for a particular symbology. These factors include spots, voids, non-uniform bar/space widths, damaged labels, etc. that may be experienced in some barcode labels. If there are many hard to read or damaged labels that cannot be decoded using a conservative setting, increase the decoding level to be more aggressive. If the majority of labels are very good quality labels, or there is a need to decrease the possibility of a decoder error, lower the decoding level to a more conservative level.

UPC/EAN Global Settings – cont.

UPC/EAN Decoding Level – cont.

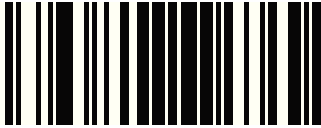
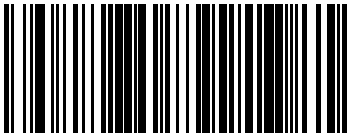
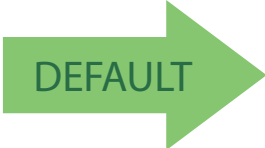
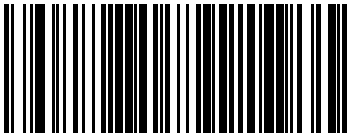
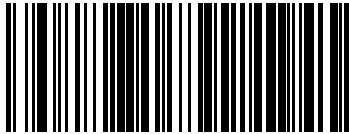
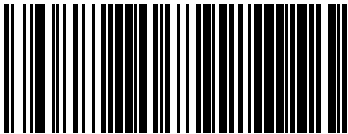
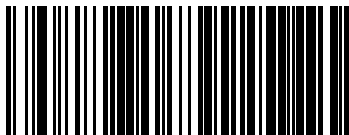
 ENTER/EXIT PROGRAMMING MODE	
 UPC/EAN Decoding Level = 1	
 DEFAULT	 UPC/EAN Decoding Level = 2
 UPC/EAN Decoding Level = 3	
	 UPC/EAN Decoding Level = 4
 UPC/EAN Decoding Level = 5	

UPC/EAN Global Settings – cont.

UPC/EAN Correlation

When correlation is enabled, the barcode reader will combine label data from multiple scans when decoding. Enabling correlation will help the scanner read labels that have some spots and/or voids. It may also help read labels that have damaged areas. Enabling correlation will also increase the chances that a label will be read incorrectly.



UPC/EAN Reconstruction

This option enables/disables character reconstruction for UPC/EAN labels.

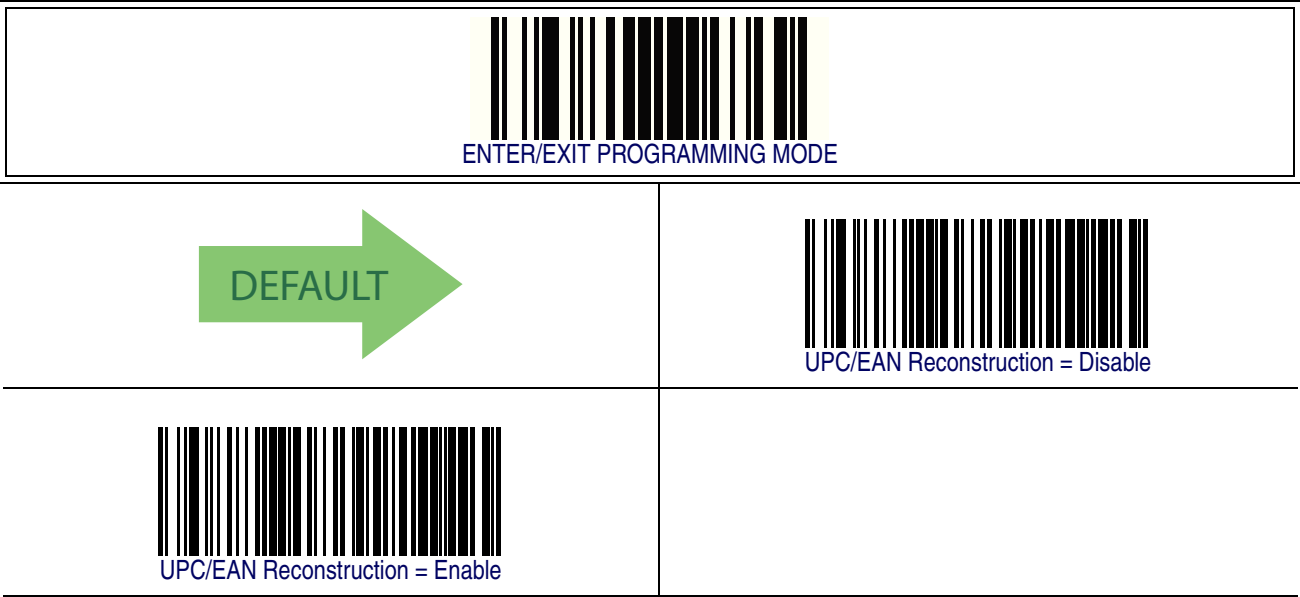

UPC/EAN Global Settings – cont.

UPC/EAN Price Weight Check

This feature enables/disables calculation and verification of price/weight check digits. Options are

- Disabled
- Enable 4-digit price-weight check-digit calculation
- Enable 5-digit price-weight check-digit calculation
- Enable European 4-digit price-weight check-digit calculation
- Enable European 5-digit price-weight check-digit calculation

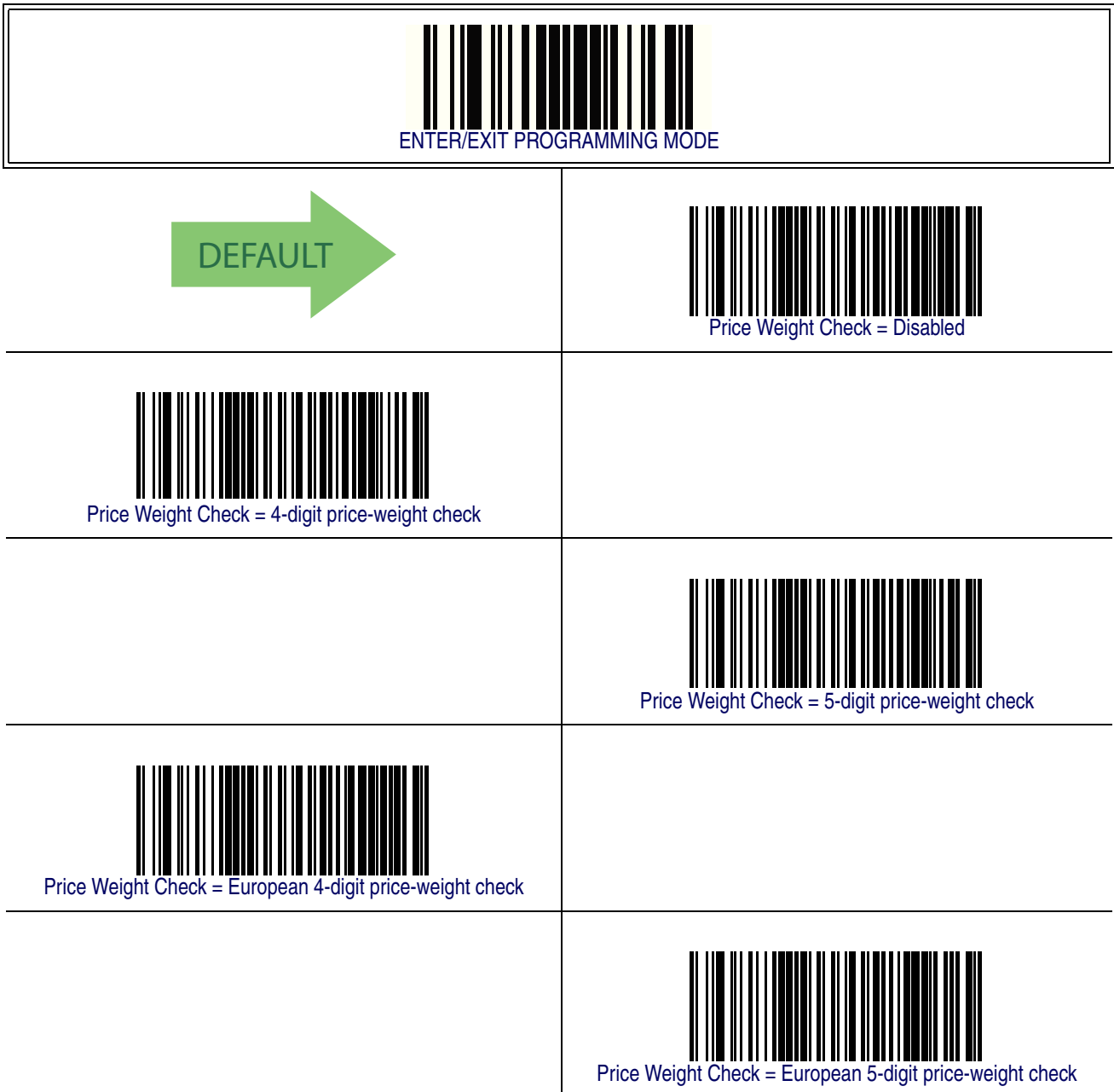

UPC/EAN Global Settings – cont.

UPC-A Minimum Reads

This feature specifies the minimum number of consecutive times a UPC-A label must be decoded before it is accepted as good read..



Add-Ons

The following features apply to optional add-ons.



NOTE

Contact Customer Support for advanced programming of optional and conditional add-ons.

Optional Add-ons

The reader can be enabled to optionally read the following add-ons (supplementals):

- P2
- P5
- GS1-128



NOTE

If a UPC/EAN base label and a an add-on are both decoded, the reader will transmit the base label and add-on. If a UPC/EAN base label is decoded without an add-on, the base label will be transmitted without an add-on.

Conditional add-on settings (if enabled) are considered by the reader before optional add-on settings.



Add-Ons – cont.

Optional Add-ons – cont.

 ENTER/EXIT PROGRAMMING MODE	
 Optional Add-Ons = Enable P5	
 DEFAULT	 Optional Add-Ons = Disable GS1-128
 Optional Add-Ons = Enable GS1-128	

Add-Ons — cont.

Optional Add-On Timer

This option sets the time the reader will look for an add-on when an add-on fragment has been seen and optional add-ons are enabled. (Also see [Optional GS1-128 Add-On Timer on page 155.](#))

 ENTER/EXIT PROGRAMMING MODE	
 Optional Add-on Timer = 10ms	
	 Optional Add-on Timer = 20ms
 Optional Add-on Timer = 30ms	
	 Optional Add-on Timer = 40ms
 Optional Add-on Timer = 50ms	

Add-Ons – cont.

Optional Add-On Timer – cont.

 ENTER/EXIT PROGRAMMING MODE	
	 Optional Add-on Timer = 60ms
 Optional Add-on Timer = 70ms	
	 Optional Add-on Timer = 100ms
 Optional Add-on Timer = 120ms	
	 Optional Add-on Timer = 140ms
 Optional Add-on Timer = 160ms	

Add-Ons — cont.

Optional Add-On Timer — cont.

 ENTER/EXIT PROGRAMMING MODE	
	 Optional Add-on Timer = 180ms
 Optional Add-on Timer = 200ms	
	 Optional Add-on Timer = 220ms
 Optional Add-on Timer = 240ms	
	 Optional Add-on Timer = 260ms
 Optional Add-on Timer = 280ms	
	 Optional Add-on Timer = 300ms

Add-Ons — cont.

Optional GS1-128 Add-On Timer

This option sets the timer expiration value to read the added part after reading the linear EAN/UPC part. For UPC/EAN add-ons other than those of that type, see [Optional Add-On Timer on page 152](#).

 ENTER/EXIT PROGRAMMING MODE	
 DEFAULT	 Optional GS1-128 Add-On Timer = Disable
 Optional GS1-128 Add-On Timer = 10ms	
	 Optional GS1-128 Add-On Timer = 20ms
 Optional GS1-128 Add-On Timer = 30ms	
	 Optional GS1-128 Add-On Timer = 40ms
 Optional GS1-128 Add-On Timer = 50ms	





Add-Ons — cont.

Optional GS1-128 Add-On Timer — cont.

 ENTER/EXIT PROGRAMMING MODE	
	 Optional GS1-128 Add-On Timer = 60ms
 Optional GS1-128 Add-On Timer = 70ms	
	 Optional GS1-128 Add-On Timer = 100ms
 Optional GS1-128 Add-On Timer = 120ms	
	 Optional GS1-128 Add-On Timer = 140ms
 Optional GS1-128 Add-On Timer = 160ms	

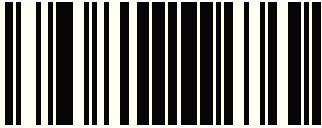
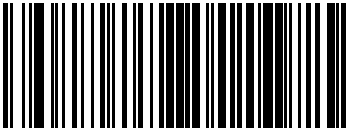
Add-Ons – cont.

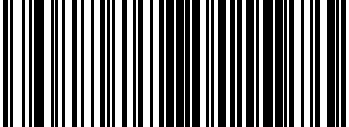
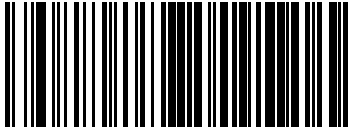
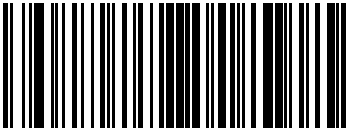
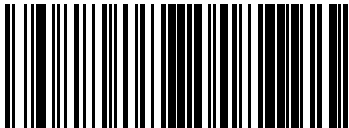
Optional GS1-128 Add-On Timer – cont.

 ENTER/EXIT PROGRAMMING MODE	
	 Optional GS1-128 Add-On Timer = 180ms
 Optional GS1-128 Add-On Timer = 200ms	
	 Optional GS1-128 Add-On Timer = 220ms
 Optional GS1-128 Add-On Timer = 240ms	
	 Optional GS1-128 Add-On Timer = 260ms
 Optional GS1-128 Add-On Timer = 280ms	
	 Optional GS1-128 Add-On Timer = 300ms

Add-Ons — cont.

P2 Add-Ons Minimum Reads

This feature specifies the minimum number of times a P2 add-on must be read before it is marked as valid and then combined with a base label.

 ENTER/EXIT PROGRAMMING MODE	
	 P2 Add-Ons Minimum Reads = 1
 P2 Add-Ons Minimum Reads = 2	 DEFAULT
	 P2 Add-Ons Minimum Reads = 3
 P2 Add-Ons Minimum Reads = 4	

Add-Ons — cont.

P5 Add-Ons Minimum Reads

This feature specifies the minimum number of times a P5 add-on must be read before it is marked as valid and then combined with a base label.



Add-Ons — cont.

GS1-128 Add-Ons Minimum Reads

This feature specifies the minimum number of times an GS1-128 add-on must be read before it is marked as valid and then combined with a base label.



GS1 DataBar™ Omnidirectional

The following options apply to the GS1 DataBar Omnidirectional (formerly RSS-14) symbology.

GS1 DataBar Omnidirectional Enable/Disable

When disabled, the reader will not read GS1 DataBar Omnidirectional barcodes.



GS1 DataBar Omnidirectional GS1-128 Emulation

When enabled, GS1 DataBar Omnidirectional barcodes will be translated to the GS1-128 label data format.

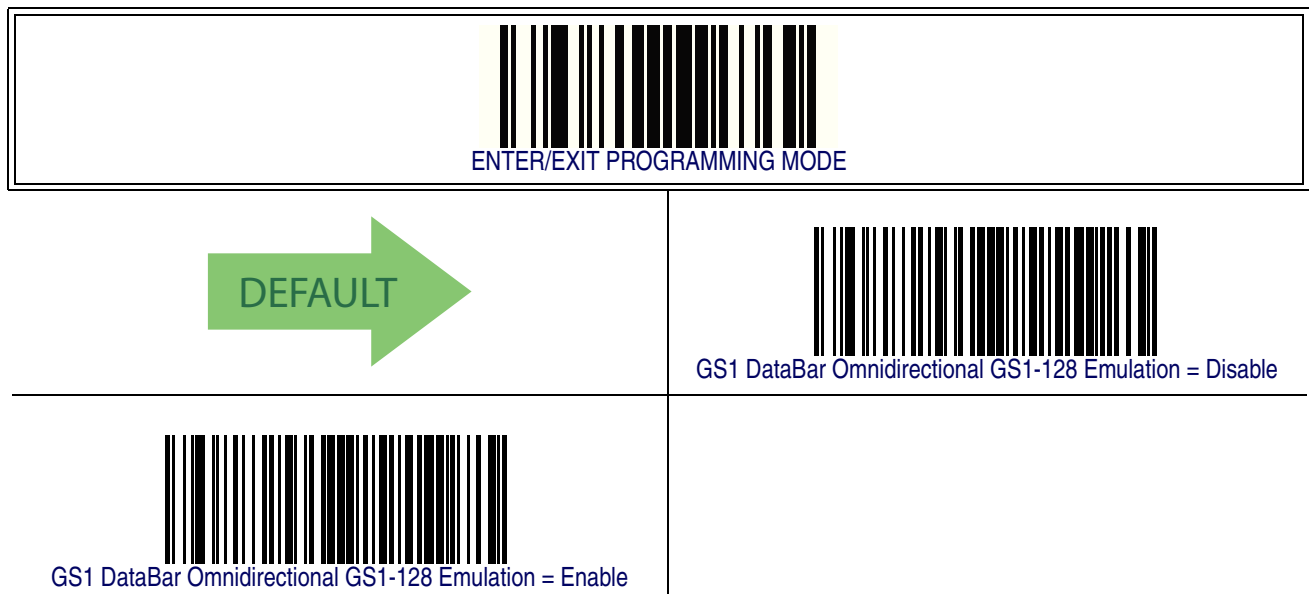

GS1 DataBar™ Omnidirectional – cont.

GS1 DataBar Omnidirectional Minimum Reads

This feature specifies the minimum number of consecutive times a GS1 DataBar Omnidirectional label must be decoded before it is accepted as good read.



GS1 DataBar™ Expanded

The following options apply to the GS1 DataBar Expanded (formerly RSS Expanded) symbology.

GS1 DataBar Expanded Enable/Disable

When disabled, the reader will not read GS1 DataBar Expanded barcodes.

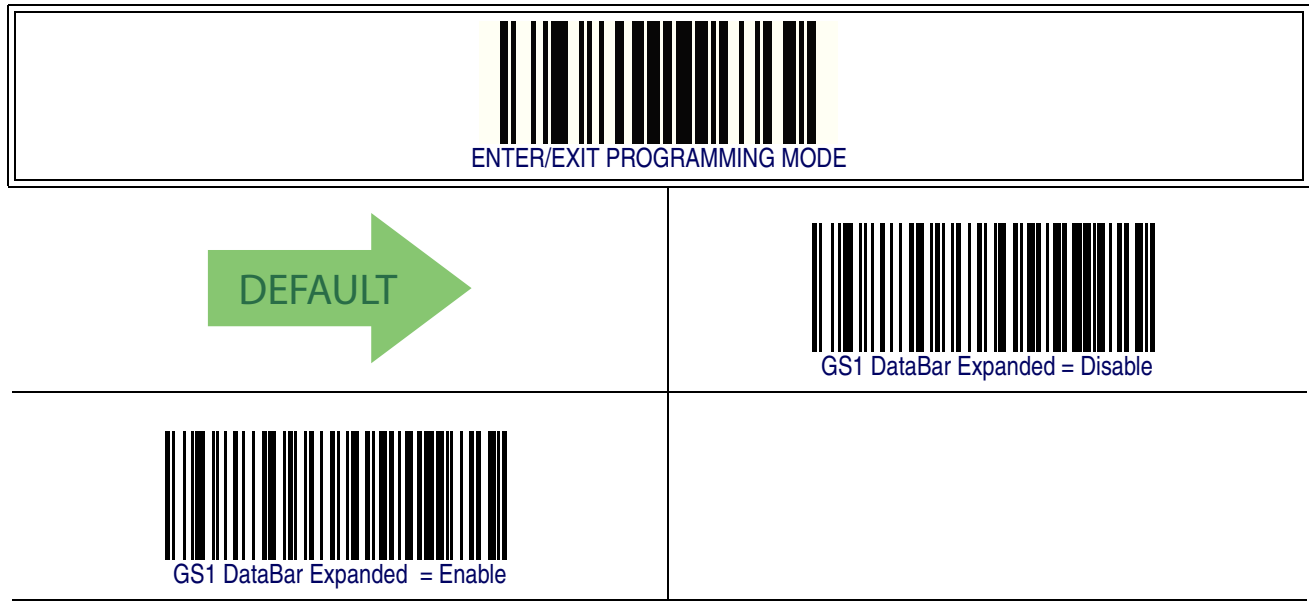

GS1 DataBar Expanded GS1-128 Emulation

When enabled, GS1 DataBar Expanded barcodes will be translated to the GS1-128 label data format.

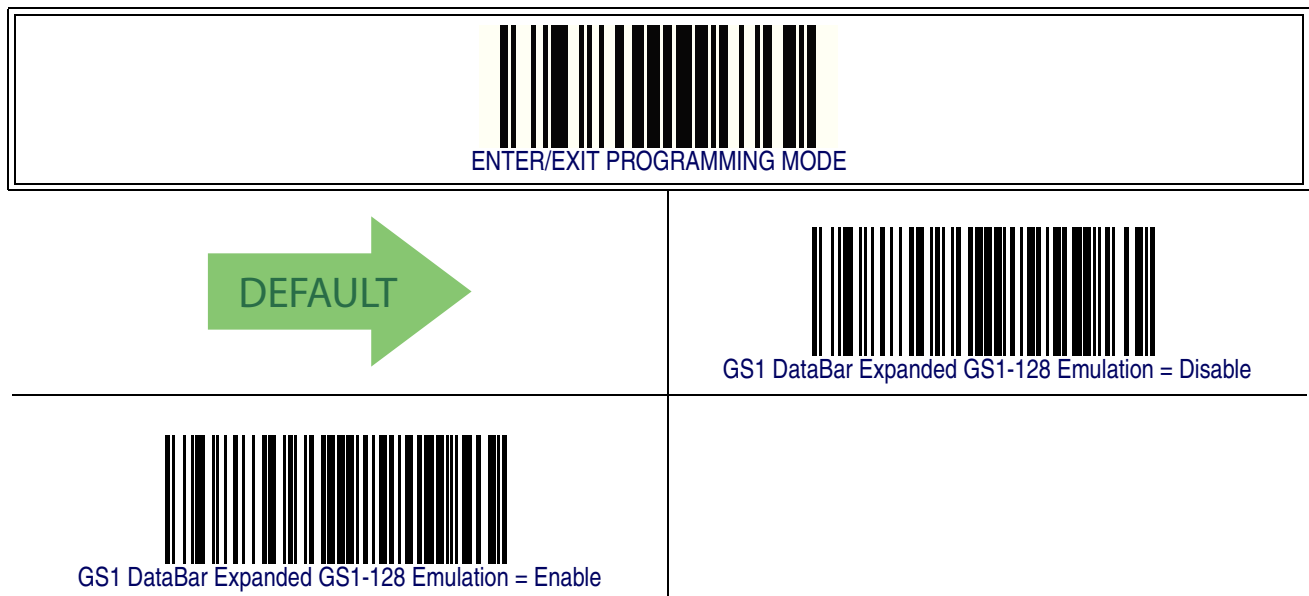

GS1 DataBar™ Expanded — cont.

GS1 DataBar Expanded Minimum Reads

This feature specifies the minimum number of consecutive times a GS1 DataBar Expanded label must be decoded before it is accepted as good read.



GS1 DataBar™ Expanded – cont.

GS1 DataBar Expanded Length Control

This feature specifies either variable length decoding or fixed length decoding for the GS1 DataBar Expanded symbology.

Variable Length – For variable-length decoding, a minimum length may be set.

Fixed Length – For fixed-length decoding, two different lengths may be set.

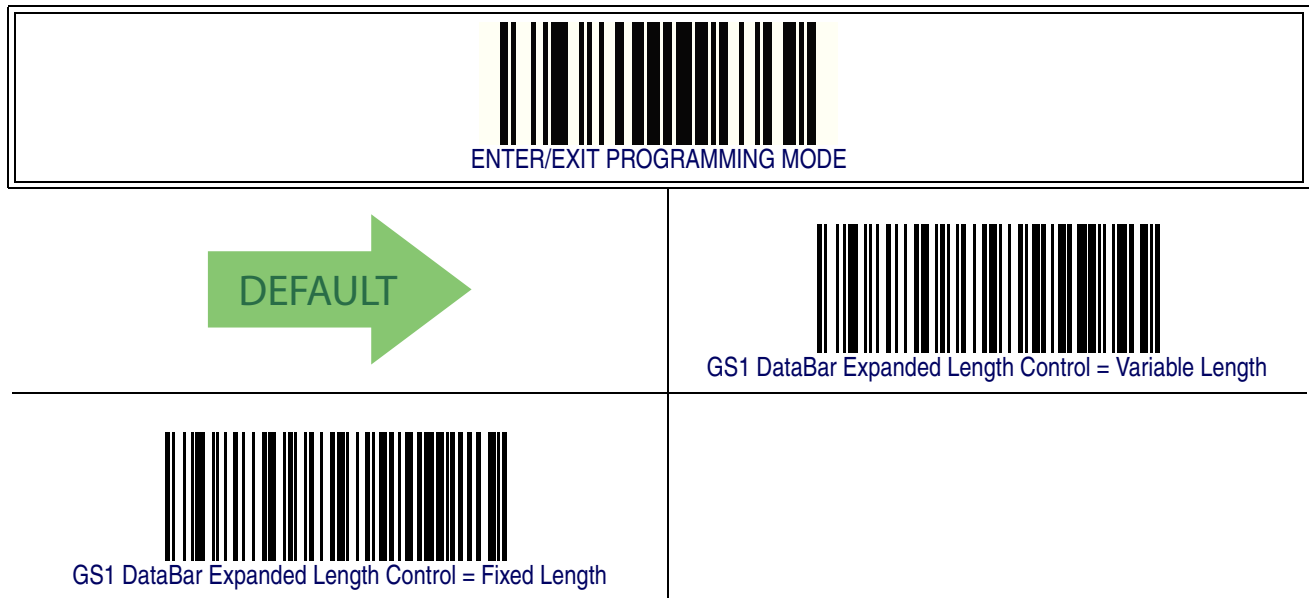

GS1 DataBar™ Expanded – cont.

GS1 DataBar Expanded Set Length 1

This feature specifies one of the barcode lengths for [GS1 DataBar Expanded Length Control](#). Length 1 is the minimum label length if in [Variable Length Mode](#), or the first fixed length if in [Fixed Length Mode](#). Length includes the barcode’s data characters only.

The length can be set from 1 to 74 characters.

Follow these instructions to set this feature:

1. Determine the desired character length (from 1 to 74). Pad the number with leading zeroes to yield two digits. For example: 0 = 00, 5 = 05, 20 = 20, etc.
2. Scan the ENTER/EXIT PROGRAMMING MODE barcode to enter Programming Mode.
3. Scan the barcode: SELECT GS1 DATABAR EXPANDED LENGTH 1 SETTING.
4. Scan the appropriate two digits from the keypad in [Appendix E, Keypad](#), that represent the length setting which was determined in the steps above. You will hear a two-beep indication after the last character.



If you make a mistake before the last character, scan the CANCEL barcode to abort and not save the entry string. You can then start again at the beginning.

NOTE

5. Scan the ENTER/EXIT PROGRAMMING MODE barcode to exit Programming Mode.



This completes the procedure. See [Table 19](#) for some examples of how to set this feature.

Table 19. GS1 DataBar Expanded Length 1 Setting Examples

STEP	ACTION	EXAMPLES			
1	Desired Setting	01 Character	07 Characters	52 Characters	74 Characters
2	Scan ENTER/EXIT PROGRAMMING MODE				
3	Scan SELECT GS1 DATABAR EXPANDED LENGTH 1 SETTING				
4	Scan Two Characters From Appendix E, Keypad	'0' and '1'	'0' and '7'	'5' and '2'	'7' AND '4'
5	Scan ENTER/EXIT PROGRAMMING MODE				

GS1 DataBar™ Expanded – cont.

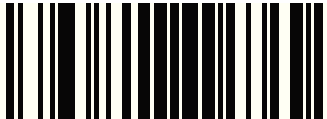
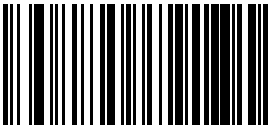
GS1 DataBar Expanded Set Length 1 – cont.

 ENTER/EXIT PROGRAMMING MODE	
 Select GS1 DataBar Expanded Set Length 1 Setting	
Make a mistake? Scan the CANCEL barcode to abort and not save the entry string. You can then start again at the beginning.	 CANCEL

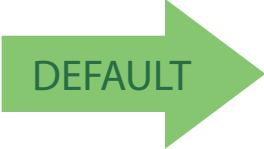
 01 = Length 1 is 1 Character

GS1 DataBar™ Expanded – cont.

GS1 DataBar Expanded Set Length 2

This feature specifies one of the barcode lengths for [GS1 DataBar Expanded Length Control](#). Length 2 is the maximum label length if in [Variable Length Mode](#), or the second fixed length if in [Fixed Length Mode](#). Length includes the barcode's data characters only.

The length can be set from 1 to 74 characters. A setting of 0 specifies to ignore this length (only one fixed length).

Follow these instructions to set this feature:

1. Determine the desired character length (from 1 to 74). Pad the number with leading zeroes to yield two digits. For example: 0 = 00, 5 = 05, 20 = 20, etc.
2. Scan the ENTER/EXIT PROGRAMMING MODE barcode to enter Programming Mode.
3. Scan the barcode: SELECT GS1 DATABAR EXPANDED LENGTH 2 SETTING.
4. Scan the appropriate two digits from the keypad in [Appendix E, Keypad](#), that represent the length setting which was determined in the steps above. You will hear a two-beep indication after the last character.



If you make a mistake before the last character, scan the CANCEL barcode to abort and not save the entry string. You can then start again at the beginning.

NOTE

5. Scan the ENTER/EXIT PROGRAMMING MODE barcode to exit Programming Mode.

This completes the procedure. See [Table 20](#) for some examples of how to set this feature.

Table 20. GS1 DataBar Expanded Length 2 Setting Examples

STEP	ACTION	EXAMPLES			
1	Desired Setting	00 (ignore second length)	07 Characters	52 Characters	74 Characters
2	Scan ENTER/EXIT PROGRAMMING MODE				
3	Scan SELECT GS1 DATABAR EXPANDED LENGTH 2 SETTING				
4	Scan Two Characters From Appendix E, Keypad	'0' and '0'	'0' and '7'	'5' and '2'	'7' and '4'
5	Scan ENTER/EXIT PROGRAMMING MODE				

GS1 DataBar™ Expanded – cont.

GS1 DataBar Expanded Set Length 2 – cont.

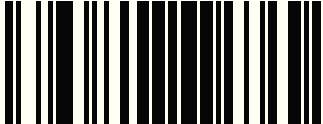
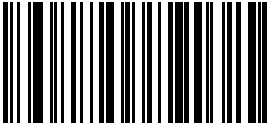
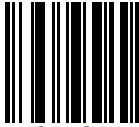
 ENTER/EXIT PROGRAMMING MODE	
 Select GS1 DataBar Expanded Set Length 2 Setting	
Make a mistake? Scan the CANCEL barcode to abort and not save the entry string. You can then start again at the beginning.	 CANCEL

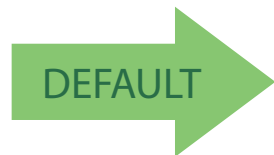

74 = Length 2 is 74 Characters

GS1 DataBar™ Limited

The following options apply to the GS1 DataBar Limited (formerly RSS Limited) symbology.

GS1 DataBar Limited Enable/Disable

When disabled, the reader will not read GS1 DataBar Limited barcodes.



GS1 DataBar Limited GS1-128 Emulation

When enabled, GS1 DataBar Limited barcodes will be translated to the GS1-128 label data format.



GS1 DataBar™ Limited – cont.

GS1 DataBar Limited Minimum Reads

This feature specifies the minimum number of consecutive times a GS1 DataBar Limited label must be decoded before it is accepted as good read.



Code 39

The following options apply to the Code 39 symbology.

Code 39 Enable/Disable

When disabled, the reader will not read Code 39 barcodes.

 ENTER/EXIT PROGRAMMING MODE	
	 Code 39 = Disable
 Code 39 = Enable	 DEFAULT

Code 39 — cont.

Code 39 Check Character Calculation



Enable this option to enables/disables calculation and verification of an optional Code 39 check character. When disabled, any check character in the label is treated as a data character

 ENTER/EXIT PROGRAMMING MODE	
	 Code 39 Check Character Calculation = Don't Calculate
 Code 39 Check Character Calculation = Calculate Std Check	
	 Code 39 Check Character Calculation = Calculate Mod 7 Check
 Code 39 Check Character Calculation = Enable Italian Post Check	
	 Code 39 Check Character Calculation = Enable Daimler Chrysler Check

Code 39 – cont.

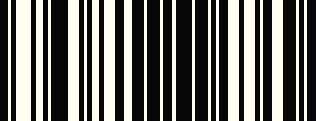
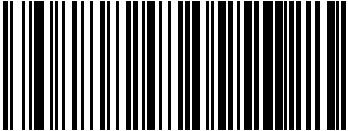
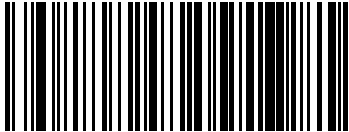

Code 39 Check Character Transmission

Enable this option to transmit the check character along with Code 39 barcode data.

 ENTER/EXIT PROGRAMMING MODE	
	 Code 39 Check Character Transmission = Don't Send
 Code 39 Check Character Transmission = Send	 DEFAULT

Code 39 Start/Stop Character Transmission

Enable this option to enable/disable transmission of Code 39 start and stop characters.

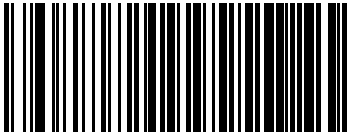
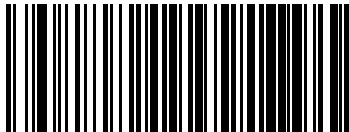
 ENTER/EXIT PROGRAMMING MODE	
 DEFAULT	 Code 39 Start/Stop Character Transmission = Don't Transmit
 Code 39 Start/Stop Character Transmission = Transmit	

Code 39 — cont.

Code 39 Full ASCII

In Code 39 decoding, this enables/disables the translation of Code 39 characters to Code 39 full-ASCII characters.



Code 39 – cont.

Code 39 Quiet Zones

This feature specifies the number of quiet zones for Code 39 labels. Quiet zones are blank areas at the ends of a barcode and are typically 10 times the width of the narrowest bar or space in the label.

 ENTER/EXIT PROGRAMMING MODE	
 Code 39 Quiet Zones = Quiet Zone on one side	
	 Code 39 Quiet Zones = Quiet Zones on two sides
 Code 39 Quiet Zones = Auto	 DEFAULT
	 Code 39 Quiet Zones = Virtual Quiet Zones on two sides
 Code 39 Quiet Zones = Small Quiet Zones on two sides	

Code 39 — cont.

Code 39 Minimum Reads

This feature specifies the minimum number of consecutive times a Code 39 label must be decoded before it is accepted as good read..



Code 39 – cont.

Code 39 Decoding Level

Decoding Levels are used to configure a barcode symbology decoder to be very aggressive to very conservative depending on a particular customer's needs.

- Choosing Level 1 results in a very conservative decoder at the expense of not being able to read poorly printed or damaged labels.
- Choosing Level 5 results in a very aggressive decoder. This aggressive behavior allows decoding of poorly printed and damaged labels at the expense of increasing the likelihood of decoding errors.
- Choosing Level 3, which is the default setting, allows the majority of product labels to be decoded.

There are many factors that determine when to change the decoding level for a particular symbology. These factors include spots, voids, non-uniform bar/space widths, damaged labels, etc. that may be experienced in some barcode labels. If there are many hard to read or damaged labels that cannot be decoded using a conservative setting, increase the decoding level to be more aggressive. If the majority of labels are very good quality labels, or there is a need to decrease the possibility of a decoder error, lower the decoding level to a more conservative level.



NOTE

This configuration item applies to Code 39 and Code 32.

Code 39 — cont.

Code 39 Decoding Level — cont.

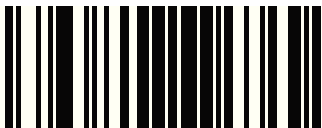
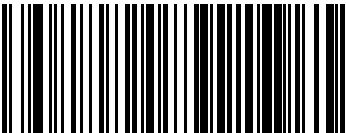
 ENTER/EXIT PROGRAMMING MODE	
 Code 39 Decoding Level = 1	
	 Code 39 Decoding Level = 2
 Code 39 Decoding Level = 3	 DEFAULT
	 Code 39 Decoding Level = 4
 Code 39 Decoding Level = 5	

Code 39 – cont.

Code 39 Length Control

This feature specifies either variable length decoding or fixed length decoding for the Code 39 symbology.

Variable Length – For variable length decoding, a minimum and maximum length may be set.

Fixed Length – For fixed length decoding, two different lengths may be set.



Code 39 – cont.

Code 39 Set Length 1

This feature specifies one of the barcode lengths for [Code 39 Length Control](#). Length 1 is the minimum label length if in [Variable Length Mode](#), or the first fixed length if in [Fixed Length Mode](#). Length includes the barcode's data characters only.

The length can be set from 0 to 50 characters.

Follow these instructions to set this feature:

1. Determine the desired character length (from 0 to 50). Pad the number with leading zeroes to yield two digits. For example: 0 = 00, 5 = 05, 20 = 20, etc.
2. Scan the ENTER/EXIT PROGRAMMING MODE barcode to enter Programming Mode.
3. Scan the barcode: SELECT CODE 39 LENGTH 1 SETTING.
4. Scan the appropriate two digits from the keypad in [Appendix E, Keypad](#), that represent the length setting which was determined in the steps above. You will hear a two-beep indication after the last character.



If you make a mistake before the last character, scan the CANCEL barcode to abort and not save the entry string. You can then start again at the beginning.

NOTE

5. Scan the ENTER/EXIT PROGRAMMING MODE barcode to exit Programming Mode.

This completes the procedure. See [Table 21](#) for some examples of how to set this feature.

Table 21. Code 39 Length 1 Setting Examples

STEP	ACTION	EXAMPLES			
1	Desired Setting	00 Characters	07 Characters	15 Characters	50 Characters
2	Scan ENTER/EXIT PROGRAMMING MODE				
3	Scan SELECT CODE 39 LENGTH 1 SETTING				
4	Scan Two Characters From Appendix E, Keypad	'0' and '0'	'0' and '7'	'1' and '5'	'5' AND '0'
5	Scan ENTER/EXIT PROGRAMMING MODE				

Code 39 – cont.

Code 39 Set Length 1 – cont.

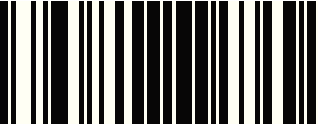
 ENTER/EXIT PROGRAMMING MODE
--

 Select Code 39 Set Length 1 Setting
--

Make a mistake? Scan the CANCEL barcode to abort and not save the entry string. You can then start again at the beginning.

 CANCEL

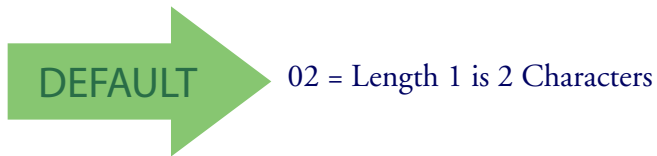

Code 39 — cont.

Code 39 Set Length 2

This feature specifies one of the barcode lengths for [Code 39 Length Control](#). Length 2 is the maximum label length if in [Variable Length Mode](#), or the second fixed length if in [Fixed Length Mode](#). Length includes the barcode's check, data, and full-ASCII shift characters. The length does not include start/stop characters.

The length can be set from 1 to 50 characters. A setting of 0 specifies to ignore this length (only one fixed length).

Follow these instructions to set this feature:

1. Determine the desired character length (from 1 to 50 — or 0 to ignore this length). Pad the number with leading zeroes to yield two digits. For example: 0 = 00, 5 = 05, 20 = 20, etc.
2. Scan the ENTER/EXIT PROGRAMMING MODE barcode to enter Programming Mode.
3. Scan the barcode: SELECT CODE 39 LENGTH 2 SETTING.
4. Scan the appropriate two digits from the keypad in [Appendix E, Keypad](#), that represent the length setting which was determined in the steps above. You will hear a two-beep indication after the last character.



If you make a mistake, before the last character scan the CANCEL barcode to abort and not save the entry string. You can then start again at the beginning.

NOTE

5. Scan the ENTER/EXIT PROGRAMMING MODE barcode to exit Programming Mode.

This completes the procedure. See [Table 22](#) for some examples of how to set this feature.

Table 22. Code 39 Length 2 Setting Examples

STEP	ACTION	EXAMPLES			
1	Desired Setting	00 (Ignore This Length)	07 Characters	15 Characters	50 Characters
2	Scan ENTER/EXIT PROGRAMMING MODE				
3	Scan SELECT CODE 39 LENGTH 2 SETTING				
4	Scan Two Characters From Appendix E, Keypad	'0' and '0'	'0' and '7'	'1' and '5'	'5' AND '0'
5	Scan ENTER/EXIT PROGRAMMING MODE				

Code 39 – cont.

Code 39 Set Length 2 – cont.

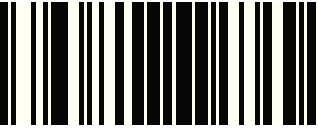
 ENTER/EXIT PROGRAMMING MODE
--

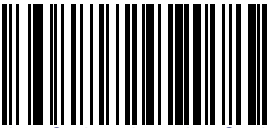
 Select Code 39 Length 2 Setting	
--	--

Make a mistake? Scan the CANCEL barcode to abort and not save the entry string. You can then start again at the beginning.	 CANCEL
--	---



Code 39 — cont.

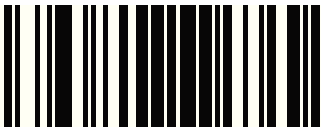
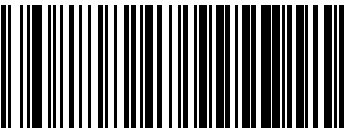

Code 39 Interdigit Ratio

This feature specifies the ratio between an intercharacter space and module for Code 39 labels.

 ENTER/EXIT PROGRAMMING MODE	
	 Code 39 Interdigit Ratio = Disable
 Code 39 Interdigit Ratio = 1	
	 Code 39 Interdigit Ratio = 2
 Code 39 Interdigit Ratio = 3	
 DEFAULT	 Code 39 Interdigit Ratio = 4
 Code 39 Interdigit Ratio = 5	

Code 39 – cont.

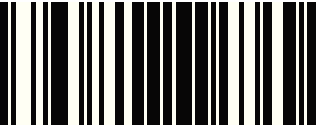
Code 39 Interdigit Ratio – cont.

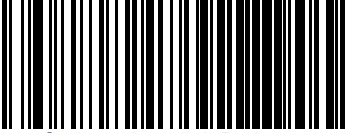
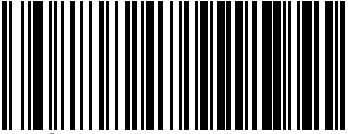
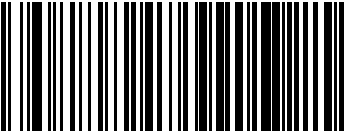
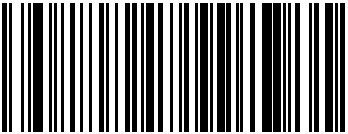
 ENTER/EXIT PROGRAMMING MODE	
	 Code 39 Interdigit Ratio = 6
 Code 39 Interdigit Ratio = 7	
	 Code 39 Interdigit Ratio = 8
 Code 39 Interdigit Ratio = 9	
	 Code 39 Interdigit Ratio = 10

Code 39 — cont.

Code 39 Character Correlation

When correlation is enabled, the barcode reader will combine label data from multiple scans when decoding. Enabling correlation will help the scanner read labels that have some spots and/or voids. It may also help read labels that have damaged areas. Enabling correlation will also increase the chances that a label will be read incorrectly.



Code 39 Stitching

This option enables/disables stitching for Code 39 labels. When parts of a Code 39 barcode are presented to the reader with this feature enabled, the barcode parts will be assembled by the reader's software, and the data will be decoded if all barcode proofing requirements are met.



Code 32 (Italian Pharmaceutical)

The following options apply to the Code 32 (Italian Pharmaceutical Code) symbology.

Code 32 Enable/Disable

When disabled, the reader will not read Code 32 barcodes.

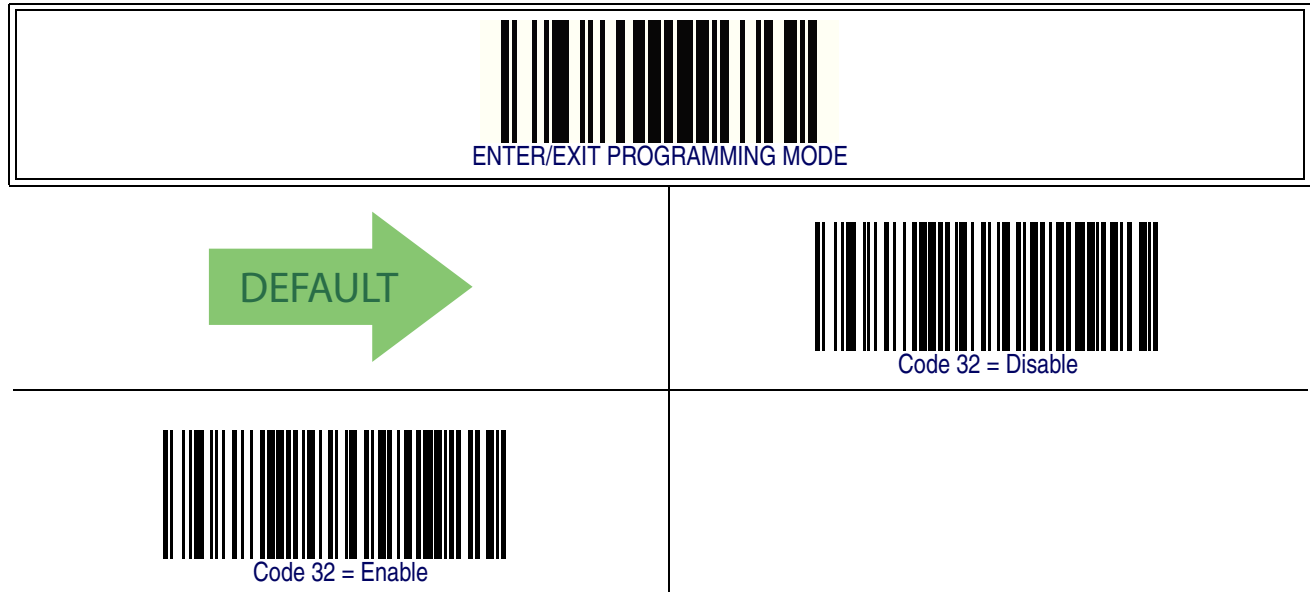

Code 32 Feature Setting Exceptions



NOTE

The following features are set for Code 32 by using these Code 39 settings:

- Code 39 Quiet Zones on page 176
- Code 39 Minimum Reads on page 177
- Code 39 Decoding Level on page 178
- Code 39 Interdigit Ratio on page 185
- Code 39 Character Correlation on page 187
- Code 39 Stitching on page 188

Code 32 (Italian Pharmaceutical) – cont.

Code 32 Check Character Transmission

Enable this option to transmit the check character along with Code 32 barcode data.

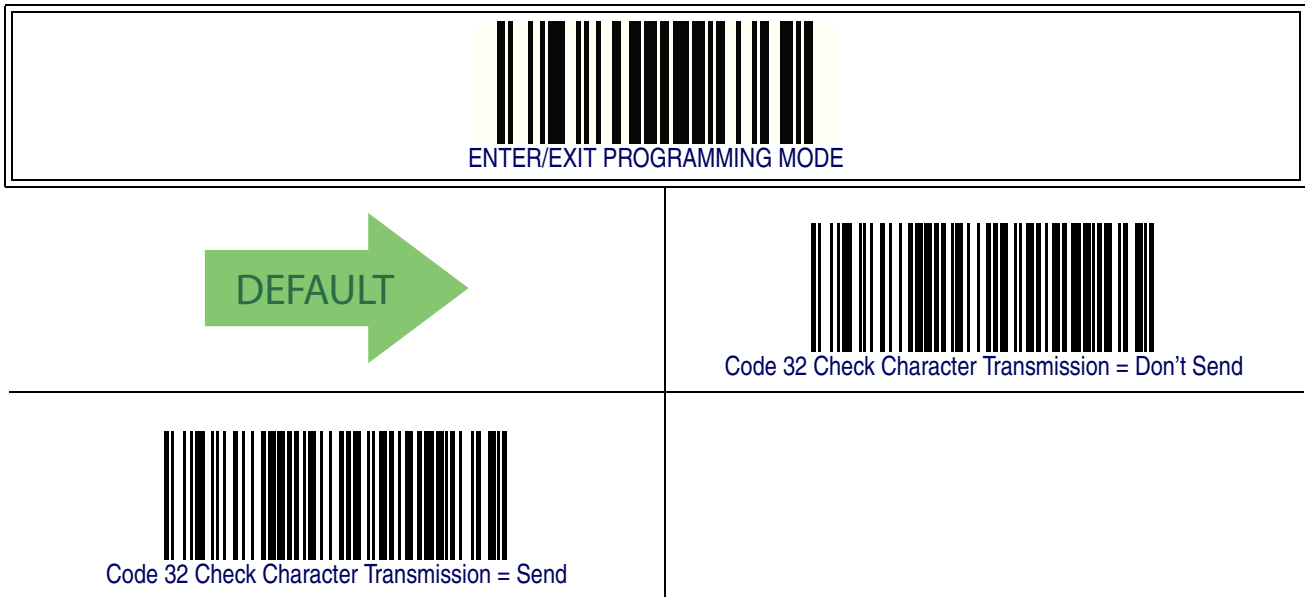

Code 32 Start/Stop Character Transmission

This option enables/disables transmission of Code 32 start and stop characters.

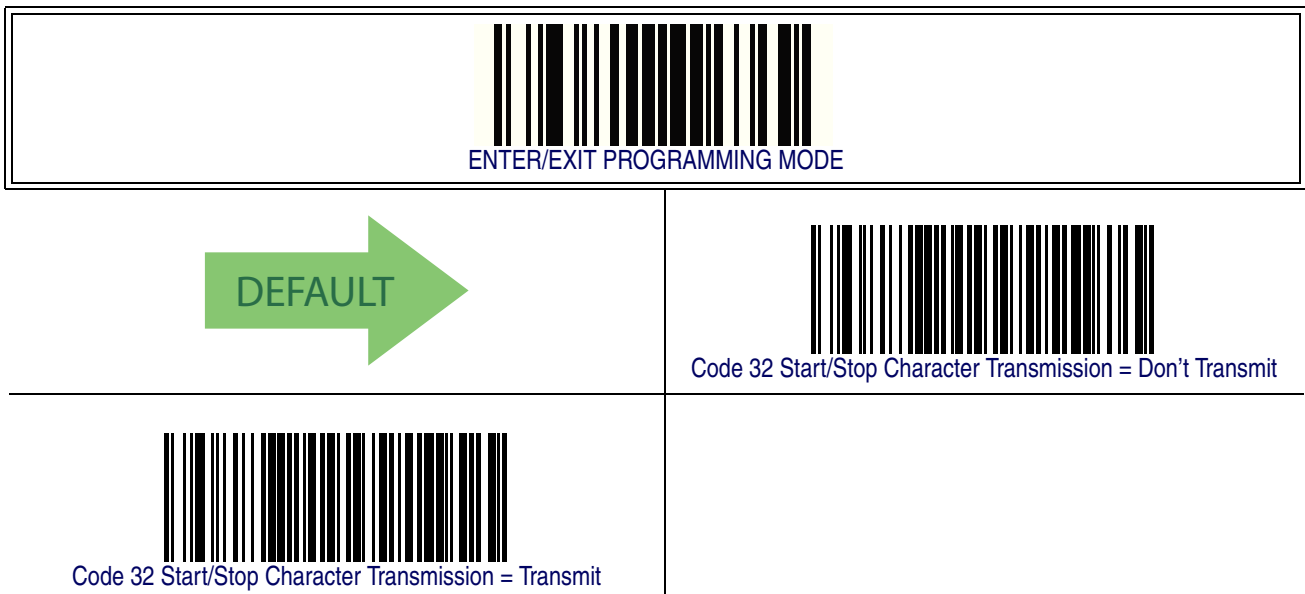

Code 39 CIP (French Pharmaceutical)

The following options apply to the Code 39 CIP symbology.

Code 39 CIP Enable/Disable

Enables/Disables ability of the reader to decode Code 39 CIP labels.

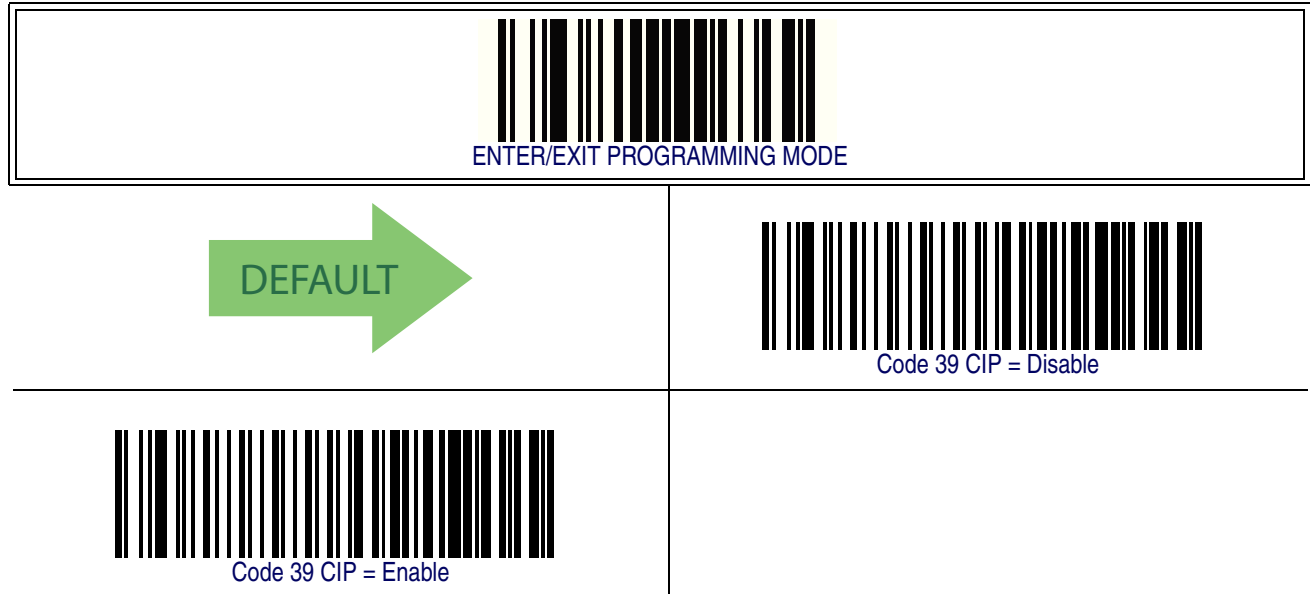

Code 128

The following options apply to the Code 128 symbology.

Code 128 Enable/Disable

When disabled, the reader will not read Code 128 barcodes.



Code 128 – cont.

Expand Code 128 to Code 39

This feature enables/disables expansion of Code 128 labels to Code 39 labels.

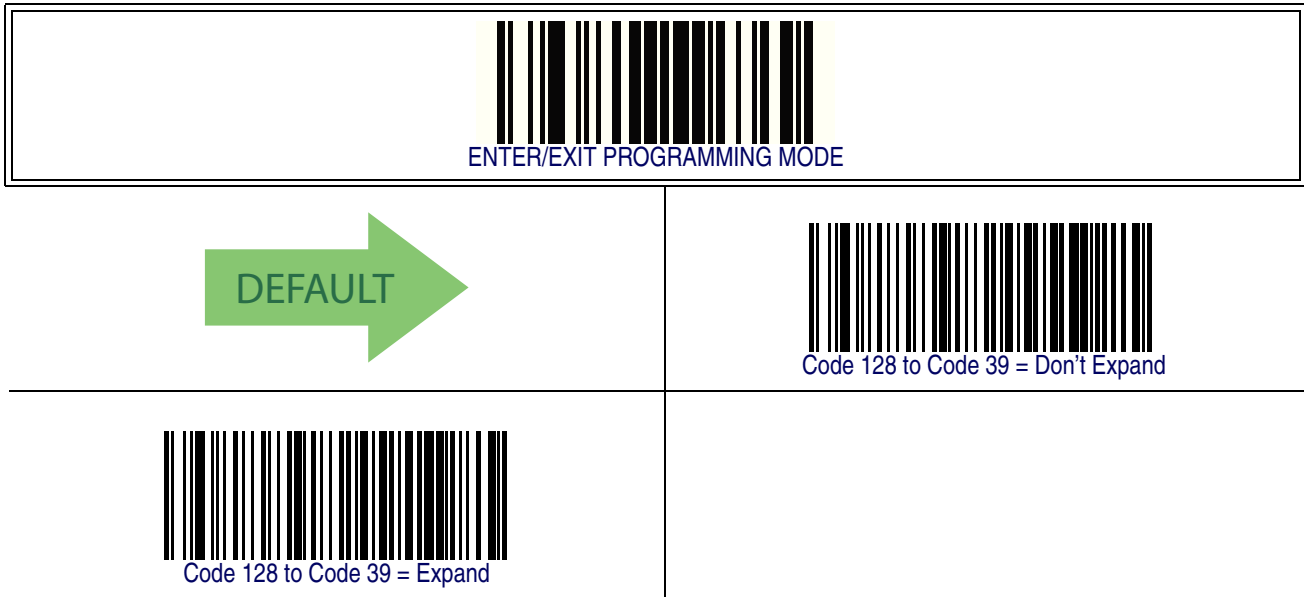

Code 128 Check Character Transmission

Enable this option to transmit the check character along with Code 128 barcode data.

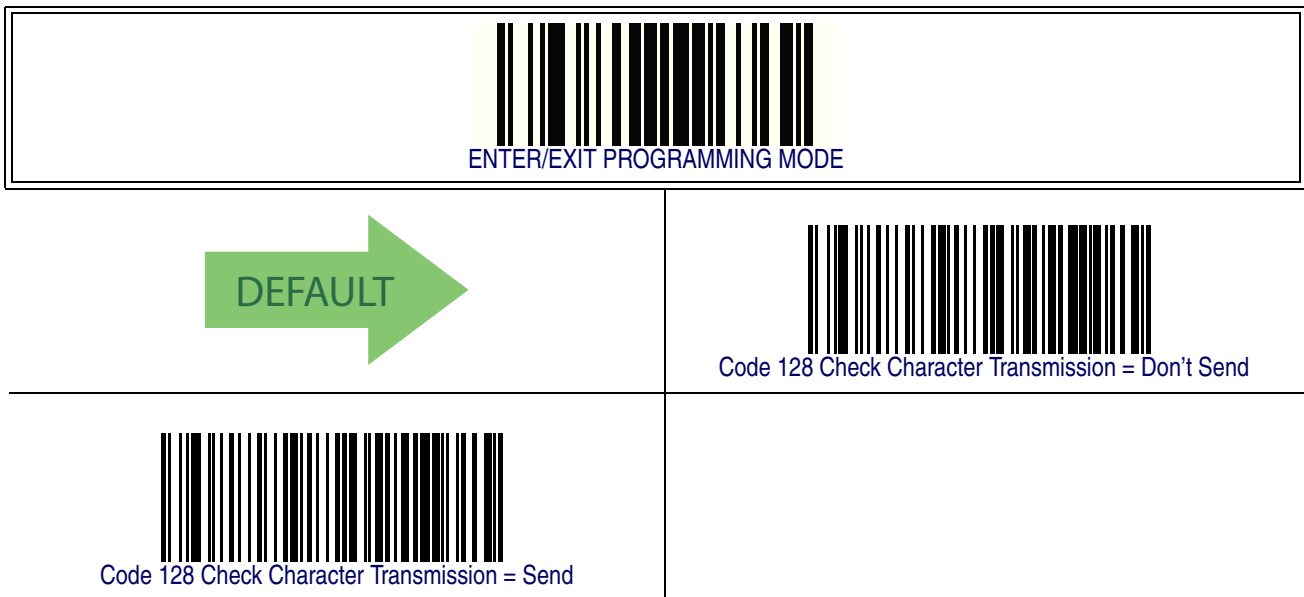

Code 128 – cont.

Code 128 Function Character Transmission

Enables/disables transmission of Code128 function characters 1, 2, 3, and 4.

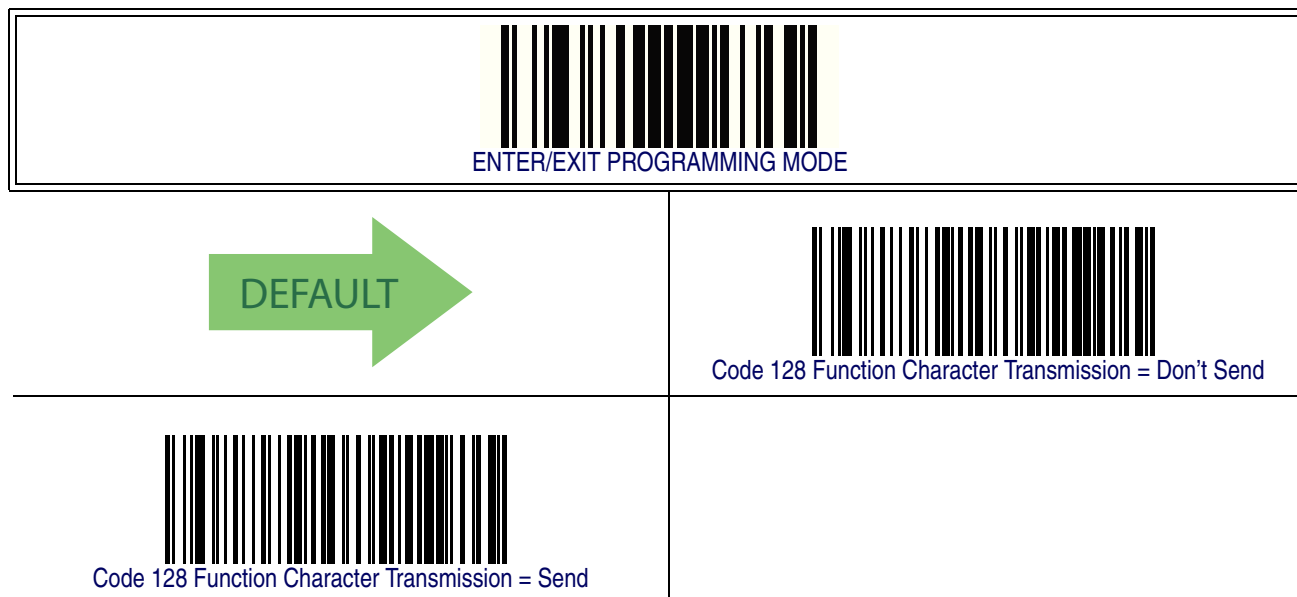

Code 128 – cont.

Code 128 Sub-Code Change Transmission

Enables/disables the transmission of “Sub-Code exchange” characters (NOT transmitted by standard decoding).

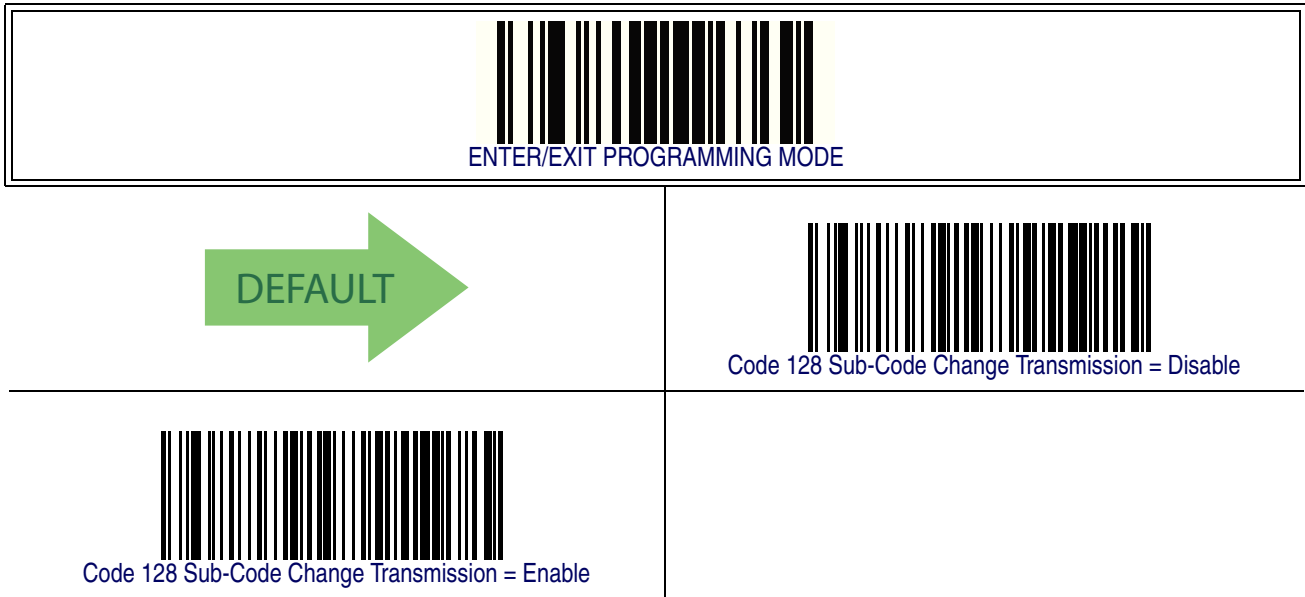

Code 128 – cont.

Code 128 Quiet Zones

This feature specifies the number of quiet zones for Code 128 labels. Quiet zones are blank areas at the ends of a barcode and are typically 10 times the width of the narrowest bar or space in the label.

 ENTER/EXIT PROGRAMMING MODE	
	 Code 128 Quiet Zones = No Quiet Zones
 Code 128 Quiet Zones = Quiet Zone on one side	
	 Code 128 Quiet Zones = Quiet Zones on two sides
 Code 128 Quiet Zones = Auto	
	 Code 128 Quiet Zones = Virtual Quiet Zones on two sides

Code 128 – cont.

Code 128 Minimum Reads

This feature specifies the minimum number of consecutive times a Code 128 label must be decoded before it is accepted as good read..



Code 128 — cont.

Code 128 Decoding Level

Decoding Levels are used to configure a barcode symbology decoder to be very aggressive to very conservative depending on a particular customer's needs.

- Choosing Level 1 results in a very conservative decoder at the expense of not being able to read poorly printed or damaged labels.
- Choosing Level 5 results in a very aggressive decoder. This aggressive behavior allows decoding of poorly printed and damaged labels at the expense of increasing the likelihood of decoding errors.
- Choosing Level 3, which is the default setting, allows the majority of product labels to be decoded.

There are many factors that determine when to change the decoding level for a particular symbology. These factors include spots, voids, non-uniform bar/space widths, damaged labels, etc. that may be experienced in some barcode labels. If there are many hard to read or damaged labels that cannot be decoded using a conservative setting, increase the decoding level to be more aggressive. If the majority of labels are very good quality labels, or there is a need to decrease the possibility of a decoder error, lower the decoding level to a more conservative level.

Code 128 – cont.

Code 128 Decoding Level – cont.

 ENTER/EXIT PROGRAMMING MODE	
 Code 128 Decoding Level = 1	
	 Code 128 Decoding Level = 2
 Code 128 Decoding Level = 3	 DEFAULT
	 Code 128 Decoding Level = 4
 Code 128 Decoding Level = 5	

Code 128 – cont.

Code 128 Length Control

This feature specifies either variable length decoding or fixed length decoding for the Code 128 symbology.

Variable Length – For variable length decoding, a minimum and maximum length may be set.

Fixed Length – For fixed length decoding, two different lengths may be set.

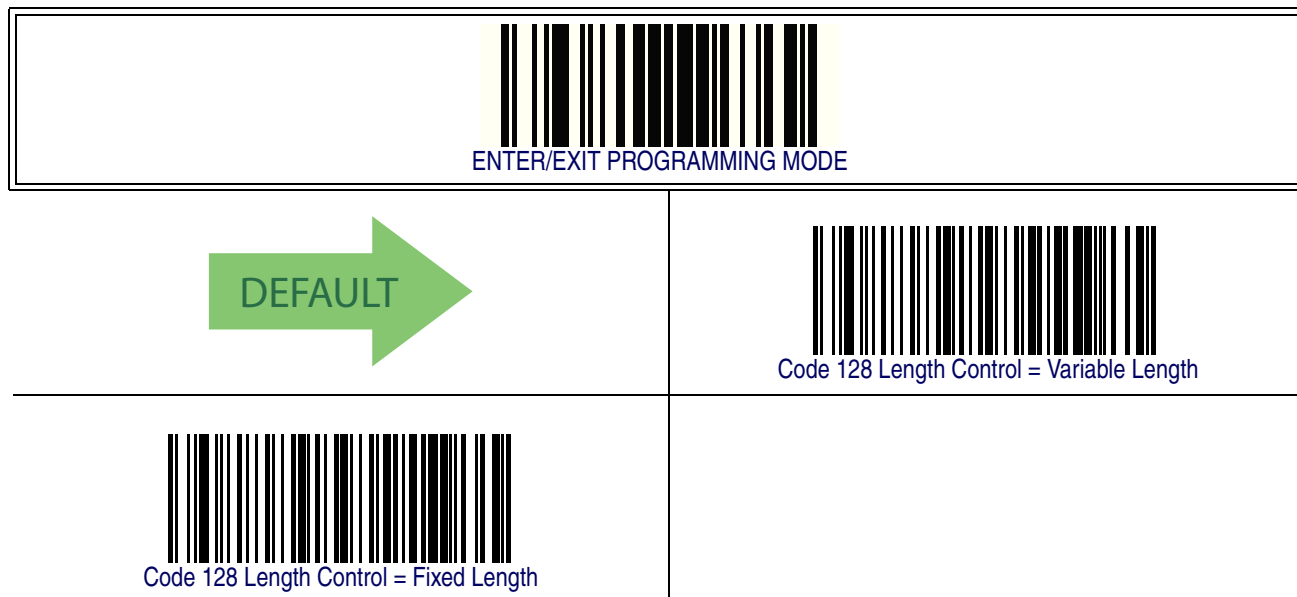

Code 128 – cont.

Code 128 Set Length 1

This feature specifies one of the barcode lengths for [Code 128 Length Control](#). Length 1 is the minimum label length if in [Variable Length](#) Mode, or the first fixed length if in [Fixed Length](#) Mode. Length includes the barcode’s data characters only. The length can be set from 1 to 80 characters.

Follow these instructions to set this feature:

1. Determine the desired character length (from 1 to 80). Pad the number with leading zeroes to yield two digits. For example: 0 = 00, 5 = 05, 20 = 20, etc.
2. Scan the ENTER/EXIT PROGRAMMING MODE barcode to enter Programming Mode.
3. Scan the barcode: SELECT CODE 128 LENGTH 1 SETTING.
4. Scan the appropriate two digits from the keypad in [Appendix E, Keypad](#), that represent the length setting which was determined in the steps above. You will hear a two-beep indication after the last character.



If you make a mistake before the last character, scan the CANCEL barcode to abort and not save the entry string. You can then start again at the beginning.

NOTE

5. Scan the ENTER/EXIT PROGRAMMING MODE barcode to exit Programming Mode.



This completes the procedure. See [Table 23](#) for some examples of how to set this feature.

Table 23. Code 128 Length 1 Setting Examples

STEP	ACTION	EXAMPLES			
1	Desired Setting	01 Character	07 Characters	15 Characters	80 Characters
2	Scan ENTER/EXIT PROGRAMMING MODE				
3	Scan SELECT CODE 128 LENGTH 1 SETTING				
4	Scan Two Characters From Appendix E, Keypad	'0' and '1'	'0' and '7'	'1' and '5'	'8' AND '0'
5	Scan ENTER/EXIT PROGRAMMING MODE				

Code 128 – cont.

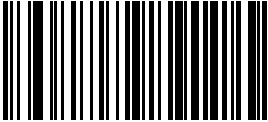
Code 128 Set Length 1 – cont.

 ENTER/EXIT PROGRAMMING MODE	
 Select Code 128 Set Length 1 Setting	
Make a mistake? Scan the CANCEL barcode to abort and not save the entry string. You can then start again at the beginning.	 CANCEL

 01 = Length 1 is 1 Character

Code 128 – cont.

Code 128 Set Length 2

This feature specifies one of the barcode lengths for [Code 128 Length Control](#). Length 2 is the maximum label length if in [Variable Length Mode](#), or the second fixed length if in [Fixed Length Mode](#). Length includes the barcode’s data characters only.

The length can be set from 1 to 80 characters. A setting of 0 specifies to ignore this length (only one fixed length).

Follow these instructions to set this feature:

1. Determine the desired character length (from 1 to 80 — or 0 to ignore this length). Pad the number with leading zeroes to yield two digits. For example: 0 = 00, 5 = 05, 20 = 20, etc.
2. Scan the ENTER/EXIT PROGRAMMING MODE barcode to enter Programming Mode.
3. Scan the barcode: SELECT CODE 128 LENGTH 2 SETTING.
4. Scan the appropriate two digits from the keypad in [Appendix E, Keypad](#), that represent the length setting which was determined in the steps above. You will hear a two-beep indication after the last character.



If you make a mistake before the last character, scan the CANCEL barcode to abort and not save the entry string. You can then start again at the beginning.

NOTE

5. Scan the ENTER/EXIT PROGRAMMING MODE barcode to exit Programming Mode.

This completes the procedure. See [Table 24](#) for some examples of how to set this feature.

Table 24. Code 128 Length 2 Setting Examples

STEP	ACTION	EXAMPLES			
1	Desired Setting	00 (Ignore This Length)	07 Characters	15 Characters	80 Characters
2	Scan ENTER/EXIT PROGRAMMING MODE				
3	Scan SELECT CODE 128 LENGTH 2 SETTING				
4	Scan Two Characters From Appendix E, Keypad	'0' and '0'	'0' and '7'	'0' and 'F'	'5' AND '0'
5	Scan ENTER/EXIT PROGRAMMING MODE				

Code 128 – cont.

Code 128 Set Length 2 – cont.

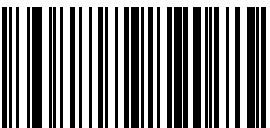
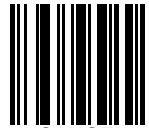
 ENTER/EXIT PROGRAMMING MODE	
 Select Code 128 Length 2 Setting	
Make a mistake? Scan the CANCEL barcode to abort and not save the entry string. You can then start again at the beginning.	 CANCEL

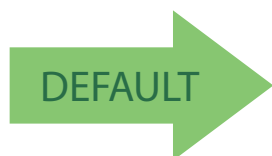

80 = Length 2 is 80 Characters

Code 128 – cont.

Code 128 Character Correlation

When correlation is enabled, the barcode reader will combine label data from multiple scans when decoding. Enabling correlation will help the scanner read labels that have some spots and/or voids. It may also help read labels that have damaged areas. Enabling correlation will also increase the chances that a label will be read incorrectly.

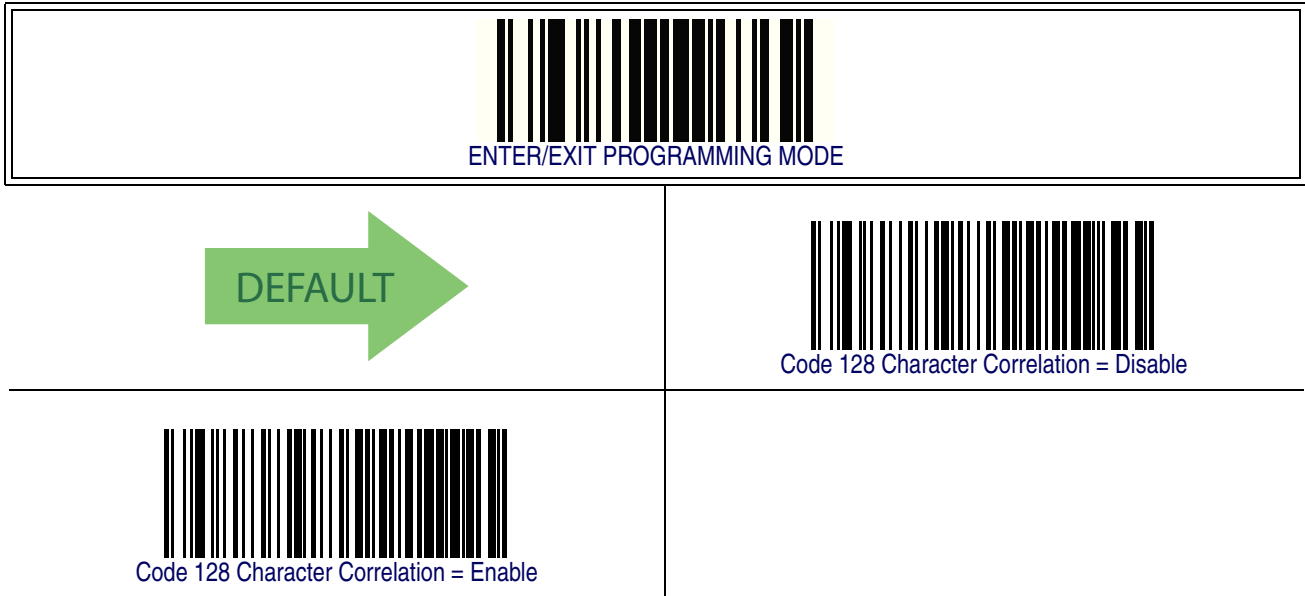

Code 128 – cont.

Code 128 Stitching

This option enables/disables stitching for Code 128 labels. When parts of a Code 128 barcode are presented to the reader with this feature enabled, the barcode parts will be assembled by the reader's software, and the data will be decoded if all barcode proofing requirements are met.



GS1-128

The following options apply to the GS1-128 symbology. (Also known as USS-128, GTIN-128, UCC-128, EAN 128.)

GS1-128 Enable

This option enables/disables the ability of the reader to translate GS1-128 labels to the GS1-128 data format. Options are:

- Transmit GS1-128 labels in Code 128 data format.
- Transmit GS1-128 labels in GS1-128 data format.
- Do not transmit GS1-128 labels.

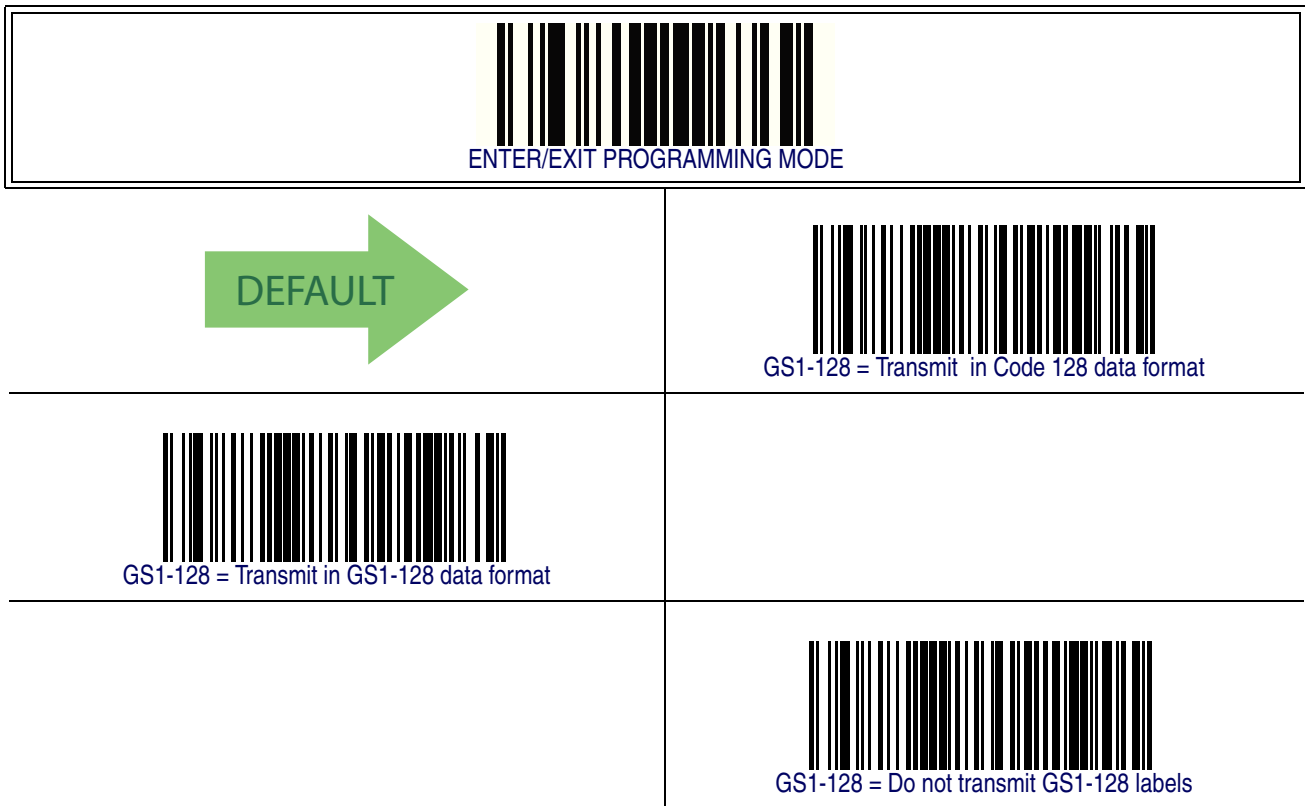

Interleaved 2 of 5 (I 2 of 5)

The following options apply to the I 2 of 5 symbology.

I 2 of 5 Enable/Disable

When disabled, the reader will not read I 2 of 5 barcodes.

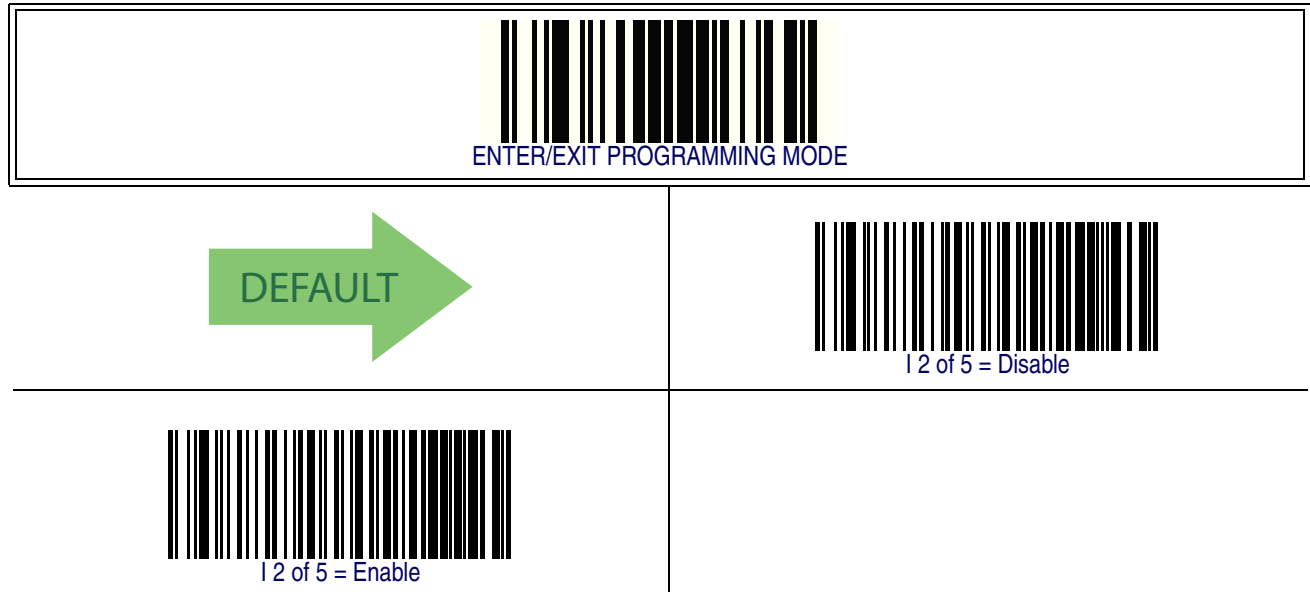

Interleaved 2 of 5 (I 2 of 5) – cont.

I 2 of 5 Check Character Calculation

This option enables/disables calculation and verification of an optional I 2 of 5 check character. When disabled, any check character in label is treated as a data character.

 ENTER/EXIT PROGRAMMING MODE	
	 I 2 of 5 Check Character Calculation = Disable
 I 2 of 5 Check Character Calculation = Check Standard (Modulo 10)	
	 I 2 of 5 Check Character Calculation = Check German Parcel
 I 2 of 5 Check Character Calculation = Check DHL	
	 I 2 of 5 Check Character Calculation = Check Daimler Chrysler
 I 2 of 5 Check Character Calculation = Check Bosch	

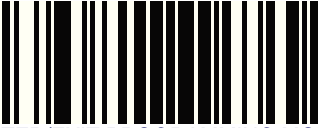
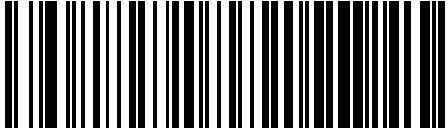

Interleaved 2 of 5 (I 2 of 5) – cont.

I 2 of 5 Check Character Calculation – cont.

 ENTER/EXIT PROGRAMMING MODE	
	 I 2 of 5 Check Character Calculation = Check Italian Post

I 2 of 5 Check Character Transmission

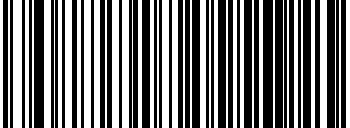
Enable this option to transmit the check character along with I 2 of 5 barcode data.

 ENTER/EXIT PROGRAMMING MODE	
	 I 2 of 5 Check Character Transmission = Don't Send
 I 2 of 5 Check Character Transmission = Send	 DEFAULT

Interleaved 2 of 5 (I 2 of 5) – cont.

I 2 of 5 Minimum Reads

This feature specifies the minimum number of consecutive times an I 2 of 5 label must be decoded before it is accepted as good read..



Interleaved 2 of 5 (I 2 of 5) – cont.

I 2 of 5 Decoding Level



This configuration item applies to Interleaved 2 of 5, Datalogic 2 of 5 and Standard 2 of 5.

NOTE

Decoding Levels are used to configure a barcode symbology decoder to be very aggressive to very conservative depending on a particular customer's needs.

- Choosing Level 1 results in a very conservative decoder at the expense of not being able to read poorly printed or damaged labels.
- Choosing Level 5 results in a very aggressive decoder. This aggressive behavior allows decoding of poorly printed and damaged labels at the expense of increasing the likelihood of decoding errors.
- Choosing Level 3, which is the default setting, allows the majority of product labels to be decoded.

There are many factors that determine when to change the decoding level for a particular symbology. These factors include spots, voids, non-uniform bar/space widths, damaged labels, etc. that may be experienced in some barcode labels. If there are many hard to read or damaged labels that cannot be decoded using a conservative setting, increase the decoding level to be more aggressive. If the majority of labels are very good quality labels, or there is a need to decrease the possibility of a decoder error, lower the decoding level to a more conservative level.

Interleaved 2 of 5 (I 2 of 5) – cont.

I 2 of 5 Decoding Level – cont.

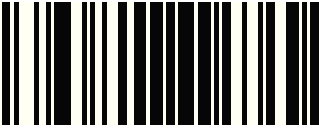
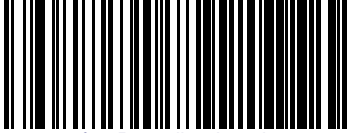
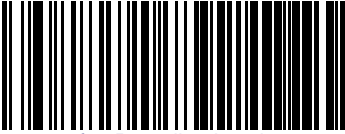
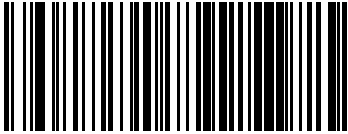
 ENTER/EXIT PROGRAMMING MODE	
 2 of 5 Decoding Level = 1	
	 2 of 5 Decoding Level = 2
 2 of 5 Decoding Level = 3	 DEFAULT
	 2 of 5 Decoding Level = 4
 2 of 5 Decoding Level = 5	

Interleaved 2 of 5 (I 2 of 5) – cont.

I 2 of 5 Length Control

This feature specifies either variable length decoding or fixed length decoding for the I 2 of 5 symbology.

Variable Length – For variable length decoding, a minimum and maximum length may be set.

Fixed Length – For fixed length decoding, two different lengths may be set.



Interleaved 2 of 5 (I 2 of 5) – cont.

I 2 of 5 Set Length 1

This feature specifies one of the barcode lengths for **I 2 of 5 Length Control**. Length 1 is the minimum label length if in **Variable Length Mode**, or the first fixed length if in **Fixed Length Mode**. The length includes the barcode's check and data characters. The length can be set from 2 to 50 characters in increments of two.

Follow these instructions to set this feature:

1. Determine the desired character length (from 2 to 50). The length must be an even number.
2. Pad the result with leading zeroes to yield two digits. For example: 0 = 00, 5 = 05, 20 = 20, etc.
3. Scan the ENTER/EXIT PROGRAMMING MODE barcode to enter Programming Mode.
4. Scan the barcode: SELECT I 2 of 5 LENGTH 1 SETTING.
5. Scan the appropriate two digits from the keypad in **Appendix E, Keypad**, that represent the length setting which was determined in the steps above. You will hear a two-beep indication after the last character.



If you make a mistake before the last character scan the CANCEL barcode to abort and not save the entry string. You can then start again at the beginning.

NOTE

6. Scan the ENTER/EXIT PROGRAMMING MODE barcode to exit Programming Mode.



This completes the procedure. See **Table 27** for some examples of how to set this feature.

Table 25. I 2 of 5 Length 1 Setting Examples

STEP	ACTION	EXAMPLES			
1	Desired Setting	2 Characters	6 Characters	14 Characters	50 Characters
2	Pad with leading zeroes to yield two digits	02	06	14	50
3	Scan ENTER/EXIT PROGRAMMING MODE				
4	Scan SELECT I 2 of 5 LENGTH 1 SETTING				
5	Scan Two Characters From Appendix E, Keypad	'0' and '2'	'0' and '6'	'1' and '4'	'5' AND '0'
6	Scan ENTER/EXIT PROGRAMMING MODE				

Interleaved 2 of 5 (I 2 of 5) – cont.

Datalogic 2 of 5 Set Length 1 – cont.

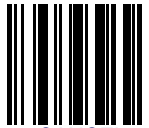
 ENTER/EXIT PROGRAMMING MODE	
 Select I 2 of 5 Length 1 Setting	
Make a mistake? Scan the CANCEL barcode to abort and not save the entry string. You can then start again at the beginning.	 CANCEL

 06 = Length 1 is 6 Characters

Interleaved 2 of 5 (I 2 of 5) – cont.

I 2 of 5 Set Length 2

This feature specifies one of the barcode lengths for **I 2 of 5 Length Control**. Length 2 is the maximum label length if in **Variable Length Mode**, or the second fixed length if in **Fixed Length Mode**. The length includes the barcode’s check and data characters. The length can be set from 2 to 50 characters. A setting of 0 specifies to ignore this length (only one fixed length).

Follow these instructions to set this feature:

1. Determine the desired character length (from 2 to 50, or 0 to ignore this length). The length must be an even number.
2. Pad the number with leading zeroes to yield two digits. For example: 0 = 00, 5 = 05, 20 = 20, etc.
3. Scan the ENTER/EXIT PROGRAMMING MODE barcode to enter Programming Mode.
4. Scan the barcode: SELECT I 2 of 5 LENGTH 2 SETTING.
5. Scan the appropriate two digits from the keypad in [Appendix E, Keypad](#), that represent the length setting which was determined in the steps above. You will hear a two-beep indication after the last character.



NOTE

If you make a mistake before the last character, scan the **CANCEL** barcode to abort and not save the entry string. You can then start again at the beginning.

6. Scan the ENTER/EXIT PROGRAMMING MODE barcode to exit Programming Mode.

This completes the procedure. See [Table 28](#) for some examples of how to set this feature.

Table 26. I 2 of 5 Length 2 Setting Examples

STEP	ACTION	EXAMPLES			
		Ignore This Length	4 Characters	14 Characters	50 Characters
1	Desired Setting				
2	Pad with leading zeroes to yield two digits	00	04	14	50
3	Scan ENTER/EXIT PROGRAMMING MODE				
4	Scan SELECT I 2 OF 5 LENGTH 2 SETTING				
5	Scan Two Characters From Appendix E, Keypad	'0' and '0'	'0' and '4'	'1' and '4'	'5' AND '0'
6	Scan ENTER/EXIT PROGRAMMING MODE				

Interleaved 2 of 5 (I 2 of 5) – cont.

I 2 of 5 Set Length 2 – cont.

 ENTER/EXIT PROGRAMMING MODE
--

 Select I 2 of 5 Length 2 Setting	
---	--

Make a mistake? Scan the CANCEL barcode to abort and not save the entry string. You can then start again at the beginning.	 CANCEL
--	---

 50 = Length 2 is 50 Characters

Interleaved 2 of 5 (I 2 of 5) – cont.

I 2 of 5 Character Correlation

When correlation is enabled, the barcode reader will combine label data from multiple scans when decoding. Enabling correlation will help the scanner read labels that have some spots and/or voids. It may also help read labels that have damaged areas. Enabling correlation will also increase the chances that a label will be read incorrectly.

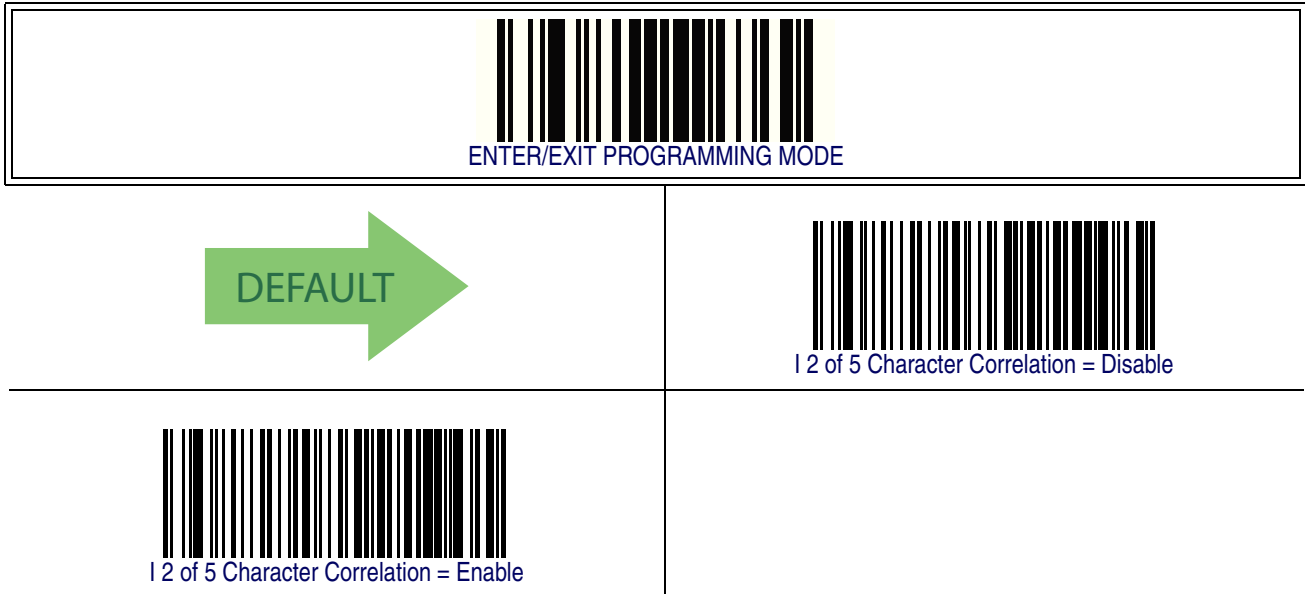

Interleaved 2 of 5 (I 2 of 5) – cont.

I 2 of 5 Stitching

This option enables/disables stitching for I 2 of 5 labels. When parts of a I 2 of 5 barcode are presented to the reader with this feature enabled, the barcode parts will be assembled by the reader's software, and the data will be decoded if all barcode proofing requirements are met.

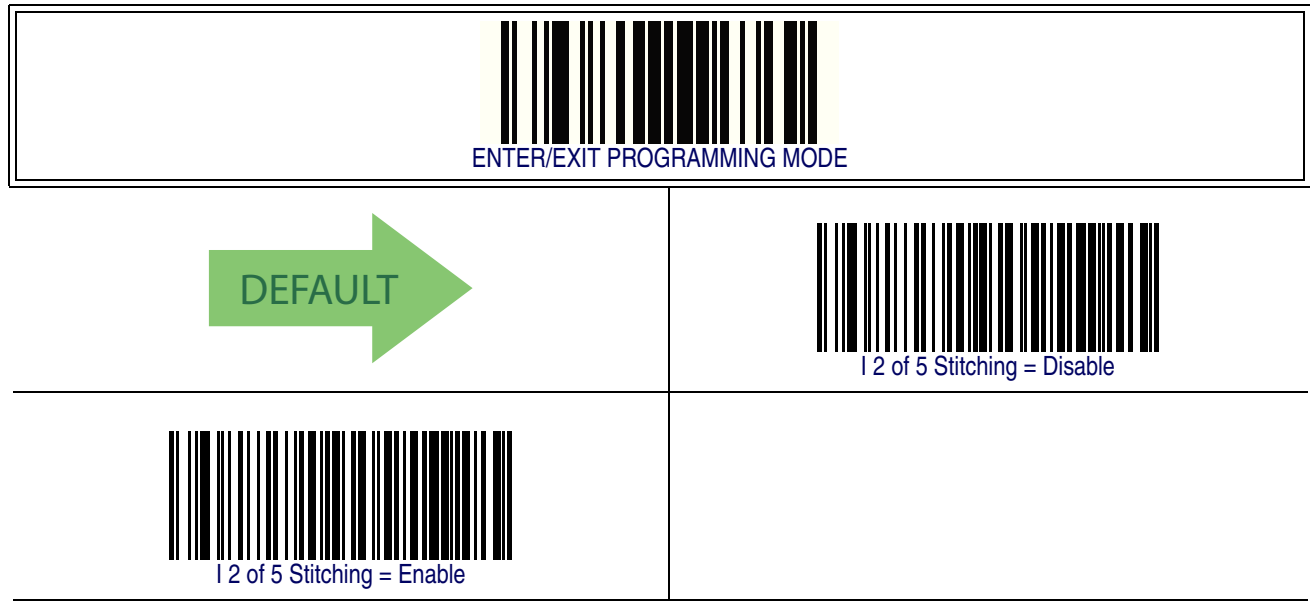

Interleaved 2 of 5 CIP HR

The following options apply to the Interleaved 2 of 5 CIP HR symbology.

Interleaved 2 of 5 CIP HR Enable/Disable

Enables/Disables ability of reader to decode Interleaved 2 of 5 CIP HR labels.



Datalogic 2 of 5

The following options apply to the Datalogic 2 of 5 symbology.

Datalogic 2 of 5 Enable/Disable

When disabled, the reader will not read Datalogic 2 of 5 barcodes.



Datalogic 2 of 5 – cont.

Datalogic 2 of 5 Check Character Calculation

This option enables/disables calculation and verification of an optional Datalogic 2 of 5 check character.

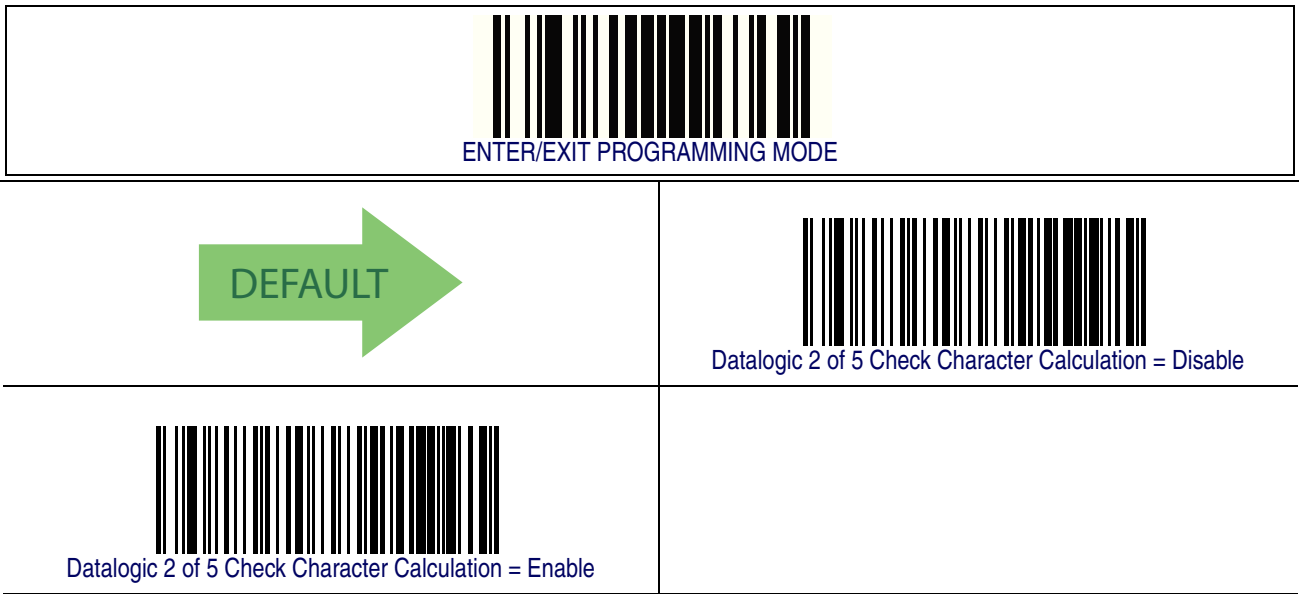

Datalogic 2 of 5 – cont.

Datalogic 2 of 5 Minimum Reads

This feature specifies the minimum number of consecutive times an Datalogic 2 of 5 label must be decoded before it is accepted as good read.



Datalogic 2 of 5 Decoding Level



The Datalogic 2 of 5 Decoding Level feature is set using [1 of 5 Decoding Level](#) on page 211.

NOTE

Datalogic 2 of 5 – cont.

Datalogic 2 of 5 Length Control

This feature specifies either variable length decoding or fixed length decoding for the Datalogic 2 of 5 symbology.

Variable Length – For variable length decoding, a minimum and maximum length may be set.

Fixed Length – For fixed length decoding, two different lengths may be set.



Datalogic 2 of 5 – cont.

Datalogic 2 of 5 Set Length 1

This feature specifies one of the barcode lengths for [Datalogic 2 of 5 Length Control](#). Length 1 is the minimum label length if in [Variable Length](#) Mode, or the first fixed length if in [Fixed Length](#) Mode. The length includes the barcode’s check and data characters.

The length can be set from 2 to 50 characters in increments of two.

Follow these instructions to set this feature:

1. Determine the desired character length (from 2 to 50). The length must be an even number.
2. Pad the result with leading zeroes to yield two digits. For example: 0 = 00, 5 = 05, 20 = 20, etc.
3. Scan the ENTER/EXIT PROGRAMMING MODE barcode to enter Programming Mode.
4. Scan the barcode: SELECT I 2 of 5 LENGTH 1 SETTING.
5. Scan the appropriate two digits from the keypad in [Appendix E, Keypad](#), that represent the length setting which was determined in the steps above. You will hear a two-beep indication after the last character.



If you make a mistake before the last character scan the CANCEL barcode to abort and not save the entry string. You can then start again at the beginning.

NOTE

6. Scan the ENTER/EXIT PROGRAMMING MODE barcode to exit Programming Mode.

This completes the procedure. See [Table 27](#) for some examples of how to set this feature.

Table 27. Datalogic 2 of 5 Length 1 Setting Examples

STEP	ACTION	EXAMPLES			
1	Desired Setting	2 Characters	6 Characters	14 Characters	50 Characters
2	Pad with leading zeroes to yield two digits	02	06	14	50
3	Scan ENTER/EXIT PROGRAMMING MODE				
4	Scan SELECT Datalogic 2 of 5 LENGTH 1 SETTING				
5	Scan Two Characters From Appendix E, Keypad	'0' and '2'	'0' and '6'	'1' and '4'	'5' AND '0'
6	Scan ENTER/EXIT PROGRAMMING MODE				

Datalogic 2 of 5 – cont.

Datalogic 2 of 5 Set Length 1 – cont.

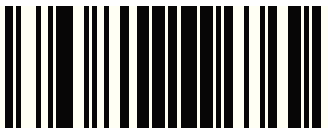
 ENTER/EXIT PROGRAMMING MODE
--

 Select Datalogic 2 of 5 Length 1 Setting

Make a mistake? Scan the CANCEL barcode to abort and not save the entry string. You can then start again at the beginning.

 CANCEL

 06 = Length 1 is 6 Characters

Datalogic 2 of 5 – cont.

Datalogic 2 of 5 Set Length 2

This feature specifies one of the barcode lengths for [Datalogic 2 of 5 Length Control](#). Length 2 is the maximum label length if in [Variable Length](#) Mode, or the second fixed length if in [Fixed Length](#) Mode. The length includes the barcode's check and data characters.

The length can be set from 2 to 50 characters. A setting of 0 specifies to ignore this length (only one fixed length).

Follow these instructions to set this feature:

1. Determine the desired character length (from 2 to 50, or 0 to ignore this length). The length must be an even number.
2. Pad the number with leading zeroes to yield two digits. For example: 0 = 00, 5 = 05, 20 = 20, etc.
3. Scan the ENTER/EXIT PROGRAMMING MODE barcode to enter Programming Mode.
4. Scan the barcode: SELECT Datalogic 2 of 5 LENGTH 2 SETTING.
5. Scan the appropriate two digits from the keypad in [Appendix E, Keypad](#), that represent the length setting which was determined in the steps above. You will hear a two-beep indication after the last character.



NOTE

If you make a mistake before the last character, scan the CANCEL barcode to abort and not save the entry string. You can then start again at the beginning.

6. Scan the ENTER/EXIT PROGRAMMING MODE barcode to exit Programming Mode.

This completes the procedure. See [Table 28](#) for some examples of how to set this feature.

Table 28. Datalogic 2 of 5 Length 2 Setting Examples

STEP	ACTION	EXAMPLES			
1	Desired Setting	Ignore This Length	4 Characters	14 Characters	50 Characters
2	Pad with leading zeroes to yield two digits	00	04	14	50
3	Scan ENTER/EXIT PROGRAMMING MODE				
4	Scan SELECT DATALOGIC 2 OF 5 LENGTH 2 SETTING				
5	Scan Two Characters From Appendix E, Keypad	'0' and '0'	'0' and '4'	'1' and '4'	'5' AND '0'
6	Scan ENTER/EXIT PROGRAMMING MODE				

Datalogic 2 of 5 – cont.

Datalogic 2 of 5 Set Length 2 – cont.

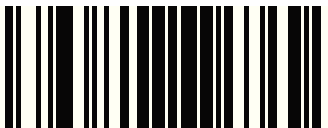
 ENTER/EXIT PROGRAMMING MODE
--

 Select Datalogic 2 of 5 Length 2 Setting	
---	--

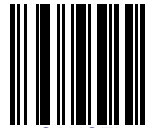
Make a mistake? Scan the CANCEL barcode to abort and not save the entry string. You can then start again at the beginning.	 CANCEL
--	---

 50 = Length 2 is 50 Characters

Datalogic 2 of 5 – cont.

Datalogic 2 of 5 Interdigit Maximum Ratio

This feature specifies the maximum ratio between intercharacter space and module for Datalogic 2 of 5.

 ENTER/EXIT PROGRAMMING MODE	
	 Datalogic 2 of 5 Interdigit Maximum Ratio = Disable
 Datalogic 2 of 5 Interdigit Maximum Ratio = 1	
	 Datalogic 2 of 5 Interdigit Maximum Ratio = 2
 Datalogic 2 of 5 Interdigit Maximum Ratio = 3	
 DEFAULT	 Datalogic 2 of 5 Interdigit Maximum Ratio = 4
 Datalogic 2 of 5 Interdigit Maximum Ratio = 5	

Datalogic 2 of 5 Interdigit Maximum Ratio – cont.

	 <p>Datalogic 2 of 5 Interdigit Maximum Ratio = 6</p>
 <p>Datalogic 2 of 5 Interdigit Maximum Ratio = 7</p>	
	 <p>Datalogic 2 of 5 Interdigit Maximum Ratio = 8</p>
 <p>Datalogic 2 of 5 Interdigit Maximum Ratio = 9</p>	
	 <p>Datalogic 2 of 5 Interdigit Maximum Ratio = 10</p>

Datalogic 2 of 5 – cont.

Datalogic 2 of 5 Character Correlation

When correlation is enabled, the barcode reader will combine label data from multiple scans when decoding. Enabling correlation will help the scanner read labels that have some spots and/or voids. It may also help read labels that have damaged areas. Enabling correlation will also increase the chances that a label will be read incorrectly.

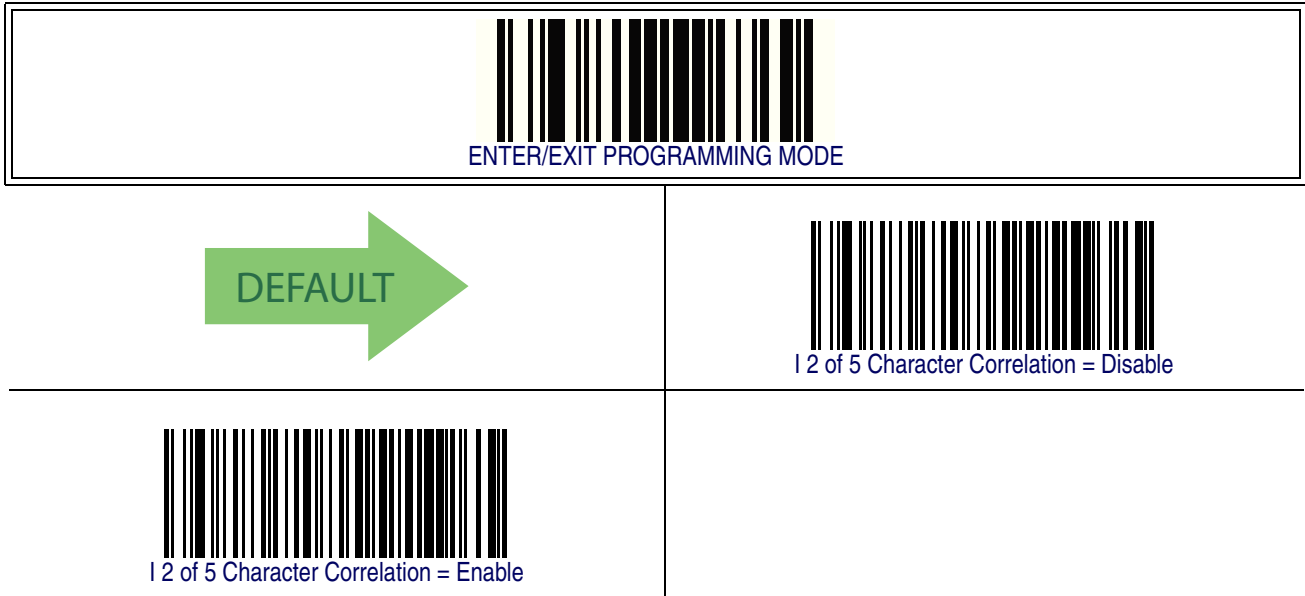

Datalogic 2 of 5 – cont.

Datalogic 2 of 5 Stitching

This option enables/disables stitching for Datalogic 2 of 5 labels. When parts of a Datalogic 2 of 5 barcode are presented to the reader with this feature enabled, the barcode parts will be assembled by the reader's software, and the data will be decoded if all barcode proofing requirements are met.



Codabar

The following options apply to the Codabar symbology.

Codabar Enable/Disable

When disabled, the reader will not read Codabar barcodes.

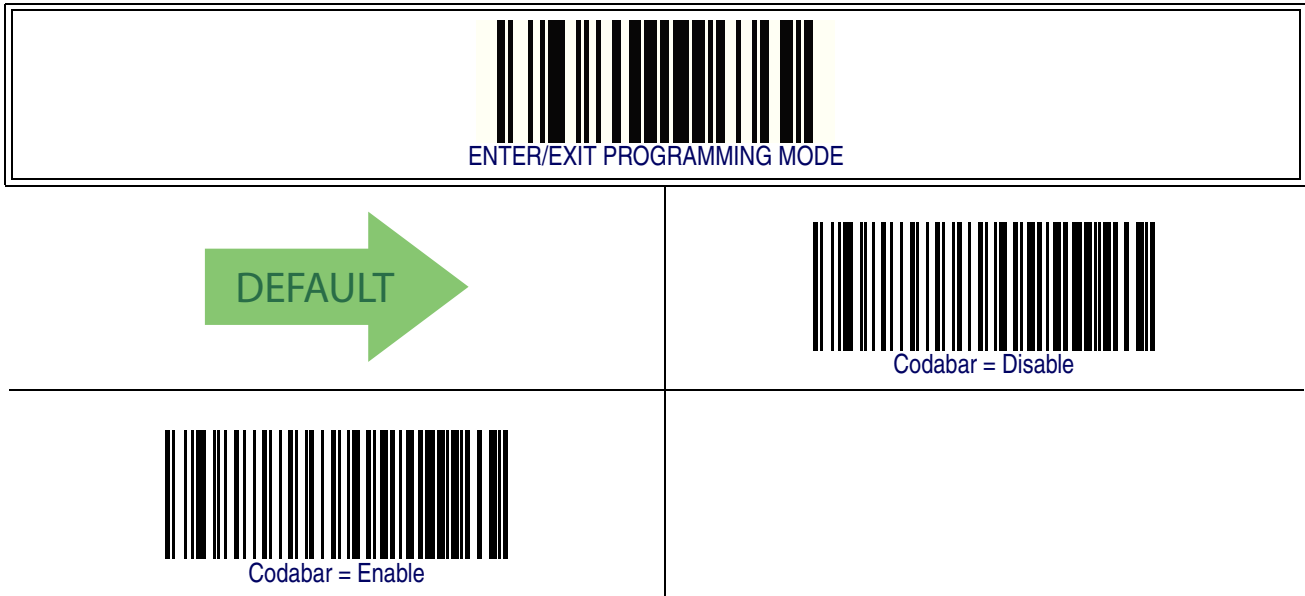

Codabar — cont.

Codabar Check Character Calculation

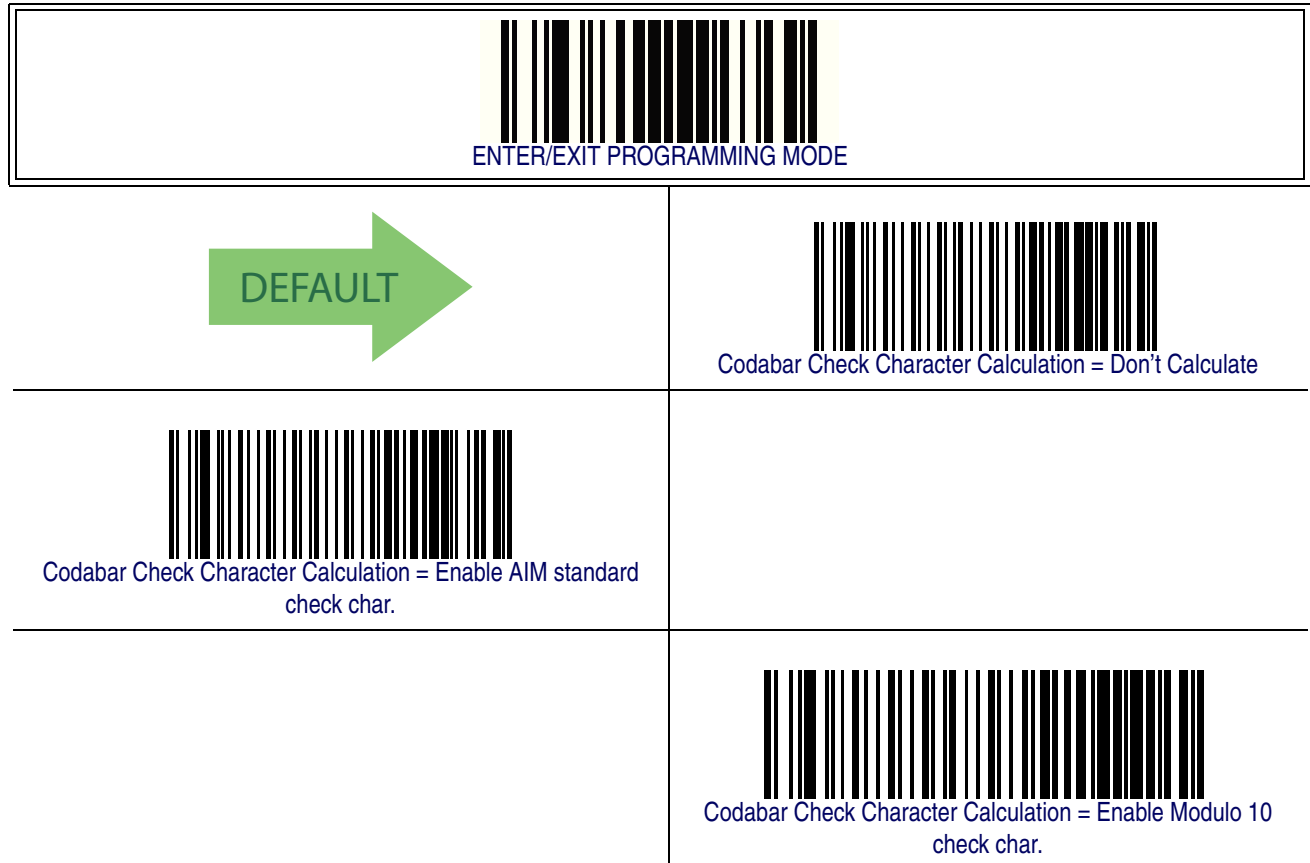

Enable this option to enables/disables calculation and verification of an optional Codabar check character. When disabled, any check character in the label is treated as a data character



Codabar – cont.

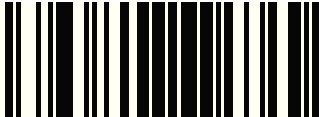
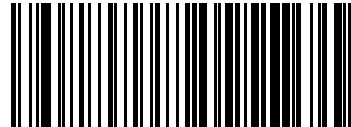
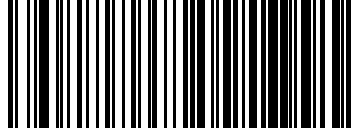

Codabar Check Character Transmission

Enable this option to transmit the check character along with Codabar barcode data.

 ENTER/EXIT PROGRAMMING MODE	
	 Codabar Check Character Transmission = Don't Send
 Codabar Check Character Transmission = Send	 DEFAULT

Codabar Start/Stop Character Transmission

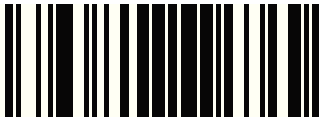
Enable this option to enable/disable transmission of Codabar start and stop characters.

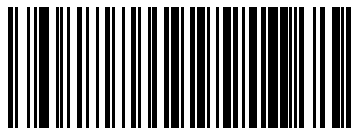
 ENTER/EXIT PROGRAMMING MODE	
 DEFAULT	 Codabar Start/Stop Character Transmission = Don't Transmit
 Codabar Start/Stop Character Transmission = Transmit	

Codabar — cont.

Codabar Start/Stop Character Set

This option specifies the format of transmitted Codabar start/stop characters.

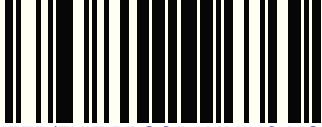
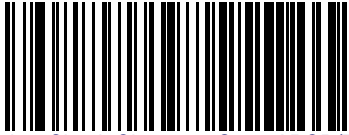
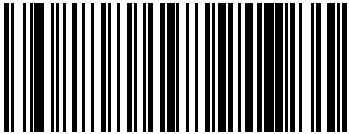
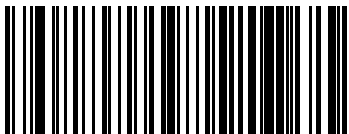
 <p>ENTER/EXIT PROGRAMMING MODE</p>	
	 <p>Codabar Check Character Set = ABCD/TN*E</p>
 <p>Codabar Check Character Set = ABCD/ABCD</p>	
	 <p>Codabar Check Character Set = abcd/tn*e</p>
 <p>Codabar Check Character Set = abcd/abcd</p>	 <p>DEFAULT</p>

Codabar — cont.

Codabar Start/Stop Character Match

When enabled, this option requires that start and stop characters match.

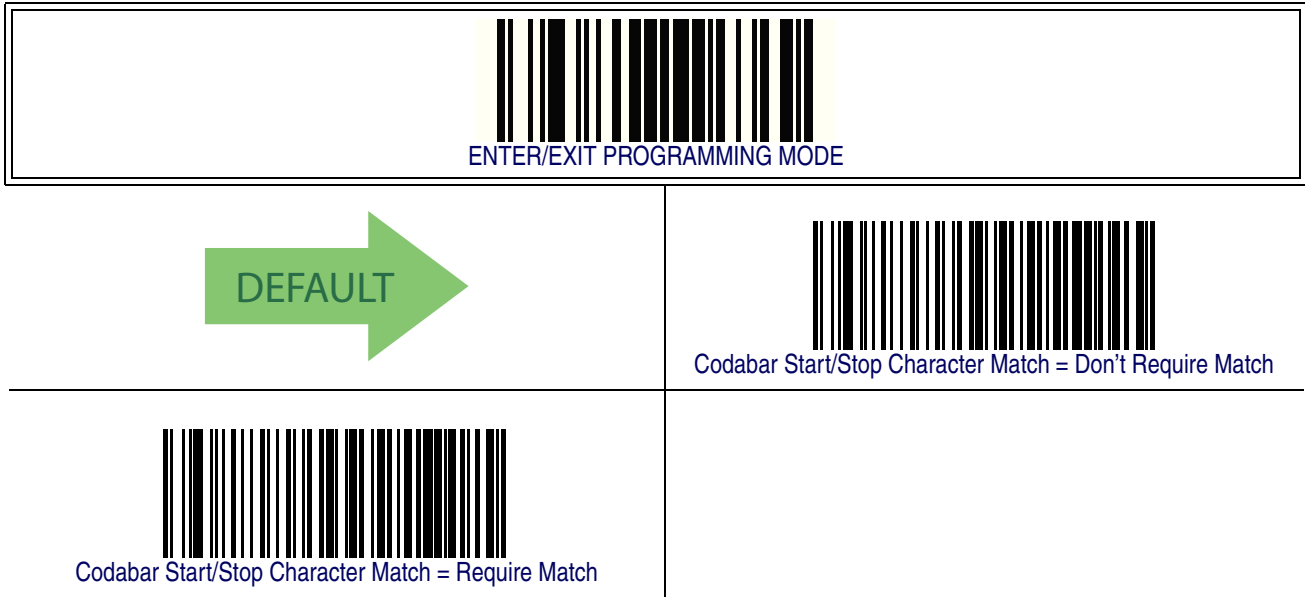

Codabar — cont.

Codabar Quiet Zones

This feature specifies the number of quiet zones for Codabar labels. Quiet zones are blank areas at the ends of a barcode and are typically 10 times the width of the narrowest bar or space in the label.

 ENTER/EXIT PROGRAMMING MODE	
 Codabar Quiet Zones = Quiet Zone on one side	
	 Codabar Quiet Zones = Quiet Zones on two sides
 Codabar Quiet Zones = Auto	 DEFAULT
	 Codabar Quiet Zones = Virtual Quiet Zones on two sides
 Codabar Quiet Zones = Small Quiet Zones on two sides	

Codabar – cont.

Codabar Minimum Reads

This feature specifies the minimum number of consecutive times a Codabar label must be decoded before it is accepted as good read..



Codabar — cont.

Codabar Decoding Level

Decoding Levels are used to configure a barcode symbology decoder to be very aggressive to very conservative depending on a particular customer's needs.

- Choosing Level 1 results in a very conservative decoder at the expense of not being able to read poorly printed or damaged labels.
- Choosing Level 5 results in a very aggressive decoder. This aggressive behavior allows decoding of poorly printed and damaged labels at the expense of increasing the likelihood of decoding errors.
- Choosing Level 3, which is the default setting, allows the majority of product labels to be decoded.

There are many factors that determine when to change the decoding level for a particular symbology. These factors include spots, voids, non-uniform bar/space widths, damaged labels, etc. that may be experienced in some barcode labels. If there are many hard to read or damaged labels that cannot be decoded using a conservative setting, increase the decoding level to be more aggressive. If the majority of labels are very good quality labels, or there is a need to decrease the possibility of a decoder error, lower the decoding level to a more conservative level.

Codabar – cont.

Codabar Decoding Level – cont.

 ENTER/EXIT PROGRAMMING MODE	
 Codabar Decoding Level = 1	
	 Codabar Decoding Level = 2
 Codabar Decoding Level = 3	 DEFAULT
	 Codabar Decoding Level = 4
 Codabar Decoding Level = 5	

Codabar — cont.

Codabar Length Control

This feature specifies either variable length decoding or fixed length decoding for the Codabar symbology.

Variable Length — For variable length decoding, a minimum and maximum length may be set.

Fixed Length — For fixed length decoding, two different lengths may be set.

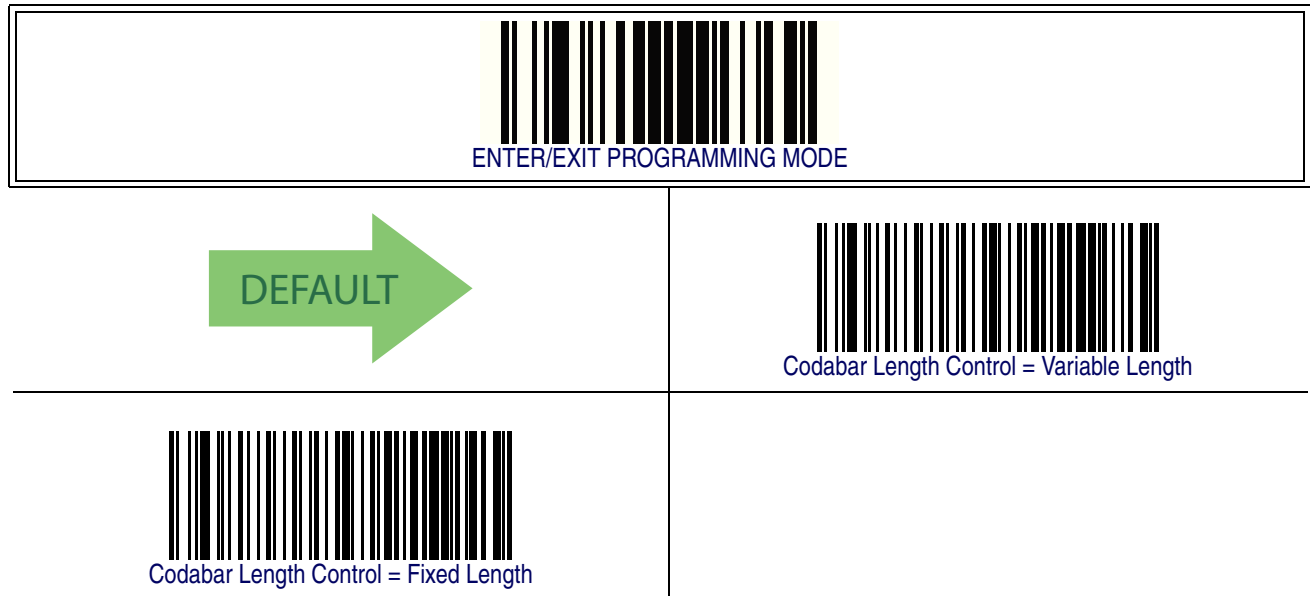

Codabar – cont.

Codabar Set Length 1

This feature specifies one of the barcode lengths for **Codabar Length Control**. Length 1 is the minimum label length if in **Variable Length Mode**, or the first fixed length if in **Fixed Length Mode**. Length includes the barcode’s start, stop, check and data characters. The length must include at least one data character. The length can be set from 3 to 50 characters.

Follow these instructions to set this feature:

1. Determine the desired character length (from 3 to 50). Pad the number with leading zeroes to yield two digits. For example: 0 = 00, 5 = 05, 20 = 20, etc.
2. Scan the ENTER/EXIT PROGRAMMING MODE barcode to enter Programming Mode.
3. Scan the barcode: SELECT CODABAR LENGTH 1 SETTING.
4. Scan the appropriate two digits from the keypad in **Appendix E, Keypad**, that represent the length setting which was determined in the steps above. You will hear a two-beep indication after the last character.



If you make a mistake before the last character, scan the CANCEL barcode to abort and not save the entry string. You can then start again at the beginning.

NOTE

5. Scan the ENTER/EXIT PROGRAMMING MODE barcode to exit Programming Mode.

This completes the procedure. See **Table 29** for some examples of how to set this feature.

Table 29. Codabar Length 1 Setting Examples

STEP	ACTION	EXAMPLES			
1	Desired Setting (and pad with leading zeroes)	03 Characters	09 Characters	15 Characters	50 Characters
2	Scan ENTER/EXIT PROGRAMMING MODE				
3	Scan SELECT CODABAR LENGTH 1 SETTING				
4	Scan Two Characters From Appendix E, Keypad	'0' and '3'	'0' and '9'	'1' and '5'	'5' AND '0'
5	Scan ENTER/EXIT PROGRAMMING MODE				

Codabar – cont.

Codabar Set Length 1 – cont.

 ENTER/EXIT PROGRAMMING MODE
--

 Select Codabar Length 1 Setting
--

--

Make a mistake? Scan the CANCEL barcode to abort and not save the entry string. You can then start again at the beginning.

 CANCEL

 03 = Length 1 is 3 Characters

Codabar – cont.

Codabar Set Length 2

This feature specifies one of the barcode lengths for [Codabar Length Control](#). Length 2 is the maximum label length if in [Variable Length Mode](#), or the second fixed length if in [Fixed Length Mode](#). The length includes the barcode’s start, stop, check and data characters. The length must include at least one data character.

The length can be set from 3 to 50 characters. A setting of 0 specifies to ignore this length (only one fixed length).

Follow these instructions to set this feature:

1. Determine the desired character length (from 3 to 50 — or 0 to ignore this length). Pad the number with leading zeroes to yield two digits. For example: 0 = 00, 5 = 05, 20 = 20, etc.
2. Scan the ENTER/EXIT PROGRAMMING MODE barcode to enter Programming Mode.
3. Scan the barcode: SELECT CODABAR LENGTH 2 SETTING.
4. Scan the appropriate two digits from the keypad in [Appendix E, Keypad](#), that represent the length setting which was determined in the steps above. You will hear a two-beep indication after the last character.



If you make a mistake before the last character, scan the CANCEL barcode to abort and not save the entry string. You can then start again at the beginning.

NOTE

5. Scan the ENTER/EXIT PROGRAMMING MODE barcode to exit Programming Mode.

This completes the procedure. See [Table 30](#) for some examples of how to set this feature.

Table 30. Codabar Length 2 Setting Examples

STEP	ACTION	EXAMPLES			
1	Desired Setting (and pad with leading zeroes)	00 Ignore This Length	07 Characters	15 Characters	50 Characters
2	Scan ENTER/EXIT PROGRAMMING MODE				
3	Scan SELECT CODE 39 LENGTH 2 SETTING				
4	Scan Two Characters From Appendix E, Keypad	'0' and '0'	'0' and '7'	'1' and '5'	'5' AND '0'
5	Scan ENTER/EXIT PROGRAMMING MODE				

Codabar – cont.

Codabar Set Length 2 – cont.

 ENTER/EXIT PROGRAMMING MODE
--

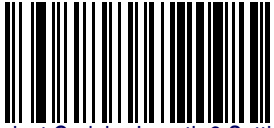
 Select CodabarLength 2 Setting	
---	--



Make a mistake? Scan the CANCEL barcode to abort and not save the entry string. You can then start again at the beginning.	 CANCEL
--	---

 50 = Length 2 is 50 Characters

Codabar — cont.

Codabar Interdigit Ratio

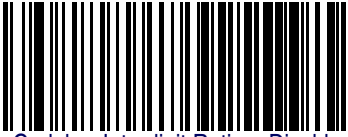
This feature specifies the ratio between an intercharacter space and module for Codabar labels.

 ENTER/EXIT PROGRAMMING MODE	
	 Codabar Interdigit Ratio = Disable
 Codabar Interdigit Ratio = 1	
	 Codabar Interdigit Ratio = 2
 Codabar Interdigit Ratio = 3	
 DEFAULT	 Codabar Interdigit Ratio = 4
 Codabar Interdigit Ratio = 5	

Codabar – cont.

Codabar Interdigit Ratio – cont.

 ENTER/EXIT PROGRAMMING MODE	
	 Codabar Interdigit Ratio = 6
 Codabar Interdigit Ratio = 7	
	 Codabar Interdigit Ratio = 8
 Codabar Interdigit Ratio = 9	
	 Codabar Interdigit Ratio = 10

Codabar – cont.

Codabar Character Correlation

When correlation is enabled, the barcode reader will combine label data from multiple scans when decoding. Enabling correlation will help the scanner read labels that have some spots and/or voids. It may also help read labels that have damaged areas. Enabling correlation will also increase the chances that a label will be read incorrectly.

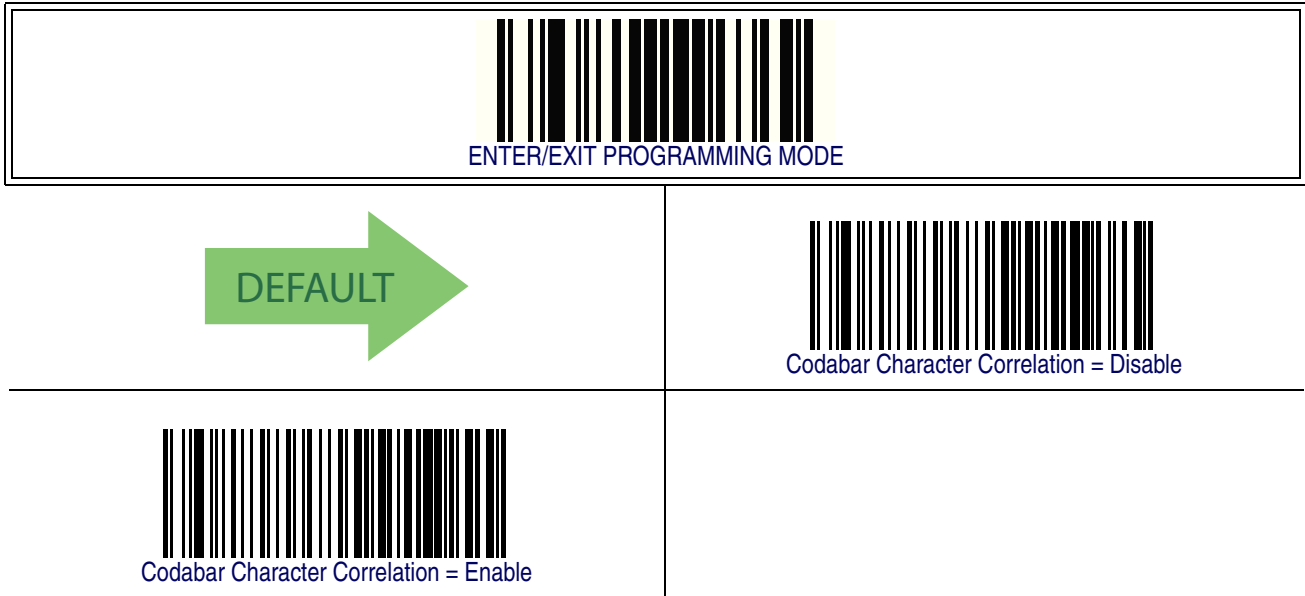

Codabar — cont.

Codabar Stitching

This option enables/disables stitching for Codabar labels. When parts of a Codabar barcode are presented to the reader with this feature enabled, the barcode parts will be assembled by the reader's software, and the data will be decoded if all barcode proofing requirements are met.

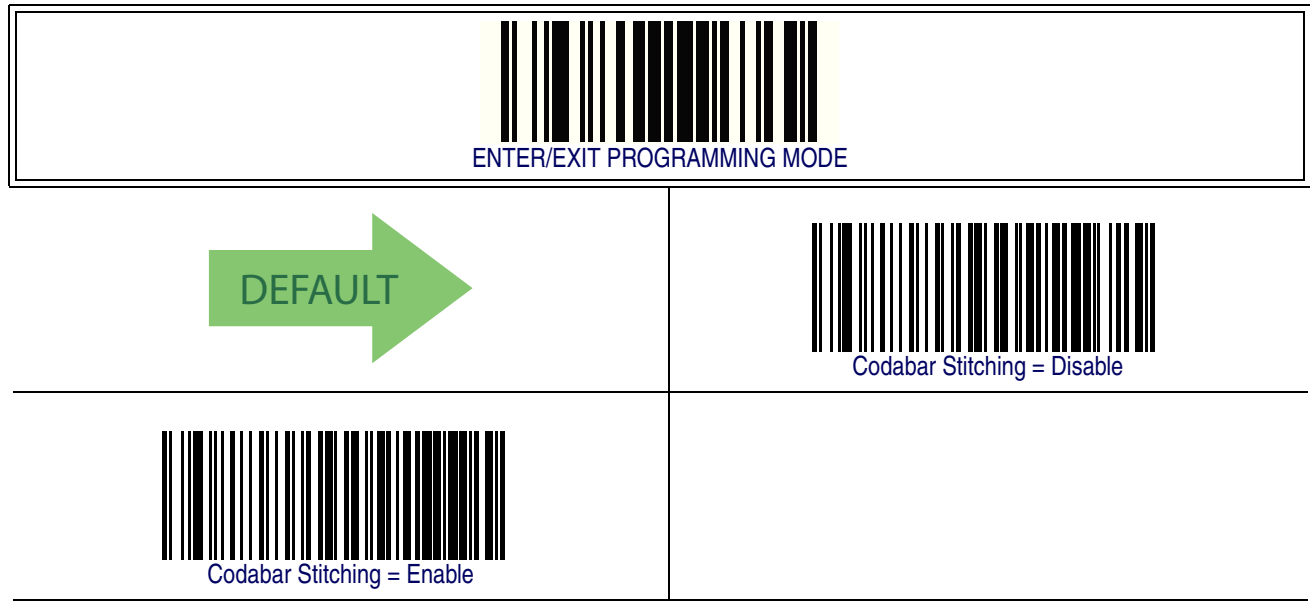

ABC Codabar

The following options apply to the ABC Codabar symbology.

ABC Codabar Enable/Disable

Enables/Disables ability of reader to decode ABC Codabar labels.



ABC Codabar Concatenation Mode

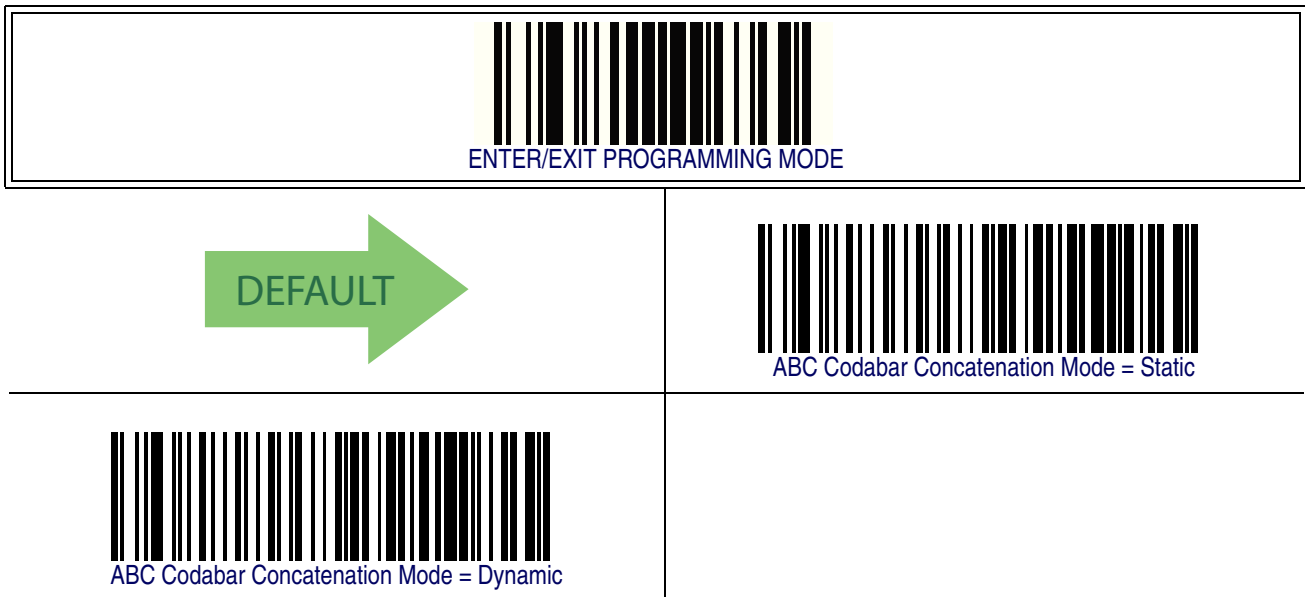

Specifies the concatenation mode between Static and Dynamic.



ABC Codabar – cont.

ABC Codabar Dynamic Concatenation Timeout

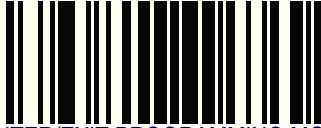
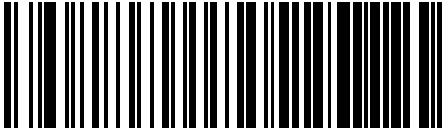
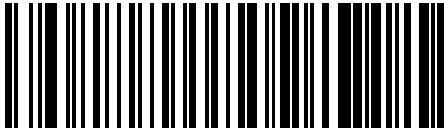
Specifies the timeout in 10-millisecond ticks used by the ABC Codabar Dynamic Concatenation Mode.

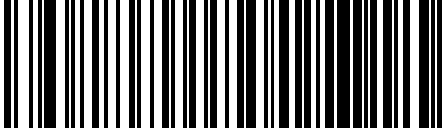
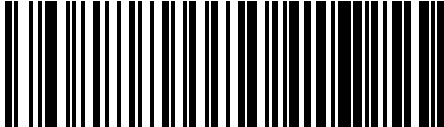
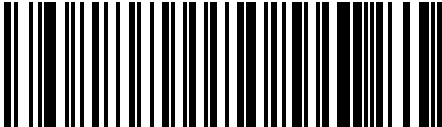
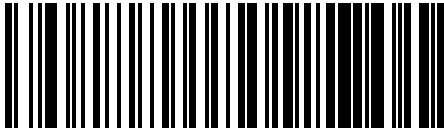
 ENTER/EXIT PROGRAMMING MODE	
	 ABC Codabar Dynamic Concatenation Timeout = 50 msec
 ABC Codabar Dynamic Concatenation Timeout = 100 msec	
	 ABC Codabar Dynamic Concatenation Timeout = 200 msec
 ABC Codabar Dynamic Concatenation Timeout = 500 msec	
	 ABC Codabar Dynamic Concatenation Timeout = 750 msec
 ABC Codabar Dynamic Concatenation Timeout = 1 Second	

ABC Codabar — cont.

ABC Codabar Force Concatenation

Forces labels starting or ending with D to be concatenated.



Code 11

The following options apply to the Code 11 symbology.

Code 11 Enable/Disable

When disabled, the reader will not read Code 11 barcodes.

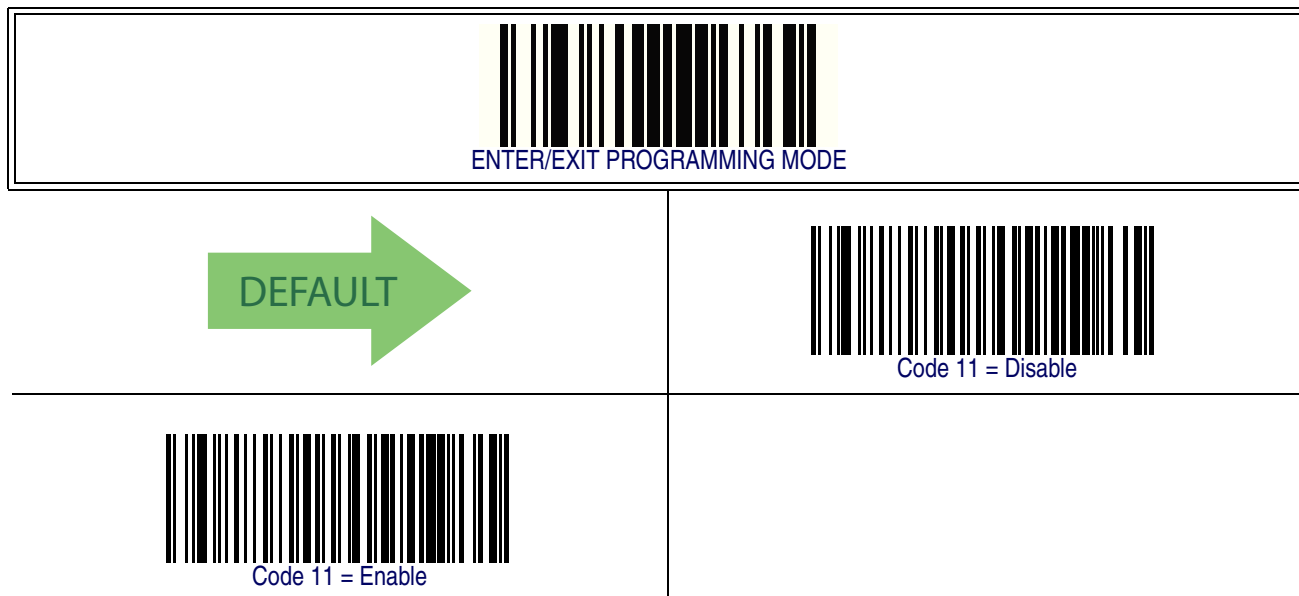

Code 11 – cont.

Code 11 Check Character Calculation

This option enables/disables calculation and verification of optional Code 11 check character.

 ENTER/EXIT PROGRAMMING MODE	
	 Code 11 Check Character Calculation = Disable
 Code 11 Check Character Calculation = Check C	
	 Code 11 Check Character Calculation = Check K
 Code 11 Check Character Calculation = Check C and K	 DEFAULT

Code 11 – cont.

Code 11 Check Character Transmission

This feature enables/disables transmission of an optional Code 11 check character.

 ENTER/EXIT PROGRAMMING MODE	
	 Code 11 Check Character Transmission = Don't Send
 Code 11 Check Character Transmission = Send	 DEFAULT

Code 11 – cont.

Code 11 Minimum Reads

This feature specifies the minimum number of consecutive times a Code 93 label must be decoded before it is accepted as good read..



Code 11 — cont.

Code 11 Length Control

This feature specifies either variable length decoding or fixed length decoding for the Code 11 symbology.

Variable Length — For variable length decoding, a minimum and maximum length may be set.

Fixed Length — For fixed length decoding, two different lengths may be set.



Code 11 – cont.

Code 11 Set Length 1

This feature specifies one of the barcode lengths for **Code 11 Length Control**. Length 1 is the minimum label length if in **Variable Length Mode**, or the first fixed length if in **Fixed Length Mode**. Length includes the barcode’s check and data characters. The length can be set from 2 to 50 characters.

Follow these instructions to set this feature:

1. Determine the desired character length (from 2 to 50). Pad the number with leading zeroes to yield two digits. For example: 0 = 00, 5 = 05, 20 = 20, etc.
2. Scan the ENTER/EXIT PROGRAMMING MODE barcode to enter Programming Mode.
3. Scan the barcode: SELECT CODE 11 LENGTH 1 SETTING.
4. Scan the appropriate two digits from the keypad in **Appendix E, Keypad**, that represent the length setting which was determined in the steps above. You will hear a two-beep indication after the last character.



If you make a mistake before the last character, scan the CANCEL barcode to abort and not save the entry string. You can then start again at the beginning.

NOTE

5. Scan the ENTER/EXIT PROGRAMMING MODE barcode to exit Programming Mode.

This completes the procedure. See **Table 31** for some examples of how to set this feature.

Table 31. Code 11 Length 1 Setting Examples

STEP	ACTION	EXAMPLES			
1	Desired Setting (pad with leading zeroes)	02 Characters	07 Characters	15 Characters	50 Characters
2	Scan ENTER/EXIT PROGRAMMING MODE				
3	Scan SELECT CODE 11 LENGTH 1 SETTING				
4	Scan Two Characters From Appendix E, Keypad	'0' and '2'	'0' and '7'	'1' and '5'	'5' AND '0'
5	Scan ENTER/EXIT PROGRAMMING MODE				

Code 11 – cont.

Code 11 Set Length 1 – cont.

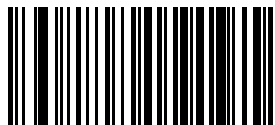

Select Code 11 Set Length 1 Setting

Make a mistake? Scan the CANCEL barcode to abort and not save the entry string. You can then start again at the beginning.

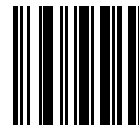

CANCEL

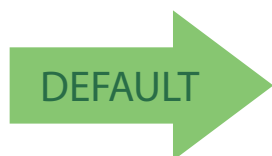

04 = Length 1 is 4 Characters

Code 11 – cont.

Code 11 Set Length 2

This feature specifies one of the barcode lengths for [Code 11 Length Control](#). Length 2 is the maximum label length if in [Variable Length Mode](#), or the second fixed length if in [Fixed Length Mode](#). Length includes the barcode's check and data characters.

The length can be set from 2 to 50 characters. A setting of 0 specifies to ignore this length (only one fixed length).

Follow these instructions to set this feature:

1. Determine the desired character length (from 2 to 50 — or 0 to ignore this length). Pad the number with leading zeroes to yield two digits. For example: 0 = 00, 5 = 05, 20 = 20, etc.
2. Scan the ENTER/EXIT PROGRAMMING MODE barcode to enter Programming Mode.
3. Scan the barcode: SELECT CODE 11 LENGTH 2 SETTING.
4. Scan the appropriate two digits from the keypad in [Appendix E, Keypad](#), that represent the length setting which was determined in the steps above. You will hear a two-beep indication after the last character.



If you make a mistake before the last character, scan the CANCEL barcode to abort and not save the entry string. You can then start again at the beginning.

NOTE

5. Scan the ENTER/EXIT PROGRAMMING MODE barcode to exit Programming Mode.

This completes the procedure. See [Table 32](#) for some examples of how to set this feature.

Table 32. Code 11 Length 2 Setting Examples

STEP	ACTION	EXAMPLES			
1	Desired Setting (pad with leading zeroes)	00 (Ignore This Length)	07 Characters	15 Characters	50 Characters
2	Scan ENTER/EXIT PROGRAMMING MODE				
3	Scan SELECT CODE 11 LENGTH 2 SETTING				
4	Scan Two Characters From Appendix E, Keypad	'0' and '0'	'0' and '7'	'0' and 'F'	'3' AND 2'
5	Scan ENTER/EXIT PROGRAMMING MODE				

Code 11 – cont.

Code 11 Set Length 2 – cont.

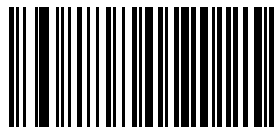
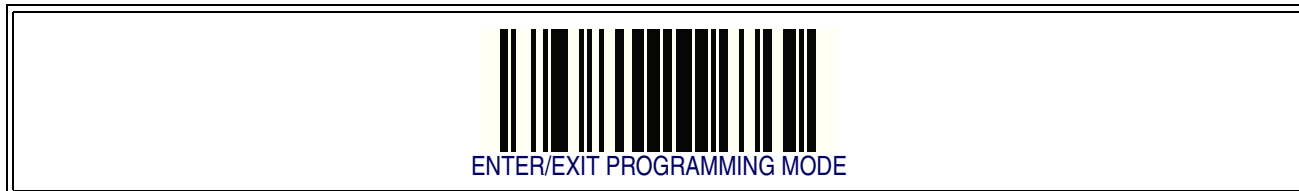

Select Code 11 Length 2 Setting

Make a mistake? Scan the CANCEL barcode to abort and not save the entry string. You can then start again at the beginning.

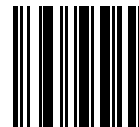

CANCEL

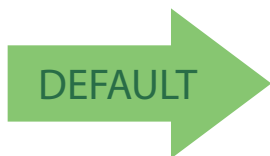

50 = Length 2 is 50 Characters

Code 11 – cont.

Code 11 Interdigit Ratio

This feature specifies the ratio between an intercharacter space and module for Code 11 labels.

 ENTER/EXIT PROGRAMMING MODE	
	 Code 11 Interdigit Ratio = Disable
 Code 11 Interdigit Ratio = 1	
	 Code 11 Interdigit Ratio = 2
 Code 11 Interdigit Ratio = 3	
 DEFAULT	 Code 11 Interdigit Ratio = 4
 Code 11 Interdigit Ratio = 5	

Code 11 – cont.

Code 11 Interdigit Ratio – cont.

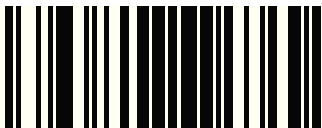
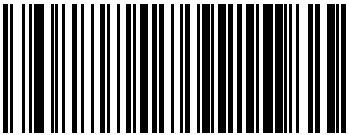
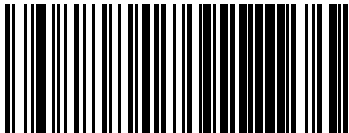
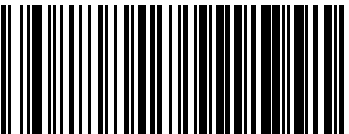
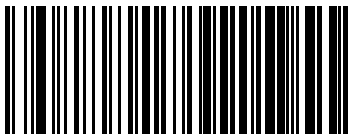
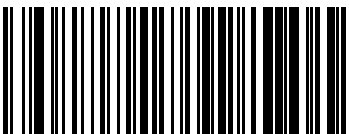
 ENTER/EXIT PROGRAMMING MODE	
	 Code 11 Interdigit Ratio = 6
 Code 11 Interdigit Ratio = 7	
	 Code 11 Interdigit Ratio = 8
 Code 11 Interdigit Ratio = 9	
	 Code 11 Interdigit Ratio = 10

Code 11 Decoding Level

Decoding Levels are used to configure a barcode symbology decoder to be very aggressive to very conservative depending on a particular customer's needs.

- Choosing Level 1 results in a very conservative decoder at the expense of not being able to read poorly printed or damaged labels.
- Choosing Level 5 results in a very aggressive decoder. This aggressive behavior allows decoding of poorly printed and damaged labels at the expense of increasing the likelihood of decoding errors.
- Choosing Level 3, which is the default setting, allows the majority of product labels to be decoded.

There are many factors that determine when to change the decoding level for a particular symbology. These factors include spots, voids, non-uniform bar/space widths, damaged labels, etc. that may be experienced in some barcode labels. If there are many hard to read or damaged labels that cannot be decoded using a conservative setting, increase the decoding level to be more aggressive. If the majority of labels are very good quality labels, or there is a need to decrease the possibility of a decoder error, lower the decoding level to a more conservative level.

Code 11 – cont.

Code 11 Decoding Level – cont.

 ENTER/EXIT PROGRAMMING MODE	
 Codabar Decoding Level = 1	
	 Codabar Decoding Level = 2
 Codabar Decoding Level = 3	 DEFAULT
	 Codabar Decoding Level = 4
 Codabar Decoding Level = 5	

Code 11 – cont.

Code 11 Character Correlation

When correlation is enabled, the barcode reader will combine label data from multiple scans when decoding. Enabling correlation will help the scanner read labels that have some spots and/or voids. It may also help read labels that have damaged areas. Enabling correlation will also increase the chances that a label will be read incorrectly.

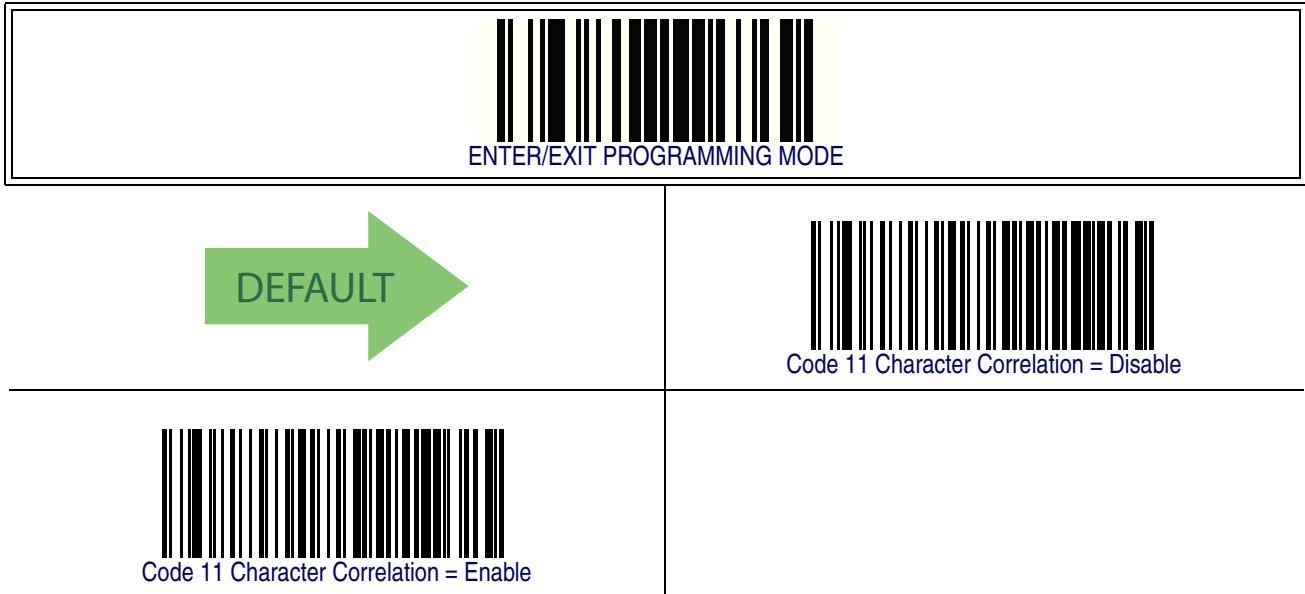

Code 11 Stitching

This option enables/disables stitching for Code 11 labels. When parts of a Code 11 barcode are presented to the reader with this feature enabled, the barcode parts will be assembled by the reader's software, and the data will be decoded if all barcode proofing requirements are met.



Standard 2 of 5

The following options apply to the Standard 2 of 5 symbology.

Standard 2 of 5 Enable/Disable

When disabled, the reader will not read Standard 2 of 5 barcodes.

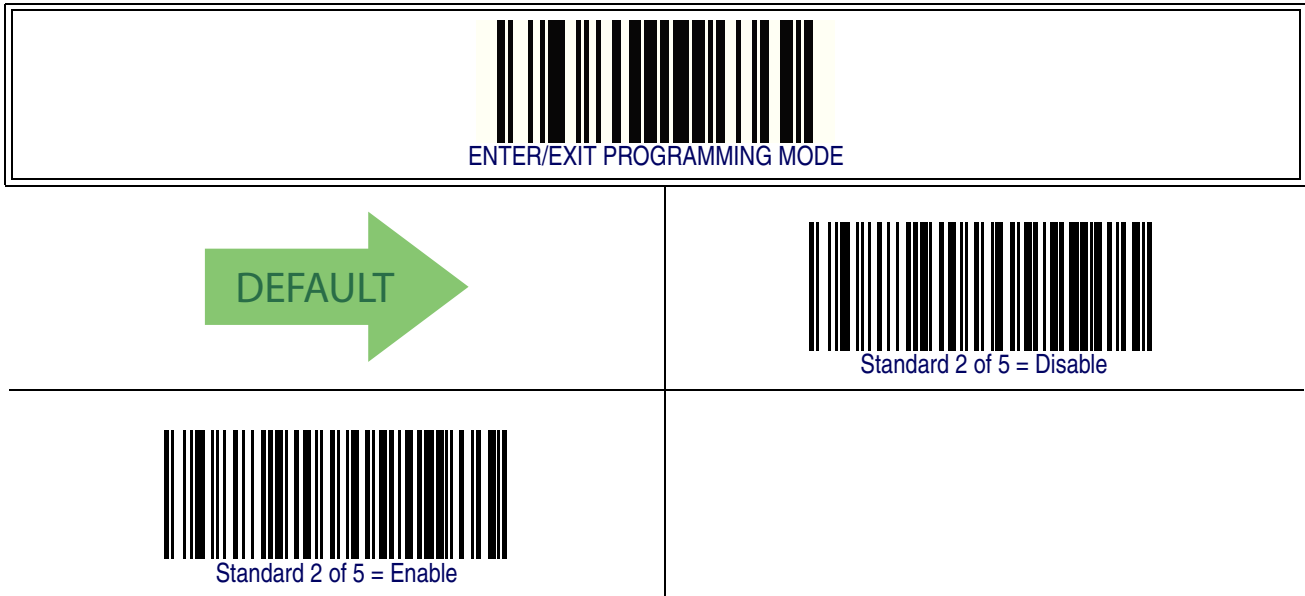

Standard 2 of 5 — cont.

Standard 2 of 5 Check Character Calculation

This option enables/disables calculation and verification of an optional Standard 2 of 5 check character.

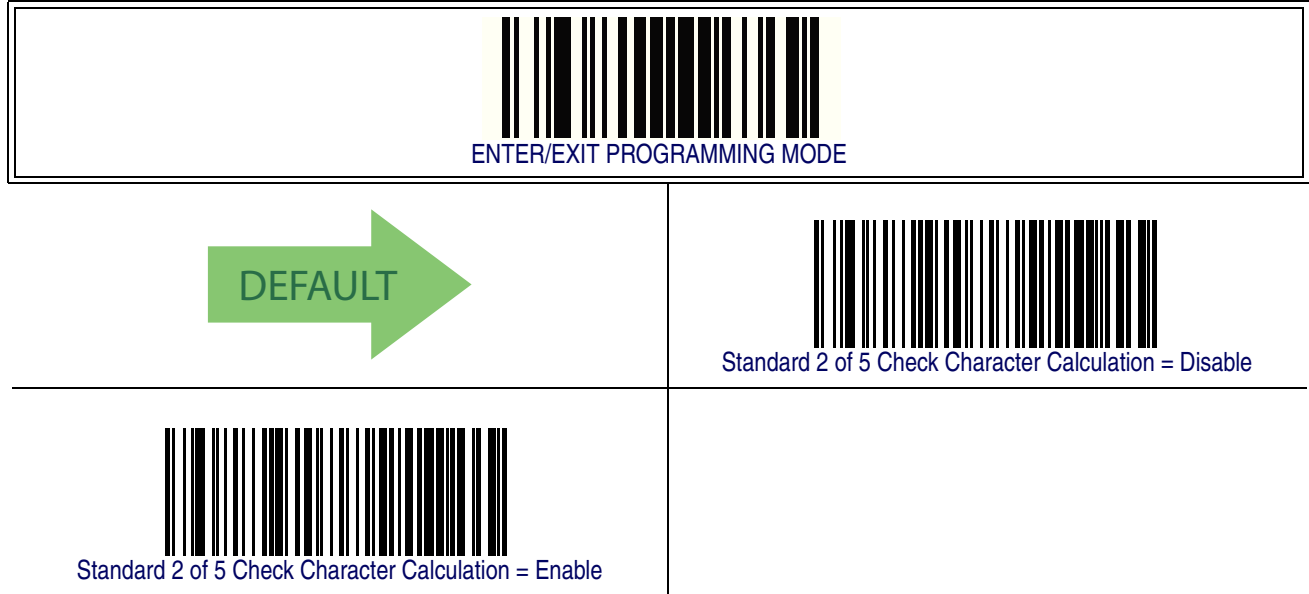

Standard 2 of 5 Check Character Transmission

This feature enables/disables transmission of an optional Standard 2 of 5 check character.



Standard 2 of 5 – cont.

Standard 2 of 5 Minimum Reads

This feature specifies the minimum number of consecutive times a Standard 2 of 5 label must be decoded before it is accepted as good read.

 ENTER/EXIT PROGRAMMING MODE	
 DEFAULT	 Standard 2 of 5 Minimum Reads = 1
 Standard 2 of 5 Minimum Reads = 2	
	 Standard 2 of 5 Minimum Reads = 3
 Standard 2 of 5 Minimum Reads = 4	

Standard 2 of 5 Decoding Level



NOTE

The Standard 2 of 5 Decoding Level feature is set using [I 2 of 5 Decoding Level](#) on page 211.

Standard 2 of 5 — cont.

Standard 2 of 5 Length Control

This feature specifies either variable length decoding or fixed length decoding for the Standard 2 of 5 symbology.

Variable Length — For variable length decoding, a minimum and maximum length may be set.

Fixed Length — For fixed length decoding, two different lengths may be set.



Standard 2 of 5 – cont.

Standard 2 of 5 Set Length 1

This feature specifies one of the barcode lengths for [Standard 2 of 5 Length Control](#). Length 1 is the minimum label length if in [Variable Length Mode](#), or the first fixed length if in [Fixed Length Mode](#). Length includes the barcode’s check and data characters.

The length can be set from 1 to 50 characters.

Follow these instructions to set this feature:

1. Determine the desired character length (from 1 to 50). Pad the number with leading zeroes to yield two digits. For example: 0 = 00, 5 = 05, 20 = 20, etc.
2. Scan the ENTER/EXIT PROGRAMMING MODE barcode to enter Programming Mode.
3. Scan the barcode: SELECT STANDARD 2 OF 5 LENGTH 1 SETTING.
4. Scan the appropriate two digits from the keypad in [Appendix E, Keypad](#), that represent the length setting which was determined in the steps above. You will hear a two-beep indication after the last character.



If you make a mistake before the last character, scan the CANCEL barcode to abort and not save the entry string. You can then start again at the beginning.

NOTE

5. Scan the ENTER/EXIT PROGRAMMING MODE barcode to exit Programming Mode.

This completes the procedure. See [Table 33](#) for some examples of how to set this feature.

Table 33. Standard 2 of 5 Length 1 Setting Examples

STEP	ACTION	EXAMPLES			
		01 Character	07 Characters	15 Characters	50 Characters
1	Desired Setting	01 Character	07 Characters	15 Characters	50 Characters
2	Scan ENTER/EXIT PROGRAMMING MODE				
3	Scan SELECT STANDARD 2 OF 5 LENGTH 1 SETTING				
4	Scan Two Characters From Appendix E, Keypad	'0' and '1'	'0' and '7'	'1' and '5'	'5' AND '0'
5	Scan ENTER/EXIT PROGRAMMING MODE				

Standard 2 of 5 — cont.

Standard 2 of 5 Set Length 1 — cont.

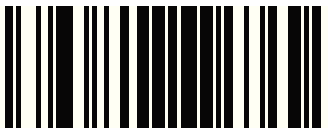
 ENTER/EXIT PROGRAMMING MODE
--

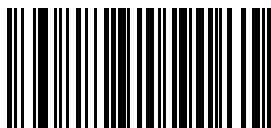
 Select Standard 2 of 5 Length 1 Setting	
--	--

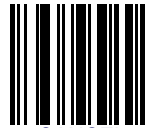
Make a mistake? Scan the CANCEL barcode to abort and not save the entry string. You can then start again at the beginning.	 CANCEL
--	---

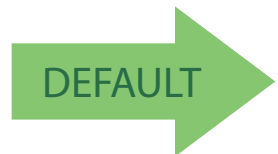
 08 = Length 1 is 8 Characters

Standard 2 of 5 – cont.

Standard 2 of 5 Set Length 2

This feature specifies one of the barcode lengths for [Standard 2 of 5 Length Control](#). Length 2 is the maximum label length if in [Variable Length](#) Mode, or the second fixed length if in [Fixed Length](#) Mode. Length includes the barcode’s check and data characters.

The length can be set from 1 to 50 characters. A setting of 0 specifies to ignore this length (only one fixed length).

Follow these instructions to set this feature:

1. Determine the desired character length (from 1 to 50 — or 0 to ignore this length). Pad the number with leading zeroes to yield two digits. For example: 0 = 00, 5 = 05, 20 = 20, etc.
2. Scan the ENTER/EXIT PROGRAMMING MODE barcode to enter Programming Mode.
3. Scan the barcode: SELECT STANDARD 2 OF 5 LENGTH 2 SETTING.
4. Scan the appropriate two digits from the keypad in [Appendix E, Keypad](#), that represent the length setting which was determined in the steps above. You will hear a two-beep indication after the last character.



If you make a mistake before the last character, scan the CANCEL barcode to abort and not save the entry string. You can then start again at the beginning.

NOTE

5. Scan the ENTER/EXIT PROGRAMMING MODE barcode to exit Programming Mode.

This completes the procedure. See [Table 34](#) for some examples of how to set this feature.

Table 34. Standard 2 of 5 Length 2 Setting Examples

STEP	ACTION	EXAMPLES			
1	Desired Setting (pad with leading zeroes)	00 (Ignore This Length)	07 Characters	15 Characters	50 Characters
2	Scan ENTER/EXIT PROGRAMMING MODE				
3	Scan SELECT STANDARD 2 OF 5 LENGTH 2 SETTING				
4	Scan Two Characters From Appendix E, Keypad	'0' and '0'	'0' and '7'	'1' and '5'	'5' AND '0'
5	Scan ENTER/EXIT PROGRAMMING MODE				

Standard 2 of 5 — cont.

Standard 2 of 5 Set Length 2 — cont.

 ENTER/EXIT PROGRAMMING MODE
--

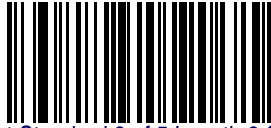
 Select Standard 2 of 5 Length 2 Setting	
--	--

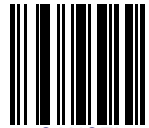
Make a mistake? Scan the CANCEL barcode to abort and not save the entry string. You can then start again at the beginning.	 CANCEL
--	---

 50 = Length 2 is 50 Characters

Standard 2 of 5 – cont.

Standard 2 of 5 Character Correlation

When correlation is enabled, the barcode reader will combine label data from multiple scans when decoding. Enabling correlation will help the scanner read labels that have some spots and/or voids. It may also help read labels that have damaged areas. Enabling correlation will also increase the chances that a label will be read incorrectly.

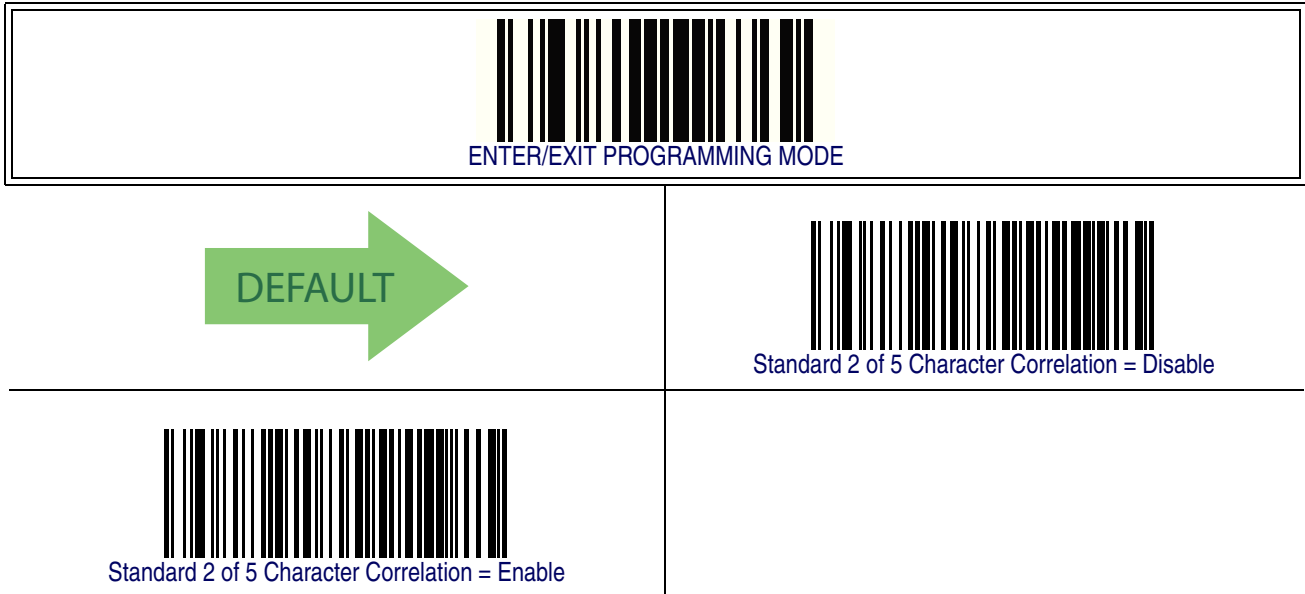

Standard 2 of 5 — cont.

Standard 2 of 5 Stitching

This option enables/disables stitching for Standard 2 of 5 labels. When parts of a Standard 2 of 5 barcode are presented to the reader with this feature enabled, the barcode parts will be assembled by the reader's software, and the data will be decoded if all barcode proofing requirements are met.



Industrial 2 of 5

The following options apply to the Industrial 2 of 5 symbology.

Industrial 2 of 5 Enable/Disable

Enables/Disables ability of reader to decode Industrial 2 of 5 labels.

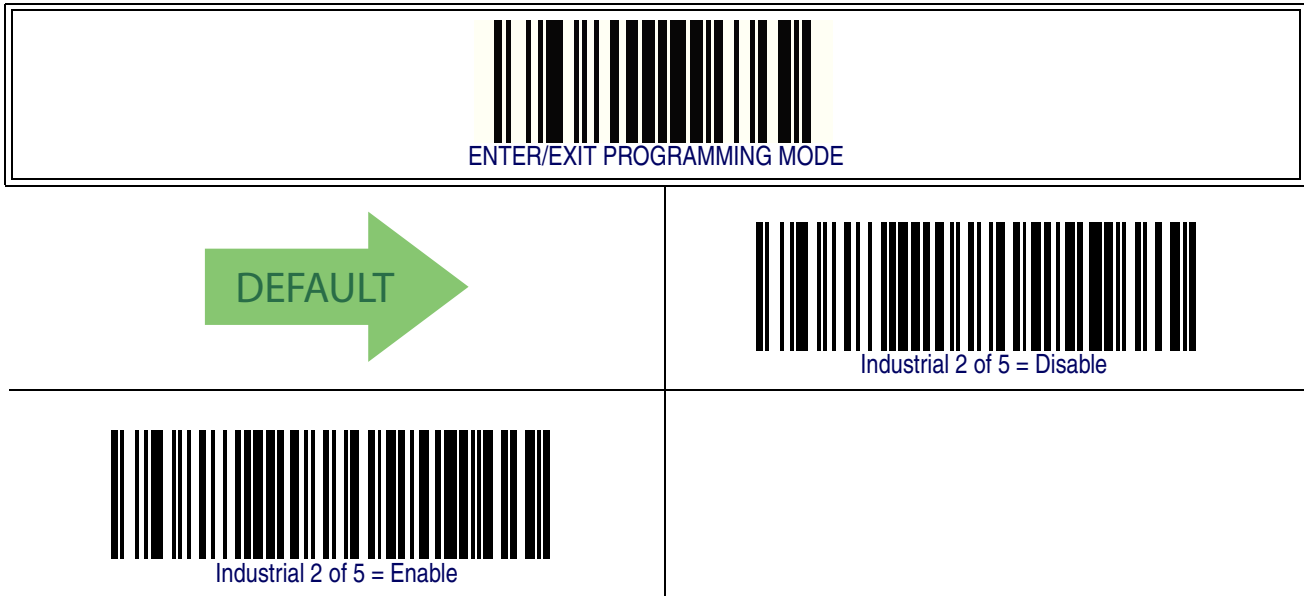

Industrial 2 of 5 Check Character Calculation



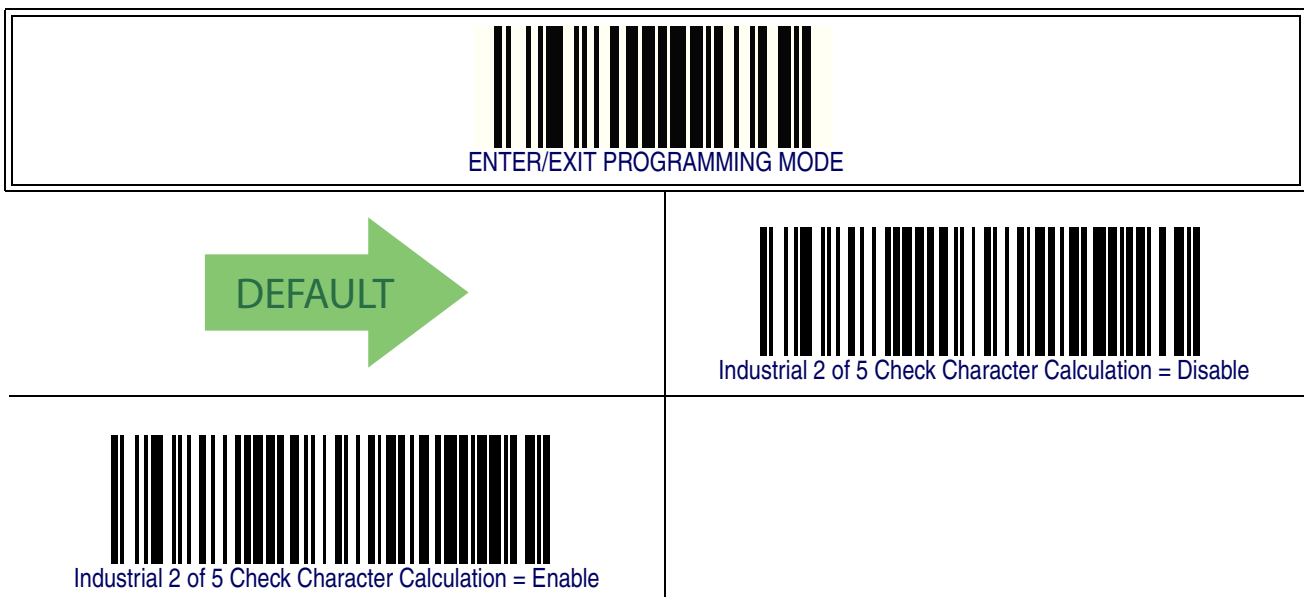

Enables/Disables calculation and verification of an optional Industrial 2 of 5 check character.



Industrial 2 of 5 – cont.

Industrial 2 of 5 Check Character Transmission

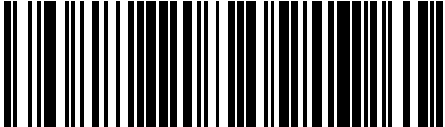
Enables/disables transmission of an Industrial 2 of 5 check character.

 ENTER/EXIT PROGRAMMING MODE	
	 Industrial 2 of 5 Check Character Transmission = Disable
 Industrial 2 of 5 Check Character Transmission = Enable	

Industrial 2 of 5 – cont.

Industrial 2 of 5 Length Control

This feature specifies either variable length decoding or fixed length decoding for the Industrial 2 of 5 symbology.

Variable Length – For variable length decoding, a minimum and maximum length may be set.

Fixed Length – For fixed length decoding, two different lengths may be set.

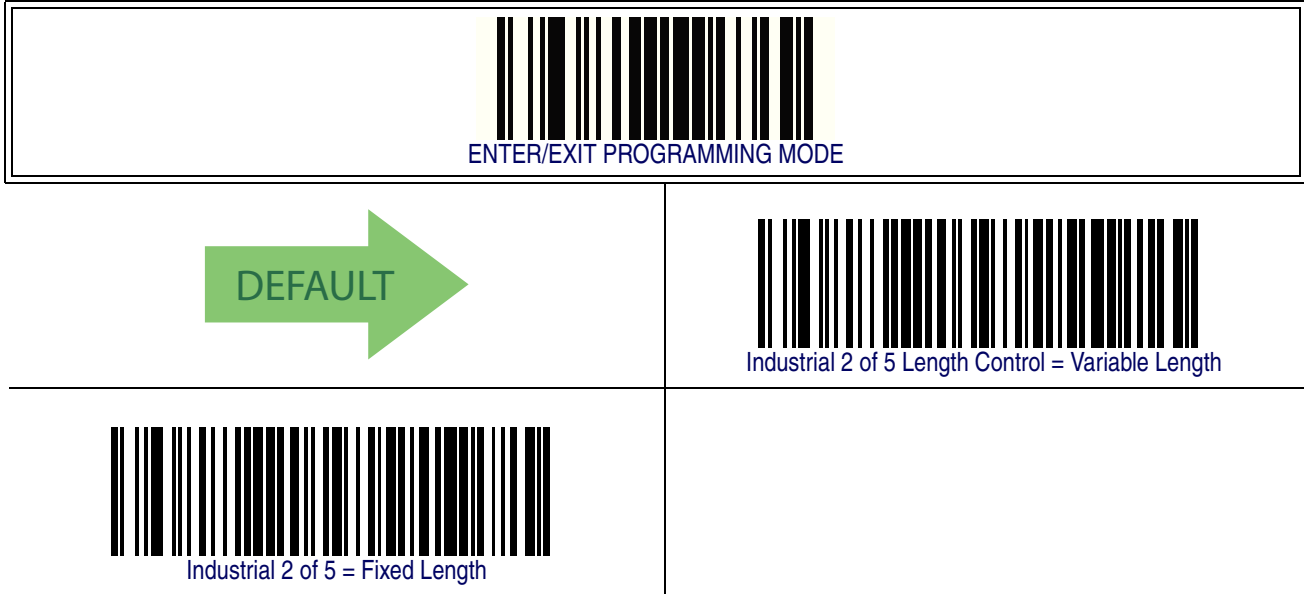

Industrial 2 of 5 – cont.

Industrial 2 of 5 Set Length 1

This feature specifies one of the barcode lengths for **Industrial 2 of 5 Length Control**. Length 1 is the minimum label length if in **Variable Length Mode**, or the first fixed length if in **Fixed Length Mode**. Length includes the barcode’s data characters only. The length can be set from 1 to 50 characters.

Follow these instructions to set this feature:

1. Determine the desired character length (from 1 to 50). Pad the number with leading zeroes to yield two digits. For example: 1 = 01, 5 = 05, 20 = 20, etc.
2. Scan the ENTER/EXIT PROGRAMMING MODE barcode to enter Programming Mode.
3. Scan the barcode: SELECT INDUSTRIAL 2 of 5 LENGTH 1 SETTING.
4. Scan the appropriate two digits from the keypad in the Keypad Appendix, that represent the length setting which was determined in the steps above. You will hear a two-beep indication after the last character.



If you make a mistake before the last character, scan the CANCEL barcode to abort and not save the entry string. You can then start again at the beginning.

NOTE

5. Scan the ENTER/EXIT PROGRAMMING MODE barcode to exit Programming Mode.

This completes the procedure. See the table below for some examples of how to set this feature.

Table 35. Code 39 Length 1 Setting Examples

STEP	ACTION	EXAMPLES			
1	Desired Setting	01 Characters	07 Characters	15 Characters	50 Characters
2	Scan ENTER/EXIT PROGRAMMING MODE				
3	Scan SELECT INDUSTRIAL 2 OF 5 LENGTH 1 SETTING				
4	Scan Two Characters From the Keypad Appendix	'0' and '1'	'0' and '7'	'1' and '5'	'5' AND '0'
5	Scan ENTER/EXIT PROGRAMMING MODE				

Industrial 2 of 5 – cont.

Industrial 2 of 5 Set Length 1 – cont.

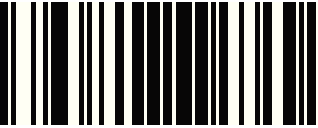
 ENTER/EXIT PROGRAMMING MODE
--

 Select Industrial 2 of 5 Set Length 1 Setting
--

--

Make a mistake? Scan the CANCEL barcode to abort and not save the entry string. You can then start again at the beginning.
--

 CANCEL

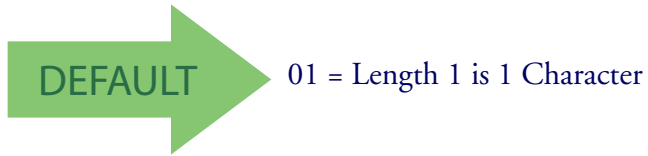

Industrial 2 of 5 – cont.

Industrial 2 of 5 Set Length 2

This feature specifies one of the barcode lengths for **Industrial 2 of 5 Length Control**. Length 2 is the maximum label length if in **Variable Length Mode**, or the second fixed length if in **Fixed Length Mode**. Length includes the barcode's check, data, and full-ASCII shift characters. The length does not include start/stop characters.

The length can be set from 1 to 50 characters. A setting of 0 specifies to ignore this length (only one fixed length).

Follow these instructions to set this feature:

1. Determine the desired character length (from 1 to 50 — or 0 to ignore this length). Pad the number with leading zeroes to yield two digits. For example: 0 = 00, 5 = 05, 20 = 20, etc.
2. Scan the ENTER/EXIT PROGRAMMING MODE barcode to enter Programming Mode.
3. Scan the barcode: SELECT INDUSTRIAL 2 OF 5 LENGTH 2 SETTING.
4. Scan the appropriate two digits from the keypad in the Keypad Appendix that represent the length setting which was determined in the steps above. You will hear a two-beep indication after the last character.



If you make a mistake, before the last character scan the CANCEL barcode to abort and not save the entry string. You can then start again at the beginning.

NOTE

5. Scan the ENTER/EXIT PROGRAMMING MODE barcode to exit Programming Mode.

This completes the procedure. See the table below for some examples of how to set this feature.

Table 36. Code 39 Length 2 Setting Examples

STEP	ACTION	EXAMPLES			
1	Desired Setting	00 (Ignore This Length)	07 Characters	15 Characters	50 Characters
2	Scan ENTER/EXIT PROGRAMMING MODE				
3	Scan SELECT INDUSTRIAL 2 OF 5 LENGTH 2 SETTING				
4	Scan Two Characters From the Keypad Appendix	'0' and '0'	'0' and '7'	'1' and '5'	'5' AND '0'
5	Scan ENTER/EXIT PROGRAMMING MODE				

Industrial 2 of 5 – cont.

Industrial 2 of 5 Set Length 2 – cont.

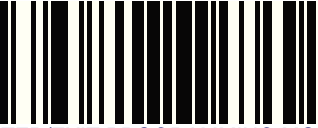
 ENTER/EXIT PROGRAMMING MODE
--

 Select Industrial 2 of 5 Length 2 Setting
--

--

Make a mistake? Scan the CANCEL barcode to abort and not save the entry string. You can then start again at the beginning.
--

 CANCEL



Industrial 2 of 5 – cont.

Industrial 2 of 5 Minimum Reads

This feature specifies the minimum number of consecutive times an Industrial 2 of 5 label must be decoded before it is accepted as good read..



Industrial 2 of 5 – cont.

Industrial 2 of 5 Stitching

Enables/disables fixed length stitching for Industrial 2 of 5.



Industrial 2 of 5 Character Correlation

Enable/disables character correlation for Industrial 2 of 5.

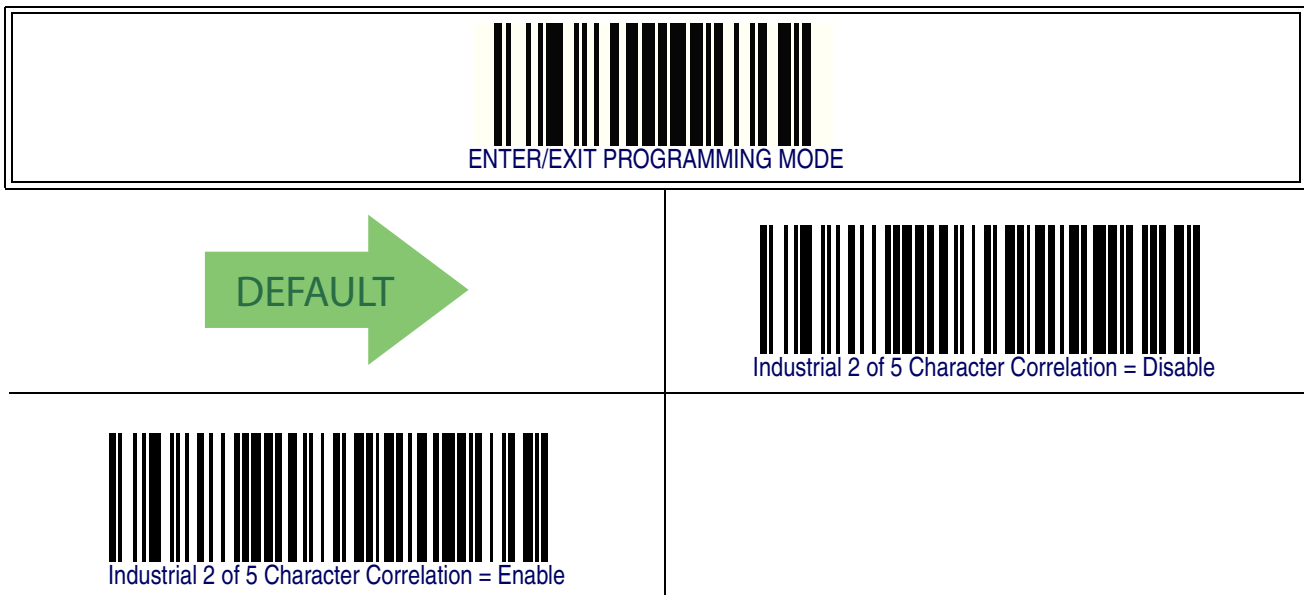

IATA

The following options apply to the IATA symbology.

IATA Enable/Disable

Enables/Disables the ability of the reader to decode IATA labels.

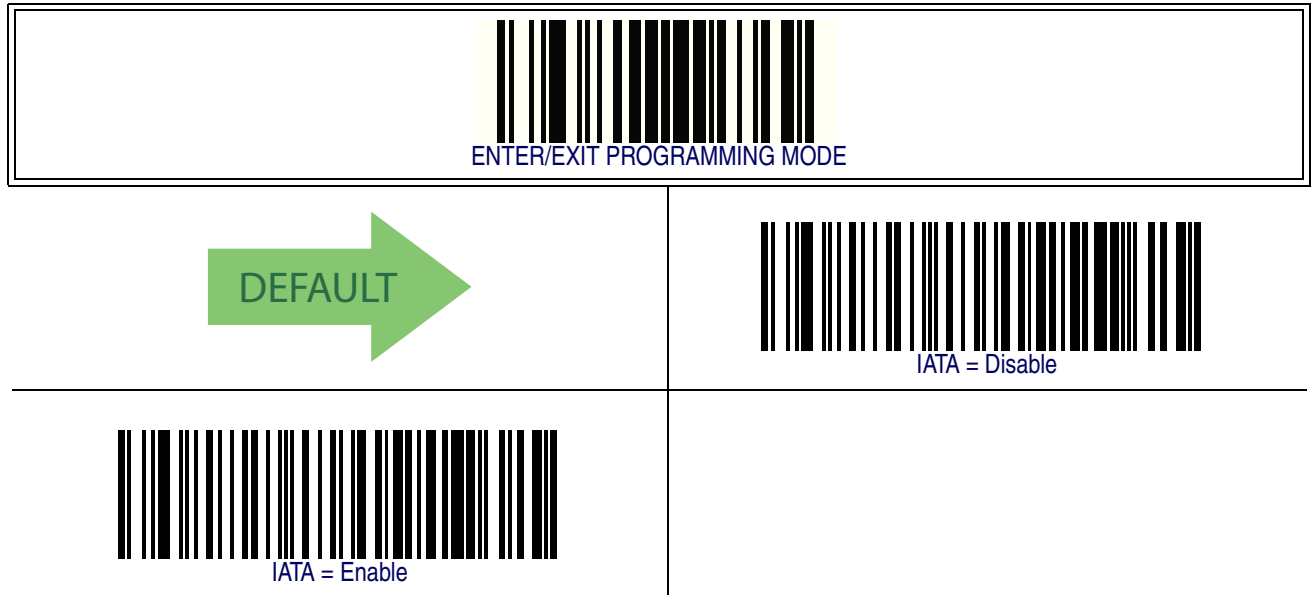

IATA Check Character Transmission

Enables/Disables calculation and verification of an optional Industrial 2 of 5 check character.



ISBT 128

The following options apply to the ISBT 128 symbology.

ISBT 128 Concatenation

Use this option to enable/disable ISBT128 concatenation of 2 labels.

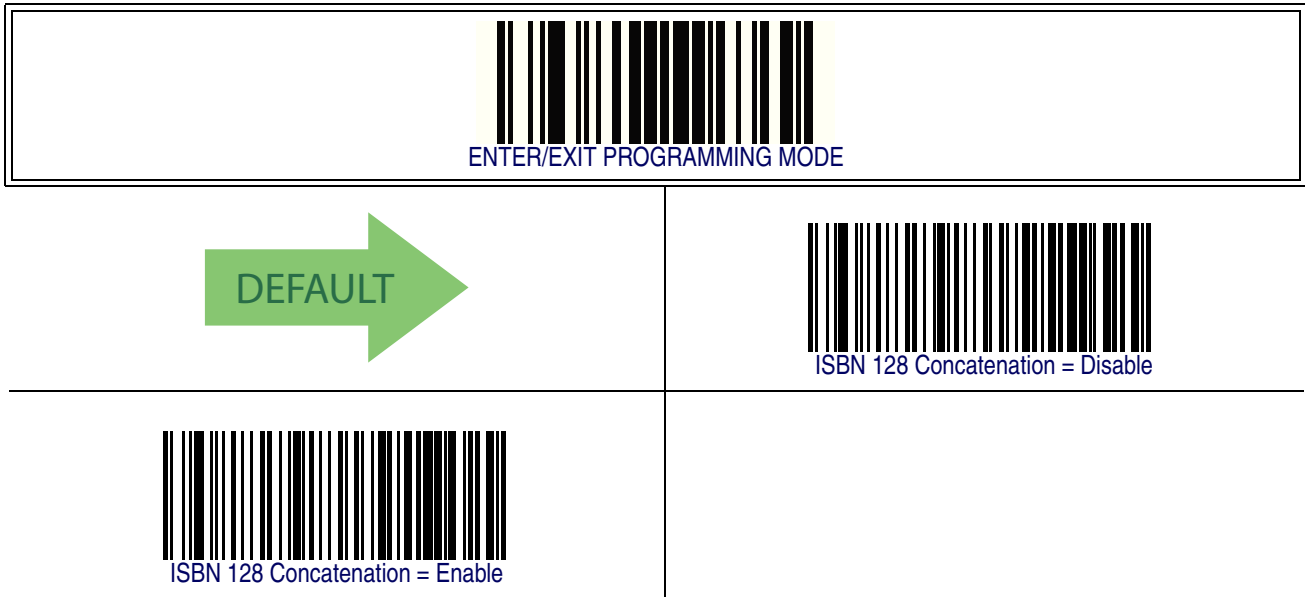

ISBT 128 Concatenation Mode

Specifies the concatenation mode between Static and Dynamic.



This option is only valid when ISBT 128 Concatenation is enabled (see page 288).





NOTE

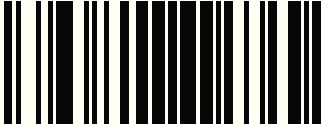
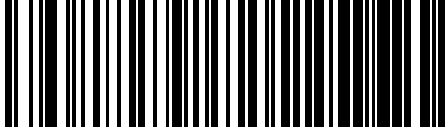

ISBT 128 – cont.

ISBT 128 Dynamic Concatenation Timeout

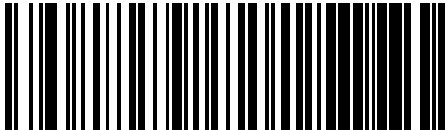
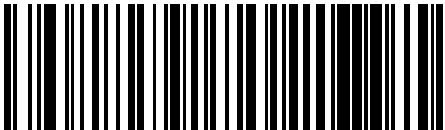
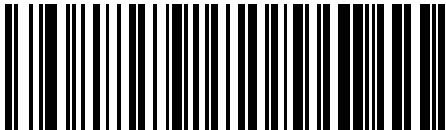
Specifies the timeout used by the ISBT 128 Dynamic Concatenation Mode.

 ENTER/EXIT PROGRAMMING MODE	
	 ISBT 128 Dynamic Concatenation Timeout = 50 msec
 ISBT 128 Dynamic Concatenation Timeout = 100 msec	
 DEFAULT	 ISBT 128 Dynamic Concatenation Timeout = 200 msec
 ISBT 128 Dynamic Concatenation Timeout = 500 msec	
	 ISBT 128 Dynamic Concatenation Timeout = 750 msec
 ISBT 128 Dynamic Concatenation Timeout = 1 second	

ISBT 128 – cont.

ISBT 128 Force Concatenation

When enabled, this feature forces concatenation for ISBT.



This option is only valid when ISBT 128 Concatenation is enabled. (see page 288).

NOTE



ISBT 128 Advanced Concatenation Options



Use the Datalogic Aladdin Configuration Application or contact Customer Support to set up pairs of label types for concatenation.

NOTE

MSI

The following options apply to the MSI symbology.

MSI Enable/Disable

Enables/Disables ability of reader to decode MSI labels.



MSI – cont.

MSI Check Character Calculation

Enables/Disables calculation and verification of an optional MSI check character.

 ENTER/EXIT PROGRAMMING MODE	
	 MSI Check Character Calculation = Disable
 MSI Check Character Calculation = Enable Mod10	
	 MSI Check Character Calculation = Enable Mod11/10
 MSI Check Character Calculation = Enable Mod10/10	

MSI – cont.

MSI Check Character Transmission

Enables/disables transmission of an MSI check character.



MSI Length Control

This feature specifies either variable length decoding or fixed length decoding for the MSI symbology.

Variable Length – For variable length decoding, a minimum and maximum length may be set.

Fixed Length – For fixed length decoding, two different lengths may be set.

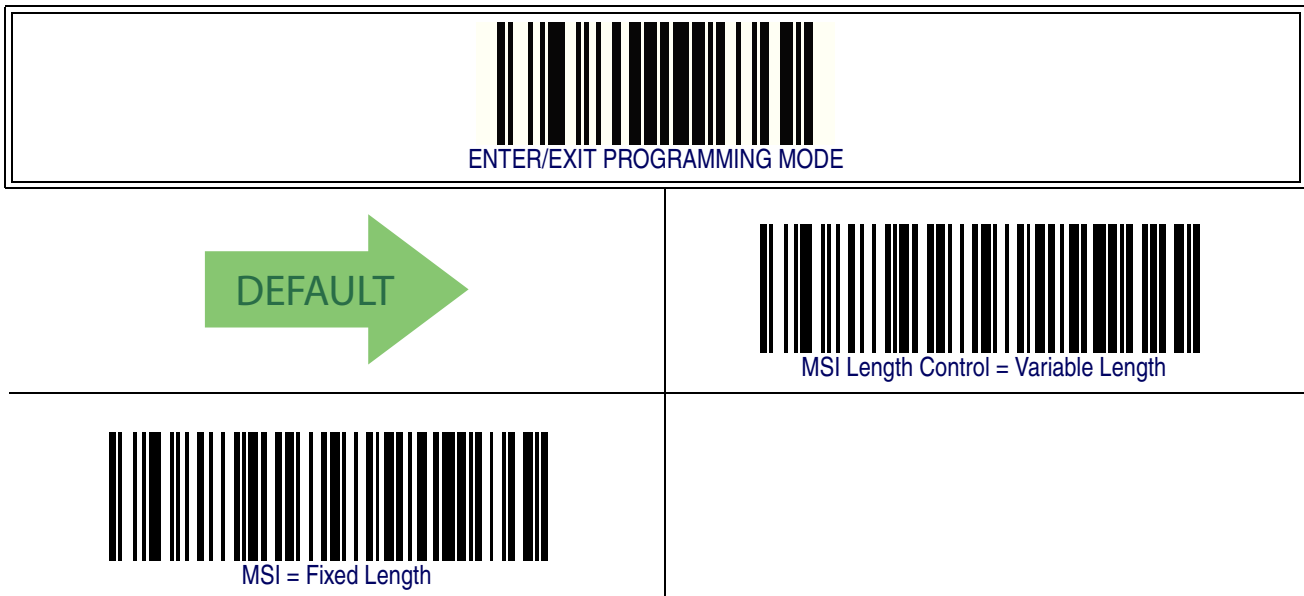

MSI – cont.

MSI Set Length 1

This feature specifies one of the barcode lengths for **MSI Length Control**. Length 1 is the minimum label length if in **Variable Length Mode**, or the first fixed length if in **Fixed Length Mode**. Length includes the barcode's data characters only.

The length can be set from 01 to 50 characters.

Follow these instructions to set this feature:

1. Determine the desired character length (from 0 to 50). Pad the number with leading zeroes to yield two digits. For example: 1 = 01, 5 = 05, 20 = 20, etc.
2. Scan the ENTER/EXIT PROGRAMMING MODE barcode to enter Programming Mode.
3. Scan the barcode: SELECT MSI LENGTH 1 SETTING.
4. Scan the appropriate two digits from the keypad in the Keypad Appendix, that represent the length setting which was determined in the steps above. You will hear a two-beep indication after the last character.



If you make a mistake before the last character, scan the CANCEL barcode to abort and not save the entry string. You can then start again at the beginning.

NOTE

5. Scan the ENTER/EXIT PROGRAMMING MODE barcode to exit Programming Mode.

This completes the procedure. See the table below for some examples of how to set this feature.

Table 37. MSI Length 1 Setting Examples

STEP	ACTION	EXAMPLES			
1	Desired Setting	01 Characters	07 Characters	15 Characters	50 Characters
2	Scan ENTER/EXIT PROGRAMMING MODE				
3	Scan SELECT MSI LENGTH 1 SETTING				
4	Scan Two Characters From the Keypad Appendix	'0' and '1'	'0' and '7'	'1' and '5'	'5' AND '0'
5	Scan ENTER/EXIT PROGRAMMING MODE				

MSI — cont.

MSI Set Length 1 — cont.

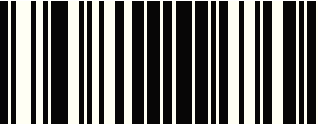
 ENTER/EXIT PROGRAMMING MODE
--

 Select MSI Set Length 1 Setting
--

Make a mistake? Scan the CANCEL barcode to abort and not save the entry string. You can then start again at the beginning.

 CANCEL

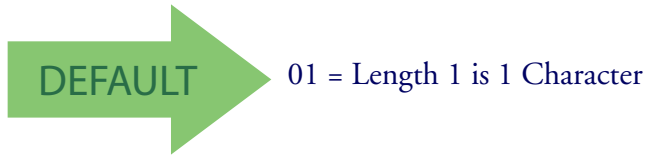

MSI – cont.

MSI Set Length 2

This feature specifies one of the barcode lengths for **MSI Length Control**. Length 2 is the maximum label length if in **Variable Length Mode**, or the second fixed length if in **Fixed Length Mode**. Length includes the barcode's check, data, and full-ASCII shift characters. The length does not include start/stop characters.

The length can be set from 1 to 50 characters. A setting of 0 specifies to ignore this length (only one fixed length).

Follow these instructions to set this feature:

1. Determine the desired character length (from 1 to 50 — or 0 to ignore this length). Pad the number with leading zeroes to yield two digits. For example: 0 = 00, 5 = 05, 20 = 20, etc.
2. Scan the ENTER/EXIT PROGRAMMING MODE barcode to enter Programming Mode.
3. Scan the barcode: SELECT MSI LENGTH 2 SETTING.
4. Scan the appropriate two digits from the keypad in the Keypad Appendix that represent the length setting which was determined in the steps above. You will hear a two-beep indication after the last character.



If you make a mistake, before the last character scan the CANCEL barcode to abort and not save the entry string. You can then start again at the beginning.

NOTE

5. Scan the ENTER/EXIT PROGRAMMING MODE barcode to exit Programming Mode.

This completes the procedure. See the table below for some examples of how to set this feature.

Table 38. MSI Length 2 Setting Examples

STEP	ACTION	EXAMPLES			
1	Desired Setting	00 (Ignore This Length)	07 Characters	15 Characters	50 Characters
2	Scan ENTER/EXIT PROGRAMMING MODE				
3	Scan SELECT MSI LENGTH 2 SETTING				
4	Scan Two Characters From the Keypad Appendix	'0' and '0'	'0' and '7'	'1' and '5'	'5' AND '0'
5	Scan ENTER/EXIT PROGRAMMING MODE				

MSI — cont.

MSI Set Length 2 — cont.

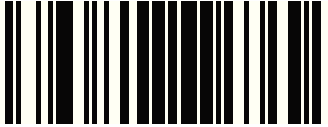
 ENTER/EXIT PROGRAMMING MODE
--

 Select MSI Length 2 Setting
--

Make a mistake? Scan the CANCEL barcode to abort and not save the entry string. You can then start again at the beginning.

 CANCEL



MSI – cont.

MSI Minimum Reads

This feature specifies the minimum number of consecutive times an MSI label must be decoded before it is accepted as good read.

 ENTER/EXIT PROGRAMMING MODE	
	 MSI Minimum Reads = 1
 MSI Minimum Reads = 2	
	 MSI Minimum Reads = 3
 MSI Minimum Reads = 4	

MSI – cont.

MSI Decoding Level

Decoding Levels are used to configure a barcode symbology decoder to be very aggressive to very conservative depending on a particular customer’s needs.

- Choosing Level 1 results in a very conservative decoder at the expense of not being able to read poorly printed or damaged labels.
- Choosing Level 5 results in a very aggressive decoder. This aggressive behavior allows decoding of poorly printed and damaged labels at the expense of increasing the likelihood of decoding errors.
- Choosing Level 3, which is the default setting, allows the majority of product labels to be decoded.

There are many factors that determine when to change the decoding level for a particular symbology. These factors include spots, voids, non-uniform bar/space widths, damaged labels, etc. that may be experienced in some barcode labels. If there are many hard to read or damaged labels that cannot be decoded using a conservative setting, increase the decoding level to be more aggressive. If the majority of labels are very good quality labels, or there is a need to decrease the possibility of a decoder error, lower the decoding level to a more conservative level.

 ENTER/EXIT PROGRAMMING MODE	
	 MSI Decoding Level = Disable
 MSI Decoding Level = 1	
	 MSI Decoding Level = 2

MSI – cont.

MSI Decoding Level – cont.

 <p>MSI Decoding Level = 3</p>	
	 <p>MSI Decoding Level = 4</p>
 <p>MSI Decoding Level = 5</p>	

Plessey

The following options apply to the Plessey symbology.

Plessey Enable/Disable

Enables/Disables ability of reader to decode Plessey labels.

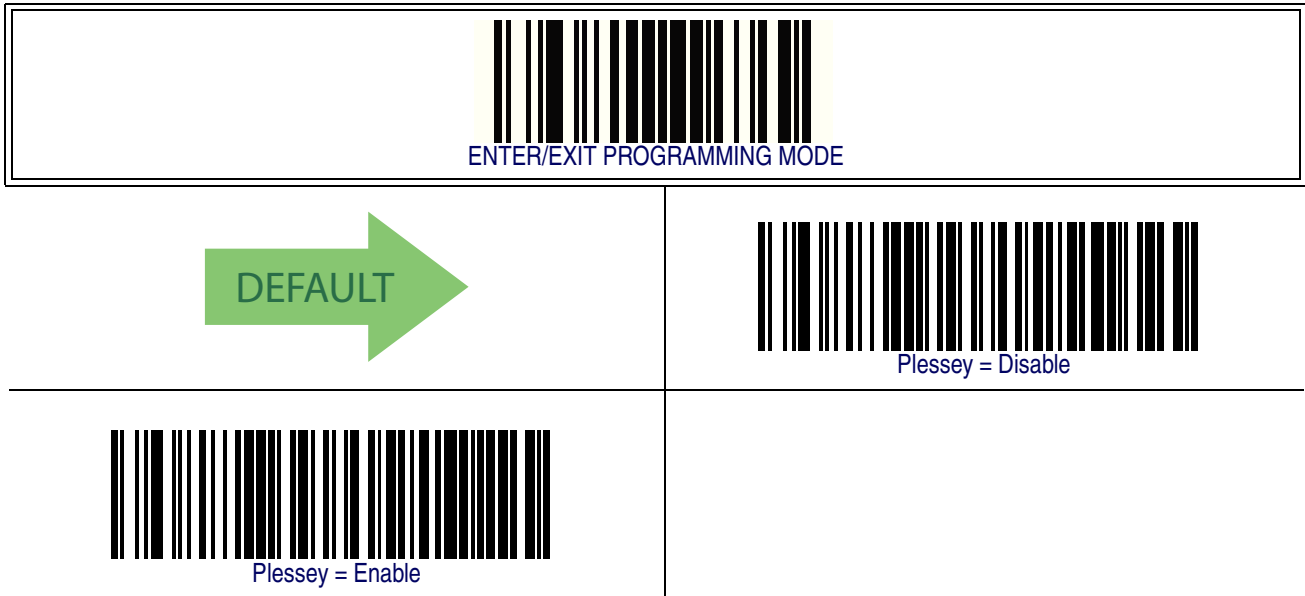

Plessey – cont.

Plessey Check Character Calculation

Enables/Disables calculation and verification of an optional Plessey check character.

 ENTER/EXIT PROGRAMMING MODE	
	 Plessey Check Character Calculation = Disable
 Plessey Check Character Calculation = Enable Plessey std. check char. verification	
	 Plessey Check Character Calculation = Enable Anker check char. verification
 Plessey Check Character Calculation = Enable Plessey std. and Anker check char verification	

Plessey – cont.

Plessey Check Character Transmission

Enables/disables transmission of an MSI check character.

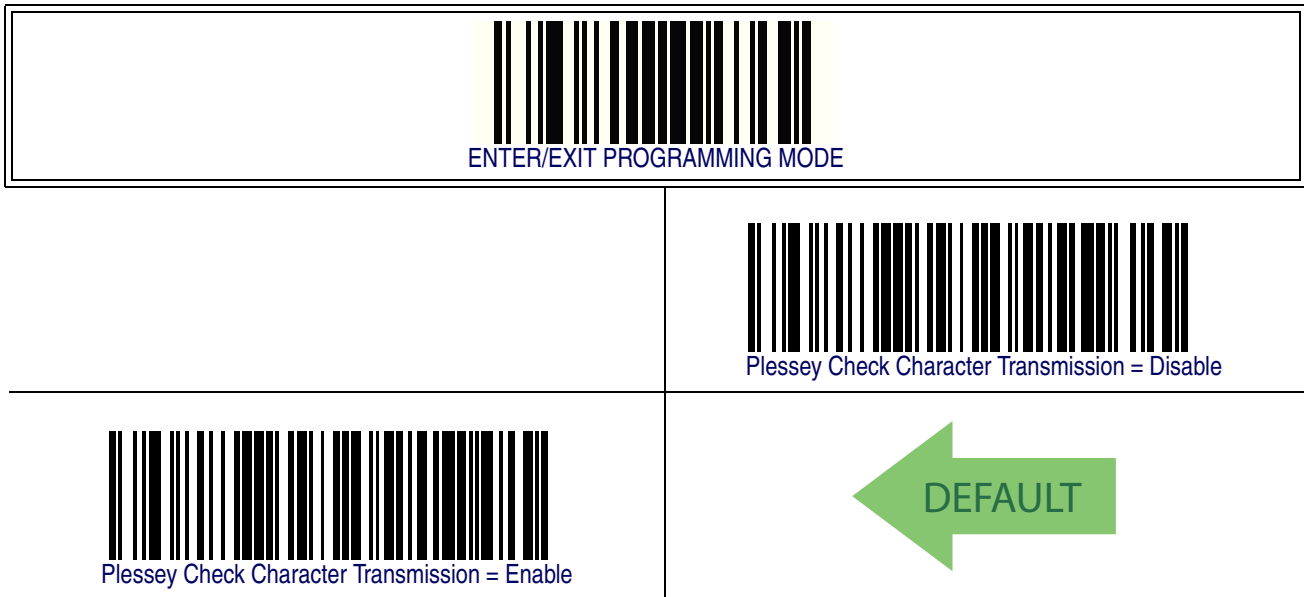

Plessey Length Control

This feature specifies either variable length decoding or fixed length decoding for the Plessey symbology.

Variable Length – For variable length decoding, a minimum and maximum length may be set.

Fixed Length – For fixed length decoding, two different lengths may be set.



Plessey – cont.

Plessey Set Length 1

This feature specifies one of the barcode lengths for **Plessey Length Control**. Length 1 is the minimum label length if in **Variable Length Mode**, or the first fixed length if in **Fixed Length Mode**. Length includes the barcode's data characters only.

The length can be set from 01 to 50 characters.

Follow these instructions to set this feature:

1. Determine the desired character length (from 0 to 50). Pad the number with leading zeroes to yield two digits. For example: 1 = 01, 5 = 05, 20 = 20, etc.
2. Scan the ENTER/EXIT PROGRAMMING MODE barcode to enter Programming Mode.
3. Scan the barcode: SELECT PLESSEY LENGTH 1 SETTING.
4. Scan the appropriate two digits from the keypad in the Keypad Appendix, that represent the length setting which was determined in the steps above. You will hear a two-beep indication after the last character.



If you make a mistake before the last character, scan the CANCEL barcode to abort and not save the entry string. You can then start again at the beginning.

NOTE

5. Scan the ENTER/EXIT PROGRAMMING MODE barcode to exit Programming Mode.

This completes the procedure. See the table below for some examples of how to set this feature.

Table 39. Plessey Length 1 Setting Examples

STEP	ACTION	EXAMPLES			
1	Desired Setting	01 Characters	07 Characters	15 Characters	50 Characters
2	Scan ENTER/EXIT PROGRAMMING MODE				
3	Scan SELECT Plessey LENGTH 1 SETTING				
4	Scan Two Characters From the Keypad Appendix	'0' and '1'	'0' and '7'	'1' and '5'	'5' AND '0'
5	Scan ENTER/EXIT PROGRAMMING MODE				

Plessey – cont.

Plessey Set Length 1 – cont.

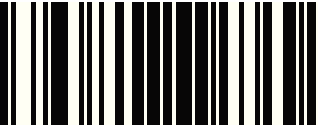
 ENTER/EXIT PROGRAMMING MODE
--

 Select Plessey Set Length 1 Setting
--

<p>Make a mistake? Scan the CANCEL barcode to abort and not save the entry string. You can then start again at the beginning.</p>	 CANCEL
---	---

 01 = Length 1 is 1 Character

Plessey – cont.

Plessey Set Length 2

This feature specifies one of the barcode lengths for **Plessey Length Control**. Length 2 is the maximum label length if in **Variable Length Mode**, or the second fixed length if in **Fixed Length Mode**. Length includes the barcode's check, data, and full-ASCII shift characters. The length does not include start/stop characters.

The length can be set from 1 to 50 characters. A setting of 0 specifies to ignore this length (only one fixed length).

Follow these instructions to set this feature:

1. Determine the desired character length (from 1 to 50 — or 0 to ignore this length). Pad the number with leading zeroes to yield two digits. For example: 0 = 00, 5 = 05, 20 = 20, etc.
2. Scan the ENTER/EXIT PROGRAMMING MODE barcode to enter Programming Mode.
3. Scan the barcode: SELECT PLESSEY LENGTH 2 SETTING.
4. Scan the appropriate two digits from the keypad in the Keypad Appendix that represent the length setting which was determined in the steps above. You will hear a two-beep indication after the last character.



If you make a mistake, before the last character scan the CANCEL barcode to abort and not save the entry string. You can then start again at the beginning.

NOTE

5. Scan the ENTER/EXIT PROGRAMMING MODE barcode to exit Programming Mode.

This completes the procedure. See the table below for some examples of how to set this feature.

Table 40. Plessey Length 2 Setting Examples

STEP	ACTION	EXAMPLES			
1	Desired Setting	00 (Ignore This Length)	07 Characters	15 Characters	50 Characters
2	Scan ENTER/EXIT PROGRAMMING MODE				
3	Scan SELECT PLESSEY LENGTH 2 SETTING				
4	Scan Two Characters From the Keypad Appendix	'0' and '0'	'0' and '7'	'1' and '5'	'5' AND '0'
5	Scan ENTER/EXIT PROGRAMMING MODE				

Plessey – cont.

Plessey Set Length 2 – cont.

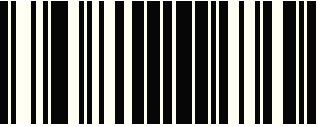
 ENTER/EXIT PROGRAMMING MODE
--

 Select Plessey Length 2 Setting
--

Make a mistake? Scan the CANCEL barcode to abort and not save the entry string. You can then start again at the beginning.

 CANCEL



Plessey – cont.

Plessey Minimum Reads

This feature specifies the minimum number of consecutive times a Plessey label must be decoded before it is accepted as good read.

 ENTER/EXIT PROGRAMMING MODE	
	 Plessey Minimum Reads = 1
 Plessey Minimum Reads = 2	
	 Plessey Minimum Reads = 3
 Plessey Minimum Reads = 4	

Plessey – cont.

Plessey Decoding Level

Decoding Levels are used to configure a barcode symbology decoder to be very aggressive to very conservative depending on a particular customer’s needs.

- Choosing Level 1 results in a very conservative decoder at the expense of not being able to read poorly printed or damaged labels.
- Choosing Level 5 results in a very aggressive decoder. This aggressive behavior allows decoding of poorly printed and damaged labels at the expense of increasing the likelihood of decoding errors.
- Choosing Level 3, which is the default setting, allows the majority of product labels to be decoded.

There are many factors that determine when to change the decoding level for a particular symbology. These factors include spots, voids, non-uniform bar/space widths, damaged labels, etc. that may be experienced in some barcode labels. If there are many hard to read or damaged labels that cannot be decoded using a conservative setting, increase the decoding level to be more aggressive. If the majority of labels are very good quality labels, or there is a need to decrease the possibility of a decoder error, lower the decoding level to a more conservative level.

 ENTER/EXIT PROGRAMMING MODE	
	 Plessey Decoding Level = Disable
 Plessey Decoding Level = 1	
	 Plessey Decoding Level = 2

Plessey – cont.

Plessey Decoding Level – cont.

 <p>Plessey Decoding Level = 3</p>	
	 <p>Plessey Decoding Level = 4</p>
 <p>Plessey Decoding Level = 5</p>	

Plessey Stitching

Enables/disables fixed length stitching for Plessey.

 <p>ENTER/EXIT PROGRAMMING MODE</p>	
	 <p>Plessey Stitching = Disable</p>
 <p>Plessey Stitching = Enable</p>	

Plessey – cont.

Plessey Character Correlation

Enables/disables Character Correlation for Plessey.

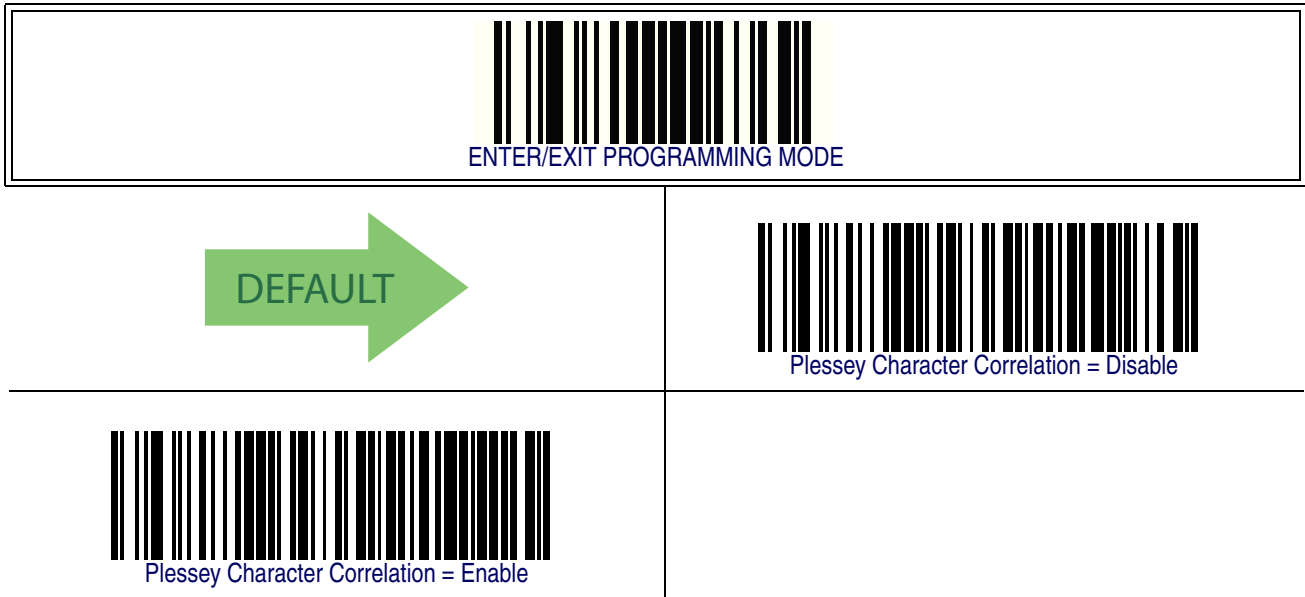

Code 93

The following options apply to the Code 93 symbology.

Code 93 Enable/Disable

Enables/Disables ability of reader to decode Code 93 labels.



Code 93 — cont.

Code 93 Check Character Calculation

Enables/disables calculation and verification of an optional Code 93 check character.

 ENTER/EXIT PROGRAMMING MODE	
	 Code 93 Check Character Calculation = Disable
 Code 93 Check Character Calculation = Enable Check C	
	 Code 93 Check Character Calculation = Enable Check K
 Code 93 Check Character Calculation = Enable Check C and K	

Code 93 – cont.

Code 93 Check Character Transmission

Enables/disables transmission of an optional Code 93 check character.



Code 93 Length Control

This feature specifies either variable length decoding or fixed length decoding for the Code 93 symbology.

Variable Length – For variable length decoding, a minimum and maximum length may be set.

Fixed Length – For fixed length decoding, two different lengths may be set.



Code 93 – cont.

Code 93 Set Length 1

This feature specifies one of the barcode lengths for **Code 93 Length Control**. Length 1 is the minimum label length if in **Variable Length Mode**, or the first fixed length if in **Fixed Length Mode**. Length includes the barcode's data characters only.

The length can be set from 01 to 50 characters.

Follow these instructions to set this feature:

1. Determine the desired character length (from 0 to 50). Pad the number with leading zeroes to yield two digits. For example: 1 = 01, 5 = 05, 20 = 20, etc.
2. Scan the ENTER/EXIT PROGRAMMING MODE barcode to enter Programming Mode.
3. Scan the barcode: SELECT CODE 93 LENGTH 1 SETTING.
4. Scan the appropriate two digits from the keypad in the Keypad Appendix, that represent the length setting which was determined in the steps above. You will hear a two-beep indication after the last character.



If you make a mistake before the last character, scan the CANCEL barcode to abort and not save the entry string. You can then start again at the beginning.

NOTE

5. Scan the ENTER/EXIT PROGRAMMING MODE barcode to exit Programming Mode.

This completes the procedure. See the table below for some examples of how to set this feature.

Table 41. Code 93 Length 1 Setting Examples

STEP	ACTION	EXAMPLES			
1	Desired Setting	01 Characters	07 Characters	15 Characters	50 Characters
2	Scan ENTER/EXIT PROGRAMMING MODE				
3	Scan SELECT CODE 93 LENGTH 1 SETTING				
4	Scan Two Characters From the Keypad Appendix	'0' and '1'	'0' and '7'	'1' and '5'	'5' AND '0'
5	Scan ENTER/EXIT PROGRAMMING MODE				

Code 93 — cont.

Code 93 Set Length 1 — cont.

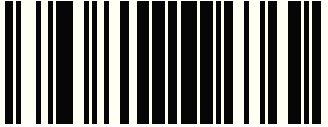
 ENTER/EXIT PROGRAMMING MODE
--

 Select Code 93 Set Length 1 Setting
--

Make a mistake? Scan the CANCEL barcode to abort and not save the entry string. You can then start again at the beginning.

 CANCEL

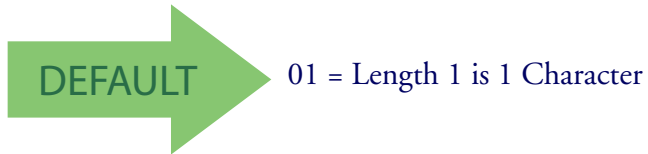

Code 93 — cont.

Code 93 Set Length 2

This feature specifies one of the barcode lengths for [Code 93 Length Control](#). Length 2 is the maximum label length if in [Variable Length Mode](#), or the second fixed length if in [Fixed Length Mode](#). Length includes the barcode's check, data, and full-ASCII shift characters. The length does not include start/stop characters.

The length can be set from 1 to 50 characters. A setting of 0 specifies to ignore this length (only one fixed length).

Follow these instructions to set this feature:

1. Determine the desired character length (from 1 to 50 — or 0 to ignore this length). Pad the number with leading zeroes to yield two digits. For example: 0 = 00, 5 = 05, 20 = 20, etc.
2. Scan the ENTER/EXIT PROGRAMMING MODE barcode to enter Programming Mode.
3. Scan the barcode: SELECT CODE 93 LENGTH 2 SETTING.
4. Scan the appropriate two digits from the keypad in the Keypad Appendix that represent the length setting which was determined in the steps above. You will hear a two-beep indication after the last character.



If you make a mistake, before the last character scan the CANCEL barcode to abort and not save the entry string. You can then start again at the beginning.

NOTE

5. Scan the ENTER/EXIT PROGRAMMING MODE barcode to exit Programming Mode.

This completes the procedure. See the table below for some examples of how to set this feature.

Table 42. CODE 93 Length 2 Setting Examples

STEP	ACTION	EXAMPLES			
1	Desired Setting	00 (Ignore This Length)	07 Characters	15 Characters	50 Characters
2	Scan ENTER/EXIT PROGRAMMING MODE				
3	Scan SELECT CODE 93 LENGTH 2 SETTING				
4	Scan Two Characters From the Keypad Appendix	'0' and '0'	'0' and '7'	'1' and '5'	'5' AND '0'
5	Scan ENTER/EXIT PROGRAMMING MODE				

Code 93 — cont.

Code 93 Set Length 2 — cont.

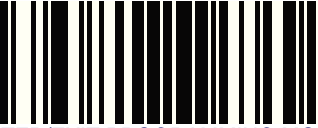
 ENTER/EXIT PROGRAMMING MODE
--

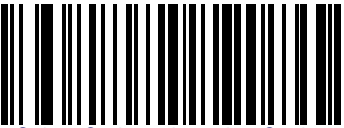
 Select Code 93 Length 2 Setting
--

Make a mistake? Scan the CANCEL barcode to abort and not save the entry string. You can then start again at the beginning.

 CANCEL

 50 = Length 2 is 50 Characters

Code 93 — cont.

Code 93 Minimum Reads

This feature specifies the minimum number of consecutive times a Code 93 label must be decoded before it is accepted as good read.



Code 93 – cont.

Code 93 Decoding Level

Decoding Levels are used to configure a barcode symbology decoder to be very aggressive to very conservative depending on a particular customer’s needs.

- Choosing Level 1 results in a very conservative decoder at the expense of not being able to read poorly printed or damaged labels.
- Choosing Level 5 results in a very aggressive decoder. This aggressive behavior allows decoding of poorly printed and damaged labels at the expense of increasing the likelihood of decoding errors.
- Choosing Level 3, which is the default setting, allows the majority of product labels to be decoded.

There are many factors that determine when to change the decoding level for a particular symbology. These factors include spots, voids, non-uniform bar/space widths, damaged labels, etc. that may be experienced in some barcode labels. If there are many hard to read or damaged labels that cannot be decoded using a conservative setting, increase the decoding level to be more aggressive. If the majority of labels are very good quality labels, or there is a need to decrease the possibility of a decoder error, lower the decoding level to a more conservative level.

 ENTER/EXIT PROGRAMMING MODE	
	 Code 93 Decoding Level = Disable
 Code 93 Decoding Level = 1	
	 Code 93 Decoding Level = 2

Code 93 – cont.

Code 93 Decoding Level – cont.

 <p>Code 93 Decoding Level = 3</p>	
	 <p>Code 93 Decoding Level = 4</p>
 <p>Code 93 Decoding Level = 5</p>	

Code 93 – cont.

Code 93 Quiet Zones

Enables/disables fixed length stitching for Code 93.

 ENTER/EXIT PROGRAMMING MODE	
	 Code 93 Quiet Zones = No Quiet Zones
 Code 93 Quiet Zones = Quiet Zone on one side	
	 Code 93 Quiet Zones = Quiet Zones on two sides
 Code 93 Quiet Zones = Auto	 DEFAULT
	 Code 93 Quiet Zones = Virtual Quiet Zones on two sides

Code 93 — cont.

Code 93 Stitching

Disable/enable fixed or variable length stitching for Code 93.



Code 93 Character Correlation

Enables/disables Character Correlation for Code 93.



Codablock F

The following options apply to the Codablock F symbology.

Codablock F Enable/Disable

Enables/Disables the ability of the imager to decode Codablock F labels.

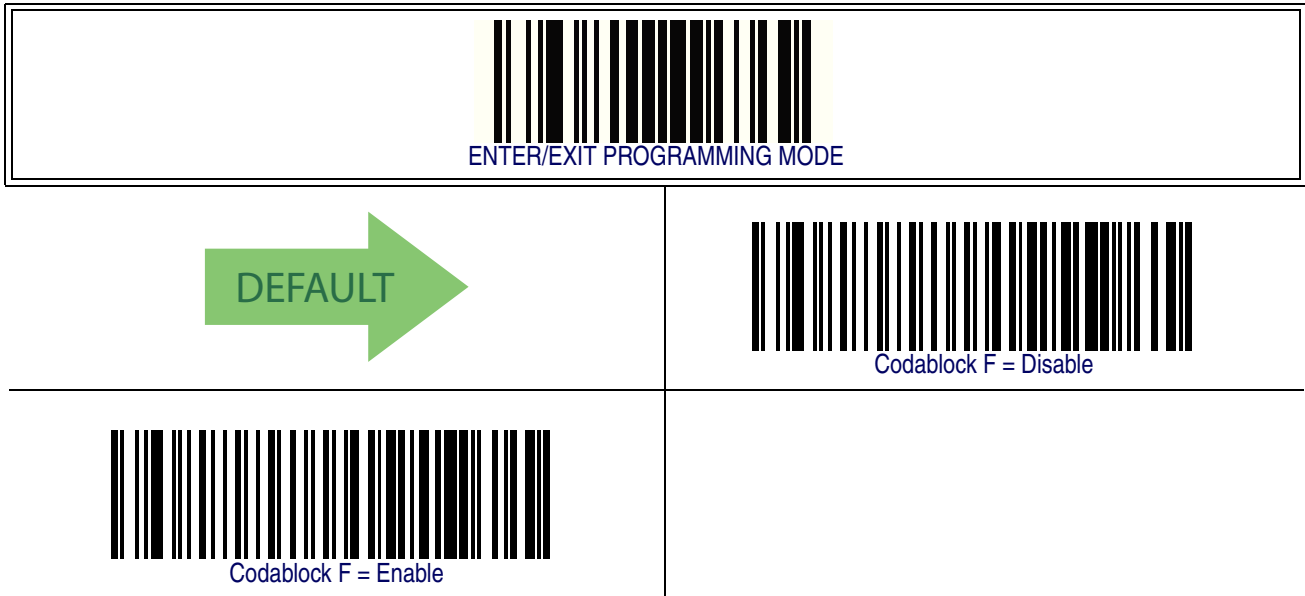

Codablock F – cont.

Codablock F EAN Enable/Disable

Enables/Disables the Codablock F EAN subtype (code with FNC1 in the first position).



Codablock F AIM Check

Specifies if Check Digit calculation algorithm is AIM compliant or not.



Codablock F – cont.

Codablock F Length Control

This feature specifies either variable length decoding or fixed length decoding for the Codablock F symbology.

Variable Length – For variable length decoding, a minimum and maximum length may be set.

Fixed Length – For fixed length decoding, two different lengths may be set.



Codablock F – cont.

Codablock F Set Length 1

This feature specifies one of the barcode lengths for **Codablock F Length Control**. Length 1 is the minimum label length if in **Variable Length Mode**, or the first fixed length if in **Fixed Length Mode**. Length includes the barcode's data characters only. The length can be set from 003 to 255 characters.

Follow these instructions to set this feature:

1. Determine the desired character length (from 3 to 255). Pad the number with leading zeroes to yield three digits. For example: 3 = 003, 5 = 005, 20 = 020, etc.
2. Scan the ENTER/EXIT PROGRAMMING MODE barcode to enter Programming Mode.
3. Scan the barcode: SELECT CODABLOCK F LENGTH 1 SETTING.
4. Scan the appropriate three digits from the keypad in the Keypad Appendix, that represent the length setting which was determined in the steps above. You will hear a two-beep indication after the last character.



If you make a mistake before the last character, scan the CANCEL barcode to abort and not save the entry string. You can then start again at the beginning.

NOTE

5. Scan the ENTER/EXIT PROGRAMMING MODE barcode to exit Programming Mode.

This completes the procedure. See the table below for some examples of how to set this feature.

Table 43. CODABLOCK F Length 1 Setting Examples

STEP	ACTION	EXAMPLES			
1	Desired Setting	003 Characters	007 Characters	015 Characters	050 Characters
2	Scan ENTER/EXIT PROGRAMMING MODE				
3	Scan SELECT CODABLOCK F LENGTH 1 SETTING				
4	Scan three Characters From the Keypad Appendix	'0', '0' and '3'	'0', '0' and '7'	'0', '1' and '5'	'0', '5' AND '0'
5	Scan ENTER/EXIT PROGRAMMING MODE				

Codablock F — cont.

Codablock F Set Length 1 — cont.

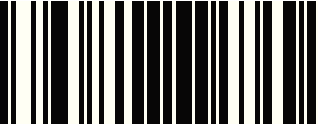
 ENTER/EXIT PROGRAMMING MODE
--

 Select Codablock F Length 1 Setting
--

Make a mistake? Scan the CANCEL barcode to abort and not save the entry string. You can then start again at the beginning.

 CANCEL



Codablock F – cont.

Codablock F Set Length 2

This feature specifies one of the barcode lengths for [Codablock F Length Control](#). Length 2 is the maximum label length if in [Variable Length Mode](#), or the second fixed length if in [Fixed Length Mode](#). Length includes the barcode's check, data, and full-ASCII shift characters. The length does not include start/stop characters.

The length can be set from 3 to 255 characters. A setting of 0 specifies to ignore this length (only one fixed length).

Follow these instructions to set this feature:

1. Determine the desired character length (from 3 to 255 — or 0 to ignore this length). Pad the number with leading zeroes to yield three digits. For example: 0 = 000, 5 = 005, 20 = 020, etc.
2. Scan the ENTER/EXIT PROGRAMMING MODE barcode to enter Programming Mode.
3. Scan the barcode: SELECT CODABLOCK F LENGTH 2 SETTING.
4. Scan the appropriate three digits from the keypad in the Keypad Appendix that represent the length setting which was determined in the steps above. You will hear a two-beep indication after the last character.



If you make a mistake, before the last character scan the CANCEL barcode to abort and not save the entry string. You can then start again at the beginning.

NOTE

5. Scan the ENTER/EXIT PROGRAMMING MODE barcode to exit Programming Mode.

This completes the procedure. See the table below for some examples of how to set this feature.

Table 44. CODABLOCK Length 2 Setting Examples

STEP	ACTION	EXAMPLES			
1	Desired Setting	000 (Ignore This Length)	007 Characters	015 Characters	050 Characters
2	Scan ENTER/EXIT PROGRAMMING MODE				
3	Scan SELECT CODABLOCK F LENGTH 2 SETTING				
4	Scan three Characters From the Keypad Appendix	'0', '0' and '0'	'0', '0' and '7'	'0', '1' and '5'	'0', '5' AND '0'
5	Scan ENTER/EXIT PROGRAMMING MODE				

Codablock F — cont.

Codablock F Set Length 2 — cont.

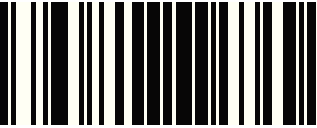
 ENTER/EXIT PROGRAMMING MODE
--

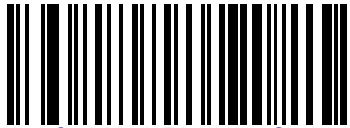
 Select Codablock F Length 2 Setting
--

Make a mistake? Scan the CANCEL barcode to abort and not save the entry string. You can then start again at the beginning.

 CANCEL

 100 = Length 2 is 100 Characters

Code 4

The following options apply to the Code 4 symbology.

Code 4 Enable/Disable

Enables/Disables ability of imager to decode Code 4 labels.



Code 4 – cont.

Code 4 Check Character Transmission

This feature enables/disables transmission of an optional Code 4 check character.

 ENTER/EXIT PROGRAMMING MODE	
	 Code 4 Check Character Transmission = Don't Send
 Code 4 Check Character Transmission = Send	

Code 4 Hex to Decimal Conversion

This feature enables/disables the conversion of hexadecimal label data to decimal label data.

 ENTER/EXIT PROGRAMMING MODE	
	 Code 4 Hex to Decimal Conversion = Disable
 Code 4 Hex to Decimal Conversion = Enable	

Code 5

The following options apply to the Code 5 symbology.

Code 5 Enable/Disable

Enables/Disables ability of imager to decode Code 5 labels.



Code 5 – cont.

Code 5 Check Character Transmission

This feature enables/disables transmission of an optional Code 5 check character.

 ENTER/EXIT PROGRAMMING MODE	
	 Code 5 Check Character Transmission = Don't Send
 Code 5 Check Character Transmission = Send	 DEFAULT

Code 5 Hex to Decimal Conversion

This feature enables/disables the conversion of hexadecimal label data to decimal label data.

 ENTER/EXIT PROGRAMMING MODE	
	 Code 5 Hex to Decimal Conversion = Disable
 Code 5 Hex to Decimal Conversion = Enable	 DEFAULT

Code 4 and Code 5 Common Configuration Items

The following options apply to both Code 4 and Code 5 symbologies.

Code 4 and 5 Decoding Level

Decoding Levels are used to configure a barcode symbology decoder to be very aggressive to very conservative depending on a particular customer's needs.

- Choosing Level 1 results in a very conservative decoder at the expense of not being able to read poorly printed or damaged labels.
- Choosing Level 5 results in a very aggressive decoder. This aggressive behavior allows decoding of poorly printed and damaged labels at the expense of increasing the likelihood of decoding errors.
- Choosing Level 3, which is the default setting, allows the majority of product labels to be decoded.

There are many factors that determine when to change the decoding level for a particular symbology. These factors include spots, voids, non-uniform bar/space widths, damaged labels, etc. that may be experienced in some barcode labels. If there are many hard to read or damaged labels that cannot be decoded using a conservative setting, increase the decoding level to be more aggressive. If the majority of labels are very good quality labels, or there is a need to decrease the possibility of a decoder error, lower the decoding level to a more conservative level.



This configuration item applies to Code 4 and Code 5.

NOTE

Code 4 and Code 5 Common Configuration Items – cont.

Code 4 and 5 Decoding Level – cont.

 ENTER/EXIT PROGRAMMING MODE	
 Code 4 and Code 5 Decoding Level = 1	
	 Code 4 and Code 5 Decoding Level = 2
 Code 4 and Code 5 Decoding Level = 3	 DEFAULT
	 Code 4 and Code 5 Decoding Level = 4
 Code 4 and Code 5 Decoding Level = 5	

Code 4 and Code 5 Common Configuration Items – cont.

Code 4 and Code 5 Minimum Reads

This feature specifies the minimum number of consecutive times a Code 4 or Code 5 label must be decoded before it is accepted as good read.

 ENTER/EXIT PROGRAMMING MODE	
 DEFAULT	 Code 4 or Code 5 Minimum Reads = 1
 Code 4 or Code 5 Minimum Reads = 2	
	 Code 4 or Code 5 Minimum Reads = 3
 Code 4 or Code 5 Minimum Reads = 4	

Follett 2 of 5

The following options apply to the Follett 2 of 5 symbology.

Follett 2 of 5 Enable/Disable

Enables/Disables ability of imager to decode Follett 2 of 5 labels.



Chapter 13

BT Features

Introduction

This section provides options and programming related to the reader's radio communication features.

Standard Factory Settings

Reference [Appendix B, Standard Defaults](#) for a listing of standard factory settings.

BT Beeper Features

Several options are available to configure beeper behavior for BT operation.

ACK Beep

Enables/disables the ACK beep indication. The ACK beep occurs in response to the label acknowledgement (HACK) from the Base Station. The HACK signal is sent according to the settings made for [BT Address Stamping on page 364](#).

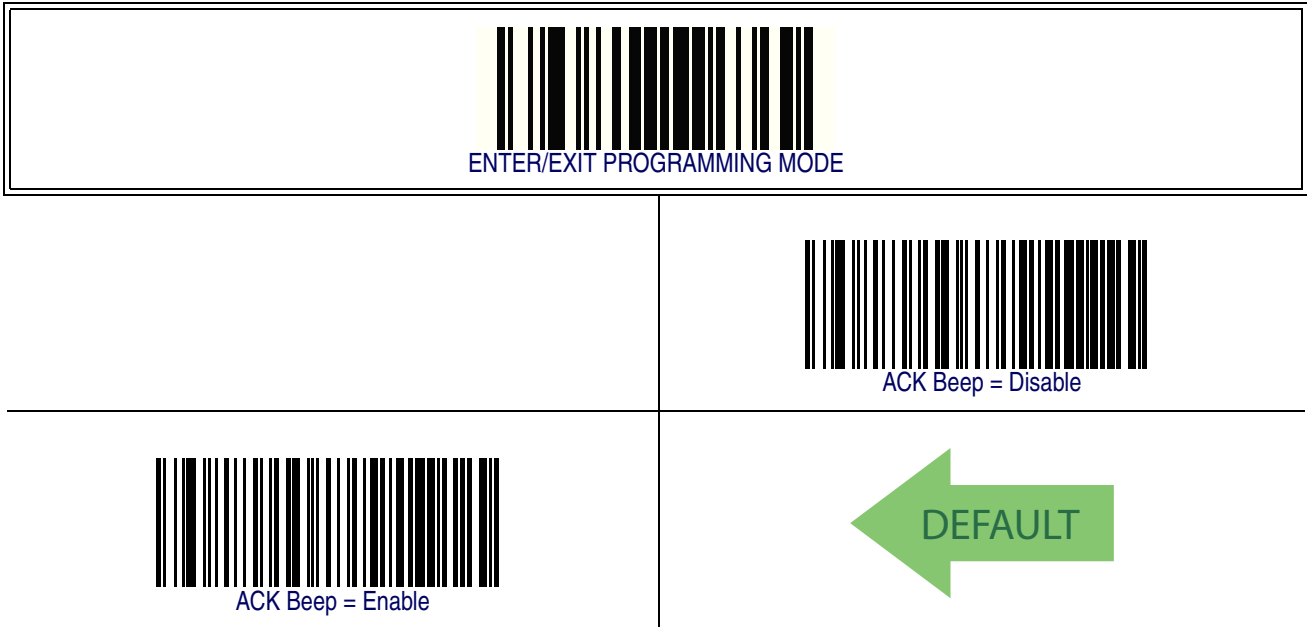







Beep Frequency

Adjusts radio-specific beep indications to sound at a low, medium or high frequency, selectable from the list below. (Controls the beeper's pitch/tone.)

 ENTER/EXIT PROGRAMMING MODE	
	 Beep Frequency = Low
 Beep Frequency = Medium	
	 Beep Frequency = High

Beep Duration

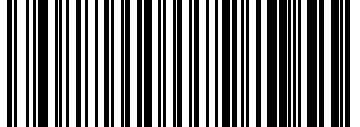
This feature controls the duration of radio-specific beep indications.

 ENTER/EXIT PROGRAMMING MODE	
	 Beep Duration = 60 msec
 Beep Duration = 80 msec	
	 Beep Duration = 100 msec
 Beep Duration = 120 msec	
	 Beep Duration = 140 msec

Beep Duration – cont.

 ENTER/EXIT PROGRAMMING MODE	
 Beep Duration = 160 msec	
	 Beep Duration = 180 msec
 Beep Duration = 200 msec	

Beep Volume

Selects the beeper volume (loudness) of radio-specific beep indications. There are three selectable volume levels.

 ENTER/EXIT PROGRAMMING MODE	
 Beep Volume = Low	
	 Beep Volume = Medium
 Beep Volume = High	

BT Base Station Beep

Enables/disables a beep indication when the handheld is placed in the Base Station.



Disconnect Beep

Enables/disables the beep indication that a handheld has become disconnected from a Base Station.



BT Leash Alarm

This setting specifies the number of seconds to sound the Leash Mode beeps (three per second) when the handheld goes out of range. This is especially useful in instances where the reader might inadvertently have been placed in a bag or cart.

For this mode to be effective, the feature [Sleep Mode Timeout on page 23](#), must be disabled. If the reader is asleep, there is no way for it to know where it is relative to the Base Station because communication is not active between the devices.

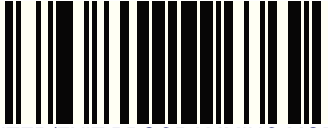
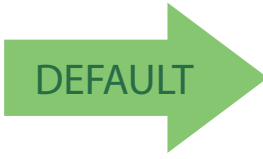
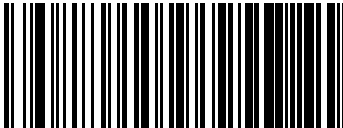
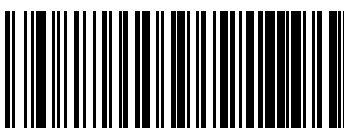
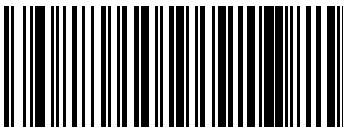
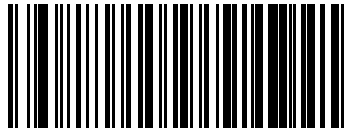
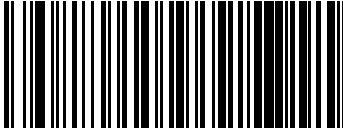
 ENTER/EXIT PROGRAMMING MODE	
	 BT Leash Alarm = Disabled
 BT Leash Alarm = 1 Second	
	 BT Leash Alarm = 2 Seconds
 BT Leash Alarm = 3 Seconds	
	 BT Leash Alarm = 4 Seconds

BT Leash Alarm – cont.

 ENTER/EXIT PROGRAMMING MODE	
 BT Leash Alarm = 5 Seconds	
	 BT Leash Alarm = 10 Seconds
 BT Leash Alarm = 25 Seconds	
	 BT Leash Alarm = 30 Seconds

Flash Update

BT Automatic Flash Update

This feature enables/disables the automatic flash update of a reader.

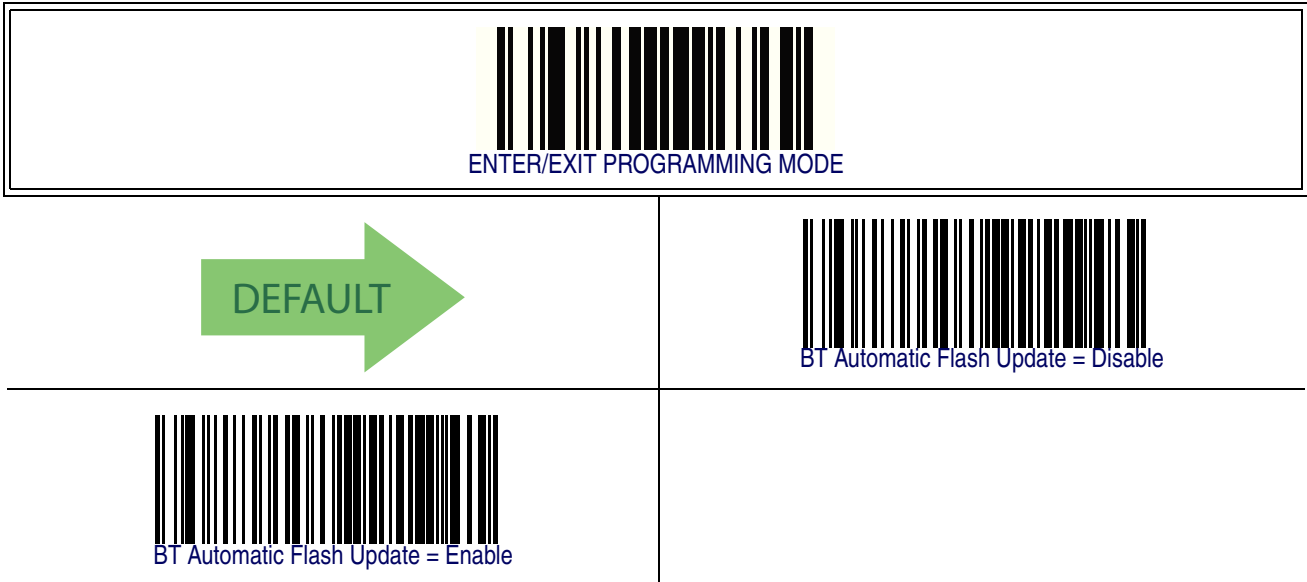

Request Flash Update

Scan this barcode to request a flash update from a Base Station



Do not scan an ENTER/EXIT PROGRAMMING MODE label in conjunction with this barcode.

NOTE

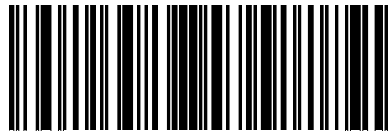

Request Flash Update

Configuration Update

Automatic Configuration Update

When this feature is enabled, a reader and its linked Base Station can automatically ensure they stay in sync with regard to application hardware and/or configuration. This is accomplished by the linked reader and Base Station comparing application version number and configuration file check sum. If either is different, the Base Station will automatically update the reader with its application/configuration.

If the units are linked, any changes made to the Base Station configuration through the Aladdin™ software will automatically be sent to the reader at the completion of the programming session.

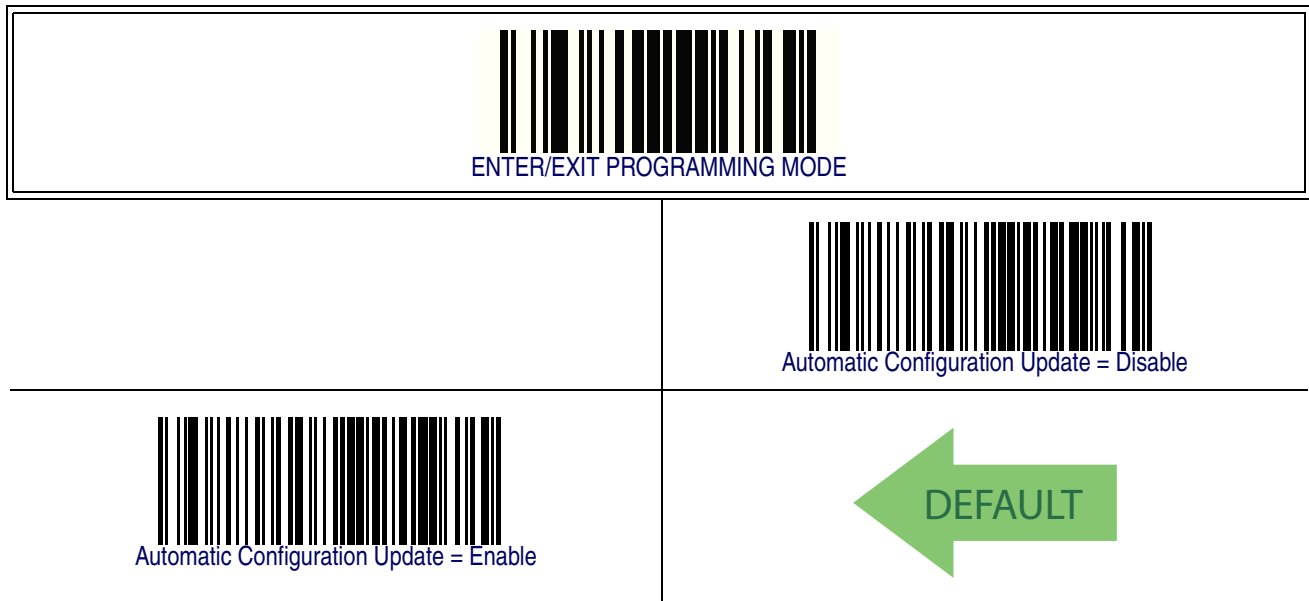

Configuration Update From Base Station to Handheld

Scan this barcode to manually request a one-time configuration update from the Base Station to the handheld.



Do not scan an ENTER/EXIT PROGRAMMING MODE label in conjunction with this barcode.

NOTE



Configuration Update From Base Station to Handheld

Configuration Update — cont.

Copy Configuration From Handheld to Base Station

Use this barcode to manually copy the handheld configuration to the Base Station.



Do not scan an ENTER/EXIT PROGRAMMING MODE label in conjunction with this barcode.

NOTE

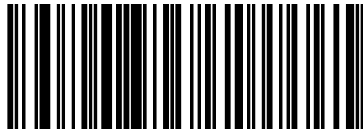

Copy Configuration From Handheld to Base Station

Battery Charge Mode

This feature specifies the battery charge mode for the Base Station.

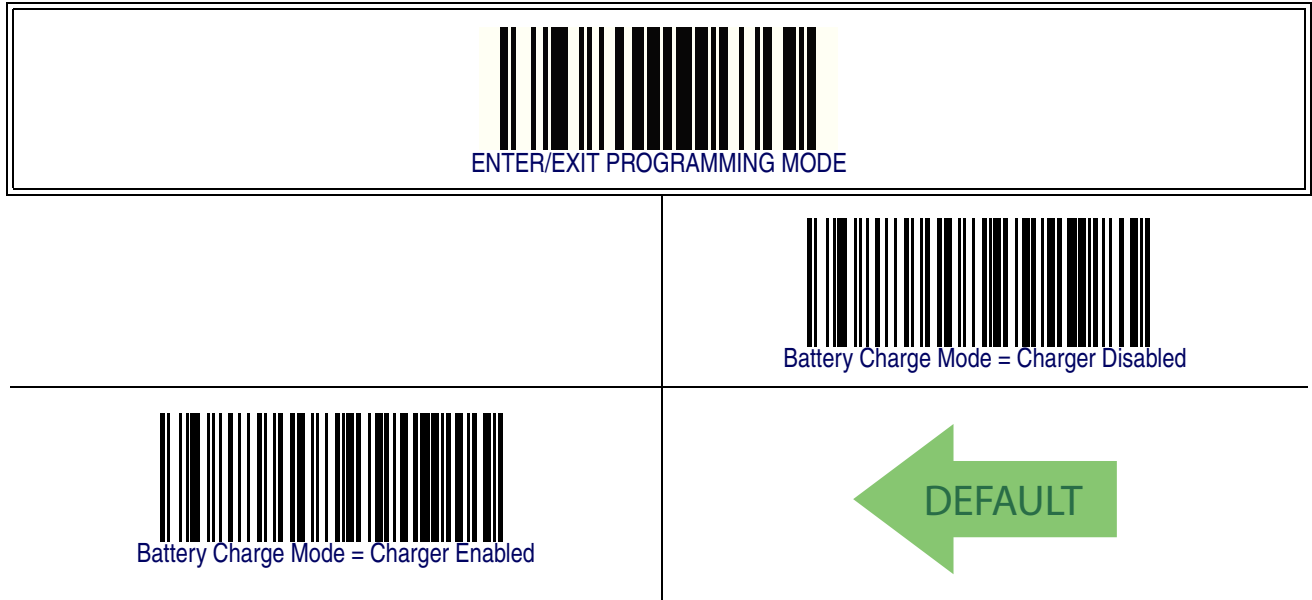

Powerdown Timeout

The Powerdown Timeout feature sets the time for automatically switching the unit off when the imager has been idle.

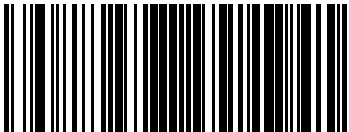



 ENTER/EXIT PROGRAMMING MODE	
	 Powerdown Timeout = Disable
 Powerdown Timeout = 10 minutes	
	 Powerdown Timeout = 20 minutes
 Powerdown Timeout = 30 minutes	
	 Powerdown Timeout = 40 minutes

Powerdown Timeout – continued

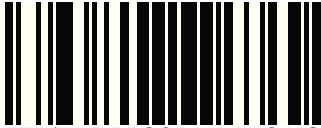
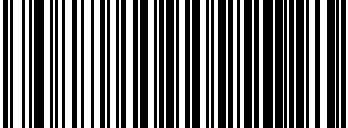
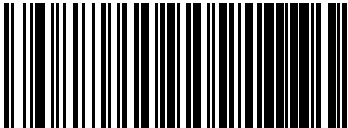
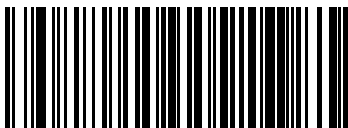

BT Poll Rate

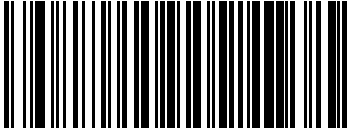
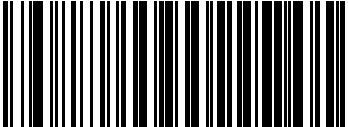
This feature Specifies the time between BT polls.

 ENTER/EXIT PROGRAMMING MODE	
 BT Poll Rate = Maximum BT Poll Rate	
	 BT Poll Rate = 10 ms
 BT Poll Rate = 20 ms	
	 BT Poll Rate = 30 ms
 BT Poll Rate = 50 ms	
	 BT Poll Rate = 100 ms

BT Poll Rate – cont.

 ENTER/EXIT PROGRAMMING MODE	
 BT Poll Rate = 150 ms	
	 BT Poll Rate = 200 ms
 BT Poll Rate = 500 ms	
	 BT Poll Rate = 990 ms

Batch Features

Batch Mode

This option specifies which mode to use to store labels in the handheld while disconnected from the base. Options are as follows:

- Disabled — The handheld will not store/batch labels.
- Automatic — The handheld will store labels to RAM when the handheld goes out of range and is disconnected from the remote device.
- Manual — The handheld will always store labels to Flash memory. The user must manually send the stored labels to the remote device using a special "batch send" label.

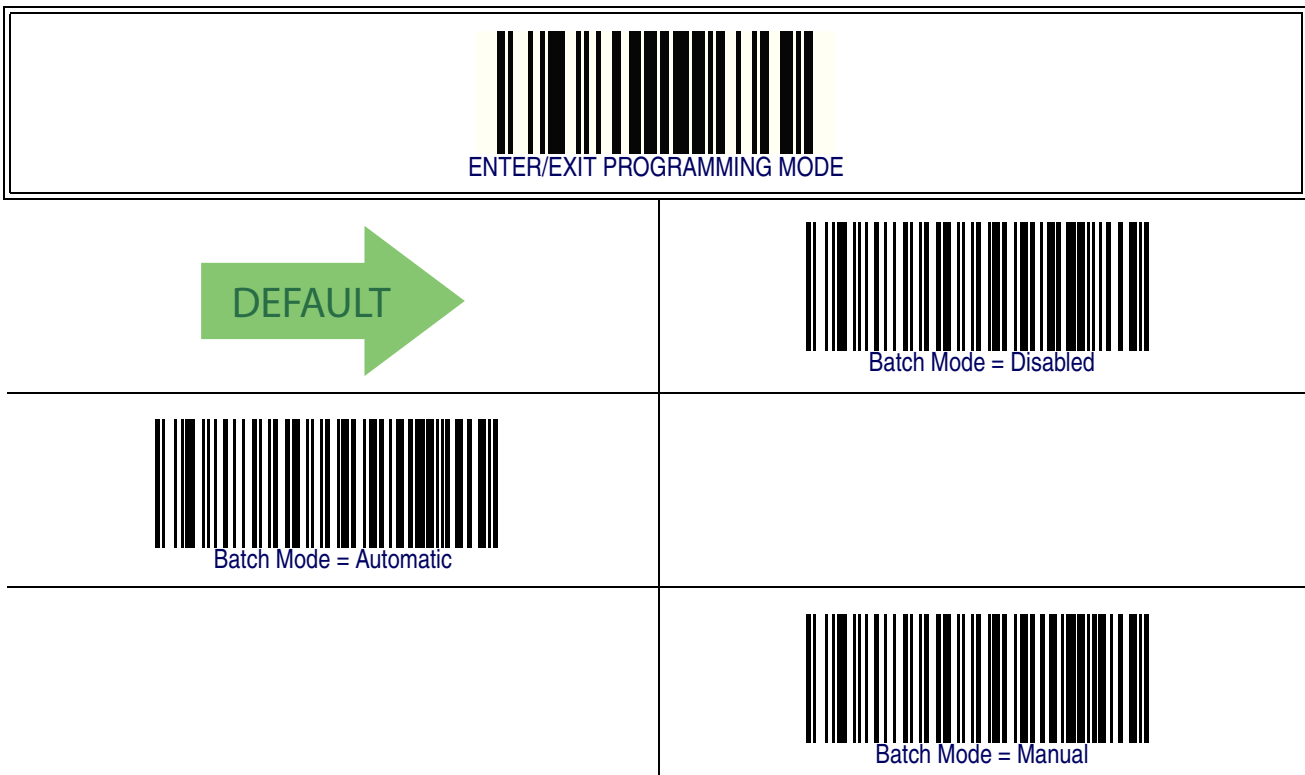

Batch Features – cont.

Send Batch

Use this barcode to initiate sending of labels stored in batch memory.



Do not scan an ENTER/EXIT PROGRAMMING MODE label in conjunction with this barcode.

NOTE

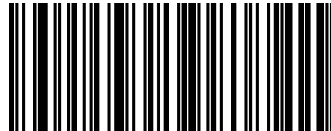

Send Batch

Erase Batch Memory

Use this barcode to erase any labels stored in batch memory.



Do not scan an ENTER/EXIT PROGRAMMING MODE label in conjunction with this barcode.

NOTE



Erase Batch Memory

Batch Features – cont.

BT Batch Mode Transmit Delay

Enables/disables the ability of the Base Station to emulate a PowerScan 7000 model Base Station. When enabled, the Base Station can link with a PowerScan 7000BT handheld.



BT Security Features

These features enable/disable the BT system to require a configurable pin code to authenticate/connect the BT devices, and encrypt the data.

BT Pin Code

This option specifies the 4-character pin code to be used for authentication of the BT link. [BT Security Mode on page 362](#) must be enabled in order to require the pin code.

To set the pin code:

1. Determine the desired characters. For example, D254.
2. Convert the characters to hexadecimal using the [ASCII Chart](#) on the inside back cover of this manual. In the case of the example, the hexadecimal equivalents would be:

D = 0x44, 2 = 0x32, 5 = 0x35, and 4 = 0x34

3. Scan the ENTER/EXIT PROGRAMMING MODE barcode to enter Programming Mode.
4. Scan the barcode: SELECT BT PIN CODE.
5. Scan the appropriate alpha-numeric characters from the keypad in [Appendix E, Keypad](#) representing the hexadecimal entries which was determined in the steps above. You will hear a two-beep indication after the last character.



If you make a mistake before the last character, scan the CANCEL barcode to abort and not save the entry string. You can then start again at the beginning.

NOTE

6. Scan the ENTER/EXIT PROGRAMMING MODE barcode to exit Programming Mode.

This completes the procedure. See [Table 45](#) for some examples of how to set this feature.



Changing the pin code setting will unlink the devices. If the Automatic Configuration Update is set to the default enabled setting, the devices must only be relinked. If the Automatic Configuration Update is set to the disabled setting, the Pin Code setting must also be updated in the Base Station using Aladdin. After the Base Station has been updated the devices must be relinked.



NOTE

This completes the procedure. See [Table 45](#) for some examples of how to set this feature.

Table 45. BT Pin Code Setting Examples

STEP	ACTION	EXAMPLES			
1	Desired Setting	1234	D254	1359	STOR
2	Convert the characters to hexadecimal	31 32 33 34	44 32 35 34	31 33 35 39	53 54 4F 52
3	Scan ENTER/EXIT PROGRAMMING MODE				
4	Scan SELECT LABEL GONE TIMEOUT SETTING				
5	Scan the Eight Alpha-Numeric Characters From Appendix E, Keypad	31323334	44323534	31333539	53544F52
6	Scan ENTER/EXIT PROGRAMMING MODE				

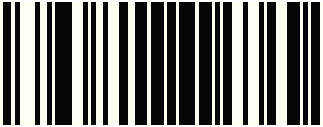
BT Pin Code – cont.

 ENTER/EXIT PROGRAMMING MODE	
 Select BT Pin Code	
Make a mistake? Scan the CANCEL barcode to abort and not save the entry string. You can then start again at the beginning.	 CANCEL



31323334 = Default Pin Code is 1234

BT Security Mode

This feature enables/disables authentication and encryption of the BT link. Use the feature, [BT Pin Code on page 359](#), to specify the pin code used to authenticate the BT Link.



NOTE

Changing the security mode setting will unlink the devices. If the Automatic Configuration Update is set to the default enabled setting, the devices must only be relinked. If the Automatic Configuration Update is set to the disabled setting, the Security Mode setting must also be updated in the Base Station using Aladdin. After the Base Station has been updated the devices must be relinked.

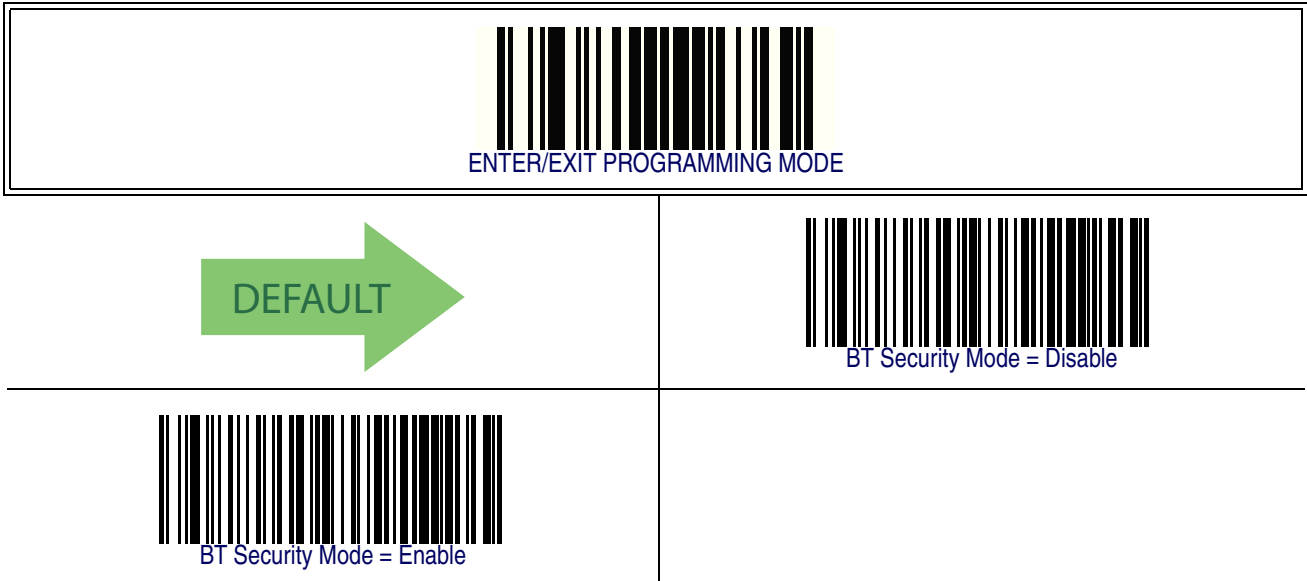

Linking the Reader

The PBT7100 reader can link to a PBT7100 Base Station or to a PC. See the [Getting Started](#) section in the front of this manual for information. See the following section for information on linking a PowerScan 7000 reader to a PBT7100 Base Station.

Optional: Linking a PowerScan 7000 Reader to a PBT7100 Base Station

A PowerScan 7000 reader can optionally be linked in Serial Port Profile mode to a PBT7100 Base Station. In this configuration, the paging feature and host commands are not supported.



To use this feature, [BT Security Mode on page 362](#) must be disabled.

NOTE

To do this, follow these steps:

1. Enable the SPP Mode in the Base Station by scanning the “[BT SPP Mode = Enable](#)” label with a PBT7100 reader that is linked to the PBT7100 Base Station. Optionally, Aladdin may be used to enable SPP Mode in the Base Station.
2. Create a Code 128 link barcode with the following format: <Fnc3>LnkB<12 character Base Station bluetooth address>. The bluetooth address of the Base Station can be found printed below the barcode on the top of the PowerScan 7100 Base Station.
3. Put the PowerScan 7100 Base Station in link mode by pressing the button for 2 seconds and then scan the link label created in step 2 with the PowerScan 7000 reader.



A PBT7100 reader can link in SPP mode to a PBT7100 Base Station using the label created in step 2.

NOTE

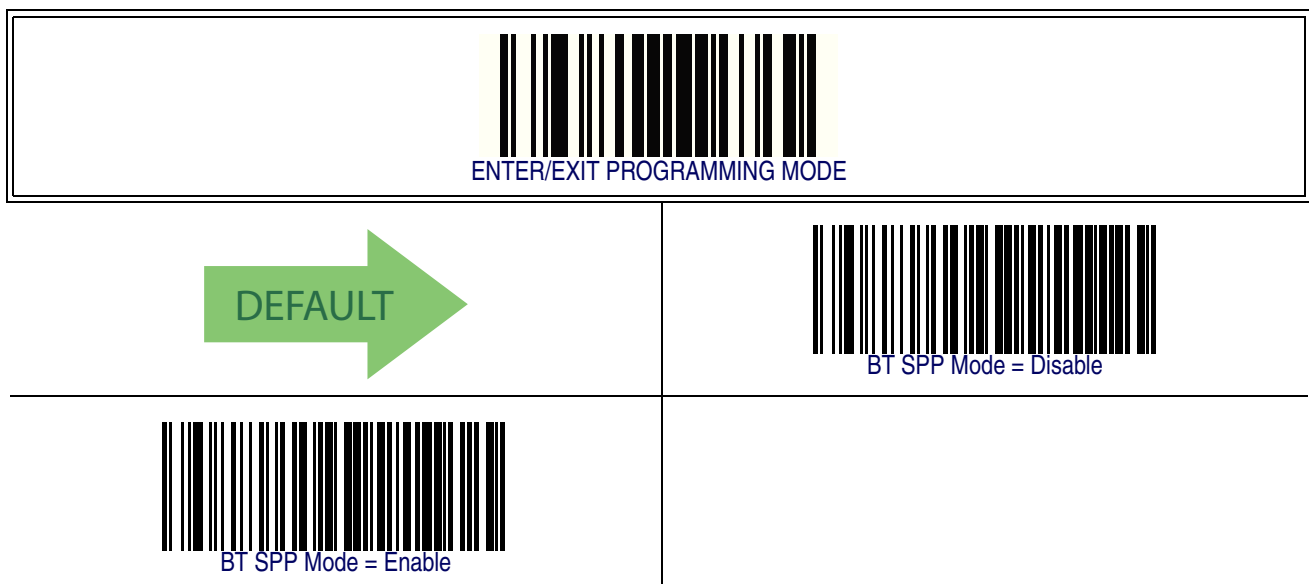

BT Address Stamping

These features allow configuration of source radio data inclusion.

Source Radio Address Transmission

Enables/disables the ability of source radio information to be transmitted to the host and, if so, at what position with respect to the label data.

Options are:

Do Not Include — Do not include source-radio ID

Prefix — Include source-radio ID as prefix



NOTE

When included as a prefix, the source-radio ID is displayed after all label formatting has been applied.

The 6 byte hex address is sent as 12 ascii characters, ie, an address of:

00 06 66 00 1A ED

will be sent as (shown in hex):

30 30 30 36 36 36 30 30 31 41 45 44

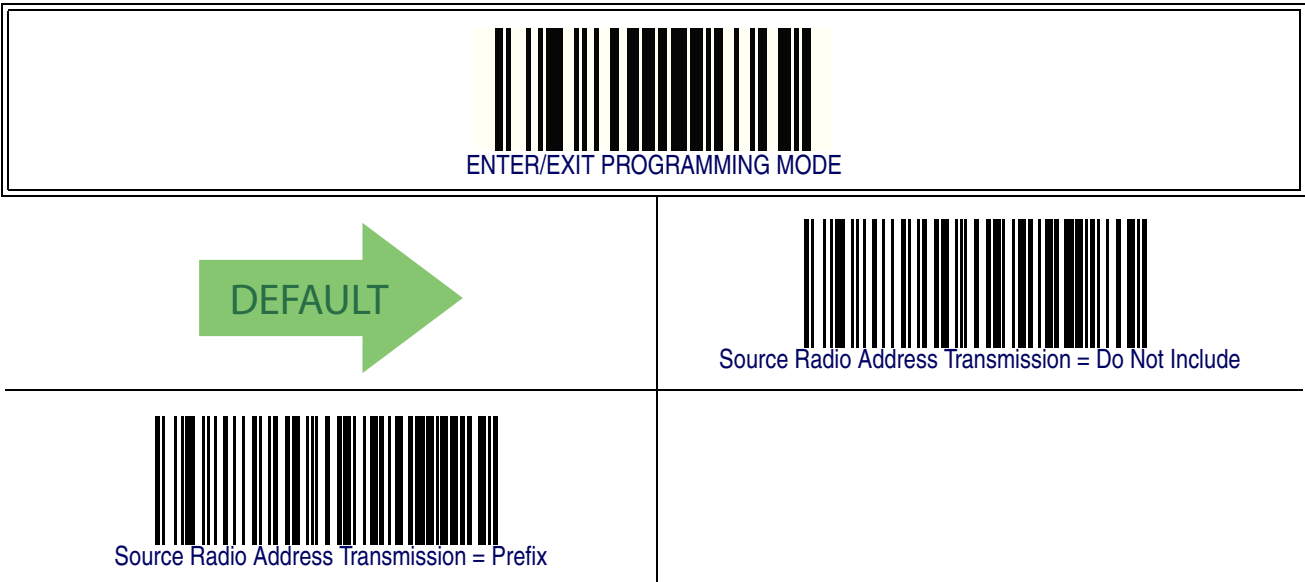

Source Radio Address Delimiter Character

This option specifies the delimiter character to be placed between the label data and radio address when address stamping is enabled.



This feature only applies if [Source Radio Address Transmission](#) on [page 364](#) is enabled.

NOTE

Follow these instructions to select the delimiter character:

1. Determine the desired character, then find its hexadecimal equivalent on the [ASCII Chart](#) on the inside back cover. A setting of 00 specifies no delimiter character.
2. Scan the ENTER/EXIT PROGRAMMING MODE barcode to enter Programming Mode.
3. Scan the barcode: SET SOURCE RADIO ADDRESS DELIMITER CHARACTER.
4. Scan the appropriate two digits from the keypad in [Appendix E, Keypad](#), that represent the hexadecimal characters which were determined in the steps above. You will hear a two-beep indication after the last character.



If you make a mistake before the last character, scan the CANCEL barcode to abort and not save the entry string. You can then start again at the beginning.

NOTE

5. Scan the ENTER/EXIT PROGRAMMING MODE barcode to exit Programming Mode.

This completes the procedure. See [Table 46](#) for some examples of how to set this feature.

Table 46. Source Radio Address Delimiter Character Setting Examples

STEP	ACTION	EXAMPLES			
1	Desired Setting	No delimiter character	, (comma)	- (dash)	/ (slash)
2	Scan ENTER/EXIT PROGRAMMING MODE				
3	Scan SET SOURCE RADIO ADDRESS DELIMITER CHARACTER				
4	Scan Two Characters From Appendix E, Keypad	'0' and '0'	'2' and 'C'	'2' and 'D'	'2' AND 'F'
5	Scan ENTER/EXIT PROGRAMMING MODE				

Source Radio Address Delimiter Character – cont.

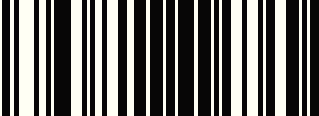
 ENTER/EXIT PROGRAMMING MODE
--

 Set Source Radio Address Delimiter Character

--

Make a mistake? Scan the CANCEL barcode to abort and not save the entry string. You can then start again at the beginning.

 CANCEL

 00 = No Delimiter Character

Appendix A

Technical Specifications

Table 47 contains Physical and Performance Characteristics, User Environment and Regulatory information. Table 48 provides Standard Cable Pinouts.

Table 47. Technical Specifications

Item	Description
Physical Characteristics — Reader	
Color	Yellow/Black Black/Black
Dimensions	Height 7.5"/190 mm Length 4.5"/115 mm Width 3.0"/75 mm
Weight (battery included)	Approximately 13.4 ounces/380 g
Physical Characteristics — Base Station	
Color	Black/Yellow
Dimensions	Height 1.8" (46 mm) — 5.45" (13.84cm) w/antenna Length 9.5" (24.13cm) Width 4.0" (10.16cm) — 4.75" (12.07cm) w/antenna
Weight	12.5 ounces/354 g
Electrical Characteristics — Base Station	
Input Voltage	5 VDC +/- 5% 7 – 14 VDC
Input Power Maximum Operating Power (charging dead battery) Typical Operating Power (charging full battery) Typical Standby Power	6.5 W (while charging) 1.4 W 1 W
Input Current Maximum Operating Current Typical Operating Current Typical Operating Current (TX data) Typical Standby Current (Idle)	1300 mA @ 5VDC 250 mA @ 5VDC 210 mA @ 5VDC 115 mA
Performance Characteristics	
Light Source	Dual LEDs

Item	Description
Roll (Tilt) Tolerance	± 30° from normal
Pitch Tolerance	± 82°
Skew (Yaw) Tolerance	± 65°
Field of View	2" wide at 1" from the reader 7" wide at 7" from the reader
Depth of Field	100 mil: typical 5.1" to 208.7" (13 cm to 530 cm) 55 mil: typical 1.9" to 118.1" (4.7 cm to 300 cm) 40 mil: typical 0.8" to 94.5" (2 cm to 240 cm) 20 mil: typical 0.1" to 46.9" (0.3 cm to 119 cm) 13 mil: typical 0" to 31.5" (0.1 cm to 80 cm) 10 mil: typical 0" to 23.6" (0 cm to 60 cm) 7.5 mil: typical 0.1" to 17.3" (0.2 cm to 44 cm) 5 mil: typical 0.6" to 5.5" (1.5 cm to 14 cm)
Minimum Element Width	3 mil
Print Contrast Minimum	15% minimum reflectance
Decode Capability	UPC/EAN/JAN, P2 /P5 add-ons; Code 39; Italian Code 32; Code 128; C128 ISBT; Code 128 add-ons; I 2 of 5; Datalogic 2 of 5; Standard 2 of 5; Code 11; Codabar; EAN 128; Code 93; MSI; DataBar Omnidirectional, DataBar Limited, DataBar Expanded.
Interfaces Supported	RS-232 Std., RS-232 Wincor-Nixdorf, RS-232 OPOS, IBM 46xx (ports 5B and 9B), USB Com Std., USB Keyboard, USB Alternate Keyboard, USB-OEM, Keyboard Wedge (AT with or w/o Alternate Key, IBM AT PS2 with or w/o Alternate Key, PC-XT, IBM 3153, IBM Terminals 31xx, 32xx, 34xx, 37xx make only and make break keyboard, and Digital Terminals VT2x, VT3xx, VT4xx, and Apple).
User Environment — Reader	
Operating Temperature	-4° to +122° F (-20° to +50° C)
Storage Temperature	-40° to +140° F (-40° to +60° C)
Humidity	Operating: 5% to 90% relative humidity, non-condensing Storage: 5% to 95% relative humidity, non-condensing
Drop Specifications	50 drops from 2 meters (6.5 feet) to concrete, -30°C to 50°C
Ambient Light Immunity	Up to 100,000 LUX in sunlight.
Contaminants Spray/rain Dust/particulates	IEC 529-IPX5 IEC 529-IP6X
Beeper Loudness	84 dBA typical for operator at a distance of 19" (50cm)

Item	Description
ESD Level	25 KV
User Environment — Base Station & Charger	
Contaminants Spray/rain Dust/particulates	IEC 529-IPX4 IEC 529-IP5X
Regulatory	
Electrical Safety	UL 60950-1, CSA C22.2 No. 60950-1, IEC 60950-1
EMI/RFI	USA FCC Part 15 Class B. Canada ICES-003 Class B. European Union EMC and R&TTE Directives. EN 301 489-17 — Radio Immunity. EN 300 328 v 1.7.1 Radio Emissions. EN 61000 6-2 — Generic Immunity for Industrial Environments. EN 50392 — Human exposure to electromagnetic fields.
Laser Safety	Complies with 21 CFR 1040 Class 2 and IEC/EN60825-1:2007 Class II when laser pointer installed.

Standard Cable Pinouts

Figure 8 and Table 48 provide standard pinout information for the Base Station's cable.

Figure 8. Standard Cable Pinouts

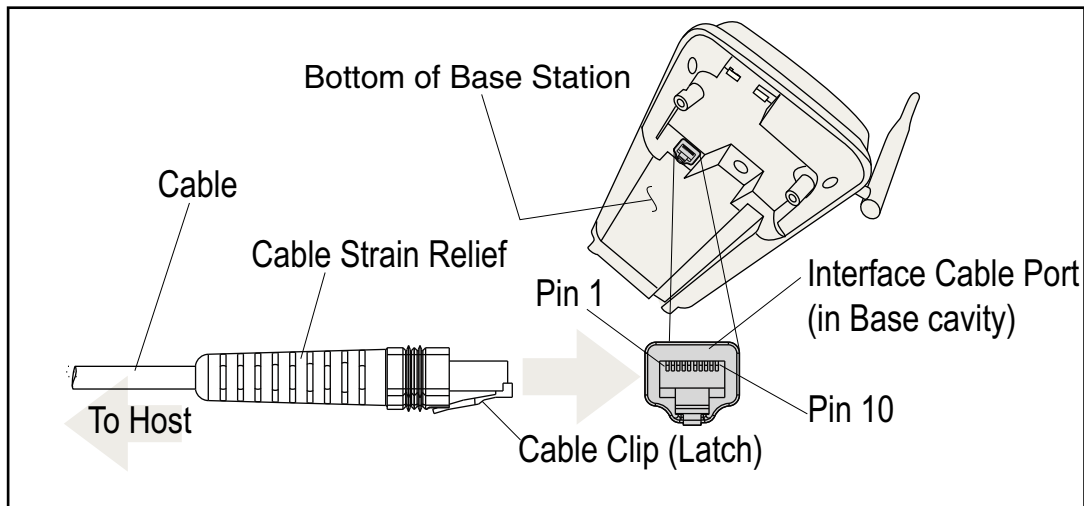

The signal descriptions in Table 48 apply to the connector on the Base Station and are for reference only.

Table 48. Standard Cable Pinouts — Base Station Side

Pin	RS-232	OEM	USB	Keyboard Wedge
1	RTS (out)			
2			D+	CLKIN (KBD side)
3			D-	DATAIN (KBD side)
4	GND	GND	GND	GND
5	RX			
6	TX			
7	VCC	VCC	VCC	VCC
8		IBM_B		CLKOUT (PC side)
9		IBM_A		DATAOUT (PC side)
10	CTS (in)			

Appendix B

Standard Defaults

The most common configuration settings are listed in the “Default” column of the table below. Page references are also provided for feature descriptions and programming barcodes for each parameter. A column has also been provided for recording of your preferred default settings for these same configurable features.

Table 49. Standard Defaults

Parameter	Default	Your Setting	Page Number
General Features			
Double Read Timeout	0.4 Second		19
Label Gone Timeout	160 ms		21
Sleep Mode Timeout	Disable		23
Sleep Mode Timeout	Disable		23
Power On Alert	4 Beeps		25
Good Read: When to Indicate	After Decode		26
Good Read Beep Type	Mono		27
Good Read Beep Frequency	High		28
Good Read Beep Length	80 ms		28
Good Read Beep Volume	High		30
Good Read LED Duration	2 Seconds		31
Scan Mode	Trigger Single		33
Stand Mode Triggered Timeout	0.5 Seconds		35
Scanning Active Time	5 Seconds		37
Flash On Time	1 Second		39
Flash Off Time	600 ms		41
Laser Pointer Control	Start scanning immediately after trigger		44
Laser Pointer Period	500 ms		45

Parameter	Default	Your Setting	Page Number
Green Spot Duration	300 ms		46
RS-232			
Baud Rate	9600		47
Data Bits	8 Data Bits		49
Stop Bits	1 Stop Bit		50
Parity	None		51
Handshaking Control	Disable		52
RS-232/USB-COM			
RTS/CTS Scan Control — RTS is asserted during transmissions. CTS gates transmissions and controls enable and disable state of scanner.	No Delay		52
Beep On ASCII BEL	Disable		56
Beep On Not on File	Enable		56
ACK Character	'ACK'		58
NAK Character	'NAK'		60
ACK NAK Timeout Value	600 ms		62
ACK NAK Retry Count	3 Retries		64
ACK NAK Error Handling	Ignore Errors Detected		66
Indicate Transmission Failure	Enable		67
Disable Character	'D'		68
Enable Character	'E'		70
Keyboard Wedge			
Country Mode	U.S. Keyboard		74
Caps Lock State	Caps Lock OFF		77
Numlock	Numlock Key Unchanged		77
Send Control Characters	Disable		78
Wedge Quiet Interval	100 ms		79
Intercharacter Delay	No Delay		81
Intercode Delay	No Delay		83

Parameter	Default	Your Setting	Page Number
USB Keyboard Speed	1 ms		85
USB-OEM			
USB-OEM Device Usage	Handheld Reader		88
USB-OEM Interface Options	Ignore		89
IBM			
46xx Number of Host Resets	6 Host Resets		92
Transmit Labels in Code 39 Format	IBM Std Format		95
IBM 46XX Interface Options	Ignore		96
Wand Emulation			
Wand Idle State	High		97
Wand Polarity	Quiet Zones and Spaces High, Bars Low		98
Wand Signal Speed	660 ms		99
Label Symbology Conversion	No Conversion		100
Transmit Noise	Disable		101
Data Editing			
Global Prefix/Suffix	No Global Prefix Global Suffix = 0x0D (CR)		104
Global AIM ID	Disable		106
Label ID Control	Disable		114
Case Conversion	Disable		123
Character Conversion	No Char Conversion		124
Symbologies			
Coupon Control	Enable only UPC/EAN coupon decoding		129
UPC-A			
UPC-A Enable/Disable	Enable		130
UPC-A Check Character Transmission	Enable		130
Expand UPC-A to EAN-13	Don't Expand		131

Parameter	Default	Your Setting	Page Number
UPC-A Number System Character Transmission	Transmit		131
UPC-A Minimum Reads	1		149
In-Store Minimum Reads	2		132
UPC-E			
UPC-E Enable/Disable	Enable		133
UPC-E Check Character Transmission	Send		133
Expand UPC-E to EAN-13	Don't Expand		134
Expand UPC-E to UPC-A	Don't Expand		134
UPC-E Number System Character Transmission	Transmit		135
UPC-E Minimum Reads	2		136
GTIN			
GTIN Formatting	Disable		137
EAN 13			
EAN 13 Enable/Disable	Enable		138
EAN 13 Check Character Transmission	Send		138
EAN-13 Flag 1 Character	Transmit		139
EAN-13 ISBN Conversion	Disable		140
ISSN Enable/Disable	Disable		140
EAN 13 Minimum Reads	1		141
EAN 8			
EAN 8 Enable/Disable	Enable		142
EAN 8 Check Character Transmission	Send		142
Expand EAN 8 to EAN 13	Disable		143
EAN 8 Minimum Reads	1		144
UPC/EAN Global Settings			
UPC/EAN Decoding Level	3		145
UPC/EAN Correlation	Disable		147
UPC/EAN Reconstruction	Disable		147

Parameter	Default	Your Setting	Page Number
UPC/EAN Price Weight Check	Disable		148
Add-Ons			
Optional Add-ons	Disable P2, P5 and P8		150
Optional Add-On Timer	70 ms		152
Optional GS1-128 Add-On Timer	Disable		155
P2 Add-Ons Minimum Reads	2		158
P5 Add-Ons Minimum Reads	1		159
GS1-128 Add-Ons Minimum Reads	1		160
DataBar Omnidirectional			
GS1 DataBar Omnidirectional Enable/Disable	Disable		161
GS1 DataBar Omnidirectional GS1-128 Emulation	Disable		161
GS1 DataBar Omnidirectional Minimum Reads	1		162
DataBar Expanded			
GS1 DataBar Expanded Enable/Disable	Disable		163
GS1 DataBar Expanded GS1-128 Emulation	Disable		163
GS1 DataBar Expanded Minimum Reads	1		164
GS1 DataBar Expanded Length Control	Variable		165
GS1 DataBar Expanded Set Length 1	1		166
GS1 DataBar Expanded Set Length 2	74		168
DataBar Limited			
GS1 DataBar Limited Enable/Disable	Disable		170
GS1 DataBar Limited GS1-128 Emulation	Disable		170
GS1 DataBar Limited Minimum Reads	1		171
Code 39			
Code 39 Enable/Disable	Enable		172
Code 39 Check Character Calculation	Calculate		173

Parameter	Default	Your Setting	Page Number
Code 39 Check Character Transmission	Send		174
Code 39 Start/Stop Character Transmission	Don't Transmit		174
Code 39 Full ASCII	Disable		175
Code 39 Quiet Zones	Auto		176
Code 39 Minimum Reads	1		177
Code 39 Decoding Level	3		178
Code 39 Length Control	Variable		180
Code 39 Set Length 1	2		181
Code 39 Set Length 2	50		183
Code 39 Interdigit Ratio	4		185
Code 39 Character Correlation	Disable		187
Code 39 Stitching	Enable		188
Code 32			
Code 32 Enable/Disable	Disable		189
Code 32 Feature Setting Exceptions	3		189
Code 32 Check Character Transmission	Don't Send		190
Code 32 Start/Stop Character Transmission	Don't Transmit		190
Code 39 CIP (French Pharmaceutical)			
Code 39 CIP Enable/Disable	Disable		191
Code 128			
Code 128 Enable/Disable	Enable		191
Expand Code 128 to Code 39	Don't Expand		192
Code 128 Check Character Transmission	Send		192
Code 128 Quiet Zones	Auto		195
Code 128 Minimum Reads	1		196
Code 128 Decoding Level	3		197
Code 128 Length Control	Variable		199
Code 128 Set Length 1	1		200

Parameter	Default	Your Setting	Page Number
Code 128 Set Length 2	80		202
Code 128 Character Correlation	Disable		204
Code 128 Stitching	Enable		205
UCC-EAN 128			
GS1-128 Enable	Transmit in Code 128 Data Format		206
ISBT 128			
ISBT 128 Concatenation	Disable		288
ISBT 128 Concatenation Mode	Static		289
ISBT 128 Dynamic Concatenation Timeout	200 ms		290
ISBT 128 Force Concatenation	Enable		291
ISBT 128 Advanced Concatenation Options	Disable		291
Interleaved 2 of 5			
I 2 of 5 Enable/Disable	Enable		207
I 2 of 5 Check Character Calculation	Disable		208
I 2 of 5 Check Character Transmission	Send		209
I 2 of 5 Minimum Reads	1		222
I 2 of 5 Decoding Level	3		211
I 2 of 5 Length Control	Variable		213
I 2 of 5 Set Length 1	12		214
I 2 of 5 Set Length 2	100		216
I 2 of 5 Character Correlation	Disable		218
I 2 of 5 Stitching	Disable		219
Interleaved 2 of 5 CIP HR			
Interleaved 2 of 5 CIP HR Enable/Disable	Disable		220
Datalogic 2 of 5			
Datalogic 2 of 5 Enable/Disable	Enable		220
Datalogic 2 of 5 Check Character Calculation	Disable		221

Parameter	Default	Your Setting	Page Number
Datalogic 2 of 5 Minimum Reads	1		222
Datalogic 2 of 5 Length Control	Variable		223
Datalogic 2 of 5 Set Length 1	12		224
Datalogic 2 of 5 Set Length 2	100		226
Datalogic 2 of 5 Character Correlation	Disable		230
Datalogic 2 of 5 Stitching	Disable		231
Codabar			
Codabar Enable/Disable	Disable		232
Codabar Check Character Calculation	Don't Calculate		233
Codabar Check Character Transmission	Send		234
Codabar Start/Stop Character Transmission	Don't Transmit		234
Codabar Start/Stop Character Set	abcd/abcd		235
Codabar Start/Stop Character Match	Don't Require Match		236
Codabar Quiet Zones	Auto		237
Codabar Minimum Reads	1		238
Codabar Decoding Level	3		239
Codabar Length Control	Variable		241
Codabar Set Length 1	3		242
Codabar Set Length 2	50		244
Codabar Interdigit Ratio	4		246
Codabar Character Correlation	Disable		248
Codabar Stitching	Disable		249
ABC Codabar			
ABC Codabar Enable/Disable	Disable		250
ABC Codabar Concatenation Mode	Static		250
ABC Codabar Dynamic Concatenation Timeout	200ms		251
ABC Codabar Force Concatenation	Disable		252
Code 11			
Code 11 Enable/Disable	Disable		253

Parameter	Default	Your Setting	Page Number
Code 11 Check Character Calculation	Check C and K		254
Code 11 Check Character Transmission	Send		255
Code 11 Minimum Reads	1		256
Code 11 Length Control	Variable		257
Code 11 Set Length 1	4		258
Code 11 Set Length 2	50		260
Code 11 Interdigit Ratio	4		262
Code 11 Decoding Level	3		264
Code 11 Character Correlation	Disable		266
Code 11 Stitching	Disable		267
Standard 2 of 5			
Standard 2 of 5 Enable/Disable	Disable		268
Standard 2 of 5 Check Character Calculation	Disable		269
Standard 2 of 5 Check Character Transmission	Send		269
Standard 2 of 5 Minimum Reads	1		270
Standard 2 of 5 Decoding Level	3		270
Standard 2 of 5 Length Control	Variable		271
Standard 2 of 5 Set Length 1	8		272
Standard 2 of 5 Set Length 2	50		274
Standard 2 of 5 Character Correlation	Disable		276
Standard 2 of 5 Stitching	Disable		277
Industrial 2 of 5			
Industrial 2 of 5 Enable/Disable	Disable		278
Industrial 2 of 5 Check Character Calculation	Disable		278
Industrial 2 of 5 Check Character Transmission	Enable		279
Industrial 2 of 5 Length Control	Variable		280
Industrial 2 of 5 Set Length 1	1 Char		281

Parameter	Default	Your Setting	Page Number
Industrial 2 of 5 Set Length 2	50 Chars		283
Industrial 2 of 5 Minimum Reads	1 Read		285
Industrial 2 of 5 Stitching	Disable		286
Industrial 2 of 5 Character Correlation	Disable		286
IATA			
IATA Enable/Disable	Disable		287
IATA Check Character Transmission	Enable		287
ISBT 128			
ISBT 128 Concatenation	Disable		288
ISBT 128 Concatenation Mode	Static		289
ISBT 128 Dynamic Concatenation Time-out	200 ms		290
ISBT 128 Force Concatenation	Disable		291
ISBT 128 Advanced Concatenation Options	Disable		291
MSI			
MSI Enable/Disable	Disable		292
MSI Check Character Calculation	Enable Mod 10		293
MSI Check Character Transmission	Enable		294
MSI Length Control	Variable		294
MSI Set Length 1	1 Char		295
MSI Set Length 2	50 Chars		297
MSI Minimum Reads	4 Reads		299
MSI Decoding Level	Level 3		300
Plessey			
Plessey Enable/Disable	Disable		302
Plessey Check Character Calculation	Enable Plessey Std and Anker Check Verification		303
Plessey Check Character Transmission	Enable		304
Plessey Length Control	Variable		304

Parameter	Default	Your Setting	Page Number
Plessey Set Length 1	1 Char		305
Plessey Set Length 2	50 Chars		307
Plessey Minimum Reads	4 Reads		309
Plessey Decoding Level	Level 3		310
Plessey Stitching	Disable		311
Plessey Character Correlation	Disable		312
Code 93			
Code 93 Enable/Disable	Disable		312
Code 93 Check Character Calculation	Enable Check C and K		313
Code 93 Check Character Transmission	Enable		314
Code 93 Length Control	Variable		314
Code 93 Set Length 1	1 Char		315
Code 93 Set Length 2	50 Chars		317
Code 93 Minimum Reads	1 Read		319
Code 93 Decoding Level	Level 3		320
Code 93 Quiet Zones	Auto		322
Code 93 Stitching	Enable		323
Code 93 Character Correlation	Enable		323
Codablock F			
Codablock F Enable/Disable	Enable		324
Codablock F EAN Enable/Disable	Disable		325
Codablock F AIM Check	Enable Check C		325
Codablock F Length Control	Variable		326
Codablock F Set Length 1	3 Chars		327
Codablock F Set Length 2	100 Chars		329
Code 4			
Code 4 Enable/Disable	Disable		331
Code 4 Check Character Transmission	Don't Send		332
Code 4 Hex to Decimal Conversion	Enable		332

Parameter	Default	Your Setting	Page Number
Code 5			
Code 5 Enable/Disable	Disable		333
Code 5 Check Character Transmission	Send		334
Code 5 Hex to Decimal Conversion	Enable		334
Code 4 and Code 5 Common Configuration Items			
Code 4 and 5 Decoding Level	3		335
Code 4 and Code 5 Minimum Reads	1		337
Follett 2 of 5			
Follett 2 of 5 Enable/Disable	Disable		338
BT Features			
ACK Beep	Enable		340
Beep Frequency	Low		341
Beep Duration	80 ms		342
Beep Volume	High		344
BT Base Station Beep	Disable		345
Disconnect Beep	Enable		345
BT Leash Alarm	Enable		346
BT Leash Alarm	Disable		346
BT Automatic Flash Update	Disable		348
Automatic Configuration Update	Enable		349
Battery Charge Mode	Low Charge		351
Powerdown Timeout	Disable		
BT Poll Rate	Wait Forever		354
BT Poll Rate	2 Seconds		354
BT Poll Rate	20 ms		354
Batch Mode	Disable		356
BT Batch Mode Transmit Delay	No Delay		358
BT Pin Code	1234		359
BT Security Mode	Disable		362

Parameter	Default	Your Setting	Page Number
Optional: Linking a PowerScan 7000 Reader to a PBT7100 Base Station	Disable		363
BT Address Stamping	Send HACK as soon as the Base Station receives a label		364
Source Radio Address Transmission	Do Not Include		364
Source Radio Address Delimiter Character	No Delimiter Character		365

NOTES

Appendix C

LED and Beeper Indications

The reader's beeper sounds and its LED illuminates to indicate various functions or errors on the reader. An optional "Green Spot" also performs useful functions. The tables below list these indications. One exception to the behaviors listed in the tables is that the reader's functions are programmable, and may or may not be turned on. For example, certain indications, such as the power-up beep can be disabled using programming barcode labels.

General Functions — LED and Beeper Indications

INDICATION	DESCRIPTION	LED	BEEPER
Power-up Beep	The reader is in the process of powering-up.		Reader beeps four times at highest frequency and volume upon power-up.
Good Read Beep	A label has been successfully scanned by the reader.	LED behavior for this indication is configurable via the feature “Good Read: When to Indicate”	The reader will beep once at current frequency, volume, mono/bi-tonal setting and duration upon a successful label scan.
ROM Failure	There is an error in the reader's software/programming	Flashes	Reader sounds one error beep at highest volume.
Limited Scanning Label Read	Indicates that a host connection is not established when the IBM or USB interface is enabled.	N/A	Reader 'chirps' six times at the highest frequency and current volume.
Reader Active Mode	The reader is active and ready to scan.	The LED is lit steadily ^a	N/A
Reader Disabled	The reader has been disabled by the host.	The LED blinks continuously	N/A
Green Spot is on continuously	While in Object Sense mode or Trigger Object Sense mode the green spot shall be on while in stand watch state.	N/A	N/A
Green Spot ^a flashes momentarily	Upon successful read of a label, the software shall turn the green spot on for the time specified by the configured value.	N/A	N/A

Programming Mode - The following indications ONLY occur when the reader is in Programming Mode.

Label Programming Mode Entry	A valid programming label has been scanned.	LED blinks continuously	Reader sounds four low frequency beeps.
Label Programming Mode Rejection of Label	A label has been rejected.	N/A	Reader sounds three times at lowest frequency & current volume.
Label Programming Mode Acceptance of Partial Label	In cases where multiple labels must be scanned to program one feature, this indication acknowledges each portion as it is successfully scanned.	N/A	Reader sounds one short beep at highest frequency & current volume.
Label Programming Mode Acceptance of Programming	Configuration option(s) have been successfully programmed via labels and the reader has exited Programming Mode.	N/A	Reader sounds one high frequency beep and 4 low frequency beeps followed by reset beeps.
Label Programming Mode Cancel Item Entry	Cancel label has been scanned.	N/A	Reader sounds two times at low frequency and current volume.

^a. Except when in sleep mode or when a Good Read LED Duration other than 00 is selected

BT Beeper Indications

Beep Type	Description	Behavior
Acknowledge (ACK) Label	A label has been sent to the Base Station, which has accepted the data and responded. Control via ACK NAK Options on page 57 .	1 beep. Duration, frequency and volume vary, since these are all configurable for this feature.
Label Rejected	Label data sent is rejected by the Base Station (responds with NAK). Control via ACK NAK Options on page 57 .	2 beeps at low frequency.
Transmission Error	A label has been sent to but not received by the Base Station (ACK timeout occurred). Control via Indicate Transmission Failure on page 67 .	Beep will sound High-low-high-low.
Link Successful	The Linking process has completed successfully between a reader and Base Station (or PC).	Beep will sound Low-med-high.
Link Unsuccessful	The Linking process has completed (timed out) without connecting to a Base (or PC).	Beep will sound High-low-high-low.
Unlink	The reader has unlinked from the Base Station.	Beep will sound High-medium-low.
Paging	Base Station is paging the reader.	5 beeps at high volume and current Good Read Beep Frequency setting.
BT Reader FRU	The reader will sound this upon detecting a Field Replaceable Unit (FRU) error at startup.	1 long error tone ^a .
Disconnect	Sounds when the reader disconnects from the Base Station due to out of range, low power, etc. Control via Disconnect Beep on page 345 .	Beep will sound High-medium-low. (Same as Unlink)
Good Read Disconnected	A label is read while disconnected, and BT Poll Rate on page 354 is disabled.	1 long beep at low frequency.
Good Read Unlinked	A label is read while unlinked.	Beep will sound High-low-high-low.
Leash mode	The Handheld has disconnected, and BT Leash Alarm on page 346 is enabled.	Beep will sound at high volume, low frequency for the count specified in BT Leash Alarm on page 346 .
Low Battery	The battery is getting low	10 beeps at high frequency
Battery Shutdown	The battery has reached a critical low level and the handheld will shut down.	Beep will sound High-medium-low

^a. Upon hearing a long error tone at startup, press the trigger to hear the FRU error beep sequence described in [Error Codes on page 389](#).

BT LED Indications

LED Indication	Behavior	Applies to:	
		Base Station	Reader
Linking in progress	Yellow LED blinks at 2 Hz	YES	YES
Low battery	Green LED blinks 10 times after either of the following events occur: -After every 10th trigger pull. -After 30 seconds of idle time. NOTE: Low battery LED indication coincides with the low battery beep.	NO	YES
Disconnected	LEDs off	YES	YES
Unlinked	LEDs off	YES	YES
BT transmission in progress	Flash yellow LED at 50 Hz while transmitting.	YES	YES
Paging	Yellow LED blinks at the same rate as the paging beep (1 hz)	YES	YES
BT Reader FRU indication	See the topic Error Codes on page 389 .	NO	YES
BT Base Station FRU indication	See the topic Error Codes on page 389 .	YES	NO
Disabled indication	Green LED blinks once a second while disabled	NO	YES
Battery charge in progress	Green LED blinks once a second while charging	YES	NO
Battery charge complete	Green LED stays ON when charge is complete and reader is seated in the Base Station.	YES	NO
Battery charge error	Yellow LED blinks 550mS on/1500mS off when there is a charge error and reader is seated in the Base Station.	YES	NO

Error Codes

Upon startup, if the reader sounds a long tone, this means the reader has not passed its automatic Selftest and has entered FRU¹ isolation mode. If the reader is reset, the sequence will be repeated. The following table describes the LED flashes/beep codes associated with an error found.

NUMBER OF LED FLASHES/BEEPS	ERROR	CORRECTIVE ACTION
1	Configuration	Contact Helpdesk for assistance
2	Interface PCB	
4	Reader Module	
5	Laser Pointer (if so equipped)	
6	Digital PCB	
14	CPLD/Code Mismatch	

1. Field Replaceable Unit (FRU)

NOTES

Appendix D

Sample Barcodes

The sample barcodes in this appendix are typical representations for their symbology types.



UPC-A

EAN-13



Code 39

Code 128



Interleaved 2 of 5

Sample Barcodes – continued

Code 32



Codabar



Code 93



Code 11

MSI



DataBar (RSS)



DataBar variants must be enabled to read the barcodes below (see [DataBar \(RSS\)](#) on page 393).

NOTE

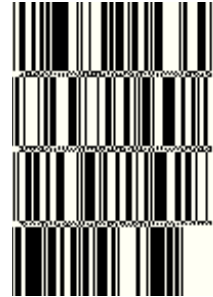

10293847560192837465019283746029478450366523
(DataBar Expanded Stacked)



1234890hji09900mnb
(DataBar Expanded)



08672345650916
(DataBar Limited)

DataBar-14



55432198673467
(DataBar Omnidirectional Truncated)



90876523412674
(DataBar Omnidirectional Stacked)









78123465709811
(DataBar Omnidirectional Stacked)





NOTES

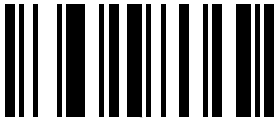
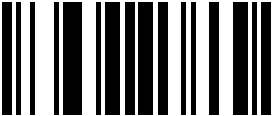

Appendix E

Keypad

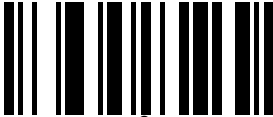
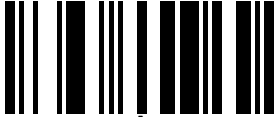
Use the barcodes in this appendix to enter numbers as you would select digits/characters from a keypad.

 0	
	 1
 2	
	 3
 4	
	 5

 6	
	 7
 8	
	 9
 A	
	 B
 C	

	 D
 E	
	 F

NOTES

Appendix F

Scancode Tables

Control Character Emulation

Control character emulation selects from different scancode tables as listed in this appendix. Each of the control character sets below are detailed by interface type in the tables. These apply to Wedge and USB Keyboard platforms.

Control Character 00 . Characters from 00 to 0x1F are sent as control character Ctrl+Keys, special keys are located from 0x80 to 0xA1.

Control Character 01 . Characters from 00 to 0x1F are sent as control character Ctrl+Capital Key, special keys are located from 0x80 to 0xA1.

Control Character 02 . Special keys are located from 00 to 0x1F and characters from 0x80 to 0xFE are intended as an extended ASCII table ([Microsoft Windows Codepage 1252 on page 410](#))

Single Press and Release Keys

In the following tables, Ar↓ means Alt right pressed and Ar↑ means Alt right released and so on. Definitions for other keys are Al (Alt left), Cr (Control Right) Cl (Control Left) Sh (shift). This method can be used for combining Alt, Control or Shift with other keys.

Example: Consider a Control character set to 00. If AltRight+A is required before sending a label to the host, it could be done by setting three Prefix keys in this way: 0x99 0x41 0x9A.

Interface Type PC AT PS/2 or USB-Keybaord

Table F-1. Scancode Set When Control Character is 00 or 01

	x0	x1	x2	x3	x4	x5	x6	x7	x8	x9	xA	xB	xC	xD	xE	xF
0x	NULL C+@	SOH C(S)+A	STX C(S)+B	ETX C(S)+C	EOT C(S)+D	ENQ C(S)+E	ACK C(S)+F	BEL C(S)+G	BS	HT TAB	LF C(S)+J	VT C(S)+K	FF C(S)+L	CR Enter	SO C(S)+N	SI C(S)+O
1x	DLE C(S)+P	DC1 C(S)+Q	DC2 C(S)+R	DC3 C(S)+S	DC4 C(S)+T	NAK C(S)+U	SYN C(S)+V	ETB C(S)+W	CAN C(S)+X	EM C(S)+Y	SUB C(S)+Z	ESC Esc	FS C+1	GS C+]	RS C+^	US C(S)+_
2x	<u>SP</u>	1	2	3	4	%	&	:	()	* _	±	•	=	•	/
3x	0	1	2	3	4	5	6	7	8	9	:	;	≤	=	≥	?
4x	@	A	B	C	D	E	F	G	H	I	J	K	L	M	N	O
5x	P	Q	R	S	T	U	V	W	X	Y	Z	[\]	^	_
6x	:	a	b	c	d	e	f	g	h	i	j	k	l	m	n	o
7x	p	q	r	s	t	u	v	w	x	y	z	{		}	~	Del
8x	€	Sh↓	Sh↑	Ins	Ent (keyp)	F1	F2	F3	F4	F5	F6	F7	F8	F9	F10	F11
9x	F12	Home	End	Pg Up	Pg Dwn	↑	↓	←	→	Ar↑	Ar↓	Al↑	Al↓	Cl↓	Cl↑	Cr↓
Ax	Cr↑	□	‘	f	”	…	†	‡	•	%	§	◀	§	◀	œ	□
Bx	°	±	•	’	‘	μ	¶	•	•	•	°	»	¼	¼	¼	¿
Cx	Á	À	Ä	Å	Ä	Å	Æ	Ç	È	É	Ê	Ë	Ì	Í	Î	Ï
Dx	Ð	Ñ	Ó	Ô	Õ	Ö	Ø	×	Ù	Ú	Û	Ü	Ý	Þ	ß	
Ex	à	á	â	ã	ä	å	æ	ç	è	é	ê	ë	ì	í	î	ï
Fx	ø	ñ	ò	ó	ô	õ	ö	÷	ø	ù	ú	û	ü	ý	þ	ÿ

Extended characters (sky blue) are sent through dedicated keys (when available in the selected country mode) or by using an Alt Mode sequence.

Interface Type PC AT PS/2 or USB-Keyboard – cont.

Table F-2. Scancode Set When Control Character is 02

	x0	x1	x2	x3	x4	x5	x6	x7	x8	x9	xA	xB	xC	xD	xE	xF
0x	Ar↓	Ar↑	All	Al↑	Cl↓	Cl↑	Cr↓	Cr↑	BS	Tab	→	S+ Tab	Enter Keypd	Enter	Ins	Pg Up
1x	Pg Dwn	Home	←	↓	↑	F6	F1	F2	F3	F4	F5	ESC	F7	F8	F9	F10
2x	Space	!	“	#	\$	%	&	'	()	*	+	,	-	.	/
3x	0	1	2	3	4	5	6	7	8	9	:	;	<	=	>	?
4x	@	A	B	C	D	E	F	G	H	I	J	K	L	M	N	O
5x	P	Q	R	S	T	U	V	W	X	Y	Z	[\]	^	_
6x	,	a	b	c	d	e	f	g	h	i	j	k	l	m	n	o
7x	p	q	r	s	t	u	v	w	x	y	z	{		}	~	Del
8x	€	□	'	f	"	...	†	‡	·	%	S	◀	S	◀	€	□
9x	□	'	'	“	"	•	-	—	~	™	§	▶	œ	□	ž	Y
Ax	NBSP	¡	¢	£	¤	¥	¦	§	¨	©	ª	«	¬	­	®	¯
Bx	°	±	²	³	´	µ	¶	·	¸	¹	º	»	¼	½	¾	¿
Cx	À	Á	Â	Ã	Ä	Å	Æ	Ç	È	É	Ê	Ë	Ì	Í	Î	Ï
Dx	Ð	Ñ	Ò	Ó	Ô	Õ	Ö	×	Ø	Ù	Ú	Û	Ü	Ý	Þ	ß
Ex	à	á	â	ã	ä	å	æ	ç	è	é	ê	ë	ì	í	î	ï
Fx	ð	ñ	ò	ó	ô	õ	ö	÷	ø	ù	ú	û	ü	ý	þ	ÿ

Interface type PC AT PS/2 Alt Mode or USB-Keyboard Alt Mode

Table F-3. Scancode Set When Control Character is 00 or 01

	x0	x1	x2	x3	x4	x5	X6	x7	x8	x9	xA	xB	xC	xD	xE	Xf
0x	Alt+000	Alt+001	Alt+002	Alt+003	Alt+004	Alt+005	Alt+006	Alt+007	BS	HT TAB	Alt+010	Alt+011	Alt+012	CR Enter	Alt+014	Alt+015
1x	Alt+016	Alt+017	Alt+018	Alt+019	Alt+020	Alt+021	Alt+022	Alt+023	Alt+024	Alt+025	Alt+026	ESC Esc	Alt+028	Alt+029	Alt+030	Alt+031
2x	A+032	A+033	A+034	A+035	A+036	A+037	A+038	A+039	A+040	A+041	A+042	A+043	A+044	A+045	A+046	A+047
3x	A+048	A+049	A+050	A+051	A+052	A+053	A+054	A+055	A+056	A+057	A+058	A+059	A+060	A+061	A+062	A+063
4x	A+064	A+065	A+066	A+067	A+068	A+069	A+070	A+071	A+072	A+073	A+074	A+075	A+076	A+077	A+078	A+079
5x	A+080	A+081	A+082	A+083	A+084	A+085	A+086	A+087	A+088	A+089	A+090	A+091	A+092	A+093	A+094	A+095
6x	A+096	A+097	A+098	A+099	A+100	A+101	A+102	A+103	A+104	A+105	A+106	A+107	A+108	A+109	A+110	A+111
7x	A+112	A+113	A+114	A+115	A+116	A+117	A+118	A+119	A+120	A+121	A+122	A+123	A+124	A+125	A+126	A+127
8x	€	Sh↓	Sh↑	Ins	Ent (keyp)	F1	F2	F3	F4	F5	F6	F7	F8	F9	F10	F11
9x	F12	Home	End	Pg Up	Pg Dwn	↑	↓	←	→	Ar↓	Ar↑	All	Alt↑	Cl↓	Cl↑	Cr↓
Ax	Cr↑	A+0161	A+0162	A+0163	A+0164	A+0165	A+0166	A+0167	A+0168	A+0169	A+0170	A+0171	A+0172	A+0173	A+0174	A+0175
Bx	A+0176	A+0177	A+0178	A+0179	A+0180	A+0181	A+0182	A+0183	A+0184	A+0185	A+0186	A+0187	A+0188	A+0189	A+0190	A+0191
Cx	A+0192	A+0193	A+0194	A+0195	A+0196	A+0197	A+0198	A+0199	A+0200	A+0201	A+0202	A+0203	A+0204	A+0205	A+0206	A+0207
Dx	A+0208	A+0209	A+0210	A+0211	A+0212	A+0213	A+0214	A+0215	A+0216	A+0217	A+0218	A+0219	A+0220	A+0221	A+0222	A+0223
Ex	A+0224	A+0225	A+0226	A+0227	A+0228	A+0229	A+0230	A+0231	A+0232	A+0233	A+0234	A+0235	A+0236	A+0237	A+0238	A+0239
Fx	A+0240	A+0241	A+0242	A+0243	A+0244	A+0245	A+0246	A+0247	A+0248	A+0249	A+0250	A+0251	A+0252	A+0253	A+0254	A+0255

Interface type PC AT PS/2 Alt Mode or USB-Keyboard Alt Mode – cont.

Table F-4. Scancode Set When Control Character is 02

	x0	x1	x2	x3	x4	x5	X6	x7	x8	x9	xA	xB	xC	xD	xE	xF
0x	Ar↓	Ar↑	All	Al↑	Cl↓	Cl↑	Cr↓	Cr↑	BS	Tab	→	S+ Tab	Enter Keyprd	Enter	Ins	Pg Up
1x	Pg Dwn	Home	←	↓	↑	F6	F1	F2	F3	F4	F5	ESC	F7	F8	F9	F10
2x	A+032	A+033	A+034	A+035	A+036	A+037	A+038	A+039	A+040	A+041	A+042	A+043	A+044	A+045	A+046	A+047
3x	A+048	A+049	A+050	A+051	A+052	A+053	A+054	A+055	A+056	A+057	A+058	A+059	A+060	A+061	A+062	A+063
4x	A+064	A+065	A+066	A+067	A+068	A+069	A+070	A+071	A+072	A+073	A+074	A+075	A+076	A+077	A+078	A+079
5x	A+080	A+081	A+082	A+083	A+084	A+085	A+086	A+087	A+088	A+089	A+090	A+091	A+092	A+093	A+094	A+095
6x	A+096	A+097	A+098	A+099	A+100	A+101	A+102	A+103	A+104	A+105	A+106	A+107	A+108	A+109	A+110	A+111
7x	A+112	A+113	A+114	A+115	A+116	A+117	A+118	A+119	A+120	A+121	A+122	A+123	A+124	A+125	A+126	A+127
8x	A+0128	A+0129	A+0130	A+0131	A+0132	A+0133	A+0134	A+0135	A+0136	A+0137	A+0138	A+0139	A+0140	A+0141	A+0142	A+0143
9x	A+0144	A+0145	A+0146	A+0147	A+0148	A+0149	A+0150	A+0151	A+0152	A+0153	A+0154	A+0155	A+0156	A+0157	A+0158	A+0159
Ax	A+0160	A+0161	A+0162	A+0163	A+0164	A+0165	A+0166	A+0167	A+0168	A+0169	A+0170	A+0171	A+0172	A+0173	A+0174	A+0175
Bx	A+0176	A+0177	A+0178	A+0179	A+0180	A+0181	A+0182	A+0183	A+0184	A+0185	A+0186	A+0187	A+0188	A+0189	A+0190	A+0191
Cx	A+0192	A+0193	A+0194	A+0195	A+0196	A+0197	A+0198	A+0199	A+0200	A+0201	A+0202	A+0203	A+0204	A+0205	A+0206	A+0207
Dx	A+0208	A+0209	A+0210	A+0211	A+0212	A+0213	A+0214	A+0215	A+0216	A+0217	A+0218	A+0219	A+0220	A+0221	A+0222	A+0223
Ex	A+0224	A+0225	A+0226	A+0227	A+0228	A+0229	A+0230	A+0231	A+0232	A+0233	A+0234	A+0235	A+0236	A+0237	A+0238	A+0239
Fx	A+0240	A+0241	A+0242	A+0243	A+0244	A+0245	A+0246	A+0247	A+0248	A+0249	A+0250	A+0251	A+0252	A+0253	A+0254	A+0255

Digital Interface

Table F-5. Scancode Set When Control Character is 00 or 01

	X0	x1	x2	x3	x4	x5	x6	x7	x8	x9	xA	xB	xC	xD	xE	xF
0x	NULL C+@	SOH C(S)+A	STX C(S)+B	ETX C(S)+C	EOT C+D	ENQ C(S)+E	ACK C(S)+F	BEL C(S)+G	BS	HT TAB	LF C(S)+J	VT C(S)+K	FF C(S)+L	CR Enter	SO C(S)+N	SI C(S)+O
1x	DLE C(S)+P	DC1 C(S)+Q	DC2 C(S)+R	DC3 C(S)+S	DC4 C(S)+T	NAK C(S)+U	SYN C(S)+V	ETB C(S)+W	CAN C(S)+X	EM C(S)+Y	SUB C(S)+Z	ESC Esc	FS C(S)+\	GS C+]	RS C(S)+^	US C(S)+_
2x	Space	!	"	#	\$	%	&	'	()	*	+	,	-	.	/
3x	0	1	2	3	4	5	6	7	8	9	:	;	<	=	>	?
4x	@	A	B	C	D	E	F	G	H	I	J	K	L	M	N	O
5x	P	Q	R	S	T	U	V	W	X	Y	Z	[\]	^	_
6x	,	a	b	c	d	e	f	g	h	i	j	k	l	m	n	o
7x	p	q	r	s	t	u	v	w	x	y	z	{		}	~	Del
8x		Sh↓	Sh↑	Ins	Ent (keyp)	F1	F2	F3	F4	F5	F6	F7	F8	F9	F10	F11
9x	F12	F13	F14	F15	F16	↑	↓	←	→					Cl↓	Cl↑	

Digital Interface — cont.

Table F-6. Scancode Set When Control Character is 02

	X0	x1	x2	x3	x4	x5	x6	x7	x8	x9	xA	xB	xC	xD	xE	xF
0x					C1↓	C1↑			BS	Tab	→	S+Tab	Enter Keypd	Enter	Ins	
1x			←	↓	↑	F6	F1	F2	F3	F4	F5	ESC	F7	F8	F9	F10
2x	Space	!	"	#	\$	%	&	'	()	*	+	,	-	.	/
3x	0	1	2	3	4	5	6	7	8	9	:	;	<	=	>	?
4x	@	A	B	C	D	E	F	G	H	I	J	K	L	M	N	O
5x	P	Q	R	S	T	U	V	W	X	Y	Z	[\]	^	_
6x	'	a	b	c	d	e	f	g	h	i	j	k	l	m	n	o
7x	p	q	r	s	t	u	v	w	x	y	z	{		}	~	Del

IBM31xx 102-key

Table F-7. Scancode Set When Control Character is 00 or 01

	X0	x1	x2	x3	x4	x5	x6	x7	x8	x9	xA	xB	xC	xD	xE	xF
0x	NULL C+@	SOH C(S)+A	STX C(S)+B	ETX C(S)+C	EOT C+D	ENQ C(S)+E	ACK C(S)+F	BEL C(S)+G	BS C(S)+H	HT TAB	LF C(S)+J	VT C(S)+K	FF C(S)+L	CR Enter	SO C(S)+N	SI C(S)+O
1x	DLE C(S)+P	DC1 C(S)+Q	DC2 C(S)+R	DC3 C(S)+S	DC4 C(S)+T	NAK C(S)+U	SYN C(S)+V	ETB C(S)+W	CAN C(S)+X	EM C(S)+Y	SUB C(S)+Z	ESC Esc	FS C(S)+\	GS C+]	RS C(S)+^	US C(S)+_
2x	Space	!	"	#	\$	%	&	'	()	*	+	,	-	.	/
3x	0	1	2	3	4	5	6	7	8	9	:	;	<	=	>	?
4x	@	A	B	C	D	E	F	G	H	I	J	K	L	M	N	O
5x	P	Q	R	S	T	U	V	W	X	Y	Z	[\] ^	^	_
6x	,	a	B	c	d	e	f	g	h	i	j	k	l	m	n	o
7x	p	q	R	s	t	u	v	w	x	y	z	{		}		Del
8x		Sh↓	Sh↑	Ins	Ent (keyp)	F1	F2	F3	F4	F5	F6	F7	F8	F9	F10	F11
9x	F12	Enter	Reset	Insert	Delete	Field -	Field +	Enter paddle	Printl	Ar↓	Ar↑	All↓	Al↑	Cl↓	Cl↑	Cr↓
Ax	Cr↑															

IBM31xx 102-key – cont.

Table F-8. Scancode Set When Control Character is 02

	X0	x1	x2	x3	x4	x5	x6	x7	x8	x9	xA	xB	xC	xD	xE	xF
0x	Ar↓	Ar↑	Al↓	Al↑	Cl↓	Cl↑	Cr↓	Cr↑	BS	Tab	→	S+ Tab	Enter Keypd	Enter	Ins	Pg Up
1x	Pg Dwn	Home	←	↓	↑	F6	F1	F2	F3	F4	F5	ESC	F7	F8	F9	F10
2x	Space	!	"	#	\$	%	&	'	()	*	+	,	-	.	/
3x	0	1	2	3	4	5	6	7	8	9	:	;	<	=	>	?
4x	@	A	B	C	D	E	F	G	H	I	J	K	L	M	N	O
5x	P	Q	R	S	T	U	V	W	X	Y	Z	[\]	^	_
6x	,	a	B	c	d	e	f	g	h	i	j	k	l	m	n	o
7x	p	q	R	s	t	u	v	w	x	y	z	{		}		Del

IBM XT

Table F-9. Scancode Set When Control Character is 00 or 01

	X0	x1	x2	x3	x4	x5	x6	x7	x8	x9	xA	xB	xC	xD	xE	xF
0x	NULL C+@	SOH C(S)+A	STX C(S)+B	ETX C(S)+C	EOT C+D	ENQ C(S)+E	ACK C(S)+F	BEL C(S)+G	BS C(S)+H	HT TAB	LF C(S)+J	VT C(S)+K	FF C(S)+L	CR Enter	SO C(S)+N	SI C(S)+O
1x	DLE C(S)+P	DC1 C(S)+Q	DC2 C(S)+R	DC3 C(S)+S	DC4 C(S)+T	NAK C(S)+U	SYN C(S)+V	ETB C(S)+W	CAN C(S)+X	EM C(S)+Y	SUB C(S)+Z	ESC Esc	FS C(S)+\	GS C+]	RS C(S)+^	US C(S)+_
2x	Space	!	"	#	\$	%	&	'	()	*	+	,	-	.	/
3x	0	1	2	3	4	5	6	7	8	9	:	;	<	=	>	?
4x	@	A	B	C	D	E	F	G	H	I	J	K	L	M	N	O
5x	P	Q	R	S	T	U	V	W	X	Y	Z	[\]	^	_
6x	,	a	B	c	d	e	f	g	h	i	j	k	l	m	n	o
7x	p	q	R	s	t	u	v	w	x	y	z	{		}		Del
8x		Sh↓	Sh↑	Ins	Ent (keyp)	F1	F2	F3	F4	F5	F6	F7	F8	F9	F10	F11
9x	F12	Home	End	Pg Up	Pg Dwn	↑	↓	←	→	Ar↓	Ar↑	All↓	Alt↑	Cl↓	Cl↑	Cr↓
Ax	Cr↑															

IBM XT — cont.

Table F-10. Scancode Set When Control Character is 02

	X0	x1	x2	x3	x4	x5	x6	x7	x8	x9	xA	xB	xC	xD	xE	xF
0x	Ar↓	Ar↑	Al↓	Al↑	Cl↓	Cl↑	Cr↓	Cr↑	BS	Tab	→	S+ Tab	Enter Keypd	Enter	Ins	Pg Up
1x	Pg Dwn	Home	←	↓	↑	F6	F1	F2	F3	F4	F5	ESC	F7	F8	F9	F10
2x	Space	!	“	#	\$	%	&	‘	()	*	+	,	-	.	/
3x	0	1	2	3	4	5	6	7	8	9	:	;	<	=	>	?
4x	@	A	B	C	D	E	F	G	H	I	J	K	L	M	N	O
5x	P	Q	R	S	T	U	V	W	X	Y	Z	[\]	^	_
6x	,	a	B	c	d	e	f	g	h	i	j	k	l	m	n	o
7x	p	q	R	s	t	u	v	w	x	y	z	{		}		Del

Microsoft Windows Codepage 1252

Windows-1252 is a character encoding of the Latin alphabet, used by default in the legacy components of Microsoft Windows in English and some other Western languages.

	00	01	02	03	04	05	06	07	08	09	0A	0B	0C	0D	0E	0F
00	<u>NUL</u> 0000	<u>STX</u> 0001	<u>SOT</u> 0002	<u>ETX</u> 0003	<u>EOT</u> 0004	<u>ENQ</u> 0005	<u>ACK</u> 0006	<u>BEL</u> 0007	<u>BS</u> 0008	<u>HT</u> 0009	<u>LF</u> 000A	<u>VT</u> 000B	<u>FF</u> 000C	<u>CR</u> 000D	<u>SO</u> 000E	<u>SI</u> 000F
10	<u>DLE</u> 0010	<u>DC1</u> 0011	<u>DC2</u> 0012	<u>DC3</u> 0013	<u>DC4</u> 0014	<u>NAK</u> 0015	<u>SYN</u> 0016	<u>ETB</u> 0017	<u>CAN</u> 0018	<u>EM</u> 0019	<u>SUB</u> 001A	<u>ESC</u> 001B	<u>FS</u> 001C	<u>GS</u> 001D	<u>RS</u> 001E	<u>US</u> 001F
20	<u>SP</u> 0020	!	"	#	\$	%	&	'	()	*	+	,	-	.	/
30	0	1	2	3	4	5	6	7	8	9	:	;	<	=	>	?
40	@	A	B	C	D	E	F	G	H	I	J	K	L	M	N	O
50	P	Q	R	S	T	U	V	W	X	Y	Z	[\]	^	_
60	`	a	b	c	d	e	f	g	h	i	j	k	l	m	n	o
70	p	q	r	s	t	u	v	w	x	y	z	{		}	~	<u>DEL</u> 007F
80	€ 20AC	⋮ 2018	/ 201A	f 0192	„ 201E	… 2026	† 2020	‡ 2021	˘ 02C6	‰ 2030	Š 0160	< 2039	€ 0152	⋮ 017D	Ž 017E	⋮ 0178
90	⋮ 2018	\ 2018	/ 2019	“ 201C	” 201D	• 2022	— 2013	— 2014	˘ 02DC	™ 2122	š 0161	> 203A	œ 0153	⋮ 017E	ž 017E	ÿ 0178
A0	<u>NBSP</u> 00A0	¡ 00A1	¢ 00A2	£ 00A3	¤ 00A4	¥ 00A5	¦ 00A6	§ 00A7	¨ 00A8	© 00A9	ª 00AA	« 00AB	¬ 00AC	­ 00AD	® 00AE	¯ 00AF
B0	° 00B0	± 00B1	² 00B2	³ 00B3	´ 00B4	µ 00B5	¶ 00B6	· 00B7	¸ 00B8	¹ 00B9	º 00BA	» 00BB	¼ 00BC	½ 00BD	¾ 00BE	¿ 00BF
C0	À 00C0	Á 00C1	Â 00C2	Ã 00C3	Ä 00C4	Å 00C5	Æ 00C6	Ç 00C7	È 00C8	É 00C9	Ê 00CA	Ë 00CB	Ì 00CC	Í 00CD	Î 00CE	Ï 00CF
D0	Ð 00D0	Ñ 00D1	Ò 00D2	Ó 00D3	Ô 00D4	Õ 00D5	Ö 00D6	× 00D7	Ø 00D8	Ù 00D9	Ú 00DA	Û 00DB	Ü 00DC	Ý 00DD	Þ 00DE	ß 00DF
E0	à 00E0	á 00E1	â 00E2	ã 00E3	ä 00E4	å 00E5	æ 00E6	ç 00E7	è 00E8	é 00E9	ê 00EA	ë 00EB	ì 00EC	í 00ED	î 00EE	ï 00EF
F0	ð 00F0	ñ 00F1	ò 00F2	ó 00F3	ô 00F4	õ 00F5	ö 00F6	÷ 00F7	ø 00F8	ù 00F9	ú 00FA	û 00FB	ü 00FC	ý 00FD	þ 00FE	ÿ 00FF

A

Ambient Light Immunity 368

B

bar codes

RS-232

baud rate 85

RS-232 parameters

parity 331, 333, 336, 338

barcodes

cancel 395

numeric barcodes 395

RS-232 parameters

parity 76

Beeper

Pitch, Good Read 27, 28

Volume, Good Read 30

Beeper Volume 368

Beeper, Good Read 25

C

Cable Pinouts 370

Clear to Send 52

Code 39 Format 95

Conversion, case 123

Conversion, character 124

Convert to Code 128 100

Convert to Code 39 100

CTS 52

D

Decode Capability 368

Defaults 371

Depth of Field 368

Dimensions 367

Drop Specifications 368

E

Leading/trailing noise 101

Electrical Safety 369

EMI/RFI 369

Error Codes 389

Errors 389

G

Good Read, Beeper 25

Pitch 27, 28

Volume 30

Good Read, Beeper – 25

Good Read, Beeper Pitch – 27, 28

Good Read, Beeper Volume – 30

Green Spot 385

H

Handheld Scanner 88, 89, 96

Host Resets 92

Humidity 368

I

IBM interface selection 14

IBM Standard Format 95

Idle State (wand) 97

Indications 385

Interface Type 10

Interfaces Supported 368

K

keyboard support 74

KEYBOARD WEDGE (KBW) interface selection 15

L

Light Source 367

M

Mixed OEM Standard + Code 39 Format 95

N

numbers lock key 77

O

Operating Temperature 368

P

Performance Characteristics 367
Physical Characteristics 367
Pitch – Good Read, Beeper 27, 28
Pitch Tolerance 368
Polarity (wand) 98
Prefix/Suffix 104
Print Contrast Minimum 368
Product Specifications 367
Programming Barcodes 9

R

Read, Beeper – Good 25
Read, Beeper Pitch – Good 27, 28
Read, Beeper Volume – Good 30
Request to Send 52
Roll (Tilt) Tolerance 368
RS-232 interface selection 14
RTS 52

S

sample bar codes
 code 128 391
 code 39 391
 interleaved 2 of 5 392
select digits/characters 395

Serial Output 370
Signal Speed (wand) 99
Skew (Yaw) Tolerance 368
Standard Cable Pinouts 370
Storage Temperature 368
Suffix 104
Symbology Conversion 100
symbology types 391

T

Table Top Scanner 88, 89, 96
trailing noise 101

U

UPC 130
USB interface selection 14
User Environment 368, 369

V

Volume – Good Read, Beeper 30

W

Weight 367

X

XON/XOFF 52

ASCII Chart

ASCII Char.	Hex No.	ASCII Char.	Hex No.	ASCII Char.	Hex No.	ASCII Char.	Hex No.
NUL	00	SP	20	@	40	'	60
SOH	01	!	21	A	41	a	61
STX	02	"	22	B	42	b	62
ETX	03	#	23	C	43	c	63
EOT	04	\$	24	D	44	d	64
ENQ	05	%	25	E	45	e	65
ACK	06	&	26	F	46	f	66
BEL	07	'	27	G	47	g	67
BS	08	(28	H	48	h	68
HT	09)	29	I	49	i	69
LF	0A	*	2A	J	4A	j	6A
VT	0B	+	2B	K	4B	k	6B
FF	0C	,	2C	L	4C	l	6C
CR	0D	-	2D	M	4D	m	6D
SO	0E	.	2E	N	4E	n	6E
SI	0F	/	2F	O	4F	o	6F
DLE	10	0	30	P	50	p	70
DC1	11	1	31	Q	51	q	71
DC2	12	2	32	R	52	r	72
DC3	13	3	33	S	53	s	73
DC4	14	4	34	T	54	t	74
NAK	15	5	35	U	55	u	75
SYN	16	6	36	V	56	v	76
ETB	17	7	37	W	57	w	77
CAN	18	8	38	X	58	x	78
EM	19	9	39	Y	59	y	79
SUB	1A	:	3A	Z	5A	z	7A
ESC	1B	;	3B	[5B	{	7B
FS	1C	<	3C	\	5C		7C
GS	1D	=	3D]	5D	}	7D
RS	1E	>	3E	^	5E	~	7E
US	1F	?	3F	_	5F	DEL	7F

Australia

Datalogic Scanning Pty Ltd
Telephone: [61] (2) 9870 3200
australia.scanning@datalogic.com

France and Benelux

Datalogic Scanning SAS
Telephone: [33].01.64.86.71.00
france.scanning@datalogic.com

Germany

Datalogic Scanning GmbH
Telephone: 49 (0) 61 51/93 58-0
germany.scanning@datalogic.com

India

Datalogic Scanning India
Telephone: 91- 22 - 64504739
india.scanning@datalogic.com

Italy

Datalogic Scanning SpA
Telephone: [39] (0) 39/62903.1
italy.scanning@datalogic.com

Japan

Datalogic Scanning KK
Telephone: 81 (0)3 3491 6761
japan.scanning@datalogic.com

Latin America

Datalogic Scanning, Inc
Telephone: (305) 591-3222
latinamerica.scanning@datalogic.com

Singapore

Datalogic Scanning Singapore PTE LTD
Telephone: (65) 6435-1311
singapore.scanning@datalogic.com

Iberia

Datalogic Scanning SAS Sucursal en España
Telephone: 34 91 746 28 60
spain.scanning@datalogic.com

United Kingdom

Datalogic Scanning LTD
Telephone: 44 (0) 1582 464900
uk.scanning@datalogic.com



www.scanning.datalogic.com

Datalogic Scanning, Inc.

959 Terry Street
Eugene, OR 97402
USA
Telephone: (541) 683-5700
Fax: (541) 345-7140

