

COBY®



IR825

EN

**Wireless Internet Radio
Instruction ManualPage 2**

Please read carefully before use

Table of Contents

THANK YOU	5
Features	5
Warnings	6
PACKAGE CONTENTS	7
GETTING STARTED	8
Requirements.....	8
Using the Menu Controls	9
Connect to Your Wireless Network.....	9
Step 1: Connecting Power	9
Step 2: Connecting to the Internet.....	10
Step 3: Select Your Region.....	10
Step 4: Select Your Network (SSID).....	10
Step 5: Enter Your WEP/WPA Password	11
Troubleshooting your network connection.....	12
CONTROLS AT A GLANCE	13
Front View.....	13
Rear View.....	13
Top View	14
INTERNET RADIO MODE	16
Stations (Choosing a Station)	17
Podcasts (Choosing a Podcast).....	18
My Favourites	18
Browsing the My Favorites list	18
Adding Stations or Podcasts to the My Favorites List	19
My Added Stations	19
Viewing Station/Podcast Information	19
Station Updates.....	20

Table of Contents

Preset Station Memory	21
Storing a Preset Station	21
Selecting a Preset station	21
FM RADIO MODE	22
General Operation.....	22
Access the FM Radio Menu.....	23
Scan Setting	23
Audio Setting.....	23
Preset Station Memory	24
Storing a Preset Station	24
Selecting a Preset station	24
MUSIC PLAYER MODE	25
Music Player Menu	25
Play shared media.....	26
Play shared folders	26
SETTING THE CLOCK	27
Manual Time/Date Setting.....	27
Automatic Time/Date Setting.....	28
Other Clock Options	29
Using the Alarms/Timers	30
Setting the Alarms.....	30
Alarm Snooze/Off.....	31
Sleep Timer.....	31
SYSTEM SETTINGS.....	33
Network setup	33
Language	34
Factory reset.....	34
Software Updates.....	35
SW Version and Radio ID.....	35

Table of Contents

APPENDIX	36
Set Up Media Sharing with Windows Media Player 11	36
Set Up Media Sharing with Mac OS X.....	39
Set up Windows File Sharing on a MAC	39
Accounts Setup	39
Directory Setup	40
Play Streaming Music on the Internet Radio	41
Frontier Silicon Internet Radio Portal.....	42
TROUBLESHOOTING	44
SPECIFICATIONS.....	47
SAFETY NOTICES	48

Thank You

Thank you for purchasing the Coby IR825 Wireless Internet Radio. Please read these instructions before installing and operating this system.

Features

- ✦ Free wireless access to thousands of stations from around the world¹
- ✦ Instant wireless access to your computer's music library²
- ✦ Integrated FM radio
- ✦ Optional station presets for Internet and FM radio (10 total)
- ✦ Full-range stereo speakers
- ✦ Alarm clock with sleep and snooze functions
- ✦ 3.5mm headphone jack for private listening

¹ Requires a 64 Kbps internet connection or greater and an 802.11g wireless access point

² Requires a computer running Windows Media Player 11.

Thank You

Warnings

- ✦ If this Internet Radio has been moved from a cold place to a warm place (e.g., from a cold car to a warm room), do not plug it in for 2-3 hours. Moisture may have condensed inside the radio, which can cause internal damage to the system. To avoid damage, please unpack your Internet Radio and allow it to stand at room temperature for 2-3 hours before use.
- ✦ Always ensure that the main plug is easily accessible.
- ✦ Do not open the radio or remove any fixed covers. Doing so may cause risk of electric shock.
- ✦ Unplug the radio during electrical storms.
- ✦ Never use your Internet Radio if it is damaged in any way. Always place the unit on a flat, level surface where it will not be subject to vibration.
- ✦ Do not expose the system to extreme temperatures, either hot or cold. Place your Internet Radio well away from heat sources including radiators, fireplaces or heat-producing devices (including amplifiers).
- ✦ Do not use the system in tropical climates.
- ✦ Do not allow your Internet Radio to be exposed to rain, moisture or dust. If any liquid is spilled into the radio, disconnect it from the power supply immediately and contact a qualified repair person.





Do not open the system or attempt to perform repairs yourself. Refer all repairs to qualified service personnel only.

Package Contents

Please make sure that the items shown below are included in the package. Should an item be missing, please contact the local retailer from which you purchased this product.

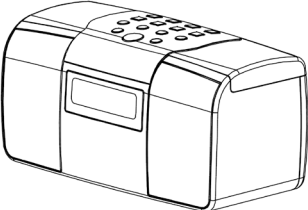
English

Main unit	 A line drawing of a rectangular electronic device, likely a portable music player or recorder. It features a control panel on top with numerous buttons and a small display screen on the front face.
Power Adapter	 A line drawing of a power adapter. It consists of a rectangular wall plug with two rectangular slots and a short cable with a small, L-shaped connector.
Instruction manual	 A line drawing of a folded instruction manual. The cover of the manual features a small image of the main unit.

Getting Started

Requirements

Before you use your Internet Radio, you will need the following:

- ✦ A broadband Internet connection.
- ✦ A wireless access point (Wi-Fi) connected to your broadband Internet, preferably via a router.
 - ✧ If your wireless network is secured with Wired Equivalent Privacy (WEP) or Wi-Fi Protected Access (WPA) encryption, you will need to enter the security key on the Internet Radio to connect it to the network. WPA encryption is recommended for better network security.
 - ✧ If your wireless network is configured for trusted stations, you will need to enter the Radio's MAC address into your wireless access point. To find the Radio's MAC address, enter the menu as follows: Main menu > System settings > Network > View settings > MAC Address.



For instructions on entering the MAC address into your wireless access point, please refer to the manual supplied with your wireless internet router.

Before you continue, make sure that your wireless access point is powered up and connected to broadband internet. For information on configuring this connection, please refer to the manual supplied with your wireless internet router.



For uninterrupted Internet radio, a broadband connection speed of at least 64kbps is recommended, although slower connection speeds may still work.

If you need further assistance to set up your wireless internet connection, please contact your internet provider or wireless access point manufacturer.

Using the Menu Controls

- ✦ To browse the menu options, press ◀ or ▶.
- ✦ To select a menu option, press **SELECT**.
- ✦ To return to a previous menu, press **BACK**.

Connect to Your Wireless Network



If you make a mistake at any point and wish to navigate backward, press the **BACK** key. This will return you to the previous screen.

Step 1: Connecting Power

Plug one end of the power adapter into the Power jack located on the bottom of the unit, then plug the other end into an AC 100-240V wall outlet. Press the  button to turn the radio on.



Getting Started

Step 2: Connecting to the Internet

When the unit turns on, the Main menu will be displayed. Press  or  to choose <Internet Radio> then press **SELECT** to confirm.

> Internet Radio
Music Player



Step 3: Select Your Region

Press  or  to choose your region from the menu and then press **SELECT** to confirm. The network wizard will launch.

Please Select
Wlan region

> Most of Europe
USA

Step 4: Select Your Network (SSID)

- ✦ The unit will scan the area and display all available networks. Press  or  to choose the name of your network from the menu list and then press **SELECT** to confirm.



The name of your network (SSID) is determined by the SSID setting of your wireless access point.

If the name of your network does not appear in the list, select <Rescan> to have the unit try to find your network again.

If you have configured your wireless access point to hide the SSID name, you will need to enter your network settings manually. Choose <Manual config> from the menu and press [SELECT] to confirm.

Getting Started

- ✦ If your network does not have WEP or WPA security enabled, the unit will finish connecting to the network and return to the Internet Radio menu.

Step 5: Enter Your WEP/WPA Password

If security is enabled, you will be asked to input the WEP or WPA password. A password entry screen will display as follows:

Key: **xxxxxx**
0123456789 < ↵

- ✦ Press **◀** or **▶** to cycle through the alphanumeric character list. Press **SELECT** to input a character.
- ✦ If you make a mistake while entering your password, select the '**<**' icon to delete the previous character.
- ✦ Select the '**↵**' icon when you have finished entering your password,.

The unit will finish connecting to the network and return to the Internet Radio menu.



The radio will automatically save your WEP or WPA security key. You will not need to re-enter a WEP/WPA key unless the radio's <FACTORY RESET> function is selected.

Troubleshooting your network connection

If after trying to connect to your wireless network, the display reads "Failed to connect," please take the following steps:

- ✦ Ensure that your wireless access point and internet modem are connected and working normally.
 - ✧ Try resetting your wireless access point and internet modem (i.e., turn them off and then back on again).
- ✦ Move the radio to a location where the wireless signal is stronger (e.g., closer to your wireless access point).
- ✦ Make sure that your password has been entered correctly.



WEP/WPA passwords are case-sensitive.

To retrieve your access code or to get solutions to frequently asked questions, move the display highlight to the <HELP> menu and press [SELECT] to confirm.

Controls at a Glance

Front View

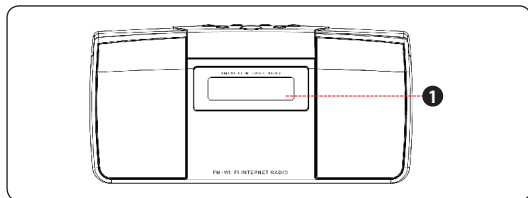

1. Display Screen

Rear View

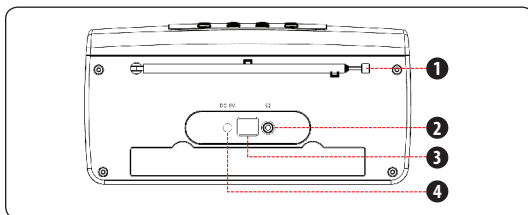

1. Telescopic FM antenna
2. 3.5mm headphone jack
3. Service port (for use by authorized service personnel only)
4. Power input (for use with supplied power adapter)

Controls at a Glance

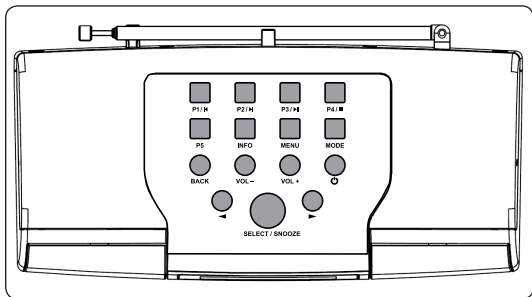

Top View

English



Control	Internet Radio	FM Radio	Music Player
P1/◀			Previous track
P2/⏸	Press and hold to save Preset station 1-5;		Play/Pause
P3/▶		Next track	
P4/■	Press to tune to Preset station 1-5.		Stop
P5		No function.	
INFO	Press to change information display (e.g., station information, software version, etc.)		
MENU	Press to access the menu.		

Controls at a Glance

Control	Internet Radio	FM Radio	Music Player
MODE	Press to toggle between Internet Radio, FM Radio, and Media Player modes.		
BACK	Press to return to a previous menu. When entering a WEP or WPA network password, press to scroll quickly through the alphanumeric character list.		
VOL -	Press to decrease volume.		
VOL +	Press to increase volume.		
	Turn the radio on or off.		
	Scroll up when browsing a menu list.		
	Scroll down when browsing a menu list.		
SELECT [SNOOZE]	Select a menu item. FM mode: auto tune to the next available station. Snooze: When alarm is sounding, press to delay the alarm.		

Internet Radio Mode

Press **MODE** repeatedly until "Internet Radio" is displayed on the screen.

A rectangular box representing a screen display with the text "Internet Radio Mode" centered inside.

Internet Radio
Mode

If you were previously listening to a station, the unit will automatically try to reconnect to that station. Press  to return to the Internet Radio menu.

The Internet Radio menu contains the following items:

- ✦ My Favourites: Select to listen to your favorite stations or podcast programming that you have saved.
- ✦ Stations: Select to listen to internet radio streams.
- ✦ Podcasts: Select to listen to podcast programming.
- ✦ My Added Stations: Listen to stations added from the Frontier Silicon website.
- ✦ Help: Select to access a short FAQ about internet radio stations, or get your access code to register at the Frontier Silicon website.

For more information about each of these items, please refer to each of their respective sections below.

Internet Radio Mode

Stations (Choosing a Station)

Listen to internet radio streams from all over the world.

From the Internet radio menu, select <Stations> and then press **SELECT** to confirm

English

There are five options available for station selection:

- Location: Find and listen to a station by geographic location (e.g., Asia, Europe, North America, etc.)
- Genre: Find and listen to a station by content category (e.g., Alternative, Blues, Business News, Classical, etc.)
- Search Stations: Find and listen to a station by name.
- Popular Stations: Browse and listen to the most popular stations.
- New Stations: Browse and listen to the newest stations.



Some radio stations do not broadcast 24 hours per day, and some stations are not always available on-line.

Stations with on-demand content may provide the option of listening to programs that have already been broadcast.

Internet Radio Mode

Podcasts (Choosing a Podcast)

Listen to podcast programming from all over the world.

From the Station List menu, select <Podcasts> and press **SELECT** to confirm.

There are three options available for podcast selection:

- Location: Find and listen to podcasts by geographic location (e.g., Asia, Europe, North America, etc.)
- Genre: Find and listen to podcasts by content category (e.g., Alternative, Blues, Business News, Classical, etc.)
- Search podcasts: Find and listen to a podcast by name.

My Favourites

Listen to your favorite station or podcast programming. To use this function, you must first add stations or podcasts to the My Favorites list.

Browsing the My Favorites list

From the Internet Radio menu, select <My Favorites> and press **SELECT** to confirm.

1. Choose <Podcasts> or <Stations> and then press **SELECT** to confirm.
2. Find your favorite Podcast or Station in the list and press **SELECT** to listen to it.

Internet Radio Mode

Adding Stations or Podcasts to the My Favorites List

When you are listening to a station or podcast that you like, press and hold **SELECT** to add it to the My Favorites list.



You can also add stations to the My Favorites list from the Frontier Silicon website if you have a registered account and device (www.wifiradio-frontier.com). Please refer to the Appendix for more information.

English

My Added Stations

Listen to stations added from the Frontier Silicon website (www.wifiradio-frontier.com). A registered account and device is required. Please refer to the Appendix or visit the website and follow the instructions there to register.

After you have added stations on the Frontier Silicon website, go to the Station list menu:

1. Select <My Added Stations> and press **SELECT** to confirm.
2. Find an added station in the list and press **SELECT** to listen to it.

Viewing Station/Podcast Information

While listening to a station or a podcast, press **INFO** to change the information displayed on the screen.

Internet Radio Mode

- **Description of Station**
Scrolling text information supplied by the Internet station. It may include information on music titles or program details. This information is provided by the broadcaster.
- **Location of Station**
Description provided by either internet radio station or broadcaster.
- **Reliability of Station**
Displays the degree of reliability of selected station.
- **Signal Information of Station**
Displays station's digital bit rate and signal mode.
- **Playback Buffer of Station**
Displays playback buffer strength of current station.
- **Date of Station**
Displays the date; this information is provided by the broadcaster to ensure accuracy.

Station Updates

Occasionally, the radio display will indicate that the system is receiving an updated station list. This function is performed automatically and periodically, ensuring that your Radio always has the latest station directory on-board.

Internet Radio Mode

Preset Station Memory

Storing a Preset Station

Your radio can store 5 Internet and 5 FM stations. To store the current station as a preset:

1. Press and hold one of the five preset station buttons [**P1/◀** to **P5**]. The current station will be saved as a preset and the screen will display:

00.00 MHz
Preset 1 Saved

or

Station name
Preset 1 Saved

The station has now been saved as a preset station.

Selecting a Preset station

Simply press one of the five preset station buttons [**P1/◀** to **P5**] to tune directly to the saved station.

FM Radio Mode

General Operation

Switch the radio on and press **MODE** until <FM> is displayed.



The first time that FM Radio mode is selected, the radio will tune to the beginning of the FM frequency range (87.50 MHz). Otherwise, the last FM station you were listening to will be selected.

- Press ◀ or ▶ to increase or decrease the frequency by 0.1 MHz per step.
- To 'SEEK' active stations automatically, press and hold ◀ or ▶.



*You can also press **SELECT** to auto tune to active stations. The unit will display the changing frequency until it stops on the next station.*

When the end of the frequency range is reached, the radio will resume the search at the beginning.

FM Radio Mode

Access the FM Radio Menu

Press **MENU** at any time to access the FM Radio menu. There are three items in the FM Radio menu:

- ✦ Scan Setting: Select to change the auto scan options.
- ✦ Audio Setting: Select to change the audio options.
- ✦ Main Menu: Select to return to the Main menu.

Scan Setting

Set the sensitivity of the auto scan tuning feature.

- Select <Strong station only> to auto scan to radio stations with a strong signal, only.
- Select <All stations> to auto scan to all available radio stations.



This auto scan feature will overwrite all previously stored preset stations.

Audio Setting

Set the radio reception mode to Stereo or Mono.

- Select <Stereo or mono> to set the radio reception to Stereo. The radio will degrade the reception mode to mono if necessary.
- Select <Mono only> to set the radio reception mode to Mono. Selecting Mono may improve the reception stability of weak radio station broadcasts.

FM Radio Mode

Preset Station Memory

Storing a Preset Station

Your radio can store 5 Internet and 5 FM stations. To store the current station as a preset:

1. Press and hold one of the five preset station buttons [**P1/◀** to **P5**]. The current station will be saved as a preset and the screen will display:

00.00 MHz
Preset 1 Saved

or

Station name
Preset 1 Saved

The station has now been saved as a preset station.

Selecting a Preset station

Simply press one of the five preset station buttons [**P1/◀** to **P5**] to tune directly to the saved station.

Music Player Mode

Music Player mode allows you to enjoy music from your computer wirelessly over a network.



To use the Music Player streaming media functions, you will need to set up media sharing on a computer. Please set up media sharing first (refer to the Appendix for guidance), then follow the instructions below to use the Music Player shared media functions.

English

Music Player Menu

To enter Music Player mode, press **MODE** repeatedly until <Music Player Mode> is displayed on the screen. The Music Player menu will appear.

Music Player
Mode

+ **Play Shared Media**

Select <Shared media> to browse and play shared media located on your computer.

+ **Play Shared Folders**



Select <Shared folders> to browse and play shared folders located on your computer.





You may need to allow the radio to log in to your computer in order to access its shared media and folders. To enter your PC username and password, go to: Main Menu > System Setup > Internet Setup > PC Settings.

Music Player Mode

Play shared media

1. From the Music Player menu, select <Shared media>.
2. Press  or  to highlight the desired selection.
Press **SELECT** to confirm and play your music.

Play shared folders

1. From the Music Player menu, select <Shared folders>.
2. Press  or  to highlight the desired selection.
Press **SELECT** to confirm and play the folder.

Setting the Clock

Manual Time/Date Setting

1. Press **MENU** to access the Main menu, then select <System setup>.

Alarms
> System setup

2. Select <Time/Setup>.

Internet setup
> Time setup

3. Select <Set Clock>.

> Set clock
Set date

4. Press ◀ or ▶ to adjust each time or date setting, then press **SELECT** to save the setting and move on to the next one. Repeat for each time setting (Hours, Minutes).

Set time
00 : 00



To set the date, select <Set date> instead of <Set clock> in step 3.

Setting the Clock

Automatic Time/Date Setting

English

To have the unit automatically update the time from an internet server:

1. Press **MENU** to access the Main menu, then select <System Setup>.



*To access the Main menu in FM radio mode, press **MENU**, then select <Main menu> from the menu list.*

2. Select <Time/Setup>.

Internet setup
> Time setup

3. Select <Auto Update>.

> Auto update
Set Time Zone

4. Select <Update from NET>.

> Update from NET *
No update

Setting the Clock

Other Clock Options

1. Press **MENU** to access the Main menu, then select <System Setup>.

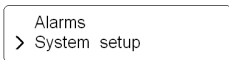

2. Select <Time/Setup>.

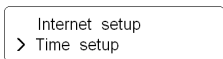

- ✧ Select <Set format> to set the clock to 12-hour or 24-hour display format.
- ✧ Select <Set timezone> to set the clock to your local time zone (if necessary, you refer to the website www.greenwichmeantime.com).
- ✧ Select <Daylight savings> to set the daylight savings time adjustment on or off.

Setting the Clock

Using the Alarms/Timers

Setting the Alarms

Before setting the alarm, be sure that your clock settings are correct. To set an alarm:

1. Press **MENU** to access the Main menu, then select <Alarms>. The current alarm status will be displayed.

> Alarm: Off



*To access the Main menu in FM radio mode, press **MENU**, then select <Main menu> from the menu list.*

2. Press **SELECT** to change the alarm settings. There are 5 options to adjust:
 - ✧ Select <Time> to set when the alarm will sound.
 - ✧ Select <On> or <Off> to toggle the alarm on or off.
 - ✧ Select <Mode> to set the alarm mode to wake to (Buzzer, Internet radio, or FM).
 - ✧ Select <Last listened> or one of the Preset stations <1 to 5> to set a preset station to wake to.
 - ✧ Select <Volume> to set how loud the alarm will sound.
3. Select <Save> after you have finished adjusting all of the alarm options.

Setting the Clock



An alarm icon will be displayed on the Standby screen (power off) if the alarm is enabled.

Alarm Snooze/Off

When the alarm sounds:

- ✦ Press **SELECT** / [SNOOZE] to delay the alarm. The alarm will sound again after 5 to 30 minutes (this delay can be adjusted). You can press **SELECT** / [SNOOZE] again to see how much time is remaining on the snooze timer.
- ✦ Press any button to turn off the alarm.
- ✦ To disable the alarm completely, you will need to set the Alarm option to <Off> in the Alarms menu. Please refer to the previous section "Setting the Alarms" for more information.

Sleep Timer

Set a sleep timer to turn the unit off automatically after 0 to 60 minutes.



To set the sleep timer:

1. Press **MENU** to access the Main menu, then select <SLEEP>.



To access the Main menu in FM radio mode, press **MENU**, then select <Main menu> from the menu list.

Setting the Clock

2. Press  or  to change the "Set sleep time" option, then press **SELECT** to confirm:

Set sleep time
Sleep time off

- ✧ Sleep time off: Disable the sleep timer.
 - ✧ 15 minutes
 - ✧ 30 minutes
 - ✧ 45 minutes
 - ✧ 60 minutes
3. The radio will automatically turn itself off after the set sleep period has elapsed.



To resume listening once automatic shut-down has occurred, press .

Network setup

You can change the network settings if you need to connect to another wireless network (e.g., if you relocate the unit to another room or building). The radio will scan for connection to another wireless network, or you may configure the network parameters manually.

1. For Network Setup, enter the menu as follows: MAIN MENU > SYSTEM SETUP > Internet Setup. Press **SELECT** to confirm.
2. Press ◀ or ▶ to highlight your desired selection. Press **SELECT** to confirm.
 - ✧ Wizard: Launch the wireless setup wizard. Refer to the "Getting Started" section for details.
 - ✧ PC settings: Enter PC login credentials (for use with Music Player streaming mode). If your PC has security enabled, you will need to enter your username and password
 - ✧ View settings: View current network settings (Active adapter, MAC address, DHCP, PC settings, SSID, IP settings, Wlan region).
 - ✧ Wlan region: Set your network location.
 - ✧ Manual settings: Configure your wireless network settings manually instead of using the Wizard option.

System Settings

Language

1. For language settings, enter the menu as follows: MAIN MENU > SYSTEM SETUP > Language. Press **SELECT** to confirm.
2. Press ◀ or ▶ to highlight your desired selection. Press **SELECT** to confirm.

Factory reset

Restore all options to their factory-default settings.

1. To perform factory reset, enter the menu as follows: MAIN MENU > SYSTEM SETUP > Factory Reset. Press **SELECT** to confirm.
2. Press **INFO** to confirm.
 - ✧ If you do not wish to continue, press any other key.



Performing a factory reset will completely reset your radio's memory, clearing all WEP/WPA codes and user settings.

Software Updates

Connect to the update server to check for new software versions.

1. Enter the menu as follows: MAIN MENU > SYSTEM SETUP > Software update. Press **SELECT** to confirm.
2. The radio will connect to the update server and check for new versions. If a new software version is found, the radio will download and install the new software.

Checking for
new versions...

Your radio software is now up-to-date.



Software updates can take several minutes. Do not interrupt the update or switch the radio off until the update is complete. Interrupting the update may cause permanent damage to the system.

SW Version and Radio ID

View software version and Radio ID info.

Enter the menu as follows: MAIN MENU > SYSTEM SETUP > Info. Press **SELECT** to confirm.

- ✦ SW version: View software version info.
- ✦ Radio ID: View radio identification info.



You may need to note this information when dealing with technical support issues.

Set Up Media Sharing with Windows Media Player 11

After you download and install Windows Media Player 11 for Windows XP and connect your radio to the network, you will need to set up media sharing so that the radio can access your music library. The following steps describe how to set up media sharing in Windows Media Player 11.

1. In Windows Media Player 11, click the small arrow below the Library tab, and then click Media Sharing.

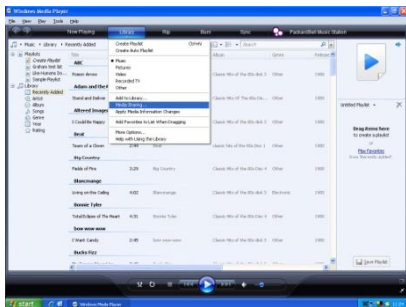

2. In the Media Sharing dialogue box, select the 'Share my media' check box.

3. Check the “Share my media to” box, then select your radio model from the list. Click ‘Allow’. The selected device will now show a green tick. Click ‘Apply’ to confirm.

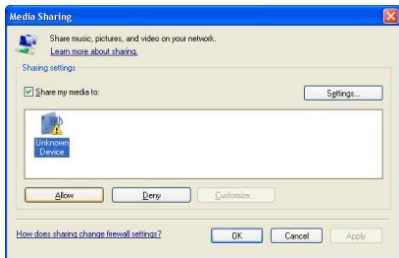

If your radio does not appear in the list of devices, perform the following steps:

1. From the “Media Player” menu of your internet radio, select “UPNP Servers”. A list of available computers will appear.
2. Select your computer. Your device will now appear in the list.

Appendix

If you want to confirm that this is your radio, right click on the device and select 'Properties'. Your Radio's MAC address will be shown.

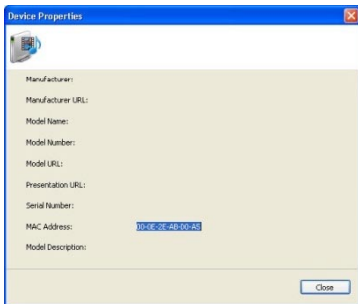
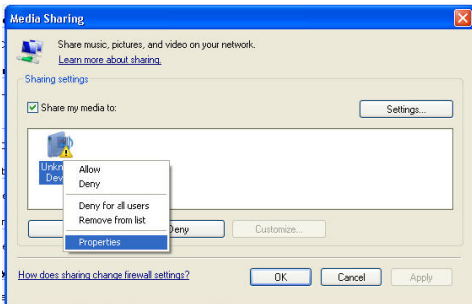

Set Up Media Sharing with Mac OS X

Using the Radio with a MAC will require Windows File Sharing. MAC OS X versions 10.2 and later have Windows File Sharing built in; if your operating system is MAC OS version 9 or earlier, you will require extra software to perform this function.

Set up Windows File Sharing on a MAC

1. From the 'Dock', click on 'System Preferences'. From the 'System Preferences' window, under the 'Internet & Network' section, click on 'Sharing'.
2. From the 'Sharing' window, perform the following steps:
 - ✧ Under the 'Services' section, enable 'Personal File Sharing' and 'Windows Sharing'. In order to do this, tick the corresponding boxes or click on 'Start' for each of these services.
 - ✧ Under the 'Firewall' section, switch off the firewall.
 - ✧ Under the 'Internet' section, switch off 'Internet Sharing'.

Accounts Setup

From the 'System Preferences' window, in the 'System' section, click on 'Accounts'. Select an account and remember its 'Short Name' and password. This will allow the radio to connect to your MAC.

Directory Setup

1. From the 'Dock', click on 'Finder'. From 'Finder', click on 'Applications, and then 'Utilities'.
2. Click on 'More Info' for 'Directory Access' and ensure that the 'Read/Write' option is enabled. Double-click on 'Directory Access' and enable the following:
 - ✧ AppleTalk
 - ✧ LDAPv3
 - ✧ SLP
 - ✧ SMB/CIFS
3. For 'SMB/CIFS', click on 'Configure' and select an appropriate workgroup.
4. Copy and paste the mp3 files to 'Documents' in the 'Finder' window.
5. Turn on 'AirPort' (wireless sharing).
6. Wait for a few minutes.
7. In the 'Media Player' > 'Windows Shares' menu, enter the MAC account's short name and password. The Radio should then be able to connect to the MAC.

Play Streaming Music on the Internet Radio

After installing and configuring your Radio and Windows Media Player 11, you are now ready to play music via a wireless connection. The following steps describe how to play music with your Radio.

1. Select "UPNP Servers" in the "Media Player" menu.
2. Select the computer you wish to play the music files from.
3. Use the controls to browse according to the following criteria: All Music, Genre, All Artists, Contributing Artists, Album Artists, Composers, Albums, Playlists, Folders or Star Ratings, and then press **SELECT** to confirm.
4. Select the tracks you wish to play, then press the **SELECT** button.

Enjoy the music!

Frontier Silicon Internet Radio Portal

Visit the Frontier Silicon web portal at www.wifiradio-frontier.com to browse global stations and personalize your favorites. You can also add additional stations to your radio through the website.

You will need to create an account and register your device to use the web portal.

1. Get the unique access code.
Each IR825 unit has a unique access code ID.
 - ✧ Press **MENU** to access the Main menu, then select INTERNET RADIO > HELP > Get access code. Write down the access code that is displayed on the screen.



*To access the Main menu in FM radio mode, press **MENU**, then select <Main menu> from the menu list.*

2. On a computer, enter the URL **www.wifiradio-frontier.com** into a web browser. Click on the link "Register here."

3. Fill out the registration form with the access code from step 1, as well as an email address, a new password, and the internet radio model you are using (e.g., Coby IR825).

FRONTIER SILICON
Radio Portal

Member Login
Email address
Password

Forgot your password?
Not a member? Register here.

English Dansk Portugals
Español Norsk Italiano
Français Svensk Nederlands
Deutsch Suomi Türkçe
Polski

About us Contact us
© Frontier Silicon 2009 | Legal

Access global stations
Personalise favourites
Search. Browse. Find.

Create account login

1. Please enter the Access code for your Wi-Fi radio (Please refer to your Wi-Fi radio instruction manual to find your Access code):

Access code:

2. Type in your Email Address, then enter in your Password twice to verify accuracy, click the register link to continue.
Please keep track of your password since it will be used every time you log in to your account.

E-Mail address:

Password: Must be at least 6 characters

Enter password again:

Wi-Fi radio model

4. When the form is complete, click the “Register” button to create your account.

Troubleshooting

If you have trouble connecting the radio to your wireless network, these steps may help to resolve the problem:

1. Confirm that a Wi-Fi connected PC can access the Internet (i.e., can browse the web) using the same network.
2. Check that a DHCP server is available, or that you have configured a static IP address on the radio. You can configure a static IP address on the radio by entering System setup -> Network -> Manual setting-> Wireless, then selecting 'DHCP disable'.
3. Check that your access point does not restrict connections to particular MAC addresses. You can view the radio's MAC address by entering 'System setup -> Network -> View setting-> MAC address'.
4. If you have an encrypted network, check that you have entered the correct key or password into the radio. Remember that text-format keys are case sensitive. If, when attempting to connect to an encrypted network, your radio displays: 'Wireless error' followed by a 5-digit number, then please ensure that you enter the correct passcode for the network. If the problem persists, you may need to consult your network configuration.

If your radio can connect to the network successfully, but is unable to play particular stations, it may be due to one of the following:

- The station is not broadcasting at this time of the day (e.g., it is located in a different time zone).

Troubleshooting

- The station has reached the maximum allowed number of simultaneous listeners.
- The station is no longer broadcasting.
- The link on the radio is out of date.
- The Internet connection between the server (often located in a different country) and the radio is slow.

To confirm station status, try using a PC to access the station via the broadcaster's web site.



If you can play back the station with a PC, use the form at <http://www.wifiRadio-frontier.com> to notify us so that we can change the station data. Once this information has been updated, the radio should be able to connect.

Specifications

Power Requirements	AC 100-240V, 50-60HZ (please use provided adapter) Output: DC 9V, 1000mA
Frequency Range	(FM) 87.5-108MHz
Rated Output Power	2W x 2 (RMS)
Speaker Impedance	8 Ω
Headphone Jack	3.5mm stereo, 32 Ω
Dimension	8.9" x 4.1" x 4.4" (WHD)

Specifications and manual are subject to change without notice.

Safety Notices

	CAUTION WARNING: SHOCK HAZARD. DO NOT OPEN. AVIS: RISQUE DE CHOC ELECTRIQUE. NE PAS OUVRIR	
CAUTION: TO REDUCE THE RISK OF FIRE AND ELECTRIC SHOCK, DO NOT REMOVE THE COVER (OR BACK) OF THE UNIT. REFER SERVICING ONLY TO QUALIFIED SERVICE PERSONNEL.		



The lightning flash with arrowhead symbol within an equilateral triangle is intended to alert the user to the presence of uninsulated "dangerous voltage" within the product's enclosure that may be of sufficient magnitude to constitute a risk of electric shock.



The exclamation point within an equilateral triangle is intended to alert the user to the presence of important operation and servicing instructions in the literature accompanying the appliance.

For Customer Use:

Enter below the serial number that is located on the rear of the unit. Retain this information for future reference.

Model No. IR825

Serial No. _____

WARNING: To prevent fire or shock hazard, do not expose this device to rain or moisture. Dangerous high voltage is present inside the enclosure. Do not open the cabinet.

CAUTION: To prevent electric shock, match wide blade of plug to wide slot of outlet and fully insert.

Protect your hearing: Hearing experts advise against the constant use of personal stereos played at high volume. Constant exposure to high volumes can lead to hearing loss. If you should experience ringing in the ears or hearing loss, discontinue use and seek medical advice.

At the end of its operating life, this product must be disposed of safely. Bring the product to a collection point for recycling electrical and electronic equipment. Do not dispose of it with household waste. By recycling this equipment and its components, you are making an important contribution to the protection of our environment.

Safety Notices



For recycling or disposal information about this product, please contact your local authorities or the Electronics Industries Alliance: www.eiae.org.

FCC Statement:

This device complies with Part 15 of the FCC Rules. Operation is subject to the following two conditions:

- (1) This device may not cause harmful interference, and
- (2) This device must accept any interference received, including interference that may cause undesired operation.

Note: This equipment has been tested and found to comply with the limits for Class B digital devices, pursuant to Part 15 of the FCC rules. These limits are designed to provide reasonable protection against harmful interference in a residential installation. This equipment generates, uses and can radiate radio frequency energy and, if not installed and used in accordance with the instructions, may cause harmful interference to radio communications. However, there is no guarantee that interference will not occur in a particular installation. If this equipment does cause harmful interference to radio or television reception, which can be determined by turning the equipment off and on, the user is encouraged to try to correct the interference by one or more of the following measures:

- Reorient or relocate the receiving antenna.
- Increase the separation between the equipment and receiver.
- Connect the equipment into an outlet on a circuit different from that to which the receiver is connected.
- Consult the dealer or an experienced radio/TV technician for help

Use of shielded cable is required to comply with Class B limits in Subpart B of Part 15 of the FCC rules.

Do not make any changes or modifications to the equipment unless otherwise specified in the manual. If such changes or modifications should be made, you could be required to stop operation of the equipment.

Safety Notices

Important Safety Instructions

1. **Read Instructions:** All the safety and operating instructions should be read before the product is operated.
2. **Retain Instructions:** The safety and operating instructions should be retained for future reference.
3. **Heed Warnings:** All warnings on the product and in the operating instructions should be adhered to.
4. **Follow Instructions:** All operating and usage instructions should be followed.
5. **Cleaning:** Unplug this product from the wall outlet before cleaning. Do not use liquid cleaners or aerosol cleaners. Use a damp cloth for cleaning.
6. **Attachments:** Use only attachments recommended by the manufacturer. Use of other attachments may be hazardous.
7. **Water and Moisture:** Do not use this product near water (e.g., near a bath tub, washbowl, kitchen sink, laundry tub, in wet basements, or near a swimming pool and the like).
8. **Ventilation:** Slots and openings in the cabinet are provided for ventilation to ensure reliable operation of the product and to protect it from overheating. These openings should never be blocked by placing the product on a bed, sofa, rug, or other similar surface. This product should not be placed in a built-in installation such as a bookcase or rack unless proper ventilation is provided or the manufacturer instructions have been adhered to.
9. **Power Sources:** This product should be operated only from the type of power source indicated on the rating label. If you are not sure of the type of power supply to your home, consult your product dealer or local power company. For products intended to operate from battery power or other sources, refer to the operating instructions.
10. **Power-Cord Protection:** Power supply cords should be routed so that they are not likely to be walked on or pinched by items placed upon or against them, paying particular attention to cords at plugs, convenience receptacles, and at the point which they exit from the product.
11. **Lightning:** For added protection for this product, unplug it from the wall outlet and disconnect the antenna or cable system during a lightning storm or when it is left unattended and unused for long periods of time. This will prevent damage to the product due to lightning or power-line surges.

Safety Notices

12. **Overloading:** Do not overload wall outlets, extension cords, or integral convenience receptacles as this can result in a risk of fire or electric shock.
13. **Object and Liquid Entry:** Never push objects of any kind into this product through openings as they may touch dangerous voltage points or short-out parts that could result in a fire or electric shock. Never spill liquid of any kind on the product.
14. **Servicing:** Do not attempt to service this product yourself as opening or removing covers may expose you to dangerous voltage or other hazards. Refer all servicing to qualified service personnel.
15. **Damage Requiring Service:** Unplug this product from the wall outlet and refer servicing to qualified service personnel under the following conditions: a) when the power-supply or plug is damaged; b) if liquid has been spilled or if objects have fallen into the product; c) if the product has been exposed to rain or water; d) if the product does not operate normally by following the operating instructions. Adjust only those controls that are covered by the operating instructions as improper adjustment of other controls may result in damage and will often require extensive work by a qualified technician to restore the product to its normal operation; e) if the product has been dropped or damaged in any way; f) when the product exhibits a distinct change in performance—this indicates a need for service.
16. **Replacement Parts:** When replacement parts are required, be sure that your service technician has used replacement parts specified by the manufacturer or have the same characteristics as the original part. Unauthorized substitutions may result in fire, electric shock, or other hazards.
17. **Safety Check:** Upon completion of any service or repairs to this product, ask the service technician to perform safety checks to ensure that the product is in proper operating condition.
18. **Heat:** The product should be situated away from heat sources such as radiators, heat registers, stoves, or other products (including amplifiers) that produce heat.

Coby Electronics Corporation

1991 Marcus Ave, Suite 301
Lake Success, NY 11042

www.cobyusa.com

www.ecoby.com