

SD-330AC

Wireless LAN Serial Device Server

Link Serial Devices to your 802.11ac Enterprise Network



The Silex SD-330AC is designed to securely connect devices equipped with the RS-232C serial interfaces. Industrial automation, building automation, medical devices, security access and control, point of sale devices, LED signs, bar code/label and other specialty printers, or virtually any other device with a serial port can now be enabled with secure, robust wireless network capability.

SD-330AC eliminates the need to connect the RS-232C device directly to the computer and is expected to improve the freedom of installation of the device and efficiency by remote maintenance and through a reduction in work time.

Key Features:

- **Secure wireless LAN environment**

In addition to general security, WPA2-EAP and IEEE 802.1x enterprise security are included, so the serial device can be deployed in a secure wireless environment.

- Open (128bit)
- WPA-PSK (AUTO)
- WPA2-PSK (AES)
- WPA-EAP (AUTO)
- WPA2-EAP (AES)
- IEEE 802.1x(EAP-TLS/EAP-TTLS/PEAP/EAP-FAST/LEAP)

- **Supports various connection modes**

1) Serial Port Emulation Mode:

It is a function to emulate the standard Windows COM port on network using the application "SX Virtual Link for Serial Device Server". User can communicate with serial devices over the network using this application

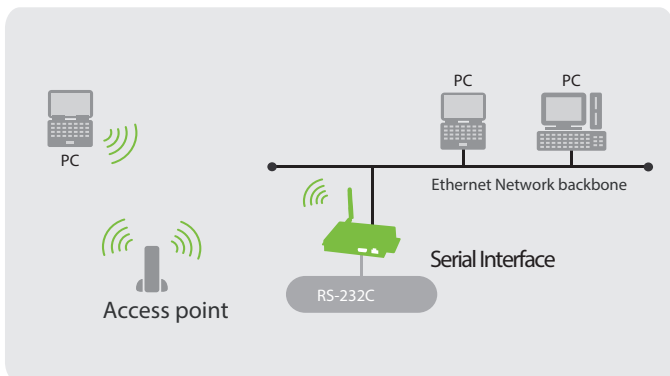

2) eCable Mode:

This function allows serial devices with no network interface to communicate with each other using two SD-330AC's. Here one SD-330AC acts as receiver and the other acts as transmitter with serial devices connected to them at each end. When the network connection is established, these serial devices can communicate with each other through SD-330AC, thus freeing the user from cable length limitations.

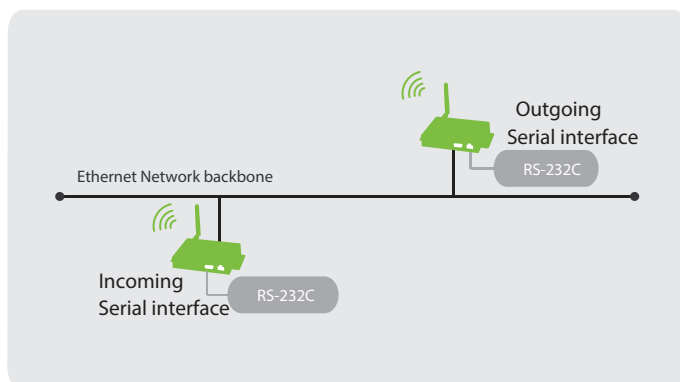

- **Wired LAN / Wireless LAN compatible**

This product can be used in a wired LAN or wireless LAN environment.

1) Wired LAN mode:

It supports 10Base-T / 100Base-TX automatic recognition function.

2) Wireless LAN mode:

■ Infrastructure mode

If there is an existing wireless LAN environment, this product can be used as a wireless handset (station).

■ AP mode

This product is equipped with access point mode.

Up to 5 wireless devices can be connected to this product.

※ Available channels in access point mode are as follows.

- 1 to 13ch, 36 to 48ch

※ Security available in access point mode are as follows.

(WEP and IEEE 802.1x are not supported.)

- WPA-PSK (AUTO)
- WPA2-PSK (AES)

SX Virtual Link Software

SX Virtual Link software for Serial Device Server is an application that allows the user to connect their computer to a serial device that is connected to a device server. Users only have to select the serial device listed in the SX Virtual Link application and click on 'Connect' to connect their computer to the server. Some of the highlights of the SX Virtual Link are:

- Ease of use
- Ability to allow control from the task tray
- Ability to send remote messages to other users to request disconnect from the serial device in use



SX Virtual Link for Serial Device Server

Other Serial Device Server

For environments with restrictions that can not introduce wireless LAN devices, we also offer wired LAN-only models.

Wired LAN only Serial Device Server SD-300



- 10Base-T / 100Base-TX (automatic identification)
- RS-232C x 1 Port

※ Please refer to the specifications on the right for differences with wired LAN models.

Embedded Option

Small Intelligent Module SX-590



- Single stream, 1x1
- UART, Ethernet (10/100)
- Offload wireless LAN driver, security supplicant, TCP / IP communication processing

Specifications

Product Name	SD-330AC
Wired LAN	10Base-T / 100Base-TX
Wireless Standard	IEEE802.11a/b/g/n/ac
Security <i>Note: 802.1x is only available in wireless station (client) mode</i>	WPA-PSK (AUTO) WPA2-PSK (AES) IEEE 802.1X (LEAP, PEAP, TTLS, TLS, EAP-FAST)
Device Interface	RS-232C
Supported OS (SX-Virtual Link Serial Port Emulator) <i>Note: RAW TCP mode and eCable mode are not OS dependent</i>	Windows 10, Windows 8 / 8.1 (32/64-bit), 7 (32/64-bit), Vista (32/64-bit), XP (32/64-bit), 2000, Windows Server 2012/2008/2003 (32/64-bit)
Supported Protocol	TCP / IP
Configuration Methods	Configuration utility, Web browser, TELNET, AMC Manger
Dimension	125.7 X 75.1 X 24.1mm (body only, excluding protrusions)
Weight	305g (body only, including antennas)
Environmental Condition	Operating Temperature: 0 to +50°C Humidity : 20 ~ 80% RH Storage Temperature: -20 to +70°C Humidity : 20 ~ 90% RH
Power Consumption	2.5W (DC5V/0.5A)
Regulatory Compliance	VCCI Class B, FCC Class B, ICES-003 Class B, CE Class B, RoHS
Supported software	SX Virtual Link for Serial Device Server AMC Manager
Included Items	Body, AC adapter, setup guide, rubber feet, wireless LAN antenna GPL inquiry sheet, warranty card

silex global sales & support locations



US Office
silex technology america, Inc.
US toll free 657-218-5199
www.silextechnology.com
sales@silexamerica.com

Europe Office
silex technology europe, GmbH
+49-2154-88967-0
Germany toll free 0800-7453938
www.silexeurope.com
contact@silexeurope.com

India Office
silex technology india, Pvt. Ltd.,
+91-44-4303234
www.silex-india.com
support@silex-india.com

Corporate Headquarters
silex technology, Inc.
+81-774-98-3781
www.silex.jp
support@silex.jp