

**LG Electronics Inc.**  
www.lge.com

LCD TV | OWNER'S MANUAL



## LCD TV OWNER'S MANUAL

LCD TV MODEL  
47LB1DA

Please read this manual carefully before operating your set. Retain it for future reference. Record model number and serial number of the set. See the label attached on the back cover and quote this information to your dealer when you require service.

LG Electronics Inc.



P/NO : 38289U0512V (0610-REV00)  
Printed in Korea

www.lge.com / www.lg.ca



# WARNING / CAUTION



**WARNING / CAUTION**

**RISK OF ELECTRIC SHOCK  
DO NOT OPEN**



**TO REDUCE THE RISK OF ELECTRIC SHOCK  
DO NOT REMOVE COVER (OR BACK). NO  
USER SERVICEABLE PARTS INSIDE. REFER TO  
QUALIFIED SERVICE PERSONNEL.**



The lightning flash with arrowhead symbol, within an equilateral triangle, is intended to alert the user to the presence of uninsulated "dangerous voltage" within the product's enclosure that may be of sufficient magnitude to constitute a risk of electric shock to persons.



The exclamation point within an equilateral triangle is intended to alert the user to the presence of important operating and maintenance (servicing) instructions in the literature accompanying the appliance.

## WARNING/CAUTION

**TO REDUCE THE RISK OF FIRE AND ELECTRIC SHOCK,  
DO NOT EXPOSE THIS PRODUCT TO  
RAIN OR MOISTURE.**

## WARNING / CAUTION

To prevent fire or shock hazards, do not expose this product to rain or moisture.

### FCC NOTICE

#### Class B digital device

This equipment has been tested and found to comply with the limits for a Class B digital device, pursuant to Part 15 of the FCC Rules. These limits are designed to provide reasonable protection against harmful interference in a residential installation. This equipment generates, uses and can radiate radio frequency energy and, if not installed and used in accordance with the instructions, may cause harmful interference to radio communications. However, there is no guarantee that interference will not occur in a particular installation. If this equipment does cause harmful interference to radio or television reception, which can be determined by turning the equipment off and on, the user is encouraged to try to correct the interference by one or more of the following measures:

- Reorient or relocate the receiving antenna.
- Increase the separation between the equipment and receiver.
- Connect the equipment to an outlet on a circuit different from that to which the receiver is connected.
- Consult the dealer or an experienced radio/TV technician for help.

**Any changes or modifications not expressly approved by the party responsible for compliance could void the user's authority to operate the equipment.**

### CAUTION

Do not attempt to modify this product in any way without written authorization from LG Electronics. Unauthorized modification could void the user's authority to operate this product

WARNING / CAUTION

# SAFETY INSTRUCTION

## IMPORTANT SAFETY INSTRUCTIONS

Important safety instructions shall be provided with each apparatus. This information shall be given in a separate booklet or sheet, or be located before any operating instructions in an instruction for installation for use and supplied with the apparatus.

This information shall be given in a language acceptable to the country where the apparatus is intended to be used.

The important safety instructions shall be entitled "Important Safety Instructions". The following safety instructions shall be included where applicable, and, when used, shall be verbatim as follows. Additional safety information may be included by adding statements after the end of the following safety instruction list. At the manufacturer's option, a picture or drawing that illustrates the intent of a specific safety instruction may be placed immediately adjacent to that safety instruction :

SAFETY INSTRUCTION

**Read these instructions.**  
**Keep these instructions.**  
**Heed all warnings.**  
**Follow all instructions.**



- 1** Do not use this apparatus near water

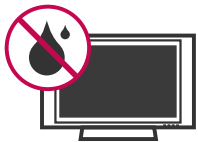

- 2** Clean only with dry cloth.



- 3** Do not block any ventilation openings. Install in accordance with the manufacturer's instructions



- 4** Do not install near any heat sources such as radiators, heat registers, stoves, or other apparatus (including amplifiers) that produce heat.



- 5** Do not defeat the safety purpose of the polarized or grounding-type plug. A polarized plug has two blades with one wider than the other. A grounding type plug has two blades and a third grounding prong. The wide blade or the third prong are provided for your safety. If the provided plug does not fit into your outlet, consult an electrician for replacement of the obsolete outlet.



- 6** Protect the power cord from being walked on or pinched particularly at plugs, convenience receptacles, and the point where they exit from the apparatus.



- 7** Only use attachments/accessories specified by the manufacturer.



- 8** Use only with the cart, stand, tripod, bracket, or table specified by the manufacturer, or sold with the apparatus. When a cart is used, use caution when moving the cart/apparatus combination to avoid injury from tip-over.



- 9** Unplug this apparatus during lightning storms or when unused for long periods of time.

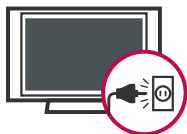

- 10** Refer all servicing to qualified service personnel. Servicing is required when the apparatus has been damaged in any way, such as power-supply cord or plug is damaged, liquid has been spilled or objects have fallen into the apparatus, the apparatus has exposed to rain or moisture, does not operate normally, or has been dropped.

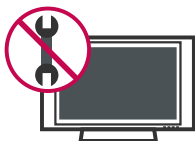

- 11** **CAUTION** concerning the Power Cord : Most appliances recommend they be placed upon a dedicated circuit; that is, a single outlet circuit which powers only that appliance and has no additional outlets or branch circuits. Check the specification page of this owner's manual to be certain.

Do not overload wall outlets. Overloaded wall outlets, loose or damaged wall outlets, extension cords, frayed power cords, or damaged or cracked wire insulation are dangerous. Any of these conditions could result in electric shock or fire. Periodically examine the cord of your appliance, and if its appearance indicates damage or deterioration, unplug it, discontinue use of the appliance, and have the cord replaced with an exact replacement part by

an authorized servicer. Protect the power cord from physical or mechanical abuse, such as being twisted, kinked, pinched, closed in a door, or walked upon. Pay particular attention to plugs, wall outlets, and the point where the cord exits the appliance.



- 12** **Outdoor Use Marking :**  
WARNING - To Reduce The Risk Of Fire Or Electric Shock, Do Not Expose This Appliance To Rain Or Moisture



- 13** **Wet Location Marking :** Apparatus shall not be exposed to dripping or splashing and no objects filled with liquids, such as vases, shall be placed on or over apparatus.



- 14** **DISCONNECTING DEVICE FROM MAINS**  
Mains plug is the disconnecting device. The plug must remain readily operable.

# CONTENTS

**WARNING / CAUTION** ..... 1

**SAFETY INSTRUCTIONS** ..... 2-3

## INTRODUCTION

TV Guide On Screen™ Notices for U.S.A. /  
Digital Cable Compatibility ..... 8

Accessories ..... 9

Controls / Connection Options ..... 10-11

Remote Control Key Functions ..... 12-13

## INSTALLATION

Attaching the TV to a Wall ..... 14

Wire Arrangement ..... 15

Desktop Pedestal Installation ..... 16

Swivel Stand ..... 16

## CONNECTIONS & SETUP

Auto Link ..... 17

Antenna or Cable Connection ..... 18-19

CableCARD™ Setup ..... 20

HDSTB Setup ..... 21-23

VCR Setup ..... 24-25

AV Out Setup ..... 26

Digital Audio Output ..... 27

External A/V Source Setup ..... 28

DVD Setup ..... 29-30

PC Setup ..... 31-34

## BASIC OPERATION

Turning the TV On ..... 35

On-Screen Menus Language Selection ..... 36

Initial Channel Search (EZ Scan) ..... 37

Channel Selection ..... 38

Volume Adjustment ..... 38

## TV GUIDE ON SCREEN™ SYSTEM

TV Guide On Screen Setup ..... 39-41

- Ready to Setup

- Using TV Guide

TV Guide On Screen™ Feature ..... 42-57

- Overview

- Screen Components

- Panel Menu

- Main Services

*Listings / Search*

*Schedule / Setup*

- Remind Features

## SPECIAL FUNCTIONS

### PIP/POP/Twin Picture

- Watching PIP/POP/Twin Picture ..... 58

- Selecting an Input Signal Source  
for PIP/Twin Picture ..... 59

- TV Program Selection for PIP ..... 59

- Moving the PIP Sub Picture ..... 59

- Swapping PIP/Twin Picture ..... 60

- Adjusting Main and Sub Picture Sizes  
for Twin Picture ..... 60

- POP (Picture-out-of-Picture: Channel Scan) .... 61

## TV MENU

On Screen Menus Selection and Adjustment .... 62

### Setup(Channel)

Auto Channel Search (EZ Scan) ..... 63  
 Manual Channel Search (Manual Scan) ..... 64  
 Channel Edit ..... 65  
 DTV Signal Strength ..... 66  
 Main Picture Source Selection ..... 67  
 Input Label ..... 68

### Video Adjustment

Auto Picture Control (EZ Picture) ..... 69  
 Adaptive Picture Mode (APM)..... 70  
 Manual Picture Control  
 (EZ Picture-User Option) ..... 71  
 Color Temperature Control ..... 72-73  
 - Auto Color Temperature Control ..... 72  
 - Manual Color Temperature Control ..... 73  
 XD ..... 74  
 Advanced ..... 75-76  
 - Cinema 3:2 Mode Setup ..... 75  
 - Black Level ..... 76  
 Video Reset ..... 77

### Audio Adjustment

Audio Language ..... 78  
 Auto Volume Leveler (EZ SoundRite) ..... 79  
 Auto Sound Control (EZ Sound) ..... 80  
 Manual Sound Control  
 (EZ Sound-User Option) ..... 81-82  
 Balance ..... 83  
 TV Speakers On/Off Setup ..... 84  
 BBE ..... 85  
 Stereo/SAP Broadcasts Setup ..... 86

### Time Setting

Auto Clock Setup ..... 87  
 Manual Clock Setup ..... 88  
 On/Off Timer Setup ..... 89  
 Sleep Timer ..... 90  
 Auto Off ..... 91

## Optional Features

Aspect Ratio Control ..... 92-93  
 Caption/Text ..... 94-95  
 - Analog Broadcasting System Captions ..... 94  
 - Digital Broadcasting System Captions ..... 95  
 Caption Option ..... 96  
 Brief Info..... 97

## Lock Adjustment

Setting Up Your Password ..... 98  
 Lock System ..... 99  
 Set Password ..... 99  
 Block Channel ..... 100  
 Movie Rating (MPAA)- for USA only ..... 101  
 TV Rating Children- for USA only ..... 102  
 TV Rating General- for USA only ..... 102  
 TV Rating English- for CANADA only ..... 103  
 TV Rating French- for CANADA only ..... 103  
 Input Block ..... 104

## CableCARD™ Function

Cable Menu Options ..... 105  
 Scrambled channel ..... 106  
 Cable Channel List ..... 107  
 Emergency Message Alert ..... 107

## APPENDIX

External Control Device Setup ..... 108-114  
 IR Codes ..... 115-116  
 Programming the Remote Control ..... 117  
 Programming Codes ..... 118-119  
 Troubleshooting Checklist ..... 120-122  
 Maintenance ..... 123  
 Product Specifications ..... 124

# INTRODUCTION

## 178° - Wide angle range of vision

Your flat panel screen offers an exceptionally broad viewing angle of over 178 degrees. This means that the display is clear and visible to viewers anywhere in the room.

## Wide Screen

The wide screen offers a theater-like experience in your own home.

## Multimedia

Connect your display to a PC and use it for conferencing, games, and Internet browsing. The Picture-in-Picture feature allows you to view your PC and video images simultaneously.

## Versatile

The light weight and thin size makes it easy to install your display in a variety of locations where conventional TVs do not fit.

## The Product Manufacturing Process: a few minute colored dots may be present on the TV screen

This TV is composed of 0.9 to 2.2 million cells. A few cell defects will normally occur in the this TV manufacturing process. Several tiny, minute colored dots visible on the screen should be acceptable. This also occurs in other this TV manufacturers' products. The tiny dots appearing does not mean that this TV is defective. Thus a few cell defects are not sufficient cause for this TV to be exchanged or returned. Our production technology minimizes these cell defects during the manufacture and operation of this product.

If the TV feels cold to the touch, there may be a small "flicker" when it is turned on. This is normal, there is nothing wrong with TV.

Some minute dot defects may be visible on the screen, appearing as tiny red, green, or blue spots. However, they have no adverse effect on the monitor's performance.

Avoid touching the LCD screen or holding your finger(s) against it for long periods of time. Doing so may produce some temporary distortion effects on the screen.

## On Disposal

- a. The fluorescent lamp used in this product contains a small amount of mercury.
- b. Do not dispose of this product with general household waste.
- c. Disposal of this product must be carried out in accordance to the regulations of your local authority.



Official term for an HDTV that conforms to the plug-and-play digital cable TV standard using POD (Point of Deployment) access cards, also called CableCARDS, that allow users to plug the cable directly into an HDTV set and enjoy HDTV and digital cable without having to use a separate set-top box.



**SRS** is a trademark of SRS Labs, Inc. TruSurround XT technology is incorporated under license from SRS Labs, Inc.



Manufactured under license from BBE Sound, Inc.



Manufactured under license from Dolby Laboratories. "Dolby" and the double-D symbol are trademarks of Dolby Laboratories.



High-definition television. High-resolution digital television broadcast and playback system composed of roughly a million or more pixels, 16:9 aspect-ratio screens, and AC3 digital audio. A subset of digital television, HDTV formats include 1080i and 720p resolutions.



HDMI™, the HDMI logo and High-Definition Multimedia Interface are trademarks or registered trademarks of HDMI Licensing."



LC's own special digital image generator, consisting of a full digital image processor, APM mode & six different main picture quality factors.

# INTRODUCTION

## TV GUIDE ON SCREEN™ NOTICES FOR U.S.A.



### Trademark Notice

In the United States, TV GUIDE and other related marks are registered marks of Gemstar-TV Guide International, Inc. and/or one of its affiliates. In Canada, TV GUIDE is a registered mark of Transcontinental Inc., and is used under license by Gemstar-TV Guide International, Inc.

### License Notice

The TV Guide On Screen™ system is manufactured under license from Gemstar-TV Guide International, Inc. and/or one of its affiliates.

### Patent Notice

The TV Guide On Screen™ system is protected by one or more of the following issued United States patents 6,498,895, 6,418,556, 6,331,877; 6,239,794; 6,154,203; 5,940,073; 4,908,713; 4,751,578; 4,706,121.

Use of the CableCARD™ TradeMark.

“CableCARD™ is a trademark of Cable Television Laboratories, Inc.”

Gemstar-TV Guide International Inc. and/or its related affiliates are not in any way liable for the accuracy or availability of the program schedule information or other data in the TV Guide On Screen system and cannot guarantee service availability in your area. In no event shall Gemstar-TV Guide International, Inc. and/or its related affiliates be liable for any damages in connection with the accuracy or availability of the program schedule information or other data in the TV Guide On Screen system.

## DIGITAL CABLE COMPATIBILITY

This digital television is capable of receiving basic analog, digital basic and digital premium cable television programming by direct connection to a cable system providing such programming. A security card provided by your cable operator is required to view encrypted digital programming. Cable operator enhanced program (For example, electronic program guide provided by the cable operator), and data enhanced television service may require the use of a set top box. For more information contact your local cable operator.

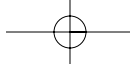

# ACCESSORIES

Ensure that the following accessories are included with your product. If an accessory is missing, please contact the dealer where you purchased the product.

User must use shielded signal interface cables (D-sub 15 pin cable) with ferrite cores to maintain standard compliance for the product.

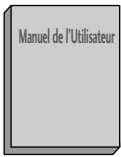

Owner's Manual

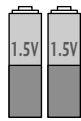

Batteries



Remote Control

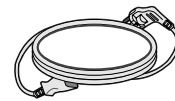

Power Cord



75ohm Round Cable

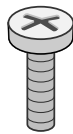

2-TV Bracket Bolts

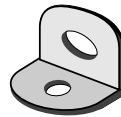

2-TV Brackets,  
2-Wall Brackets



Cable Management  
(Refer to p.15)



Twister Holder  
Arrange the wires  
with the twister holder.

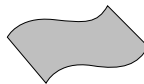

Polishing Cloth  
Polish the screen with the cloth.

- \* Slightly wipe stained spot on the exterior only with the cleansing cloths for the product exterior if there is stain or fingerprint on surface of the exterior.
- \* Do not wipe roughly when removing stain. Please be cautions of that excessive power may cause scratch or discoloration.

**Option Extras**

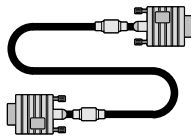

**D-sub 15 pin Cable**

# INTRODUCTION

## CONTROLS

■ Here shown may be somewhat different from your TV.

### Front Panel Controls

INTRODUCTION

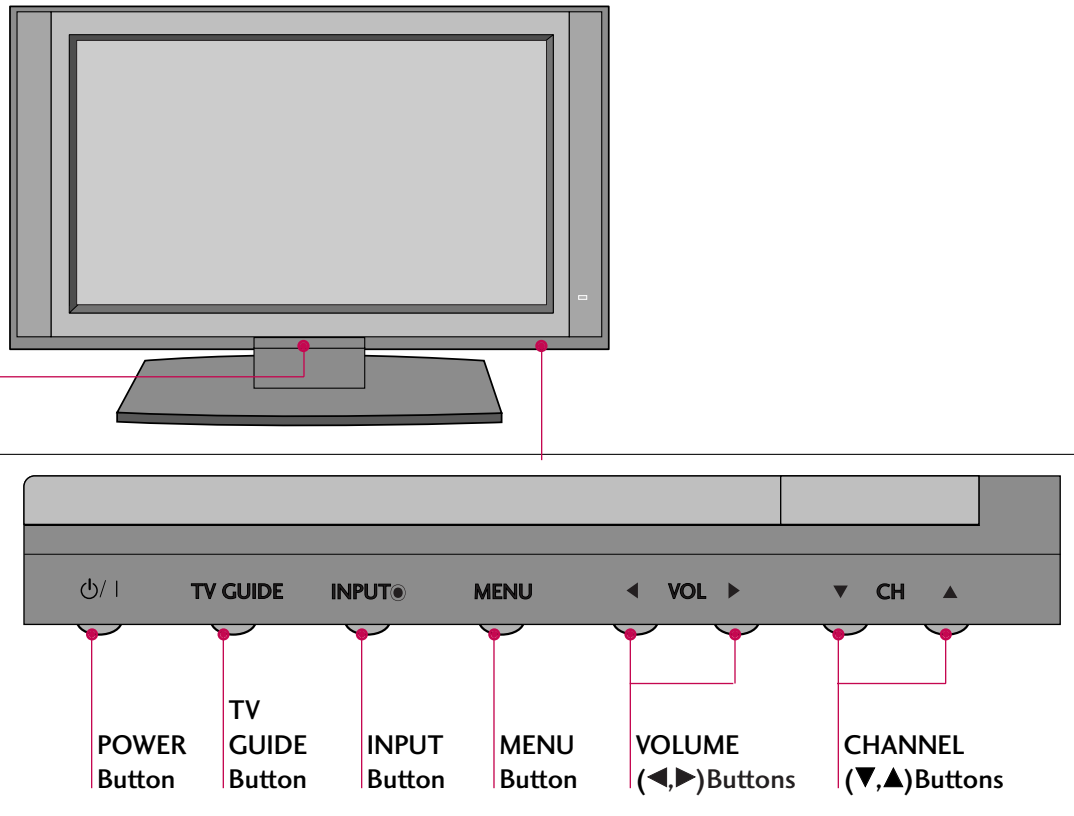

**Remote Control Sensor**

**Power Standby Indicator**  
Illuminates red in standby mode. When the TV is turned on, the indicator blinks white and then illuminates white before the picture is displayed.

---

**INDEX**

Digital Cable Ready	Component mode
HDTV mode	RGB-PC mode
AV mode	HDMI1/DVI or HDMI2 mode

# CONNECTION OPTIONS

## Back Connection Panel

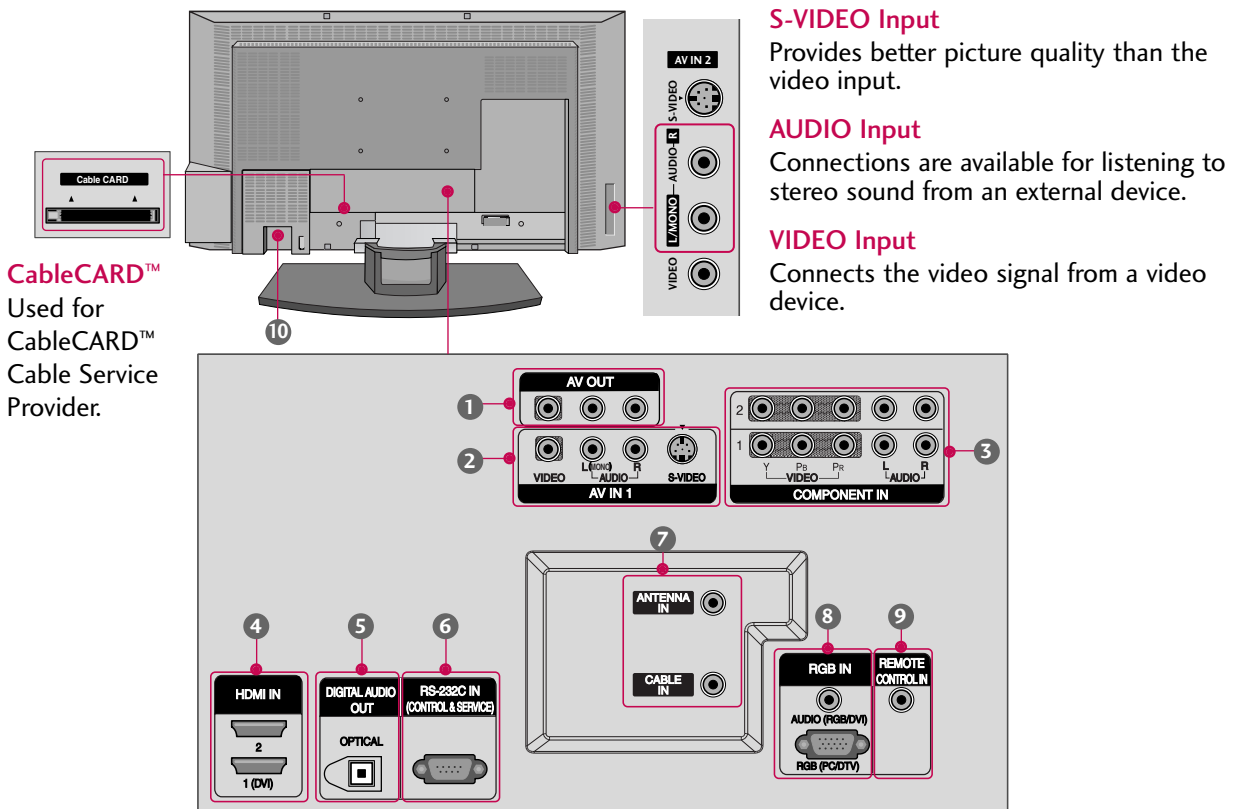

- 1 AV OUT**  
Connect a second TV or monitor.
- 2 AV (Audio/Video) IN 1**  
Connect audio/video output from an external device to these jacks.  
**S-VIDEO**  
Connect S-Video out from an S-VIDEO device.
- 3 COMPONENT IN**  
Connect a component video/audio device to these jacks.
- 4 HDMI IN**  
Connect a HDMI signal to 1 (DVI) or 2.  
Or DVI(VIDEO)signal to the 1 (DVI) port with a DVI to HDMI cable.
- 5 DIGITAL AUDIO OUT**  
Connect digital audio from various types of equipment.  
Note: In standby mode, these ports do not work.
- 6 RS-232C IN (CONTROL & SERVICE) PORT**  
Connect to the RS-232C port on a PC.
- 7 ANTENNA IN**  
Connect over-the air signals to this jack.  
**CABLE IN**  
Connect cable signals to this jack.
- 8 RGB/AUDIO IN**  
Connect the monitor output from a PC to the appropriate input port.
- 9 Remote Control Port**  
Connect your wired remote control.
- 10 Power Cord Socket**  
For operation with AC power.  
Caution:  
Never attempt to operate the TV on DC power.

# INTRODUCTION

## REMOTE CONTROL KEY FUNCTIONS

When using the remote control, aim it at the remote control sensor on the TV.

**TV INPUT** In AV 1-2, Component 1-2, RGB-PC (or RGB-DTV), HDMI1/DVI, and HDMI2 input sources, screen returns to the last TV channel.

**INPUT** External input modes rotate in regular sequence: Antenna, Cable, AV1-2, Component 1-2, RGB-PC (or RGB-DTV), HDMI1/DVI and HDMI2.  
(AV 1-2, Component 1-2, RGB-PC (or RGB-DTV), HDMI1/DVI, and HDMI2 input sources are linked automatically, only if these are connected.)

**POWER** Turns your TV or any other programmed equipment on or off, depending on the mode.

**RATIO** Change the aspect ratio. ► p.92-93

- ✱ +/-
  - Adjusts brightness on screen.
  - It returns to the default settings brightness by changing mode source.

**EXIT** Clear all on-screen displays and return to TV viewing from any menu.

**CC** Select a closed caption. ► p.94  
(\*In DTV/CADTV mode ► p.95)

**MENU** Displays the main menu. Enters or exits a Panel Menu in the TV Guide On Screen system.

**TV GUIDE** Displays the TV Guide On Screen system.

- SAP**
  - Analog mode: Selects MTS sound (Mono, Stereo, and a SAP)
  - DTV mode: Change the audio language.

### NUMBER button

— (DASH) Used to enter a program number for multiple program channels such as 2-1, 2-2, etc.

**FAV** Scroll through the programmed Favorite channels.

**TIMER** Select the amount of time before your TV turns off automatically. ► p.90

**APM** Compare the Daylight, Normal, Night Time and User1 (or2) on the screen. ► p.70

**ADJUST** Adjust the screen position, size, and phase in PC mode. ► p.34

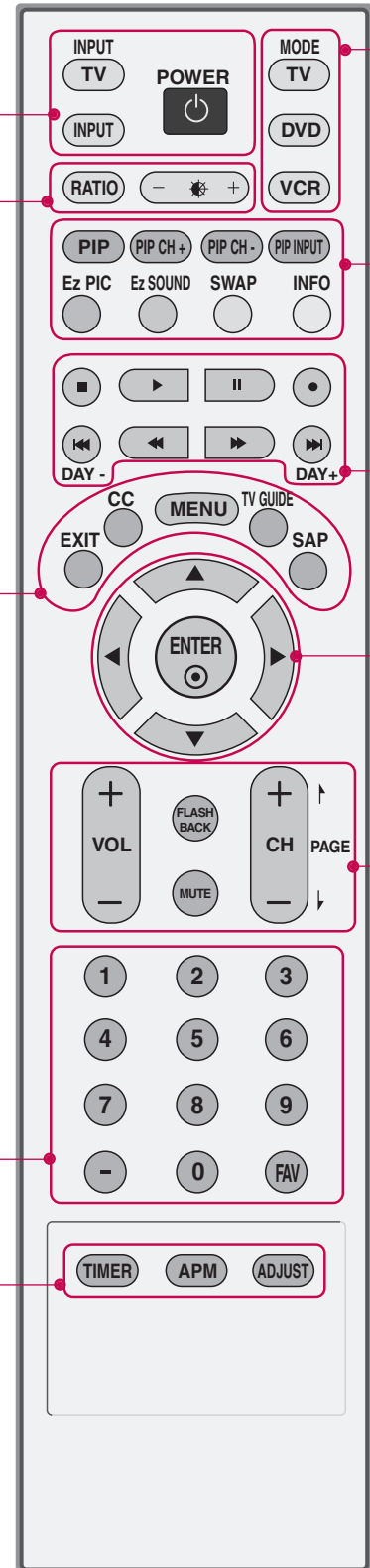

**TV, DVD, VCR,** Select the remote operating mode: TV, DVD, or VCR.

**PIP** Switches the sub picture PIP, POP, Twin picture or off mode. ▶ p.58-61

**PIP CH-/PIP CH+** Changes the PIP channel. ▶ p.59

**PIP INPUT** Select the connected input source for the sub-picture. ▶ p.59

**SWAP** Exchange the main/sub images. ▶ p.60

**Ez PIC** Adjust the factory preset picture depend on the viewing environment. ▶ p.69

**Ez SOUND** Select the appropriate type of sound for type of program. ▶ p.80

**INFO** Display information at the top of the screen. ▶ p.97

**VCR/DVD control buttons** Control video cassette recorders or DVD players.

**DAY+/DAY-** Move the Listings Grid forward or backward in 24 hour increments.

**THUMBSTICK (Up/Down/Left Right/ENTER)** Navigate the on-screen menus and adjust the system settings to your preference.

**VOLUME +/-** Increase/decrease the sound level.

**FLASHBK** Tune to the last channel viewed.

**MUTE** Switch the sound on or off. ▶ p.38

**CHANNEL +/-** Select available channels.

**PAGE UP/DOWN** Move from one full set of screen information to the next one.

## Installing Batteries

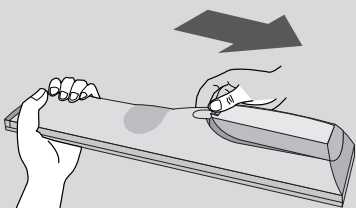

- Open the battery compartment cover on the back side and install the batteries matching correct polarity (+with +,-with -).
- Install two 1.5V AA batteries. Don't mix old or used batteries with new ones.
- Close cover.

## Remote control effective range

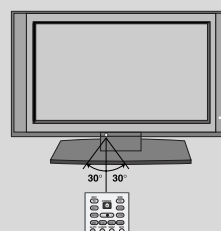

- Use a remote control up to 7 meters distance and 30 degree (left/right) within the receiving unit scope.
- Dispose of used batteries in a recycle bin to preserve environment.

# INSTALLATION

## ATTACHING THE TV TO A WALL

We recommend that you set up the TV close to a wall so it cannot fall over if pushed backwards. Additionally, we recommend that the TV be attached to a wall so it cannot be pulled in a forward direction, potentially causing injury or damaging the product.

Caution: Please make sure that children don't climb on or hang from the TV.

INSTALLATION

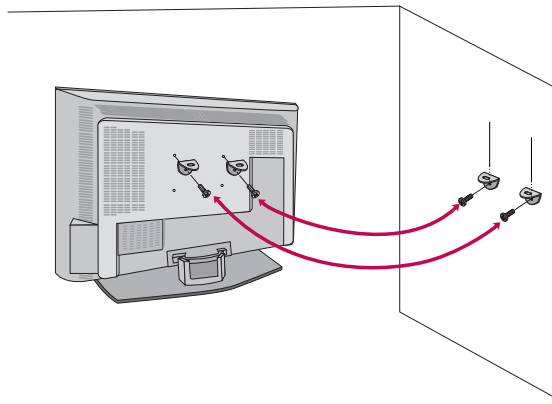

- Insert the eye-bolts (or TV brackets and bolts) to tighten the product to the wall as shown in the picture. Secure the wall brackets with the bolts (not provided as parts of the product, must purchase separately) on the wall. Match the height of the bracket that is mounted on the wall to the holes in the product. Ensure the eye-bolts or brackets are tightened securely.

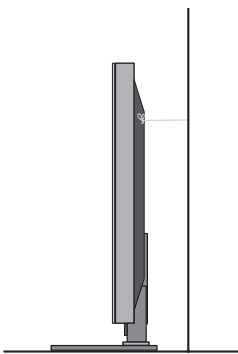

- Use a sturdy rope (not provided as parts of the product, must purchase separately) to tie the product. It is safer to tie the rope so it becomes horizontal between the wall and the product.

## WIRE ARRANGEMENT

- 1 Connect the cables as necessary.  
After connecting the cables neatly, arrange the cables to the Cable Holder.  
To connect an additional equipment, see the **Connections & Setup** section.

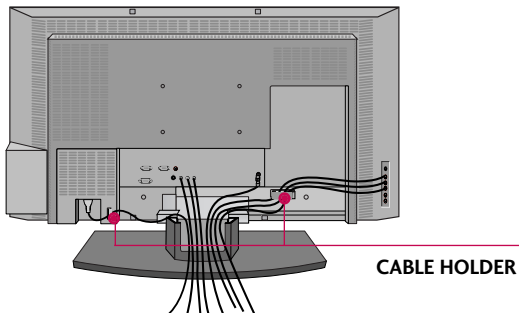

- 2 Install the **CABLE MANAGEMENT** as shown.

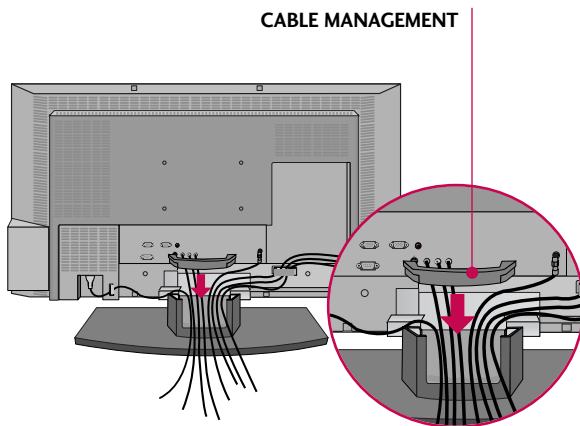

- 3 Bundle the cables using the supplied twister holder.

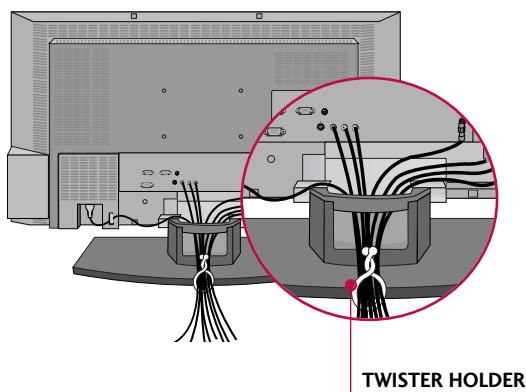

### How to remove the **CABLE MANAGEMENT**

- ▶ Hold the **CABLE MANAGEMENT** with both hands and pull it upward.

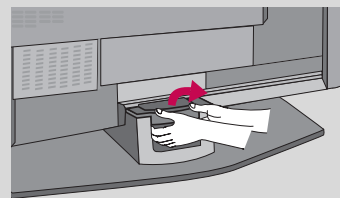

### ! **NOTE**

- ▶ Do not hold the **CABLE MANAGEMENT** when moving the product.  
- If the product is dropped, you may be injured or the product may be broken.

# INSTALLATION

## DESKTOP PEDESTAL INSTALLATION

For proper ventilation, allow a clearance of 4 inches on each side from the wall.

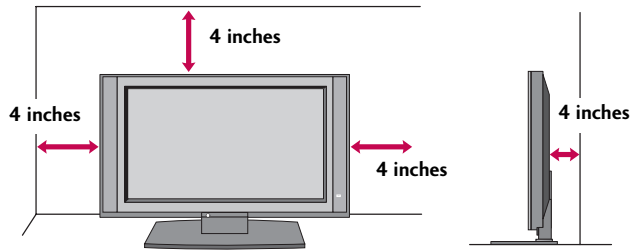

### ⚠ CAUTION

- ▶ Ensure adequate ventilation by following the clearance recommendations.

## SWIVEL STAND

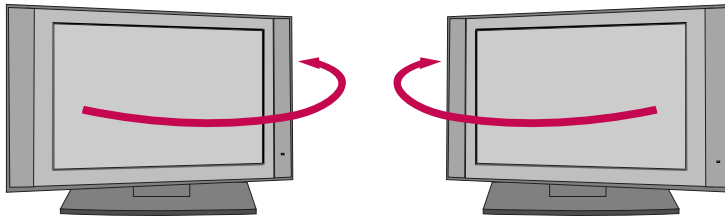

The TV can be conveniently swivelled on its stand 30° to the left or right to provide the optimum viewing angle.

- Here shown may be somewhat different from your TV.

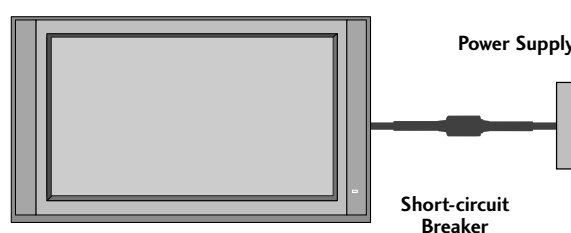

### GROUNDING

Ensure that you connect the earth ground wire to prevent possible electric shock. If grounding methods are not possible, have a qualified electrician install a separate circuit breaker.

Do not try to ground the unit by connecting it to telephone wires, lightening rods, or gas pipes.

# CONNECTIONS & SETUP

## AUTO LINK

Press the **INPUT** button and then displays the connected external equipment list on the screen.

Press the **ENTER** button to change the main input to the active external equipment. Use the **▲** or **▼** button to select the main input source.

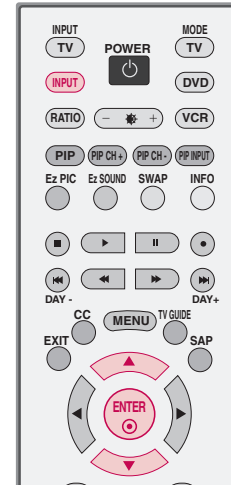
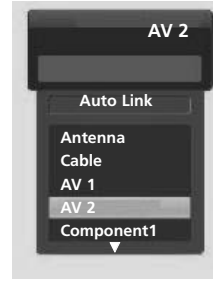

**1** When every external equipment is connected:

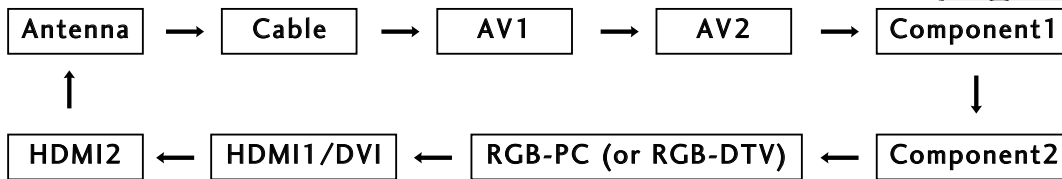

**2** When any external equipment is not connected:

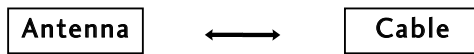

**3** When some External Equipment is connected:  
(ex: When connected to AV 2)

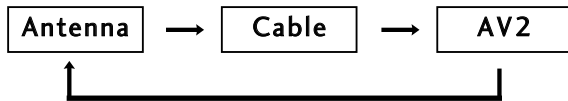

■ You can also select **Main Input** in the **SETUP** menu.

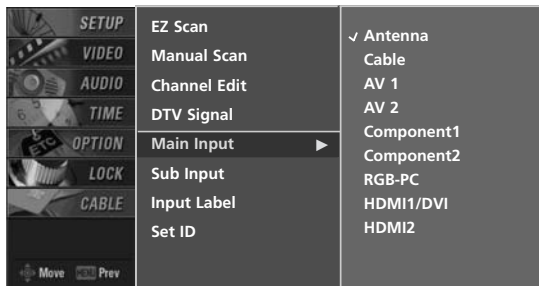

- **Antenna:** Select it when watching the TV/DTV.
- **Cable:** Select it when watching the CATV/CADTV.
- **AV 1-2:** Select it when watching the VCR or external equipment.
- **Component 1-2:** Select it when using the DVD or the Digital set-top box depend on connector.
- **RGB-PC/RGB-DTV:** Select it when using PC or Digital set-top box depend on connector.
- **HDMI1/DVI, HDMI2:** Select it when using DVD, PC or Digital set-top box depend on connector.

# CONNECTIONS & SETUP

## ANTENNA OR CABLE CONNECTION

### 1. Antenna (analog or digital)

Wall Antenna Socket or Outdoor Antenna without a Cable Box Connections.  
For optimum picture quality, adjust antenna direction if needed.

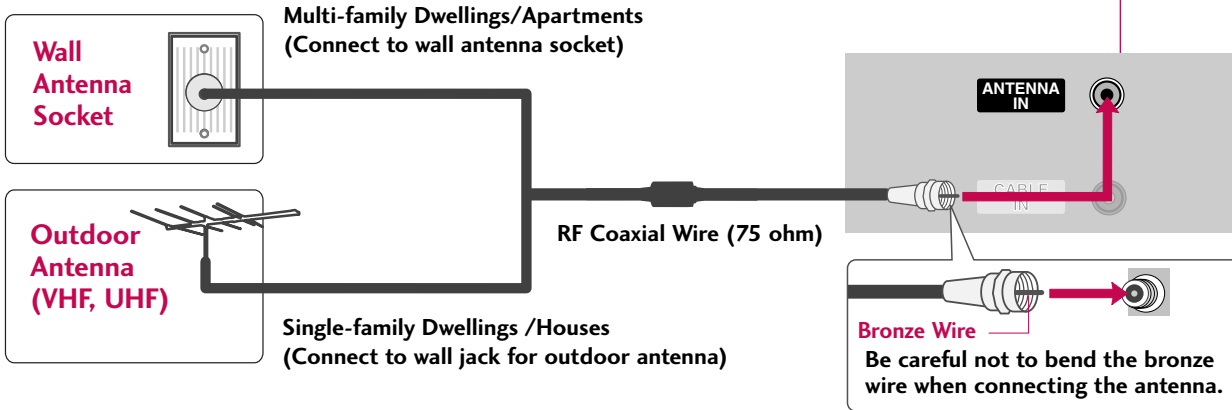
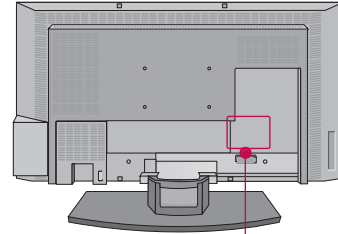

### 2. Cable

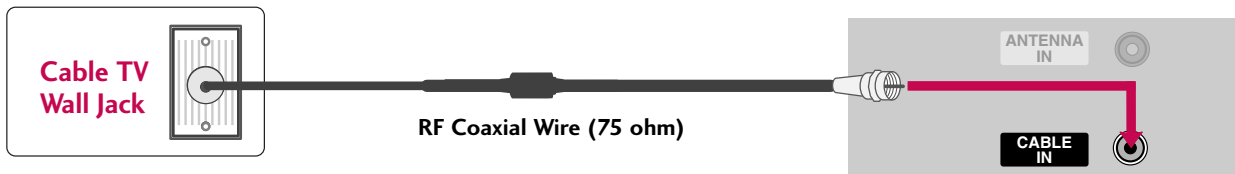

### 3. Using both Cable and Antenna

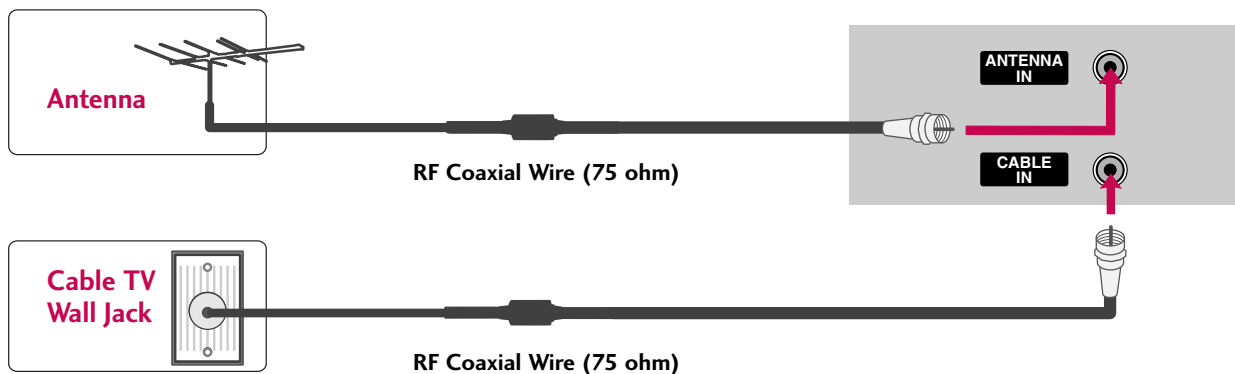

CONNECTIONS & SETUP

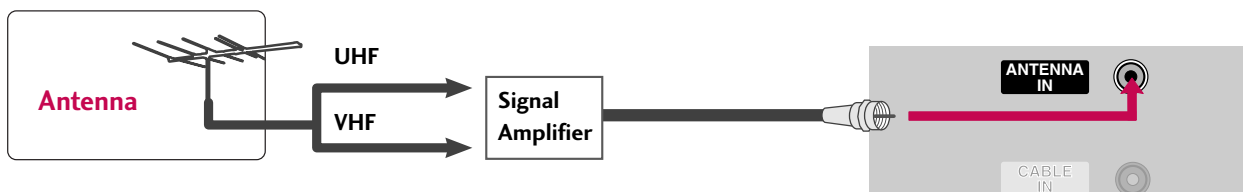

- To improve the picture quality in a poor signal area, please purchase a signal amplifier and install properly.
- If the antenna needs to be split for two TV's, install a 2-Way Signal Splitter.
- If the antenna is not installed properly, contact your dealer for assistance.

#### ! NOTE

- ▶ The TV will let you know when the analog, cable, and digital channel scans are complete.

# CONNECTIONS & SETUP

## CABLECARD™ SETUP

### 1. How to use

Insert the CableCARD™ from your cable service provider into the CableCARD™ slot on the back of your TV. If pairing information about this TV and the CableCARD is displayed on the screen, contact your cable service provider.

#### ! NOTE

- ▶ This TV supports CableCARD™ technology from Motorola, Scientific Atlanta, and SCM.

#### ! CAUTION

- ▶ When removing, do not drop it as this may cause damage to the CableCARD™.

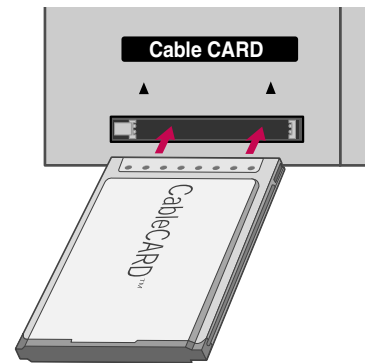

## HDSTB SETUP

This TV can receive Digital Over-the-air/Cable signals without an external digital set-top box. However, if you do receive digital signals from a digital set-top box or other digital external device, refer to the figure as shown below.

This TV supports HDCP (High-bandwidth Digital Contents Protection) protocol for Digital Contents (480p,720p,1080i).

### When connecting Component cable

#### 1. How to connect

- 1 Connect the video outputs (Y, PB, PR) of the digital set top box to the **COMPONENT IN VIDEO 1** jacks on the set. Match the jack colors (Y = green, PB = blue, and PR = red).
- 2 Connect the audio output of the digital set-top box to the **COMPONENT IN AUDIO 1** jacks on the set.

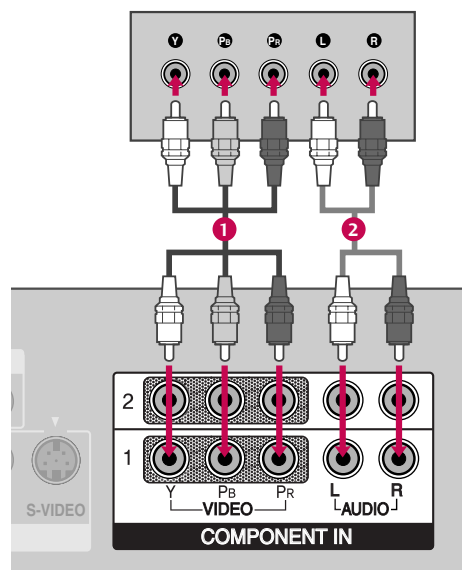

#### 2. How to use

- Turn on the digital set-top box.  
(Refer to the owner's manual for the digital set-top box.)
- Select **COMPONENT 1** input source with using the **INPUT** button on the remote control.
- If connected to **COMPONENT IN2** input, select **COMPONENT 2** input source.

Signal	Component 1/2	RGB-DTV	HDMI1/DVI, HDMI2
480i	Yes	No	No
480p	Yes	Yes	Yes
720p	Yes	Yes	Yes
1080i	Yes	Yes	Yes
1080p (@ 24, 30, 60)	24p/30p	24p/30p	Yes

\* In some resolution (1080p), the PIP, Twin Picture, TV Guide, and some other functions are not available.

# CONNECTIONS & SETUP

## When connecting D-sub 15pin cable

### 1. How to connect

- 1 Connect the RGB output of the digital set-top box to the **RGB (PC/DTV)** jack on the set.
- 2 Connect the audio outputs of the set-top box to the **AUDIO (RGB/DVI)** jack on the set.

### 2. How to use

- Turn on the digital set-top box.  
(Refer to the owner's manual for the digital set-top box.)
- Select **RGB-DTV** input source with using the **INPUT** button on the remote control.

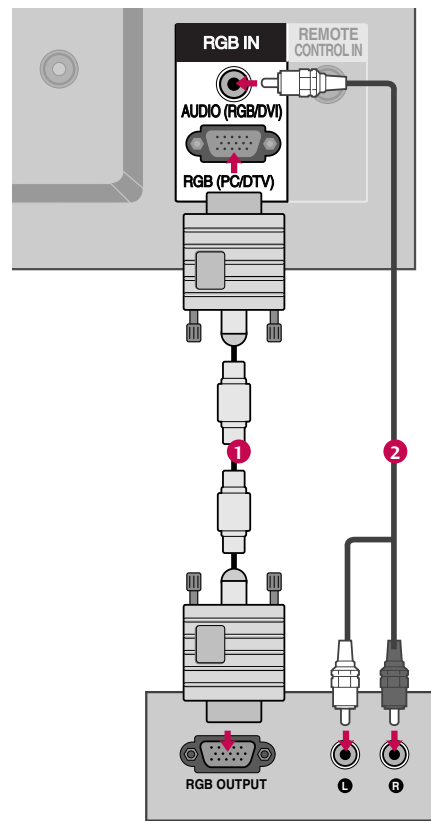

## When connecting HDMI cable

### 1. How to connect

- 1 Connect the digital set-top box to **HDMI IN 1 (DVI)** or **2** jack on the set.
- 2 No separated audio connection is necessary.

### 2. How to use

- Turn on the digital set-top box.  
(Refer to the owner's manual for the digital set-top box.)
- Select **HDMI1/DVI** or **HDMI2** input source with using the **INPUT** button on the remote control.

#### NOTE

- ▶ If the digital set-top box supports Auto HDMI function, the output resolution of the source device will be automatically set to 1280x720p.
- ▶ If the digital set-top box player does not support Auto HDMI, you need to set the output resolution appropriately.  
To get the best picture quality, adjust the output resolution of the source device to 1280x720p.

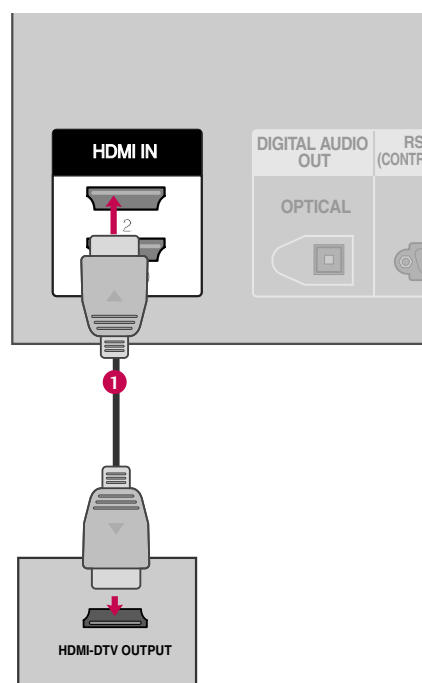

## When connecting HDMI to DVI cable

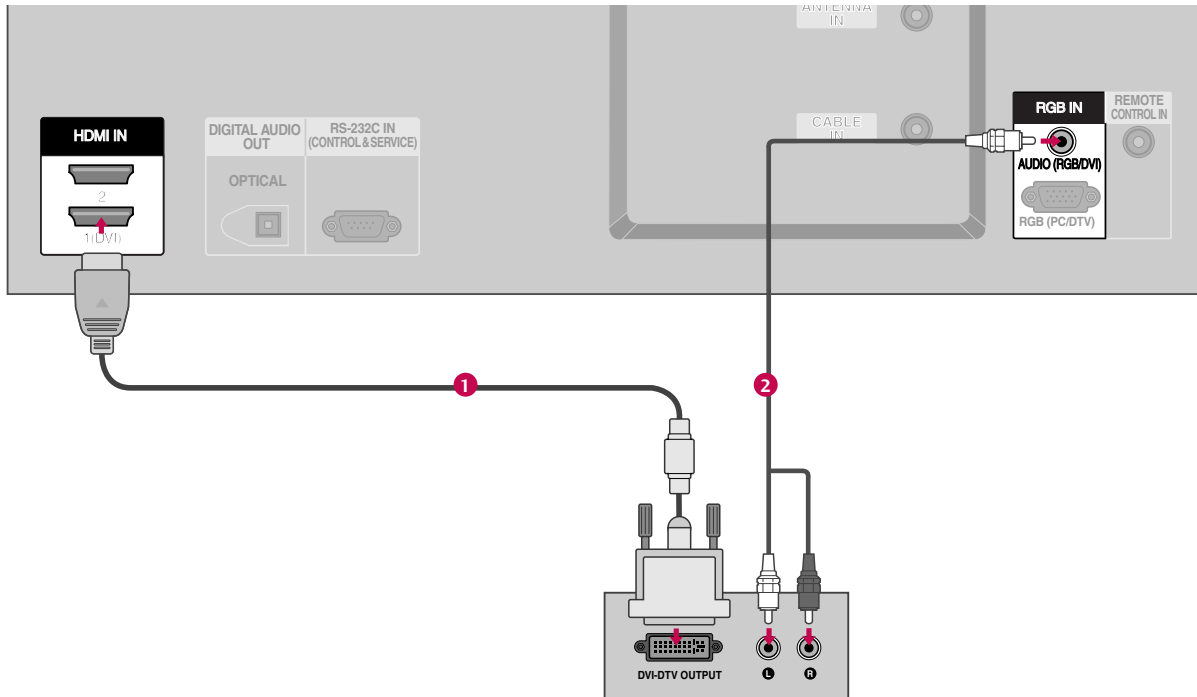

### 1. How to connect

- 1 Connect the DVI output of the digital set-top box to the **HDMI IN 1 (DVI)** jack on the set.
- 2 Connect the audio output of the digital set-top box to the **AUDIO (RGB/DVI)** jack on the set.

### 2. How to use

- Turn on the digital set-top box. (Refer to the owner's manual for the digital set-top box.)
- Select **HDMI1/DVI** input source with using the **INPUT** button on the remote control.

# CONNECTIONS & SETUP

## VCR SETUP

- To avoid picture noise (interference), leave an adequate distance between the VCR and TV
- If a fixed image is displayed on the screen for a long time, the image may become imprinted on the screen and remain visible. This phenomenon is common to all manufactures and in consequence the manufactures warranty does not cover the product bearing this phenomenon.

### When connecting with an antenna

CONNECTIONS & SETUP

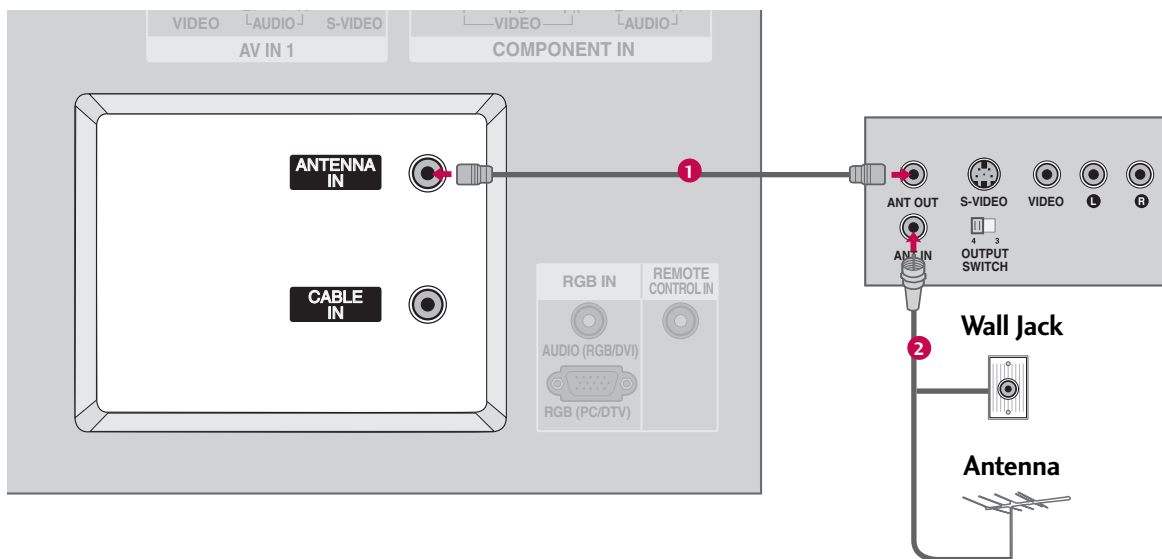

### 1. How to connect

- 1 Connect the RF antenna out socket of the VCR to the **Antenna** socket on the set.
- 2 Connect the antenna cable to the RF antenna in socket of the VCR.

### 2. How to use

- Set VCR output switch to 3 or 4 and then tune TV to the same channel number.
- Insert a video tape into the VCR and press PLAY on the VCR. (Refer to the VCR owner's manual.)

## When connecting with a RCA cable

### 1. How to connect

- 1 Connect the **AUDIO/VIDEO** jacks between TV and VCR. Match the jack colors (Video = yellow, Audio Left = white, and Audio Right = red)

### 2. How to use

- Insert a video tape into the VCR and press PLAY on the VCR. (Refer to the VCR owner's manual.)
- Select **AV1** input source with using the **INPUT** button on the remote control.
- If connected to **AV IN2**, select **AV2** input source.

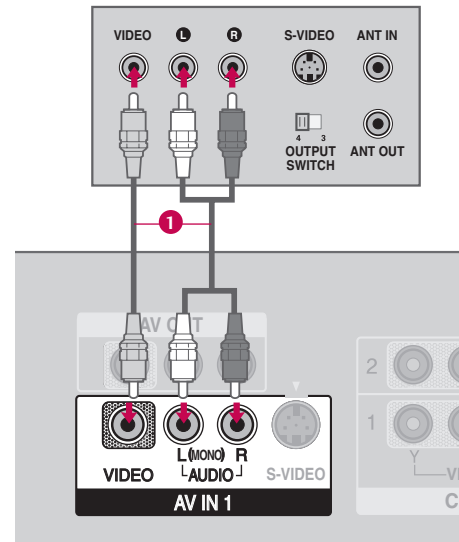

#### NOTE

- ▶ If you have a mono VCR, connect the audio cable from the VCR to the **AUDIO L/MONO** jack of the set.

## When connecting with an S-Video cable

### 1. How to connect

- 1 Connect the **S-VIDEO** output of the VCR to the **S-VIDEO** input on the set.
- 2 Connect the audio outputs of the VCR to the **AUDIO** input jacks on the set.

### 2. How to use

- Insert a video tape into the VCR and press PLAY on the VCR. (Refer to the VCR owner's manual.)
- Select **AV1** input source with using the **INPUT** button on the remote control.
- If connected to **AV IN2**, select **AV2** input source.

#### NOTE

- ▶ The picture quality is improved: compared to normal composite (RCA cable) input.

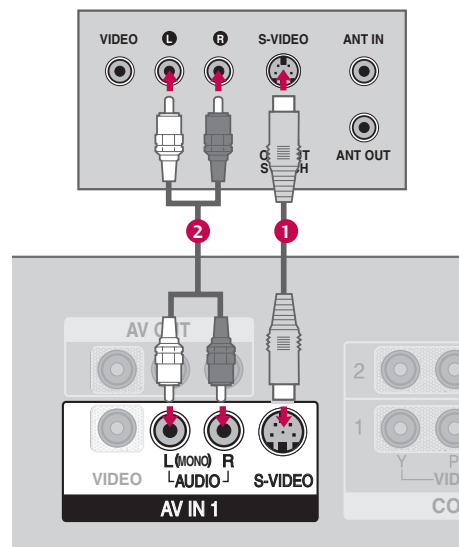

#### CAUTION

- ▶ Do not connect to both Video and S-Video at the same time. In the event that you connect both Video and the S-Video cables, only the S-Video will work.

# CONNECTIONS & SETUP

## AV OUT SETUP

The TV has a special signal output capability which allows you to hook up the second TV or monitor.

### 1. How to connect

- 1 Connect the second TV or monitor to the TV's **AV OUT** jacks.
- 2 See the Operating Manual of the second TV or monitor for further details regarding that device's input settings.

#### NOTE

- ▶ Component1-2, RGB-PC/RGB-DTV, HDMI1/DVI, HDMI2, DTV input sources cannot be used for AV out.
- ▶ We recommend to use the AV OUT jacks for VCR recording.

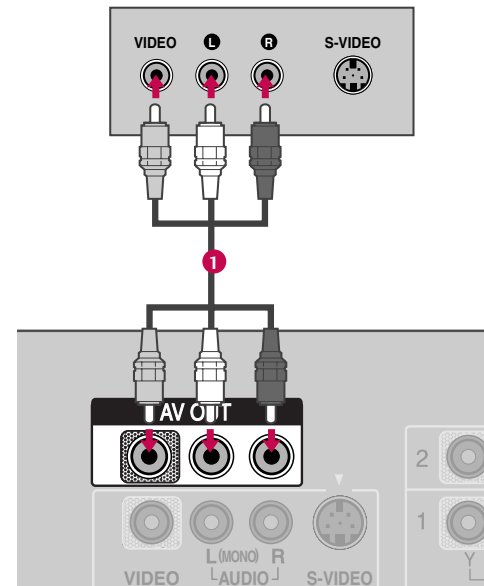

## DIGITAL AUDIO OUTPUT

Send the TV's audio to external audio equipment via the Digital Audio Output (Optical) port.

### 1. How to connect

- 1 Connect one end of an optical cable to the TV Digital Audio (Optical) Output port.
- 2 Connect the other end of the optical cable to the digital audio (optical) input on the audio equipment.
- 3 Set the "TV Speaker option - Off" in the AUDIO menu. (▶ p.84). See the external audio equipment instruction manual for operation.

#### ! NOTE

- ▶ When connecting with external audio equipments, such as amplifiers or speakers, please turn the TV speakers off. (▶ p.84)

#### ⚠ CAUTION

- ▶ Do not look into the optical output port. Looking at the laser beam may damage your vision.

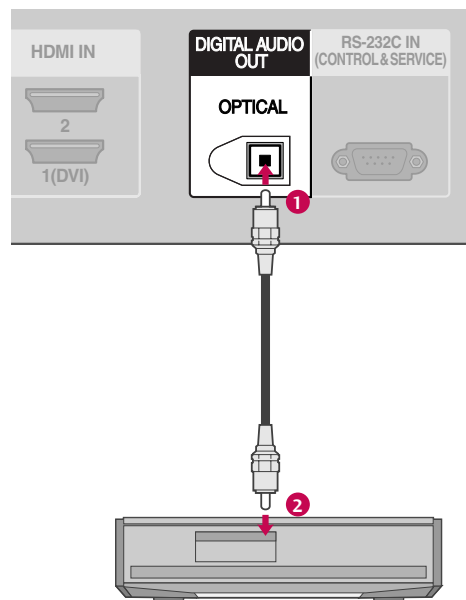

# CONNECTIONS & SETUP

## EXTERNAL A/V SOURCE SETUP

### 1. How to connect

- 1 Connect the **AUDIO/VIDEO** jacks between TV and external equipment. Match the jack colors.  
(Video = yellow, Audio Left = white, and Audio Right = red)

### 2. How to use

- Select **AV1** input source with using the **INPUT** button on the remote control.
- If connected to **AV IN2** input, select **AV2** input source.
- Operate the corresponding external equipment.

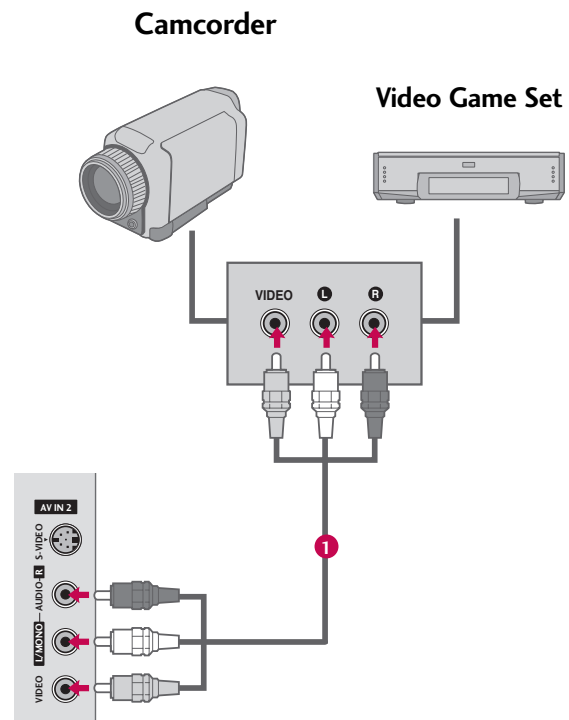

# DVD SETUP

## When connecting Component cable

### 1. How to connect

- 1 Connect the video outputs (Y, PB, PR) of the DVD to the **COMPONENT IN VIDEO1** jacks on the set. Match the jack colors (Y = green, PB = blue, and PR = red).
- 2 Connect the audio outputs of the DVD to the **COMPONENT IN AUDIO1** jacks on the set.

### 2. How to use

- Turn on the DVD player, insert a DVD.
- Select **COMPONENT 1** input source with using the **INPUT** button on the remote control.
- If connected to **COMPONENT IN 2** input, select **COMPONENT 2** input source.
- Refer to the DVD player's manual for operating instructions.

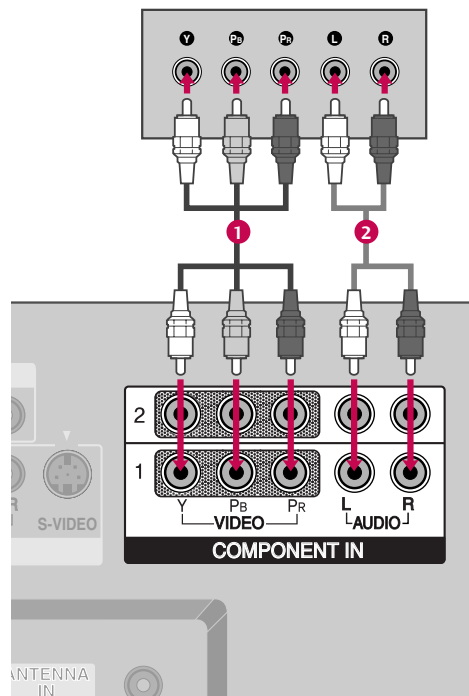

### Component Input ports

To get better picture quality, connect a DVD player to the component input ports as shown below.

Component ports on the TV	Y	P <sub>B</sub>	P <sub>R</sub>
Video output ports on DVD player	Y	P <sub>B</sub>	P <sub>R</sub>
	Y	B-Y	R-Y
	Y	C <sub>b</sub>	C <sub>r</sub>
	Y	P <sub>b</sub>	P <sub>r</sub>

# CONNECTIONS & SETUP

## When connecting with an S-Video cable

### 1. How to connect

- 1 Connect the S-VIDEO output of the DVD to the S-VIDEO input on the set.
- 2 Connect the audio outputs of the DVD to the AUDIO input jacks on the set.

### 2. How to use

- Turn on the DVD player, insert a DVD.
- Select **AV1** input source with using the **INPUT** button on the remote control.
- If connected to **AV IN2**, select **AV2** input source.
- Refer to the DVD player's manual for operating instructions.

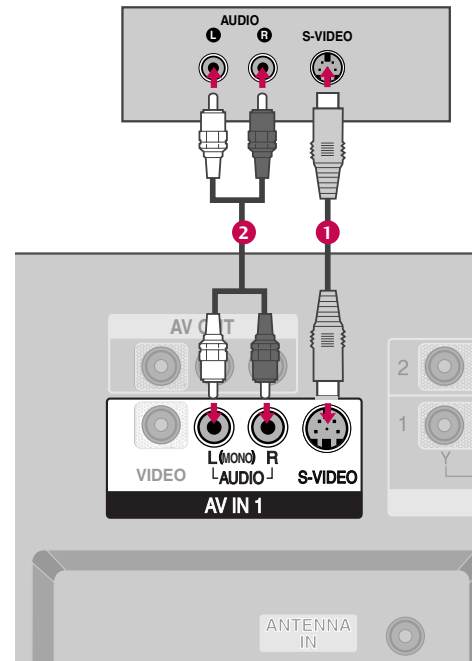

## When connecting HDMI cable

### 1. How to connect

- 1 Connect the HDMI output of the DVD to the HDMI IN 1 (DVI) or 2 jack on the set.
- 2 No separated audio connection is necessary.

### 2. How to use

- Select **HDMI1/DVI** or **HDMI2** input source with using the **INPUT** button on the remote control.
- Refer to the DVD player's manual for operating instructions.

#### NOTE

- ▶ If the DVD supports Auto HDMI function, the DVD output resolution will be automatically set to 1280x720p.
  - ▶ If the DVD does not support Auto HDMI, you need to set the output resolution appropriately.
- To get the best picture quality, adjust the output resolution of the DVD to 1280x720p.

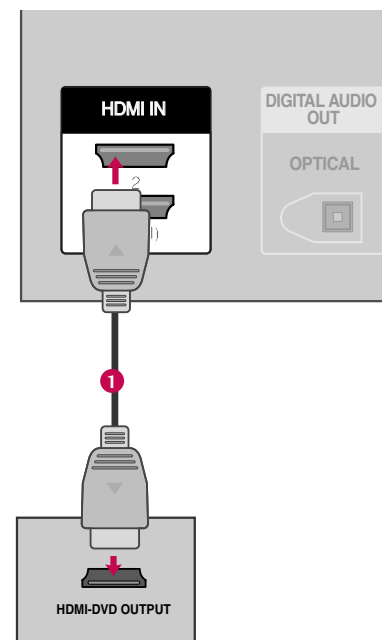

## PC SETUP

This TV provides Plug and Play capability, meaning that the PC adjusts automatically to the TV's settings. The TV perceives 640x480, 60Hz as DTV 480p based on the PC graphic card. If necessary, change the screen scanning rate for the graphic card accordingly.

### When connecting D-sub 15pin cable

#### 1. How to connect

- 1 Connect the RGB output of the PC to the **RGB (PC/DTV)** jack on the set.
- 2 Connect the PC audio output to the **AUDIO (RGB/DVI)** jack on the set.

#### 2. How to use

- Turn on the PC and the set.
- Select **RGB-PC** input source in main input option of **SETUP** menu. (▶ p.67)
- Once you select **RGB-PC** in main input option of **SETUP** menu, **INPUT** button is also available for this purpose.

#### ! NOTE

- ▶ Check the image on your TV. There may be noise associated with the resolution, vertical pattern, contrast or brightness in PC mode. If noise is present, change the PC output to another resolution, change the refresh rate to another rate or adjust the brightness and contrast on the **VIDEO** menu until the picture is clear. If the refresh rate of the PC graphic card can not be changed, change the PC graphic card or consult the manufacturer of the PC graphic card.

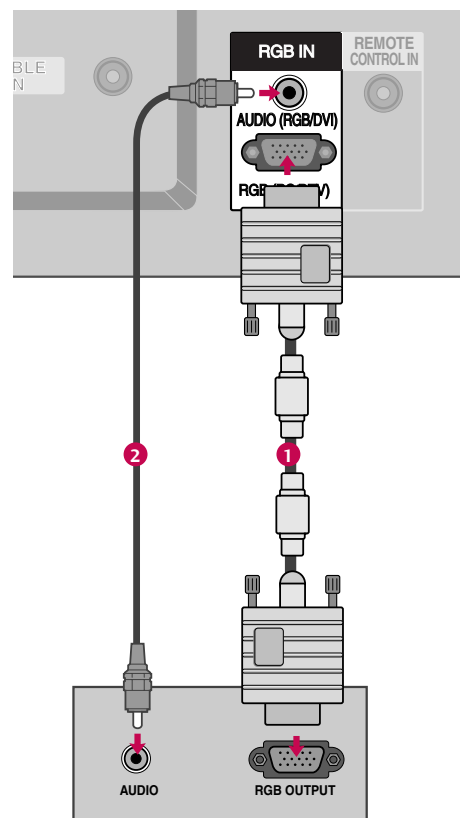

# CONNECTIONS & SETUP

## When connecting HDMI to DVI cable

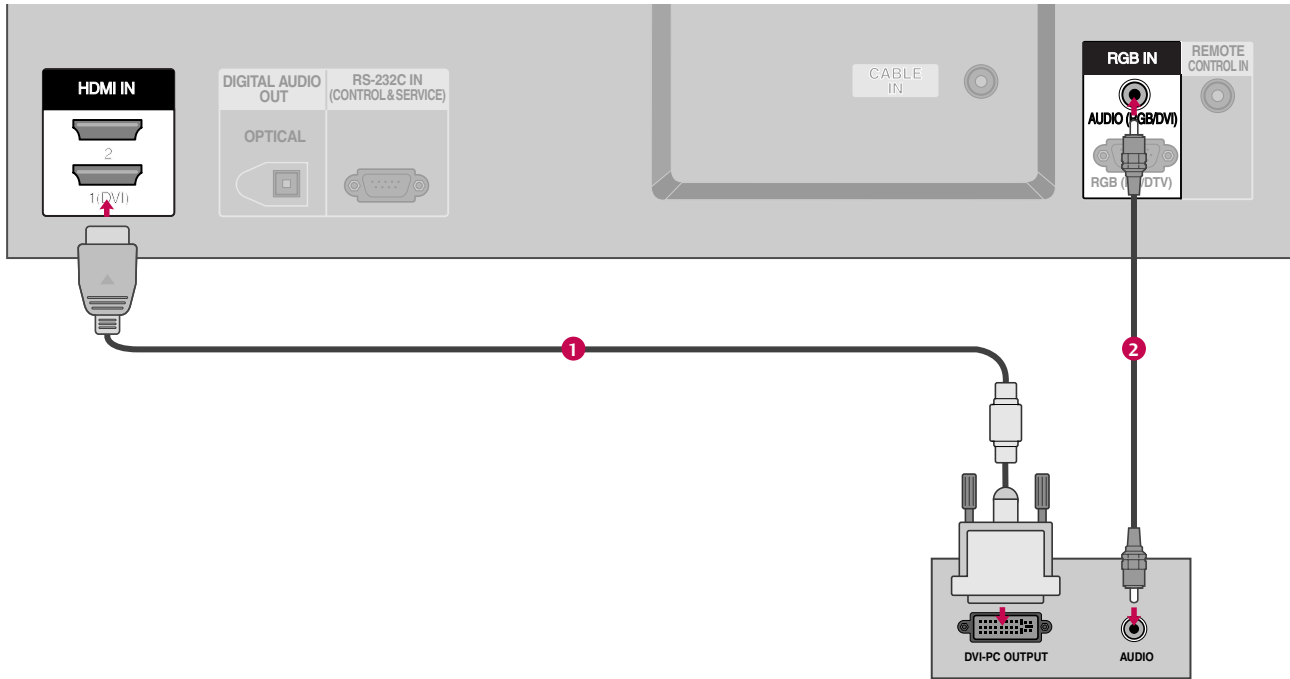

### 1. How to connect

- 1 Connect the DVI output of the PC to the **HDMI IN 1 (DVI)** jack on the set.
- 2 Connect the PC audio output to the **AUDIO (RGB/DVI)** jack on the set.

### 2. How to use

- Turn on the PC and the set
- Select **HDMI1/DVI** input source with using the **INPUT** button on the remote control.

#### ! NOTE

- ▶ HDMI2 source does not support DVI source.
- ▶ If the PC has a DVI output and no HDMI output, a separated audio connection is necessary.
- ▶ If the PC does not support Auto DVI, you need to set the output resolution appropriately. To get the best picture quality, adjust the output resolution of PC graphics card's output resolution to 1024x768, 60Hz.

## NOTES

- ▶ To get the best picture quality, adjust the RGB-PC to 1360x768, 60Hz.
- ▶ To get the best picture quality, adjust the HDMI to 1920x1080, 60Hz.
- ▶ Depending on the graphics card, DOS mode may not work if a HDMI to DVI Cable is in use.
- ▶ When Source Devices are connected with HDMI/DVI Input, the output PC Resolution (VGA, SVGA, XGA), Position and Size may not fit on the Screen. As shown in the picture, press the ADJUST button to adjust the screen Position of the TV SET and contact a PC graphics card service center.
- ▶ When Source Devices connected with HDMI/DVI Input, output TV SET Resolution (480p, 720p, 1080i) and TV SET Display fit EIA/CEA-861-B Specification to Screen. If not, refer to the Manual of HDMI/DVI Source Devices or contact your service center.
- ▶ If the HDMI/DVI Source Device is not connected to the Cable or if there is a poor cable connection, "No signal" is displayed in the HDMI/DVI Input. In this case, that Video Resolution is not supported. If "Invalid Format" is displayed, refer to the Source Device manual or contact your service center.
- ▶ Avoid keeping a fixed image on the screen for a long period of time. The fixed image may become permanently imprinted on the screen.
- ▶ The synchronization input form for Horizontal and Vertical frequencies is separate.
- ▶ If you select HDMI1/DVI, HDMI2 input source in main input option of SETUP menu and set HDMI-PC 1920 x 1080 in your PC format, you can get best picture quality with matching 1:1 pixel.

### Supported Display Specifications (RGB/HDMI-PC)

Resolution	Horizontal Frequency(KHz)	Vertical Frequency(Hz)
640x350	31.468	70.09
720x400	31.469	70.08
640x480	31.469	59.94
	37.861	72.80
	37.500	75.00
800x600	35.156	56.25
	37.879	60.31
	48.077	72.18
	46.875	75.00
1024x768	48.363	60.00
	56.476	70.06
	60.023	75.02
1280x768	47.776	59.870
1360x768	47.720	59.799
1920x1080	67.500	60.00

\* RGB-PC mode only: 640x350, 720x400

\* HDMI-PC mode only: 1280x768, 1920x1080

### Supported Display Specifications (RGB/HDMI-DTV)

Resolution	Horizontal Frequency(KHz)	Vertical Frequency(Hz)
720x480	31.47	60
	31.47	59.94
1280x720	45.00	60.00
	44.96	59.94
1920x1080	33.75	60.00
	33.72	59.94

# CONNECTIONS & SETUP

## Screen Setup for PC mode

### Overview

When RGB connect to PC output and select the RGB-PC in Main Input, this function is used.

When HDMI IN 1 (DVI) connect to PC output and select HDMI1/DVI input, this function is used.

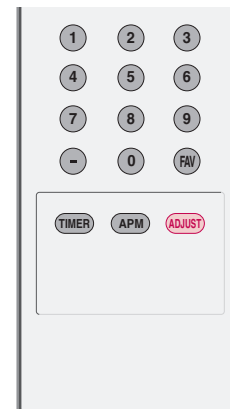

### Adjustment for screen Position, Size, Phase, Reset

- 1 Press the **ADJUST** button and then use ▲ or ▼ button to select **Position**, **Size**, or **Phase**.
- 2 Press the **ENTER** button and then use ▲ ▼ ◀ ▶ button to make appropriate adjustments.
  - The **Phase** adjustment range is **-16 ~ +16**.  
In HDMI-PC/RGB-DTV mode, Phase is not available.
  - The **Size** adjustment range is **-30 ~ +30**.  
In HDMI-PC/RGB-DTV mode, Size is not available.
- 3 Press the **ENTER** button.

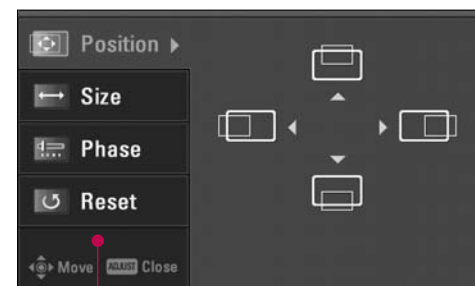

- 1
  - 2
  - 3
- Position** This function is to adjust picture to left/right and up/down as you prefer.
- Size** This function is to minimize any vertical bars or stripes visible on the screen background. And the horizontal screen size will also change.
- Phase** This function allows you to remove any horizontal noise and clear or sharpen the image of characters.

### Initializing (Reset to original factory values)

To initialize the adjusted values

- 1 Press the **ADJUST** button and then use ▲ or ▼ button to select **Reset**.
- 2 Press the **ENTER** button and then use ◀ or ▶ button to select **Yes**.
- 3 Press the **ENTER** button.



- 1
- 2
- 3

# BASIC OPERATION

## TURNING THE TV ON

- 1** First, connect power cord correctly.  
At this moment, the TV switches to standby mode.

  - In standby mode, press the **⏻/|**, **INPUT**, **CH (▲ or ▼)** button on the TV or press the **POWER**, **INPUT**, **TV INPUT**, **CH(+ or-)**, **Number (0~9)** button on the remote control.
- 2** Select the viewing source by using the **INPUT** button on the remote control.

  - This TV is programmed to remember which mode it was last set to, even if you turn the TV off.
- 3** When finished using the TV, press the **POWER** button on the remote control. The TV reverts to standby mode.

### ! NOTE

- ▶ If you intend to be away on vacation, disconnect the power plug from the wall power outlet.
- ▶ After turning on the TV, it could take up to a week for the TV Guide On Screen system to receive full listings data.
- ▶ When the TV is turned on, the indicator will blink white before the picture is seen.

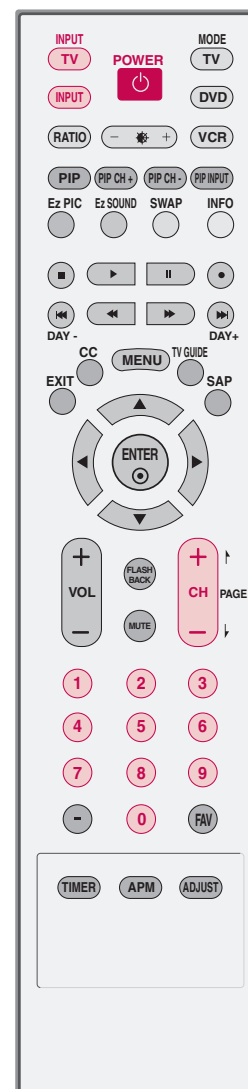

# BASIC OPERATION

## ON-SCREEN MENUS LANGUAGE SELECTION

The menus can be shown on the screen in the selected language.  
First select your language.

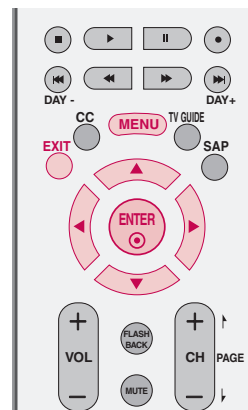

**1** Press the **MENU** button and then use ▲ or ▼ button to select the **OPTION** menu.

**2** Press the ► button and then use ▲ or ▼ button to select **Language**.

**3** Press the ► button and then use ▲ or ▼ button to select your desired language.  
From this point on, the on-screen menus will be shown in the selected language.

**4** Press the **EXIT** button to return to TV viewing or press **MENU** to return to the previous menu.

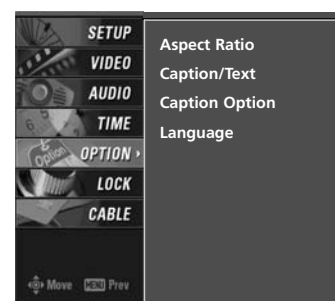

**1**

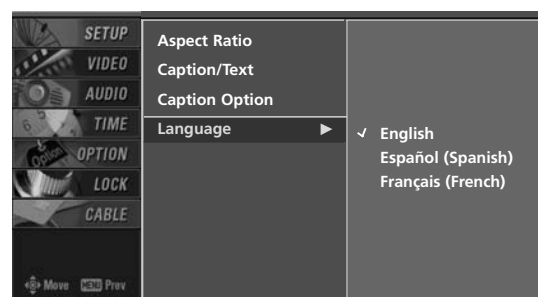

**2 3**

# INITIAL CHANNEL SEARCH (EZ SCAN)

This feature automatically finds all channels available through the antenna or cable input and stores them in memory on the channel list.

Run EZ Scan again after any Antenna/Cable connection changes.

Note: A password is required to gain access to EZ Scan menu if the Lock System is turned on.

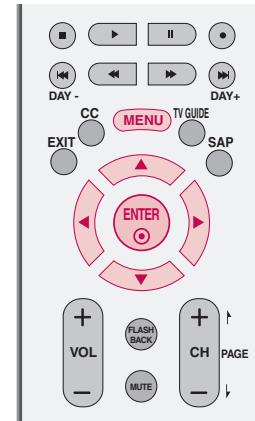

- 1 Press the **MENU** button and then use **▲** or **▼** button to select the **SETUP** menu.

---

- 2 Press the **▶** button and then use **▲** or **▼** button to select **EZ Scan**.

---

- 3 Press the **ENTER** button to begin the channel search. Allow EZ Scan to complete the channel search cycle for ANTENNA and CABLE.

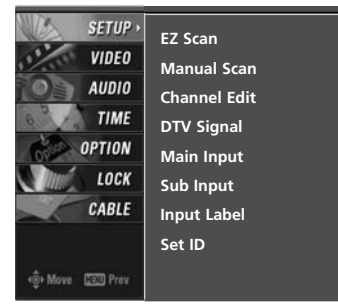

1

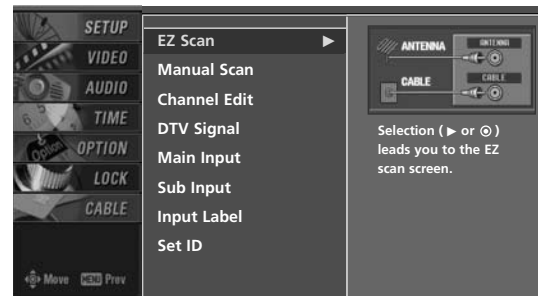

2

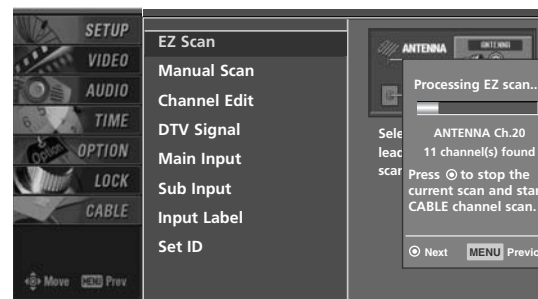

3

# BASIC OPERATION

## CHANNEL SELECTION

- 1 Press the **CH +/-** or **NUMBER** buttons to select a channel number.

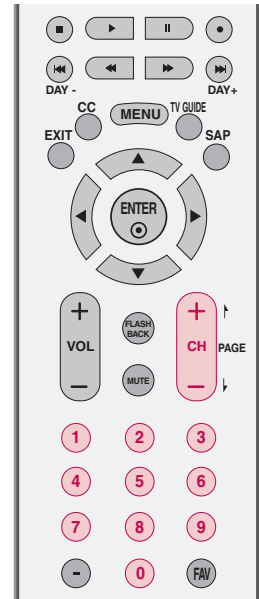

## VOLUME ADJUSTMENT

Adjust the volume to suit your personal preference.

- 1 Press the **VOL +/-** button to adjust the volume.
- 2 If you want to switch the sound off, press the **MUTE** button.
- 3 You can cancel the Mute function by pressing the **MUTE** or **VOL +/-** button.

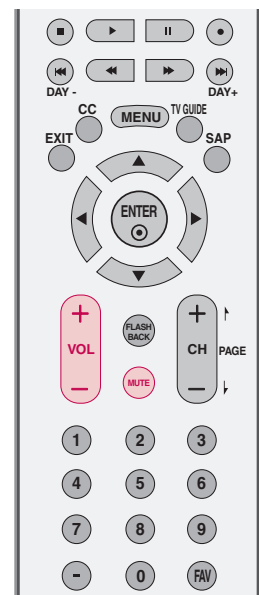

# TV GUIDE ON SCREEN™ SYSTEM

## TV GUIDE ON SCREEN SETUP

The TV Guide On Screen system uses Setup information to provide you with show listings and lineups in your area—which are updated several times a day.

Once you set up the TV according to manufacturer's instructions, you are ready to set up the TV Guide On Screen system.

### NOTE

- ▶ The TV Guide On Screen system provides listings for cable-ready, and digital cable services as well as over-the-air broadcast. It does not provide listings for satellite services.

## Ready to setup

### 1 Welcome Screen

The TV Guide On Screen system's Welcome Screen appears:

- By pressing the **TV GUIDE** button
- When you power On your TV if you previously skipped "Set up TV Guide On Screen now" on the Reminder Screen.

The Welcome Screen highlights features of the TV Guide On Screen system.

Press the **ENTER** button to begin Setup.



1

### 2 Reminder Screen

The TV Guide On Screen system's Reminder Screen appears:

- After initial TV set up.
- If you power Off the TV and then power it back On.

To make a selection, use the ▲ or ▼ button to highlight an option, and press the **ENTER** button.

- "Set up TV Guide On Screen now", displays the Welcome Screen. Press the **ENTER** button to begin Setup.
- "Remind me to set up later" returns you to watching TV.
- "Don't remind me again" returns you to watching TV and stops the reminder screen from appearing upon power On.

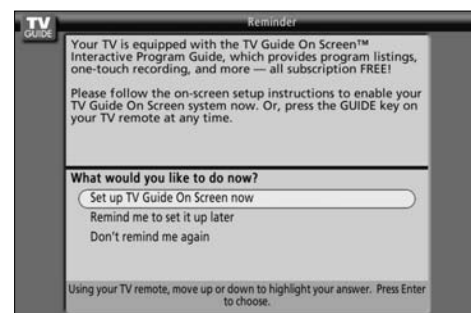

2

# TV GUIDE ON SCREEN™ SYSTEM

## Using TV Guide

### 1 Screen 1: Country

- This screen asks you the location of your TV.
- Use the ▲ or ▼ button to highlight a country.
- Press the **ENTER** button to display Screen 2.

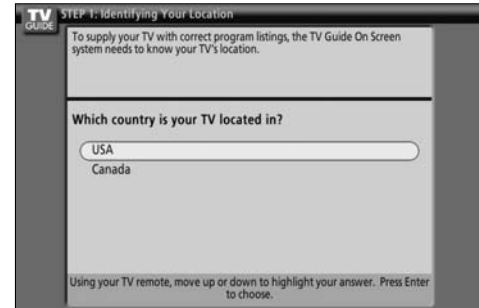

### 2 Screen 2: Enter ZIP or Postal Code

#### Option 1

- If you selected USA in Screen 1, you see the ZIP Code screen.
- You input numbers by either pressing the number keys on the remote or using the ▲ or ▼ button to display a number, and then the ◀ or ▶ button to move to another field.
- Press the **ENTER** button to display Screen 3.



#### Option 2

- If you selected Canada in Screen 1, you see the Postal Code screen.
- You input characters by using the ▲ or ▼ button, and then the ◀ or ▶ button to move to another field.
- Press the **ENTER** button to display Screen 3.



### 3 Screen 3: Do you have Cable Service connected?

- If you select Yes, you see Screen 4.
- If you select No, you see Screen 4.

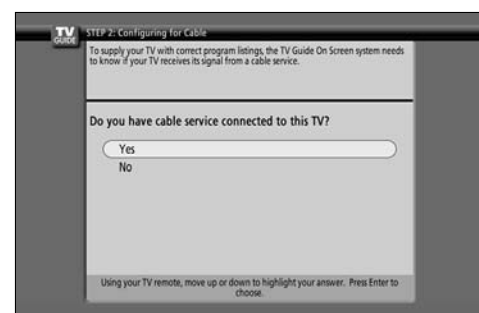

#### 4 Screen 4: Do you have an antenna connected?

- If you select Yes, you see Screen 5.
- If you select No, you see Screen 5.

#### ! NOTE

- ▶ If you selected No in Screen 3 then you must select Yes in this screen to receive a channel lineup and listings.

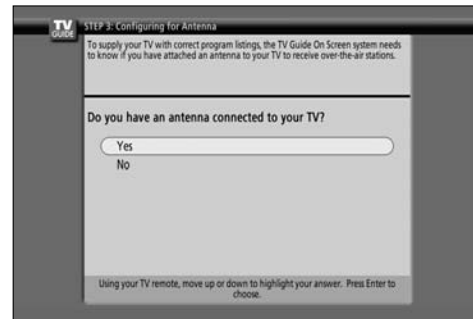

4

#### 5 Screen 5: Are your basic settings correct?

- If you select Yes, you see Screen 6.
- If you select No, you see Screen 1.



5

#### 6 Screen 6: Congratulations

- Press the **ENTER** button to display Screen 7.



6

#### 7 Screen 7: Helpful Information

- This screen tells you valuable information on using your Guide.
- Press the **ENTER** button to watch TV.

#### ! NOTE

- ▶ The TV Guide On Screen system receives program listings data through your cable or over-the-air video signal. In order to receive regular program listings, please remember to do the following:
  1. Turn OFF your TV when it is not in use. (Do not unplug the power cord.)
  2. If you have more than one Cable system in your area, you may be prompted to select which Cable system's program data to download. If so prompted, please follow the on-screen instructions.
- ▶ Program listings are updated several times a day. It may take up to 24 hours to begin to receive any TV program listings. It may take up to one week to receive all eight days of TV program listings.



7

# TV GUIDE ON SCREEN™ SYSTEM

## TV GUIDE ON SCREEN™ FEATURE

### Overview

Your new TV contains the TV Guide On Screen Interactive Program Guide.

The TV Guide On Screen system has features that help you get the most out of your viewing experience.

### TV Guide On Screen Overview

The TV Guide On Screen system has the following features:

- Eight days of show listings (today plus seven days).
- Icons that indicate show rating, stereo, HDTV, new episode, etc.
- Intuitive up/down/left/right navigation using your remote control.
- Schedule show Reminders.
- Search shows by category (e.g., Movies, Sports, Children, etc.).
- Search for shows based on keywords or alphabetically by title.
- Direct tuning to a channel.
- Streamlined System Setup and default setting options.
- Channel lineup customization.
- Help screens while in the TV Guide On Screen system.

## Screen Components

The screens displayed in the TV Guide On Screen system share many of the same components, as shown in the following figure:

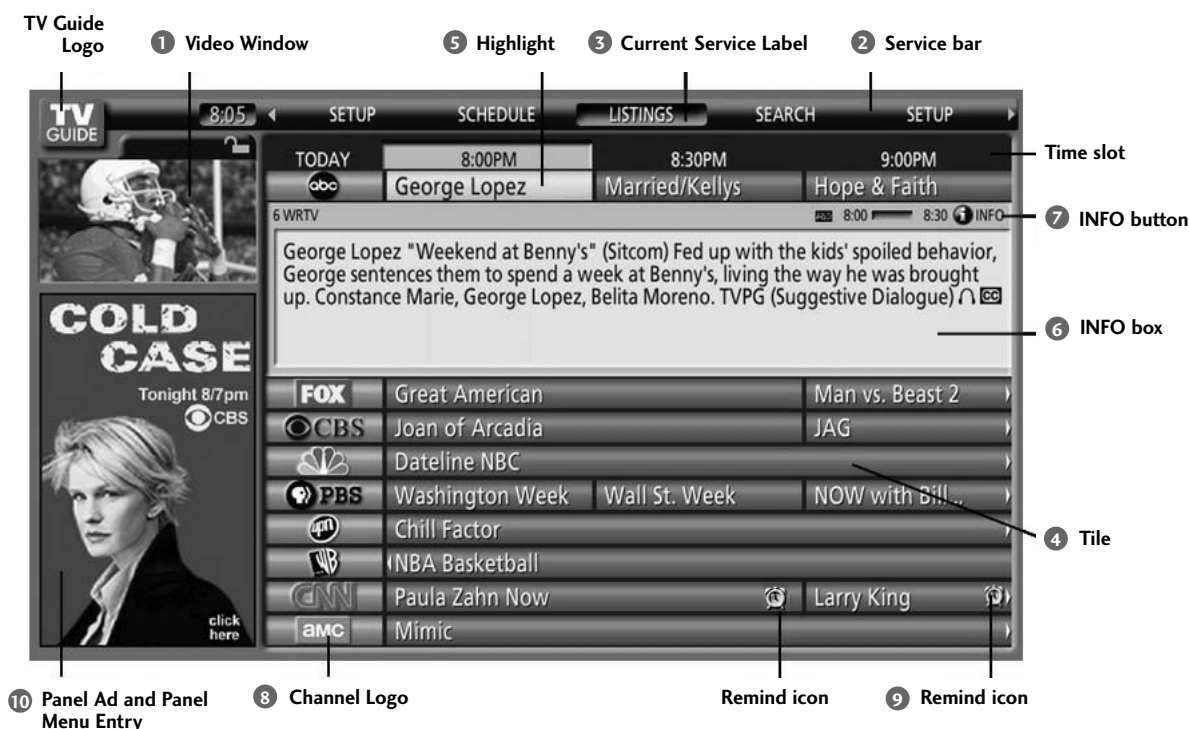

- |   |  |
|---|--|
| <ul style="list-style-type: none"> <li>❶ Video Window - Displays TV video while The TV Guide On Screen system is displayed.</li> <li>❷ Service Bar - Provides access to the 4 main Guide Services.</li> <li>❸ Current Service Label - Indented to indicate current Service displayed.</li> <li>❹ Tile - Displays show title.</li> <li>❺ Highlight - Indicates an active tile.</li> <li>❻ INFO Box - Provides information for a highlighted item.</li> </ul> | <ul style="list-style-type: none"> <li>❼ INFO Button - Indicates you can cycle through the various Info Box sizes.</li> <li>❽ Channel Logo - Identifies network.</li> <li>❾ Remind Icons - Indicates a show is set as a Reminder.</li> <li>❿ Panel Ad - Location where show- or product-specific information appears (and also where Panel Menu appears).</li> </ul> |
|---|--|

# TV GUIDE ON SCREEN™ SYSTEM

## Panel Menu



- A Panel Menu appears when the **MENU** button is pressed on a highlighted tile and additional options are available. It also appears when you press the **ENTER** button on a show starting in the future.
- When a Panel Menu appears, the highlighted tile changes color to indicate the Panel Menu relates to this tile.
- The Panel Menu displays below the Video Window.
- Help is available for a displayed Panel Menu by pressing the **INFO** button.
- The **▲** or **▼** button move between the options within the Panel Menu.
- The left and right arrows move to adjacent options unless the highlight is on an odometer, where these arrows change the odometer choice.
- Pressing the **ENTER** button from an odometer or number entry box moves the highlight to the default command button of that Panel Menu, for example, Schedule Reminder.
- Pressing the **ENTER** button from a highlighted command button executes the action and closes the Panel Menu (e.g., Schedule Reminder, Cancel).
- Select Cancel to cancel any changes and press the **ENTER** button to close the menu.
- Pressing the **MENU** button is a shortcut to Cancel. Press the **MENU** button to cancel any changes and close the menu.
- If a Panel Menu contains more menu options than can be displayed on a single screen, the more **▼** text appears at the bottom of the menu. Simply scroll down to access additional options.

## Main Services

### Listings

Access Listings by pressing the **TV GUIDE** button on your remote or on the front panel of your TV.

Listings is always the first Service displayed in the Guide.

With Listings highlighted, press the **INFO** button to display a Help screen. Press the **INFO** button again to close the screen.

**1** Use the **▲ ▼ ◀ ▶** button to move the highlight within Listings to:

- View 8 days of show listings
- Read show descriptions
- Tune directly to a show currently airing
- Set a show to Remind
- Lock and Unlock the Video Window
- Access Panel and Channel Ads

#### ! NOTE

- ▶ There may be times when the TV Guide On Screen system could display partial or no program listings. The reasons for this include:
  - Program schedule information was not provided to TV Guide On Screen.
  - The transmission of the program listings was interrupted.
  - The phrase “No Listings” will be replaced with program information during the next transmission, which should occur within the next 24 hours.
  - Please remember to turn off your TV when not in use in order to receive program listings.



**1**

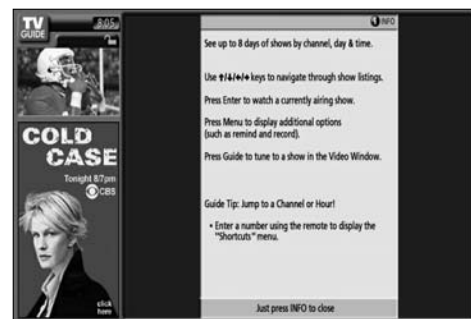

**1**



**1**

# TV GUIDE ON SCREEN™ SYSTEM

## Search

Search lets you find shows alphabetically, by category (Movies, Sports, Children, Educational, News, Variety, Series, HDTV) or by Keyword.

With Search highlighted, press the **INFO** button to display a Help screen. Press the **INFO** button again to close the screen.

### Category Search Example: Movies

- 1 From Search, use the ▼ button to highlight Movies.



1

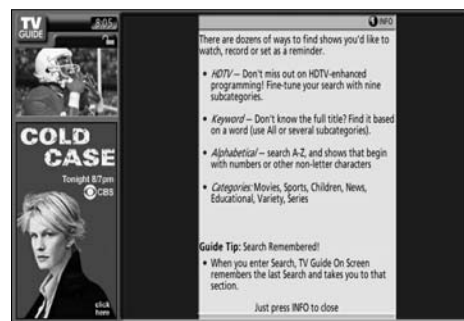

1



1

2 Use the ▼ button to highlight a subcategory (for example, All).

3 Press the ENTER button to display a list of all Movies, organized by date and time.

4 Highlight a show and press the ENTER button to watch (if on now) or the MENU button to display the Episode Options menu.

5 You can choose to set a reminder, or tune to the channel.

- ▶ Go to Service Bar - Closes the menu, changes no information, and returns to the Search Service Bar.
- ▶ Tune to Channel - Exits the Guide and tunes to the channel of the highlighted show (show airs in the future).

**NOTE**

This option reads Watch Now if the show is currently airing.

- ▶ Set Recording - This TV doesn't support recording feature.
- ▶ Set Reminder - Displays the Remind Options menu, from which you can set frequency, when, automatically power On, and auto-tune the TV.
- ▶ Cancel - Closes the menu, changes no information, and returns to the highlighted show.



2 3



4



5

# TV GUIDE ON SCREEN™ SYSTEM

## Keyword Search

Keyword search lets you enter a word(s) to look for a particular show by category or for every show title that matches.

- 1 Highlight the Keyword navigation label, and press the **ENTER** button to display the Keyword Search menu.
- 2 Highlight New Search, and press the **ENTER** button.
- 3 The Search Options menu is displayed.
- 4 Highlight Category, and use the ◀ or ▶ button to select a category to search (e.g. All, HDTV, Children, Sports, etc.). When finished, use the ▼ button to highlight Enter Keyword.
- 5 Highlight Enter Keyword, and press the **ENTER** button. The keyboard is displayed.
- 6 Use the ▲▼◀▶ button to highlight a character, and press the **ENTER** button to display it. When complete, highlight Done and press the **ENTER** button.



1 2



3 4 5



6

- 7** A list of all matching shows for that keyword is displayed.

You can highlight a show, and press the **ENTER** button to display all airings. You can then highlight a specific listing and press the **ENTER** button to watch (if On now) or the **MENU** button to display the Episode Options menu.

From the Episode Options menu, choose to set a reminder, or tune to the channel, as previously described.

The TV Guide On Screen system stores all the keywords you create. To edit or delete a keyword, highlight the keyword and press the **MENU** button. A Search Options menu is displayed.

- ▶ Go to Service Bar - Closes the menu, changes no information, and returns to the Search Service Bar.
- ▶ Edit Search - Displays the keyboard, where you can change the keyword.
- ▶ Delete Search - A Confirm menu is displayed.
  - Yes - Deletes the Search.
  - No - Closes the panel menu.
- ▶ Cancel - Closes the menu, changes no information, and returns to the highlighted show.



# TV GUIDE ON SCREEN™ SYSTEM





## Schedule

Schedule lets you review, edit, or delete Remind events that you set previously. See page 55 for information on how to set a reminder.

With Schedule highlighted, press the **INFO** button to display a Help screen. Press the **INFO** button again to close the screen.

An icon identifies the event type:

### Remind

-  Once - Sets a show reminder one time.
-  Regularly - Sets a show reminder every time the show airs on the same channel and starts at the same time.
-  Weekly - Sets a show reminder each time the show airs on the same day of the week, on the same channel and starts at the same time.
-  Off - Keeps the show in the list but will not remind the show until the frequency is changed.



Highlight an event, and press the **MENU** button for options.

- ▶ Go to Service Bar - Closes the menu, changes no information, and returns to the Schedule Service Bar.
- ▶ Tune to channel - Exits the TV Guide On Screen system and tunes to the highlighted show.
- ▶ Set Recording - This TV doesn't support recording feature.
- ▶ Delete Reminder - Removes the reminder from the Schedule after a Confirm screen.
- ▶ Edit Reminder - Opens a menu from which you can change existing reminder information.
- ▶ Cancel - Closes the menu, changes no information, and returns to the highlighted show.

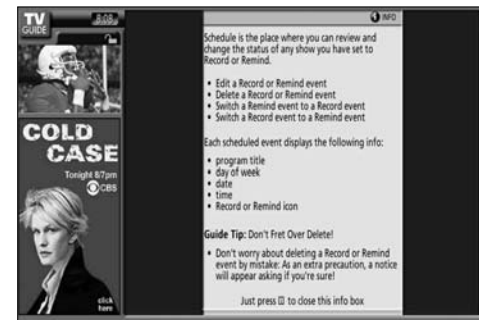

## Setup

After you initially complete Guide Setup, you can make changes to Guide settings in the following areas:

- Change System Settings
- Change Channel Display
- Change Default Options

**1** Highlight a choice, press the **ENTER** button, and follow the on-screen instructions.

**2** With Setup highlighted, press the **INFO** button to display a Help screen. Press the **INFO** button again to close the screen.

## Change System Settings

**3** This option appears after you have completed the initial Guide Setup process.

Press the **ENTER** button to display the Confirming Your Settings screen. You can see your current settings.

**4** Choose one of the options, press the **ENTER** button, and follow the on-screen instructions.



**1**

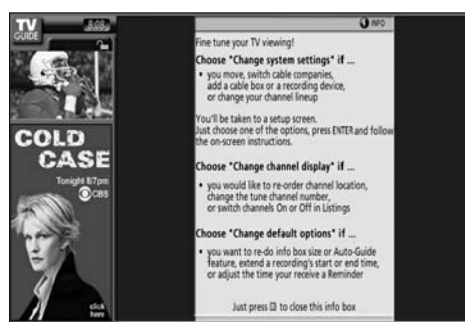

**2**

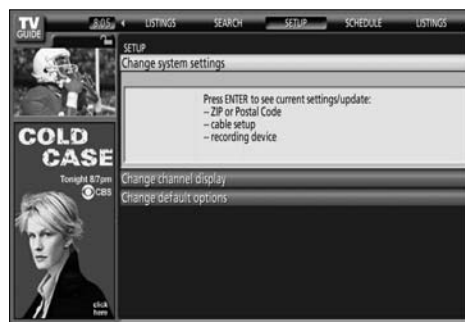

**3**

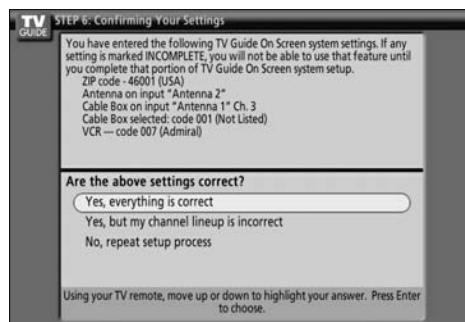

**4**

# TV GUIDE ON SCREEN™ SYSTEM

## Change Channel Display

- 1 Change Channel Display lets you edit channel information that appears in Listings. With Change Channel Display you can :
  - Re-order the position of the channel in Listings.
  - Change the tune channel number.
  - Switch a channel:

- ▶ On - The channel is always displayed.
- ▶ Off - The channel is never displayed.
- ▶ Auto-Hide - The channel is only displayed when program information is available.

- 2 Press the **ENTER** button to display the Channel Editor screen.  
Then, highlight a channel and press the **MENU** button. A Grid Options menu is displayed.  
Highlight Go Back to Setup to close the menu, change no information, and return to the Setup Service Bar.

Or make changes and when finished, press the **ENTER** button to highlight Done. Press the **ENTER** button again to close the menu and accept the changes.

Highlight Cancel to close the menu, change no information, and return to the highlighted channel.

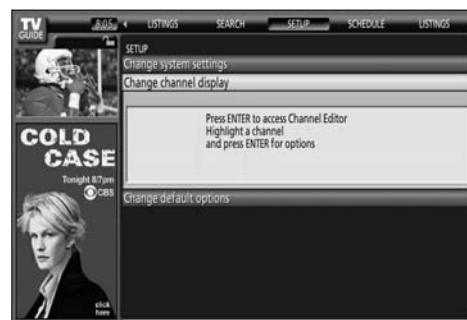

## Change Default Options

Change Default Options lets you change default settings in the following categories:

- General Defaults
- Record Defaults
- Remind Defaults

Highlight Change Default Options, and press the **ENTER** button.

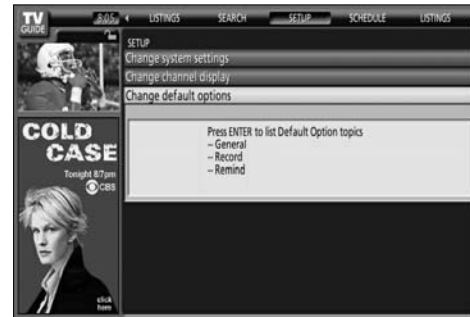

### 1 General Defaults

General Defaults lets you set defaults for the following:

- The initial Info Box size when the TV Guide On Screen system is entered. Choices are No, Small, Large, and Last Used. (Default = Last Used)
- The Info Box size rotation when the **INFO** button is pressed while in the TV Guide On Screen system. Choices are No only, Small only, Large only, No & Small, No & Large, Small & Large, All. (Default = All)
- Automatic entry into the TV Guide On Screen system (Auto-Guide) when the TV is powered On. Choices are On and Off. (Default = Off)

Highlight General Defaults, and press the **MENU** button to display the General Defaults menu.

Highlight Go to Service Bar to close the menu, change no information, and return to the Setup Service Bar.

When finished, press the **ENTER** button to highlight Done. Press the **ENTER** button again to close the menu and accept the changes.

Highlight Cancel to close the menu, change no information, and return to the highlighted option.



1



1

# TV GUIDE ON SCREEN™ SYSTEM

## 2 Record Defaults

This TV doesn't support recording feature.



2

## 3 Remind Defaults

Remind Defaults lets you set defaults for the following:

- Power On the TV, if Off, when a Reminder is scheduled. Choices are Yes and No. (Default = No)
- Automatically tune the TV to the channel (TV must be On), when a Reminder is scheduled. Choices are Yes and No. (Default = No)
- When to display the reminder screen, choices are 30 seconds to 15 minutes early, to 30 seconds to 15 minutes late, to On time. (Default = 1 min early)

Highlight Remind Defaults, and press the **MENU** button to display the Remind Defaults menu.

Highlight Go to Service Bar to close the menu, change no information, and return to the Setup Service Bar.

When finished, press the **ENTER** button to highlight Done. Press the **ENTER** button again to close the menu and accept the changes.

Highlight Cancel to close the menu, change no information, and return to the highlighted option.



3



3

## Remind Features

You can set a show Reminder in Listings, Search, and Schedule or change Reminder settings for a show in Schedule.

There are 2 ways to set a show Reminder:

### From a Panel Menu

- 1 Highlight a show, and press the **MENU** button to display the Episode Options menu.
- 2 Highlight Set Reminder, and press the **ENTER** button to display the Remind Options menu.
- 3 Highlight the Frequency option, and use the left and right arrows to choose between:

- Once - Sets a show reminder one time.
- Regularly - Sets a show reminder every time the show airs on the same channel and starts at the same time.
- Weekly - Sets a show reminder each time the show airs on the same day of the week, on the same channel and starts at the same time.
- Off - Keeps the show in the list but will not remind until the frequency is changed.

- 4 Power On the TV, if Off, when a Reminder is scheduled. Choices are Yes and No. (Default = No)
- 5 Automatically tune the TV to the channel (TV must be On), when a Reminder is scheduled. Choices are Yes and No. (Default =No)
- 6 When to display the reminder screen. Choices are 30 seconds to 15 minutes early, to 30 seconds to 15 minutes late, to On time. (Default = 1 min early)
- 7 When finished, press the **ENTER** button to highlight Schedule Reminder. Press the **ENTER** button again to close the menu. You can see a Remind icon for the selected frequency next to the show title. Highlight Cancel to close the menu, change no information, and return to the highlighted show.



1 2



3 4 5 6







7

# TV GUIDE ON SCREEN™ SYSTEM

## Manual Reminder

- 1 Highlight the Schedule Service label, and press the **MENU** button to display the Schedule Options menu.
- 2 Highlight New Manual Reminder and press the **ENTER** button to display the Remind Options menu.
- 3 Current information (i.e., date, start and end times, channel, input) is displayed.
- 4 Use the **▲ ▼ ◀ ▶** button to move through the options. Use the number or the **▲ ▼ ◀ ▶** buttons to change the information, as necessary.
- 5 Highlight the Frequency option, and use the **◀** or **▶** button to choose among Once, Daily, Weekly, and Off, as follows :

-  **Once** - Sets a show reminder for the time, channel, input combination one time.
-  **Daily** - Reminds for the time, channel, input combination Monday through Friday.
-  **Weekly** - Sets a show reminder for the time, channel, input combination once a week on this selected day of the week.
-  **Off (not cancel)** - Keeps the time, channel, input combination in the list without reminding until the frequency is changed.

- 6 Power On the TV, if the TV is Off, when a Reminder is scheduled. Choices are Yes and No.(Default =No)
- 7 Automatically tune the TV to the channel (TV must be On), when a Reminder is scheduled. Choices are Yes and No. (Default = No)
- 8 When finished, press the **ENTER** button to highlight Schedule Reminder. Press the **ENTER** button again to close the menu. You can see a Remind icon for the selected frequency next to the input and channel number.

Highlight Cancel to close the menu, change no information, and return to the highlighted show.



1 2



3 4 5 6 7

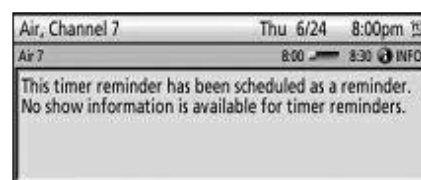

8

## Remind Alerts

Based on your option settings, a notification screen will appear, if your TV is On at the reminder time. Then you can choose to hide the reminder, or highlight the show, and press the **ENTER** button to tune to the show. If there is no activity for 3 minutes, the notification screen automatically closes and completes the highlighted item (hide reminders).

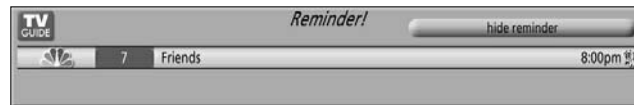

If you choose Hide Reminders, the window closes for the show or shows, but does not affect other Reminders you set.

### ! NOTE

- ▶ If more than 2 reminders are set for the same time, arrows appear on the Reminder screen. Use the ▲ or ▼ button to view the shows.

## Remind Conflict

A conflict message appears for the following reasons:

- A show set with an Auto-Tune Reminder has the same start time as an existing Auto-Tune Reminder.

Select one of these options:

- Auto-tune anyway - This show will override an existing show set to auto-tune.
- Proceed, no auto-tune - Set the show as a Reminder but do not auto-tune.
- Don't set this reminder - Cancel the Reminder.

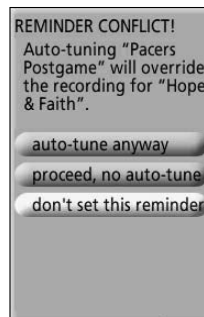
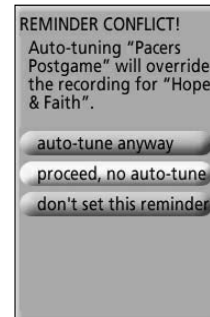
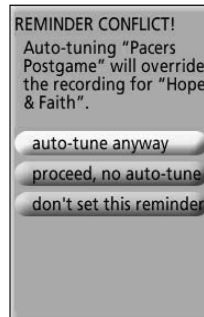

# SPECIAL FUNCTIONS | PIP / POP / Twin Picture

PIP lets you view 2 different inputs (sources) on your TV screen at the same time. One source will be large, and the other source will show a smaller inset image.

Twin Picture mode splits the screen into two images, allowing two picture sources to be shown on the TV screen at the same time. Each source is given half the screen.

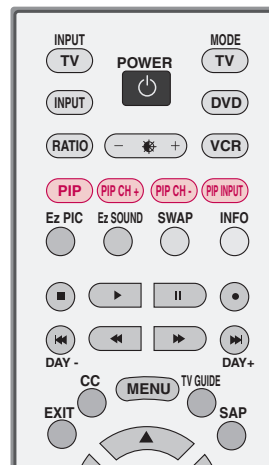

## Watching PIP/POP/Twin Picture

Press the **PIP** button to access the sub picture. Each press of PIP changes the PIP options as shown below.

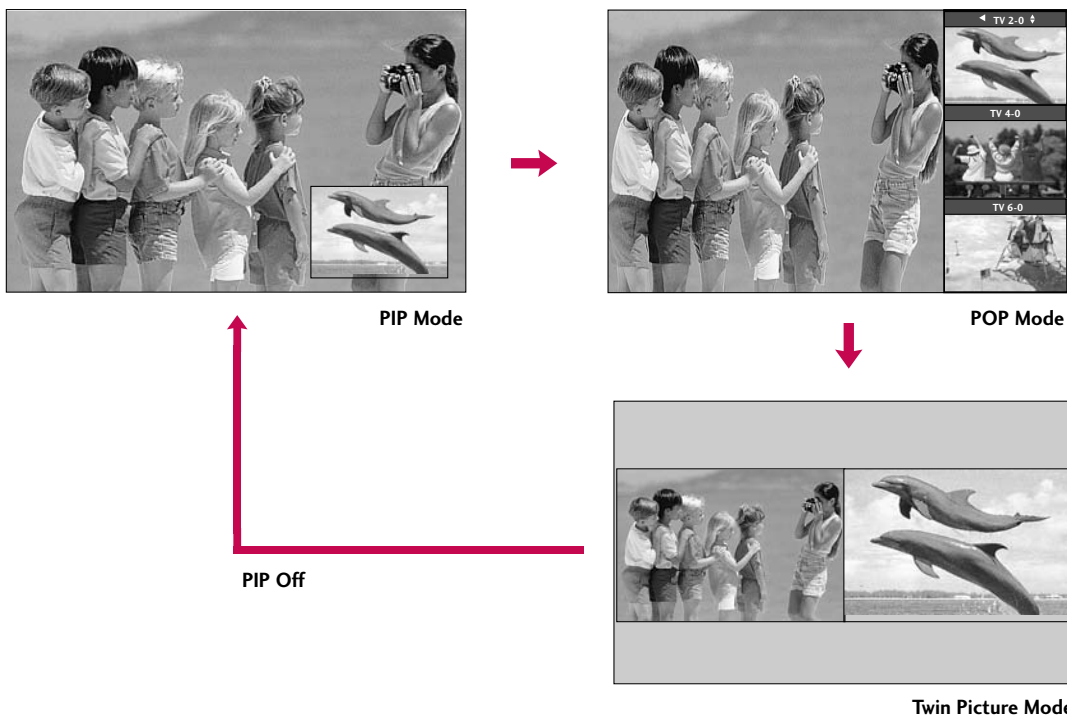

SPECIAL FUNCTIONS / PIP / POP / TWIN PICTURE

## Selecting an Input Signal Source for PIP/Twin Picture

Use the **PIP INPUT** button to select the input source for the sub picture. Each press of **PIP INPUT** button changes the PIP source. You can also select sources for the **Sub Input** in the **SETUP** menu.

Main Picture Source	Available Sub Picture Sources
DTV/CADTV	Analog (TV/CATV), AV1, and AV2
TV/CATV, AV1, AV2, Component1, Component2, RGB-PC/RGB-DTV, HDMI1/DVI, HDMI2	DTV/CADTV, Analog(TV/CATV), AV1, and AV2

## TV Program Selection for PIP

- 1 Press the **PIP** button.
- 2 Select the **Antenna** or **Cable** option on the Sub input menu or with the **PIP INPUT** button. Use the **PIP CH+** / **PIP CH-** button to select a channel for the sub picture.  
(You can't select DTV for main and sub picture simultaneously).

## Moving the PIP Sub Picture

- 1 In PIP mode, press the **▲▼◀▶** button to move the sub picture to a different location on the screen.

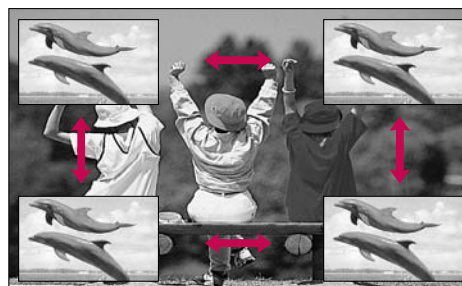

# SPECIAL FUNCTIONS | PIP / POP / Twin Picture

## Swapping the PIP/Twin Picture

- 1 Repeatedly, use the **SWAP** button to switch the main and sub pictures.
  - Component 1, Component 2, RGB-PC (or RGB-DTV), HDMI1/DVI, HDMI2 input sources for the main picture can't be used to swap the main and sub pictures.

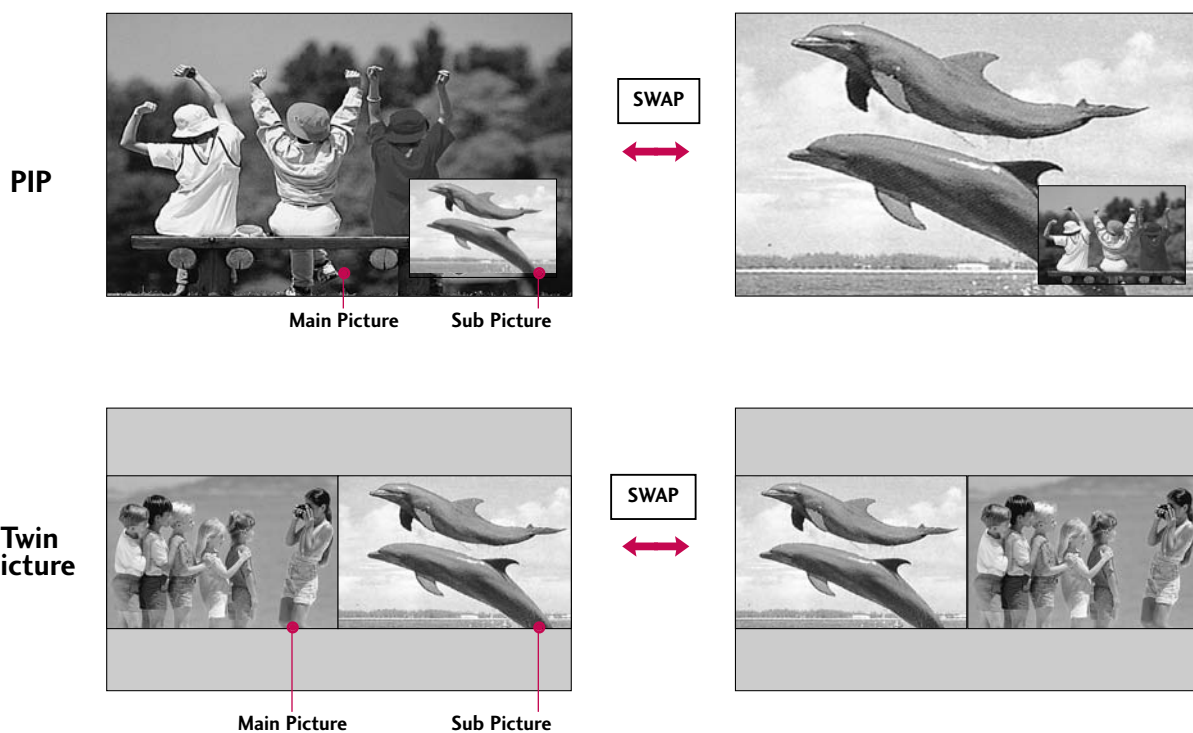

## Adjusting Main and Sub Picture Sizes for Twin Picture

- 1 Use the **▲ ▼ ◀ ▶** button to change main and sub picture sizes in Twin Picture mode.
  - If screen is adjusted to the maximum size, the large screen is filled with entire screen vertically as shown.



## POP (Picture-out-of-Picture : Channel Scan)

Use POP to search the programs of all the memorized channels one-by-one on the 3 PIP screen display, (while the main picture source remains the current channel). The pictures of all the programmed channels are searched with the 3 POP screens.

- 1 Press the **PIP** button to activate the **POP mode** while in **PIP mode**.
  - **Channel selection** : Use ◀ button to enlarge the selected channel being searched on the PIP screen to shift it for viewing on the Main screen.
  - **PIP selection** : Use ▲ or ▼ button to select one of 3 PIP screen pictures in **POP** mode.
  - When watching TV/CATV, TV/DTV or CATV/CADTV Sub pictures are scanned. However, when watching DTV/CADTV, only TV/CATV Sub pictures are scanned.



- 2 Press the **EXIT** button to cancel POP mode.

### NOTE

- ▶ Run EZ Scan channel search before using POP mode.
- ▶ When Sub pictures are changed from the TV/DTV to CATV/CADTV in POP mode, you may hear a noise from the Tuner switch.

# TV MENU

## ON SCREEN MENUS SELECTION AND ADJUSTMENT

Your TV's OSD (On Screen Display) may differ slightly from what is shown in this manual.

**1** Press the **MENU** button and then use **▲** or **▼** button to select the each menu.

**2** Press the **▶** button and then use **▲ ▼ ◀ ▶** button to display the available menus.



TV MENU

# TV MENU | SETUP(Channel)

## AUTO CHANNEL SEARCH (EZ SCAN)

Automatically finds all channels available through antenna or cable inputs, and stores them in memory on the channel list.

Run EZ Scan again after any Antenna/Cable connection changes.

A password is required to gain access to EZ Scan menu if the Lock System is turned on.

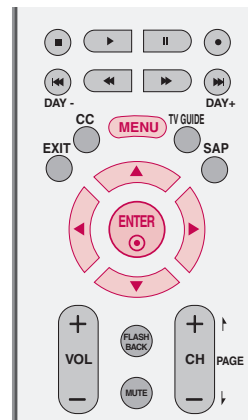

- 1 Press the **MENU** button and then use ▲ or ▼ button to select the **SETUP** menu.
- 2 Press the ► button and then use ▲ or ▼ button to select **EZ Scan**.
- 3 Press the **ENTER** button to begin the channel search. Allow **EZ Scan** to complete the channel search cycle for **ANTENNA** and **CABLE**.

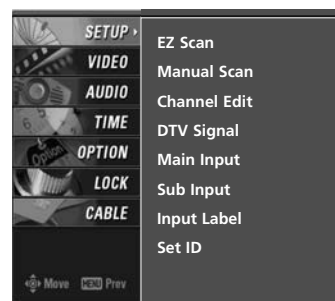

1

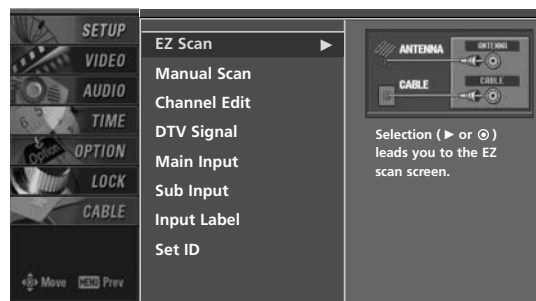

2

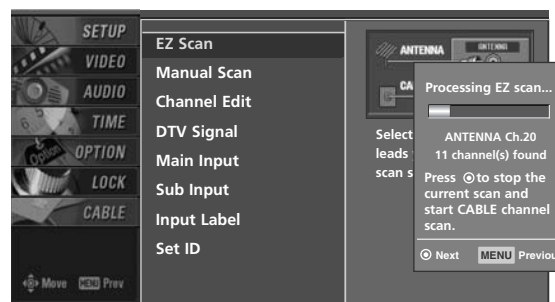

3

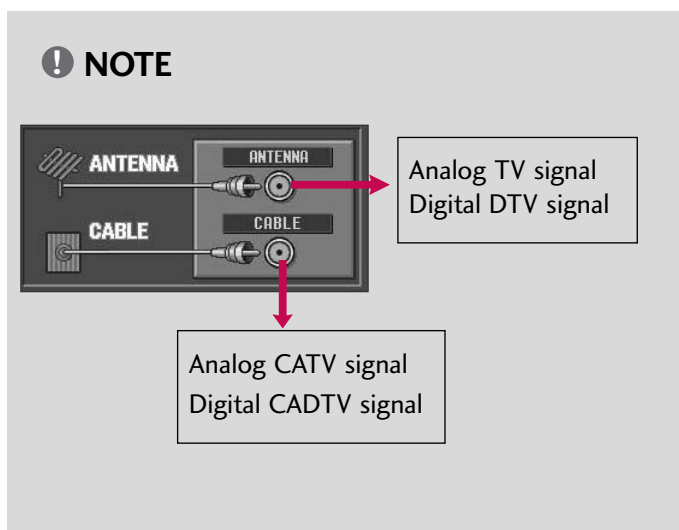

# TV MENU | SETUP(Channel)

## MANUAL CHANNEL SEARCH (MANUAL SCAN)

A password is required to gain access to Manual Scan menu if the Lock System is turned on.

While using the CableCARD™, CATV, CADTV is not working in Manual Scan.

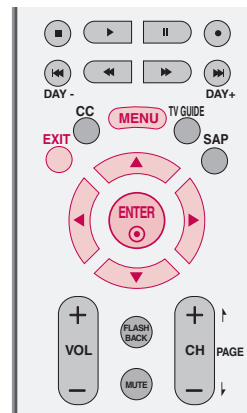

- 1 Press the **MENU** button and then use ▲ or ▼ button to select the **SETUP** menu.
- 2 Press the ► button and then use ▲ or ▼ button to select **Manual Scan**.
- 3 Press the ► button and then use ▲ or ▼ button to select **TV, DTV, CATV, and CADTV**.
- 4 Press the ► button and then use ▲ or ▼ button to select channel you want to add or delete.
- 5 Press the **ENTER** button to add or delete the channel.
- 6 Press the **EXIT** button to return to TV viewing or press **MENU** button to return to the previous menu.

**NOTE**

- ▶ This digital channel number is a physical channel number, which is different from the normal channel number shown in Channel Edit.

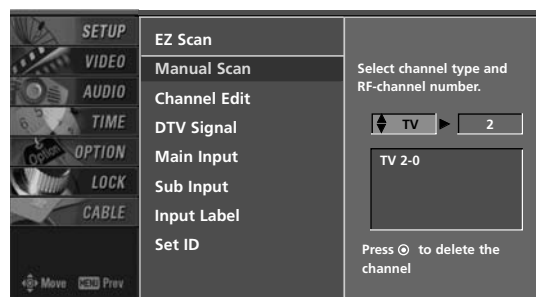
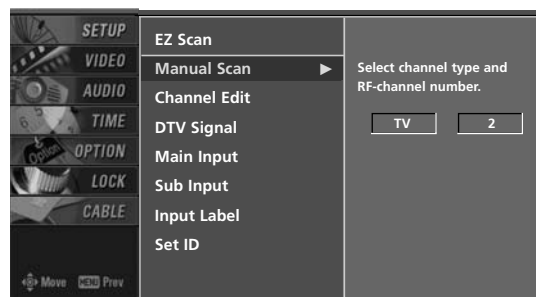
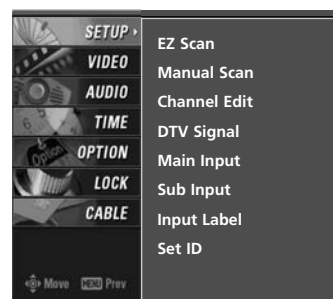

- 4 5

# CHANNEL EDIT

From the default channel list created from the EZ Scan channel search, you can create two different types of channel lists in memory: “custom list” and “favorite channel list”.

A custom list can be created by toggling each channel on or off with **ENTER** button. The channels in the Custom List are displayed in black and the channels deleted from the Custom List are displayed in gray. Once a channel is highlighted you can add or delete the channel by referring to the small window at the top-right corner of the screen.

You can create your own Favorite List. Use the **FAV** button on the remote control when a channel is highlighted and then add or delete the channel to/from your Favorite List.

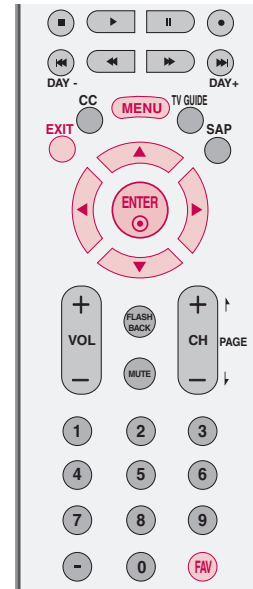

**1** Press the **MENU** button and then use **▲** or **▼** button to select the **SETUP** menu.

**2** Press the **▶** button and then use **▲** or **▼** button to select **Channel Edit**.

**3** Press the **▶** button. You will now see a screen filled with channel numbers and a preview picture.

**4** Use **▲ ▼ ◀ ▶** button to select a channel and then use the **ENTER** button to add or delete it. Press **FAV** button to add the channel to the Favorite List. The surfing icon mark will appear in front of that channel number.

**5** Press **EXIT** button to return to TV viewing or press **MENU** button to return to the previous menu.

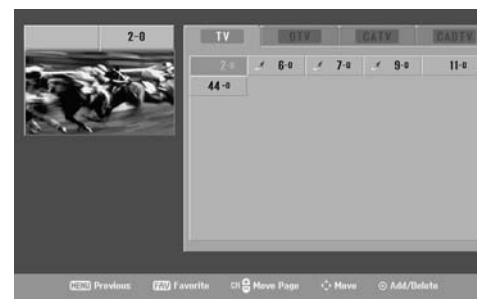
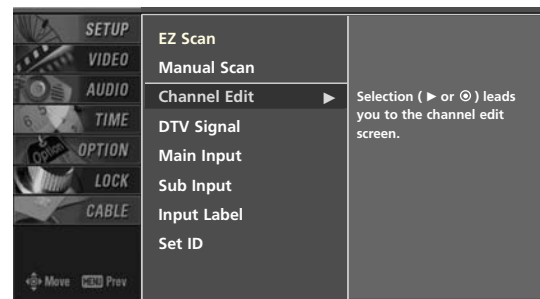
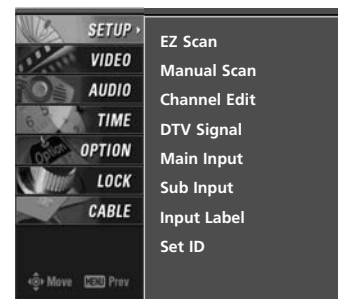

TV MENU / SETUP(CHANNEL)

# TV MENU | SETUP(Channel)

## DTV SIGNAL STRENGTH

This feature displays the DTV signal levels being received and indicates whether you need to adjust your antenna or digital cable input. The higher the signal strength, the less likely you are to experience picture degradation.

**DTV Signal:** This function is only available when the input signal is DTV or CADTV.

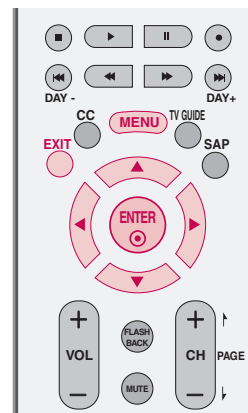

**1** Press the **MENU** button and then use ▲ or ▼ button to select the **SETUP** menu.

**2** Press the ► button and then use ▲ or ▼ button to select **DTV Signal**.

**3** View the on-screen signal strength monitor to see the quality of the signal being received.

**4** Press **EXIT** button to return to TV viewing or press **MENU** button to return to the previous menu.

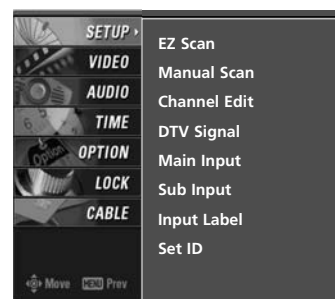

**1**

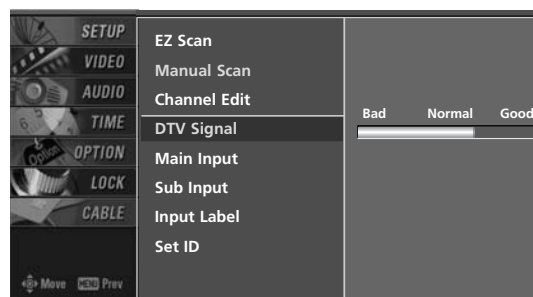

**2 3**

## MAIN PICTURE SOURCE SELECTION

Changes the picture source so you can watch your off-air TV, cable TV, VCR, DVD, or any other devices that are connected to your TV.

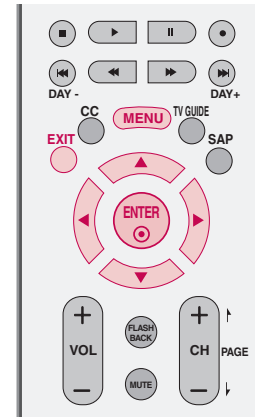

- 1 Press the **MENU** button and then use **▲** or **▼** button to select the **SETUP** menu.
- 2 Press the **▶** button and then use **▲** or **▼** button to select **Main Input**.
- 3 Press the **▶** button and then use **▲** or **▼** button to select the source: **Antenna**, **Cable**, **AV1**, **AV2**, **Component1**, **Component2**, **RGB-PC** (or **RGB-DTV**), **HDMI1/DVI**, or **HDMI2**.
  - To toggle RGB-DTV and RGB-PC, select RGB-PC (or RGB-DTV) and press the **▶** button.
- 4 Press **EXIT** button to return to TV viewing or press **MENU** button to return to the previous menu.

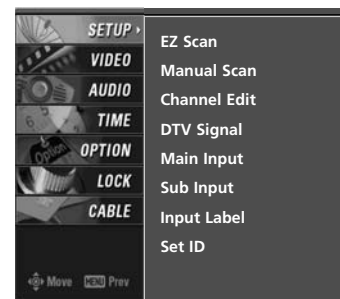

1

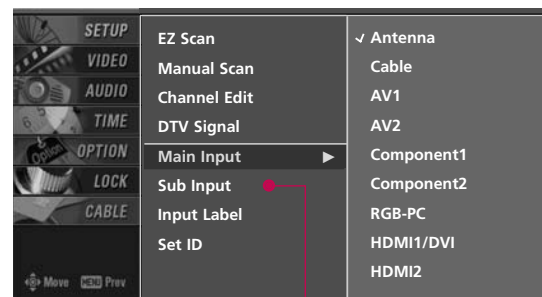

2 3

### Sub Picture Source Selection

Select sources for the **Sub Input** in the **SETUP** menu.

See Page 59 for selecting the input source for the sub picture by pressing the **PIP INPUT** button.

# TV MENU | SETUP(Channel)

## INPUT LABEL

Sets a label to each input source which is not in use when you press the **INPUT** button.

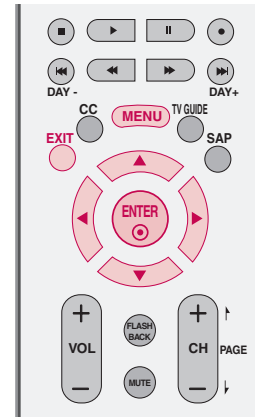

**1** Press the **MENU** button and then use **▲** or **▼** button to select the **SETUP** menu.

**2** Press the **▶** button and then use **▲** or **▼** button to select **Input Label**.

**3** Press the **▶** button and then use **▲** or **▼** button to select the source: **AV1, AV2, Component1, Component2, RGB, HDMI1/DVI** or **HDMI2**.

**4** Press the **◀** or **▶** button to select the label.

**5** Press **EXIT** button to return to TV viewing or press **MENU** button to return to the previous menu.

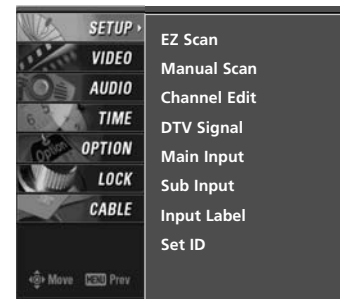

**1**

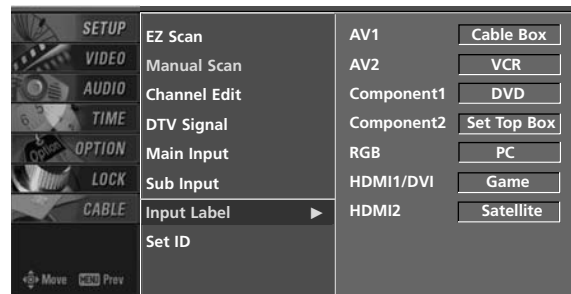

**2 3 4**

# TV MENU | VIDEO ADJUSTMENT

## AUTO PICTURE CONTROL (EZ PICTURE)

EZ Picture adjusts the TV for the best picture appearance. Select the preset value in the EZ Picture menu based on the program category.

Daylight, Normal, Night Time Settings are preset for optimum picture quality at the factory and are not adjustable.

In the User1, and User2 modes only, user can directly adjust the contrast, brightness, color, sharpness, tint.

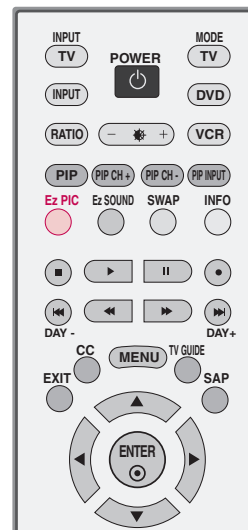

- 1 Press the **Ez PIC** button repeatedly to select the picture appearance setup option as below :  
**Daylight, Normal, Night Time, User1, and User2** (your own settings).

- 2 Press the **EXIT** button to save and return to TV viewing.

■ You can also use the **VIDEO** menu to adjust **EZ Picture**.

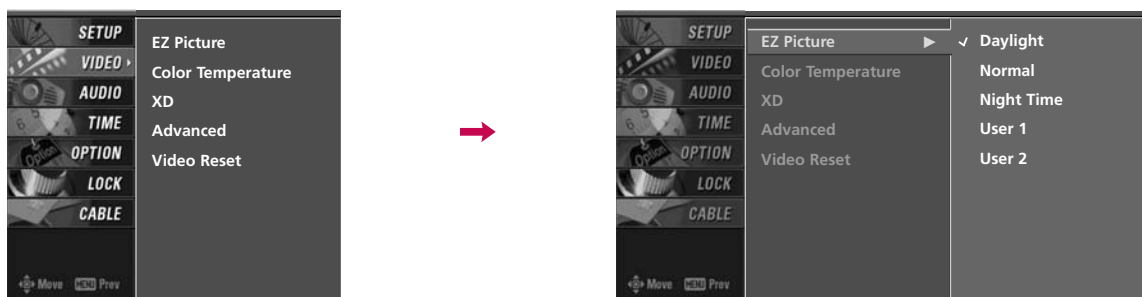

## TV MENU | VIDEO ADJUSTMENT

### ADAPTIVE PICTURE MODE (APM)

Allows you to select your preferred picture mode after comparing the four different picture (Daylight, Normal, Night Time, User1 (or User2)) settings.

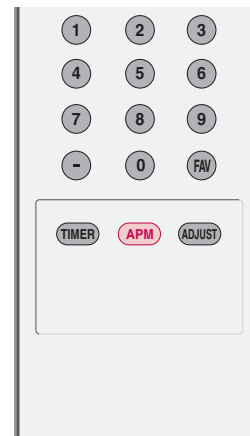

**1** Press the **APM** button at once. As shown below, the screen is divided to 4-split.

**2** Use the **▲ ▼ ◀ ▶** button to navigate 4 EZ Pictures. By pressing the **ENTER** button, you can select the desired mode.

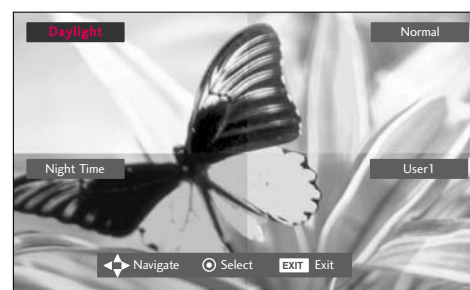

**1 2**

**3** Press the **APM** button twice. The 4-same screens are displayed. You can easily compare with 4 modes.

**4** Use the **▲ ▼ ◀ ▶** button to navigate 4 EZ Pictures. By pressing the **ENTER** button, you can select the desired mode.

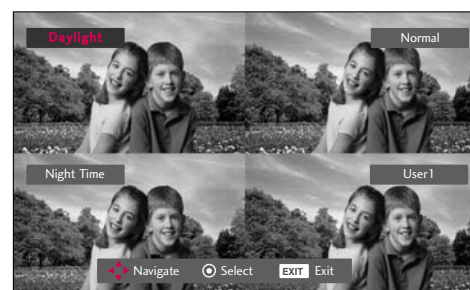

**3 4**

#### ! NOTE

- ▶ While operating the 4-split, any button except **APM**, **ENTER**, **EXIT**, **▲ ▼ ◀ ▶**, **VOLUME ▲** or **▼**, **MUTE** button on the remote control are not usable.
- ▶ APM screen will automatically disappear after approx. 40 seconds unless a button is pressed.

# MANUAL PICTURE CONTROL (EZ Picture-User option)

Adjust the picture appearance to suit your preference and viewing situations.

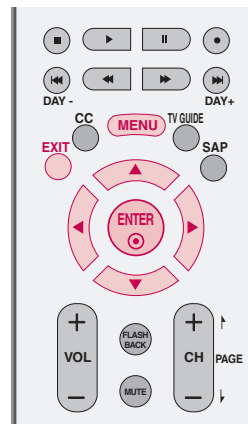

**1** Press the **MENU** button and then use **▲** or **▼** button to select the **VIDEO** menu.

**2** Press the **▶** button and then use **▲** or **▼** button to select **EZ Picture**.

**3** Press the **▶** button and then use **▲** or **▼** button to select **User 1** or **User 2**.

**4** Press the **▶** button and then use **▲** or **▼** button to select the desired picture option (**Contrast**, **Brightness**, **Color**, **Sharpness**, or **Tint**).

**5** Press the **▶** button and then use **◀** or **▶** button to make appropriate adjustments.

**6** Press **EXIT** button to return to TV viewing or press **MENU** button to return to the previous menu.

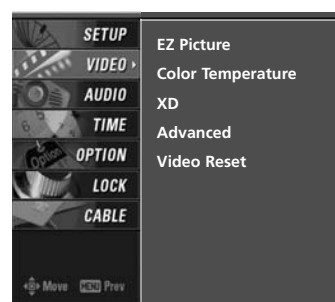

**1**

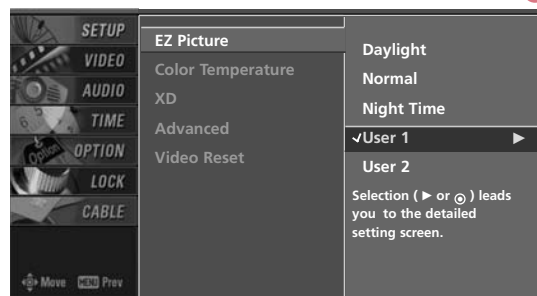

**2 3**

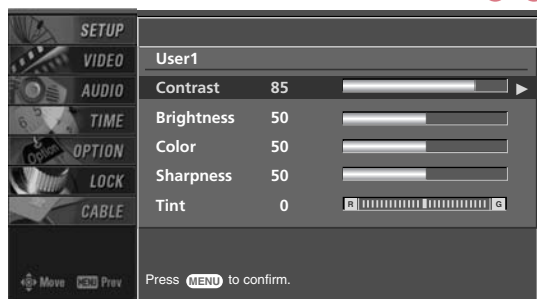

**4**



**5**

# TV MENU | VIDEO ADJUSTMENT

## COLOR TEMPERATURE CONTROL

### Auto Color Temperature Control

Choose one of three automatic color adjustments. Set to warm to enhance hotter colors such as red, or set to cool to see less intense colors with more blue.

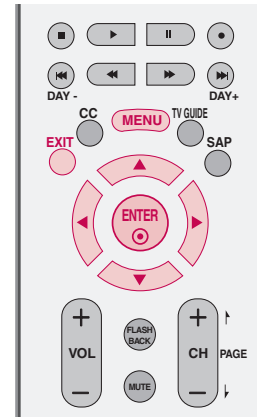

**1** Press the **MENU** button and then use **▲** or **▼** button to select the **VIDEO** menu.

**2** Press the **▶** button and then use **▲** or **▼** button to select **Color Temperature**.

**3** Press the **▶** button and then use **▲** or **▼** button to select either **Cool**, **Medium**, **Warm** or **User**.

**4** Press **EXIT** button to return to TV viewing or press **MENU** button to return to the previous menu.

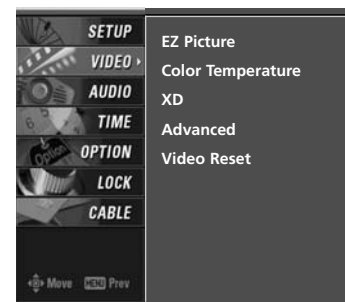

**1**

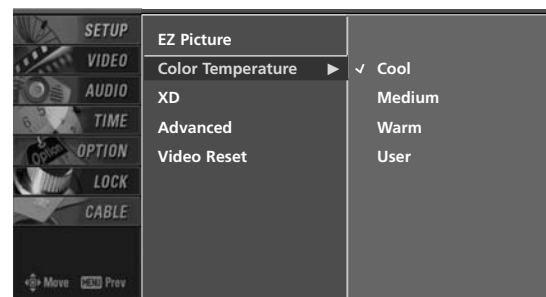

**2 3**

## Manual Color Temperature Control

You can also adjust the detailed settings (Red, Green, Blue) by selecting the **User** menu.

- 1 Press the **MENU** button and then use **▲** or **▼** button to select the **VIDEO** menu.
- 2 Press the **▶** button and then use **▲** or **▼** button to select **Color Temperature**.
- 3 Press the **▶** button and then use **▲** or **▼** button to select **User**.
- 4 Press the **▶** button and then use **▲** or **▼** button to select **Red, Green, or Blue**.
- 5 Press the **▶** button and then use **◀** or **▶** button to make appropriate adjustments.
  - The adjustment range of **RGB, Green, or Blue** is -20~ +20.
- 6 Press **EXIT** button to return to TV viewing or press **MENU** button to return to the previous menu.

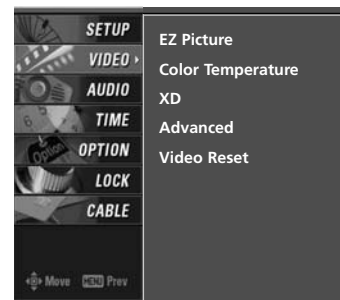
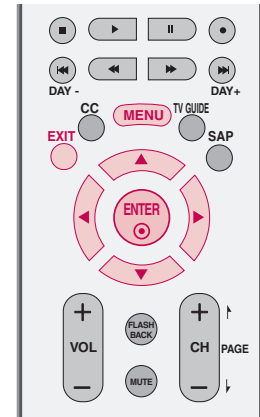

1

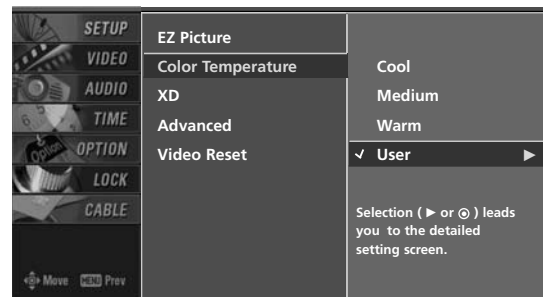

2 3

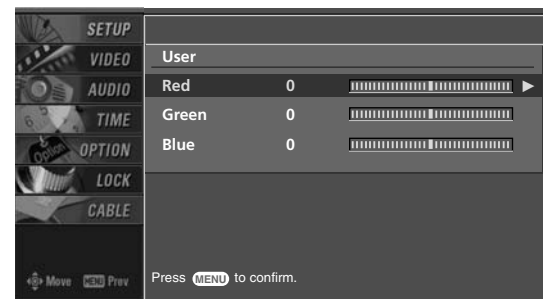

4

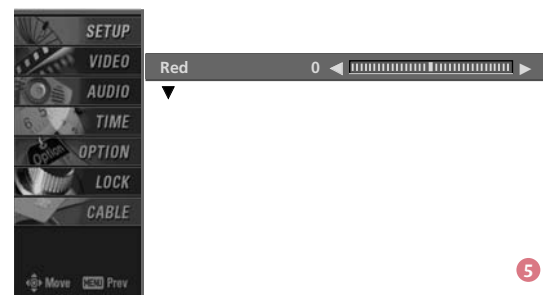

5

## TV MENU | VIDEO ADJUSTMENT

### XD

XD is LG Electronic's unique picture improving technology to display a real HD source through an advanced digital signal processing algorithm.

When selecting EZ Picture options (Daylight, Normal and Night time), XD is automatically changed to Auto.

When selecting EZ Picture options (User 1 and User 2), you can choose the Auto / Manual.

When selecting the Manual, you can adjust the XD Contrast, XD color and XD Noise.

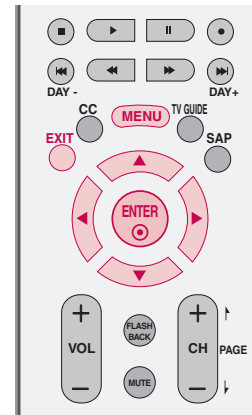

- 1 Press the **MENU** button and then use **▲** or **▼** button to select the **VIDEO** menu.

- 2 Press the **▶** button and then use **▲** or **▼** button to select **XD**.

- 3 Press the **▶** button and then use **▲** or **▼** button to select **Auto** or **Manual**.

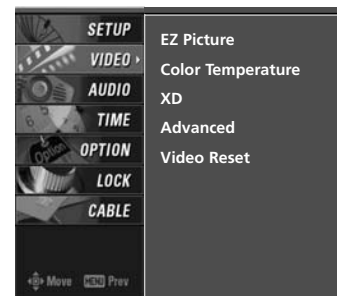

1

#### Selecting the Manual

1. Press the **▶** button and then use **◀** or **▶** button to select **XD Contrast**, **XD Color** or **XD Noise**.

- **XD Contrast:** Optimizing the contrast automatically according to the brightness of the reflection.
- **XD Color:** Adjusting the colors of the reflection automatically to reproduce as closely as possible to the natural colors.
- **XD Noise :** Removing the noise up to the point where it does not damage the original picture.

2. Use the **▲** or **▼** button to select **On** or **Off**.

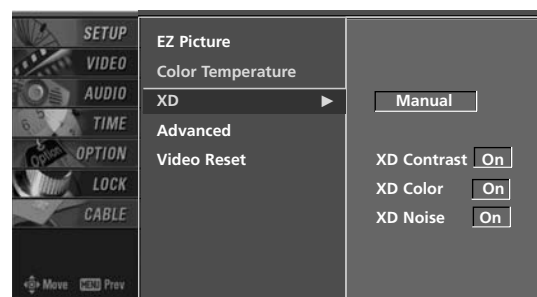

2 3

- 4 Press **EXIT** button to return to TV viewing or press **MENU** button to return to the previous menu.

## ADVANCED-CINEMA 3:2 MODE SETUP

Set up the TV for the best picture appearance for viewing movies.

When you operate Cinema 3:2 Mode (3:2 Pull-Down Mode or Cinema Correction Mode), the TV will adjust 24 fps video from movies to 30 fps video for display.

This feature operates only in Analog, AV1, AV2, and Component 480i mode.

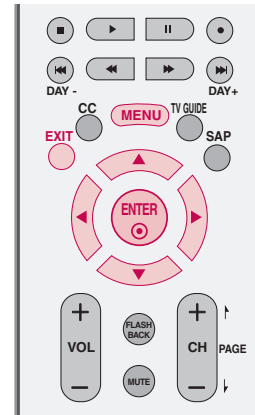

**1** Press the **MENU** button and then use **▲** or **▼** button to select the **VIDEO** menu.

**2** Press the **▶** button and then use **▲** or **▼** button to select **Advanced**.

**3** Press the **▶** button and then use **▲** or **▼** button to select **Cinema 3:2 Mode**.

**4** Press the **▶** button and then use **▲** or **▼** button to select **On** or **Off**.

**5** Press **EXIT** button to return to TV viewing or press **MENU** button to return to the previous menu.

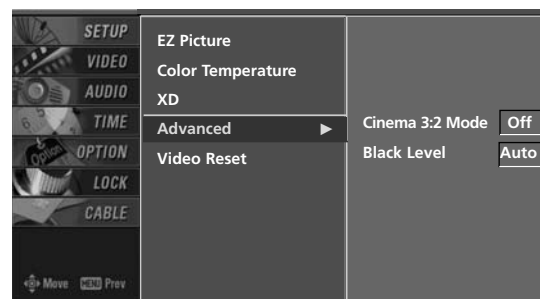
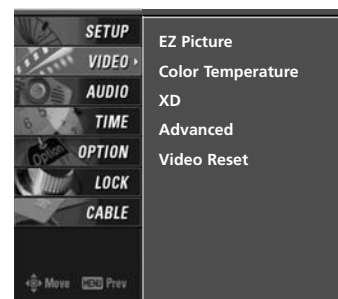

## TV MENU | VIDEO ADJUSTMENT

### ADVANCED-BLACK LEVEL

Adjusting the contrast and the brightness of the screen using the black level of the screen.

This feature operates only in AV1, AV2, HDMI1/DVI, or HDMI2 mode.

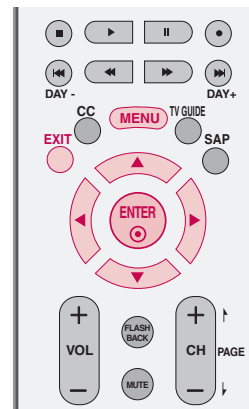

**1** Press the **MENU** button and then use **▲** or **▼** button to select the **VIDEO** menu.

**2** Press the **▶** button and then use **▲** or **▼** button to select **Advanced**.

**3** Press the **▶** button and then use **▲** or **▼** button to select **Black level**.

**4** Press the **▶** button and then use **▲** or **▼** button to select **Auto**, **Low**, or **High**.

- **Auto**  
Realizing the black level of the screen and set it to High or Low automatically.
- **Low**  
The screen gets darker.
- **High**  
The screen gets brighter.

**5** Press **EXIT** button to return to TV viewing or press **MENU** button to return to the previous menu.

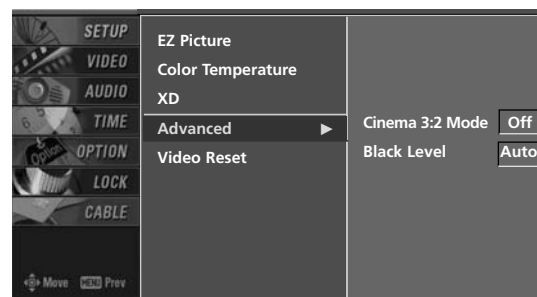
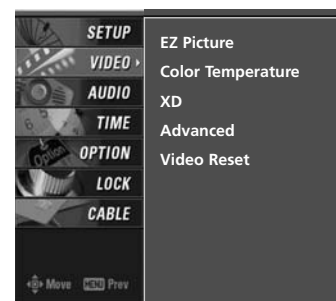

**3** **4**

## VIDEO RESET

Use to quickly reset all the Video menu options to their original factory preset values.

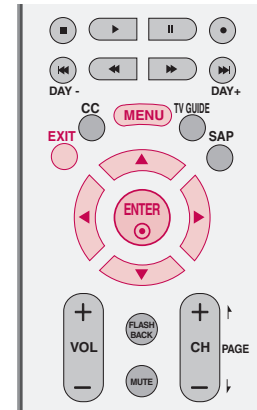

- 1 Press the **MENU** button and then use ▲ or ▼ button to select the **VIDEO** menu.
- 2 Press the ► button and then use ▲ or ▼ button to select **Video Reset**.
- 3 Press the ► button to reset the Video menu options to original values.

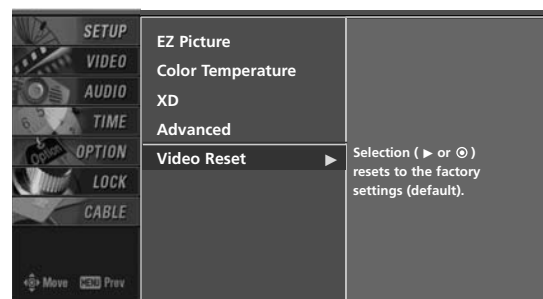
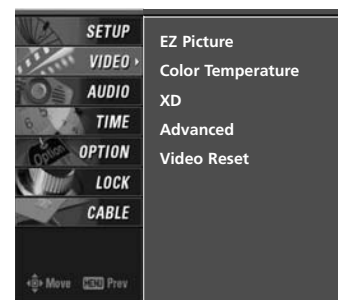

# TV MENU | AUDIO ADJUSTMENT

## AUDIO LANGUAGE

Other languages may be available if a digital signal is provided by the broadcasting station.

This feature operates only in DTV/CADTV mode.

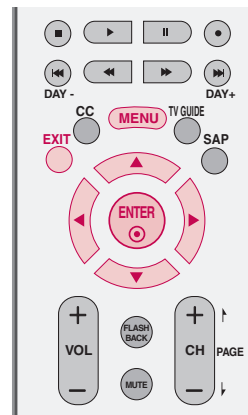

**1** Press the **MENU** button and then use **▲** or **▼** button to select the **AUDIO** menu.

**2** Press the **▶** button and then use **▲** or **▼** button to select **Audio Language**.

**3** Press the **▶** button and then use **▲** or **▼** button to select : **English, Spanish, or French**.

**4** Press **EXIT** button to return to TV viewing or press **MENU** button to return to the previous menu.

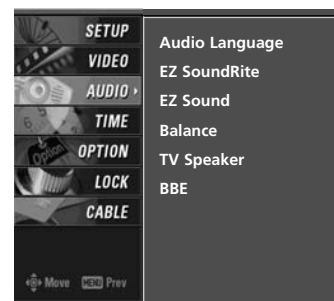

**1**

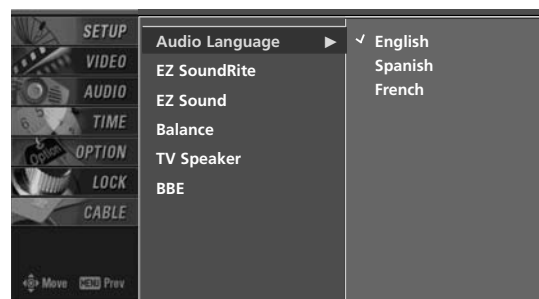

**2 3**

## AUTO VOLUME LEVELER (EZ SOUNDRITE)

Scans for changes in sound levels during commercials, then adjusts the sound to match the specified audio level. SoundRite makes sure that the volume level remains consistent whether you are watching a commercial or a regular TV program.

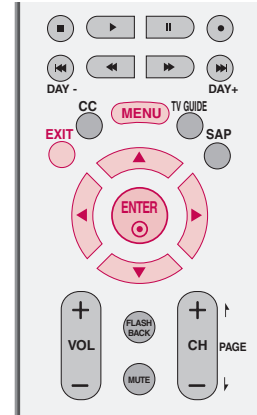

**1** Press the **MENU** button and then use **▲** or **▼** button to select the **AUDIO** menu.

**2** Press the **▶** button and then use **▲** or **▼** button to select **EZ SoundRite**.

**3** Press the **▶** button and then use **▲** or **▼** button to select **On** or **Off**.

**4** Press **EXIT** button to return to TV viewing or press **MENU** button to return to the previous menu.

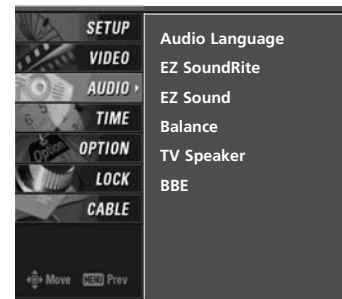

# TV MENU | AUDIO ADJUSTMENT

## AUTO SOUND CONTROL (EZ SOUND)

EZ Sound lets you enjoy the best sound without any special adjustment because the TV sets the appropriate sound options based on the program content.

Normal, Stadium, News, Music and Theater are preset for good sound quality at the factory and are not adjustable.

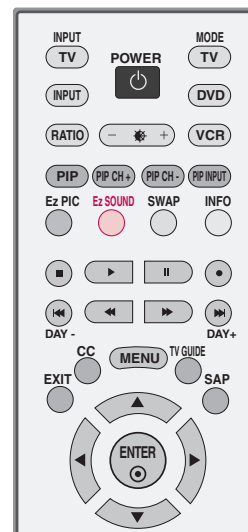

- 1 Press the **Ez SOUND** button repeatedly to select the appropriate sound setup as below :  
**Normal, Stadium, News, Music, Theater, and User** (your own settings).

- 2 Press **EXIT** button to return to TV viewing.

■ You can also adjust **EZ Sound** in the **AUDIO** menu.

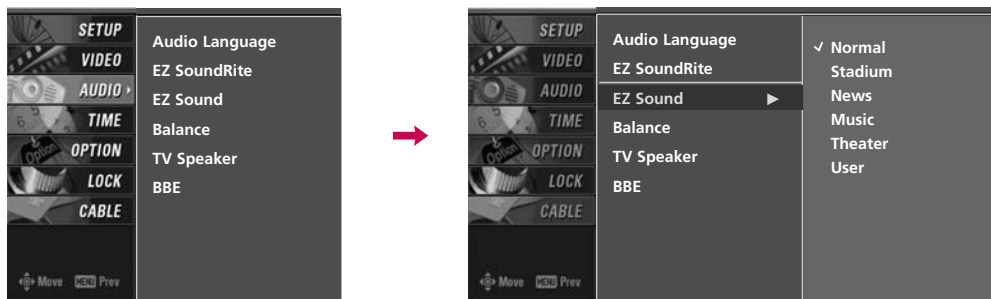

# MANUAL SOUND CONTROL (EZ SOUND-User option)

Adjust the sound to suit your taste and room situations.

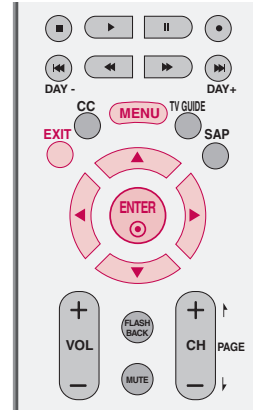

**1** Press the **MENU** button and then use **▲** or **▼** button to select the **AUDIO** menu.

**2** Press the **▶** button and then use **▲** or **▼** button to select **EZ Sound**.

**3** Press the **▶** button and then use **▲** or **▼** button to select **User**.

**4** Press the **▶** button and then use **▲** or **▼** button to select the desired sound option (**Treble**, **Bass**, or **Front Surround**).

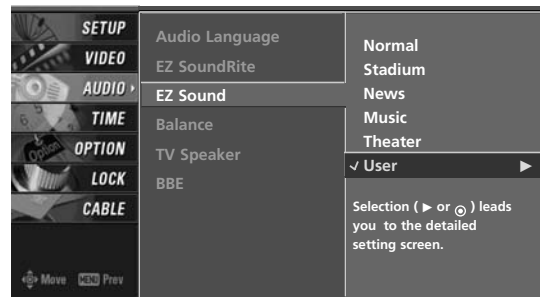

**1 2 3**

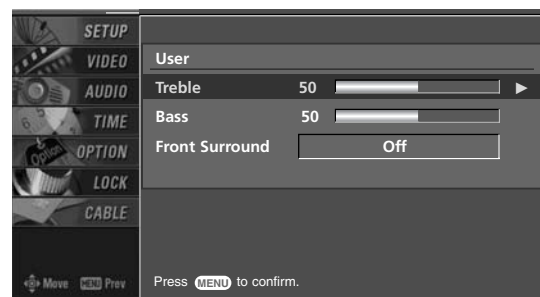

**4**

(Next page continued)

## TV MENU | AUDIO ADJUSTMENT

### MANUAL SOUND CONTROL *Continued*

- 5** Press the **▶** button and then use **◀** or **▶** button to make appropriate adjustments.

#### Selecting the Front surround

Press the **▶** button and then use **◀** or **▶** button to select **Off**, **3D EchoSound System** or **SRS (Sound Retrieval System) TruSurround XT**.



- 6** Press **EXIT** button to return to TV viewing or press **MENU** button to return to the previous menu.

#### SRS TruSurround XT

Takes advantage of any multi-channel format without needing to add extra speakers or equipment. Dialog clarity, bass enrichment, and the addition of stereo audio enhancement produces an immersive sound experience from standard stereo material.

#### 3D EchoSound System

Creates a stunning simulated stereo effect from any mono sound and a realistic three-dimensional sound with a very wide and deep sound stage.

## BALANCE

Adjust the left/right sound of speaker to suit your taste and room situations.

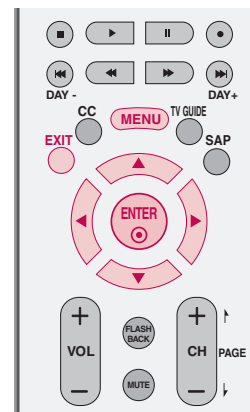

1 Press the **MENU** button and then use ▲ or ▼ button to select the **AUDIO** menu.

2 Press the ► button and then use ▲ or ▼ button to select **Balance**.

3 Press the ► button and then use ◀ or ▶ button to make appropriate adjustments.

4 Press **EXIT** button to return to TV viewing or press **MENU** button to return to the previous menu.

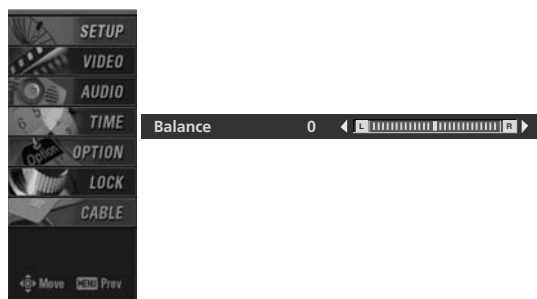
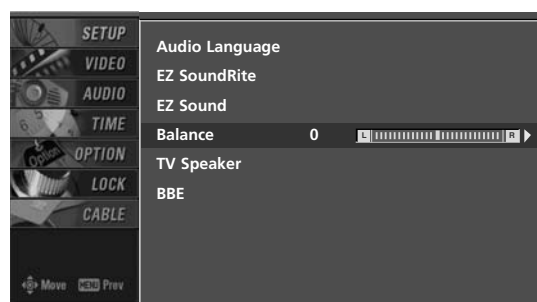
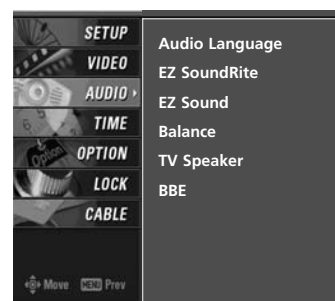

## TV MENU | AUDIO ADJUSTMENT

### TV SPEAKERS ON/OFF SETUP

Turn the TV speakers off if using external audio equipment. Feature turns the TV Speakers option On or Off.

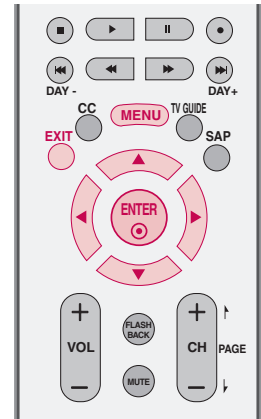

**1** Press the **MENU** button and then use **▲** or **▼** button to select the **AUDIO** menu.

**2** Press the **▶** button and then use **▲** or **▼** button to select **TV Speaker**.

**3** Press the **▶** button and then use **▲** or **▼** button to select **On** or **Off**.

**4** Press **EXIT** button to return to TV viewing or press **MENU** button to return to the previous menu.

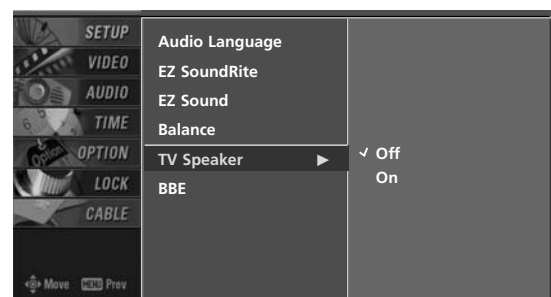
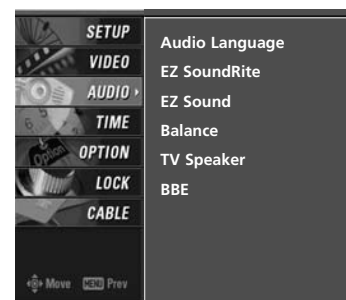

**3**

# BBE

BBE High Definition Sound restores clarity for better speech intelligibility and musical realism.

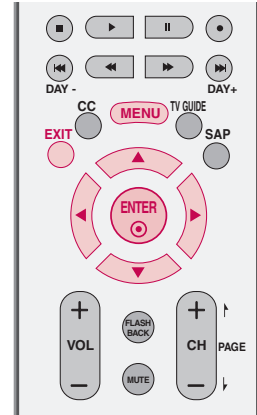

**1** Press the **MENU** button and then use ▲ or ▼ button to select the **AUDIO** menu.

**2** Press the ► button and then use ▲ or ▼ button to select **BBE**.

**3** Press the ► button and then use ▲ or ▼ button to select **On** or **Off**.

**4** Press **EXIT** button to return to TV viewing or press **MENU** button to return to the previous menu.

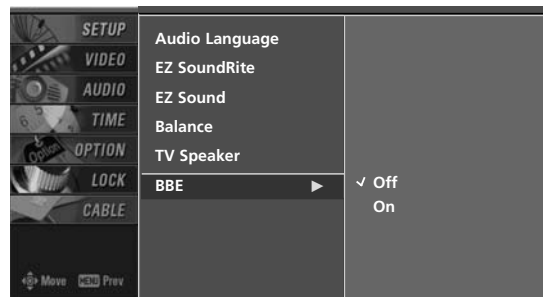
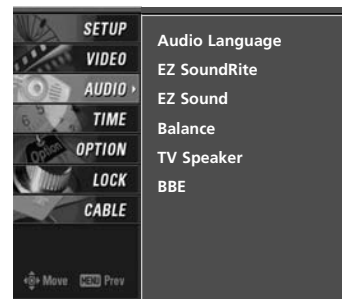

## TV MENU | AUDIO ADJUSTMENT

### STEREO/SAP BROADCAST SETUP

This TV can receive MTS stereo programs and any SAP (Secondary Audio Program) that accompanies the stereo program if the station transmits an additional sound signal as well as the original one and when you select Stereo or SAP on the remote control.

Mono sound is automatically received if the broadcast is only in Mono; even though Stereo or SAP has been selected.

Select Mono if you want to listen to the mono sound in remote areas during stereo/SAP broadcasting.

Stereo or SAP can be received in Analog channel.

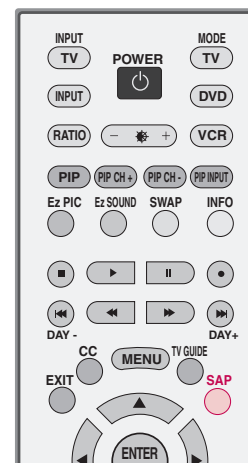

- 1 Use the **SAP** button to select your desired MTS mode in analog signal. Each time you press the **SAP** button, **Mono**, **Stereo**, or **SAP** appear in turn.
  - If other languages available on the digital signal, select them with the **SAP** button.

- 2 Press **EXIT** button to save and return to TV viewing.

# TV MENU | TIME SETTING

## AUTO CLOCK SETUP

The time is set automatically from a digital channel signal. The digital channel signal includes information for the current time provided by the broadcasting station. Set the clock manually if the current time is set incorrectly by the auto clock function.

**Note:** When you set up the TV Guide On Screen system, Auto Clock menu is not available.

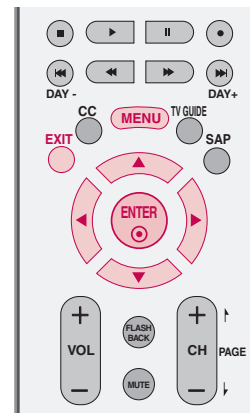

**1** Press the **MENU** button and then use **▲** or **▼** button to select the **TIME** menu.

**2** Press the **▶** button and then use **▲** or **▼** button to select **Auto Clock**.

**3** Press the **▶** button and then use **▲** or **▼** button to select **On**.

**4** Press the **▶** button and then use **▲** or **▼** button to select your viewing area time zone:  
 U.S.A : **Eastern, Central, Mountain, Pacific, Alaska or Hawaii.**  
 Canada : **Eastern, Central, Mountain, Pacific, New F.land or Atlantic.**

**5** Press the **▶** button and then use **▲** or **▼** button to select **Auto, Off, On**, depending on whether or not your viewing area observes Daylight Saving time.

**6** Press **EXIT** button to return to TV viewing or press **MENU** button to return to the previous menu.

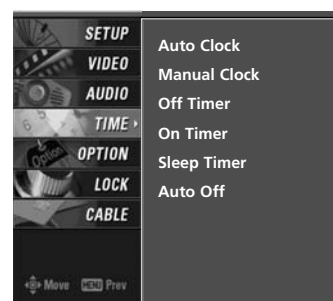

**1**

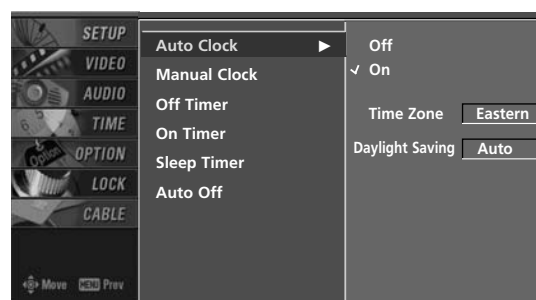

**2 3 4 5**

# TV MENU | TIME SETTING

## MANUAL CLOCK SETUP

If the current time setting is wrong, reset the clock manually. When you set up the TV Guide On Screen system, the Manual Clock menu is not available.

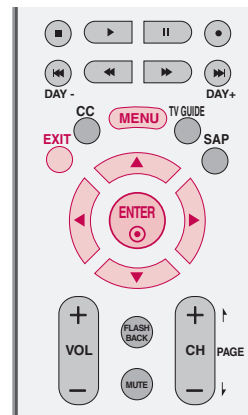

- 1 Press the **MENU** button and then use ▲ or ▼ button to select the **TIME** menu.
- 2 Press the ► button and then use ▲ or ▼ button to select **Manual Clock**.
- 3 Press the ► button and then use ◀ or ▶ to select either the year, date, or time option. Once selected, use the ▲ or ▼ button to set the year, date, and time options.
- 4 Press **EXIT** button to return to TV viewing or press **MENU** button to return to the previous menu.

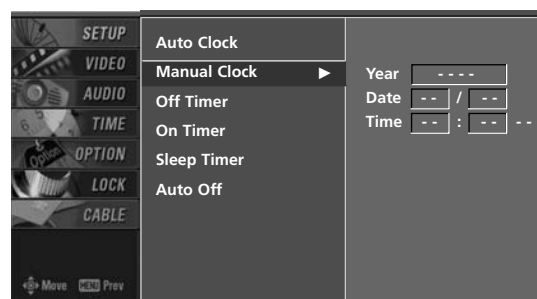
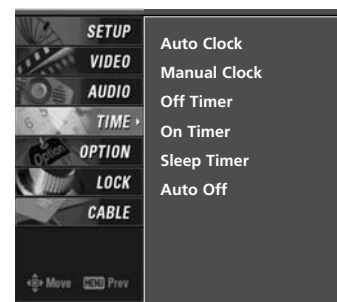

3

## ON/OFF TIMER SETUP

The timer function operates only if the current time has been set.

The Off-Timer function overrides the On-Timer function if they are both set to the same time.

The TV must be in standby mode for the On-Timer to work.

If you do not press any button within 2 hours after the TV turns on with the On Timer function, the TV will automatically revert to standby mode.

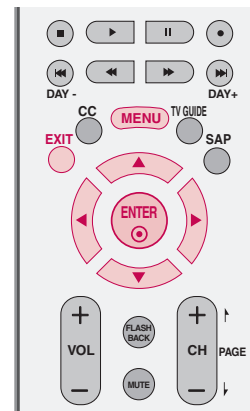

**1** Press the **MENU** button and then use **▲** or **▼** button to select the **TIME** menu.

**2** Press the **▶** button and then use **▲** or **▼** button to select **Off Timer** or **On Timer**.

**3** Press the **▶** button and then use **▲** or **▼** button to select **On**.  
 ■ To cancel the **On/Off timer** function, select **Off**.

**4** Press the **▶** button and then use **▲** or **▼** button to set the hour.

**5** Press the **▶** button and then use **▲** or **▼** button to set the minutes.

**6** **Only On timer**  
 Press the **▶** button and then use **▲** or **▼** to select the channel at turn-on.

Press the **▶** button and then use **▲** or **▼** to set the sound level at turn-on.

**7** Press **EXIT** button to return to TV viewing or press **MENU** button to return to the previous menu.

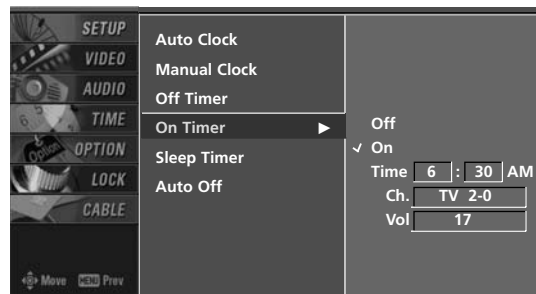
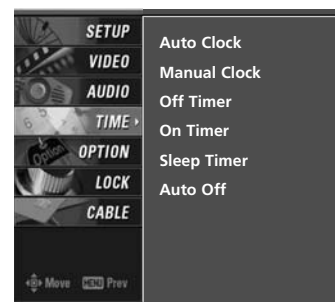

**2 3 4 5 6**

# TV MENU | TIME SETTING

## SLEEP TIMER

The Sleep Timer turns the TV off at the preset time.  
 Note that this setting is cleared when the TV is turned off.

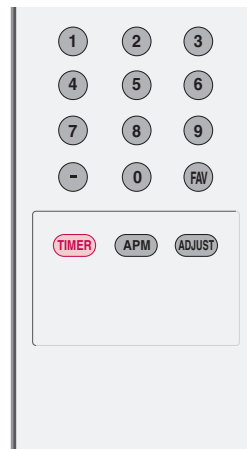

**1** Press the **TIMER** button repeatedly to select the number of minutes. First the **Off** option appears on the screen, followed by the following sleep timer options : 10, 20, 30, 60, 90, 120, 180, and 240 minutes.

**2** When the number of minutes you want is displayed on the screen, press the **ENTER** button. The timer begins to count down from the number of minutes selected.

**3** To check the remaining minutes before the TV turns off, press the **TIMER** button once.

**4** To cancel the Sleep Timer, press the **TIMER** button repeatedly to select **Off**.

■ You can also set up the **Sleep Timer** in the **TIME** menu.

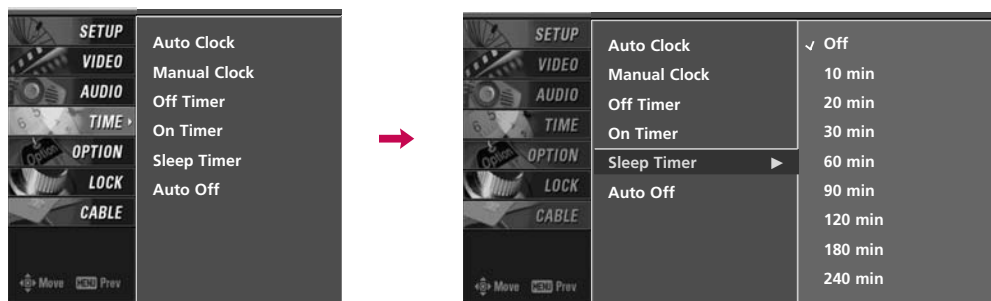

## AUTO OFF

If set to on and there is no input signal, the TV turns off automatically after 10 minutes.

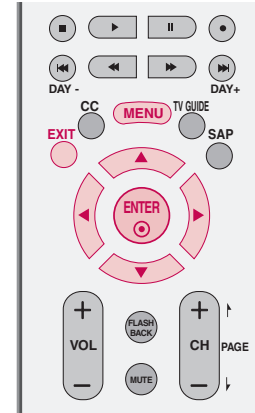

- 1 Press the **MENU** button and then use ▲ or ▼ button to select the **TIME** menu.
- 2 Press the ► button and then use ▲ or ▼ button to select **Auto Off**.
- 3 Press the ► button and then use ▲ or ▼ button to select **On** or **Off**.
- 4 Press **EXIT** button to return to TV viewing or press **MENU** button to return to the previous menu.

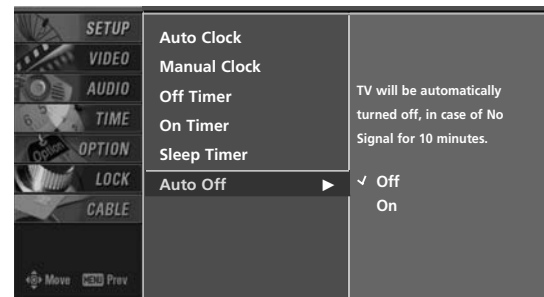
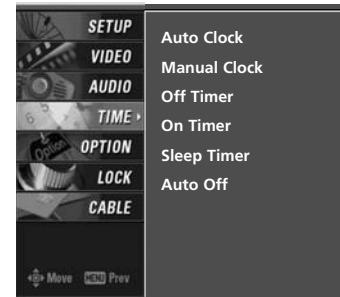

# TV MENU | OPTIONAL FEATURES

## ASPECT RATIO CONTROL

This feature lets you choose the way an analog picture with a 4:3 aspect ratio is displayed on your TV. When you receive an analog picture with a 4:3 aspect ratio on your 16:9 TV, you need to specify how the picture is to be displayed.

- RGB-PC/DVI-PC input source use 4:3 or 16:9 aspect ratio.

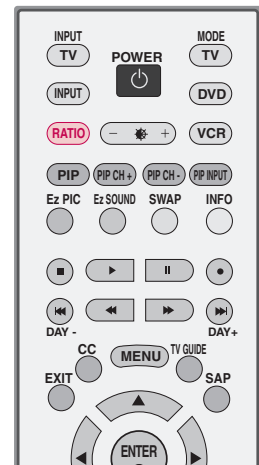

### NOTE

- ▶ If a fixed image is displayed on the screen for a long time, the image may become imprinted on the screen and remain visible. This phenomenon is common to all manufactures and in consequence the manufactures warranty does not cover the product bearing this phenomenon.

- 1 Press the **RATIO** button repeatedly to select the desired picture format.

You can also adjust **Aspect Ratio** in the **OPTION** menu.

### Set by program

Selects the proper picture proportion to match the source's image.

4:3 → 4:3

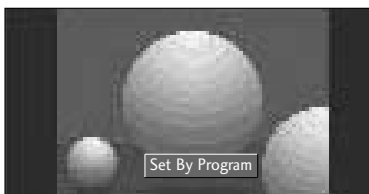

16:9 → 16:9



### 4:3

Choose 4:3 when you want to view a picture with an original 4:3 aspect ratio.

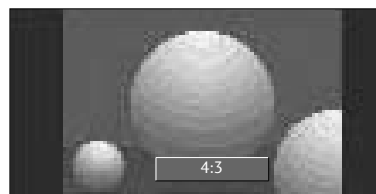

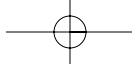

### 16:9

Adjust the picture horizontally, in a linear proportion to fill the entire screen.

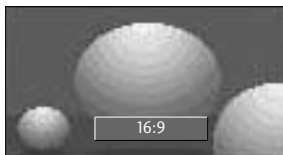

### Horizon

The screen size is more enlarged at both sides, to create a spectacular view.

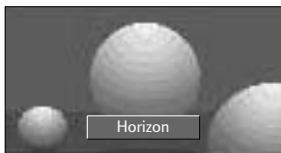

### Zoom 1

Choose Zoom 1 when you want to view the picture without any alteration. However, the top and bottom portions of the picture will be cropped.

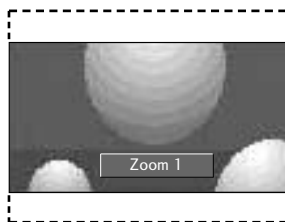

### Zoom 2

Choose Zoom 2 when you want the picture to be altered, both vertically extended and cropped. The picture taking a halfway trade off between alteration and screen coverage.

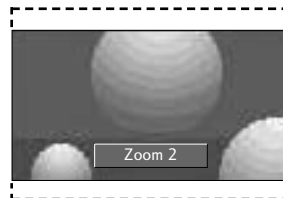

### Cinema Zoom

Choose Cinema Zoom when you want to enlarge the picture in correct proportion. Note: When enlarging or reducing the picture, the image may become distorted.

You can adjust the enlarge proportion of Cinema Zoom using ▲ or ▼ button.

The adjustment range is 1-16.

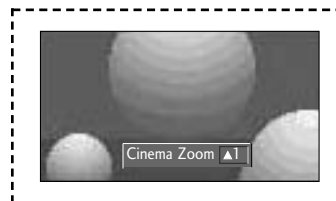

# TV MENU | OPTIONAL FEATURES

## CAPTION / TEXT

### Analog Broadcasting System Captions

Select a caption mode for displaying captioning information if provided on a program. Analog caption displays information at any position on the screen and is usually the program's dialog.

Text displays information, usually at the bottom position and is used for a data service, generally not program related. Caption/Text, if provided by the broadcaster, would be available for both digital and analog channels on the Antenna/Cable.

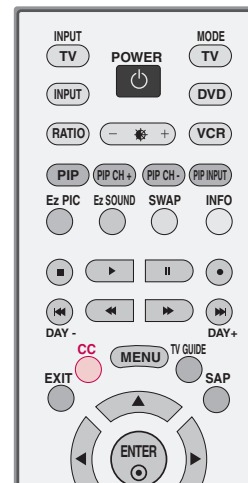

This TV is programmed to memorize the caption/text mode which was last set when you turn the power off.

- 1 Use the **CC** button repeatedly to select Caption **Off**, **CC1**, **CC2**, **CC3**, **CC4**, **Text1**, **Text2**, **Text3** or **Text4**.

- **CAPTION**

The term for the words that scroll across the bottom of the TV screen; usually the audio portion of the program provided for the hearing impaired.

- **TEXT**

The term for the words that appear in a large black frame and almost cover the entire screen; usually messages provided by the broadcaster.

- 2 Press **EXIT** to save and return to TV viewing.

- You can also use the **OPTION** menu to select **Caption/Text**.

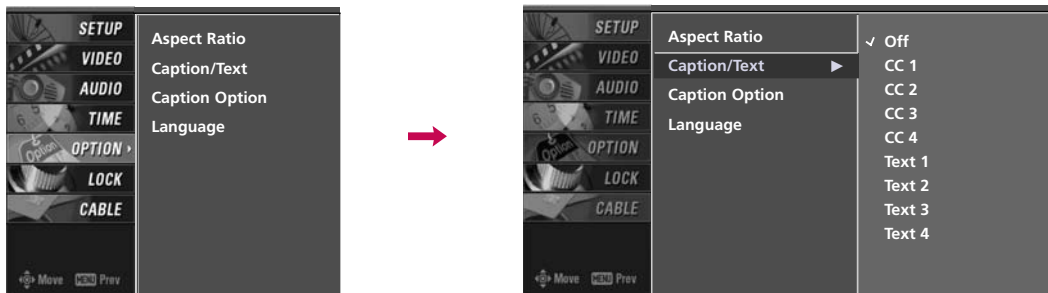

## Digital Broadcasting System Captions

Choose the language you want the DTV/CADTV Captions to appear in.

Languages can be chosen for digital sources only if they are included on the program.

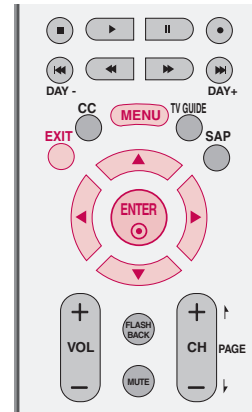

**1** Press the **MENU** button and then use **▲** or **▼** button to select the **OPTION** menu.

**2** Press the **▶** button and then use **▲** or **▼** button to select **Caption/Text**.

**3** Press the **▶** button and then use **▲** or **▼** button to select available caption languages : **English, Spanish** or **French**.

**4** Press **EXIT** button to return to TV viewing or press **MENU** button to return to the previous menu.

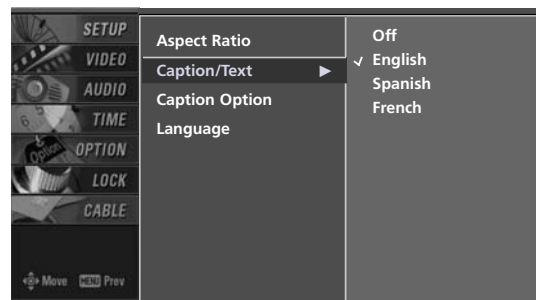
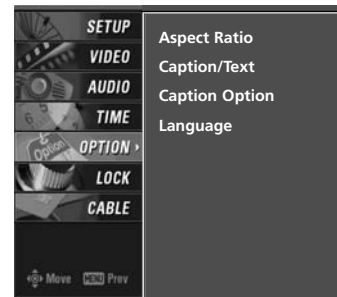

# TV MENU | OPTIONAL FEATURES

## CAPTION OPTION

Customize the DTV/CADTV captions that appear on your screen.

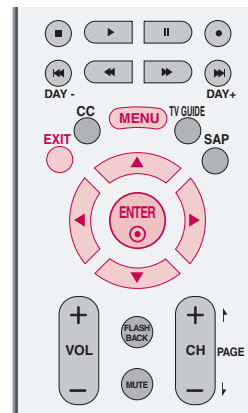

**1** Press the **MENU** button and then use **▲** or **▼** button to select the **OPTION** menu.

**2** Press the **▶** button and then use **▲** or **▼** button to select **Caption Option**.

**3** Press the **▶** button and then use **◀** or **▶** button to select **Custom**.

**4** Use **▲** or **▼** button to customize the **Style, Font, etc.**, to your preference.

A preview icon is provided at the bottom of the screen, use it to see the caption language.

- ▶ **Size** : Set the word size.
- ▶ **Font** : Select a typeface for the text.
- ▶ **Text Color** : Choose a color for the text.
- ▶ **Text Opacity** : Specify the opacity for the text color.
- ▶ **Bg (Background) Color** : Select a background color.
- ▶ **Bg (Background) Opacity** : Select the opacity for the background color.
- ▶ **Edge Type** : Select an edge type.
- ▶ **Edge Color** : Select a color for the edges.

**5** Press **EXIT** button to return to TV viewing or press **MENU** button to return to the previous menu.

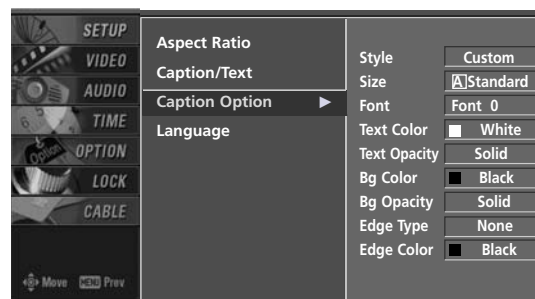
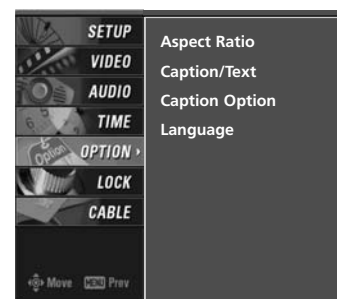

**3 4**

## BRIEF INFO.

### What is Brief Info.?

- : Brief Info shows the present screen information.
- : On Watching with the upper Input signal, press the **INFO** button.

### How To Use?

1. Press the **INFO** button to show the Brief Info on the screen.
2. Press the **INFO** button or **EXIT** button to exit.

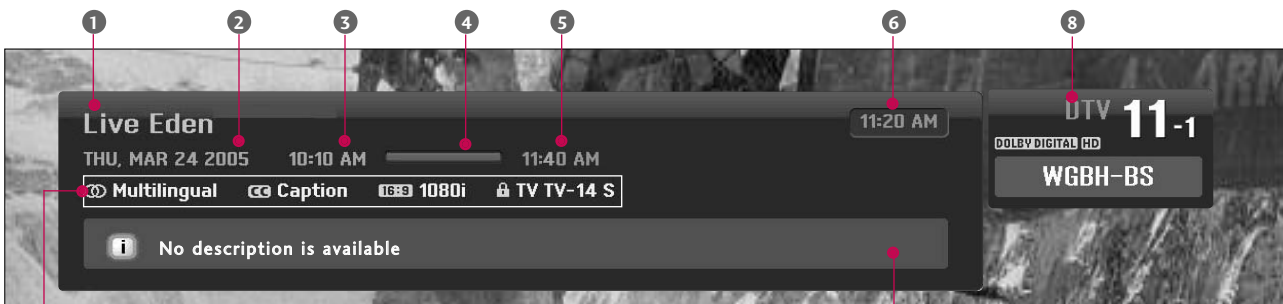
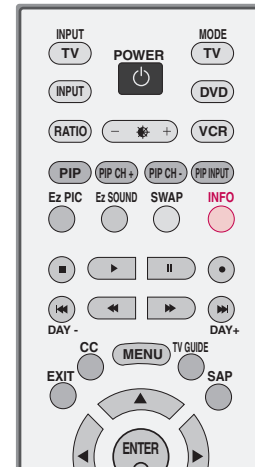

	<b>Multilingual</b> : Input Signal have over two Audio information.
	<b>Caption</b> : Input Signal have over one Close service.
	Screen Ratio of Input Signal 4:3
	Screen Ratio of Input Signal 16:9
	Resolution of Input Signal 720x480i
	Resolution of Input Signal 720x480p
	Resolution of Input Signal 1280x720p
	Resolution of Input Signal 1920x1080i
	Input Signal have rating information. Refer to the <Lock Menu>. D(Dialogue), L(Language), S(Sex), V(Violence), FV(Fantasy Violence)

- 1 Program title
- 2 Day, Month, Year
- 3 Program start time
- 4 Program progress bar
- 5 Program finish time
- 6 Present time
- 7 Program information
- 8 Banner information

## TV MENU | LOCK ADJUSTMENT

Parental Control can be used to block specific channels, ratings and other viewing sources.

The Parental Control Function (V-Chip) is used to block program viewing based on the ratings sent by the broadcasting station. The default setting is to allow all programs to be viewed. Viewing can be blocked by choosing the type of the program and the categories. It is also possible to block all program viewing for a time period. To use this function, the following must be done :

1. Set ratings and categories to be blocked.
2. Specify a password
3. Enable the lock

### V-Chip rating and categories

Rating guidelines are provided by broadcasting stations. Most television programs and television movies can be blocked by TV Rating and/or Individual Categories. Movies that have been shown at the theaters or direct-to-video movies use the Movie Rating System (MPAA) only.

### Ratings for Television programs including made-for-TV movies :

- TV-G (General audience)
- TV-PG (Parental guidance suggested)
- TV-14 (Parents strongly cautioned)
- TV-MA (Mature audience only)
- TV-Y (All children)
- TV-Y7 (Children 7 years older)

## SETTING UP YOUR PASSWORD

Set up blocking schemes to block specific channels, ratings, and external viewing sources.

A password is required to gain access to this menu.

- 1 Press the **MENU** button and then use the **▲** or **▼** button to select the **LOCK** menu. Then, press the **▶** button.

- Enter the password as requested.
- The TV is set up with the initial password "0-0-0-0".

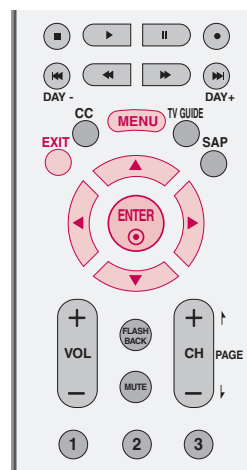
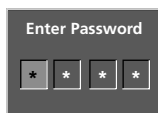

## LOCK SYSTEM

Enables or disables the blocking scheme you set up previously.

- 1 After inputting the password, use the ▲ or ▼ button to choose **Lock System**.
- 2 Press the ► button and then use the ▲ or ▼ button to select **On** or **Off**.
  - When you select **On**, the Lock System is enable.
- 3 Press **EXIT** button to return to TV viewing or press **MENU** button to return to the previous menu.

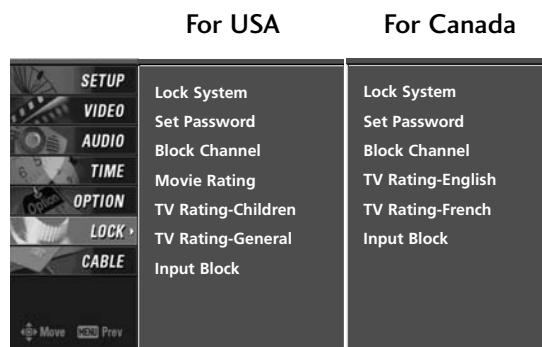

1

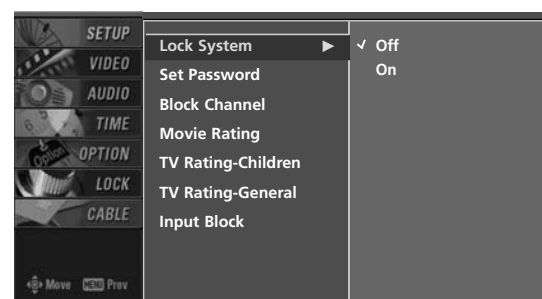

2

## SET PASSWORD

Change the password by inputting a new password twice.

- 1 After inputting the password, use the ▲ or ▼ button to choose **Set password**.
- 2 Press the ► button and then choose any 4 digits for your new password.
 

As soon as the 4 digits are entered, re-enter the same 4 digits on the **Confirm**.  
Then your changed password has been memorized.
- 3 Press **EXIT** to return to TV viewing or press **MENU** to return to the previous menu.

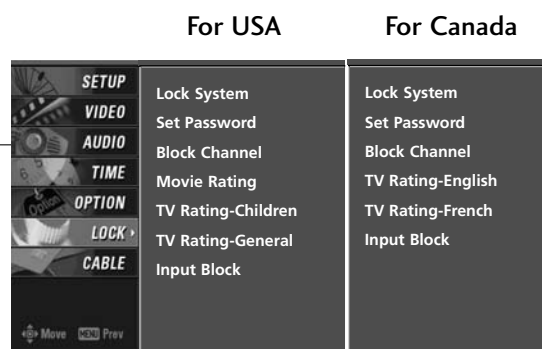

1

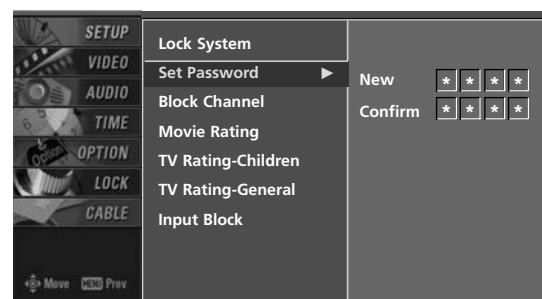

2

### ! NOTE

- ▶ If you ever forget your password, key in '7', '7', '7', '7' on the remote control.

# TV MENU | LOCK ADJUSTMENT

## BLOCK CHANNEL

Blocks any channels that you do not want to watch or that you do not want your children to watch.

**1** After inputting the password, use the ▲ or ▼ button to choose **Block Channel**.

**2** Press the ► button. You will now see a screen filled with channel numbers and a preview picture.

**3** Use ▲ ▼ ◀ ▶ button to select a channel and then use the **ENTER** button to block or unblock it.

**4** Press **EXIT** button to return to TV viewing or press **MENU** button to return to the previous menu.

For USA

For Canada

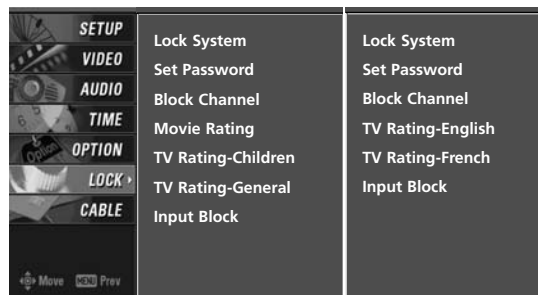

**1**

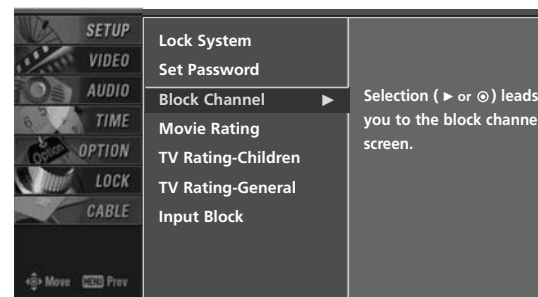

**2**

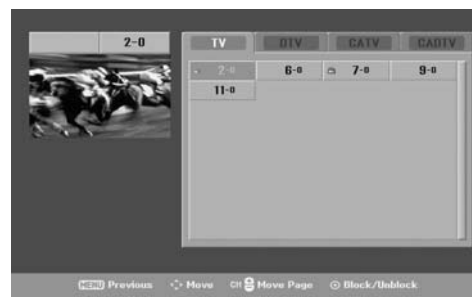

**3**

## MOVIE RATING (MPAA) - for USA only

Blocks movies according to the movie ratings limits specified, so children cannot view certain movies. You can set the ratings limit by blocking out all the movies with the ratings above a specified level. Keep in mind that the movie ratings limit only applies to movies shown on TV, not TV programs, such as soap operas.

**1** After inputting the password, use the ▲ or ▼ button to choose **Movie Rating**.

**2** Press the ► button and then use the ▲ or ▼ button to select **G, PG, PG-13, R, NC-17** or **X**.

- G (General audience)
- PG (Parental guidance suggested)
- PG-13 (Parents strongly cautioned)
- R (Restricted)
- NC-17 (No one 17 and under admitted)
- X (Adult only)
- Blocking Off (Permits all programs)

► If you set PG-13 : G and PG movies will be available, PG-13, R, NC-17 and X will be blocked.

**3** Press **EXIT** button to return to TV viewing or press **MENU** button to return to the previous menu.

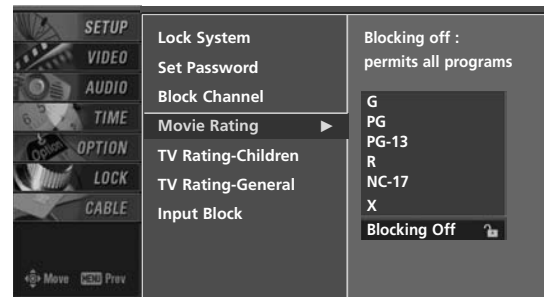
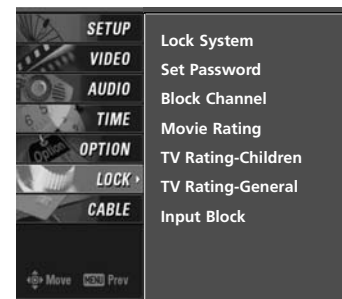

# TV MENU | LOCK ADJUSTMENT

## TV RATING CHILDREN - *for USA only*

Prevents children from watching certain children's TV programs, according to the ratings limit set. The children rating does not apply to other TV programs. Unless you block certain TV programs intended for mature audiences in the TV Rating - sub menu, your children can view those programs.

**1** After inputting the password, use the ▲ or ▼ button to choose **TV Rating-Children**.

**2** Press the ► button and then use the ▲ or ▼ button to select **Age**, or **Fantasy Violence**.  
Press the ► button and then use the ▲ or ▼ button to select block options.

- Age (applies to TV-Y, TV-Y7)
- Fantasy Violence (applies to TV-Y7)

**3** Press **EXIT** button to return to TV viewing or press **MENU** button to return to the previous menu.



1

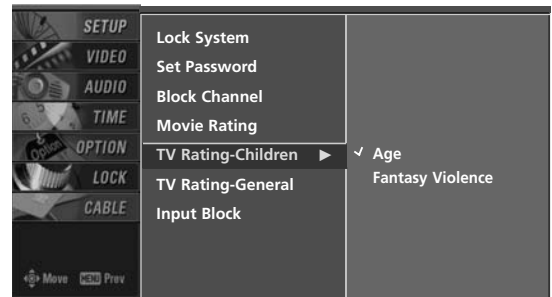

2

## TV RATING GENERAL - *for USA only*

Based on the ratings, blocks certain TV programs that you and your family do not want to view.

**1** After inputting the password, use the ▲ or ▼ button to choose **TV Rating-General**.

**2** Press the ► button and then use the ▲ or ▼ button to select **Age**, **Dialogue**, **Language**, **Sex** or **Violence**.  
Press the ► button and then use the ▲ or ▼ button to select block options.

- Age (applies to TV-G, TV-PG, TV-14, TV-MA)
- Dialogue-sexual dialogue (applies to TV-PG, TV-14)
- Language-adult language (applies to TV-PG, TV-14, TV-MA)
- Sex-sexual situations (applies to TV-PG, TV-14, TV-MA)
- Violence (applies to TV-PG, TV-14, TV-MA)

**3** Press **EXIT** button to return to TV viewing or press **MENU** button to return to the previous menu.

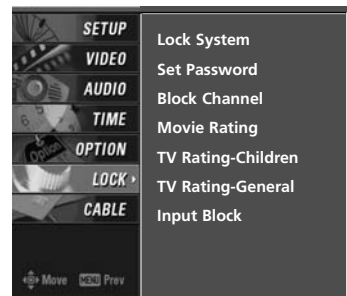

1

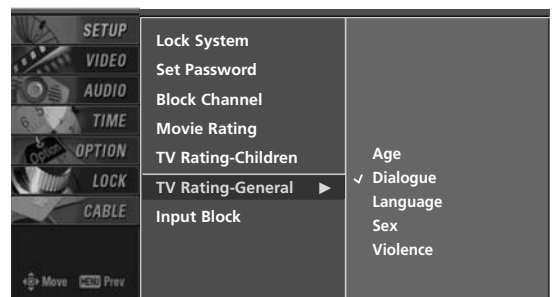

2

## TV RATING ENGLISH - for CANADA only

Selecting canadian english language rating system.

- 1 After inputting the password, use the ▲ or ▼ button to choose **TV Rating-English**.
- 2 Press the ► button and then use the ▲ or ▼ button to select **E, C, C8+, G, PG, 14+, 18+, or Blocking Off**.
  - E (Exempt)
  - C (Children)
  - C8+ (Children eight years and older)
  - G (General programming, suitable for all audiences)
  - PG (Parental Guidance)
  - 14+ (Viewers 14 years and older)
  - 18+ (Adult programming)
  - Blocking Off (Permits all programs)

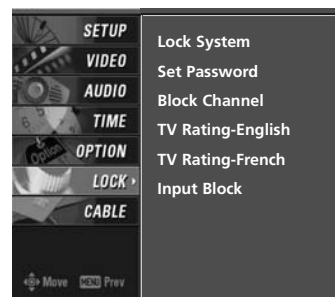

1

- 3 Press **EXIT** button to return to TV viewing or press **MENU** button to return to the previous menu.

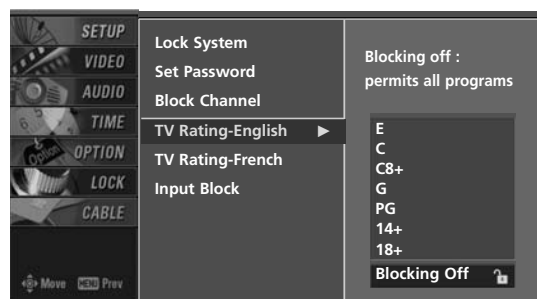

2

## TV RATING FRENCH - for CANADA only

Selecting canadian french language rating system.

- 1 After inputting the password, use the ▲ or ▼ button to choose **TV Rating-French**.
- 2 Press the ► button and then use the ▲ or ▼ button to select **E, G, 8ans+, 13ans+, 16ans+, 18ans+, or Blocking off**.
  - E(Exempt)
  - G(General)
  - 8ans+ (General-Not convenient for little children)
  - 13ans+ (Not convenient for children of 13 years and younger)
  - 16ans+ (Not convenient for children of 16 years and younger)
  - 18ans+ (This programs is only for adults)
  - Blocking off (Permits all programs)

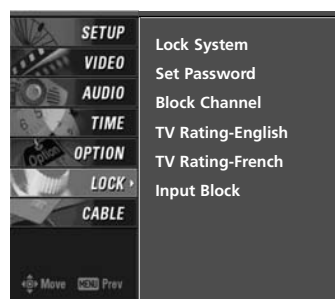

1

- 3 Press **EXIT** button to return to TV viewing or press **MENU** button to return to the previous menu.

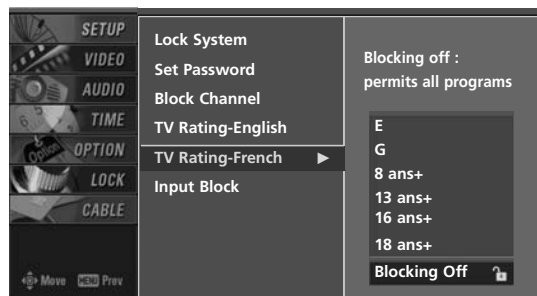

2

# TV MENU | LOCK ADJUSTMENT

## INPUT BLOCK

Enables you to select a source to block from the external source devices you have hooked up.

- 1 After inputting the password, use the ▲ or ▼ button to choose **Input Block**.
- 2 Press the ► button and then use the ◀ or ▶ button to select a source.
- 3 Press the ► button and then use the ▲ or ▼ button to select **On** or **Off** on the each source.
- 4 Press **EXIT** button to return to TV viewing or press **MENU** button to return to the previous menu.

For USA

For Canada

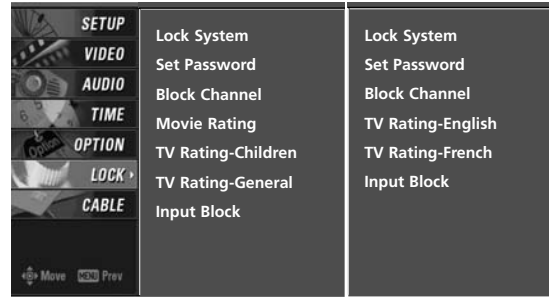

1

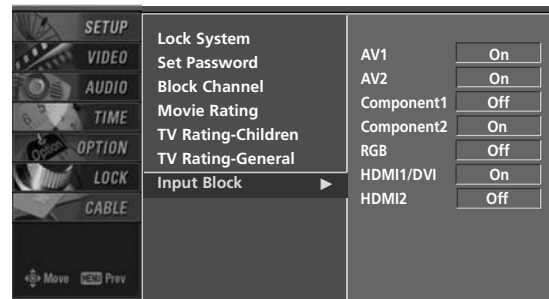

2 3

# TV MENU | CableCARD™ FUNCTION

*In this manual, the OSD (On Screen Display) may be different from your TV's because it is just example to help the TV operation.*

## CABLE MENU OPTIONS

The Cable sub menu displays when inserting the CableCARD™ to the TV.

The CableCARD™ type is Motorola, Scientific Atlanta (SA), or SCM etc. The OSD (On screen display) is different from your TV according to your CableCARD™ type.

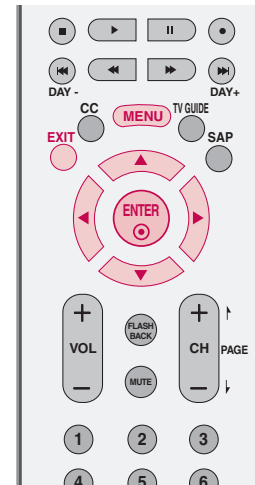

**1** Press the **MENU** button and then use ▲ or ▼ button to select the **CABLE** menu.

**2** Press the ► button and then use ▲ or ▼ button to select your desired item.

**3** Press the ► button.

**4** Press **EXIT** button to return to TV viewing.

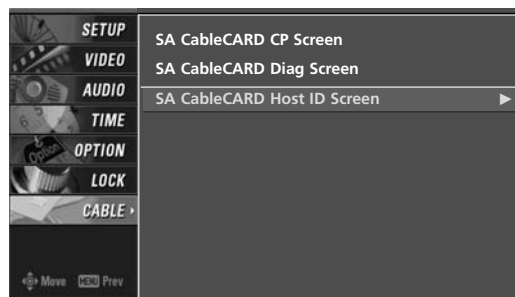

In case of Scientific Atlanta CableCARD™



**CableCARD™/ Host ID Screen**  
As shown, the pairing number means your TV and CableCARD™ ID. For further information regarding cable TV service, contact your local cable TV service provider(s).

# TV MENU | CableCARD™ FUNCTION

## SCRAMBLED CHANNEL

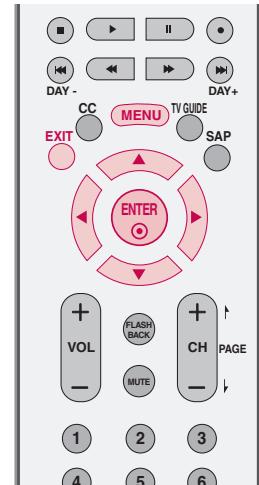

**1** Insert the CableCARD™. It takes about 1 minute to exchange data between the TV and the CableCARD™. The screen displays information as shown to the right.

**2** Let your cable TV service provider know the CableCARD™ ID and Host ID.

**3** If your cable TV service provider registers the CableCARD™ ID and Host ID, you can watch premium or high value channel. If you are subscribed to them.

**4** If you registered with the cable TV service provider, you can watch premium or high value channel without a message.

**5** If the certificates don't match between the TV and the CableCARD™, the OSD (On screen display) displays as shown right.

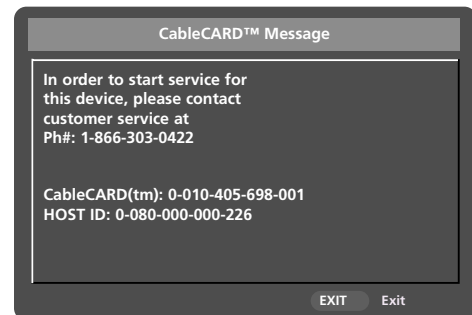

**1 2 3 4**



**5**

## CABLE CHANNEL LIST

- 1 If you select **Channel Edit** after running the EZ Scan without a CableCARD™, the cable channel list displays, as in the picture below.
- 2 Insert the CableCARD™. After a few minutes (about 2~3 minutes), the TV receives a new cable channel list. (Occasionally more time will be needed)

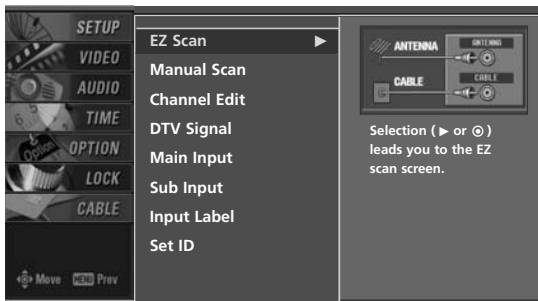

1

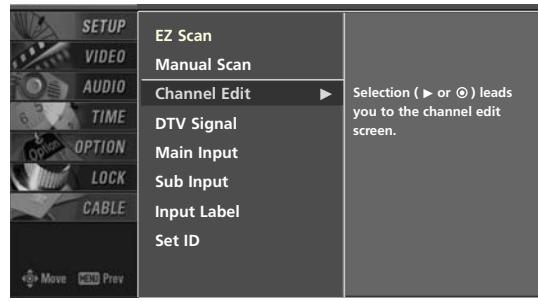

2

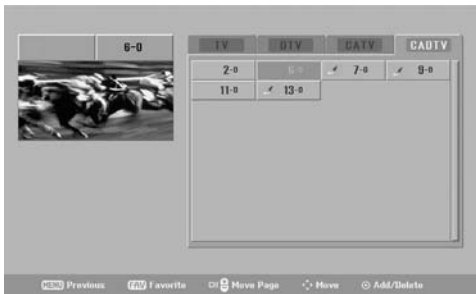

3

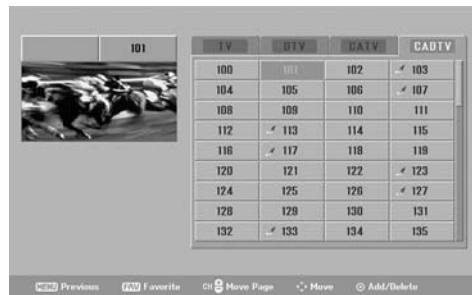

4

## EMERGENCY MESSAGE ALERT

- 1 If an emergency situation occurs while you are watching the TV/DTV/CATV/CADTV, you may receive a message from your cable TV service provider(s).
- 2 When receiving an emergency message, the message is displayed on the screen as shown or the channel is changed to one that maintains the emergency message. When the broadcast is complete the TV returns to the channel you were viewing.



1 2

# APPENDIX

## EXTERNAL CONTROL DEVICE SETUP

Connect the RS-232C (serial port) input jack to an external control device (such as a computer or an A/V control system) to control the product's functions externally.

Connect the serial port of the control device to the RS-232C jack on the product back panel.

Note: RS-232C connection cables are not supplied with the product.

### RS-232C Setup

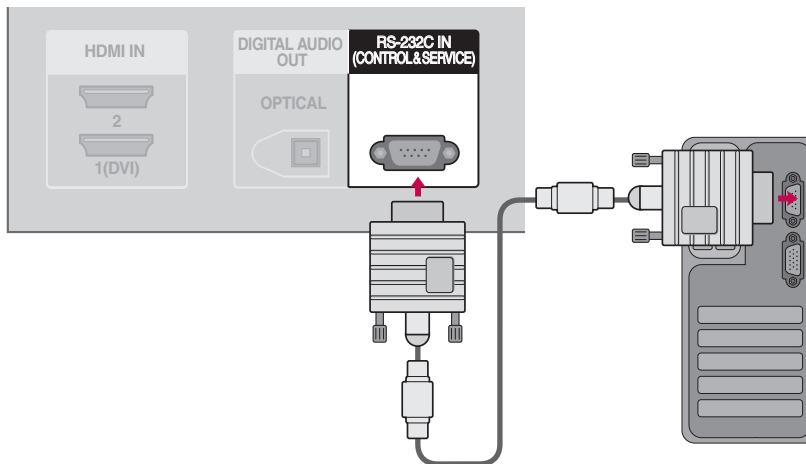

### Type of Connector; D-Sub 9-Pin Male

No.	Pin Name
1	No connection
2	RXD (Receive data)
3	TXD (Transmit data)
4	DTR (DTE side ready)
5	GND
6	DSR (DCE side ready)
7	RTS (Ready to send)
8	CTS (Clear to send)
9	No Connection

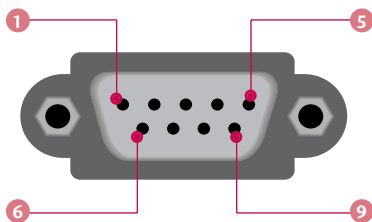

## RS-232C Configurations

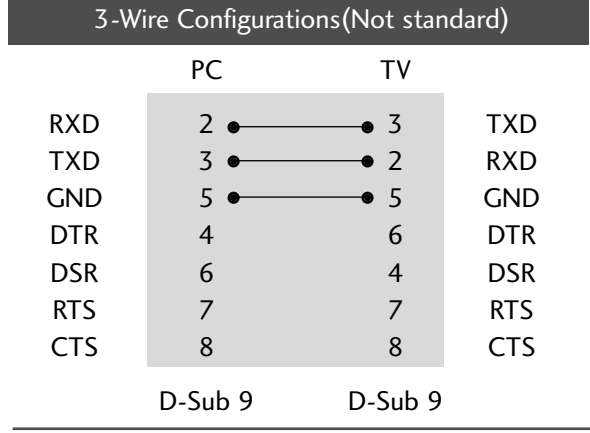
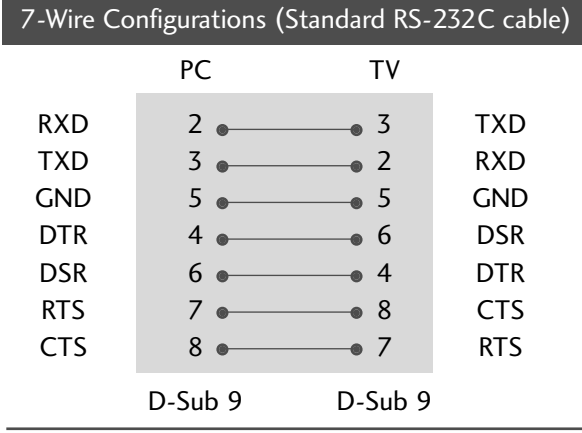

## Set ID

Use this function to specify a TV ID number.  
Refer to 'Real Data Mapping 1'. ► p.111.

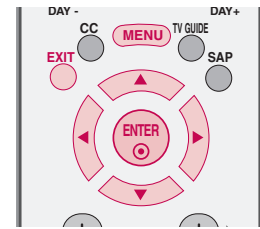

- 1 Press the **MENU** button and then use ▲ or ▼ button to select the **SETUP** menu.
- 2 Press the ► button and then use ▲ or ▼ button to select **Set ID**.
- 3 Press the ► button and then use ▲ or ▼ button to adjust **Set ID** to choose the desired TV ID number. The adjustment range of Set ID is 1~99.
- 4 Press **EXIT** button to return to TV viewing or press **MENU** button to return to the previous menu.

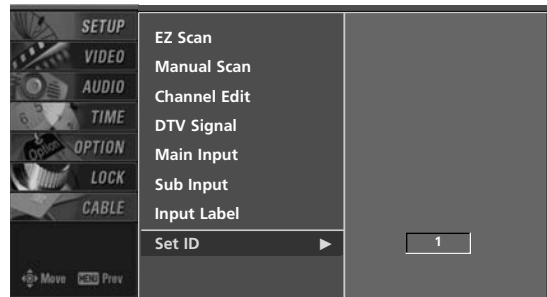

## Communication Parameters

- Baud rate : 9600 bps (UART)
- Data length : 8 bits
- Parity : None
- Stop bit : 1 bit
- Communication code : ASCII code
- Use a crossed (reverse) cable.

# APPENDIX

## Command Reference List

	COMMAND1	COMMAND2	DATA (Hexadecimal)		COMMAND1	COMMAND2	DATA (Hexadecimal)
01. Power	k	a	0 ~ 1	14. PIP/POP/Twin	k	n	0,1,2,5
02. Input Select	k	b	0 ~ 9	15. PIP Position	k	q	0 ~ 3
03. Aspect Ratio	k	c	(▶ p.111)	16. Treble	k	r	0 ~ 64
04. Screen Mute	k	d	0 ~ 1	17. Bass	k	s	0 ~ 64
05. Volume Mute	k	e	0 ~ 1	18. Balance	k	t	0 ~ 64
06. Volume Control	k	f	0 ~ 64	19. Color Temperature	k	u	0 ~ 3
07. Contrast	k	g	0 ~ 64	20. Red adjustment	k	v	0 ~ C8
08. Brightness	k	h	0 ~ 64	21. Green adjustment	k	w	0 ~ C8
09. Color	k	i	0 ~ 64	22. Blue adjustment	k	\$	0 ~ C8
10. Tint	k	j	0 ~ 64	23. PIP Input Select	k	y	0 ~ 3
11. Sharpness	k	k	0 ~ 64				
12. OSD Select	k	l	0 ~ 1				
13. Remote Control Lock Mode	k	m	0 ~ 1				

	COMMAND1	COMMAND2	DATA0 (Hexadecimal)	DATA1 (Hexadecimal)	DATA2 (Hexadecimal)	DATA3 (Hexadecimal)	DATA4 (Hexadecimal)	DATA5 (Hexadecimal)
24. Channel Tuning	m	a	physical program high	major program low	major low	minor high	minor low	attribute
25. Channel Add/Del	m	b	0 ~ 1					
26. Key	m	c	(▶ p.114)					
27. Input Select	x	b	(▶ p.114)					
28. PIP Input Select	x	y	(▶ p.114)					

## Transmission / Receiving Protocol

### Transmission

[Command1][Command2][ ][Set ID][ ][Data][Cr]

[Command 1] : First command to control the set.(j, k, m or x)

[Command 2] : Second command to control the set.

[Set ID] : You can adjust the set ID to choose desired TV ID number in Setup menu. Adjustment range is 1 ~ 99. When selecting Set ID '0', every connected the TV is controlled. Set ID is indicated as decimal (1 ~ 99) on menu and as Hexa decimal (0x0 ~ 0x63) on transmission/receiving protocol.

[DATA] : To transmit command data.

Transmit 'FF' data to read status of command.

[Cr] : Carriage Return

ASCII code '0x0D'

[ ] : ASCII code 'space (0x20)'

### OK Acknowledgement

[Command2][ ][Set ID][ ][OK][Data][x]

The TV transmits ACK (acknowledgement) based on this format when receiving normal data. At this time, if the data is data read mode, it indicates present status data. If the data is data write mode, it returns the data of the PC computer.

### Error Acknowledgement

[Command2][ ][Set ID][ ][NG][Data][x]

The TV transmits ACK (acknowledgement) based on this format when receiving abnormal data from non-viable functions or communication errors.

Data1: Illegal Code

Data2: Not supported function

Data3: Wait more time

**01. Power (Command2:a)**

To control Power On/Off of the TV.

**Transmission** [k][a][ ][Set ID][ ][Data][Cr]

Data 0 : Power Off      Data 1 : Power On

**Acknowledgement** [a][ ][Set ID][ ][OK/NG][Data][x]

\* In a like manner, if other functions transmit 'FF' data based on this format, Acknowledgement data feedback presents status about each function.

**02. Input Select (Command2:b) (Main Picture Input)**

To select input source for the TV.

**Transmission** [k][b][ ][Set ID][ ][Data][Cr]

Data 0: DTV                      Data 1: Analog  
Data 2: AV1                      Data 3: AV2  
Data 4: Component 1          Data 5: Component 2  
Data 6: RGB-DTV                Data 7: RGB-PC  
Data 8: HDMI1/DVI              Data 9: HDMI2

**Acknowledgement** [b][ ][Set ID][ ][OK/NG][Data][x]

**03. Aspect Ratio (Command2:c) (Main picture format)**

To adjust the screen format.

You can also adjust the screen format using the RATIO button on remote control or in the Option menu.

**Transmission** [k][c][ ][Set ID][ ][Data][Cr]

Date 1: 4:3                      5: Zoom 2  
2: 16:9                          6: Set by program  
3: Horizon                      10: Cinema Zoom (1)  
4: Zoom 1                        ⋮  
   1F: Cinema Zoom (16)

**Acknowledgement** [c][ ][Set ID][ ][OK/NG][Data][x]

**04. Screen Mute (Command2:d)**

To select screen mute on/off.

**Transmission** [k][d][ ][Set ID][ ][Data][Cr]

Data 0 : Screen mute off (Picture on)

Data 1 : Screen mute on (Picture off)

**Acknowledgement** [d][ ][Set ID][ ][OK/NG][Data][x]

**05. Volume Mute (Command2:e)**

To control volume mute on/off.

You can also adjust mute using the MUTE button on remote control.

**Transmission** [k][e][ ][Set ID][ ][Data][Cr]

Data 0 : Volume mute off (Volume on)

Data 1 : Volume mute on (Volume off)

**Acknowledgement** [e][ ][Set ID][ ][OK/NG][Data][x]

**06. Volume Control (Command2:f)**

To adjust volume.

You can also adjust volume with the volume buttons on remote control.

**Transmission** [k][f][ ][Set ID][ ][Data][Cr]

Data Min : 0 ~ Max : 64

Refer to 'Real data mapping1' as shown below.

**Acknowledgement** [f][ ][Set ID][ ][OK/NG][Data][x]

**07. Contrast (Command2:g)**

To adjust screen contrast.

You can also adjust contrast in the Video menu.

**Transmission** [k][g][ ][Set ID][ ][Data][Cr]

Data Min : 0 ~ Max : 64

Refer to 'Real data mapping1' as shown below.

**Acknowledgement** [g][ ][Set ID][ ][OK/NG][Data][x]

**08. Brightness (Command2:h)**

To adjust screen brightness.

You can also adjust brightness in the Video menu.

**Transmission** [k][h][ ][Set ID][ ][Data][Cr]

Data Min : 0 ~ Max : 64 (\*transmit by Hexadecimal code)

Refer to 'Real data mapping1' as shown below.

**Acknowledgement** [h][ ][Set ID][ ][OK/NG][Data][x]

**09. Color (Command2:i)**

To adjust the screen color.

You can also adjust color in the Video menu.

**Transmission** [k][i][ ][Set ID][ ][Data][Cr]

Data Min : 0 ~ Max : 64

Refer to 'Real data mapping1' as shown below.

**Acknowledgement** [i][ ][Set ID][ ][OK/NG][Data][x]

\*Real data mapping 1

0 : Step 0

⋮

A : Step 10 (SET ID 10)

⋮

F : Step 15 (SET ID 15)

10 : Step 16 (SET ID 16)

⋮

63 : Step 99 (SET ID 99)

64 : Step 100

# APPENDIX

## 10. Tint (Command2:j)

To adjust the screen tint.

You can also adjust tint in the Video menu.

*Transmission* [k][j][ ][Set ID][ ][Data][Cr]

Data Red : 0 ~ Green : 64

\*Refer to 'Real data mapping'. ► p.111.

*Acknowledgement* [ j ][ ][Set ID][ ][OK/NG][Data][x]

## 11. Sharpness (Command2:k)

To adjust the screen sharpness.

You can also adjust sharpness in the Video menu.

*Transmission* [k][k][ ][Set ID][ ][Data][Cr]

Data Min: 0 ~ Max: 64

\*Refer to 'Real data mapping'. ► p.111.

*Acknowledgement* [k][ ][Set ID][ ][OK/NG][Data][x]

## 12. OSD Select (Command2:l)

To select OSD (On Screen Display) on/off.

*Transmission* [k][l][ ][Set ID][ ][Data][Cr]

Data 0: OSD off                      Data 1: OSD on

*Acknowledgement* [l][ ][Set ID][ ][OK/NG][Data][x]

## 13. Remote Control Lock Mode (Command2:m)

To lock the remote control and the front panel controls on the set.

*Transmission* [k][m][ ][Set ID][ ][Data][Cr]

Data 0: Lock off                      Data 1: Lock on

*Acknowledgement* [m][ ][Set ID][ ][OK/NG][Data][x]

If you're not using the remote control and front panel controls on the TV, use this mode. When main power is on/off, remote control lock is released.

## 14. PIP / POP / Twin Picture (Command2:n)

To control the PIP (Picture-in-Picture)/POP/Twin picture. You can also control the PIP/POP/Twin picture using the PIP button on the remote control.

*Transmission* [k][n][ ][Set ID][ ][Data][Cr]

Data 0: PIP Off                      2: Twin picture  
1: PIP                                      5: POP4(POP Scan)

*Acknowledgement* [n][ ][Set ID][ ][OK/NG][Data][x]

## 15. PIP Position (Command2:q)

To select sub picture position for PIP.

*Transmission* [k][q][ ][Set ID][ ][Data][Cr]

Data 0: Right down on screen

Data 1: Left down on screen

Data 2: Left up on screen

Data 3: Right up on screen

*Acknowledgement* [q][ ][Set ID][ ][OK/NG][Data][x]

## 16. Treble (Command2:r)

To adjust treble.

You can also adjust treble in the Audio menu.

*Transmission* [k][r][ ][Set ID][ ][Data][Cr]

Data Min: 0 ~ Max: 64(\*transmit by Hexadecimal code)

\*Refer to 'Real data mapping'. ► p.111.

*Acknowledgement* [r][ ][Set ID][ ][OK/NG][Data][x]

## 17. Bass (Command2:s)

To adjust bass.

You can also adjust bass in the Audio menu.

*Transmission* [k][s][ ][Set ID][ ][Data][Cr]

Data Min: 0 ~ Max: 64(\*transmit by Hexadecimal code)

\*Refer to 'Real data mapping'. ► p.111.

*Acknowledgement* [s][ ][Set ID][ ][OK/NG][Data][x]

## 18. Balance (Command2:t)

To adjust balance.

You can also adjust balance in the Audio menu.

*Transmission* [k][t][ ][Set ID][ ][Data][Cr]

Data Min: 0 ~ Max: 64(\*transmit by Hexadecimal code)

\*Refer to 'Real data mapping'. ► p.111.

*Acknowledgement* [t][ ][Set ID][ ][OK/NG][Data][x]

## 19. Color Temperature (Command2:u)

To adjust color temperature.

You can also adjust color temperature in the Video menu.

*Transmission* [k][u][ ][Set ID][ ][Data][Cr]

Data 0: Medium    1: Cool    2: Warm    3: User

*Acknowledgement* [u][ ][Set ID][ ][OK/NG][Data][x]

## 20. Red adjustment(Command:v)

To adjust red in color temperature

*Transmission* [k][v][ ][Set ID][ ][Data][Cr]

Data Min:0 ~ Max:C8

\*Refer to "Real data mapping 2". ► p.113.

*Acknowledgement* [v][ ][Set ID][ ][OK/NG][Data][x]

**21. Green adjustment(Command:w)**

To adjust green in color temperature.

*Transmission* [k][w][ ][Set ID][ ][Data][Cr]

Data Min:0 ~ Max:C8

\*Refer to "Real data mapping 2" as shown below.

*Acknowledgement* [w][ ][Set ID][ ][OK/NG][Data][x]

**22. Blue adjustment(Command:\$)**

To adjust blue in color temperature.

*Transmission* [k][\$][ ][Set ID][ ][Data][Cr]

Data Min:0 ~ Max:C8

\*Refer to "Real data mapping 2" as shown below.

*Acknowledgement* [\$][ ][Set ID][ ][OK/NG][Data][x]

\*Real data mapping 2

0 : -20

5 : -19

A : -18

⋮

5F: -1

64: 0

69: +1

⋮

C3 : +19

C8 : +20

**23. PIP Input Select (Command2:y)**

To select input source for sub picture in PIP/Twin picture mode.

*Transmission* [k][y][ ][Set ID][ ][Data][Cr]

Data 0: DTV

1: Analog

2: AV1

3: AV2

*Acknowledgement* [y][ ][Set ID][ ][OK/NG][Data][x]

**24. Channel Tuning (Command: m a)**

To tune channel to following physical/major/minor number.

*Transmission* [m][a][ ][Set ID][ ][Data0][ ][Data1][ ][Data2][ ][Data3][ ][Data4][ ][Data5][Cr]

Data 0: Physical Channel Number(Transmit by Hexadecimal code)

NTSC air:02~45

NTSC cable: 01, 0E~7D

ATSC air:01~45

ATSC cable:01~87

Data 1,Data2: Major Channel Number (two part) / Channel Number (One part)

Data1: High byte

Data2: Low byte

Two part channel number:

Major number-Minor number

One part channel number:

If the channel band is ATSC digital cable, it can be used. In case of using one part channel number, minor channel does not need.

Data3, Data 4: Minor Channel Number

Data3: High byte , Data4: Low byte

(Next page continued)

# APPENDIX

Data5:	7 Main/Sub Picture	6 Two/One Part Channel	5 Using Physical Channel	4 Reserved	3	2	1	0	Step
0	Main	0 Two	0 Use	x	0	0	0	0	NTSC Air
1	Sub	1 One	1 No Use	x	0	0	0	1	NTSC Cable
				x	0	0	1	0	ATSC Air
				x	0	0	1	1	ATSC Cable_std
				x	0	1	0	0	ATSC Cable_hrc
				x	0	1	0	1	ATSC Cable_irc
				x	0	1	1	0	ATSC cable_auto
				x	1	1	1	1	Reserved
				x	x	x	x	x	-
				x	1	1	1	1	Reserved

All data are transmitted by Hexadecimal code

\* Two/One part Channel: 6th bit

This bit is used in a cable-ready system.

\* Using physical channel: 5th bit

If the channel band is NTSC air or NTSC cable, channel tuning can be done by only physical channel. In this case, using physical channel bit must be low(0).

But if the channel band is ATSC air or ATSC cable, there are two cases that physical channel enable or disable.

If the physical channel sending is meaningful, you should set this bit low(0). If the physical channel sending is meaningless, you should set this bit high(1).

Example)

1. Analog channel: NTSC cable, channel number(35), main picture Command: ma 00 23 xx xx xx xx 01  
attribute(0x01): main picture, two part(it's not mandatory), using physical channel, NTSC cable 'xx' data: don't care major and minor channel number in case analog channel tuning.
2. Digital channel: ATSC air, channel number(don't know physical channel, major(30), minor(3)), sub picture Command: ma 00 xx 00 1E 00 03 A2  
attribute(0xA2): sub picture, two part, not using physical channel, ATSC air 'xx' data: don't care analog channel number in case digital channel tuning.
3. Digital channel: ATSC air, channel number(physical(20),major(20), minor(3)), sub picture Command: ma 00 14 00 14 00 03 82

attribute(0x82): sub picture, two part, using physical channel, ATSC air.

```
Acknowledgement[a][ ][Set ID][ ][OK][Data0][Data1][Data2][Data3][Data4][x][a][ ][Set ID][ ][NG][Data0][x]
```

## 25. Channel Add/Del (Command: m b)

To add and delete the channels

```
Transmission [m][b][ ][Set ID][ ][Data][Cr]
```

Data 0: Channel Delete      Data 1: Channel Add

```
Acknowledgement [b][ ][Set ID][ ][OK/NG][Data][x]
```

## 26. Key (Command: m c)

To send IR remote key code.

```
Transmission [m][c][ ][Set ID][ ][Data][Cr]
```

Data Key code: Refer to page 116.

```
Acknowledgement [c][ ][Set ID][ ][OK/NG][Data][x]
```

## 27. Input select(Command: x b) (Main Picture Input)

To select input source for TV.

```
Transmission [x][b][ ][Set ID][ ][Data][Cr]
```

Data 00 : DTV (Antenna)      Data 01 : DTV (Cable)

Data 10 : Analog (Antenna)      Data 11 : Analog (Cable)

Data 20 : AV1      Data 21 : AV2

Data 40 : Component 1      Data 41 : Component 2

Data 50 : RGB DTV      Data 60 : RGB PC

Data 90 : HDMI1/DVI      Data 91 : HDMI2

```
Acknowledgement [b][ ][Set ID][ ][OK/NG][Data][x]
```

## 28. PIP Input Select(Command: x y)

To adjust input source for sub picture in PIP mode.

```
Transmission [x][y][ ][Set ID][ ][Data][Cr]
```

Data 00 : DTV (Antenna)

Data 01 : DTV (Cable)

Data 10 : Analog (Antenna)

Data 11 : Analog (Cable)

Data 20 : AV1

Data 21 : AV2

```
Acknowledgement [y][ ][Set ID][ ][OK/NG][Data][x]
```

# IR CODES

## 1. How to Connect

- Connect your wired remote control to the Remote Control port on the TV.

## 2. Remote Control IR Codes

### ■ Output waveform

Single pulse, modulated with 37.917KHz signal at 455KHz

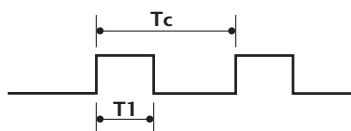

Carrier frequency  
 $FCAR = 1/TC = fOSC/12$   
 Duty ratio =  $T1/TC = 1/3$

### ■ Configuration of frame

1st frame

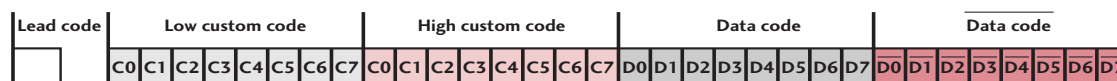

Repeat frame

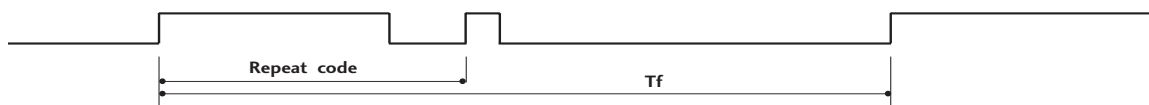

### ■ Lead code

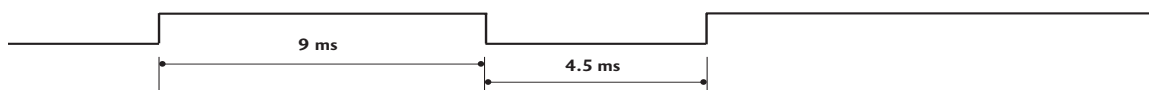

### ■ Repeat code

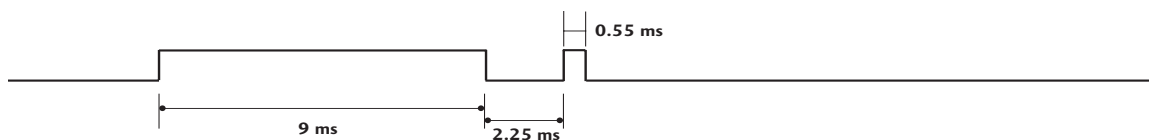

### ■ Bit description





### ■ Frame interval: Tf

The waveform is transmitted as long as a key is depressed.



# APPENDIX

Code (Hexa)	Function	Note	Code (Hexa)	Function	Note
0F	TV INPUT	Remote control Button	BF	COMPONENT1	Discrete IR Code
0B	INPUT	Remote control Button			(Component1 Input Selection)
08	POWER	Remote control Button (Power On/Off)	D4	COMPONENT2	Discrete IR Code
79	RATIO	Remote control Button			(Component2 Input Selection)
0E	TIMER	Remote control Button	D5	RGB-PC	Discrete IR Code
10-19	Number Key 0-9	Remote control Button			(RGB-PC Input Selection)
4C	- (Dash)	Remote control Button	D7	RGB-DTV	Discrete IR Code
1A	FLASHBK	Remote control Button			(RGB-DTV Input Selection)
09	MUTE	Remote control Button	C6	HDMI1/DVI	Discrete IR Code
02	VOL +	Remote control Button			(HDMI1/DVI Input Selection)
03	VOL -	Remote control Button	CC	HDMI2	Discrete IR Code
00	CH +	Remote control Button			(HDMI2 Input Selection)
01	CH -	Remote control Button	76	Ratio 4:3	Discrete IR Code
1E	FAV	Remote control Button			(Only 4:3 Mode)
AA	INFO	Remote control Button	77	Ratio 16:9	Discrete IR Code
39	CC	Remote control Button			(Only 16:9 Mode)
40	▲	Remote control Button	AF	Ratio Zoom	Discrete IR Code
41	▼	Remote control Button			(Only Zoom1 Mode)
07	◀	Remote control Button	70	POP	Discrete IR Code
06	▶	Remote control Button			(Channel Search)
44	ENTER	Remote control Button	C4	POWER ON	Discrete IR Code
43	MENU	Remote control Button			(Only Power On)
52	EZ SOUND	Remote control Button	C5	POWER OFF	Discrete IR Code
4D	EZ PIC	Remote control Button			(Only Power Off)
5B	EXIT	Remote control Button	A9	TV GUIDE	Remote control Button
60	PIP	Remote control Button	92	APM	Remote control Button
72	PIPCH -	Remote control Button	E1	- 	Remote control Button
71	PIPCH +	Remote control Button	E0	 +	Remote control Button
61	PIP INPUT	Remote control Button			
63	SWAP	Remote control Button			
0A	SAP	Remote control Button			
CB	ADJUST	Remote control Button			
D6	TV	Discrete IR Code (TV Input Selection)			
5A	AV1	Discrete IR Code (AV1 Input Selection)			
D0	AV2	Discrete IR Code (AV2 Input Selection)			

## PROGRAMMING THE REMOTE CONTROL

The provided universal remote control can be programmed to operate most remote-controllable devices. Note that the remote may not control all models of other brands.

### Programming a code into a remote mode

- 1** To find out whether your remote control can operate each device without programming, turn on the device (such as a VCR) and press the corresponding mode button on the remote. After that, press the **POWER** button. If the device is turned off and it responds properly the remote control need not be programmed. If not, the remote should be programmed to operate the device. The programming procedures are explained below.
- 2** Press the **MENU** and **MUTE** button continuously at the same time for two seconds; the currently selected device button is illuminated. If you don't press any button for 20 seconds, the light on the mode button will be turned off. In that case, you have to repeat from step 2.
- 3** Enter the appropriate code from the code table on the following pages. When pressing the button, the light blinks at a time. If the device turned off, the programming is successful.
- 4** Press the **MENU** button to store the code. After blinking twice, this code is stored.
- 5** Test the remote control functions to see if the device responds properly. If not, steps 2-5.

## APPENDIX

## PROGRAMMING CODES

## VCRs

Brand	Codes	Brand	Codes	Brand	Codes
AIWA	034	MAGNAVOX	031 033 034 041	SAMSUNG	032 040 102 104
AKAI	016 043 046 124 125 146		067 068 012 031 033 067		105 107 109 112 113 115 120 122 125
AMPRO	072	MARANTZ	069		
ANAM	031 033 103	MARTA	101	SANSUI	022 043 048 135
AUDIO DYNAMICS	012 023 039 043	MATSUI	027 030	SANYO	003 007 010 014 102 134
BROKSONIC	035 037 129	MEI	031 033	SCOTT	017 037 112 129 131
CANON	028 031 033	MEMOREX	003 010 014 031 033 034 053 072 101 102 134 139	SEARS	003 008 009 010 013 014 017 020 031 042 073 081 101
CAPEHART	108			SHARP	031 054 149
CRAIG	003 040 135	MGA	045 046 059	SHINTOM	024
CURTIS MATHES	031 033 041	MINOLTA	013 020	SONY	003 009 031 052 056 057 058 076 077 078 149
DAEWOO	005 007 010 064 065 108 110 111 112 116 117 119	MITSUBISHI	013 020 045 046 049 051 059 061 151	SOUNDESIGN	034
DAYTRON	108	MTC	034 040	STS	013
DBX	012 023 039 043	MULTITECH	024 034	SYLVANIA	031 033 034 059 067
DYNATECH	034 053	NEC	012 023 039 043 048	SYMPHONIC	034
ELECTROHOME	059			TANDY	010 034
EMERSON	006 017 025 027 029 031 034 035 036 037 046 101 129 131 138 153	NORDMENDE	043	TATUNG	039 043
FISHER	003 008 009 010	OPTONICA	053 054	TEAC	034 039 043
FUNAI	034	PANASONIC	066 070 074 083 133 140 145	TECHNICS	031 033 070
GE	031 033 063 072 107 109 144 147	PENTAX	013 020 031 033 063	TEKNIKA	019 031 033 034 101
GO VIDEO	132 136	PHILCO	031 034 067	THOMAS	034
HARMAN KARDON	012 045	PHILIPS	031 033 034 054 067 071 101	TMK	006
HITACHI	004 018 026 034 043 063 137 150	PILOT	101	TOSHIBA	008 013 042 047 059 082 112 131
INSTANTREPLAY	031 033	PIONEER	013 021 048	TOTEVISION	040 101
JCL	031 033	PORTLAND	108	UNITECH	040
JCPENNY	012 013 015 033 040 066 101	PULSAR	072	VECTOR RESEARCH	012
JENSEN	043	QUARTZ	011 014	VICTOR	048
JVC	012 031 033 043 048 050 055 060 130 150 152	QUASAR	033 066 075 145	VIDEO CONCEPTS	012 034 046
KENWOOD	014 034 039 043 047 048	RCA	013 020 033 034 040 041 062 063 107 109 140 144 145 147	VIDEOSONIC	040
LG (GOLDSTAR)	001 012 013 020 101 106 114 123	REALISTIC	003 008 010 014 031 033 034 040 053 054 101	WARDS	003 013 017 024 031 033 034 040 053 054 131
LLOYD	034	RICO	058	YAMAHA	012 034 039 043
LXI	003 009 013 014 017 034 101 106	RUNCO	148	ZENITH	034 048 056 058 072 080 101
MAGIN	040	SALORA	014		

**DVD**

Brand	Codes	Brand	Codes	Brand	Codes
APEX DIGITAL	022	MITSUBISHI	002	RCA	005 006
DENON	020 014	NAD	023	SAMSUNG	011 015
GE	005 006	ONKYO	008 017	SONY	007
HARMAN KARDON	027	PANASONIC	003 009	THOMPSON	005 006
JVC	012	PHILIPS	013	TOSHIBA	019 008
LG	001 010 016 025	PIONEER	004 026	YAMAHA	009 018
MAGNAVOX	013	PROCEED	021	ZENITH	010 016 025
MARANTZ	024	PROSCAN	005 006		

# APPENDIX

## TROUBLESHOOTING CHECKLIST

### The operation does not work normally.

The remote control doesn't work

- Check to see if there is any object between the product and the remote control causing obstruction. Ensure you are pointing the remote control directly at the TV.
- Ensure that the batteries are installed with correct polarity (+ to +, - to -).
- Ensure that the correct remote operating mode is set: TV, VCR etc.
- Install new batteries.

Power is suddenly turned off

- Is the sleep timer set?
- Check the power control settings. Power interrupted.
- No broadcast on station tuned with Auto off activated.

### The operation does not work normally.

No picture & No sound

- Check whether the product is turned on.
- Try another channel. The problem may be with the broadcast.
- Is the power cord inserted into wall power outlet?
- Check your antenna direction and/or location.
- Test the wall power outlet, plug another product's power cord into the outlet where the product's power cord was plugged in.

Picture appears slowly after switching on

- This is normal, the image is muted during the product startup process. Please contact your service center, if the picture has not appeared after five minutes.

No or poor color or poor picture

- Adjust Color in menu option.
- Keep a sufficient distance between the product and the VCR.
- Try another channel. The problem may be with the broadcast.
- Are the video cables installed properly?
- Activate any function to restore the brightness of the picture.

Horizontal/vertical bars or picture shaking

- Check for local interference such as an electrical appliance or power tool.

Poor reception on some channels

- Station or cable product experiencing problems, tune to another station.
- Station signal is weak, reorient antenna to receive weaker station.
- Check for sources of possible interference.

Lines or streaks in pictures

- Check antenna (Change the direction of the antenna).

**The audio function does not work.**

Picture OK & No sound	<ul style="list-style-type: none"> <li>■ Press the VOL or VOLUME button.</li> <li>■ Sound muted? Press MUTE button.</li> <li>■ Try another channel. The problem may be with the broadcast.</li> <li>■ Are the audio cables installed properly?</li> </ul>
No output from one of the speakers	<ul style="list-style-type: none"> <li>■ Adjust Balance in menu option.</li> </ul>
Unusual sound from inside the product	<ul style="list-style-type: none"> <li>■ A change in ambient humidity or temperature may result in an unusual noise when the product is turned on or off and does not indicate a fault with the product.</li> </ul>

**There is a problem in PC mode. (Only PC mode applied)**

The signal is out of range	<ul style="list-style-type: none"> <li>■ Adjust resolution, horizontal frequency, or vertical frequency.</li> <li>■ Check the input source.</li> </ul>
Vertical bar or stripe on background & Horizontal Noise & Incorrect position	<ul style="list-style-type: none"> <li>■ Work the Auto configure or adjust clock, phase, or H/V position. (Option)</li> </ul>
Screen color is unstable or single color	<ul style="list-style-type: none"> <li>■ Check the signal cable.</li> <li>■ Reinstall the PC video card.</li> </ul>

# APPENDIX

## There is a problem on the TV Guide On Screen™ function.

My Guide listings disappeared after a power failure	<ul style="list-style-type: none"> <li>■ You should begin to receive listings again within 24 hours.</li> </ul>
Some channel numbers in the Guide are incorrect.	<ul style="list-style-type: none"> <li>■ You can correct them using Change Channel Display under the Setup menu.</li> </ul>
I have not received any Guide listings.	<ul style="list-style-type: none"> <li>■ Listings usually appear within 24 hours after a successful Setup.</li> <li>■ It may take up to a week to fill the Listings grid with the full 8 days of listings.</li> <li>■ If you see a Listings grid with the message "No Listings" displayed you should start to receive updated program listings within 24 hours.</li> <li>■ If the message "No data for this screen" is displayed:             <ul style="list-style-type: none"> <li>- Check the connections between the TV, cable, antenna.</li> <li>- Verify Setup information under Change System Settings.</li> <li>- If this message is still displayed after multiple days, please contact the LG®Brand Customer Support.</li> </ul> </li> </ul>
A show I set to Remind did not.	<ul style="list-style-type: none"> <li>■ Check the Schedule menu and verify that the show is listed as a reminder.</li> </ul>
I set a show to Auto-Tune and it did not.	<ul style="list-style-type: none"> <li>■ Check the Schedule menu and verify that the show is listed as a Reminder.</li> <li>■ Highlight the show under Listings and do the following:             <ul style="list-style-type: none"> <li>- Press the Menu key on the remote.</li> <li>- Use the down arrow to highlight Edit Reminder, and press <b>ENTER</b>.</li> <li>- Verify the Auto-Tune option reads Yes.</li> </ul> </li> <li>■ The TV must be On at the scheduled time for Auto-Tune.</li> </ul>
I set a show with the Power On TV option and it did not	<ul style="list-style-type: none"> <li>■ Check the Schedule menu and verify that the show is listed as a Reminder.</li> <li>■ Highlight the show under Listings and do the following:             <ul style="list-style-type: none"> <li>- Press the Menu key on the remote.</li> <li>- Use the down arrow to highlight Edit Reminder, and press <b>ENTER</b>.</li> <li>- Verify the Power On TV option reads Yes.</li> </ul> </li> </ul>

## MAINTENANCE

Early malfunctions can be prevented. Careful and regular cleaning can extend the amount of time you can enjoy your new TV.

**Caution:** Be sure to turn the power off and unplug the power cord before you begin any cleaning.

### Cleaning the Screen

- 1 Here's a great way to keep the dust off your screen for a while. Wet a soft cloth in a mixture of lukewarm water and a little fabric softener or dish washing detergent. Wring the cloth until it's almost dry, and then use it to wipe the screen.
- 2 Make sure the excess water is off the screen, and then let it air-dry before you turn on your TV.

### Cleaning the Cabinet

- To remove dirt or dust, wipe the cabinet with a soft, dry, lint-free cloth.
- Please be sure not to use a wet cloth.

### Extended Absence

#### **⚠ CAUTION**

- ▶ If you expect to leave your TV dormant for a long time (such as a vacation), it's a good idea to unplug the power cord to protect against possible damage from lightning or power surges.

# APPENDIX

## PRODUCT SPECIFICATIONS

MODELS		47LB1 DA (47LB1 DA-UB)
Dimensions (Width x Height x Depth)	including stand	50.4 x 32.6 x 12.4 inches 1280.0 x 828.0 x 315.0 mm
	excluding stand	50.4 x 28.3 x 5.3 inches 1280.0 x 719.0 x 135.0 mm
Weight	including stand	124.6 pounds / 56.5 kg
	excluding stand	98.9 pounds / 44.9 kg
Power requirement		AC100-240V ~ 50/60Hz
Television System		NTSC-M, ATSC, 64 & 256 QAM
Program Coverage		VHF 2-13, UHF 14-69, CATV 1-135, DTV 2-69, CADTV 1-135
External Antenna Impedance		75 ohm
Environment condition	Operating Temperature	32 ~ 104°F (0 ~ 40°C)
	Operating Humidity	Less than 80%
	Storage Temperature	-4 ~ 140°F (-20 ~ 60°C)
	Storage Humidity	Less than 85%

- The specifications shown above may be changed without prior notice for quality improvement.