

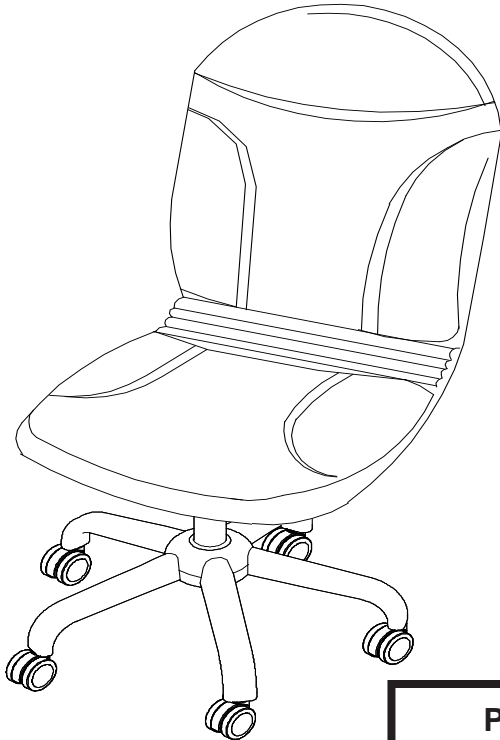

#34731

Olympus Big & Tall Chair







Email us at support@moorecoinc.com
 if you have Missing or Damaged Parts

24 Hours a Day 7 Days a Week

Should you require assistance during
 assembly, please call our Customer
 Service Department Monday - Friday
 8 a.m. - 5 p.m. Central Standard Time

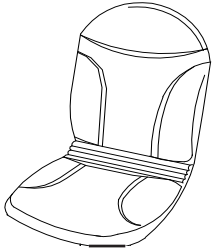
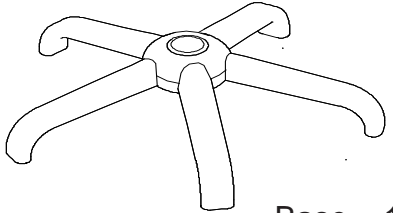
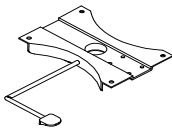
1-800-749-2258

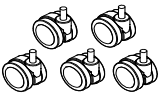
Parts/Hardware

<p>P1</p>  <p>Chair 1 EA</p>	<p>P2</p>  <p>Base 1 EA</p>		
<p>P3</p>  <p>Seat Support 1 EA</p>	<p>P4</p>  <p>Cylinder 1 EA</p>	<p>P5</p>  <p>Casters 5 EA</p>	<p>P6</p>  <p>1"- Screws 4 EA</p>

Do not use unless all screws are tight. At least every six months, check all screws to be sure they are tight. If any parts are missing, broken, damaged or worn, stop using the product until repairs are made by your dealer using factory authorized parts.

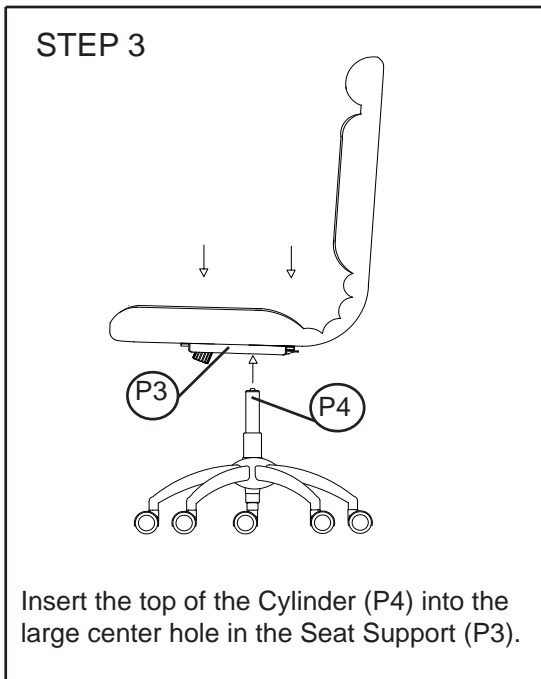
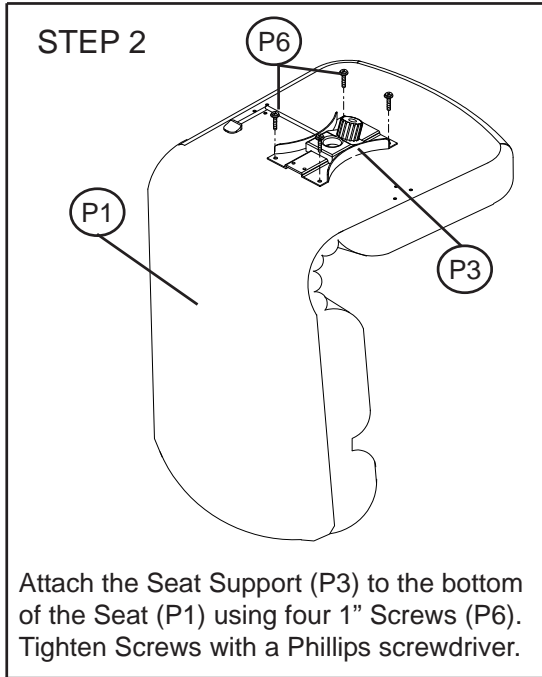
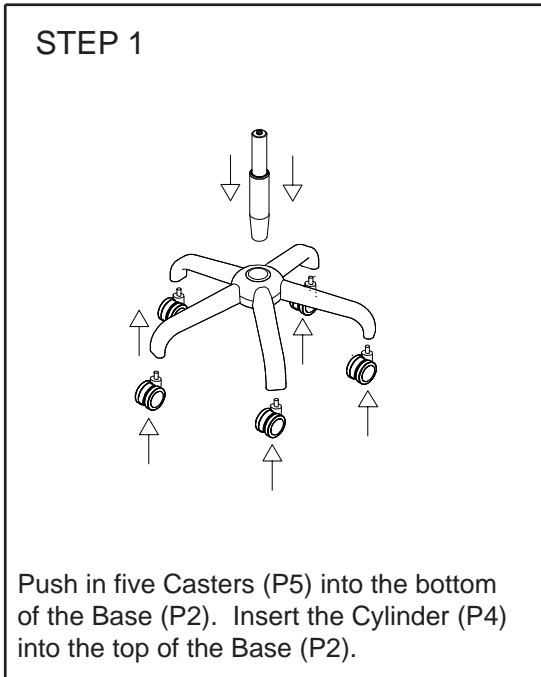

Important

The Balt product you have purchased is guaranteed against material and workmanship defects. This guarantee extends 1 year from date of purchase. Should this product fail to function satisfactorily under normal use due to defect or imperfection, the defective part or product will be replaced. Damage caused by common carriers during shipment is not included in this guarantee.

This guarantee sets forth all applicable guarantees and remedies. No other warranty, expressed or implied shall apply. Failure to follow instructions found in Important Information Section of Owner Sheet shall void the guarantee. Consequential or incidental damages and or costs are not refundable.