











Assembly Instructions

MODEL NO.:LLR81943/LLR81944

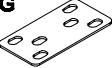
Bridge

TUN010CL	TUN011EC	C	TUN021AG	E	F	G	TUN0191B	I	J	K
 Cam Lock 6Pcs	 Klix Cam 6Pcs	 Aluminium Supports 3Pcs	 Adjustable Glide 2Pcs	 Screw M6*50 3Pcs	 60mm Black Grommet 1Pc	 I-Bracket 4Pcs	 Screw M6*20 24Pcs	 Z Bracket 4Pcs	 Screw #4*14 16Pcs	 Cam Cover 6Pcs

STEP1

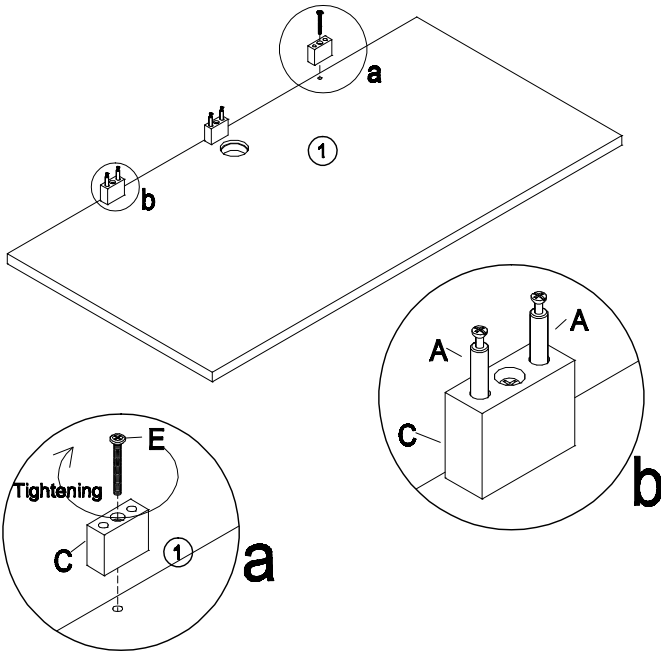

STEP2

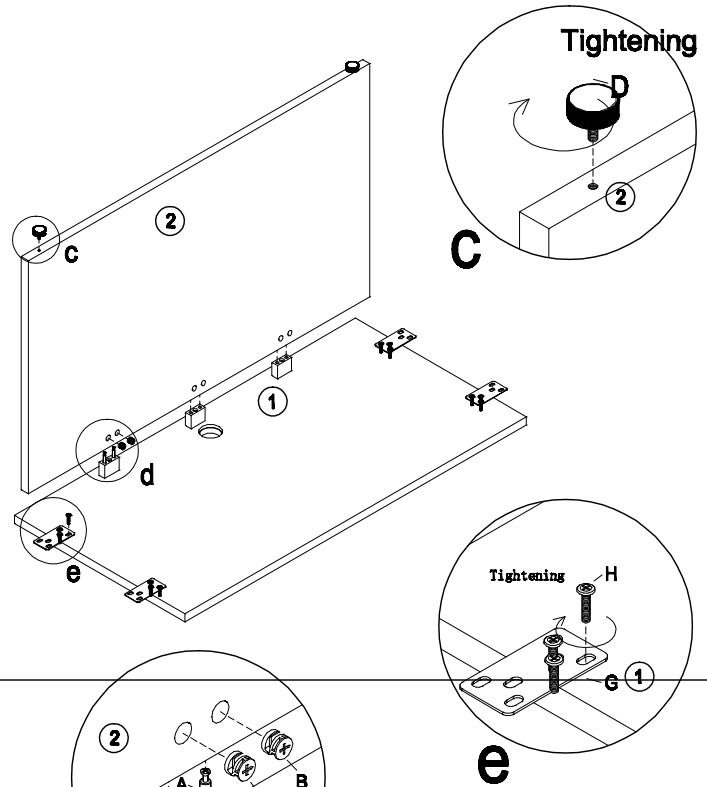

STEP3

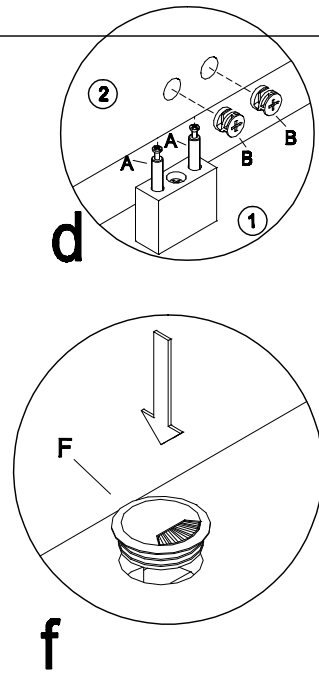
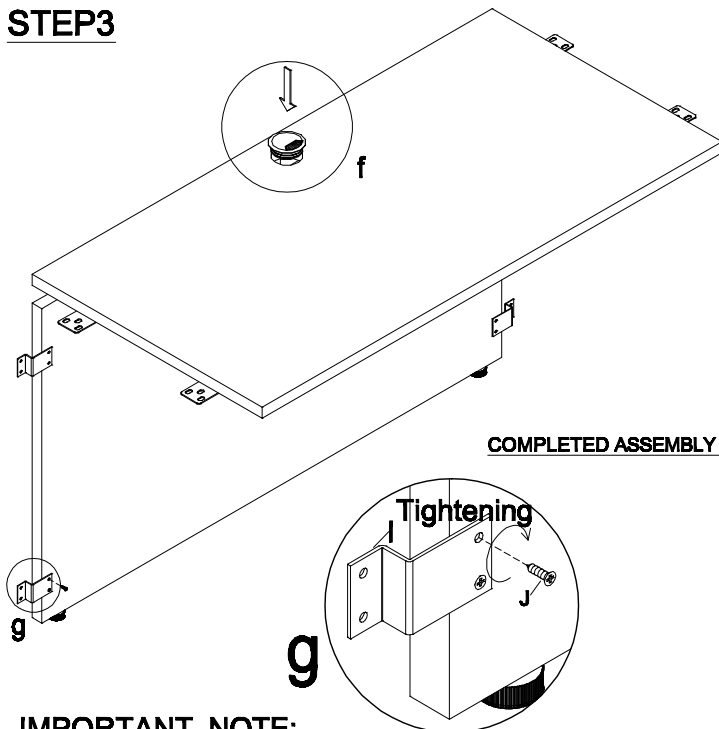

IMPORTANT:

FUNCTION OF KLIX CAM



1/4 RIGHT
TURN FOR
LOCKING

MAKE SURE THE ARROW IS
POINTING UPWARDS
BEFORE INSERTING INTO
THE PANEL'S HOLE.



IMPORTANT NOTE:

- Place all laminated parts on a clean and smooth surface such as a rug or carpet to avoid the parts from being scratched.
- Check to be sure that you have all parts and hardware.
- Remove all wrapping materials, including staples & packing straps before you start to assemble.
- Don't tighten all screws/bolts until all completely assembled.
- Keep all hardware parts out of reach of children.
- It is recommended to require 2 persons to complete the assembly.