



Hewlett Packard
Enterprise

HPE FlexNetwork MSR Router Series

Interface Module Guide

Part number: 5200-2346
Document version: 6W108-20161111

© Copyright 2016 Hewlett Packard Enterprise Development LP

The information contained herein is subject to change without notice. The only warranties for Hewlett Packard Enterprise products and services are set forth in the express warranty statements accompanying such products and services. Nothing herein should be construed as constituting an additional warranty. Hewlett Packard Enterprise shall not be liable for technical or editorial errors or omissions contained herein.

Confidential computer software. Valid license from Hewlett Packard Enterprise required for possession, use, or copying. Consistent with FAR 12.211 and 12.212, Commercial Computer Software, Computer Software Documentation, and Technical Data for Commercial Items are licensed to the U.S. Government under vendor's standard commercial license.

Links to third-party websites take you outside the Hewlett Packard Enterprise website. Hewlett Packard Enterprise has no control over and is not responsible for information outside the Hewlett Packard Enterprise website.

Acknowledgments

Intel®, Itanium®, Pentium®, Intel Inside®, and the Intel Inside logo are trademarks of Intel Corporation in the United States and other countries.

Microsoft® and Windows® are trademarks of the Microsoft group of companies.

Adobe® and Acrobat® are trademarks of Adobe Systems Incorporated.

Java and Oracle are registered trademarks of Oracle and/or its affiliates.

UNIX® is a registered trademark of The Open Group.

Contents

SIC/DSIC	1
Ethernet switching module	1
SIC-4FSW/SIC-4FSW-PoE/DSIC-9FSW/DSIC-9FSW-PoE	1
SIC-4GSW/SIC-4GSW-POE	2
SIC-4GSWF	3
Ethernet interface module	4
SIC-1FEA	5
SIC-1FEF	5
SIC-1GEC-V2/SIC-1GEC-H3	6
E1/T1 interface module	7
SIC-1E1-F	8
SIC-2E1-F	9
SIC-EPRI/SIC-1EPRI	10
SIC-1T1-F	11
Serial interface module	12
SIC-8AS	12
SIC-16AS	13
SIC-1SAE/SIC-2SAE/SIC-4SAE	14
XDSL interface module	16
DSIC-1SHDSL-8W	16
SIC-1ADSL	17
SIC-1ADSL-I	18
ISDN BRI interface module	19
SIC-1BS	20
Voice interface module	21
SIC-1FXS/SIC-1FXO/SIC-2FXS/SIC-2FXO	21
SIC-2FXS1FXO	22
DSIC-4FXS1FXO	23
SIC-1BSV/SIC-2BSV	24
SIC-1VE1	26
SIC-1VT1	27
SIC-1VE1T1	28
WLAN interface module	29
SIC-WLAN-b/g/n/SIC-WLAN-b/g/n(NA)	30
3G interface module	30
SIC-3G-GSM	31
SIC-3G-HSPA	32
SIC-3G-HSPA+	33
4G interface module	35
SIC-4G-LTE-V (JG742A)	35
SIC-4G-LTE-V (JG742B)	37
SIC-4G-LTE-A (JG743A)	38
SIC-4G-LTE-A (JG743B)	40
SIC-4G-LTE-G (JG744A)	42
SIC-4G-LTE-G (JG744B)	44
MIM/DMIM/XMIM	47
Ethernet switching module	47
XMIM-16FSW/XMIM-24FSW	47
MIM-16FSW/MIM-16FSW-PoE/DMIM-24FSW/DMIM-24FSW-PoE	48
Ethernet interface module	50
MIM-2FE/MIM-4FE	50
MIM-2GBE	51
ATM interface module	52
MIM-1ATM-OC3	52
MIM-IMA-8E1	53
MIM-IMA-4T1	54

POS (SDH/SONET) interface module.....	55
MIM-1POS.....	55
E1/T1 interface module	56
MIM-2E1/MIM-4E1/MIM-4E1-F modules.....	56
MIM-8E1/MIM-8E1-F.....	58
MIM-2T1/MIM-4T1-F.....	59
MIM-8T1/MIM-8T1-F.....	61
E3/T3 interface module	62
MIM-1CE3	62
MIM-1CT3	63
xDSL interface module.....	64
MIM-1SHL-4W.....	64
Serial interface module.....	65
MIM-2SAE/MIM-4SAE/MIM-8SAE.....	66
MIM-8ASE/MIM-16ASE	67
Voice interface module.....	68
MIM-16FXS.....	69
MIM-4BSV	70
MIM-2FXO and MIM-4FXS/MIM-4FXO.....	71
MIM-4E&M.....	72
MIM-1VE1	73
MIM-1VT1.....	74
MIM-2VE1	75
MIM-2VT1.....	76
HMIM	78
Ethernet interface switching module.....	78
HMIM-8GSW/HMIM-24GSW/HMIM-24GSW-PoE.....	78
HMIM-8GSWF	79
Ethernet interface module.....	80
HMIM-2GEE/HMIM-4GEE/HMIM-8GEE.....	80
HMIM-2GEF/HMIM-4GEF/HMIM-8GEF.....	81
POS (SDH/SONET) interface module.....	82
HMIM-1POS.....	82
CPOS (SDH/SONET) interface module	83
HMIM-1CPOS	83
E1/T1 interface module	84
HMIM-2E1/HMIM-4E1/HMIM-4E1-F	85
HMIM-8E1	86
HMIM-2T1/HMIM-4T1-F.....	87
HMIM-8E1T1/HMIM-8E1T1-F	88
E3/T3 interface module	91
HMIM-1CE3	91
HMIM-1CT3	92
HMIM-1E3T3.....	93
Serial interface module.....	94
HMIM-4SAE/HMIM-8SAE	94
HMIM-16ASE	96
Voice interface module.....	97
HMIM-16FXS	97
HMIM-2VE1	98
HMIM-2VT1	99
HMIM-1VE1	100
HMIM-1VT1	101
HMIM-4FXS/HMIM-4FXO	102
HMIM-4E&M	103
FIC/DFIC	104
Ethernet switching module.....	104
FIC-16FSW/FIC-16FSW-PoE/DFIC-24FSW/DFIC-24FSW-PoE	104
Ethernet interface module.....	106

FIC-2FE/FIC-4FE	106
FIC-1GBE/FIC-2GBE	107
FIC-1GEF/FIC-2GEF	108
ATM interface module	109
FIC-IMA-4E1/FIC-IMA-8E1	110
FIC-IMA-8T1	111
FIC-1AE3	112
FIC-1AT3.....	113
FIC-1ATM-OC3.....	114
POS (SDH/SONET) interface module.....	115
FIC-1POS.....	115
CPOS (SDH/SONET) interface module	116
FIC-1CPOS.....	116
E1/T1 interface module	117
FIC-2E1/FIC-4E1 and FIC-4E1-F	117
FIC-8E1	119
FIC-4T1-F.....	120
E3/T3 interface module	121
FIC-1CE3	121
FIC-1CT3	122
ISDN BRI interface module	124
FIC-4BSE	124
Serial interface module.....	126
FIC-4SAE/FIC-8SAE.....	126
FIC-8ASE/FIC-16ASE	128
Voice interface module.....	129
FIC-4FXS/FIC-4FXO.....	130
FIC-4E&M.....	131
FIC-24FXS.....	132
FIC-2VE1	132
FIC-2VT1.....	133
FIC-1VE1	135
FIC-1VT1.....	136
ESM/VCPM/VPM	138
ESMs	138
ESM-ANDE.....	138
ESM-SNDE.....	139
VCPM/VPM	139
VCPM/VPM purchase guide	139
VCPM.....	140
VPM	141
Cables and connection methods.....	142
Ethernet interface.....	142
Fiber port	144
E1 interface	149
T1 interface	156
E3/T3 interface.....	158
Synchronous/asynchronous serial ports.....	159
Asynchronous serial ports.....	160
ADSL/BS/FXS/FXO/AM/FCM interface	165
E&M interface	166
24FXS interface.....	167
BSV/BSE interface	168
G.SHDSL interface.....	171
WLAN interface	173
3G interface.....	173
4G interface.....	175

Appendix A Interface module list 177

Appendix B Purchase guide 182

 SIC/DSIC purchase guide 182

 MIM/XMIM/DMIM purchase guide..... 187

 HMIM purchase guide 189

 FIC/DFIC purchase guide 190

 ESM/VPM/VCPM purchase guide..... 192

Index 193

SIC/DSIC

MSR series routers use modular design and support a wide range of SICs and DSICs. A SIC occupies one SIC slot and a DSIC occupies two SIC slots. The SIC/DSIC series interface modules provide interfaces such as synchronous/asynchronous serial interface, Ethernet interface, E1/T1, ISDN BRI/PRI, ADSL, audio interface, and Layer 2 switching interface.

Among this series interface modules, the Layer 2 switching interface modules (SIC-4FSW and DSIC-9FSW) each have a corresponding PoE-capable module. The module can provide -48 VDC power to remote powered devices (PDs, such as IP phone, WLAN AP, network camera) through straight-through cables if it is installed in a PoE router.

Ethernet switching module

- SIC-4FSW
- SIC-4FSW-PoE
- DSIC-9FSW
- DSIC-9FSW-PoE
- SIC-4GSW
- SIC-4GSW-PoE
- SIC-4GSWF

SIC-4FSW/SIC-4FSW-PoE/DSIC-9FSW/DSIC-9FSW-PoE

Introduction

The 4/9-port 10/100 Mbps Ethernet Layer 2 interface modules SIC-4FSW/SIC-4FSW-PoE and DSIC-9FSW/DSIC-9FSW-PoE can provide up to 4/9 10/100 Base-Tx Ethernet ports for Layer 2 and Layer 3 switching. A router installed with SIC-4FSW/DSIC-9FSW modules can work as a switching/routing integrated device on a small-sized enterprise network to connect PCs and network devices inside the network. The SIC-4FSW-PoE/DSIC-9FSW-PoE interface modules can supply power to powered devices (PDs) through power over Ethernet (PoE).

Interface specifications

Table 1 Interface specifications

Item	Specification	
	SIC-4FSW/SIC-4FSW-PoE	DSIC-9FSW/DSIC-9FSW-PoE
Connector	RJ-45	
Interface type	MDI/MDIX	
Number of connectors	Four 100 Mbps RJ-45 connectors	Nine 100 Mbps RJ-45 connectors
Transmission distance	100 m (328.08 ft) over category-5 twisted pair cables (both crossover and straight-through)	
Operating mode	10/100 Mbps autosensing, full/half duplex	

Interface LEDs

Figure 1 SIC-4FSW panel

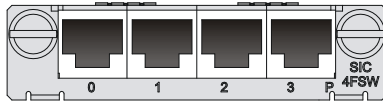

Figure 2 SIC-4FSW-PoE panel

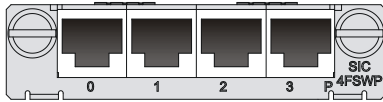

Figure 3 DSIC-9FSW panel

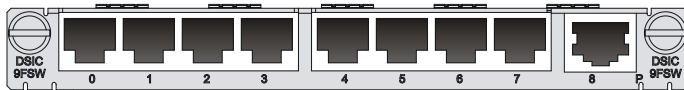

Figure 4 DSIC-9FSW-PoE panel

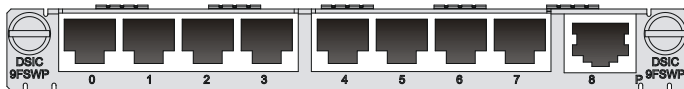

Table 2 LED description

LED	Description
Steady green	A link is present.
Off	No link is present.
Flashing green	Data is being transmitted and received (ACT).

In addition, the SIC-4FSW-POE and DSIC-9FSW-POE each provide a PoE LED.

Table 3 LED description

LED	Description
Steady green	The module is supplying power to PDs.
Flashing green at 8 Hz	An alarm has occurred on the ports that connects to the PDs.
Off	The module is not supplying power to any PDs.

Interface cables and connection methods

For more information about the Ethernet interface cables and connection methods, see "[Ethernet interface.](#)"

SIC-4GSW/SIC-4GSW-POE

Introduction

The 4-port 1000 Mbps Ethernet Layer 2 SIC interface module SIC-4GSW/SIC-4GSW-POE provides four 1000 Mbps RJ-45 connectors. It is designed for switching/routing integrated routers on a

small-sized enterprise network. You can use it to connect PCs and network devices inside the network. The SIC-4GW-PoE interface module can supply power to PDs through PoE.

Interface specifications

Table 4 Interface specifications

Item	Specification
Connector	RJ-45
Interface type	MDI/MDIX
Number of connectors	4
Transmission distance	100 m (328.08 ft) over category-5 twisted pair cables (both crossover and straight-through)
Operating mode	10/100/1000 Mbps autosensing, full/half duplex

Interface LEDs

Figure 5 SIC-4GSW

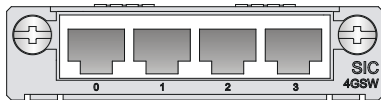

Figure 6 SIC-4GSW-PoE

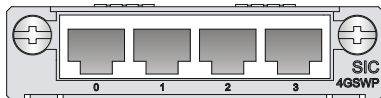

Table 5 LED description

LED	Description
Off	No link is present.
Steady green	A 1000 Mbps link is present.
Flashing green	The interface is sending or receiving data at 1000 Mbps.
Steady yellow	A 10/100 Mbps link is present.
Flashing yellow	The interface is sending or receiving data at 10/100 Mbps.

Interface cables and connection methods

For more information about the Ethernet interface cables and connection methods, see "[Ethernet interface](#)."

SIC-4GSWF

Introduction

The 4-port 100/1000 Mbps Ethernet Layer 2/Layer 3 SIC interface module SIC-4GSWF provides four fiber ports. It is designed for switching/routing integrated routers on a small-sized enterprise network. You can use it to connect network devices inside the network.

The interface module has the following features:

- Support for multiple types of 100/1000 Mbps transceiver modules.
- 1000/100 Mbps interface rate.
- Full duplex operating mode.

Interface specifications

Table 6 Interface specifications

Item	Description
Number of interfaces	4
Connector	SFP/LC
Standard	802.3/802.3u/802.3ab
Operating mode	1000/100 Mbps, full duplex

Interface LEDs

Figure 7 SIC-4GSWF panel



The SIC-4GSWF interface module provides a double-color (green/yellow) LED for each port to indicate the operating status of the port.

Table 7 LED description

LED	Description
Off	No link is present.
Steady green	A link is present on the port and the port is operating at 1000 Mbps.
Flashing green	The port is sending and receiving data at 1000 Mbps.
Steady yellow	A link is present on the port and the port is operating at 100 Mbps.
Flashing yellow	The port is sending and receiving data at 100 Mbps.

Transceiver modules, optical fibers, and connection methods

For more information about transceiver modules, optical fibers, and connection methods, see "[Fiber port.](#)"

Ethernet interface module

- SIC-1FEA
- SIC-1FEF
- SIC-1GEC-V2
- SIC-1GEC-H3

SIC-1FEA

Introduction

The 1-port 10Base-T/100Base-TX Ethernet interface module (SIC-1FEA) implements communication between Routers and LANs.

Interface specifications

Table 8 Interface specifications

Item	Specification
Connector	RJ-45
Interface type	MDI
Number of connectors	1
Transmission distance	100 m (328.08 ft) over category-5 twisted pair cables (both crossover and straight-through)
Operating mode	10/100 Mbps autosensing, full duplex/half duplex

Interface LEDs

Figure 8 SIC-1FEA panel

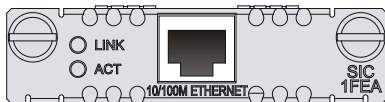

Table 9 LED description

LED	Description
LINK	<ul style="list-style-type: none">Off means no link is present;On means a link is present.
ACT	<ul style="list-style-type: none">Off means no data is being transmitted or received;Flashing means data is being received or/and transmitted.

Interface cables and connection methods

For more information about the Ethernet interface cables and connection methods, see "[Ethernet interface.](#)"

SIC-1FEF

Introduction

The 1-port 100 Mbps fiber Ethernet interface module (SIC-1FEF) implements communication between the router and LAN.

Interface specifications

Table 10 Interface specifications

Item	Specification
Number of connectors	1

Item	Specification
Connector	SFP/LC
Interface standard	802.3, 802.3u, and 802.3ab
Operating mode	100 Mbps, full duplex

Interface LEDs

Figure 9 SIC-1FEF panel



Table 11 LED description

LED	Status	Description
LINK/ACT	Off	No link is present.
	Steady green	A link is present.
	Flashing green	Data is being received and transmitted at 100 Mbps.
	Steady yellow	Information detection failed.

Fiber ports, optical fibers, and the connection methods

For more information about fiber ports, optical fibers, and the connection methods, see "[Fiber port.](#)"

SIC-1GEC-V2/SIC-1GEC-H3

Introduction

The 1-port 10/100/1000 Mbps copper and fiber Ethernet interface module SIC-1GEC-V2/SIC-1GEC-H3 provides the following features:

- Receipt, transmission and processing of GE data stream.
- CE copper and fiber interface access.
- 1000/100/10 Mbps on the copper interface.
- 1000 Mbps on the fiber interface.

Interface specifications

Table 12 Interface specifications

Item	Specification
Connector	RJ-45
Interface type	MDI
Frame format	<ul style="list-style-type: none"> • Ethernet_II • Ethernet_SNAP • IEEE 802.2 • IEEE 802.3
Operating mode	10/100/1000 Mbps autosensing, full/half duplex

NOTE:

The SIC-1GEC-V2/SIC-1GEC-H3 provides an interface that combines a fiber port and a copper port. Only one port of the combo interface can be activated at a time. The copper port is activated by default. To use the fiber port, execute the related command at the command line interface (CLI).

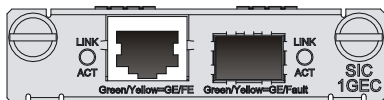
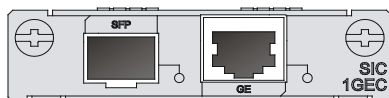
Interface LEDs**Figure 10 SIC-1GEC-H3 panel****Figure 11 SIC-1GEC-V2 panel****Table 13 LED description for the SIC-1GEC-V2/SIC-1GEC-H3**

LED	Description
LINK	<ul style="list-style-type: none">On means carrier signal is received.Off means no carrier signal is received.Green: Data is being received and transmitted at a speed of 1000 Mbps.Yellow: Data is being received and transmitted at a speed of 100/10 Mbps.
ACT	<ul style="list-style-type: none">Off: No data is being received and transmitted.Flashing: Data is being received and transmitted.

Table 14 LED description for the SIC-1GEC-V2/SIC-1GEC-H3

LED	Description
LINK	<ul style="list-style-type: none">On means carrier signal is received.Off means no carrier signal is received.Green: Data is being received and transmitted at a speed of 1000 Mbps.Yellow: The module is faulty.
ACT	<ul style="list-style-type: none">Off: No data is being received and transmitted.Flashing: Data is being received and transmitted.

Interface cables and connection methods

For more information about the Ethernet interface cables and connection methods, see "[Ethernet interface](#)."

For more information about fiber ports, optical fibers, and the connection methods, see "[Fiber port](#)."

E1/T1 interface module

- SIC-1E1-F
- SIC-2E1-F
- SIC-EPRI

- SIC-1EPRI
- SIC-1T1-F

SIC-1E1-F

Introduction

The 1-port fractional E1 interface module (SIC-1E1-F) provides the following features:

- Transmission, receiving, and handling of E1 data streams
- CE1 (channelized E1) access
- Remote loopback and local loopback functions, facilitating fault test and location

The FE1 operating mode supported by the SIC-1E1-F module allows only one bundle. The time slots can only be bundled into one $n \times 64$ kbps channel, where n is in the range of 1 to 31.

The SIC-1E1-F does not support the PRI mode.

Interface specifications

Table 15 Interface specifications

Item	Specification
Connector type	D15
Number of connectors	1
Interface standard	G.703, G.704
Interface rate	2.048 Mbps
Cable type	75-ohm unbalanced coaxial cable (D15 to BNC)
Operating modes	E1 CE1
Supported services	Backup Terminal access

Interface LEDs

Figure 12 SIC-1E1-F panel



Table 16 LED description

LED	Description
LINK/ACT	<ul style="list-style-type: none"> • On means carrier signal has been received. • Flashing means data is being transmitted or received. • Off means no carrier signal has been received.
LP/AL	<ul style="list-style-type: none"> • On means the interface is in a loopback. • Flashing means an AIS, LFA, or RAI alarm signal is present. • Off means neither loopback nor alarm is present.
<p>Note: AIS = Alarm indication signal; LFA = loss of frame alignment; RAI = Remote alarm indication</p>	

Interface cables and connection methods

For more information about E1 interface cables, see "[E1 interface](#)."

SIC-2E1-F

Introduction

The 2-port fractional E1 interface module (fractional) provides the following features:

- Transmission/Receiving and handling of E1 data streams
- CE1 (channelized E1) access
- Remote loopback and local loopback functions, facilitating fault test and location.

The FE1 operating mode supported by the SIC-2E1-F module allows only one bundle. The time slots can only be bundled into one $n \times 64$ kbps channel, where n is in the range of 1 to 31.

The SIC-2E1-F does not support the PRI mode.

Interface specifications

Table 17 Interface specifications

Item	Specification
Connector type	D15
Number of connectors	1
Interface standard	G.703, G.704
Interface rate	2.048 Mbps
Cable type	75-ohm unbalanced coaxial cable (D15 to BNC)
Operating modes	E1 CE1
Supported services	Backup Terminal access

Interface LEDs

Figure 13 SIC-2E1-F panel

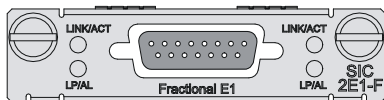

Table 18 LED description

LED	Description
LINK/ACT	<ul style="list-style-type: none">• On means carrier signal has been received.• Flashing means data is being transmitted or received.• Off means no carrier signal has been received.
LP/AL	<ul style="list-style-type: none">• On means the interface is in a loopback.• Flashing means an AIS, LFA, or RAI alarm signal is present.• Off means neither loopback nor alarm is present.

LED	Description
Note: AIS = Alarm indication signal; LFA = loss of frame alignment; RAI = Remote alarm indication	

Interface cables and connection methods

For more information about E1 interface cables, see "[E1 interface](#)."

SIC-EPRI/SIC-1EPRI

Introduction

The 1-port E1/CE1/PRI SIC interface module (SIC-EPRI/SIC-1EPRI) provides the following features:

- Transmission/Receiving and handling of E1 data streams.
- CE1 (channelized E1) access.
- ISDN PRI.
- Remote loopback and local loopback functions, facilitating fault test and location.

Interface specifications

Table 19 Interface specifications

Item	Specification
Connector type	D15
Number of connectors	1
Interface standard	G.703, G.704
Interface rate	2.048 Mbps
Cable type	75-ohm unbalanced coaxial cable (D15 to BNC) Coaxial connector, network interface connector, and 75-to-120-ohm adaptor (with BNC connector)
Operating modes	E1 CE1 ISDN PRI
Supported services	Backup Terminal access ISDN

Interface LEDs

Figure 14 SIC-EPRI/SIC-1EPRI panel

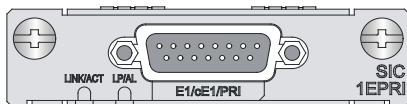

Table 20 LED description

LED	Description
LINK/ACT	<ul style="list-style-type: none"> On means carrier signal has been received. Flashing means data is being transmitted or received. Off means no carrier signal has been received.
LP/AL	<ul style="list-style-type: none"> On means the interface is in a loopback. Flashing means an AIS, LFA, or RAI alarm signal is present. Off means neither loopback nor alarm is present.
Note: AIS = Alarm indication signal; LFA = loss of frame alignment; RAI = Remote alarm indication	

Interface cables and connection methods

A 70-to-120-ohm adaptor is required to connect a 120-ohm cable to the 75-ohm SIC-1EPRI. For more information about E1 interface cables, see "[E1 interface](#)."

SIC-1T1-F

Introduction

1-port Fractional T1 interface module provides the following features:

- Transmission/Receiving and handling of T1 data streams.
- Remote loopback and local loopback, facilitating the effective and flexible debugging.

The FT1 operating mode supported by the SIC-1T1-F module allows only one bundle. The time slots can only be bundled into one $n \times 56$ kbps channel, where n is in the range of 1 to 24.

The SIC-1T1-F does not support the PRI mode.

Interface specifications

Table 21 Interface specifications

Item	Specification
Connector type	RJ-45
Number of connectors	1
Interface standard	<ul style="list-style-type: none"> • G.703/T1.102 • G.704 • AT&T TR 54016 • AT&T TR 62411 • ANSI T1.403
Interface rate	1.544 Mbps
Cable type	T1 cable (100-ohm standard shielded network cable)
Operating mode	FT1
Supported service	<ul style="list-style-type: none"> • Backup • Terminal access

Interface LEDs

Figure 15 SIC-1T1-F panel



Table 22 LED description

LED	Description
LINK/ACT	<ul style="list-style-type: none">On means the carrier signal has been received.Off means no carrier signal has been received.Flashing means data is being transmitted or/and received.
LP/AL	<ul style="list-style-type: none">On means the interface is in a loopback.Flashing means an AIS, LFA, or RAI alarm signal is present.Off means no loopback or alarm is present.
Note: AIS = Alarm indication signal; LFA = loss of frame alignment; RAI = Remote alarm indication	

Interface cables and connection methods

For more information about T1 Interface cables and connection methods, see "[T1 interface](#)."

Serial interface module

- SIC-8AS
- SIC-16AS
- SIC-1SAE
- SIC-2SAE
- SIC-4SAE

SIC-8AS

Introduction

The 8-port asynchronous serial interface module (SIC-8AS) transmits and processes asynchronous data streams.

The SIC-8AS provides the following features:

- Each asynchronous serial port provides a rate up to 115.2 Kbps.
- Supports the terminal access service and asynchronous dedicated line.
- Acts as the small-/medium-sized ISP dial-up access server when an asynchronous serial port is used for dial-up.

Interface specifications

Table 23 Interface specifications

Item	Specification
Connector	DB60
Number of connectors	1

Item	Specification
Interface cable	Customized cable with 8-port RJ-45 connector
Interface standard	RS232
Minimum baud rate	300 bps
Maximum baud rate	115.2 Kbps
Supported services	<ul style="list-style-type: none"> • Modem dial-up • Backup • Terminal access service • Asynchronous dedicated line

Interface LEDs

Figure 16 SIC-8AS front panel

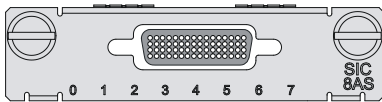

Table 24 LED description

LED	Description
LINK/ACT	<ul style="list-style-type: none"> • Off means no link is present; • On means a link is present. • Flashing means data is being received or/and transmitted.

Interface cables and connection methods

For more information about asynchronous serial port cables, see "[Asynchronous serial ports.](#)"

SIC-16AS

Introduction

The 16-port asynchronous serial interface module (SIC-16AS) transmits and processes asynchronous data streams.

SIC-16AS provides the following features:

- Each asynchronous serial port provides a rate of up to 115.2 Kbps.
- Supports the terminal access service and asynchronous dedicated line.
- Acts as the small-/medium-sized ISP dial-up access server when an asynchronous serial port is used for dial-up.

Interface specifications

Table 25 Interface specifications

Item	Specification
Connector	D28 (male)
Number of connectors	1
Interface cable	Customized cable with 16-port RJ-45 connector (female)

Item	Specification
Interface standard	RS232
Minimum baud rate	300 bps
Maximum baud rate	115.2 Kbps
Supported services	<ul style="list-style-type: none"> • Modem dial-up • Backup • Terminal access service • Asynchronous dedicated line

Interface LEDs

Figure 17 SIC-16AS panel

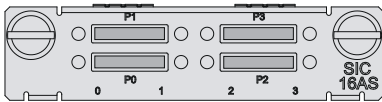

Table 26 LED description

LED	Description
LINK/ACT	<ul style="list-style-type: none"> • Off means no link is present; • On means a link is present. • Flashing means data is being received or/and transmitted.

Interface cables and connection methods

For more information about asynchronous serial port cables, see "[Asynchronous serial ports.](#)"

SIC-1SAE/SIC-2SAE/SIC-4SAE

Introduction

The 1-port/2-port/4-port enhanced high-speed synchronous/asynchronous serial interface module (SIC-1SAE/SIC-2SAE/SIC-4SAE) provides features similar to SA, but its serial interfaces support additional protocols, such as RS449, X.21, and RS530.

Interface specifications

Table 27 Interface specifications

Item	Specification		
	Synchronous		Asynchronous
Connector	D28		
Number of connectors	<ul style="list-style-type: none"> • 1 (SIC-1SAE) • 2 (SIC-2SAE) • 4 (SIC-4SAE) 		
Interface standard and operating mode	V.24	V.35, RS449, X.21, RS530	RS232
	DTE, DCE	DTE, DCE	
Minimum baud rate (bps)	1200	1200	300

Item	Specification		
	Synchronous		Asynchronous
Maximum baud rate (bps)	64 k	2.048 M	115.2
Cable	V.24 (RS232) DTE cable V.24 (RS232) DCE cable V.35 DTE cable V.35 DCE cable X.21 DTE cable X.21 DCE cable RS449 DTE cable RS449 DCE cable RS530 DTE cable RS530 DCE cable		
Supported service	<ul style="list-style-type: none"> DDN leased line Terminal access service 	<ul style="list-style-type: none"> Dialup through modems Backup Asynchronous leased line Terminal access 	

Interface LEDs

Figure 18 SIC-1SAE panel



Figure 19 SIC-1SAE panel

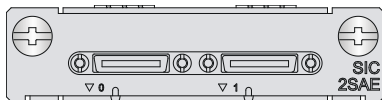

Figure 20 SIC-1SAE panel

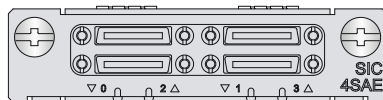

Table 28 LED description

LED	Description
LINK	<ul style="list-style-type: none"> Off means no link is present. On means a link is present.
ACT	<ul style="list-style-type: none"> Off means no data is being transmitted or received. Flashing means data is being received or/and transmitted.

Interface cables and connection methods

For more information about synchronous/asynchronous serial port cables and connection methods, see "[Synchronous/asynchronous serial ports.](#)"

XDSL interface module

- DSIC-1SHDSL-8W
- SIC-1ADSL
- SIC-1ADSL-I

DSIC-1SHDSL-8W

Introduction

The 1-port 8-wire (4-pair) high-speed digital subscriber line interface module (DSIC-1SHDSL-8W) supports symmetric link rate of up to 22.76 Mbps.

The G. SHDSL provides symmetric uplink and downlink and transmission rates of 192 kbps to 2312 kbps. Developed from G. SHDSL, the G.SHDSL.BIS provides a higher-speed negotiation rate and supports scalability of multi-pair wires in addition to the functions of the G. SHDSL.

The DSIC-1SHDSL-8W provides the following features:

- Communications in the ATM/EFM mode.
- Manual and automatic switchover between the ATM and EFM mode.
- Supports using four, three, two, and one pair(s) of wires.

Interface specifications

Table 29 Interface specifications

Item	Specification
Connector	RJ-45
Number of connectors	1
Interface standard	ITU-T G991.2 ANNEX A, ANNEX B, ANNEX F, ANNEX G ITU-T G994.1 handshaking
Interface rate	<ul style="list-style-type: none"> • 5.69 Mbps (1 pair mode) • 11.38 Mbps (2 pair mode) • 17.07 Mbps (3 pair mode) • 22.76 Mbps (4 pair mode)
Cable	Telephone cable with ferrite core (one RJ-45 connector converts to two RJ-11 connectors.)
Operating mode	<ul style="list-style-type: none"> • ATM • EFM
Supported services	G.SHDSL over the regular telephone line

Interface LEDs

Figure 21 DSIC-1SHDSL-8W panel

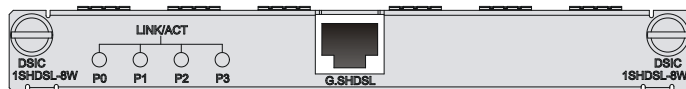

Table 30 LED description

LED	Description
LINK/ACT (P0-P3)	<ul style="list-style-type: none"> • On means a carrier signal is received. • Off means no carrier signals is received. • Fast flashing means data is being received or/and transmitted. • Slow flashing means the module is negotiating rates.

Interface cables and connection methods

For more information about G.SHDSL interface cables and connection methods, see "[G.SHDSL interface](#)."

SIC-1ADSL

Introduction

The 1-port ADSL over PSTN interface module (SIC-1ADSL) provides an RJ-11 interface that can work as a WAN interface. It allows a LAN subscriber to connect to the digital subscriber's loop access multiplexer (DSLAM) at the central office over a regular analog subscriber line or telephone line. Therefore, the subscriber can access the ATM/IP backbone or the Internet to use services such as high-speed data communication and video on demand (VoD).

ADSL transmits data in the high frequency band above 26 kHz. Therefore, it can provide services without interfering with the voice service being provided in the low frequency band (0 to 4 kHz) on the same line. It provides downlink rates in the range 32 kbps to 8 Mbps and uplink rates in the range 32 kbps to 1 Mbps.

The SIC-1ADSL provides the following features:

- Manual ADSL line activation and deactivation, which provides a convenient method for fault location.
- Interface standards of G. DMT, G. Lite, and T1.413, auto-sensing.
- Trellis coding (except for G. Lite) on ADSL interfaces, enhancing the stability of ADSL connection.

Interface specifications

Table 31 Interface specifications

Item	Specification
Connector	RJ-11
Number of connectors	1
Interface rate	<ul style="list-style-type: none"> • In ADSL full rate mode (ITU-T 992.1 G.DMT/ANSI T1.413): <ul style="list-style-type: none"> ○ 8 Mbps (downlink rate) ○ 1024 kbps (uplink rate) • In ADSL Lite mode (ITU-T 992.2 G.Lite): <ul style="list-style-type: none"> ○ 64 kbps to 1 Mbps (downlink rate) ○ 64 kbps to 512 kbps (uplink rate) • In ADSL2+ full rate mode (ITU-T 992.5): <ul style="list-style-type: none"> ○ 24 Mbps (downlink rate) ○ 1024 kbps (uplink rate)

Item	Specification
Interface standard	<ul style="list-style-type: none"> • ITU-T 992.1 G.DMT • ITU-T 992.2 G.Lite • ANSI T1.413 Issue 2 • ITU-T 992.3 • ITU-T 992.5
Cable	Telephone cable
Supported service	ADSL over the regular telephone line

Interface LEDs

Figure 22 SIC-1ADSL panel



Table 32 LED description

LED	Description
LINK	<ul style="list-style-type: none"> • Off means the loop is inactive. • On means the loop has been activated and has entered the data mode. • Flashing means the loop is being activated.
ACT	<ul style="list-style-type: none"> • Off means no data is being transmitted or received. • Flashing means data is being received or/and transmitted.

Interface cables and connection methods

For more information about ADSL interface cables and connection methods, see ["ADSL/BS/FXS/FXO/AM/FCM interface."](#)

SIC-1ADSL-I

Introduction

The 1-port ADSL over ISDN interface module (SIC-1ADSL-I) uses the RJ-11 connector for the WAN interface. It allows a LAN subscriber to connect to the DSLAM at the central office over a regular analog subscriber line or telephone line. Thus, the subscriber can access the ATM/IP backbone or the Internet to use services such as high-speed data communication and video on demand (VoD).

The module transmits data in the high frequency band above 138 kHz. Therefore, it can provide services on the same line without interfering with the ISDN service being provided on the same line. It provides downlink rates in the range 32 kbps to 8 Mbps and uplink rates in the range 32 kbps to 1 Mbps.

The SIC-1ADSL-I interface module provides the following features:

- Manual ADSL line activation and deactivation, which provides a convenient method for fault location.
- A G.992.1-compliant interface, auto-sensing.
- Trellis coding on ADSL interfaces, enhancing the stability of ADSL connection.

Interface specifications

Table 33 Interface specifications

Item	Specification
Connector	RJ-11
Number of connectors	1
Interface rate	<ul style="list-style-type: none"> • In ADSL full rate mode (ITU-T 992.1 G.DMT/ANSI T1.413): <ul style="list-style-type: none"> ◦ 8 Mbps (downlink rate) ◦ 1024 kbps (uplink rate) • In ADSL Lite mode (ITU-T 992.2 G.Lite): <ul style="list-style-type: none"> ◦ 64 kbps to 1 Mbps (downlink rate) ◦ 64 kbps to 512 kbps (uplink rate) • In ADSL2+ full rate mode (ITU-T 992.5): <ul style="list-style-type: none"> ◦ 24 Mbps (downlink rate) ◦ 1024 kbps (uplink rate)
Interface standard	<ul style="list-style-type: none"> • ITU-T 992.1 G.DMT • ITU-T 992.2 G.Lite • ANSI T1.413 Issue 2 • ITU-T 992.3 • ITU-T 992.5
Interface rate	<ul style="list-style-type: none"> • Downlink: 8 Mbps • Uplink: 1024 kbps
Interface cable	Regular telephone cable
Supported services	ADSL over ISDN

Interface LEDs

Figure 23 SIC-1ADSL-I panel



Table 34 LED description

LED	Description
LINK	<ul style="list-style-type: none"> • Off means no link is present; • On means a link is present.
ACT	<ul style="list-style-type: none"> • Off means no data is being transmitted or received. • Flashing means data is being received or/and transmitted.

Interface cables and connection methods

For more information about ADSL Interface cables and connection methods, see "[ADSL/BS/FXS/FXO/AM/FCM interface.](#)"

ISDN BRI interface module

- SIC-1BS

SIC-1BS

Introduction

The 1-port ISDN BRI S/T interface module (SIC-1BS) transmits and processes ISDN BRI S/T traffic flows. It can operate in dial-up or leased line mode.

Interface specifications

Table 35 Interface specifications

Item	Description
Connector	RJ-45
Number of connectors	1
Cable type	Telephone cable with ferrite core
Interface standard	<ul style="list-style-type: none">• ITU-T I.430• Q.921• Q.931
Working mode	<ul style="list-style-type: none">• ISDN Dial-up• ISDN leased line
Supported services	<ul style="list-style-type: none">• ISDN• ISDN supplementary services• Multi-subscriber number• Sub-address• Backup

Interface LEDs

Figure 24 SIC-1BS panel

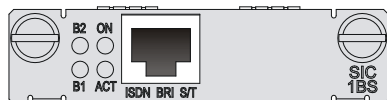

Table 36 LED description

LED	Description
B1	<ul style="list-style-type: none">• Off indicates the B1 channel is idle.• Flashing indicates the B1 channel is being used for data communication.
B2	<ul style="list-style-type: none">• Off indicates the B2 channel is idle.• Flashing indicates the B1 channel is being used for data communication.
ACT	<ul style="list-style-type: none">• Off indicates the inactive state.• Steady on indicates the active state.
On	<ul style="list-style-type: none">• Off indicates the interface module is powered off.• On indicates the interface module is powered on.

Interface cables and connection methods

For more information about BS Interface cables and connection methods, see ["ADSL/BS/FXS/FXO/AM/FCM interface."](#)

Voice interface module

- SIC-1FXS
- SIC-1FXO
- SIC-2FXS
- SIC-2FXO
- SIC-2FXS1FXO
- DSIC-4FXS1FXO
- SIC-2BSV
- SIC-1VE1
- SIC-1VT1
- SIC-1VE1T1

SIC-1FXS/SIC-1FXO/SIC-2FXS/SIC-2FXO

Introduction

The 1/2-port voice subscriber circuit interface module (SIC-1FXS/SIC-2FXS) and 1/2-port voice AT0 analog trunk interface module (SIC-1FXO/SIC-2FXO) provide access for and handle 1/2 channels of analog voice signals over data communication networks. The differences between SIC-FXS and SIC-FXO are as follows:

- The SIC-FXS modules are analog subscriber line modules that provide ordinary analog telephone and fax access and also can connect AT0 loop trunks of exchanges.
- The SIC-FXO modules are loop trunk modules that provide access for common subscriber lines.

Interface specifications

Table 37 Interface specifications

Item	Specification
Connector type	RJ-11
Number of connectors	1 (SIC-1FXS/SIC-1FXO) 2 (SIC-2FXS/SIC-2FXO)
Interface standard	<ul style="list-style-type: none">• Subscriber circuit interface (SIC-1FXS/SIC-2FXS) compliant with ITU Q.512.• Loop trunk interface (SIC-1FXO/SIC-2FXO) compliant with ITU Q.552.• Over-current and over-voltage protection compliant with ITU K.20
Cable type	Telephone cable with ferrite core.
Dialing mode	Supports DTMF, does not support pulse dial-up.
Bandwidth	300 Hz to 3400 Hz

Interface LEDs

Figure 25 SIC-1FXS panel

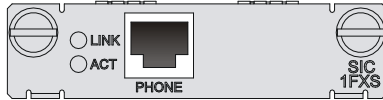

Figure 26 SIC-1FXO panel

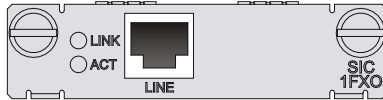

Figure 27 SIC-2FXS panel

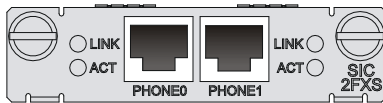

Figure 28 SIC-2FXO panel

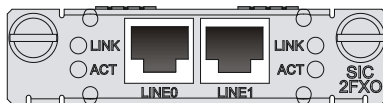

Table 38 LED description

LED	Description
LINK	<ul style="list-style-type: none">Off means the link is idle.On means the link is being occupied for call connection.
ACT	<ul style="list-style-type: none">Off means the link is idle.On means the link is being occupied for communication.

Interface cables and connection methods

For more information about FXS/FXO interface cables and connection methods, see "[ADSL/BS/FXS/FXO/AM/FCM interface](#)."

SIC-2FXS1FXO

Introduction

The 2-port analog subscriber circuit interface module and 1-port voice AT0 loop trunk interface module (SIC-2FXS1FXO) provide access for and handle three channels of analog voice signals over data communication networks. Two FXS interfaces and one FXO interface are available on a SIC-2FXS1FXO module:

- FXS interfaces are analog subscriber line interfaces that provide ordinary analog telephone and fax access and also can connect AT0 loop trunks of exchanges.
- FXO interfaces are loop trunk interfaces that provide access for common subscriber lines.

Interface specifications

Table 39 Interface specifications

Item	Specification
Connector type	RJ-11
Number of connectors	2 FXS interfaces 1 FXO interface
Interface standard	<ul style="list-style-type: none">• Supports subscriber circuit interface (FXS), compliant with ITU Q.512• Supports loop trunk interface (FXO), compliant with ITU Q.552• Over-current and over-voltage protection compliant with ITU K.20
Cable type	Telephone cable with ferrite core
Dial-up mode	Supports DTMF, compliant with GB3378, but does not support pulse dial-up.
Bandwidth	300 Hz to 3400 Hz

Interface LEDs

Figure 29 SIC-2FXS1FXO panel

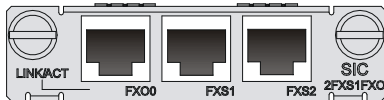

Table 40 LED description

LED	Description
LINK/ACT	<ul style="list-style-type: none">• Off means the link is idle.• On (Green) means the link is being occupied for call connection.• Flashing (Yellow) means the link is being occupied for communication.

Interface cables and connection methods

For more information about FXS/FXO interface cables and connection methods, see "[ADSL/BS/FXS/FXO/AM/FCM interface.](#)"

DSIC-4FXS1FXO

Introduction

The 4-port analog subscriber circuit interface module and 1-port voice AT0 loop trunk interface module (DSIC-4FXS1FXO) provide access for and handle five channels of analog voice signals over data communication networks.

- FXS interfaces are analog subscriber line interfaces that provide ordinary analog telephone and fax access and also can connect AT0 loop trunks of exchanges;
- FXO interfaces are loop trunk interfaces that provide access for common subscriber lines.

Interface specifications

Table 41 Interface specifications

Item	Specification
Connector type	RJ-11
Number of connectors	4 FXS interfaces 1 FXO interface
Interface standard	<ul style="list-style-type: none"> Supports subscriber circuit interface (FXS), compliant with ITU Q.512 Supports loop trunk interface (FXO), compliant with ITU Q.552 Over-current and over-voltage protection compliant with ITU K.20
Cable type	Telephone cable with ferrite core
Dial-up mode	Supports DTMF, compliant with GB3378, but does not support pulse dial-up.
Bandwidth	300 Hz to 3400 Hz

Interface LEDs

Figure 30 DSIC-4FXS1FXO panel

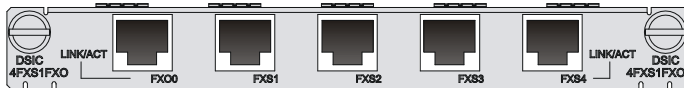

Table 42 LED description

LED	Description
LINK/ACT	<ul style="list-style-type: none"> Off means the link is idle. On (Green) means the link is being occupied for call connection. Flashing (Yellow) means the link is being occupied for communication.

Interface cables and connection methods

For more information about FXS/FXO interface cables and connection methods, see "[ADSL/BS/FXS/FXO/AM/FCM interface](#)."

SIC-1BSV/SIC-2BSV

Introduction

The 2-port ISDN BRI S/T voice interface module (SIC-2BSV) processes ISDN interface voice traffic. The interfaces on the SIC-2BSV module are ITU-T I.430-compliant. They use pseudo-ternary coding, provide 192 Kbps interface rate, and allow a maximum transmission distance of 1 km (0.6 miles) in point-to-point mode. In the upstream direction, the SIC-2BSV module can be connected to a user interface on an ISDN switch to receive and decompress, compress and transmit ISDN BRI digital voice traffic. In the downstream direction, the module can be connected to a TE device to forward voice packets from the TE device to the Internet through a WAN interface on the router to implement VoIP. The module provides the following features:

- A BSV interface supports user and network modes for connecting an ISDN network and a TE device, respectively.
- When a BSV interface operates in network mode, traffic is processed as follows:
 - The digital voice traffic received on the BSV interface is compressed and forwarded through the CPU on the main processing unit (MPU) to a WAN interface.

- The IP voice traffic received on a WAN interface is forwarded through the CPU on the MPU to SIC-2BSV, where the traffic is decompressed and sent to the TE device.
- When a BSV interface operates in user mode, traffic is processed as follows:
 - The digital voice traffic received from the B channels on the BSV interface is decompressed and forwarded through the CPU on the MPU to a local FXS or FXO analog voice interface.
 - The voice signals received on the local FXS or FXO analog voice interface are processed by VoIP and forwarded through the CPU on the MPU to the SIC-2BSV. The SIC-2BSV decompresses the traffic and sends the traffic out of the BSV interface to the ISDN switch.
- Working in conjunction with the FXS or FXO analog voice interface modules, SIC-2BSV provides flexibility in voice call routing.
- The ISDN BRI D channel signaling is processed separately on the CPU.
- A BSV interface can be connected to an ISDN phone to supply power to the phone.
- The SIC-2BSV is dedicated to voice applications.

Interface specifications

Table 43 Interface specifications

Item	Specification
Connector	RJ-45
Number of connectors	2
Interface standard	ITU-T I.430, Q.921, Q.931
Interface rate	192 Kbps
Cable	ISDN S interface cable
Supported service	Voice access over ISDN S interface cable

Interface LEDs

Figure 31 SIC-2BSV panel

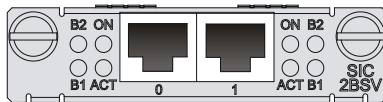

Table 44 LED description

LED	Description
B1	Flashing indicates data is being transmitted or received on the B1 channel.
B2	Flashing green indicates data is being transmitted or received on the B2 channel.
ACT	<ul style="list-style-type: none"> • Flashing yellow indicates the link is being activated. • Steady green indicates the link is active.
On	Steady green indicates the module is powered on.

Interface cables and connection methods

For more information about BSV interface cables and connection methods, see "[BSV/BSE interface](#)."

SIC-1VE1

Introduction

The 1-port E1 voice interface module (SIC-1VE1) handles dense voice signals in a VoIP system. It provides a CE1/PRI/R2 port that can process a maximum of 30 channels of voice signals.

Interface specifications

Table 45 Interface specifications

Item	Specification
Connector	DB 15
Number of connector	1
Interface standard	G.703, G.704
Interface rate	2.048 Mbps
Frame format	<ul style="list-style-type: none"> Ethernet_II Ethernet_SNAP IEEE 802.2 IEEE 802.3
Cable type	<ul style="list-style-type: none"> 75-ohm unbalanced coaxial cable 120-ohm balanced twisted pair cable Coaxial connector, network interface connector and 75-ohm to 120-ohm adapter (with BNC connector)
Operating mode	CE1 ISDN PRI (only supported by SIC-1VE1) R2
Services	<ul style="list-style-type: none"> Backup Terminal access ISDN (only supported by SIC-1VE1)

Interface LEDs

Figure 32 SIC-1VE1 panel

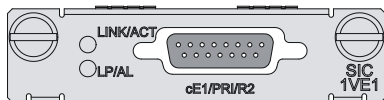

Table 46 LED description

LED	Description
LINK/ACT	<ul style="list-style-type: none"> On means carrier signal has been received. Flashing means data is being transmitted or received. Off means no carrier signal has been received.
LP/AL	<ul style="list-style-type: none"> On means the interface is in a loopback. Flashing means an AIS, LFA, or RAI alarm signal is present. Off means neither loopback nor alarm is present.
<p>Note: AIS = Alarm indication signal; LFA = loss of frame alignment; RAI = Remote alarm indication</p>	

Interface cables and connection methods

For more information about E1 interface cables, see "E1 interface."

SIC-1VT1

Introduction

The 1-port T1 voice interface module (SIC-1VT1) handles dense voice signals in a VoIP system. It provides a CT1/PRI/R2 port that can process a maximum of 23 channels of voice signals.

Interface specifications

Table 47 Interface specifications

Item	Specification
Connector	RJ-45
Number of connector	1
Interface standard	<ul style="list-style-type: none">• G.703/T1.102• G.704• AT&T TR 54016• AT&T TR 62411• ANSI T1.403
Interface rate	1.544 Mbps
Cable type	T1 cable (100-ohm standard shielded cable)
Operating mode	CT1 ISDN PRI
Services	Backup Terminal access ISDN

Interface LEDs

Figure 33 SIC-1VT1 panel

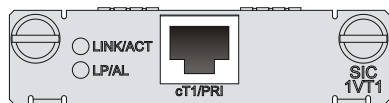

Table 48 LED description

LED	Description
LINK/ACT	<ul style="list-style-type: none">• On means carrier signal has been received.• Flashing means data is being transmitted or received.• Off means no carrier signal has been received.
LP/AL	<ul style="list-style-type: none">• On means the interface is in a loopback.• Flashing means an AIS, LFA, or RAI alarm signal is present.• Off means neither loopback nor alarm is present.
Note: AIS = Alarm indication signal; LFA = loss of frame alignment; RAI = Remote alarm indication	

Interface cables and connection methods

For more information about T1 interface cables and connection methods, see "[T1 interface](#)."

SIC-1VE1T1

Introduction

The 1-port E1/T1 voice interface module SIC-1VE1T1 handles dense voice signals in VoIP and FoIP systems. The E1 module transmits, receives, and processes E1 voice signals. It allows the interface to operate in CE1 mode or ISDN PRI mode to process a maximum of 30 channels of voice signals. The T1 module transmits, receives, and processes T1 voice signals. It allows the interface to operate in CT1 mode or ISDN PRI mode to process a maximum of 23 channels of voice signals.

You can use command lines and a jumper to configure the interface as a 75-ohm E1 interface, 100-ohm T1 interface, or 120-ohm E1 interface. By default, the interface is a 75-ohm E1 interface.

- To configure the interface as a 75-ohm E1 interface, connect the jumper to pins 1 and 2, pins 7 and 8, pins 11 and 12, and pins 13 and 14.
- To configure the interface as a 100-ohm T1 or 120-ohm E1 interface, connect the jumper to pins 1 to 3, pins 5 to 7, pins 9 and 10, and pins 11 to 13.

Figure 34 Jumper connecting methods

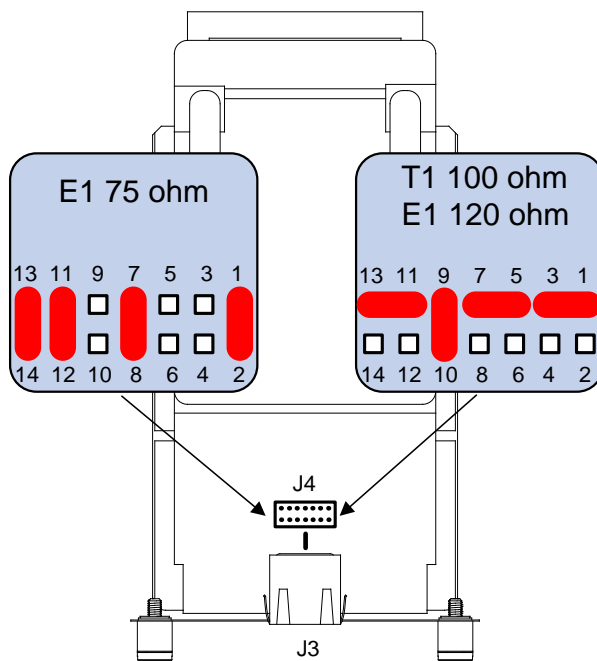

Interface specifications

Table 49 Interface specifications

Item	Specification
Connector	RJ-45
Number of connector	1
Interface standard	<ul style="list-style-type: none">• G.703• G.704

Item	Specification
Interface rate	<ul style="list-style-type: none"> E1 interface: 2.048Mbps T1 interface: 1.544 Mbps
Cable type	<ul style="list-style-type: none"> E1 75-ohm coaxial cable E1 120-ohm twisted pair cable: 2 m (6.56 ft), 15 m (49.21 ft), or 30 m (98.43 ft) T1 100-ohm standard shielded cable Coaxial connector, network interface connector, or 75-to-120-ohm adapter (with BNC connector)
Operating mode	<ul style="list-style-type: none"> E1 T1 CE1T1 ISDN PRI
Services	Backup Terminal access ISDN PRI

Interface LEDs

Figure 35 SIC-1VE1T1 panel

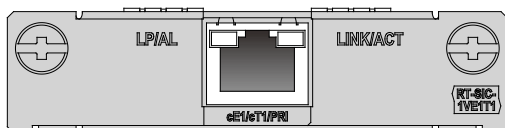

Table 50 LED description

LED	Description
LINK/ACT	<ul style="list-style-type: none"> Steady green: Carrier signal has been received. Flashing green at 4 Hz: Data is being transmitted or received. Off: No carrier signals have been received.
LP/AL	<ul style="list-style-type: none"> Steady yellow: The interface is in loopback mode. Flashing yellow at 0.5 Hz: An AIS, LFA, or RAI alarm is present. Off: Neither loopback nor alarm is present.

Interface cables and connection methods

For more information about E1 interface cables and connection methods, see "[E1 interface](#)."

For more information about T1 interface cables and connection methods, see "[T1 interface](#)."

WLAN interface module

- SIC-WLAN-b/g/n
- SIC-WLAN-b/g/n(NA)

SIC-WLAN-b/g/n/SIC-WLAN-b/g/n(NA)

Introduction

The SIC-WLAN-b/g/n module receives and sends 802.11b/g/n WIFI protocol data. Two external omnidirectional antennas are available on the module. The antennas follow the 802.11b/g/n standard, work on the 2.4 GHz channel and support 2*2 radio MIMO.

The SIC-WLAN-b/g/n (NA) modules are applicable only in North America, and the area code is fixed at NA. The other specifications for the SIC-WLAN-b/g/n (NA) modules are the same as the SIC-WLAN-b/g/n modules.

Interface specifications

Table 51 Interface specifications

Item	Specification
Interface standard	Supports 802.11b/g/n standard. Works at the 2.4 G band.
Rate	54 Mbps 300 Mbps (40 MHz) 130 Mbps(20 MHz)
Operating mode	CCK+ OFDM + 2*2 Radio MIMO
Services	WLAN Layer 2/Layer 3 access WLAN encryption WLAN security

Interface LEDs

Figure 36 SIC-WLAN-b/g/n panel



Table 52 LED description

LED	Description
LINK/ACT	<ul style="list-style-type: none">Off means the link is idle.Steady green means a link is present and a call connection is being established.Flashing yellow means a link is present and there is a call activity.

Interface cables and connection methods

For more information about WLAN interface cables and connection methods, see "[WLAN interface](#)."

3G interface module

- SIC-3G-GSM
- SIC-3G-HSPA
- SIC-3G-HSPA+

SIC-3G-GSM

Introduction

The SIC-3G-GSM module provides access to 3G networks. It supports the following features:

- General Packet Radio Service (GPRS)
- Enhanced Data Rate for GSM Evolution (EDGE)
- Universal Mobile Telecommunications System (UMTS)
- High Speed Downlink Packet Access (HSDPA)

Interface specifications

Table 53 Interface specifications

Item	Specification
Connector type	TNC: For connecting an antenna and accessing WLANs. RJ-45: For connecting to a third-party WLAN debugging and testing software such as CAIT of Qualcomm.
Number of connectors	1 TNC RF 1 RJ-45
Interface standard	TNC RF: Omni antenna, supporting GPRS/EDGE/UMTS/HSDPA. RJ-45: RS232
Cable type	TNC RF: None RJ-45: AUX cable
Rates	<ul style="list-style-type: none"> • HSDPA (downlink: 7.2 Mbps) • HSUPA (uplink: 5.76 Mbps) • UMTS (downlink: 384 Mbps, uplink: 384 Kbps) • EDGE (downlink: 236.8 Kbps, uplink: 236.8 Kbps) • GPRS (downlink: 85.6 Kbps, uplink: 85.6 Kbps)
Services	GPRS/EDGE/UMTS/HSDPA

Interface LEDs

Figure 37 SIC-3G-GSM panel

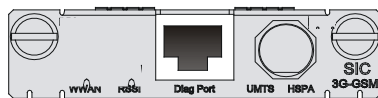

Table 54 LED description

LED	Description
WWAN	<ul style="list-style-type: none"> • Steady green means that a link is present. • Flashing green means that data is being transmitted or received.
RSSI	<ul style="list-style-type: none"> • Steady green means strong signal. • Flashing green means middle or low signal. • Off means weak signal or no signal.
UMTS	<ul style="list-style-type: none"> • Steady yellow means the service is valid. • Off means no service.

LED	Description
HSDPA	<ul style="list-style-type: none"> Steady yellow means the service is valid. Off means no service.

Antenna, interface cable, and the connection method

For more information about SIC-3G-GSM interface cables and connection methods, see "[WLAN interface](#)."

Installing a SIM card

1. Push the 3G SIM card holder in the direction marked "OPEN" so the holder projects upwards. Do not insert the 3G SIM card to the card holder before projecting the card holder up. Do not forcibly lift the holder.
2. Insert the 3G SIM card along the slide rails to the holder.
3. Put down the holder and push the holder in the direction marked "LOCK" to lock the card in position.
4. Position the 3G SIM card socket cover and fasten the screws on the cover.
5. Execute the **display cellular [slot]/0 all** command after the router is started. When "SIM Status = OK" appears in the output information, the SIM card is identified.

SIC-3G-HSPA

Introduction

The SIC-3G-HSPA module provides access to 3G networks. It provides the following features:

- GPRS
- EDGE
- UMTS
- HSDPA

Interface specifications

Table 55 Interface specifications

Item	Specification
Connector type	TNC: For connecting an antenna and accessing WLANs. RJ-45: For connecting to a third-party WLAN debugging and testing software such as CAIT of Qualcomm.
Number of connectors	2 TNC RF 1 RJ-45
Interface standard	TNC RF: Omni antenna, supporting GPRS/EDGE/UMTS/HSDPA. RJ-45: RS232
Cable type	TNC RF: None RJ-45: AUX cable
Rates	<ul style="list-style-type: none"> HSDPA (downlink: 7.2 Mbps) HSUPA (uplink: 5.76 Mbps) UMTS (downlink: 384 Mbps, uplink: 384 Kbps) EDGE (downlink: 236.8 Kbps, uplink: 236.8 Kbps) GPRS (downlink: 85.6 Kbps, uplink: 85.6 Kbps)
Services	GPRS/EDGE/UMTS/HSDPA

Item	Specification
Supported wireless band	850/900/1900/2100MHz WCDMA/HSDPA/HSUPA 850/900/1800/1900MHz GPRS/EDGE

Interface LEDs

Figure 38 SIC-3G-HSPA panel

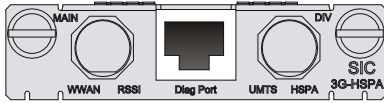

Table 56 LED description

LED	Description
WWAN	<ul style="list-style-type: none"> Steady green means that a link is present. Flashing green means that data is being transmitted or received.
RSSI	<ul style="list-style-type: none"> Steady green means strong signal. Flashing green means middle or low signal. Off means weak signal or no signal.
UMTS	<ul style="list-style-type: none"> Steady yellow means the service is valid. Off means no service.
HSDPA	<ul style="list-style-type: none"> Steady yellow means the service is valid. Off means no service.

Antenna, interface cables, and connection methods

⚠ CAUTION:

The 3G antenna provided with the SIC-3G-HSPA must be installed on the antenna port that has a MAIN mark.

For more information about SIC-3G-HSPA Interface cables and connection methods, see "[WLAN interface](#)."

Installing a SIM card

1. Push the 3G SIM card holder in the direction marked "OPEN" so the holder projects upwards. Do not insert the 3G SIM card to the card holder before projecting the card holder up. Do not forcibly lift the holder.
2. Insert the 3G SIM card along the slide rails to the holder.
3. Put down the holder and push the holder in the direction marked "LOCK" to lock the card in position.
4. Position the 3G SIM card socket cover and fasten the screws on the cover.
5. Execute the **display cellular [slot]/0 all** command after the router is started. When "SIM Status = OK" appears in the output information, the SIM card is identified.

SIC-3G-HSPA+

Introduction

The SIC-3G-HSPA+ module provides access to 3G networks. It provides the following features:

- GPRS

- EDGE
- UMTS
- HSDPA

Interface specifications

Table 57 Interface specifications

Item	Specification
Connector type	TNC: For connecting an antenna and accessing WLANs. RJ-45: For connecting to a third-party WLAN debugging and testing software such as CAIT of Qualcomm.
Number of connectors	2 TNC RF 1 RJ-45
Interface standard	TNC RF: Omni antenna, supporting GPRS/EDGE/UMTS/HSDPA. RJ-45: RS232
Cable type	TNC RF: None RJ-45: AUX cable
Rates	<ul style="list-style-type: none"> • HSDPA (downlink: 7.2 Mbps) • HSUPA (uplink: 5.76 Mbps) • UMTS (downlink: 384 Mbps, uplink: 384 Kbps) • EDGE (downlink: 236.8 Kbps, uplink: 236.8 Kbps) • GPRS (downlink: 85.6 Kbps, uplink: 85.6 Kbps)
Services	GPRS/EDGE/UMTS/HSDPA
Supported wireless band	850/900/1900/2100MHz WCDMA/HSDPA/HSUPA 850/900/1800/1900MHz GPRS/EDGE

Interface LEDs

Figure 39 SIC-3G-HSPA+ panel

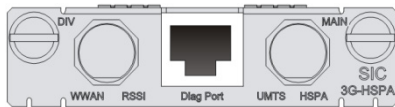

Table 58 LED description

LED	Description
WWAN	<ul style="list-style-type: none"> • Steady green means that a link is present. • Flashing green means that data is being transmitted or received.
RSSI	<ul style="list-style-type: none"> • Steady green means strong signal. • Flashing green means middle or low signal. • Off means weak signal or no signal.
UMTS	<ul style="list-style-type: none"> • Steady yellow means the service is valid. • Off means no service.
HSDPA	<ul style="list-style-type: none"> • Steady yellow means the service is valid. • Off means no service.

Antenna, interface cables, and connection methods

CAUTION:

The 3G antenna provided with the SIC-3G-HSPA+ must be installed on the antenna port that has a MAIN mark.

For more information about SIC-3G-HSPA+ Interface cables and connection methods, see "[WLAN interface](#)."

Installing a SIM card

1. Push the 3G SIM card holder in the direction marked "OPEN" so the holder projects upwards. Do not insert the 3G SIM card to the card holder before projecting the card holder up. Do not forcibly lift the holder.
2. Insert the 3G SIM card along the slide rails to the holder.
3. Put down the holder and push the holder in the direction marked "LOCK" to lock the card in position.
4. Position the 3G SIM card socket cover and fasten the screws on the cover.
5. Execute the **display cellular [slot]/0 all** command after the router is started. When "SIM Status = OK" appears in the output information, the SIM card is identified.

4G interface module

- SIC-4G-LTE-V (JG742A, JG742B)
- SIC-4G-LTE-A (JG743A, JG743B)
- SIC-4G-LTE-G (JG744A, JG744B)

SIC-4G-LTE-V (JG742A)

The SIC-4G-LTE-V (JG742A) module provides access to 4G WLANs. It supports the following services:

- LTE.
- CDMA.
- GPS.

Interface specifications

Table 59 Interface specifications

Item	Specification
Connector type	<ul style="list-style-type: none">• TNC: Antenna connector for accessing WLANs.• SMA: Antenna connector for accessing GPS.• Mini USB Type AB: For connecting to third-party WLAN debugging and testing software such as CAIT of Qualcomm.
Number of connectors	<ul style="list-style-type: none">• 2 × TNC.• 1 × SMA.• 1 × Mini USB Type AB.
Interface standard	<ul style="list-style-type: none">• TNC: LTE, UMTS, HSPA+, CDMA 1x, EVDO Release 0 & A, Quad-band EDGE, GPRS, and GSM.• SMA: GPS.• Mini USB Type AB: Support for USB devices.

Item	Specification
Cable type	<ul style="list-style-type: none"> TNC: None. SMA: Flexible 174 sized cable. Mini USB Type AB: USB console cable.
Services	<ul style="list-style-type: none"> LTE. CDMA. GPS.

Interface LEDs

Figure 40 SIC-4G-LTE-V (JG742A) panel

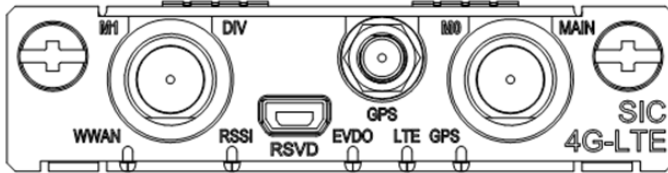

Table 60 LED description

LED	Description
WWAN	<ul style="list-style-type: none"> Steady green: A link is present. Flashing green fast: Data is being transmitted or received. Flashing green slowly: The module is searching for 4G WLANs. Off: No link is present.
RSSI	<ul style="list-style-type: none"> Steady green: Strong signal strength. The RSSI is equal to or greater than -69 dBm. Flashing green fast: Middle- or low-level signal strength. The RSSI is equal to or greater than -89 dBm and less than -69 dBm. Flashing green slowly: Low signal strength. The RSSI is equal to or greater than -99 dBm and less than -89 dBm. Off: Weak or no signal strength. The RSSI is less than -99 dBm.
EVDO	<ul style="list-style-type: none"> Flashing green: The EVDO service is valid. Off: The EVDO service is not available.
LTE	<ul style="list-style-type: none"> Steady green: The LTE service is valid. Off: The LTE service is not available.
GPS	<ul style="list-style-type: none"> Steady green: The GPS service is valid. Off: The GPS service is not available.

Connecting the antenna and interface cable

For more information about connecting antennas and interface cables for the interface module, see ["4G interface."](#)

Installing a SIM card

1. Push the 4G SIM card holder in the direction marked "OPEN" so the holder projects upwards. Do not insert the 4G SIM card to the card holder before projecting the card holder up. Do not forcibly lift the holder.
2. Insert the 4G SIM card along the slide rails to the holder.
3. Put down the holder and push the holder in the direction marked "LOCK" to lock the card in position.
4. Position the 4G SIM card socket cover and fasten the screws on the cover.

5. Execute the **display cellular [slot]/0 all** command after the router is started. When "SIM Status = OK" appears in the output information, the SIM module is identified.

SIC-4G-LTE-V (JG742B)

The SIC-4G-LTE-V (JG742B) module provides access to 4G WLANs. It supports the following services:

- LTE.
- EVDO Release 0 & A.
- UMTS.
- HSPA+.
- DC-HSPA+.
- Quad-band EDGE.
- GPRS.
- GSM.
- GNSS.

Interface specifications

Table 61 Interface specifications

Item	Specification
Connector type	<ul style="list-style-type: none"> • TNC: Antenna connector for accessing WLANs. • SMA: Antenna connector for accessing GNSS. • Mini USB Type AB: For connecting to third-party WLAN debugging and testing software such as CAIT of Qualcomm.
Number of connectors	<ul style="list-style-type: none"> • 2 × TNC. • 1 × SMA. • 1 × Mini USB Type AB.
Interface standard	<ul style="list-style-type: none"> • TNC: LTE, UMTS, HSPA+, CDMA 1x, EVDO Release 0 & A, Quad-band EDGE, GPRS, and GSM. • SMA: GNSS. • Mini USB Type AB: Support for USB devices.
Cable type	<ul style="list-style-type: none"> • TNC: None. • SMA: Flexible 174 sized cable. • Mini USB Type AB: USB console cable.
Services	<ul style="list-style-type: none"> • LTE. • EVDO Release 0 & A. • UMTS. • HSPA+. • DC-HSPA+. • Quad-band EDGE. • GPRS. • GSM. • GNSS.

Interface LEDs

Figure 41 SIC-4G-LTE-V (JG742B) panel

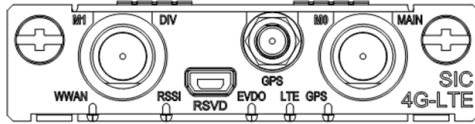

Table 62 LED description

LED	Description
WWAN	<ul style="list-style-type: none"> Steady green: A link is present. Flashing green fast: Data is being transmitted or received. Flashing green slowly: The module is searching for 4G WLANs. Off: No link is present.
RSSI	<ul style="list-style-type: none"> Steady green: Strong signal strength. The RSSI is equal to or greater than -69 dBm. Flashing green fast: Middle- or low-level signal strength. The RSSI is equal to or greater than -89 dBm and less than -69 dBm. Flashing green slowly: Low signal strength. The RSSI is equal to or greater than -99 dBm and less than -89 dBm. Off: Weak or no signal strength. The RSSI is less than -99 dBm.
EVDO	<ul style="list-style-type: none"> Flashing green: The EVDO service is valid. Off: The EVDO service is not available.
LTE	<ul style="list-style-type: none"> Steady green: The LTE service is valid. Off: The LTE service is not available.
GPS	<ul style="list-style-type: none"> Steady green: The GPS service is valid. Off: The GPS service is not available.

Connecting the antenna and interface cable

For more information about connecting antennas and interface cables for the interface module, see ["4G interface."](#)

Installing a SIM card

1. Push the 4G SIM card holder in the direction marked "OPEN" so the holder projects upwards. Do not insert the 4G SIM card to the card holder before projecting the card holder up. Do not forcibly lift the holder.
2. Insert the 4G SIM card along the slide rails to the holder.
3. Put down the holder and push the holder in the direction marked "LOCK" to lock the card in position.
4. Position the 4G SIM card socket cover and fasten the screws on the cover.
5. Execute the **display cellular [slot]/0 all** command after the router is started. When "SIM Status = OK" appears in the output information, the SIM module is identified.

SIC-4G-LTE-A (JG743A)

The SIC-4G-LTE-A (JG743A) module provides access to 4G networks. It supports the following services:

- LTE.
- UMTS.
- HSPA+.

- DC-HSPA+.
- Quad-band EDGE.
- GPRS.
- GSM.
- GPS.

Interface specifications

Table 63 Interface specifications

Item	Specification
Connector type	<ul style="list-style-type: none"> • TNC: Antenna connector for accessing WLANs. • SMA: Antenna connector for accessing GPS. • Mini USB Type AB: For connecting to third-party WLAN debugging and testing software such as CAIT of Qualcomm.
Number of connectors	<ul style="list-style-type: none"> • 2 × TNC. • 1 × SMA. • 1 × Mini USB Type AB.
Interface standard	<ul style="list-style-type: none"> • TNC: LTE, UMTS, HSPA+, CDMA 1x, EVDO Release 0 & A, Quad-band EDGE, GPRS, and GSM. • SMA: GNSS. • Mini USB Type AB: Support for USB devices.
Cable type	<ul style="list-style-type: none"> • TNC: None. • SMA: Flexible 174 sized cable. • Mini USB Type AB: USB console cable.
Services	<ul style="list-style-type: none"> • LTE. • UMTS. • HSPA+. • DC-HSPA+. • Quad-band EDGE. • GPRS. • GSM. • GPS.

Interface LEDs

Figure 42 SIC-4G-LTE-A (JG743A) panel

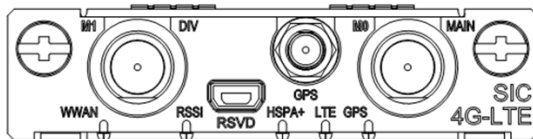

Table 64 LED description

LED	Description
WWAN	<ul style="list-style-type: none"> • Steady green: A link is present. • Flashing green fast: Data is being transmitted or received. • Flashing green slowly: The module is searching for 4G WLANs. • Off: No link is present.

LED	Description
RSSI	<ul style="list-style-type: none"> Steady green: Strong signal strength. The RSSI is equal to or greater than -69 dBm. Flashing green fast: Middle- or low-level signal strength. The RSSI is equal to or greater than -89 dBm and less than -69 dBm. Flashing green slowly: Low signal strength. The RSSI is equal to or greater than -99 dBm and less than -89 dBm. Off: Weak or no signal strength. The RSSI is less than -99 dBm.
HSPA+	<ul style="list-style-type: none"> Steady green: The HSPA+ or HSDPA service is valid. Off: The HSPA+ or HSDPA service is not available.
LTE	<ul style="list-style-type: none"> Steady green: The LTE service is valid. Off: The LTE service is not available.
GPS	<ul style="list-style-type: none"> Steady green: The GPS service is valid. Off: The GPS service is not available.

Connecting the antenna and interface cables

For more information about connecting antennas and interface cables for the interface module, see ["4G interface."](#)

Installing a SIM card

1. Push the 4G SIM card holder in the direction marked "OPEN" so the holder projects upwards. Do not insert the 4G SIM card to the card holder before projecting the card holder up. Do not forcibly lift the holder.
2. Insert the 4G SIM card along the slide rails to the holder.
3. Put down the holder and push the holder in the direction marked "LOCK" to lock the card in position.
4. Position the 4G SIM card socket cover and fasten the screws on the cover.
5. Execute the **display cellular [slot]/0 all** command after the router is started. When "SIM Status = OK" appears in the output information, the SIM card is identified.

SIC-4G-LTE-A (JG743B)

The SIC-4G-LTE-A (JG743B) module provides access to 4G networks. It supports the following services:

- LTE.
- EVDO Release 0 & A.
- UMTS.
- HSPA+.
- DC-HSPA+.
- Quad-band EDGE.
- GPRS.
- GSM.
- GNSS.

Interface specifications

Table 65 Interface specifications

Item	Specification
Connector type	<ul style="list-style-type: none"> • TNC connector: For connecting to a wireless network antenna. • SMA connector: For connecting to a GPS antenna. • Mini USB Type AB connector: For connecting to third-party WLAN debugging and testing software such as CAIT of Qualcomm.
Number of connectors	<ul style="list-style-type: none"> • 2 × TNC connector. • 1 × SMA connector. • 1 × Mini USB Type AB connector.
Interface standard	<ul style="list-style-type: none"> • TNC connector: LTE, UMTS, HSPA+, CDMA 1x, EVDO Release 0 & A, Quad-band EDGE, GPRS, and GSM. • SMA connector: GNSS. • Mini USB Type AB connector: Support for USB devices.
Cable type	<ul style="list-style-type: none"> • TNC connector: None. • SMA connector: Flexible 174 sized cable. • Mini USB Type AB connector: USB console cable.
Supported services	<ul style="list-style-type: none"> • LTE. • EVDO Release 0 & A. • UMTS. • HSPA+. • DC-HSPA+. • Quad-band EDGE. • GPRS. • GSM. • GNSS.

Interface LEDs

Figure 43 SIC-4G-LTE-A (JG743B) panel

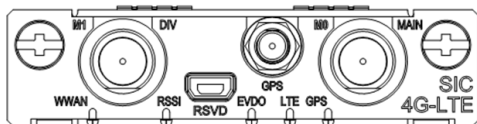

Table 66 LED description

LED	Description
WWAN	<ul style="list-style-type: none"> • Steady green: A link is present. • Flashing green fast: Data is being transmitted or received. • Flashing green slowly: The module is searching for wireless networks. • Off: No link is present.
RSSI	<ul style="list-style-type: none"> • Steady green: Strong signal strength. The RSSI is equal to or greater than -69 dBm. • Flashing green fast: Middle-level signal strength. The RSSI is equal to or greater than -89 dBm and less than -69 dBm. • Flashing green slowly: Low signal strength. The RSSI is equal to or greater than -99 dBm and less than -89 dBm. • Off: Weak or no signal strength. The RSSI is less than -99 dBm.

LED	Description
EVDO	<ul style="list-style-type: none"> Flashing green: The EVDO service is valid. Off: The EVDO service is not available.
LTE	<ul style="list-style-type: none"> Steady green: The LTE service is valid. Off: The LTE service is not available.
GPS	<ul style="list-style-type: none"> Steady green: The GPS service is valid. Off: The GPS service is not available.

Connecting the antenna and interface cables

For information about connecting antennas and interface cables for the interface module, see "[4G interface](#)."

Installing a SIM card

1. Push the 4G SIM card holder in the direction marked "OPEN" so the holder projects upwards. Do not insert the 4G SIM card to the card holder before projecting the card holder up. Do not forcibly lift the holder.
2. Insert the 4G SIM card along the slide rails into the holder. Correctly orient the SIM card so that the angled corner of the SIM card fits in the holder.
3. Put down the holder and push the holder in the direction marked "LOCK" to lock the card in position.
4. Execute the **display cellular [slot]/0 all** command after the router is started. If message "SIM Status = OK" is displayed in the output information, the SIM card is identified.

SIC-4G-LTE-G (JG744A)

The SIC-4G-LTE-G module (JG744A) provides access to 4G networks. It supports the following services:

- LTE.
- UMTS.
- HSPA+.
- Quad-band EDGE.
- GPRS.
- GSM.
- GPS.

Interface specifications

Table 67 Interface specifications

Item	Specification
Connector type	<ul style="list-style-type: none"> TNC: Antenna connector for accessing WLANs. SMA: Antenna connector for accessing GPS. Mini USB Type AB: For connecting to third-party WLAN debugging and testing software such as CAIT of Qualcomm.
Number of connectors	<ul style="list-style-type: none"> 2 × TNC. 1 × SMA. 1 × Mini USB Type AB.

Item	Specification
Interface standard	<ul style="list-style-type: none"> TNC: LTE, UMTS, HSPA+, CDMA 1x, EVDO Release 0 & A, Quad-band EDGE, GPRS, and GSM. SMA: GPS. Mini USB Type AB: Support for USB devices.
Cable type	<ul style="list-style-type: none"> TNC: None SMA: Flexible 174 sized cable Mini USB Type AB: USB console cable
Services	<ul style="list-style-type: none"> LTE. UMTS. HSPA+. Quad-band EDGE. GPRS. GSM. GPS.

Interface LEDs

Figure 44 SIC-4G-LTE-G (JG744A) panel

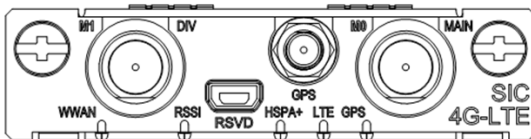

Table 68 LED description

LED	Description
WWAN	<ul style="list-style-type: none"> Steady green: A link is present. Flashing green fast: Data is being transmitted or received. Flashing green slowly: The module is searching for 4G WLANs. Off: No link is present.
RSSI	<ul style="list-style-type: none"> Steady green: Strong signal strength. The RSSI is equal to or greater than -69 dBm. Flashing green fast: Middle- or low-level signal strength. The RSSI is equal to or greater than -89 dBm and less than -69 dBm. Flashing green slowly: Low signal strength. The RSSI is equal to or greater than -99 dBm and less than -89 dBm. Off: Weak or no signal strength. The RSSI is less than -99 dBm.
HSPA+	<ul style="list-style-type: none"> Steady green: The HSPA+ or HSDPA service is valid. Off: The HSPA+ or HSDPA service is not available.
LTE	<ul style="list-style-type: none"> Steady green: The LTE service is valid. Off: The LTE service is not available.
GPS	<ul style="list-style-type: none"> Steady green: The GPS service is valid. Off: The GPS service is not available.

Connecting the antenna and interface cables

For more information about connecting antennas and interface cables for the interface module, see "[4G interface](#)."

Installing a SIM card

1. Push the 4G SIM card holder in the direction marked "OPEN" so the holder projects upwards. Do not insert the 4G SIM card to the card holder before projecting the card holder up. Do not forcibly lift the holder.
2. Insert the 4G SIM card along the slide rails to the holder.
3. Put down the holder and push the holder in the direction marked "LOCK" to lock the card in position.
4. Position the 4G SIM card socket cover and fasten the screws on the cover.
5. Execute the **display cellular [slot]/0 all** command after the router is started. When "SIM Status = OK" appears in the output information, the SIM card is identified.

SIC-4G-LTE-G (JG744B)

The SIC-4G-LTE-G module (JG744B) provides access to 4G networks. It supports the following services:

- LTE.
- UMTS.
- HSPA+.
- DC-HSPA+.
- Quad-Band EDGE.
- GPRS.
- GSM.
- GNSS.

Interface specifications

Table 69 Interface specifications

Item	Specification
Connector type	<ul style="list-style-type: none">• TNC: Antenna connector for accessing WLANs.• SMA: Antenna connector for accessing GNSS.• Mini USB Type AB: For connecting to third-party WLAN debugging and testing software such as CAIT of Qualcomm.
Number of connectors	<ul style="list-style-type: none">• 2 × TNC.• 1 × SMA.• 1 × Mini USB Type AB.
Interface standard	<ul style="list-style-type: none">• TNC: LTE, UMTS, HSPA+, CDMA 1x, EVDO Release 0 & A, Quad-Band EDGE, GPRS, and GSM.• SMA: GNSS.• Mini USB Type AB: Support for USB devices.
Cable type	<ul style="list-style-type: none">• TNC: None• SMA: Flexible 174 sized cable• Mini USB Type AB: USB console cable

Item	Specification
Services	<ul style="list-style-type: none"> • LTE. • UMTS. • HSPA+. • DC-HSPA+. • Quad-Band EDGE. • GPRS. • GSM. • GNSS.

Interface LEDs

Figure 45 SIC-4G-LTE-G (JG744B) panel

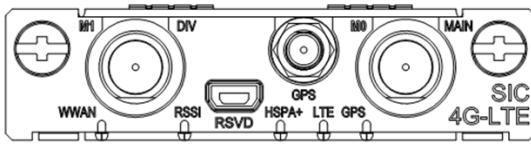

Table 70 LED description

LED	Description
WWAN	<ul style="list-style-type: none"> • Steady green: A link is present. • Flashing green fast: Data is being transmitted or received. • Flashing green slowly: The module is searching for 4G WLANs. • Off: No link is present.
RSSI	<ul style="list-style-type: none"> • Steady green: Strong signal strength. The RSSI is equal to or greater than -69 dBm. • Flashing green fast: Middle- or low-level signal strength. The RSSI is equal to or greater than -89 dBm and less than -69 dBm. • Flashing green slowly: Low signal strength. The RSSI is equal to or greater than -99 dBm and less than -89 dBm. • Off: Weak or no signal strength. The RSSI is less than -99 dBm.
HSPA+	<ul style="list-style-type: none"> • Steady green: The HSPA+ or HSDPA service is valid. • Off: The HSPA+ or HSDPA service is not available.
LTE	<ul style="list-style-type: none"> • Steady green: The LTE service is valid. • Off: The LTE service is not available.
GPS	<ul style="list-style-type: none"> • Steady green: The GPS service is valid. • Off: The GPS service is not available.

Connecting the antenna and interface cables

For more information about connecting antennas and interface cables for the interface module, see "[4G interface.](#)"

Installing a SIM card

1. Push the 4G SIM card holder in the direction marked "OPEN" so the holder projects upwards. Do not insert the 4G SIM card to the card holder before projecting the card holder up. Do not forcibly lift the holder.
2. Insert the 4G SIM card along the slide rails to the holder.

3. Put down the holder and push the holder in the direction marked "LOCK" to lock the card in position.
4. Position the 4G SIM card socket cover and fasten the screws on the cover.
5. Execute the **display cellular [slot]/0 all** command after the router is started. When "SIM Status = OK" appears in the output information, the SIM card is identified.

MIM/DMIM/XMIM

The MSR series routers provide a wide range of optional MIM/DMIMs. The MIM/DMIMs provide interfaces such as synchronous/asynchronous serial interface, Ethernet interface, E1/T1, ISDN BRI/PRI, audio interface, and Layer 2 switching interface.

The MIM-16FSW and the DMIM-24FSW support PoE to provide –48 VDC power to remote PDs such as IP phone, AP, and network camera through straight-through network cables when installed in a PoE router.

Ethernet switching module

- MIM-16FSW
- MIM-16FSW-PoE
- DMIM-24FSW
- DMIM-24FSW-PoE
- XMIM-16FSW
- XMIM-24FSW

XMIM-16FSW/XMIM-24FSW

Introduction

The 16/24-port 10/100 Mbps Ethernet Layer 2 switching MIM interface modules (XMIM-16FSW and XMIM-24FSW) can be installed on the MSR30-11. Both the XMIM-16FSW and XMIM-24FSW are suitable for a small enterprise network to act as a switching & routing device, which can be directly connected to PCs and network devices of the enterprise.

Interface specifications

Table 71 Interface specifications

Item	Specification
Connector type	RJ-45
Interface type	MDI/MDIX
Number of connectors	16/24 × 100 Mbps RJ-45 connector
Transmission distance	100 m (328.08 ft) over category-5 twisted pair cables (both crossover and straight-through)
Operating mode	10/100 Mbps auto-sensing, full duplex/half duplex

Interface LEDs

Figure 46 XMIM-16FSW panel

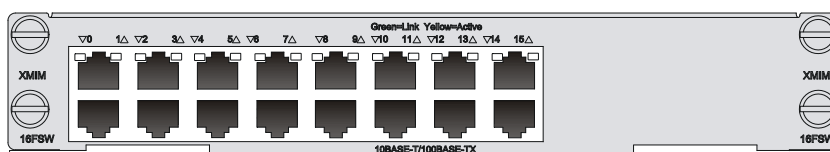
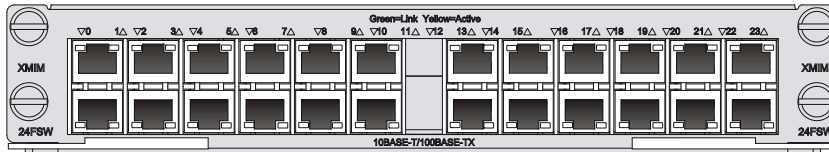

Figure 47 XMIM-24FSW panel



Each 10/100 Mbps Ethernet interface on the panel has two LEDs.

Table 72 LED description

LED status	Description
Green LED (LINK)	<ul style="list-style-type: none"> On: A link is present. Off: No link is present.
Yellow LED (ACT)	<ul style="list-style-type: none"> Flashing: Data is being received and sent on the port. Off: No data is being received or sent on the port.

Interface cables and connection methods

For more information about the Ethernet interface cables and connection methods, see "[Ethernet interface](#)."

MIM-16FSW/MIM-16FSW-PoE/DMIM-24FSW/DMIM-24FSW-PoE

Introduction

The 16/24-port 10/100 Mbps Ethernet Layer 2 switching MIM interface modules (MIM-16FSW/MIM-16FSW-PoE and DMIM-24FSW/DMIM-24FSW-PoE) are applicable to MSR30 series routers. A router installed with MIM-16FSW or DMIM-24FSW can work as a switching and routing integrated device on a small-sized enterprise network to connect PCs and network devices inside the network. The MIM-16FSW-PoE/DMIM-24FSW-PoE can supply power to PDs through PoE.

Interface specifications

Table 73 Interface specifications

Item	MIM-16FSW/MIM-16FSW-PoE	DMIM-24FSW/DMIM-24FSW-PoE
Connector	RJ-45	RJ-45 + SFP fiber port
Interface type	MDI/MDIX	MDI/MDIX + SFP fiber port
Number of connectors	16 × 100 Mbps RJ-45 connector	<ul style="list-style-type: none"> 24 × 100 Mbps RJ-45 connector 2 × 1000 Mbps RJ-45 connector 2 × SFP connectors
Transmission distance	100 m (328.08 ft) over category-5 twisted pair cables (both crossover and straight-through)	100 m (328.08 ft) over category-5 twisted pair cables (both crossover and straight-through) Fiber interface supports SFP fiber module

Item	MIM-16FSW/MIM-16FSW-PoE	DMIM-24FSW/DMIM-24FSW-PoE
Operating mode	10/100 Mbps autosensing, full/half duplex	<ul style="list-style-type: none"> 24 × 100 Mbps copper port: 10/100 Mbps autosensing 2 × GE copper port: 10/100/1000 Mbps autosensing 2 × GE fiber port: GE SFP fiber port

Interface LEDs

Figure 48 MIM-16FSW panel

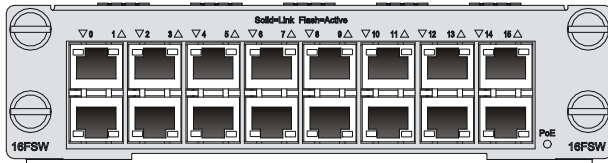

Figure 49 MIM-16FSW-PoE panel

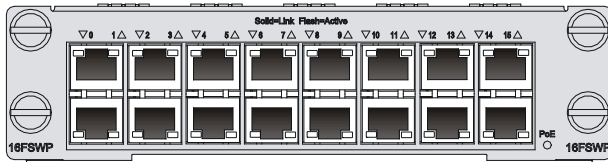

Figure 50 DMIM-24FSW panel



Figure 51 DMIM-24FSW-PoE panel



Table 74 Description for the MIM-16FSW/MIM-16FSW-PoE/DMIM-24FSW/DMIM-24FSW-PoE FE LEDs

LED status	Description
Steady green	A link is present, but no data is being transmitted and received.
Off	No link is present.
Flashing green	A link is present and data is being transmitted and received (ACT).

Table 75 Description for the DMIM-24FSW/DMIM-24FSW-PoE GE interface LEDs

LED status	Description
Off	No link is present.
Steady green	A gigabit link is present, but no data is being transmitted and received.
Flashing green	A gigabit link is present and data is being transmitted and received (ACT).

LED status	Description
Steady yellow	A 100 Mbps link is present, but no data is being transmitted and received.
Flashing yellow	A 100 Mbps link is present and data is being transmitted and received (ACT).

Table 76 Description for the DMIM-24FSW/DMIM-24FSW-PoE fiber interface LEDs

LED status	Description
Off	No link is present.
Steady green	A link is present, but no data is being transmitted and received.
Flashing green	A link is present and data is being transmitted and received (ACT).
Steady yellow	Error prompt

NOTE:

The two GE interfaces on the DMIM-24FSW-PoE do not support PoE.

Interface cables and connection methods

For more information about the Ethernet interface cables and connection methods, see "[Ethernet interface](#)."

For more information about fiber ports, optical fibers, and the connection methods, see "[Fiber port](#)."

Ethernet interface module

- MIM-2FE
- MIM-4FE
- MIM-2GBE

MIM-2FE/MIM-4FE

Introduction

The 2/4-port 10/100Base-TX Fast Ethernet interface module (MIM-2FE/MIM-4FE) completes communications between routers and LANs.

Interface specifications

Table 77 Interface specifications

Item	Specification	
	MIM-2FE	MIM-4FE
Connector	RJ-45	
Type of interface	MDI	
Number of connectors	2	4
Transmission distance	100 m (328.08 ft) over category-5 twisted pair cables (both crossover and straight-through)	
Operating mode	10/100 Mbps autosensing, full duplex/ half-duplex	

Interface LEDs

Figure 52 MIM-2FE panel

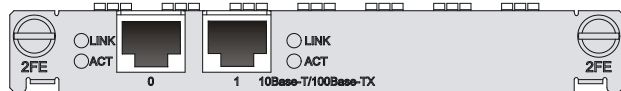

Figure 53 MIM-4FE panel

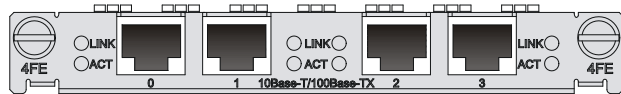

Table 78 LED description

LED	Description
LINK	<ul style="list-style-type: none"> Off means the Ethernet link is not connected. On means the link is connected.
ACTIVE	<ul style="list-style-type: none"> Off means no data is being transmitted or received; Flashing means data is being received or/and transmitted.

Interface cables and connection methods

For more information about the Ethernet interface cables and connection methods, see "[Ethernet interface](#)."

MIM-2GBE

Introduction

The 2-port 10Base-T/100Base-TX/1000Base-T Ethernet electrical interface module completes the communication between a router and a LAN.

Interface specifications

Table 79 Interface specifications

Item	Specification
Connector	RJ-45
Number of connectors	2
Interface type	MDI/MDIX
Interface standard	802.3, 802.3u, 802.3ab
Transmission distance	100 m (328.08 ft) over category-5 twisted pair cables (both crossover and straight-through)
Operating mode	10/100/1000 Mbps auto-sensing, half/full duplex

Interface LEDs

Figure 54 MIM-2GBE



Table 80 LED description

LED	Description
LINK	<ul style="list-style-type: none">• Off means no link is present;• On means a link is present.
ACT	<ul style="list-style-type: none">• Off means no data is being transmitted or received;• Flashing means data is being received or/and transmitted.

Interface cables and connection methods

For more information about the Ethernet interface cables and connection methods, see "[Ethernet interface.](#)"

ATM interface module

- MIM-1ATM-OC3
- MIM-IMA-8E1
- MIM-IMA-4T1

MIM-1ATM-OC3

Introduction

The 1-port ATM (Asynchronous Transfer Mode) 155 Mbps optical interface module (MIM-1ATM-OC3) provides ATM interfaces for routers. It provides the following features:

- Two frame formats: SDH STM-1 and SONET OC-3;
- Scrambling in data transmission;
- Both line clock (when working as DTE interface), and internal clock (when working as DCE interface);
- Three types of test measures: local cell loopback, local payload loopback, and remote loopback.

Interface specifications

Table 81 Interface specifications

Item	Specification
Number of interfaces	1
Connector	SFP/LC
Interface standard	SONET OC-3/SDH STM-1
Operating mode	1000 Mbps, full duplex

Interface LEDs

Figure 55 MIM-1ATM-OC3 panel

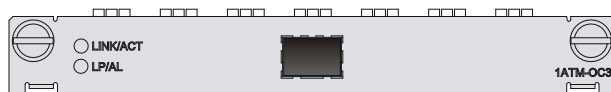

Table 82 LED description

LED	Description
LINK/ACT	<ul style="list-style-type: none"> On means carrier signal has been received. Flashing means data is being received or/and transmitted. Off means no carrier signal has been received.
LP/AL	<ul style="list-style-type: none"> On means the interface is in a loopback. Flashing means an AIS, LFA, or RAI alarm signal is present. Off means no loopback or alarm is present.
Note: LFA = Loss of frame alignment; AIS = Alarm indication signal; RAI = Remote alarm indication.	

Fiber ports, optical fibers, and the connection method

For more information about fiber ports, optical fibers, and the connection methods, see "[Fiber port.](#)"

MIM-IMA-8E1

Introduction

The 8-port E1 ATM inverse multiplexing interface module (MIM-IMA-8E1) provides four/eight E1 interfaces that support the IMA (inverse multiplexing for ATM) technology.

The IMA technology combines multiple low-speed links into a group to support a high-speed ATM cell stream. It distributes an ATM cell stream over multiple low-speed E1 links on cell by cell basis at the transmission end and reassembles the cells on the low-speed E1 links into the original stream at the far end. This technology provides a scalable and cost-effective solution, and is commonly used in plesiochronous digital hierarchy (PDH) networks to transport ATM cells.

Interface specifications

Table 83 Interface specifications

Item	Specification
Connector	DB68
Number of connectors	1
Interface standard	ITU-G.703, ITU-G.704
Interface rate	2.048 Mbps
Cable type	75-ohm 8E1 conversion cable
Max transmission distance	500 m (1640.4 ft)
Operating mode	ATM E1 independent link/IMA bundle mode
Supported service	AAL5 (ATM adaptation layer 5)
Protocol	PPPoA, PPPoEoA, IPoA, IPoEoA
Service type	CBR/VBR-rt/VBR-nrt/UBR

Interface LEDs

Figure 56 MIM-IMA-8E1 (75-ohm) panel

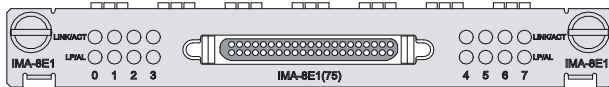

Table 84 LED description

LED	Description
LINK/ACT	<ul style="list-style-type: none"> On means carrier signal has been received. Flashing means data is being received or/and transmitted. Off means no carrier signal has been received.
LP/AL	<ul style="list-style-type: none"> On means the interface is in a loopback. Flashing means an AIS, LFA, or RAI alarm signal is present. Off means no loopback or alarm is present.
Note: AIS = Alarm indication signal; LFA = loss of frame alignment; RAI = Remote alarm indication	

Interface cables and connection methods

For more information about E1 interface cables, see "[E1 interface](#)."

MIM-IMA-4T1

Introduction

The 4-port ATM inverse multiplexing interface module (MIM-IMA-4T1) provides four/eight T1 interfaces that support the IMA technology. Their network application is similar to the MIM-IMA-4E1/MIM-IMA-8E1 module.

Interface specifications

Table 85 Interface specifications

Item	Specification
Connector	DB68
Number of connectors	1
Interface standard	ITU-G.703, ITU-G.704
Cable type	4T1 conversion cable (100-ohm straight-through shielded)
Max transmission distance	150 m (492.1 ft)
Operating mode	ATM T1 independent link/IMA bundle mode
Supported service	AAL5
Protocol	PPPoA, PPPoEoA, IPoA, IPoEoA
Transmission rate	CBR/VBR-rt/VBR-nrt/UBR

Interface LEDs

Figure 57 MIM-IMA-4T1 panel

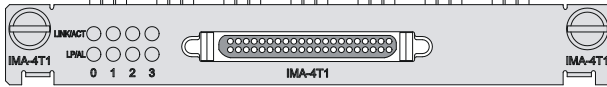

Table 86 LED description

LED	Description
LINK/ACT	<ul style="list-style-type: none">On means carrier signal has been received.Flashing means data is being received or/and transmitted.Off means no carrier signal has been received.
LP/AL	<ul style="list-style-type: none">On means the interface is in a loopback.Flashing means an AIS, LFA, or RAI alarm signal is present.Off means no loopback or alarm is present.
Note: AIS = Alarm indication signal; LFA = loss of frame alignment; RAI = Remote alarm indication	

Interface cables and connection methods

For more information about T1 interface cables and connection methods, see "[T1 interface](#)."

POS (SDH/SONET) interface module

- MIM-1POS

MIM-1POS

Introduction

The 1-port SDH/SONET interface module (MIM-1POS) provides interface rates up to 155.52 Mbps (STM-1/OC-3).

The MIM-1POS can use the protocols such as PPP, Frame Relay, and HDLC at the data link layer and IP at the network layer. It allows direct transmission of packets over SONET/SDH.

Interface specifications

Table 87 Interface specifications

Item	Specification
Connector	SFP/LC
Interface standard	SONET OC-3/SDH STM-1
Number of interfaces	1
Interface rate	155.52 Mbps

Interface LEDs

Figure 58 MIM-1POS panel



Table 88 LED description

LED	Description
LINK/ACT	<ul style="list-style-type: none">On means carrier signal has been received.Flashing means data is being received or/and transmitted.Off means no carrier signal has been received.
LP/AL	<ul style="list-style-type: none">On means the interface is in a loopback.Flashing means an AIS, LFA, or RAI alarm signal is present.Off means no loopback or alarm is present.
Note: AIS = Alarm indication signal; LFA = loss of frame alignment; RAI = Remote alarm indication	

Fiber ports, optical fibers, and the connection methods

For more information about fiber ports, optical fibers, and the connection methods, see "[Fiber port.](#)"

E1/T1 interface module

- MIM-2E1
- MIM-4E1
- MIM-4E1-F
- MIM-8E1
- MIM-8E1-F
- MIM-2T1
- MIM-4T1-F
- MIM-8T1
- MIM-8T1-F

MIM-2E1/MIM-4E1/MIM-4E1-F modules

Introduction

- MIM-2E1/MIM-4E1
The 2-/4-port channelized E1/PRI interface module (MIM-2E1/MIM-4E1) transmits, receives, and processes E1 data traffic. In addition, you can use the module for other purposes, such as CE1 access and the ISDN PRI function.
- MIM-4E1-F
The MIM-4E1-F module differs from the MIM-2E1/MIM-4E1 module in the following ways:
 - The FE1 operating mode supported by the E1-F modules allows only one $n \times 64$ kbps bundle to be formed on each interface, where $n = 1$ to 31. However, an E1 module allows arbitrary grouping of 31 channels and multiple bundles.
 - The E1-F modules do not support PRI mode.

Interface specifications

Table 89 Interface specifications

Item	Specification	
	MIM-2E1	MIM-4E1/4E1-F
Connector	D15	D25
Number of connectors	2	1
Interface standard	G.703, G.704	
Interface rate	2.048 Mbps	
Cable type	<ul style="list-style-type: none"> E1 75-ohm unbalanced coaxial cable E1 120-ohm balanced twisted pair cable 120-ohm 4E1 conversion cable (MIM-4E1/MIM-4E1-F modules) 75-ohm 4E1 conversion cable (MIM-4E1/MIM-4E1-F modules) Coaxial connector, network interface connector and 75-ohm to 120-ohm adapter (with BNC connector) 	
Operating mode	E1, CE1, ISDN PRI (only supported by MIM-2E1/MIM-4E1) FE1 (only supported by MIM-4E1-F)	
Supported service	<ul style="list-style-type: none"> Backup Terminal access service ISDN PRI (only supported by MIM-4E1) 	

Interface LEDs

Figure 59 MIM-2E1 panel

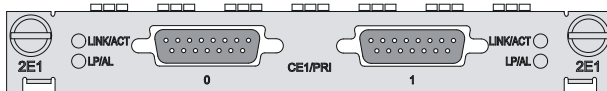

Figure 60 MIM-4E1 panel

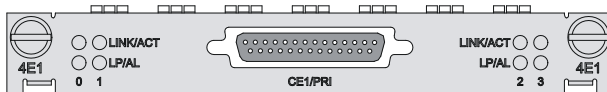

Figure 61 MIM-4E1-F panel

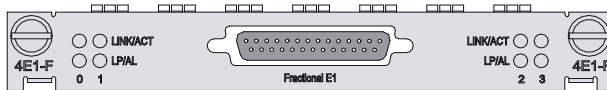

Table 90 LED description

LED	Description
LINK/ACT	<ul style="list-style-type: none"> On means carrier signal has been received. Flashing means data is being received or/and transmitted. Off means no carrier signal has been received.
LP/AL	<ul style="list-style-type: none"> On means the interface is in a loopback. Flashing means an AIS, LFA, or RAI alarm signal is present. Off means no loopback or alarm is present.

LED	Description
Note: AIS = Alarm indication signal; LFA = loss of frame alignment; RAI = Remote alarm indication	

Interface cables and connection methods

For more information about E1 interface cables, see "[E1 interface](#)."

MIM-8E1/MIM-8E1-F

Introduction

- MIM-8E1 module
The 8-port channelized E1/PRI interface module (MIM-8E1) transmits, receives, and processes eight channels of E1 data traffic. In addition, you can use the module for other purposes, such as CE1 access and the ISDN PRI function.
- MIM-8E1-F module
The 8-port fractional E1 interface module (MIM-8E1-F) differs from the MIM-8E1 module in the following ways:
 - The FE1 operating mode supported by the MIM-8E1-F module allows only one $n \times 64$ kbps bundle to be formed on each interface, where $n = 1$ to 31. However, an MIM-8E1 module allows arbitrary grouping of 31 channels and therefore multiple bundles.
 - The MIM-8E1-F module does not support PRI mode.

NOTE:

For a MIM-8E1 module, the system automatically creates a serial interface for each timeslot bundle formed on a controller E1 interface.

Interface specifications

Table 91 Interface specifications

Item	Specification
Connector	D68
Number of connectors	1
Interface standard	G.703
Interface rate	2.048 Mbps
Cable type	75-ohm 8E1 conversion cable
Cable characteristic impedance	75-ohm
Operating mode	E1, CE1, ISDN PRI (only supported by MIM-8E1) FE1 (only supported by MIM-8E1-F)
Supported service	<ul style="list-style-type: none"> • Backup • Terminal access service • ISDN PRI (only supported by MIM-8E1)

Interface LEDs

Figure 62 MIM-8E1 (75-ohm) panel

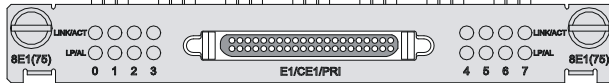

Figure 63 MIM-8E1-F (75-ohm) panel

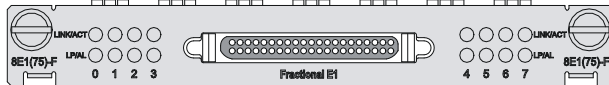

Table 92 LED description

LED	Description
LINK/ACT	<ul style="list-style-type: none"> On means carrier signal has been received. Flashing means data is being received or/and transmitted. Off means no carrier signal has been received.
LP/AL	<ul style="list-style-type: none"> On means the interface is in a loopback. Flashing means an AIS, LFA, or RAI alarm signal is present. Off means no loopback or alarm is present.
<p>Note: AIS = Alarm indication signal; LFA = loss of frame alignment; RAI = Remote alarm indication</p>	

Interface cables and connection methods

For more information about E1 interface cables, see "[E1 interface](#)."

MIM-2T1/MIM-4T1-F

Introduction

- MIM-2T1
The 2-port channelized T1/PRI interface module (MIM-2T1) transmits, receives, and handles T1 data streams, provides CT1 access, and fulfills the function of ISDN PRI.
- MIM-4T1-F
The 4-port fractional T1 interface module (MIM-4T1-F) and MIM-2T1 module differ in the following ways:
 - FT1 operating mode supported by T1-F modules allows only one bundle. The time slots can only be bundled into one $n \times 64$ kbps or 56 kbps channel, where $n=1-24$. However, a CT1 module allows of arbitrary grouping of the 24 channels;
 - T1-F does not support PRI mode.

NOTE:

For a T1 module, the system automatically creates a serial interface for each timeslot bundle formed on a controller T1 interface.

Interface specifications

Table 93 Interface specifications

Item	Specification
Connector	RJ-45
Number of connectors	<ul style="list-style-type: none"> • 2 (MIM-2T1 module) • 4 (MIM-4T1-F module)
Interface standard	<ul style="list-style-type: none"> • G.703/T1.102 • G.704 • AT&T TR 54016 • AT&T TR 62411 • ANSI T1.403
Interface rate	1.544 Mbps
Cable type	T1 cable (100-ohm shielding network cable)
Operating mode	CT1, ISDN PRI (MIM-2T1 module) FT1 (MIM-4T1-F module)
Supported service	<ul style="list-style-type: none"> • Backup • Terminal access service • ISDN PRI (MIM-2T1 module)

Interface LEDs

Figure 64 MIM-2T1 panel

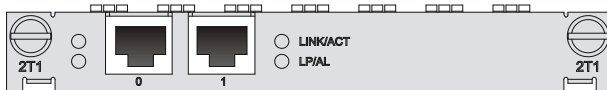

Figure 65 MIM-4T1-F panel

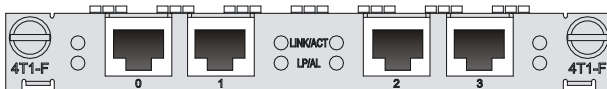

Table 94 LED description

LED	Description
LINK/ACT	<ul style="list-style-type: none"> • On means the carrier signal has been received. • Off means no carrier signal has been received. • Flashing means data is being transmitted or/and received.
LP/AL	<ul style="list-style-type: none"> • On means the interface is in a loopback. • Flashing means an AIS, LFA, or RAI alarm signal is present. • Off means no loopback or alarm is present.
<p>Note: AIS = Alarm indication signal; LFA = loss of frame alignment; RAI = Remote alarm indication</p>	

Interface cables and connection methods

For more information about T1 interface cables and connection methods, see "[T1 interface](#)."

MIM-8T1/MIM-8T1-F

Introduction

- MIM-8T1
The 8-port channelized T1/PRI interface module (MIM-8T1) transmits, receives, and processes eight channels of T1 data traffic. In addition, you can use the module for other purposes, such as CT1 access and the ISDN PRI function.
- MIM-8T1-F
The 8-port fractional T1 interface module (MIM-8T1-F) differs from the 8T1 module in the following ways:
 - The FT1 operating mode supported by the MIM-8T1-F module allows only one $n \times 64$ kbps or $n \times 56$ kbps bundle to be formed on each interface, where $n = 1$ to 24. However, the MIM-8T1 module allows arbitrary grouping of 24 channels and therefore multiple bundles.
 - The MIM-8T1-F module does not support PRI mode.

NOTE:

For a MIM-8T1 module, the system automatically creates a serial interface for each timeslot bundle formed on a controller T1 interface.

Interface specifications

Table 95 Interface specifications

Item	Specification
Connector	RJ-45
Number of connectors	1
Interface standard	<ul style="list-style-type: none"> • G.703/T1 102 • G.704 • AT&T TR 54016 • AT&T TR 62411 • ANSI T1.403
Interface rate	1.544 Mbps
Cable type	8T1 conversion cable
Operating mode	CT1, ISDN PRI (only supported by the MIM-8T1) FT1 (only supported by the MIM-8T1-F)
Supported service	<ul style="list-style-type: none"> • Backup • Terminal access service • ISDN PRI (only supported by the MIM-8T1)

Interface LEDs

Figure 66 MIM-8T1 panel

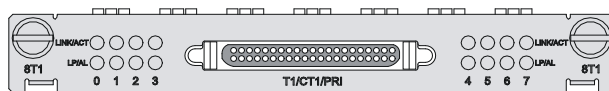

Figure 67 MIM-8T1-F panel

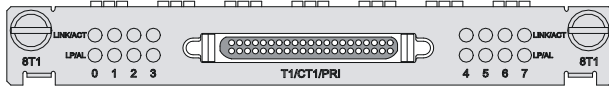

Table 96 LED description

LED	Description
LINK/ACT	<ul style="list-style-type: none"> On means carrier signal has been received. Flashing means data is being received or/and transmitted. Off means no carrier signal has been received.
LP/AL	<ul style="list-style-type: none"> On means the interface is in a loopback. Flashing means an AIS, LFA, or RAI alarm signal is present. Off means no loopback or alarm is present.
<p>Note: AIS = Alarm indication signal; LFA = loss of frame alignment; RAI = Remote alarm indication</p>	

Interface cables and connection methods

For more information about T1 interface cables and connection methods, see "[T1 interface](#)."

E3/T3 interface module

- MIM-1CE3
- MIM-1CT3

MIM-1CE3

Introduction

The 1-port channelized E3 interface module (MIM-1CE3) provides the following features:

- Transmits and receives and handles one channel of E3 fast traffic, and provides access to E3 traffic when operating in E3 mode
- Provides low-speed accessing service at $n \times 64$ kbps when operating in CE3 mode. n is smaller than or equal to 128.

NOTE:

E3 represents the tertiary group rate of E system in the TDM system: 34.368Mbps. An E3 channel can be channelized into 16 E1 lines through the demultiplexing processes of E23 and E12. Each E1 line supports both E1 and CE1 modes. E23 is used to indicate either E2-to-E3 multiplex or E3-to-E2 demultiplex, and E12 to indicate E1-to-E2 multiplex or E2-to-E1 demultiplex. "E23" and "E12" discussed here represent the demultiplex process.

Interface specifications

Table 97 Interface specifications

Item	Specification
Connector	SMB
Number of connectors	2

Item	Specification
Interface standard	G.703, G.704, G.751
Interface rate	34.368 Mbps
Interface cable type	E3/T3 cable (75-ohm coaxial cable)
Operating mode	E3 CE3
Supported service	E3 leased line

Interface LEDs

Figure 68 MIM-1CE3 panel



Table 98 LED description

LED	Description
LINK	<ul style="list-style-type: none"> Off means the link is not set up. On means the link has been set up.
ACT	<ul style="list-style-type: none"> Off means no data is being transmitted or received; Flashing means data is being received or/and transmitted.

Interface cables and connection methods

For more information about E3 interface cables and connection methods, see "[E3/T3 interface](#)."

MIM-1CT3

Introduction

The 1-port channelized T3 interface module (MIM-1CT3) provides the following features:

- Transmits and receives and handles one channel of T3 fast traffic, and provides access to T3 traffic when operating in T3 mode
- Provides low-speed accessing service at $n \times 64$ kbps or 56 kbps when operating in CT3 mode. n is smaller than or equal to 128.

NOTE:

T3 represents the tertiary group rate (44.736 Mbps) of T system in the TDM system. A T3 channel can be channelized into 28 T1 lines through the demultiplexing processes of T23 and T12. Each T1 line also supports the operating modes of CT1. T23 is used to indicate either T2-to-T3 multiplex or T3-to-T2 demultiplex, and T12 to indicate T1-to-T2 multiplex or T2-to-T1 demultiplex. "T23" and "T12" discussed here represent the demultiplex process.

Interface specifications

Table 99 Interface specifications

Item	Specification
Connector	SMB

Item	Specification
Number of connectors	2
Interface standard	<ul style="list-style-type: none"> • G.703 • G.704 • G.752 • AT&T TR 54014 • AT&T TR 62415 • ANSI T1.107
Interface rate	44.736 Mbps
Interface cable type	E3/T3 cable (75-ohm coaxial cable)
Operating mode	T3 CT3
Supported service	T3 leased line

Interface LEDs

Figure 69 MIM-1CT3 panel



Table 100 LED description

LED	Description
LINK/ACT	<ul style="list-style-type: none"> • On means the carrier signal has been received. • Off means no carrier signal has been received. • Flashing means data is being transmitted or/and received.
LP/AL	<ul style="list-style-type: none"> • On means the interface is in a loopback. • Flashing means an AIS, LFA, or RAI alarm signal is present. • Off means no loopback or alarm is present.
<p>Note: AIS = Alarm indication signal; LFA = loss of frame alignment; RAI = Remote alarm indication</p>	

Interface cables and connection methods

For more information about T3 interface cables and connection methods, see "[E3/T3 interface](#)."

xDSL interface module

- MIM-1SHL-4W

MIM-1SHL-4W

Introduction

The 1-port dual-pair G.SHDSL interface module (MIM-1SHL-4W) uses trellis coded pulse amplitude modulation (TCPAM) coding and provides symmetric rates up to 4.624 Mbps. The transmission rate of the interface can automatically adapt to line distances and conditions.

Compared with ADSL, G.SHDSL allows longer transmission distance and has a wider application scope. It is an alternative to E1/T1 line for high-speed data service access. However, because TCPAM uses the band starting from 0 Hz for data transmission, G.SHDSL cannot share the same line with POTS or ISDN.

The MIM-1SHL-4W provides the following features:

- Manual G.SHDSL line activation/deactivation and easy-to-use fault location tools.
- G.991.2 interface standard and auto-sensing.
- Allows you to set the dual-pair G.SHDSL interface to operate in dual-pair or single-pair mode.

Interface specifications

Table 101 Interface specifications

Item	Specification
Connector	RJ-11
Number of connectors	1
Interface standard	ITU-T G991.2 ITU-T G994.1 handshaking
Interface rate	In single-pair mode, supports the sending and receiving independent symmetric rates in the range from 192 kbps to 2312 kbps in steps of 8 kbps. In dual-pair mode, supports the sending/receiving independent symmetric rates in the range from 384 kbps to 4624 kbps in steps of 16 kbps.
Interface cable	Tailor-made 4-wire telephone cable
Supported services	G.SHDSL access over ordinary telephone lines

Interface LEDs

Figure 70 MIM-1SHL-4W panel

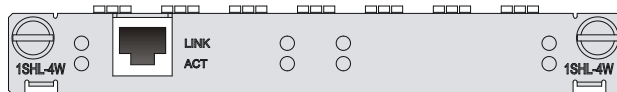

Table 102 LED description

LED	Description
LINK	<ul style="list-style-type: none"> • Off means no link is present. • On means a link is present.
ACT	<ul style="list-style-type: none"> • Off means no data is being transmitted or received. • Flashing means data is being received or transmitted.

Interface cables and connection methods

For more information about G.SHDSL interface cables and connection methods, see "[G.SHDSL interface](#)."

Serial interface module

- MIM-2SAE

- MIM-4SAE
- MIM-8SAE
- MIM-8ASE
- MIM-16ASE

MIM-2SAE/MIM-4SAE/MIM-8SAE

Introduction

The 2/4/8-port enhanced high-speed synchronous/asynchronous serial interface module (MIM-2SAE/MIM-4SAE/MIM-8SAE) functions the same as SA modules except that the SAE modules support additional protocols, for example, RS449, X.21, and RS530.

Interface specifications

Table 103 Interface specifications

Item	Specification		
	Synchronous		Asynchronous
Connector	D28		
Number of connectors	2 (MIM-2SAE) 4 (MIM-4SAE) 8 (MIM-8SAE)		
Interface standard and operating mode	V.24	V.35, RS449, X.21, RS530	RS232
	DTE, DCE	DTE, DCE	
Minimum baud rate (bps)	1200	1200	300
Maximum baud rate (bps)	64 k	2.048 M	115.2
Cable	<ul style="list-style-type: none"> • V.24 (RS232) DTE cable • V.24 (RS232) DCE cable • V.35 DTE cable • V.35 DCE cable • X.21 DTE cable • X.21 DCE cable • RS449 DTE cable • RS449 DCE cable • RS530 DTE cable • RS530 DCE cable 		
Supported service	<ul style="list-style-type: none"> • DDN leased line • Terminal access service 		<ul style="list-style-type: none"> • Dialup through modems • Backup • Asynchronous leased line • Dumb terminal access

Interface LEDs

Figure 71 MIM-2SAE panel

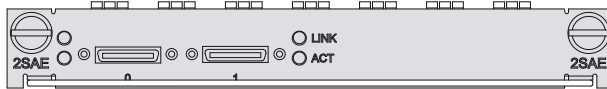

Figure 72 MIM-4SAE panel

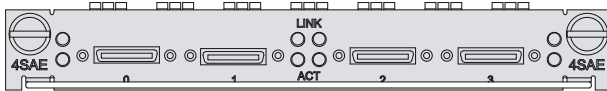
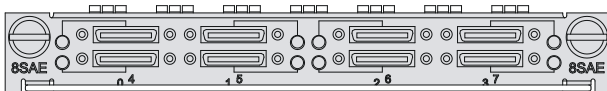

Table 104 LED description

LED	Description
LINK	<ul style="list-style-type: none"> Off means no link is present; On means a link is present.
ACT	<ul style="list-style-type: none"> Off means no data is being transmitted or received; Flashing means data is being received or/and transmitted.

Figure 73 MIM-8SAE panel



On the MIM-8SAE module, each link has one LED. On means the link is connected. Flashing means data is being transmitted or received.

Interface cables and connection methods

For more information about synchronous/asynchronous serial port cables, see "[Synchronous/asynchronous serial ports.](#)"

MIM-8ASE/MIM-16ASE

Introduction

The 8/16-port enhanced asynchronous serial interface module (MIM-8ASE/MIM-16ASE) transmits, receives, and handles asynchronous serial interface data streams. The ASE modules use RJ-45 connectors and AUX cables.

Interface specifications

Table 105 Interface specifications

Item	Specification	
	MIM-8ASE module	MIM-16ASE module
Connector	RJ-45	
Number of connectors	8 (MIM-8ASE) 16 (MIM-16ASE)	
Interface standard and operating mode	RS232	

Item	Specification	
	MIM-8ASE module	MIM-16ASE module
Cable	<ul style="list-style-type: none"> AUX cable Ethernet straight-through cable MIM-8ASE/MIM-16ASE dumb terminal cable 	
Minimum baud rate (bps)	300	
Maximum baud rate (bps)	115.2 k	
Supported services	<ul style="list-style-type: none"> Dialup through Modem Backup Terminal access service Asynchronous leased line service 	

Interface LEDs

Figure 74 MIM-8ASE panel

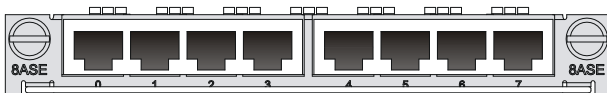
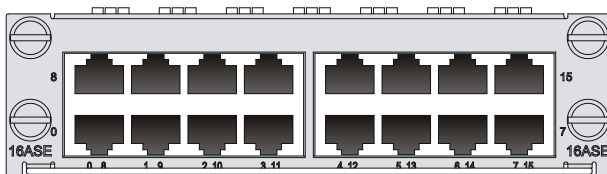

Figure 75 MIM-16ASE panel



Each channel on the MIM-8ASE/MIM-16ASE has only one LED.

Table 106 LED description

LED	Description
LINK	<ul style="list-style-type: none"> Off means no link is present; On means a link is present.
ACTIVE	<ul style="list-style-type: none"> Off means no data is being transmitted or received. Flashing means data is being transmitted or received.

Interface cables and connection methods

For more information about asynchronous serial port cables, see "[Asynchronous serial ports.](#)"

Voice interface module

- MIM-2FXO
- MIM-4FXS
- MIM-4FXO
- MIM-16FXS
- MIM-4E&M
- MIM-4BSV

- MIM-2VE1
- MIM-2VT1
- MIM-1VE1
- MIM-1VT1

MIM-16FXS

Introduction

The 16-port loop trunk interface module (MIM-16FXS) provides access for 16 channels of analog voice signals over data communication networks. The module provides 16 FXS interfaces. FXS interfaces are analog subscriber line interfaces that provide analog telephone and fax access and also can connect AT0 loop trunks of exchanges.

Interface specifications

Table 107 Interface specifications

Item	Specification
Connector type	RJ-11
Number of connectors	16 (FXS interfaces)
Interface standard	Subscriber circuit interface (FXS) compliant with ITU Q.512. Over-current and over-voltage protection compliant with ITU K.20.
Cable type	Telephone cable with ferrite core
Dial-up mode	DTMF, compliant with GB3378 (Pulse dial-up is not available.)
Bandwidth	300 to 3400 Hz

Interface LEDs

Figure 76 MIM-16FXS panel

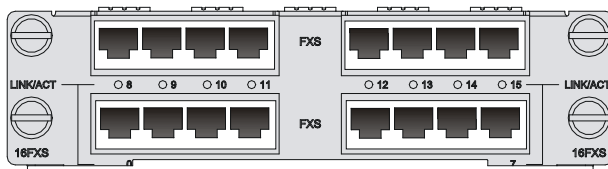

Table 108 LED description

LED	Description
LINK/ACT	<ul style="list-style-type: none"> • Off means no link is present. • Steady green means a link is present and a call connection is being established. • Flashing yellow means a link is present and there is a call activity.

Interface cables and connection methods

For more information about FXS interface cables and connection methods, see "[ADSL/BS/FXS/FXO/AM/FCM interface.](#)"

MIM-4BSV

Introduction

The 4-port ISDN BRI S/T voice interface module (MIM-4BSV) processes ISDN voice traffic. In the upstream direction, it can be connected to user interfaces on an ISDN switch to receive and decompress, and compress and transmit ISDN BRI digital voice traffic. In the downstream direction, the module can be connected to TE devices to allow their voice traffic to be forwarded through a WAN interface on the router to the Internet to implement VoIP. The interfaces on the MIM-4BSV module are ITU-T I.430-compliant. They use pseudo-ternary coding, providing 192 Kbps rate, and allow a maximum transmission distance of 1 km (0.6 miles) in point-to-point mode. The MIM-4BSV provides the following features.

- The BSV interfaces support user and network modes for connecting an ISDN network and a TE device, respectively.
- When a BSV interface operates in network mode, the digital voice traffic received on the BSV interface is compressed and forwarded through the CPU on the MPU to a WAN interface. The IP voice traffic received on a WAN interface is forwarded through the CPU on the MPU to the MIM-4BSV. The MIM-4BSV decompresses and sends the voice traffic to the TE device.
- When a BSV interface operates in user mode, the digital voice traffic received from the B channels on the BSV interface is decompressed and forwarded through the CPU on the MPU to a local FXS or FXO analog voice interface. The voice signals received on the local FXS or FXO analog voice interface are processed by VoIP and forwarded through the CPU on the MPU to the MIM-4BSV module. The MIM-4BSV module decompresses and sends the traffic out of the BSV interface to the connected ISDN switch.
- Working in conjunction with the FXS or FXO analog voice interface modules, the MIM-4BSV provides flexibility in voice call routing.
- The signaling on the ISDN BRI D channel is processed separately on CPU.
- The BSV interfaces can be connected to ISDN phones to supply power to the phones.
- The MIM-4BSV is dedicated to voice applications.

Interface specifications

Table 109 Interface specifications

Item	Specification
Connector	RJ-45
Number of connectors	4
Interface standard	ITU-T I.430, Q.921, Q.931
Interface rate	192 Kbps
Cable	ISDN S interface cable
Supported service	Voice access over ISDN S interface cable

Interface LEDs

Figure 77 MIM-4BSV panel

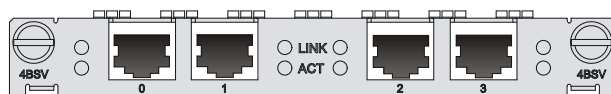

Table 110 LED description

LED	Description
LINK	<ul style="list-style-type: none"> Off means no link is present. On means a link is present.
ACT	<ul style="list-style-type: none"> Slowly flashing means data is being transmitted or received on B1 channel. Fast flashing means data is being transmitted or received on B2 channel. Steady On means data is being transmitted or received on both B1 and B2 channels. Steady Off means no data is being transmitted or received.

Interface cables and connection methods

For more information about BSV interface cables and connection methods, see "[BSV/BSE interface](#)."

MIM-2FXO and MIM-4FXS/MIM-4FXO

Introduction

The MIM-2FXO and MIM-4FXS/MIM-4FXO modules transfer voice signals over data communication networks.

- The 4-port voice subscriber circuit interface module (MIM-4FXS) can provide access for and process 2/4 channels of ordinary analog phone, fax, or AT0 loop trunk of telephone exchange.
- The 2/4-port voice AT0 analog trunk interface module (MIM-2FXO/MIM-4FXO) can provide access for and process 2/4 channels of common user lines of telephone exchange.

Interface specifications

Table 111 Interface specifications

Item	Specification
Connector	RJ-45
Number of connectors	<ul style="list-style-type: none"> 2 (MIM-2FXO module) 4 (MIM-4FXS/MIM-4FXO module)
Cable	<ul style="list-style-type: none"> Telephone cable with ferrite core E&M trunk (for E&M module, which should be made by users depending on the actual needs at the site.)
Interface standard	<ul style="list-style-type: none"> ITU Q.512-compliant subscriber circuit interface (MIM-4FXS) ITU Q.552-compliant loop trunk interface (MIM-2FXO/MIM-4FXO) ITU K.20-compliant overcurrent and overvoltage protection
Dial-up mode	DTMF (Dual-Tone Multi-Frequency) but not pulse dial-up
Bandwidth	300 Hz to 3400 Hz

Interface LEDs

Figure 78 MIM-2FXO panel

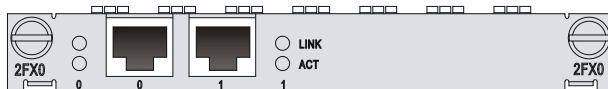

Figure 79 MIM-4FXS panel

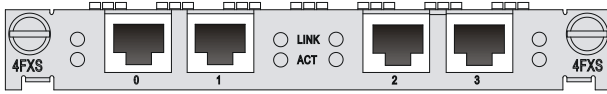

Figure 80 MIM-4FXO panel

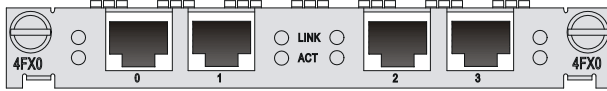

Table 112 LED description

LED	Description
LINK	<ul style="list-style-type: none"> Off means no link is present; On means a link is present.
ACT	<ul style="list-style-type: none"> Off means the channel is idle. On means there is call activity.

Interface cables and connection methods

For more information about FXS/FXO interface cables and connection methods, see "[ADSL/BS/FXS/FXO/AM/FCM interface.](#)"

MIM-4E&M

Introduction

The 4-port voice E&M analog trunk interface module (MIM-4E&M) provides access for 4 channels of E&M analog trunks to transfer voice signals over data communication networks.

Interface specifications

Table 113 Interface specifications

Item	Specification
Connector	RJ-45
Number of connectors	<ul style="list-style-type: none"> 4
Cable	<ul style="list-style-type: none"> Telephone cable with ferrite core E&M trunk (for E&M module, which should be made by users depending on the actual needs at the site.)
Interface standard	<ul style="list-style-type: none"> G.712-compliant E&M trunk interface (MIM-4E&M), E&M interface (supporting Bell type I, II, III, V, and support 2-wire and 4-wire). ITU K.20-compliant overcurrent and overvoltage protection
Dial-up mode	DTMF (Dual-Tone Multi-Frequency) but not pulse dial-up
Bandwidth	300 Hz to 3400 Hz

Interface LEDs

Figure 81 MIM-4E&M panel

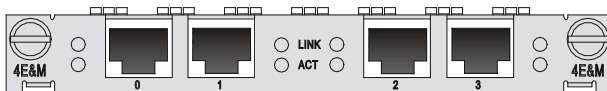

Table 114 LED description

LED	Description
LINK	<ul style="list-style-type: none"> Off means no link is present; On means a link is present.
ACT	<ul style="list-style-type: none"> Off means the channel is idle. On means there is call activity.

Interface cables and connection methods

For more information about E&M interface cables and connection methods, see "[E&M interface](#)."

MIM-1VE1

Introduction

The 1-port E1 voice interface module (MIM-1VE1) handles dense voice signals in a VoIP system. It provides a CE1/PRI/R2 port that allows access of a maximum of 30 channels of voice signals.

Interface specifications

Table 115 Interface specifications

Item	Specification
Connector	D15
Number of connectors	1
Operating mode	CE1 ISDN PRI R2
Interface rate	2.048 Mbps
Cable	E1 120-ohm balanced twisted pair cable 75-ohm-to-120-ohm adapter (with BNC connector)
Supported service	<ul style="list-style-type: none"> R2 signaling DSS1 signaling IP Fax General VoIP features in Comware

Interface LEDs

Figure 82 MIM-1VE1 panel

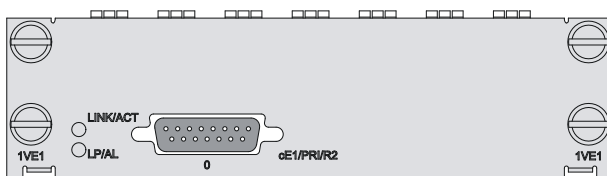

Table 116 LED description

LED	Description
LINK/ACT	<ul style="list-style-type: none"> On means carrier signal has been received. Flashing means data is being received or/and transmitted. Off means no carrier signal has been received.

LED	Description
LP/AL	<ul style="list-style-type: none"> On means the interface is in a loopback. Flashing means an AIS, LFA, or RAI alarm signal is present. Off means no loopback or alarm is present.
<p>Note: AIS = Alarm indication signal; LFA = loss of frame alignment; RAI = Remote alarm indication</p>	

Interface cables and connection methods

For more information about E1 interface cables, see "[E1 interface](#)."

MIM-1VT1

Introduction

The 1-port T1 voice interface module (MIM-1VT1) handles dense voice signals in the VoIP system. The MIM-1VT1 module is structured in the form of board plus VCPM module plus VPM strip. It provides a CT1/PRI port that allows access of 24 channels of voice signals.

Interface specifications

Table 117 Interface specifications

Item	Specification
Connector	RJ-45
Number of connector	1
Interface standard	<ul style="list-style-type: none"> G.703/T1.102 G.704 AT&T TR 54016 AT&T TR 62411 ANSI T1.403
Interface rate	1.544 Mbps
Cable type	T1 cable (100-ohm standard shielded cable)
Operating mode	CT1 ISDN PRI
Services	Backup Terminal access ISDN

Interface LEDs

Figure 83 MIM-1VT1 panel

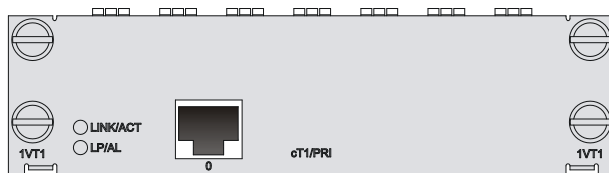

Table 118 LED description

LED	Description
LINK/ACT	<ul style="list-style-type: none"> On means carrier signal has been received. Flashing means data is being received or/and transmitted. Off means no carrier signal has been received.
LP/AL	<ul style="list-style-type: none"> On means the interface is in a loopback. Flashing means an AIS, LFA, or RAI alarm signal is present. Off means no loopback or alarm is present.
Note: AIS = Alarm indication signal; LFA = loss of frame alignment; RAI = Remote alarm indication	

Interface cables and connection methods

For more information about T1 interface cables and connection methods, see "[T1 interface](#)."

MIM-2VE1

Introduction

The 2-port E1 voice interface module (MIM-2VE1) handles dense voice signals in a VoIP system. It provides two CE1/PRI/R2 ports that allow access of a maximum of 60 channels of voice signals.

Interface specifications

Table 119 Interface specifications

Item	Specification
Connector	D15
Number of connectors	2
Operating mode	CE1 ISDN PRI R2
Interface rate	2.048 Mbps
Cable	E1 120-ohm balanced twisted pair cable 75ohm-to-120ohm adapter
Supported service	<ul style="list-style-type: none"> R2 signaling DSS1 signaling IP Fax General VoIP features in Comware

Interface LEDs

Figure 84 MIM-2VE1 panel

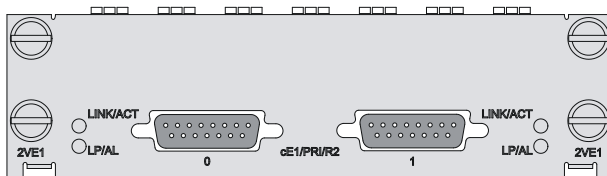

Table 120 LED description

LED	Description
LINK/ACT	<ul style="list-style-type: none">• On means carrier signal has been received.• Flashing means data is being received or/and transmitted.• Off means no carrier signal has been received.
LP/AL	<ul style="list-style-type: none">• On means the interface is in a loopback.• Flashing means an AIS, LFA, or RAI alarm signal is present.• Off means no loopback or alarm is present.
Note: AIS = Alarm indication signal; LFA = loss of frame alignment; RAI = Remote alarm indication	

Interface cables and connection methods

For more information about E1 interface cables, see "[E1 interface](#)."

MIM-2VT1

Introduction

The 2-port T1 voice interface module (MIM-2VT1) handles dense voice signals in a VoIP system. It provides two CT1/PRI ports that allow access of a maximum of 48 channels of voice signals.

Interface specifications

Table 121 Interface specifications

Item	Specification
Connector	RJ-45
Number of connector	2
Interface standard	<ul style="list-style-type: none">• G.703/T1.102• G.704• AT&T TR 54016• AT&T TR 62411• ANSI T1.403
Interface rate	1.544 Mbps
Cable type	T1 cable (100-ohm standard shielded cable)
Operating mode	<ul style="list-style-type: none">• CT1• ISDN PRI
Services	<ul style="list-style-type: none">• Backup• Terminal access• ISDN

Interface LEDs

Figure 85 MIM-2VT1 panel

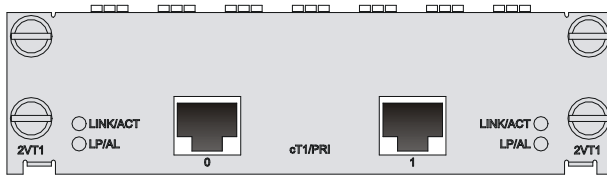

Table 122 LED description

LED	Description
LINK/ACT	<ul style="list-style-type: none">On means carrier signal has been received.Flashing means data is being received or/and transmitted.Off means no carrier signal has been received.
LP/AL	<ul style="list-style-type: none">On means the interface is in a loopback.Flashing means an AIS, LFA, or RAI alarm signal is present.Off means no loopback or alarm is present.
Note: AIS = Alarm indication signal; LFA = loss of frame alignment; RAI = Remote alarm indication	

Interface cables and connection methods

For more information about T1 interface cables and connection methods, see "[T1 interface](#)."

HMIM

A wide range of optional HMIMs are available for the MSR series routers. The HMIMs provide multiple types of interfaces such as the synchronous/asynchronous serial interface, Ethernet interface, E1/T1, ISDN BRI/PRI, audio interface, and Layer 2 switching interface.

Ethernet interface switching module

- HMIM-8GSW
- HMIM-24GSW
- HMIM-24GSW-PoE
- HMIM-8GSWF

HMIM-8GSW/HMIM-24GSW/HMIM-24GSW-PoE

Introduction

The 8/24/24-port 1000M Layer 2 Ethernet interface module (HMIM-8GSW/HMIM-24GSW/HMIM-24GSW-PoE) is suitable for a small enterprise network to act as a switching & routing device. It can be connected to PCs and network devices of the enterprise. The HMIM-24GSW-PoE supports power transmission to remote devices over Ethernet cables.

Interface specifications

Table 123 Interface specifications

Item	Specification
Connector	RJ-45
Interface standard	MDI/MDIX
Number of connectors	<ul style="list-style-type: none"> • HMIM-8GSW: 8 • HMIM-24GSW/ HMIM-24GSW-PoE: 24
Transmission distance	100 m (328.08 ft) over category-5 twisted pair cables (both crossover and straight-through)
Operating mode	10/100/1000 Mbps autosensing, full/half duplex

Interface LEDs

Each GE interface has one green LED.

Figure 86 HMIM-8GSW panel

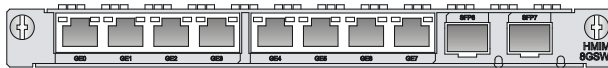

Figure 87 HMIM-24GSW panel

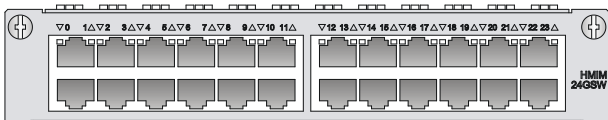

Figure 88 HMIM-24GSW-PoE panel

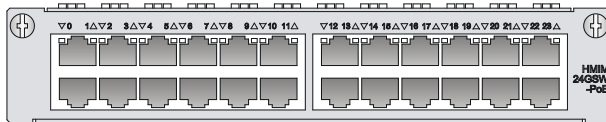

Table 124 LED description

LED	Description
Off	No link is present.
Steady green	A 1000 Mbps link is present.
Flashing green	The interface is sending or receiving data at 1000 Mbps.
Steady yellow	A 10/100 Mbps link is present.
Flashing yellow	The interface is sending or receiving data at 10/100 Mbps.

Interface cables and connection methods

For more information about the Ethernet interface cables and connection methods, see "[Ethernet interface.](#)"

HMIM-8GSWF

Introduction

The 8-port (four fiber ports and four combo interfaces) 100M/1000M Layer 2/Layer 3 Ethernet interface module (HMIM-8GSWF) is suitable for a small enterprise network to act as a switching & routing device. It can be directly connected to PCs and network devices of the enterprise.

Interface specifications

Table 125 Interface specifications

Item	Specification
Number of connectors	8
Connector type	SFP/LC
Interface standard	802.3/802.3u/802.3ab
Operating mode	100/1000 Mbps, full duplex

Interface LEDs

Figure 89 HMIM-8GSWF panel



Table 126 LED description

LED	Description
LINK	<ul style="list-style-type: none"> Off means no link is present. On means a link is present.

LED	Description
ACT	<ul style="list-style-type: none"> Off means no data is being transmitted or received on the interface. Flashing means data is being transmitted and/or received.

Fiber ports, optical fibers, and the connection methods

For more information about fiber ports, optical fibers, and the connection methods, see "[Fiber port.](#)"

Ethernet interface module

- HMIM-2GEE
- HMIM-4GEE
- HMIM-8GEE
- HMIM-2GEF
- HMIM-4GEF
- HMIM-8GEF

HMIM-2GEE/HMIM-4GEE/HMIM-8GEE

Introduction

The HMIM-GEE module completes the communication between a router and a LAN. It includes the following types:

- **HMIM-2GEE**—2-port 10Base-T/100Base-TX/1000Base-T Ethernet electrical interface module
- **HMIM-4GEE**—4-port 10Base-T/100Base-TX/1000Base-T Ethernet electrical interface module
- **HMIM-8GEE**—8-port 10Base-T/100Base-TX/1000Base-T Ethernet electrical interface module

Interface specifications

Table 127 Interface specifications

Item	HMIM-2GEE	HMIM-4GEE	HMIM-8GEE
Connector type	RJ-45		
Number of connectors	2	4	8
Interface type	MDI/MDIX		
Interface standard	802.3, 802.3u, and 802.3ab		
Transmission distance	100 m (328.08 ft) over category-5 twisted pair cables (both crossover and straight-through)		
Operating mode	10/100/1000 Mbps autosensing, full duplex/half-duplex		

Interface LEDs

Figure 90 HMIM-2GEE panel



Figure 91 HMIM-4GEE panel



Figure 92 HMIM-8GEE panel



Table 128 LED description

LED	Description
LINK	Off means no link is present. On means a link is present.
ACT	Off means no data is being transmitted or received on the interface. Flashing means data is being transmitted and/or received.

Interface cables and connection methods

For more information about the Ethernet interface cables and connection methods, see "[Ethernet interface.](#)"

HMIM-2GEF/HMIM-4GEF/HMIM-8GEF

Introduction

The HMIM-GEF module completes the communication between a router and a LAN. It includes the following types:

- **HMIM-2GEF**—2-port 10Base-T/100Base-TX/1000Base-T Ethernet optical interface module
- **HMIM-4GEF**—4-port 10Base-T/100Base-TX/1000Base-T Ethernet optical interface module
- **HMIM-8GEF**—8-port 10Base-T/100Base-TX/1000Base-T Ethernet optical interface module

Interface specifications

Table 129 Interface specifications

Item	HMIM-2GEF	HMIM-4GEF	HMIM-8GEF
Connector type	SFP/LC		
Number of connectors	2	4	8
Interface standard	802.3, 802.3u, and 802.3ab		
Operating mode	1000 Mbps, full duplex		

Interface LEDs

Figure 93 HMIM-2GEF panel



Figure 94 HMIM-4GEF panel

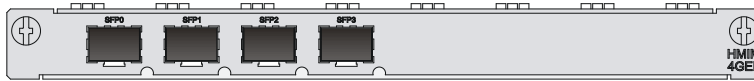

Figure 95 HMIM-8GEF panel

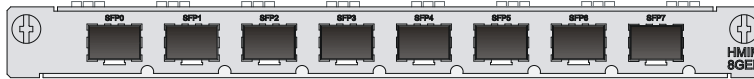

Table 130 LED description

LED	Description
LINK	Off means no link is present. On means a link is present.
ACT	Off means no data is being transmitted or received on the interface. Flashing means data is being transmitted and/or received.

Interface cables and connection methods

For more information about the Ethernet interface cables and connection methods, see "[Ethernet interface](#)."

POS (SDH/SONET) interface module

- HMIM-1POS

HMIM-1POS

Introduction

The 1-port SDH/SONET interface module (HMIM-1POS) provides interface rates up to 155.52 Mbps (STM-1/OC-3).

The HMIM-1POS uses protocols such as PPP, Frame Relay, and HDLC at the data link layer and IP at the network layer. It allows direct transmission of packets over SONET/SDH.

Interface specifications

Table 131 Interface specifications

Item	Specification
Interface standard	SONET OC-3/SDH STM-1
Number of connectors	1
Connector type	SFP/LC
Interface rate	155.52 Mbps

Interface LEDs

Figure 96 HMIM-1POS front panel

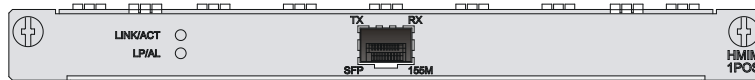

Table 132 LED description

LED	Description
LINK/ACT	<ul style="list-style-type: none">On means carrier signal has been received.Flashing means data is being received or/and transmitted.Off means no carrier signal has been received.
LP/AL	<ul style="list-style-type: none">On means the interface is in a loopback.Off means no loopback or alarm is present.Flashing means an alarm indication signal (AIS), loss of frame alignment (LFA) signal, or remote alarm indication (RAI) signal is present.

Fiber ports, optical fibers, and the connection methods

For more information about fiber ports, optical fibers, and the connection methods, see "[Fiber port.](#)"

CPOS (SDH/SONET) interface module

- HMIM-1CPOS

HMIM-1CPOS

Introduction

The 1-port channelized SDH/SONET interface module (HMIM-1CPOS) provides one STM-1/OC3-compliant multi-channel interface. It provides an interface rate of up to 155.52 Mbps.

You can set E1 or T1 working mode for the HMIM-1CPOS interface module.

The HMIM-1CPOS interface module is installed in an HMIM slot to receive and transmit data on STM-1 channelized POS interface and to communicate with the CPU through the PCI interface.

The HMIM-1CPOS provides the following features:

- Multiple transceiver modules.
- Clear channel (unframed) E1 or T1
- Fractional (framed) E1 or T1
- A maximum of 256×64 kbps logical channels

Interface specifications

Table 133 Interface specifications

Item	Specification
Interface standard	SONET OC-3/SDH STM-1
Number of interfaces	1

Item	Specification
Connector type	SFP/LC
Interface rate	155.52 Mbps

! IMPORTANT:

If the interface receives signal over a long-distance optical fiber, make sure the transmission distance is longer than 25 km (15.53 miles). If the transmission distance is shorter than 25 km (15.53 miles), use an optical attenuator to reduce the optical power.

Interface LEDs

Figure 97 HMIM-1CPOS front panel

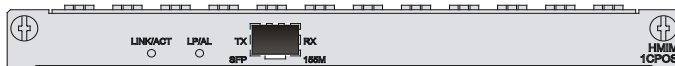

Table 134 LED description

LED	Description
LINK/ACT	<ul style="list-style-type: none"> On: Carrier signal has been received. Off: No carrier signal has been received. Flashing: Data is being received and/or transmitted.
LP/AL	<ul style="list-style-type: none"> On: The interface is in a loopback. Off: No loopback or alarm is present. Flashing: An alarm indication signal (AIS), loss of frame alignment (LFA) signal, or remote alarm indication (RAI) signal is present.

Fiber ports, optical fibers, and the connection methods

For more information about fiber ports, optical fibers, and the connection methods, see "[Fiber port.](#)"

Setting the working mode

1. Insert the HMIM-1CPOS interface module in an HMIM slot.
2. Power on the device.
3. Enter system view.

```
<Sysname> system-view
```
4. Set the working mode of the HMIM-1CPOS interface module.
 - o Set the working mode to E1.

```
[Sysname] card-mode slot 4 e1
```
 - o Set the working mode to T1.

```
[Sysname] card-mode slot 4 t1
```

E1/T1 interface module

- HMIM-2E1
- HMIM-4E1
- HMIM-4E1-F
- HMIM-8E1
- HMIM-2T1

- HMIM-4T1-F
- HMIM-8E1T1
- HMIM-8E1T1-F

HMIM-2E1/HMIM-4E1/HMIM-4E1-F

Introduction

The 2-port channelized E1/PRI interface module (HMIM-2E1) and 4-port channelized E1/PRI interface module (HMIM-4E1) transmit, receive, and process E1 data traffic. In addition, you can use these modules for CE1 access and ISDN PRI.

The HMIM-4E1-F module is different from the HMIM-4E1 module in the following ways:

- The FE1 operating mode supported by the E1-F module allows only one $n \times 64$ Kbps bundle to be formed on each interface, where the value range of n is 1 to 31. However, an E1 module allows arbitrary grouping of 31 channels and multiple bundles.
- The E1-F modules do not support the PRI mode.

Interface specifications

Table 135 Interface specifications

Item	HMIM-2E1/HMIM-2E1-F	HMIM-4E1/HMIM-4E1-F
Connector type	DB15	DB25
Number of connectors	2	1
Interface standard	G.703 and G.704	
Interface rate	2.048 Mbps	
Cable type	<ul style="list-style-type: none"> • E1 75-ohm unbalanced coaxial cable • E1 120-ohm balanced twisted pair cable • 120-ohm 4E1 conversion cable (only supported by the HMIM-4E1/HMIM-4E1-F) • 75-ohm 4E1 conversion cable (only supported by the HMIM-4E1/HMIM-4E1-F) • Coaxial connector, network interface connector, and 75-ohm to 120-ohm adapter (with BNC connector) 	
Operating mode	<ul style="list-style-type: none"> • E1, CE1, ISDN PRI (only supported by the HMIM-2E1/HMIM-4E1) • FE1 (only supported by the HMIM-4E1-F) 	
Supported services	<ul style="list-style-type: none"> • Backup • Terminal access service • ISDN PRI (only supported by the HMIM-2E1/HMIM-4E1) 	

Interface LEDs

Figure 98 HMIM-2E1 panel

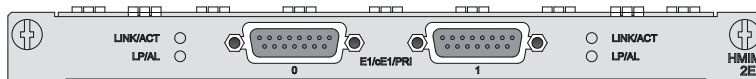

Figure 99 HMIM-4E1 panel

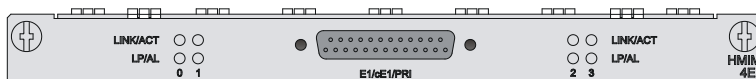

Figure 100 HMIM-4E1-F panel



Table 136 LED description

LED	Description
LINK/ACT	<ul style="list-style-type: none"> On means carrier signal has been received. Flashing means data is being received or/and transmitted. Off means no carrier signal has been received.
LP/AL	<ul style="list-style-type: none"> On means the interface is in a loopback. Off means no loopback or alarm is present. Flashing means an alarm indication signal (AIS), loss of frame alignment (LFA) signal, or remote alarm indication (RAI) signal is present.
LINK	<ul style="list-style-type: none"> On means carrier signal has been received. Off means no carrier signal has been received.
ACTIVE	<ul style="list-style-type: none"> Off means no data is being transmitted or received. Flashing means data is being received or/and transmitted.

Interface cables and connection methods

For more information about E1 interface cables, see ["E1 interface."](#)

HMIM-8E1

Introduction

The 8-port channelized E1/PRI interface module (HMIM-8E1) transmits, receives, and processes eight channels of E1 data traffic. In addition, you can use the module for CE1 access and ISDN PRI.

NOTE:

For an HMIM-8E1 module, the system automatically creates a serial interface for each timeslot bundle formed on a controller E1 interface.

Interface specifications

Table 137 Interface specifications

Item	Description
Connector type	D68
Number of connectors	1
Interface standard	G.703
Interface rate	2.048 Mbps
Cable type	75-ohm 8E1 conversion cable
Cable characteristic impedance	75 ohm
Operating mode	E1, CE1, ISDN PRI

Item	Description
Supported services	<ul style="list-style-type: none"> • Backup • Terminal access service • ISDN PRI

Interface LEDs

Figure 101 HMIM-8E1 (75-ohm) panel

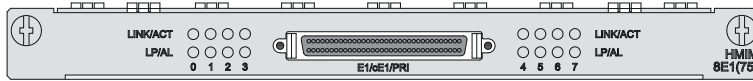

Figure 102 LED description

LED	Description
LINK/ACT	<ul style="list-style-type: none"> • On means carrier signal has been received. • Flashing means data is being received or/and transmitted. • Off means no carrier signal has been received.
LP/AL	<ul style="list-style-type: none"> • On means the interface is in a loopback. • Off means no loopback or alarm is present. • Flashing means an alarm indication signal (AIS), loss of frame alignment (LFA) signal, or remote alarm indication (RAI) signal is present.

Interface cables and connection methods

For more information about E1 interface cables, see "[E1 interface](#)."

HMIM-2T1/HMIM-4T1-F

Introduction

The 2-port channelized CT1/PRI interface module (HMIM-2T1) transmits, receives, and handles T1 data streams. In addition, you can use the module for CT1 access and ISDN PRI.

The 4-port fractional T1 interface module (HMIM-4T1-F) differs from the HMIM-CT1 module in the following ways:

- FT1 operating mode supported by T1-F modules allows only one bundle. The time slots can only be bundled into one $n \times 64$ Kbps/56 Kbps channel, where the value range of n is 1 to 24. However, a CT1 module allows of arbitrary grouping of the 24 channels.
- T1-F does not support the PRI mode.

NOTE:

For a T1 module, the system automatically creates a serial interface for each timeslot bundle formed on a controller T1 interface.

Interface specifications

Table 138 Interface specifications

Item	Specification
Connector type	RJ45
Number of connectors	<ul style="list-style-type: none"> • 2 (HMIM-2T1) • 4 (HMIM-4T1-F)

Item	Specification
Interface standard	<ul style="list-style-type: none"> G.703/T1 102 G.704 AT & T TR 54016 AT & T TR 62411 ANSI T1.403
Interface rate	1.544 Mbps
cable type	T1 cable (100-ohm shielding network cable)
Operating mode	CT1, ISDN PRI (only supported by the HMIM-2T1) FT1 (only supported by the HMIM-4T1-F)
Supported services	<ul style="list-style-type: none"> Backup Terminal access service ISDN PRI (only supported by the HMIM-2T1)

Interface LEDs

Figure 103 HMIM-2T1 panel

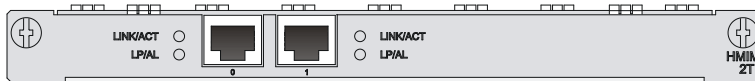

Figure 104 HMIM-4T1-F panel

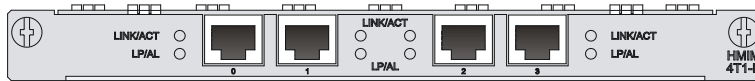

Table 139 LED description

LEDs	Description
LINK/ACT	<ul style="list-style-type: none"> On means the carrier signal has been received. Off means no carrier signal has been received. Flashing means data is being transmitted or/and received.
LP/AL	<ul style="list-style-type: none"> On means the interface is in a loopback. Off means no loopback or alarm is present. Flashing means an alarm indication signal (AIS), loss of frame alignment (LFA) signal, or remote alarm indication (RAI) signal is present.

Interface cables and connection methods

For more information about T1 interface cables and connection methods, see "[T1 interface](#)."

HMIM-8E1T1/HMIM-8E1T1-F

Introduction

- HMIM-8E1T1 module
The 8-port channelized E1/CE1/T1/CT1/PRI interface module transmits, receives, and handles T1 data streams. In addition, you can use the module for CT1 access and ISDN PRI. The module allows arbitrary grouping of 31 channels.
- HMIM-8E1T1-F module

The 8-port fractional T1 interface module allows only one bundle. The time slots can only be bundled into one $n \times 64$ Kbps/56 Kbps channel, where the value range of n is 1 to 31. The module does not support the PRI mode.

- HMIM-8E1T1(-F) jumper settings

You can set an interface to a 75-ohm E1 interface, 100-ohm T1 interface, or 120-ohm E1 interface at the CLI or by using the jumper connection method. By default, an interface is a 75-ohm E1 interface.

- For a 75-ohm E1 interface, the jumper is connected to pins 1 and 2, pins 7 and 8, and pins 11 and 12.
- For a 100-ohm T1 or 120-ohm E1 interface, the jumper is connected to pins 1 to 3, pins 5 to 7, pins 9 and 10, and pins 11 to 13.

Figure 105 Jumper settings

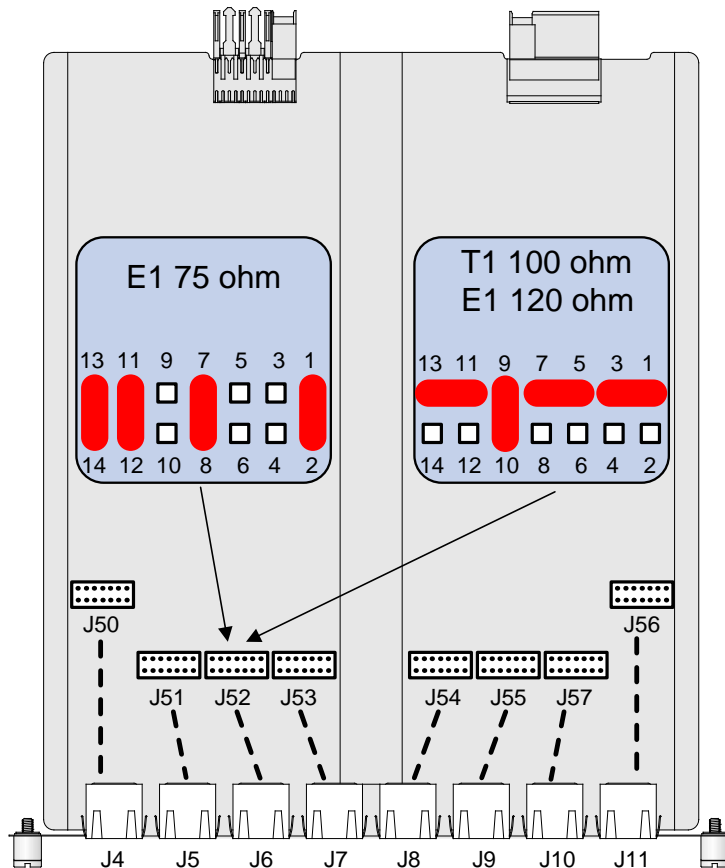

NOTE:

- An interface corresponds to a jumper connector. Pin settings for the jumper connectors are the same.
- Each interface comes with four jumper caps.
- All interfaces must operate in the same mode simultaneously.

Interface specifications

Table 140 Interface specifications

Item	Specification
Connector type	RJ-45
Number of connectors	8
Interface standard	<ul style="list-style-type: none"> • G.703/G.704 • T1 102 • AT&T TR 54016 • AT&T TR 62411 • ANSI T1.403
Interface rate	<ul style="list-style-type: none"> • 1.544 Mbps • 2.048 Mbps
Supported cable	<ul style="list-style-type: none"> • E1 75-ohm unbalanced twisted pair cable • E1 120-ohm balanced twisted pair cable, 2 m (6.56 ft), 15 m (49.21 ft), or 30 m (98.43 ft) • T1 cable (100-ohm shielding network cable) • Coaxial connector, network connector, 75-to-120-ohm adapter (with BNC connector)
Operating mode	<ul style="list-style-type: none"> • E1/T1/CE1T1/ISDN PRI (only supported by the HMIM-8E1T1) • FE1T1 (only supported by the HMIM-8E1T1-F)
Supported services	<ul style="list-style-type: none"> • Backup • Terminal access service • ISDN PRI (only supported by the HMIM-8E1T1)

Interface LEDs

Figure 106 HMIM-8E1T1 panel

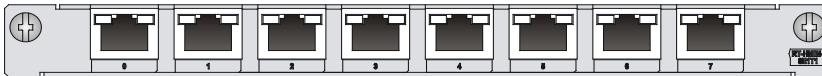

Figure 107 HMIM-8E1T1-F panel



Table 141 LED description

LED	Description
LINK/ACT	<ul style="list-style-type: none"> • On means the carrier signal has been received. • Off means no carrier signal has been received. • Flashing means data is being transmitted or/and received.
LP/AL	<ul style="list-style-type: none"> • On means the interface is in a loopback. • Off means no loopback or alarm is present. • Flashing means an AIS, LFA signal, or RAI signal is present.

Interface cables and connection methods

For more information about E1 interface cables, see "[E1 interface](#)."

For more information about T1 interface cables, see "[T1 interface](#)."

E3/T3 interface module

- HMIM-1CE3
- HMIM-1CT3
- HMIM-1E3T3

HMIM-1CE3

Introduction

The 1-port channelized E3 interface module (HMIM-1CE3) provides the following features:

- Transmits, receives and handles one channel of E3 fast traffic, and provides access for E3 traffic when operating in E3 mode.
- Provides low-speed accessing service at $n \times 64$ kbps when operating in CE3 mode. n is smaller than or equal to 128.

NOTE:

E3 represents the tertiary group rate (34.368 Mbps) of E system in the TDM system. An E3 channel can be channelized into 16 E1 lines through the demultiplexing processes of E23 and E12. Each E1 line supports both the E1 and CE1 modes. E23 is used to indicate either E2-to-E3 multiplex or E3-to-E2 demultiplex, and E12 to indicate E1-to-E2 multiplex or E2-to-E1 demultiplex. "E23" and "E12" discussed here represent the demultiplex process.

Interface specifications

Table 142 Interface specifications

Item	Specification
Connector type	SMB
Number of connectors	2
Interface standard	G.703, G.704, and G.751
Interface rate	34.368 Mbps
Cable type	E3/T3 cable (75-ohm coaxial cable)
Operating mode	E3 CE3
Supported services	E3 leased line

Interface LEDs

Figure 108 HMIM-1CE3 panel



Table 143 LED description

LED	Description
LINK/ACT	<ul style="list-style-type: none"> On means carrier signal has been received. Flashing means data is being received or/and transmitted. Off means no carrier signal has been received.
LP/AL	<ul style="list-style-type: none"> On means the interface is in a loopback. Off means no loopback or alarm is present. Flashing means an alarm indication signal (AIS), loss of frame alignment (LFA) signal, or remote alarm indication (RAI) signal is present.

Interface cables and connection methods

For more information about E3 interface cables and connection methods, see "[E3/T3 interface](#)."

HMIM-1CT3

Introduction

The 1-port channelized T3 interface module HMIM-1CT3 provides the following features:

- Transmits, receives, and handle one channel of T3 fast traffic, and provides access for T3 traffic when operating in T3 mode.
- Provides low-speed accessing service at $n \times 64$ kbps/56 kbp when operating in CT3 mode. n is smaller than or equal to 128,

NOTE:

T3 represents the tertiary group rate (44.736 Mbps) of T system in the TDM system. A T3 channel can be channelized into 28 T1 lines through the demultiplexing processes of T23 and T12. Each T1 line supports the operating modes of CT1. T23 is used to indicate either T2-to-T3 multiplex or T3-to-T2 demultiplex, and T12 to indicate T1-to-T2 multiplex or T2-to-T1 demultiplex. "T23" and "T12" discussed here represent the demultiplex process.

Interface specifications

Table 144 Interface specifications

Item	Specification
Connector type	SMB
Number of connectors	2
Interface standard	G.703 G.704 G.752 AT & T TR 54014 AT & T TR 62415 ANSI T1.107
Interface rate	44.736 Mbps
Cable type	E3/T3 cable (75-ohm coaxial cable)
Operating mode	T3 CT3

Item	Specification
Supported services	T3 leased line

Interface LEDs

Figure 109 HMIM-1CT3 panel

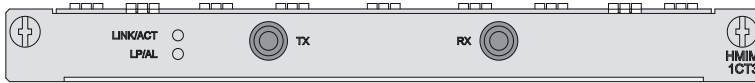

Table 145 LED description

LED	Description
LINK/ACT	<ul style="list-style-type: none"> On means carrier signal has been received. Flashing means data is being received or/and transmitted. Off means no carrier signal has been received.
LP/AL	<ul style="list-style-type: none"> On means the interface is in a loopback. Off means no loopback or alarm is present. Flashing means an alarm indication signal (AIS), loss of frame alignment (LFA) signal, or remote alarm indication (RAI) signal is present.

Interface cables and connection methods

For more information about T3 interface cables and connection methods, see "[E3/T3 interface](#)."

HMIM-1E3T3

Introduction

HMIM-1E3T3 refers to the 1-port unchannelized E3/T3 interface module. The interface on the module operates in T3 mode. It can transmit, receive, and handle one channel of T3 traffic, and provide access for T3 data flows.

NOTE:

T3 represents the tertiary group rate (44.736 Mbps) of T system in the TDM system.

Interface specifications

Table 146 Interface specifications

Item	Specification
Connector type	SMB
Number of connectors	2
Interface standard	<ul style="list-style-type: none"> G.703 G.704 G.751
Interface rate	44.736 Mbps
Cable type	E3/T3 cable (75-ohm coaxial cable)
Operating mode	T3

Item	Specification
Supported services	T3 leased line

Interface LEDs

Figure 110 HMIM-1E3T3 panel



Table 147 LED description

LED	Description
LINK/ACT	<ul style="list-style-type: none"> On: Carrier signal has been received. Flashing: Data is being received or/and transmitted. Off: No carrier signal has been received.
LP/AL	<ul style="list-style-type: none"> On: The interface is in a loopback. Off: No loopback or alarm is present. Flashing: An alarm indication signal (AIS), loss of frame alignment (LFA) signal, or remote alarm indication (RAI) alarm is present.

Interface cables and connection methods

For information about T3 interface cables and connection methods, see "[E3/T3 interface](#)."

Serial interface module

- HMIM-4SAE
- HMIM-8SAE
- HMIM-16ASE

HMIM-4SAE/HMIM-8SAE

Introduction

The 4-port SAE module (HMIM-4SAE) and 8-port SAE module (HMIM-8SAE) are enhanced high-speed synchronous/asynchronous serial interface modules. The SAE modules are the same as the SA modules except that the SAE modules support additional protocols, for example, RS449, X.21, and RS530.

Interface specifications

Table 148 Interface specifications

Item	Synchronous		Asynchronous
Connector type	D28		
Number of connectors	4 (HMIM-4SAE) 8 (HMIM-8SAE)		
Interface standard and operating mode	V.24	V.35, RS449, X.21, and RS530	
	DTE and DCE	DTE and DCE	
			RS232

Item	Synchronous		Asynchronous
Minimum baud rate (bps)	1200	1200	300
Maximum baud rate (bps)	64 k	2.048 M	115.2
cable type	V.24 (RS232) DTE cable V.24 (RS232) DCE cable V.35 DTE cable V.35 DCE cable X.21 DTE cable X.21 DCE cable RS449 DTE cable RS449 DCE cable RS530 DTE cable RS530 DCE cable		
Supported services	<ul style="list-style-type: none"> DDN leased line Terminal access service 		<ul style="list-style-type: none"> Dialup through modems Backup Asynchronous leased line Dumb terminal access

Interface LEDs

Figure 111 HMIM-4SAE panel

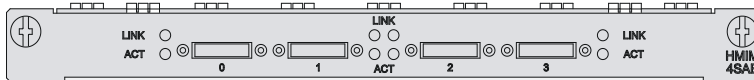

Table 149 LED description

LED	Description
LINK	<ul style="list-style-type: none"> Off means no link is present. On means a link is present.
ACT	<ul style="list-style-type: none"> Off means no data is being transmitted or received. Flashing means data is being received or/and transmitted.

Figure 112 HMIM-8SAE panel

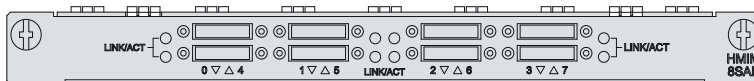

Table 150 LED description

LED	Description
LINK/ACT	<ul style="list-style-type: none"> On means a link is present. Off means no data is being transmitted or received. Flashing means data is being received or/and transmitted.

Interface cables and connection methods

For more information about synchronous/asynchronous serial port cables, see "[Synchronous/asynchronous serial ports.](#)"

HMIM-16ASE

Introduction

The 16-port ASE module (HMIM-16ASE) is an enhanced asynchronous serial interface module that transmits, receives, and handles asynchronous serial interface data streams. It uses RJ-45 connectors and AUX cables.

Interface specifications

Table 151 Interface specifications

Item	Specification
Connector type	RJ45
Number of connectors	16
Interface standard and operating mode	RS232
cable type	<ul style="list-style-type: none">• AUX cable• Standard (straight-through) Ethernet cable• HMIM-16ASE dumb terminal cable
Minimum baud rate (bps)	300
Maximum baud rate (bps)	115.2 k
Supported services	<ul style="list-style-type: none">• Dialup through Modem• Backup• Terminal access service• Asynchronous leased line service

Interface LEDs

Figure 113 HMIM-16ASE panel

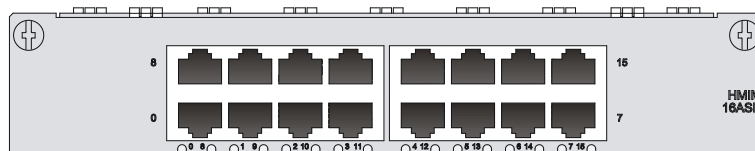

Table 152 LED description

LED	Description
N/A	<ul style="list-style-type: none">• On means a link is present.• Off means no link is present.• Flashing means data is being received or/and transmitted.

Interface cables and the connection methods

For more information about asynchronous serial port cables, see "[Asynchronous serial ports.](#)"

Voice interface module

- HMIM-16FXS
- HMIM-2VE1
- HMIM-1VE1
- HMIM-2VT1
- HMIM-1VT1
- HMIM-4FXS
- HMIM-4FXO
- HMIM-4E&M

HMIM-16FXS

Introduction

The 16-port loop trunk interface module HMMIM-16FXS provides access for and handles 16 channels of analog voice signals over data communication networks. The module provides 16 FXS interfaces.

FXS interfaces are analog subscriber line interfaces that provide analog telephone and fax access and also can connect AT0 loop trunks of exchanges.

Interface specifications

Table 153 Interface specifications

Item	Specification
Connector type	RJ-11
Number of connectors	16 (FXS interfaces)
Interface standard	<ul style="list-style-type: none"> • ITU Q.512-compliant subscriber circuit interface (FXS) • ITU K.20-compliant over-current and over-voltage protection
Cable type	Telephone cable with ferrite core
Dial-up mode	DTMF, compliant with GB3378 (Pulse dial-up is not available.)
Bandwidth	300 to 3400 Hz

Interface LEDs

Figure 114 HMIM-16FXS front panel

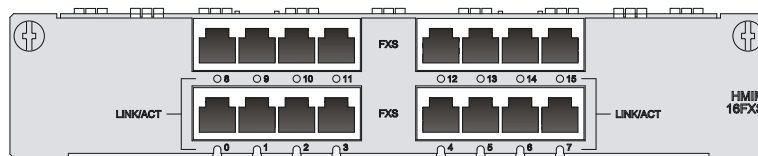

Table 154 LED descriptions

LED	Description
LINK/ACT	<ul style="list-style-type: none"> • Steady green: A link is present and a call connection is being established. • Off: No link is present. • Flashing: A link is present and there is a call activity.

Interface cables and connection methods

For more information about FXS interface cables and connection methods, see "[ADSL/BS/FXS/FXO/AM/FCM interface.](#)"

HMIM-2VE1

Introduction

The 2-port E1 voice interface module (HMIM-2VE1) handles dense voice signals in VoIP system. It provides two CE1/PRI/R2 ports that allow access of a maximum of 60 channels of voice signals.

Interface specifications

Table 155 Interface specifications

Item	Specification
Connector	D15
Number of connectors	2
Operating mode	<ul style="list-style-type: none">• CE1• ISDN PRI• R2
Interface rate	2.048 Mbps
Cable type	<ul style="list-style-type: none">• E1 75-ohm unbalanced coaxial cable• E1 120-ohm balanced twisted pair cable• Coaxial connector, network interface connector, and 75-to-120-ohm adapter (with BNC connector)
Supported service	<ul style="list-style-type: none">• R2 signaling• DSS1 signaling• IP Fax• General VoIP features in Comware

Interface LEDs

Figure 115 HMIM-2VE1 panel

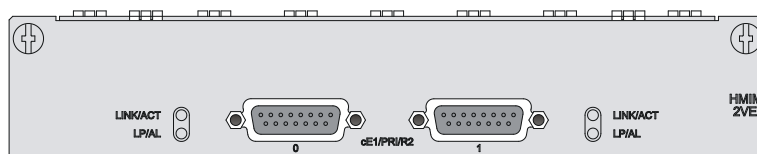

Table 156 LED description

LED	Description
LINK/ACT	<ul style="list-style-type: none">• On means carrier signal has been received.• Off means no carrier signal has been received.• Flashing means data is being received and/or transmitted.
LP/AL	<ul style="list-style-type: none">• On means the interface is in a loopback.• Off means no loopback or alarm is present.• Flashing means an alarm indication signal (AIS), loss of frame alignment (LFA) signal, or remote alarm indication (RAI) signal is present.

Interface cables and connection methods

For more information about E1 interface cables and connection methods, see "[E1 interface](#)."

HMIM-2VT1

Introduction

The 2-port T1 voice interface module HMIM-2VT1 handles dense voice signals in VoIP system. It provides two CT1/PRI ports that allow access of a maximum of 48 channels of voice signals.

Interface specifications

Table 157 Interface specifications

Item	Specification
Connector	RJ-45
Number of connector	2
Interface standard	<ul style="list-style-type: none">• G.703/T1.102• G.704• AT & T TR 54016• AT & T TR 62411• ANSI T1.403
Interface rate	1.544 Mbps
Cable type	T1 cable (100-ohm standard shielded cable)
Operating mode	<ul style="list-style-type: none">• CT1• ISDN PRI
Services	<ul style="list-style-type: none">• Backup• Terminal access• ISDN

Interface LEDs

Figure 116 HMIM-2VT1 panel

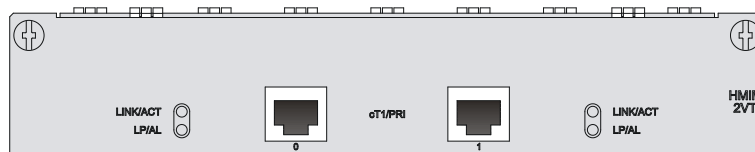

Table 158 LED description

LED	Description
LINK/ACT	<ul style="list-style-type: none">• On: Carrier signal has been received.• Off: No carrier signal has been received.• Flashing: Data is being received and/or transmitted.
LP/AL	<ul style="list-style-type: none">• On: The interface is in a loopback.• Off: No loopback or alarm is present.• Flashing: An alarm indication signal (AIS), loss of frame alignment (LFA) signal, or remote alarm indication (RAI) signal is present.

Interface cables and connection methods

For more information about T1 interface cables and connection methods, see "[T1 interface](#)."

HMIM-1VE1

Introduction

The 1-port E1 voice interface module (HMIM-1VE1) handles dense voice signals in VoIP system. It provides a CE1/PRI/R2 port that allows access of a maximum of 30 channels of voice signals.

Interface specifications

Table 159 Interface specifications

Item	Specification
Connector	D15
Number of connectors	1
Operating mode	<ul style="list-style-type: none">• CE1• ISDN PRI• R2
Interface rate	2.048 Mbps
Cable	<ul style="list-style-type: none">• E1 75-ohm unbalanced coaxial cable• E1 120-ohm balanced twisted pair cable• Coaxial connector, network interface connector, and 75ohm-to-120ohm adapter (with BNC connector)
Supported service	<ul style="list-style-type: none">• R2 signaling• DSS1 signaling• IP Fax• General VoIP features in Comware

Interface LEDs

Figure 117 HMIM-1VE1 panel

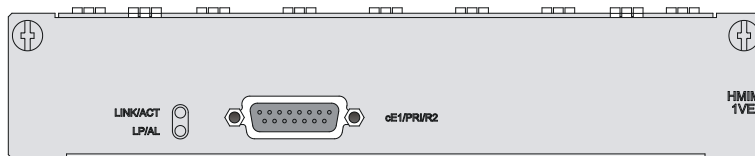

Table 160 LED description

LED	Description
LINK/ACT	<ul style="list-style-type: none">• On means carrier signal has been received.• Off means no carrier signal has been received.• Flashing means data is being received and/or transmitted.
LP/AL	<ul style="list-style-type: none">• On means the interface is in a loopback.• Off means no loopback or alarm is present.• Flashing means an alarm indication signal (AIS), loss of frame alignment (LFA) signal, or remote alarm indication (RAI) signal is present.

Interface cables and connection methods

For more information about E1 interface cables and connection methods, see "[E1 interface](#)."

HMIM-1VT1

Introduction

The 1-port T1 voice interface module (HMIM-1VT1) handles dense voice signals in VoIP system. It provides a CT1/PRI port that allows access of 24 channels of voice signals.

Interface specifications

Table 161 Interface specifications

Item	Specification
Connector	RJ-45
Number of connector	1
Interface standard	<ul style="list-style-type: none">• G.703/T1.102• G.704• AT & T TR 54016• AT & T TR 62411• ANSI T1.403
Interface rate	1.544 Mbps
Cable type	T1 cable (100-ohm standard shielded cable)
Operating mode	<ul style="list-style-type: none">• CT1• ISDN PRI
Services	<ul style="list-style-type: none">• Backup• Terminal access• ISDN

Interface LEDs

Figure 118 HMIM-1VT1 panel

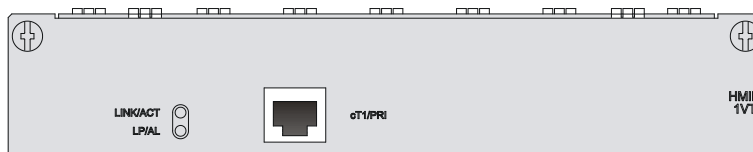

Table 162 LED description

LED	Description
LINK/ACT	<ul style="list-style-type: none">• On means carrier signal has been received.• Off means no carrier signal has been received.• Flashing means data is being received and/or transmitted.
LP/AL	<ul style="list-style-type: none">• On means the interface is in a loopback.• Off means no loopback or alarm is present.• Flashing means an alarm indication signal (AIS), loss of frame alignment (LFA) signal, or remote alarm indication (RAI) signal is present.

Interface cables and connection methods

For more information about T1 interface cables and connection methods, see "[T1 interface](#)."

HMIM-4FXS/HMIM-4FXO

Introduction

The 4-port voice subscriber circuit interface module (HMIM-4FXS) processes and transmits voice signals for 2/4 regular analog phones, faxes, or AT0 loop trunks of telephone exchanges over data communications networks.

The 4-port voice AT0 analog trunk interface module (HMIM-4FXO) processes and transmits voice signals for 2/4 loops of telephone exchanges over data communications networks.

Interface specifications

Table 163 Interface specifications

Item	Specification
Connector	RJ-45
Number of connectors	4
Cable	<ul style="list-style-type: none">Telephone cable with ferrite coreE&M trunk cable (only for E&M modules, made on site)
Interface standard	<ul style="list-style-type: none">ITU Q.512-compliant subscriber circuit interface (HMIM-4FXS)ITU Q.552-compliant loop trunk interface (HMIM-4FXO)ITU K.20-compliant over-current and over-voltage protection
Dial-up mode	DTMF, compliant with GB3378 (Pulse dial-up is not available.)
Bandwidth	300 Hz to 3400 Hz

Interface LEDs

Figure 119 HMIM-4FXS panel



Figure 120 HMIM-4FXO panel

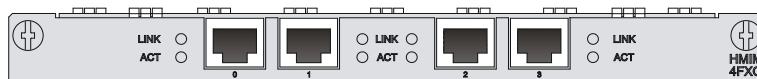

Table 164 LED description

LED	Description
LINK	<ul style="list-style-type: none">On means a link is present.Off means no link is present.
ACT	<ul style="list-style-type: none">On means there is call activity.Off means the channel is idle.

Interface cables and connection methods

For more information about FXS/FXO interface cables and connection methods, see "[ADSL/BS/FXS/FXO/AM/FCM interface](#)."

HMIM-4E&M

Introduction

The 4-port voice E&M analog trunk interface module (HMIM-4E&M) provides and transmits voice signals for 4 E&M analog trunks over data communications networks.

Interface specifications

Table 165 Interface specifications

Item	Specification
Connector	RJ-45
Number of connectors	4
Cable type	<ul style="list-style-type: none">Telephone cable with ferrite coreE&M trunk cable (only for E&M modules, made on site)
Interface standard	<ul style="list-style-type: none">G.712-compliant E&M trunk interface (HMIM-4E&M), E&M interface (supporting Bell type I, II, III, V, and support 2-wire and 4-wire)ITU K.20-compliant over-current and over-voltage protection
Dial-up mode	DTMF, compliant with GB3378 (Pulse dial-up is not available.)
Bandwidth	300 Hz to 3400 Hz

Interface LEDs

Figure 121 HMIM-4E&M panel

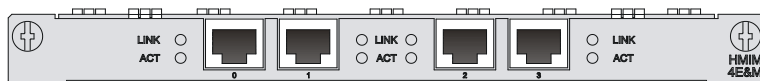

Table 166 LED description

LED	Description
LINK	<ul style="list-style-type: none">On means a link is present.Off means no link is present.
ACT	<ul style="list-style-type: none">On means there is call activity.Off means the channel is idle.

Interface cables and connection methods

For more information about E&M interface cables and connection methods, see "[E&M interface](#)."

FIC/DFIC

For modular MSR series routers, a wide range of optional FICs/DFICs are available, which provide multiple types of interfaces, such as synchronous/asynchronous serial interface, Ethernet interface, E1/T1, ISDN BRI/PRI, audio interface, and Layer 2 switching interface.

Among these interface modules, the Layer 2 switching interface modules (FIC-16FSW and DFIC-24FSW) each have a PoE-capable module. The module provides –48 VDC power to remote PDs (such as IP phone, WLAN AP, and network camera) through straight-through network cables if it is installed on a PoE router.

Ethernet switching module

- FIC-16FSW
- FIC-16FSW-PoE
- DFIC-24FSW
- DFIC-24FSW-PoE

FIC-16FSW/FIC-16FSW-PoE/DFIC-24FSW/DFIC-24FSW-PoE

Introduction

The 16/24-port 10/100 Mbps Ethernet Layer 2 switching MIM interface module (FIC-16FSW/FIC-16FSW-PoE/DFIC-24FSW/DFIC-24FSW-PoE) is used on the HPE MSR50 series router. A router installed with FIC-16FSW/DFIC-24FSW modules can act as a switching/routing integrated device on a small-sized enterprise network to connect PCs and network devices inside the network. The interfaces provided on the FIC-16FSW/FIC-16FSW-PoE and DFIC-24FSW/DFIC-24FSW-PoE are as follows:

The FIC-16FSW/FIC-16FSW-PoE provides the following features:

- 16 10/100 Mbps RJ-45 connector interfaces on the FIC-16FSW module
- One 10/100/1000 Mbps gigabit RJ-45 connector electrical interface on the FIC-16FSW module
- 1 SFP fiber interface (Fiber interfaces and gigabit electrical interfaces share the MAC layer) on the FIC-16FSW module

The DFIC-24FSW/DFIC-24FSW-PoE provides the following features:

- 2 SFP fiber interfaces (Fiber interfaces and gigabit electrical interfaces share the MAC layer) on the DMIM-24FSW module. By default, the electrical interfaces take effect.

Interface specifications

Table 167 Interface specifications

Item	FIC-16FSW/FIC-16FSW-PoE module	DFIC-24FSW/DFIC-24FSW-PoE module
Connector	RJ-45 SFP	
Interface type	MDI/MDIX	

Item	FIC-16FSW/FIC-16FSW-PoE module	DFIC-24FSW/DFIC-24FSW-PoE module
Number of connectors	16 × 100 Mbps RJ-45 connector 1 × 1000 Mbps RJ-45 connector 1 × SFP connector	24 × 100 Mbps RJ-45 connector 2 × 1000 Mbps RJ-45 connector 2 × SFP connector
Transmission distance	100 m (328.08 ft) over category-5 twisted pair cables (both crossover and straight-through)	
Operating mode	10/100 Mbps autosensing, full/half duplex	

Interface LEDs

On the FIC-16FSW/FIC-16FSW-PoE/DFIC-24FSW/DFIC-24FSW-PoE panel, each port has one green LED.

Figure 122 FIC-16FSW panel

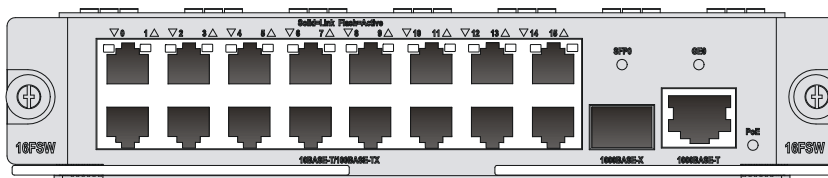

Figure 123 FIC-16FSW-PoE panel

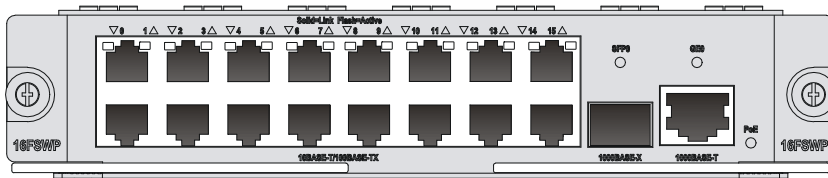

Figure 124 DFIC-24FSW panel

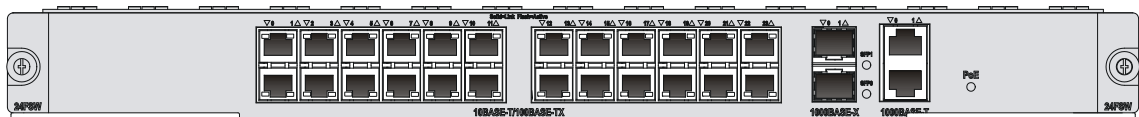

Figure 125 DFIC-24FSW-PoE panel

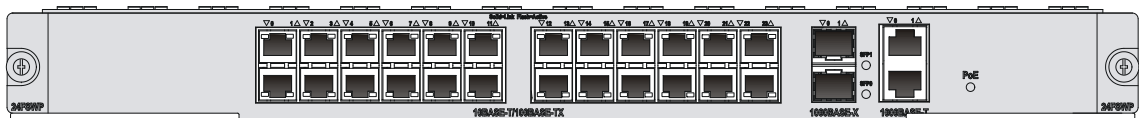

Table 168 LED description for the FIC-16FSW/FIC-16FSW-PoE/DFIC-24FSW/DFIC-24FSW-PoE FE ports

LED	Description
Steady green	A link is present, but no data is being transmitted and received.
Off	No link is present.
Flashing green	A link is present and data is being transmitted and received (ACT).

Table 169 LED description for the FIC-16FSW/FIC-16FSW-PoE/DFIC-24FSW/DFIC-24FSW-PoE GE ports

LED	Description
Off	No link is present.
Steady green	A 1000 Mbps link is present, but no data is being transmitted and received.
Flashing green	A 1000 Mbps link is present and data is being transmitted and received (ACT).
Steady yellow	A 100 Mbps link is present, but no data is being transmitted and received.
Flashing yellow	A 100 Mbps link is present and data is being transmitted and received (ACT).

Table 170 LED description for the FIC-16FSW/FIC-16FSW-PoE/DFIC-24FSW/DFIC-24FSW-PoE fiber ports

LED	Description
Off	No link is present.
Steady green	A link is present, but no data is being transmitted and received.
Flashing green	A link is present and data is being transmitted and received (ACT).
Steady yellow	Error prompt

NOTE:

The two GE ports on the DFIC-24FSW-PoE do not support PoE.

Interface cables and connection methods

For more information about the Ethernet interface cables and connection methods, see "[Ethernet interface](#)."

Ethernet interface module

- FIC-2FE
- FIC-4FE
- FIC-1GBE
- FIC-2GBE
- FIC-1GEF
- FIC-2GEF

FIC-2FE/FIC-4FE

Introduction

The 2-port and 4-port 10Base-T/100Base-TX fast Ethernet interface modules (FIC-2FE, and FIC-4FE) are typically used for communication between the router and LAN.

Interface specifications

Table 171 Interface specifications

Item	Specification	
	FIC-2FE	FIC-4FE

Item	Specification	
	FIC-2FE	FIC-4FE
Connector	RJ-45	
Number of connectors	2	4
Transmission distance	100 m (328.08 ft) over category-5 twisted pair cables (both crossover and straight-through)	
Operating mode	10/100 Mbps auto-sensing, full duplex/half-duplex	
Supported frame format	Ethernet_II Ethernet_SNAP	

Interface LEDs

Figure 126 FIC-2FE panel

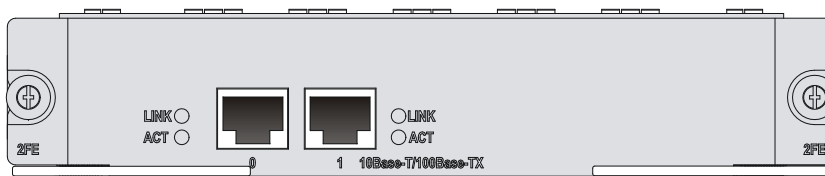

Figure 127 FIC-4FE panel

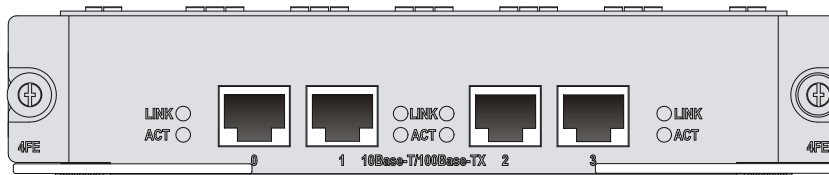

Table 172 LED description

LED	Description
LINK	<ul style="list-style-type: none"> Off means no link is present; On means a link is present.
ACT	<ul style="list-style-type: none"> Off means no data is being transmitted or received on the interface. Flashing means data is being transmitted and/or received.

Interface cables and connection methods

For more information about the Ethernet interface cables and connection methods, see "[Ethernet interface.](#)"

FIC-1GBE/FIC-2GBE

Introduction

The 1-port/2-port 10Base-T/100Base-TX/1000Base-T Ethernet electrical interface module (FIC-1GBE/FIC-2GBE) is used for router-to-LAN communication.

Interface specifications

Table 173 Interface specifications

Item	FIC-1GBE	FIC-2GBE
Connector	RJ-45	
Number of connectors	1	2
Interface type	MDI/MDIX	
Interface standard	802.3, 802.3u, and 802.3ab	
Transmission distance	100 m (328.08 ft) over category-5 twisted pair cables (both crossover and straight-through)	
Operating mode	10/100/1000 Mbps auto-sensing, half-duplex/full duplex	

Interface LEDs

Figure 128 FIC-1GBE panel

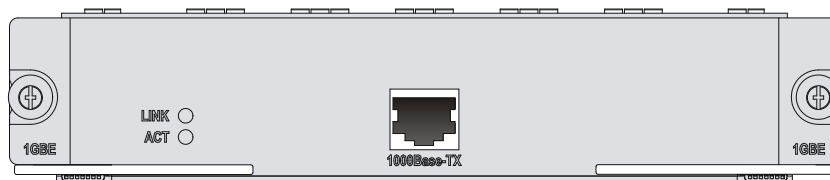

Figure 129 FIC-2GBE panel

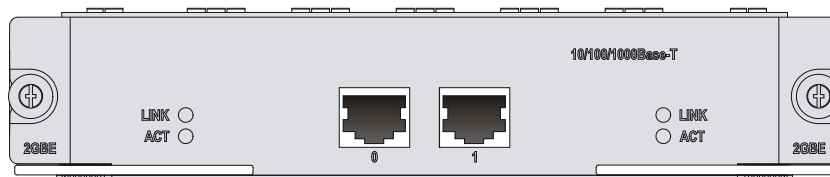

Table 174 LED description

LED	Description
LINK	<ul style="list-style-type: none"> Off means no link is present; On means a link is present.
ACT	<ul style="list-style-type: none"> Off means no data is being transmitted or received. Flashing means data is being transmitted and/or received.

Fiber ports, optical fibers, and the connection method

For more information about fiber ports, optical fibers, and the connection methods, see "[Fiber port.](#)"

FIC-1GEF/FIC-2GEF

Introduction

The 1-port/2-port 1000Base-SX/1000Base-LX GE optical interface module (The FIC-1GEF/FIC-2GEF) is used for router-to-LAN communication. The FIC-1GEF/FIC-2GEF supports multiple transceiver modules.

Interface specifications

Table 175 Interface specifications

Item	FIC-1GEF	FIC-2GEF
Connector	SFP	
Number of interfaces	1	2
Interface standard	802.3, 802.3u, 802.3ab	
Operating mode	1000 Mbps, full duplex	

Interface LEDs

Figure 130 FIC-1GEF panel

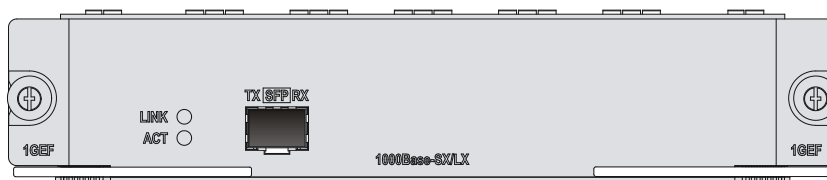

Figure 131 FIC-2GEF panel

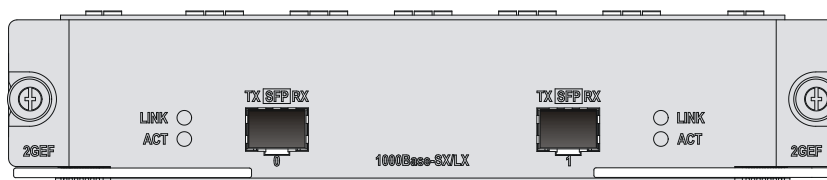

Table 176 LED description

LED	Description
LINK	<ul style="list-style-type: none"> Off means no link is present; On means a link is present.
ACT	<ul style="list-style-type: none"> Off means no data is being transmitted or received; Flashing means data is being received or/and transmitted.

Fiber ports, optical fibers, and the connection method

For more information about fiber ports, optical fibers, and the connection methods, see "[Fiber port.](#)"

ATM interface module

- FIC-IMA-4E1
- FIC-IMA-8E1
- FIC-1AE3
- FIC-1AT3
- FIC-1ATM-OC3

FIC-IMA-4E1/FIC-IMA-8E1

Introduction

The 4-port/8-port E1 ATM inverse multiplexing interface module (FIC-IMA-4E1/FIC-IMA-8E1) provides four/eight E1 interfaces that support the IMA (inverse multiplexing for ATM) technology.

IMA technology combines multiple low-speed links into a group to support a high-speed ATM cell stream. It distributes an ATM cell stream over multiple low-speed E1 links on cell by cell basis at the transmission end and reassembles the cells on the low-speed E1 links into the original stream at the far end. This technology provides a scalable and cost-effective solution, and is typically used in PDH networks to transport ATM cells.

Interface specifications

Table 177 Interface specifications

Item	Specification	
	FIC-IMA-4E1 (75-ohm)	FIC-IMA-8E1 (75-ohm)
Connector	D68	
Number of connectors	1	
Interface standard	ITU-G.703, ITU-G.704	
Interface rate	2.048 Mbps	
Cable type	75-ohm 4E1 conversion cable	75-ohm 8E1 conversion cable
Max transmission distance	500 m (1640.4 ft)	
Operating mode	ATM E1 independent link/IMA bundle mode	
Supported service	AAL5	
Protocol	PPPoA, PPPoEoA, IPoA, IPoEoA	
Transmission rate	CBR/VBR-rt/VBR-nrt/UBR	

Interface LEDs

Figure 132 75-ohm FIC-IMA-4E1 panel

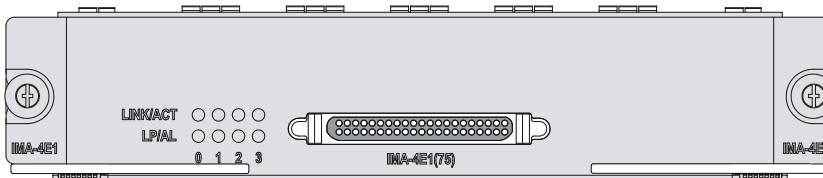

Figure 133 75-ohm FIC-IMA-8E1 panel

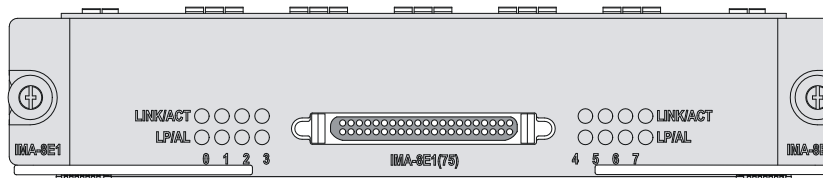

Table 178 LED description

LED	Description
LINK	<ul style="list-style-type: none"> Off means no link is present; On means a link is present.
ACT	<ul style="list-style-type: none"> Off means no data is being transmitted or received; Flashing means data is being received or transmitted.

Interface cables and connection methods

For more information about E1 interface cables, see "[E1 interface.](#)"

FIC-IMA-8T1

Introduction

The 8-port T1 ATM inverse multiplexing interface module (FIC-IMA-8T1) provides four/eight T1 interfaces that support the IMA technology.

Interface specifications

Table 179 Interface specifications

Item	Specification
Connector	D68
Number of connectors	1
Interface standard	ITU-G.703, ITU-G.704
Cable type	8T1 conversion cable (100-ohm straight-through shielded)
Max transmission distance	150 m (492.1 ft)
Operating mode	ATM T1 independent link/IMA bundle mode
Supported service	AAL5
Protocol	PPPoA, PPPoEoA, IPoA, IPoEoA
Transmission rate	CBR/VBR-rt/VBR-nrt/UBR

Interface LEDs

Figure 134 FIC-IMA-8T1 panel

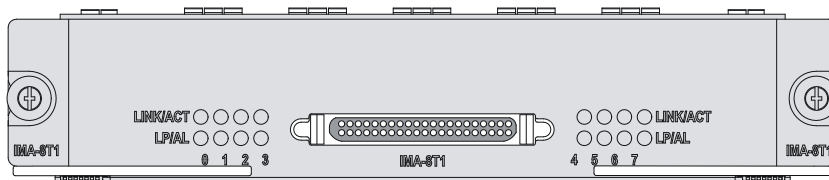

Table 180 LED description

LED	Description
LINK	<ul style="list-style-type: none"> Off means no link is present; On means a link is present.

LED	Description
ACT	<ul style="list-style-type: none"> Off means no data is being transmitted or received; Flashing means data is being received or transmitted.

Interface cables and connection methods

For more information about T1 interface cables and connection methods, see "[T1 interface](#)."

FIC-1AE3

Introduction

The 1-port 34 Mbps ATM-E3 interface module (FIC-1AE3) provides the following features:

- Two ATM cell mapping modes: ATM direct mapping (ADM) and physical layer convergence protocol (PLCP).
- Scrambling in data transmission.
- Line clock (when working as DTE interface) and internal clock (when working as DCE interface).
- Four types of test measures: local cell loopback, local loopback, remote payload loopback, and remote line loopback.

Interface specifications

Table 181 Interface specifications

Item	Specification
Connector	SMB
Number of connectors	2
Interface standard	G.703, G.751, G.832, G.823
Interface rate	34.368 Mbps
Interface cable	E3/T3 cable (75-ohm coaxial cables)
Supported services	ATM traffic CBR (constant bit rate), rt_VBR (variable bit rate-real time), nrt_VBR (variable bit rate-non real time), UBR (unspecified bit rate)

Interface LEDs

Figure 135 FIC-1AE3 panel

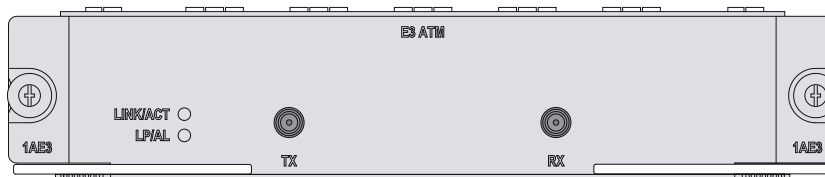

Table 182 LED description

LED	Description
LINK	<ul style="list-style-type: none"> Off means no link is present; On means a link is present.
ACT	<ul style="list-style-type: none"> Off means no data is being transmitted or received; Flashing means data is being received or/and transmitted.

Interface cables and connection methods

For more information about E3 interface cables and connection methods, see "[E3/T3 interface.](#)"

FIC-1AT3

Introduction

The 1-port 44 Mbps ATM-T3 interface module (FIC-1AT3) provides the following features:

- Two ATM cell mapping modes: ADM and PLCP.
- Scrambling in data transmission.
- Line clock (when working as DTE interface) and internal clock (when working as DCE interface).
- Four types of test measures: local cell loopback, local loopback, remote payload loopback, and remote line loopback.

Interface specifications

Table 183 Interface specifications

Item	Specification
Connector	SMB
Number of connectors	2
Interface standard	G.703, G.704, G.823
Interface rate	44.736 Mbps
Interface cable	E3/T3 cable (75-ohm coaxial cables)
Supported services	ATM Traffic CBR, rt_VBR, nrt_VBR, UBR

Interface LEDs

Figure 136 FIC-1AT3 panel

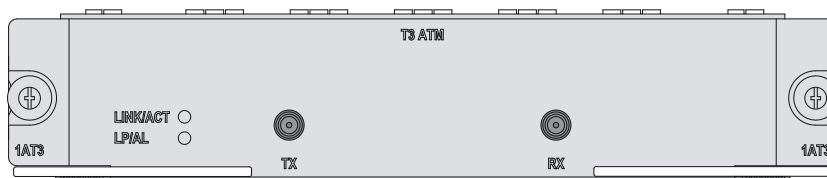

Table 184 LED description

LED	Description
LINK	<ul style="list-style-type: none">• Off means no link is present;• On means a link is present.
ACT	<ul style="list-style-type: none">• Off means no data is being transmitted or received;• Flashing means data is being received or/and transmitted.

Interface cables and connection methods

For more information about T3 interface cables and connection methods, see "[E3/T3 interface.](#)"

FIC-1ATM-OC3

Introduction

The 1-port ATM 155 Mbps optical interface module (FIC-1ATM-OC3) provides the following features:

- Two frame formats: SDH STM-1 and SONET OC-3.
- Scrambling in data transmission.
- Line clock (when working as DTE interface), and internal clock (when working as DCE interface)
- Three test measures: local cell loopback, local payload loopback and remote loopback.

Interface specifications

Table 185 Interface specifications

Item	Specification
Number of interfaces	1
Connector type	SFP/LC
Interface standard	SONET OC-3/SDH STM-1
Operating mode	1000 Mbps, full duplex

Interface LEDs

Figure 137 FIC-1ATM-OC3 panel

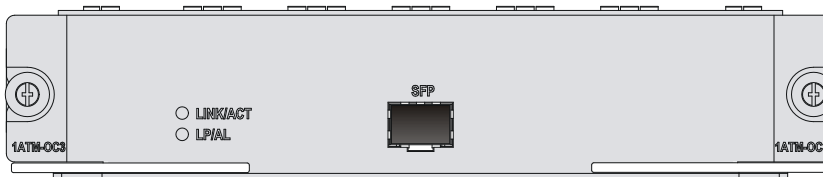

Table 186 LED description

LED	Description
LINK/ACT	<ul style="list-style-type: none">• On means carrier signal has been received.• Flashing means data is being received or/and transmitted.• Off means no carrier signal has been received.
LP/AL	<ul style="list-style-type: none">• On means the interface is in a loopback.• Flashing means an AIS, LFA, or RAI alarm signal is present.• Off means no loopback or alarm is present.
Note: LFA = Loss of frame alignment; AIS = Alarm indication signal; RAI = Remote alarm indication.	

Fiber ports, optical fibers, and the connection method

For more information about fiber ports, optical fibers, and the connection methods, see "[Fiber port.](#)"

POS (SDH/SONET) interface module

- FIC-1POS

FIC-1POS

Introduction

The 1-port SDH/SONET interface module (FIC-1POS) supports interface rates up to 155.52 Mbps (STM-1/OC-3).

The FIC-1POS uses the protocols such as PPP, Frame Relay and HDLC at the data link layer and IP at the network layer. It allows direct transmission of packets over SONET/SDH. The FIC-1POS supports multiple transceiver modules.

Interface specifications

Table 187 Interface specifications

Item	Specification
Connector	SFP/LC
Interface standard	SONET OC-3/SDH STM-1
Number of interfaces	1
Interface rate	155.52 Mbps

Interface LEDs

Figure 138 FIC-1POS panel

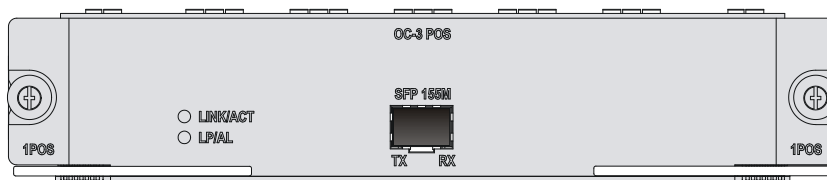

Table 188 LED description

LED	Description
LINK/ACT	<ul style="list-style-type: none">• On means carrier signal has been received.• Flashing means data is being received or/and transmitted.• Off means no carrier signal has been received.
LP/AL	<ul style="list-style-type: none">• On means the interface is in a loopback.• Flashing means an AIS, LFA, or RAI alarm signal is present.• Off means no loopback or alarm is present.
Note: AIS = Alarm indication signal; LFA = loss of frame alignment; RAI = Remote alarm indication	

Fiber ports, optical fibers, and the connection method

For more information about fiber ports, optical fibers, and the connection methods, see "[Fiber port.](#)"

CPOS (SDH/SONET) interface module

- FIC-1CPOS

FIC-1CPOS

Introduction

The 1-port channelized SDH/SONET interface module (FIC-1CPOS) provides one STM-1/OC3-compliant multi-channel interface and supports communication speeds up to 155.52 Mbps.

The FIC-1CPOS supports the switchover of E1 and T1 interface modes.

The FIC-1CPOS communicates with the CPU through the PCI interface to receive and transmit data on the STM-1 channelized POS interface.

The FIC-1CPOS provides the following features:

- Multiple transceiver modules.
- Clear channel (unframed) E1 or T1.
- Fractional (framed) E1 or T1.
- A maximum of 256 x 64 kbps logical channels.

Interface specifications

Table 189 Interface specifications

Item	Specification
Connector	SFP/LC
Number of Connectors	1
Interface standard	SONET OC-3/SDH STM-1
Interface rate	155.52 Mbps

Interface LEDs

Figure 139 FIC-1CPOS panel

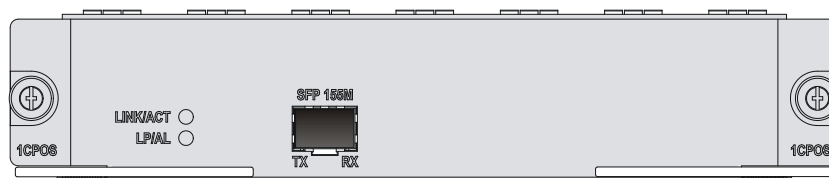

Table 190 LED description

LED	Description
LINK/ACT	<ul style="list-style-type: none">• Off means no link is present;• On means a link is present.• Flashing means data is being received or transmitted.
LP/AL	<ul style="list-style-type: none">• On means a loopback interface is configured.• Flashing means an alarm is present on the physical link.

LED	Description
Note: AIS = Alarm indication signal; LFA = loss of frame alignment; RAI = Remote alarm indication	

Fiber ports, optical fibers, and the connection method

For more information about fiber ports, optical fibers, and the connection methods, see "[Fiber port.](#)"

Interface mode switchover

To switch the FIC-1CPOS to operate in E1 and T1 interface modes at the command line interface (CLI):

1. Insert the FIC-1CPOS into the FIC slot of the router and then power on the router.
2. Use the **card-mode** command in system view to set the interface mode. The following shows the FIC-1CPOS module is inserted in slot 4 of the device.

Enter system view

```
<Sysname> system-view
```

Set the FIC-1CPOS to work in the E1 interface mode.

```
[Sysname] module-mode slot 4 e1
```

Set the FIC-1CPOS to work in the T1 interface mode.

```
[Sysname] module-mode slot 4 t1
```

E1/T1 interface module

- FIC-2E1
- FIC-4E1
- FIC-4E1-F
- FIC-8E1
- FIC-4T1-F

FIC-2E1/FIC-4E1 and FIC-4E1-F

Introduction

- FIC-2E1/FIC-4E1
The 2-/4-port channelized E1/PRI interface module (FIC-2E1/FIC-4E1) transmits, receives, and processes E1 data traffic. In addition, you can use the module for other purposes, such as CE1 access and the ISDN PRI function.
- FIC-4E1-F
The 2-/4-port fractional E1 interface module (FIC-4E1-F) differs from the FIC-2E1/FIC-4E1 in the following ways:
 - The FE1 operating mode supported by the E1-F modules allows only one $n \times 64$ kbps bundle to be formed on each interface, where $n = 1$ to 31. However, an E1 module allows arbitrary grouping of 31 channels and multiple bundles.
 - The FIC-E1-F modules do not support the PRI mode.

Interface specifications

Table 191 Interface specifications

Item	Specification	
	FIC-2E1	FIC-4E1/FIC-4E1-F
Connector	D15	D25
Number of connectors	2	1
Interface standard	G.703, G.704	
Interface rate	2.048 Mbps	
Cable type	<ul style="list-style-type: none"> E1 75-ohm unbalanced coaxial cable E1 120-ohm balanced twisted-pair cable 120-ohm 4E1 adapter cable (FIC-4E1/FIC-4E1-F) 75-ohm 4E1 adapter cable (FIC-4E1/FIC-4E1-F) Coaxial connector, network connector, 75-to-120-ohm adapter (with BNC connector) 	
Operating mode	E1, CE1, ISDN PRI (only supported by the FIC-E1 modules) FE1 (only supported by the FIC-E1-F modules)	
Supported service	<ul style="list-style-type: none"> Backup Leased line ISDN PRI (only supported by the FIC-E1 modules) 	

Interface LEDs

Figure 140 FIC-2E1 panel

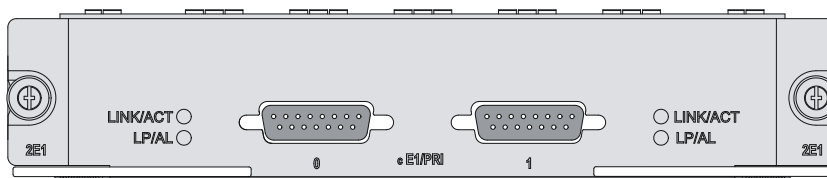

Figure 141 FIC-4E1 panel

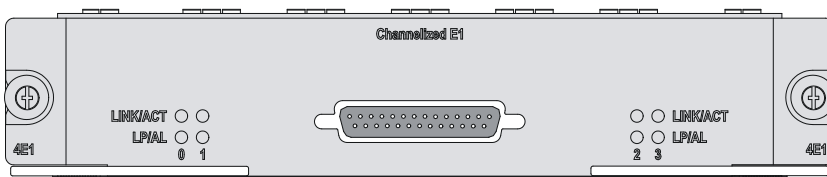

Figure 142 FIC-4E1-F panel

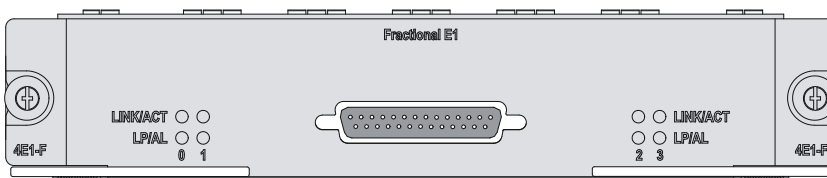

Table 192 LED description

LED	Description
LINK/ACT	<ul style="list-style-type: none">• On means carrier signal has been received.• Flashing means data is being received or/and transmitted.• Off means no carrier signal has been received.
LP/AL	<ul style="list-style-type: none">• On means the interface is in a loopback.• Flashing means an AIS, LFA, or RAI alarm signal is present.• Off means no loopback or alarm is present.
Note: AIS = Alarm indication signal; LFA = loss of frame alignment; RAI = Remote alarm indication	

Interface cables and connection methods

For more information about E1 interface cables, see "[E1 interface](#)."

FIC-8E1

Introduction

The 8-port channelized E1/PRI interface module (FIC-8E1) transmits, receives, and processes eight channels of E1 data traffic. In addition, you can use the module for other purposes, such as CE1 access and the ISDN PRI function.

NOTE:

For a FIC-8E1 module, the system automatically creates a serial interface for each timeslot bundle formed on a controller E1 interface.

Interface specifications

Table 193 Interface specifications

Item	Specification
Connector	D68
Number of connectors	1
Interface standard	G.703
Interface rate	2.048 Mbps
Cable type	75-ohm 8E1 conversion cable
Operating mode	<ul style="list-style-type: none">• E1, CE1, ISDN PRI
Supported service	<ul style="list-style-type: none">• Backup• Terminal access service• ISDN PRI

Interface LEDs

Figure 143 FIC-8E1 (75-ohm) panel

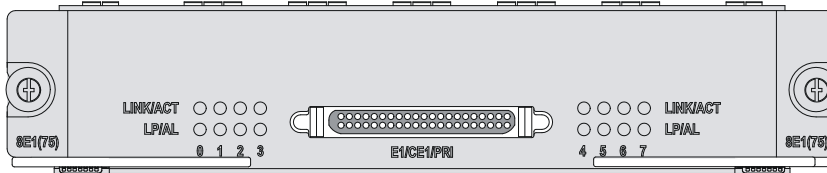

Table 194 LED description

LED	Description
LINK/ACT	<ul style="list-style-type: none"> On means carrier signal has been received. Flashing means data is being received or/and transmitted. Off means no carrier signal has been received.
LP/AL	<ul style="list-style-type: none"> On means the interface is in a loopback. Flashing means an AIS, LFA, or RAI alarm signal is present. Off means no loopback or alarm is present.
<p>Note: AIS = Alarm indication signal; LFA = loss of frame alignment; RAI = Remote alarm indication</p>	

Interface cables and connection methods

For more information about E1 interface cables, see "[E1 interface](#)."

FIC-4T1-F

Introduction

The FT1 operating mode supported by the T1-F modules allows only one $n \times 64$ kbps or $n \times 56$ kbps bundle to be formed on each interface, where $n = 1$ to 24. The FIC-4T1-F modules do not support the PRI mode.

Interface specifications

Table 195 Interface specifications

Item	Specification
Connector	RJ-45
Number of connectors	<ul style="list-style-type: none"> 4
Interface standard	<ul style="list-style-type: none"> G.703/T1 102 G.704 AT&T TR 54016 AT&T TR 62411 ANSI T1.403
Interface rate	1.544 Mbps
Cable type	T1 cable (100-ohm straight-through shielded cable)
Operating mode	FT1
Supported service	<ul style="list-style-type: none"> Backup Leased line

Interface LEDs

Figure 144 FIC-4T1-F panel

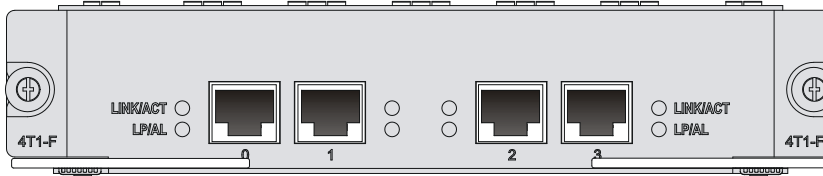

Table 196 LED description

LED	Description
LINK/ACT	<ul style="list-style-type: none">On means the carrier signal has been received.Off means no carrier signal has been received.Flashing means data is being transmitted or/and received.
LP/AL	<ul style="list-style-type: none">On means the interface is in a loopback.Flashing means an AIS, LFA, or RAI alarm signal is present.Off means no loopback or alarm is present.
Note: AIS = Alarm indication signal; LFA = loss of frame alignment; RAI = Remote alarm indication	

Interface cables and connection methods

For more information about T1 interface cables, see "[T1 interface](#)."

E3/T3 interface module

- FIC-1CE3
- FIC-1CT3

FIC-1CE3

Introduction

The 1-port channelized E3/fractional E3 interface module FIC-1CE3) provides the following features:

- In E3 mode, transmits, receives, and processes one channel of E3 fast traffic; providing E3 traffic access.
- In CE3 mode, provides the subscribers with $N \times 64$ kbps low-speed access, where N is smaller than or equal to 128.

NOTE:

E3 represents the tertiary group rate (34.368 Mbps) of E system in the TDM system. Through E23 and E12 demultiplexing, an E3 channel can be channelized into 16 E1 lines. Each line supports both the E1 and CE1 modes. E23 means either E2-to-E3 multiplex or E3-to-E2 demultiplex, and E12 means E1-to-E2 multiplex or E2-to-E1 demultiplex. "E23" and "E12" discussed here represent the demultiplex process.

Interface specifications

Table 197 Interface specifications

Item	Specification
Connector	SMB
Number of connectors	2
Interface standard	G.703 G.704 G.751
Interface rate	34.368 Mbps
Cable type	E3/T3 cable (75-ohm coaxial cable)
Operating mode	E3 CE3
Supported service	E3 leased line

Interface LEDs

Figure 145 FIC-1CE3 panel

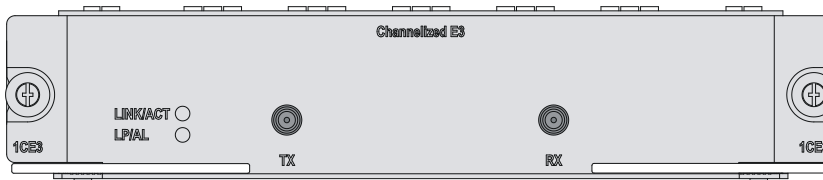

Table 198 LED description

LED	Description
LINK/ACT	<ul style="list-style-type: none"> On means the carrier signal has been received. Off means no carrier signal has been received. Flashing means data is being transmitted or/and received.
LP/AL	<ul style="list-style-type: none"> On means the interface is in a loopback. Flashing means an AIS, LFA, or RAI alarm signal is present. Off means no loopback or alarm is present.
<p>Note: AIS = Alarm indication signal; LFA = loss of frame alignment; RAI = Remote alarm indication</p>	

Interface cables and connection methods

For more information about E3 interface cables and connection methods, see "[E3/T3 interface](#)."

FIC-1CT3

Introduction

The 1-port channelized/non channelized T3 interface module (FIC-1CT3) provides the following features:

- In T3 mode, transmits, receives, and processes one channel of T3 fast traffic; providing T3 traffic access.

- In CT3 mode, provides the subscribers with N x 64 kbps or N x 56 kbps low-speed access, where N is smaller than or equal to 128.

NOTE:

T3 represents the tertiary group rate (44.736 Mbps) of T system in the TDM system. Through T23 and T12A demultiplexing, a T3 channel can be channelized into 28 T1 lines. Each line supports the operating mode of CT1. T23 means either T2-to-T3 multiplex or T3-to-T2 demultiplex, and T12 means T1-to-T2 multiplex or T2-to-T1 demultiplex. "T23" and "T12" discussed here represent the demultiplex process.

Interface specifications

Table 199 Interface specifications

Item	Specification
Connector	SMB
Number of connectors	2
Interface standard	<ul style="list-style-type: none"> • G.703 • G.704 • G.752 • AT&T TR 54014 • AT&T TR 62415 • ANSI T1.107
Interface rate	44.736 Mbps
Cable	E3/T3 cable (75-ohm coaxial cable)
Operating mode	T3 CT3
Supported service	T3 leased line

Interface LEDs

Figure 146 FIC-1CT3 panel

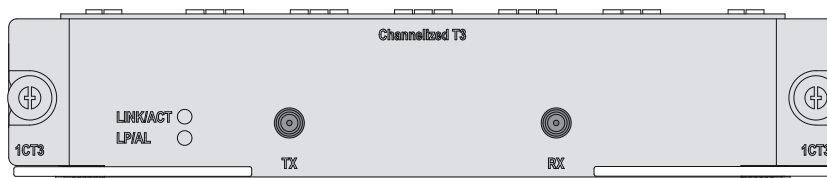

Table 200 LED description

LED	Description
LINK/ACT	<ul style="list-style-type: none"> • On means the carrier signal has been received. • Off means no carrier signal has been received. • Flashing means data is being transmitted or/and received.
LP/AL	<ul style="list-style-type: none"> • On means the interface is in a loopback. • Flashing means an AIS, LFA, or RAI alarm signal is present. • Off means no loopback or alarm is present.
<p>Note: AIS = Alarm indication signal; LFA = loss of frame alignment; RAI = Remote alarm indication</p>	

Interface cables and connection methods

For more information about T3 interface cables, see "[E3/T3 interface](#)."

ISDN BRI interface module

- FIC-4BSE

FIC-4BSE

Introduction

The four-port ISDN BRI interface module (FIC-4BSE) transmits, receives, and processes four channels of ISDN BRI S/T data traffic on ISDN BRI S/T interfaces.

The FIC-4BSE differs from the FIC-4BS only in the way they set matched resistance for an ISDN BRI S/T interface. The FIC-4BS uses jumpers while the FIC-4BSE uses DIP switches.

The FIC-4BSE can operate in dial mode or leased line mode.

Interface specifications

Table 201 Interface specifications

Item	Specification
Connector	RJ-45
Number of connectors	4
Cable	ISDN S/T cable
Protocol & standard	ITU-T I.430, Q.921, Q.931
Operating mode	<ul style="list-style-type: none">• ISDN dial-up• ISDN leased line
Supported service	<ul style="list-style-type: none">• ISDN• ISDN supplementary services• Multi-user number• Sub-addressing• Backup

Jumper settings

The FIC-4BSE uses jumpers to set matched resistance for ISDN BRI S/T interfaces. The use of 100-ohm resistance on an ISDN BRI S/T interface depends on jumper settings. By default, the jumpers are placed over jump pins 2 and 3, and 100-ohm matched resistances are not used. Figure 139 shows the jumper settings, where all the ISDN BRI S/T interfaces are using 100-ohm resistance.

Figure 147 Jumper settings of the FIC-4BSE (example)

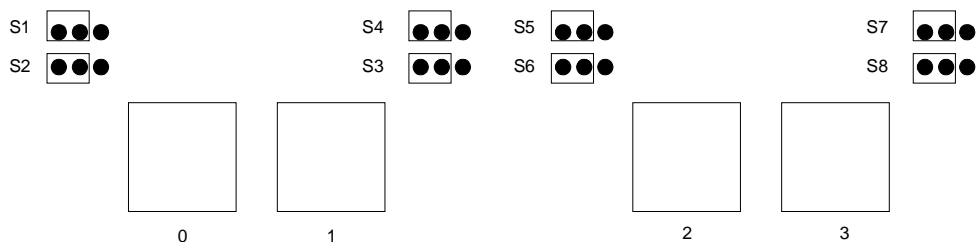

Table 202 Set the jumpers on the FIC-4BSE

Jumper settings & description		
Interface 0	S2	<ul style="list-style-type: none"> To use a 100-ohm matched resistance for data transmission, place the jumper over pins 1 and 2. To do otherwise, place the jumper over jump pins 2 and 3. See Figure 139.
	S1	<ul style="list-style-type: none"> To use a 100-ohm matched resistance for data receiving, place the jumper over jump pins 1 and 2. To do otherwise, place the jumper over jump pins 2 and 3. See Figure 139.
Interface 1	S4	<ul style="list-style-type: none"> To use a 100-ohm matched resistance for data transmission, place the jumper over pins 1 and 2. To do otherwise, place the jumper over jump pins 2 and 3. See Figure 139.
	S3	<ul style="list-style-type: none"> To use a 100-ohm matched resistance for data receiving, place the jumper over jump pins 1 and 2. To do otherwise, place the jumper over jump pins 2 and 3. See Figure 139.
Interface 2	S6	<ul style="list-style-type: none"> To use a 100-ohm matched resistance for data transmission, place the jumper over pins 1 and 2. To do otherwise, place the jumper over jump pins 2 and 3. See Figure 139.
	S5	<ul style="list-style-type: none"> To use a 100-ohm matched resistance for data receiving, place the jumper over jump pins 1 and 2. To do otherwise, place the jumper over jump pins 2 and 3. See Figure 139.
Interface 3	S8	<ul style="list-style-type: none"> To use a 100-ohm matched resistance for data transmission, place the jumper over pins 1 and 2. To do otherwise, place the jumper over jump pins 2 and 3. See Figure 139.
	S7	<ul style="list-style-type: none"> To use a 100-ohm matched resistance for data receiving, place the jumper over jump pins 1 and 2. To do otherwise, place the jumper over jump pins 2 and 3. See Figure 139.

Interface LEDs

Figure 148 FIC-4BSE panel

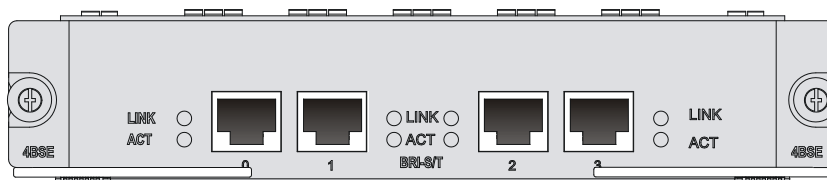

Table 203 LED description

LED	Description
LINK	<ul style="list-style-type: none"> Off means no link is present. On means a link is present.

LED	Description
ACT	<ul style="list-style-type: none"> Off means no data is being received or transmitted. Flashing means data is being received and/or transmitted.

Interface cables and connection methods

For more information about BSE interface cables, see "[BSV/BSE interface](#)."

Serial interface module

- FIC-4SAE
- FIC-8SAE
- FIC-8ASE
- FIC-16ASE

FIC-4SAE/FIC-8SAE

Introduction

The 4-/8-port enhanced high-speed synchronous/asynchronous serial interface module (FIC-4SAE/FIC-8SAE) transmits, receives, and processes data on the synchronous/asynchronous serial interface. They support both synchronous and asynchronous modes. In synchronous mode, they support the DTE/DCE mode.

DTE and DCE

An FIC-SA module is typically connected to an external modem for dialing purpose, and an appropriate baud rate setting is required.

The synchronous serial interface can work in either DTE or DCE mode. Two directly connected devices must work as DTE and DCE. The DCE provides clock synchronization and specifies the communication rate, whereas the DTE accepts clock synchronization and communicates at the specified rate.

The router typically works as a DTE. To identify whether the equipment connected to the router is DTE or DCE, refer to the manual shipped with the equipment.

Speed and transmission segment of synchronous/asynchronous serial interface

In different operating modes, the synchronous/asynchronous serial interface supports different electric signal specifications and baud rates. In addition, the maximum signal transmission segment depends not only on the specified baud rate but also on the selected cable. The following table shows how the cable type, baud rate, and the maximum signal transmission segment related to each other.

Table 204 Speed and transmission segment of the V.24 (RS232)/V.35 cable

V.24 (RS232)		V.35	
Baud rate (bps)	Max. transmission segment	Baud rate (bps)	Max. transmission segment
2400	60 m (196.9 ft)	2400	1250 (4101 ft)
4800	60 m (196.9 ft)	4800	625 m (2050.5 ft)
9600	30 m (98.4 ft)	9600	312 m (1023.6 ft)
19200	30 m (98.4 ft)	19200	156 m (511.8 ft)

V.24 (RS232)		V.35	
38400	20 m (65.6 ft)	38400	78 m (255.9 ft)
64000	20 m (65.6 ft)	56000	60 m (196.9 ft)
115200	10 m (32.8 ft)	64000	50 m (164 ft)
—	—	2048000	30 m (98.4 ft)

NOTE:

When a V.24 cable is used, make sure the baud rate of the FIC-SA in synchronous mode does not exceed 64 Kbps.

Interface specifications

Table 205 Interface specifications

Item	Specification			
	Synchronous		Asynchronous	
Connector	D28			
Number of connectors	2 (FIC-2SAE) 4 (FIC-4SAE) 8 (FIC-8SAE)			
Interface standard and operating mode	V.24	V.35, RS449, X.21, RS530		RS232
	DTE, DCE	DTE	DCE	
Min. baud rate(bps)	1200	1200		300
Max. baud rate(bps)	64 k	4.096 M	2.048 M	115.2
Cable	<ul style="list-style-type: none"> • V.24 (RS232) DTE cable • V.24 (RS232) DCE cable • V.35 DTE cable • V.35 DCE cable • X.21 DTE cable • X.21 DCE cable • RS449 DTE cable • RS449 DCE cable • RS530 DTE cable • RS530 DCE cable 			
Supported service	<ul style="list-style-type: none"> • DDN leased line • Terminal access service 		<ul style="list-style-type: none"> • Dialup through modem • Backup • Asynchronous leased line • Terminal access service 	

Interface LEDs

Figure 149 FIC-4SAE panel

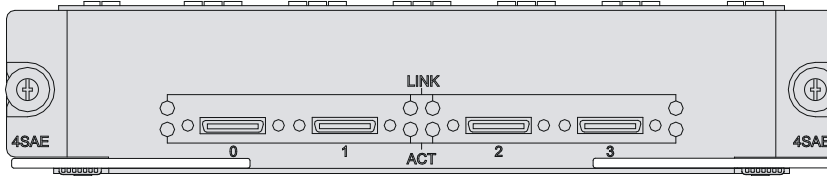
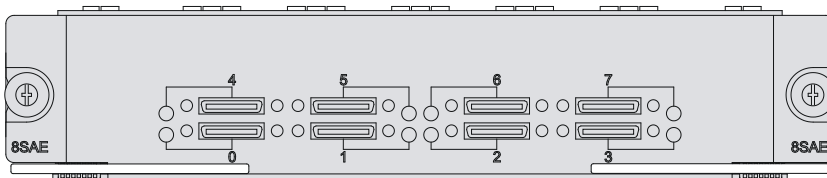

Table 206 LED description

LED	Description
LINK	<ul style="list-style-type: none"> Off means no link is present; On means a link is present.
ACT	<ul style="list-style-type: none"> Off means no data is being transmitted or received. Flashing means data is being transmitted and/or received.

Figure 150 FIC-8SAE front panel



On the FIC-8SAE panel, each link has a LED. On means a link is present. Flashing means data is being transmitted and/or received.

Interface cables and connection methods

For more information about asynchronous serial port cables, see "[Asynchronous serial ports.](#)"

FIC-8ASE/FIC-16ASE

Introduction

The 8-/16-port enhanced asynchronous serial interface module (FIC-8ASE/FIC-16ASE) transmits, receives, and processes data traffic on asynchronous serial interfaces. Each asynchronous serial interface can operate at 115.2 kbps, supporting terminal access service and asynchronous leased line. In addition, these asynchronous serial interfaces can act as the dialup access servers for the small and medium-sized ISPs to interconnect eight or 16 LANs through asynchronous dialup lines.

Interface specifications

Table 207 Interface specifications

Item	Specification	
	FIC-8ASE	FIC-16ASE
Connector	RJ-45	
Number of connectors	<ul style="list-style-type: none"> 8 (FIC-8ASE) 16 (FIC-16ASE) 	
Interface standard and operating mode	RS232	

Item	Specification	
	FIC-8ASE	FIC-16ASE
Cable type	<ul style="list-style-type: none"> AUX cable Ethernet straight-through cable FIC-8ASE/FIC-16ASE dumb terminal cable 	
Min. baud rate (bps)	300	
Max. baud rate (bps)	115.2 k	
Service supported	<ul style="list-style-type: none"> Dialup through modem Backup Terminal access service Asynchronous leased line 	

Interface LEDs

Figure 151 FIC-8ASE panel

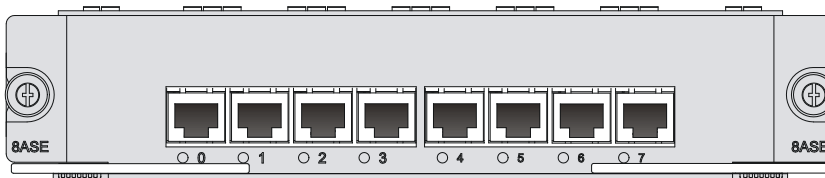
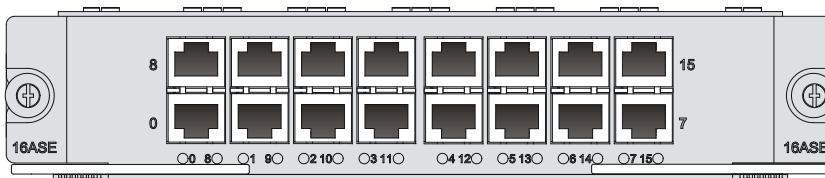

Figure 152 FIC-16ASE panel



The FIC-8ASE/FIC-16ASE has one LED for each port. On means a link is present. Off means data is being transmitted and/or received.

Interface cables and connection methods

For more information about asynchronous serial port cables, see "[Asynchronous serial ports.](#)"

Voice interface module

- FIC-4FXS
- FIC-4FXO
- FIC-4E&M
- FIC-24FXS
- FIC-2VE1
- FIC-2VT1
- FIC-1VE1
- FIC-1VT1

FIC-4FXS/FIC-4FXO

Introduction

The 4-port voice subscriber circuit interface module (FIC-4FXS) processes and transmits over data communications networks voice signals for 4 regular analog phones, faxes, or AT0 loop trunks of telephone exchanges.

The 4-port voice AT0 analog trunk interface module (FIC-4FXO) processes and transmits over data communications networks voice signals for 4 loops of telephone exchanges.

Interface specifications

Table 208 Interface specifications

Item	Specification
Connector	RJ-45
Number of connectors	<ul style="list-style-type: none"> 4
Cable	<ul style="list-style-type: none"> Telephone cable with ferrite core E&M trunk cable (only for E&M modules, made on site)
Interface standard	<ul style="list-style-type: none"> ITU Q.512-compliant subscriber circuit interface (FIC-4FXS) ITU Q.552-compliant loop trunk interface (FIC-4FXO) ITU K.20-compliant overcurrent protection
Dial-up mode	Dual-tone multifrequency (DTMF), compliant with GB3378 (Pulse dial is not available.)
Bandwidth	300 Hz to 3400 Hz

Interface LEDs

Figure 153 FIC-4FXS panel

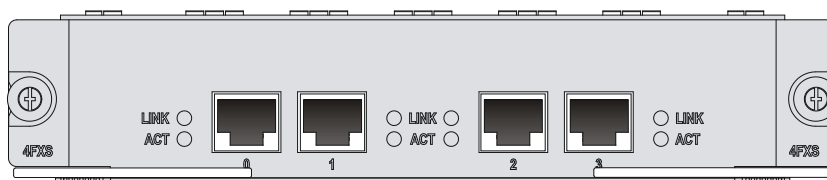

Figure 154 FIC-4FXO panel

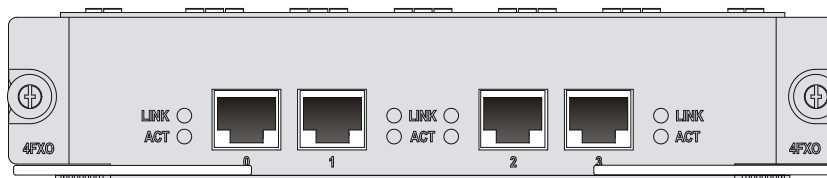

Table 209 LED description

LED	Description
LINK	<ul style="list-style-type: none"> Off means no link is present. On means a link is present.
ACT	<ul style="list-style-type: none"> Off means the channel is idle. On means there is call activity.

Interface cables and connection methods

For more information about FXS / FXO interface cables and connection methods, see "[ADSL/BS/FXS/FXO/AM/FCM interface.](#)"

FIC-4E&M

Introduction

The 4-port voice E&M analog trunk interface module (FIC-4E&M) processes and transmits over data communications networks voice signals for 4 E&M analog trunks.

Interface specifications

Table 210 Interface specifications

Item	Specification
Connector	RJ-45
Number of connectors	<ul style="list-style-type: none">• 4
Cable	<ul style="list-style-type: none">• Telephone cable with ferrite core• E&M trunk cable (only for E&M modules, made on site)
Interface standard	<ul style="list-style-type: none">• ITU Q.512-compliant subscriber circuit interface (FIC-4FXS)• ITU Q.552-compliant loop trunk interface (FIC-4FXO)• ITU K.20-compliant overcurrent protection
Dial-up mode	Dual-tone multifrequency (DTMF), compliant with GB3378 (Pulse dial is not available.)
Bandwidth	300 Hz to 3400 Hz

Interface LEDs

Figure 155 FIC-4E&M panel

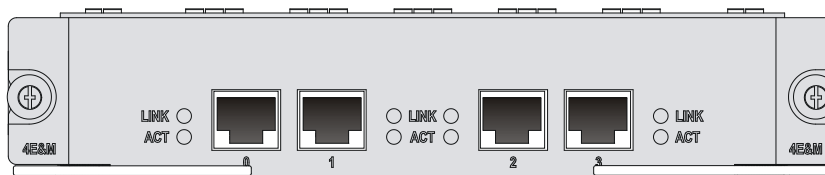

Table 211 LED description

LED	Description
LINK	<ul style="list-style-type: none">• Off means no link is present.• On means a link is present.
ACT	<ul style="list-style-type: none">• Off means the channel is idle.• On means there is call activity.

Interface cables and connection methods

For more information about E&M Interface cables and connection methods, see "[E&M interface.](#)"

FIC-24FXS

Introduction

The 24-port voice subscriber circuit interface module (FIC-24FXS) processes and transmits voice signals over data communications networks for 24 regular analog phones, faxes, or AT0 loop trunks of telephone exchanges.

Interface specifications

Table 212 Interface specifications

Item	Description
Connector	50-pin D-type female connector
Interface standard	FXS interface
Interface rate	24 × FXS interface rate

Interface LEDs

Table 213 LED description

LED	Description
LINK	<ul style="list-style-type: none">Off means no link is present.On means a link is present.
ACT	<ul style="list-style-type: none">Off means the channel is idle.On means there is call activity.

Figure 156 FIC-24FXS front panel

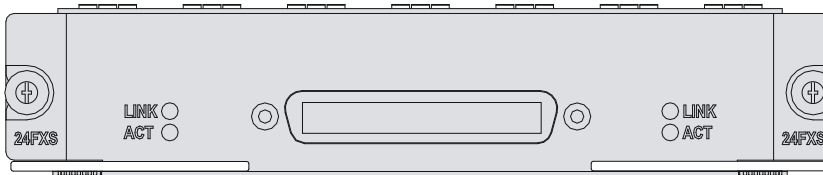

Interface cables and connection methods

For more information about 24FXS interface cables and connection methods, see "[24FXS interface](#)."

FIC-2VE1

Introduction

The 2-port E1 voice interface module (FIC-2VE1) handles dense voice signals in a VoIP system. It provides two CE1/PRI/R2 ports that provide access for a maximum of 60 channels of voice signals.

Interface specifications

Table 214 Interface specifications

Item	Specification
Connector	D15
Number of connectors	2

Item	Specification
Operating mode	CE1 ISDN PRI R2
Interface rate	2.048 Mbps
Cable	<ul style="list-style-type: none"> E1 75-ohm unbalanced twisted pair cable E1 120-ohm balanced twisted pair cable Coaxial connector, network connector, 75-to-120-ohm adapter (with BNC connector)
Supported service	<ul style="list-style-type: none"> R2 signaling DSS1 signaling IP Fax General VoIP features in Comware

Interface LEDs

Figure 157 FIC-2VE1 panel

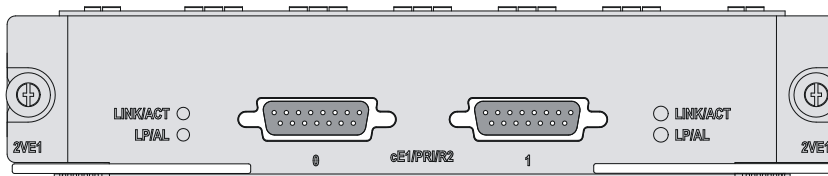

Table 215 LED description

LED	Description
LINK/ACT	<ul style="list-style-type: none"> On means carrier signal has been received. Flashing means data is being received or/and transmitted. Off means no carrier signal has been received.
LP/AL	<ul style="list-style-type: none"> On means the interface is in a loopback. Flashing means an AIS, LFA, or RAI alarm signal is present. Off means no loopback or alarm is present.
<p>Note: AIS = Alarm indication signal; LFA = loss of frame alignment; RAI = Remote alarm indication</p>	

Interface cables and connection methods

For more information about E1 interface cables and connection methods, see "[E1 interface](#)."

FIC-2VT1

Introduction

The 2-port T1 voice interface module (FIC-2VT1) handles dense voice signals in VoIP system. It provides two CE1/PRI ports that allow access of a maximum of 48 channels of voice signals.

Interface specifications

Table 216 Interface specifications

Item	Specification
Connector	RJ-45
Number of connector	2
Interface standard	<ul style="list-style-type: none"> • G.703/T1.102 • G.704 • AT&T TR 54016 • AT&T TR 62411 • ANSI T1.403
Interface rate	1.544 Mbps
Cable type	T1 cable (100-ohm standard shielded cable)
Operating mode	<ul style="list-style-type: none"> • CT1 • ISDN PRI
Services	<ul style="list-style-type: none"> • Backup • Terminal access • ISDN

Interface LEDs

Figure 158 FIC-2VT1 panel

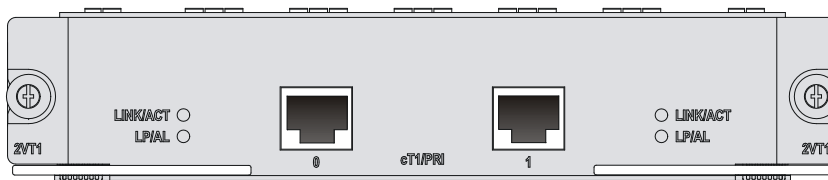

Table 217 LED description

LED	Description
LINK/ACT	<ul style="list-style-type: none"> • On means carrier signal has been received. • Flashing means data is being received or/and transmitted. • Off means no carrier signal has been received.
LP/AL	<ul style="list-style-type: none"> • On means the interface is in a loopback. • Flashing means an AIS, LFA, or RAI alarm signal is present. • Off means no loopback or alarm is present.
<p>Note: AIS = Alarm indication signal; LFA = loss of frame alignment; RAI = Remote alarm indication</p>	

Interface cables and connection methods

For more information about T1 interface cables and connection methods, see ["T1 interface."](#)

FIC-1VE1

Introduction

The 1-port E1 voice interface module (FIC-1VE1) handles dense voice signals in VoIP system. It provides a CE1/PRI/R2 port that allows access of a maximum of 30 channels of voice signals.

Interface specifications

Table 218 Interface specifications

Item	Specification
Connector	D15
Number of connectors	1
Operating mode	CE1 ISDN PRI R2
Interface rate	2.048 Mbps
Cable	<ul style="list-style-type: none"> E1 120-ohm balanced twisted pair cable 75ohm-to-120ohm adapter Network interface connector
Supported service	<ul style="list-style-type: none"> R2 signaling DSS1 signaling IP Fax General VoIP features in Comware

Interface LEDs

Figure 159 FIC-1VE1 panel

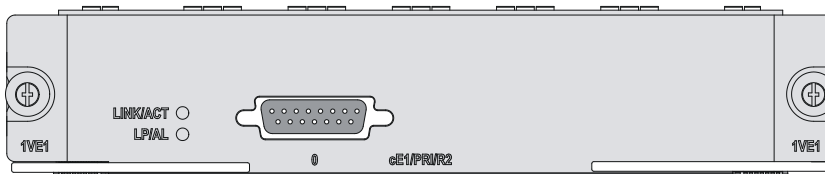

Table 219 LED description

LED	Description
LINK/ACT	<ul style="list-style-type: none"> On means carrier signal has been received. Flashing means data is being received or/and transmitted. Off means no carrier signal has been received.
LP/AL	<ul style="list-style-type: none"> On means the interface is in a loopback. Flashing means an AIS, LFA, or RAI alarm signal is present. Off means no loopback or alarm is present.
<p>Note: AIS = Alarm indication signal; LFA = loss of frame alignment; RAI = Remote alarm indication</p>	

Interface cables and connection methods

For more information about E1 interface cables and connection methods, see "[E1 interface](#)."

FIC-1VT1

Introduction

The 1-port T1 voice interface module (FIC-1VT1) handles dense voice signals in VoIP system. It provides a CT1/PRI port that allows access of a maximum of 24 channels of voice signals.

Interface specifications

Table 220 Interface specifications

Item	Specification
Connector	RJ-45
Number of connector	1
Interface standard	<ul style="list-style-type: none">• G.703/T1.102• G.704• AT&T TR 54016• AT&T TR 62411• ANSI T1.403
Interface rate	1.544 Mbps
Cable type	T1 cable (100-ohm standard shielded cable)
Operating mode	<ul style="list-style-type: none">• CT1• ISDN PRI
Services	<ul style="list-style-type: none">• Backup• Terminal access• ISDN

Interface LEDs

Figure 160 FIC-1VT1 panel

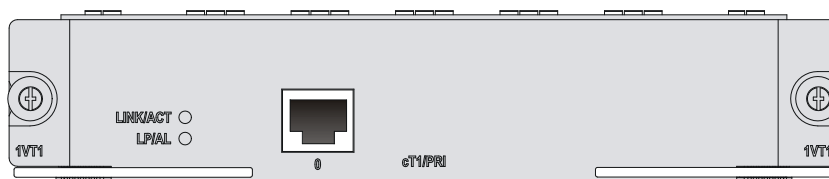

Table 221 LED description

LED	Description
LINK/ACT	<ul style="list-style-type: none">• On means carrier signal has been received.• Flashing means data is being received or/and transmitted.• Off means no carrier signal has been received.
LP/AL	<ul style="list-style-type: none">• On means the interface is in a loopback.• Flashing means an AIS, LFA, or RAI alarm signal is present.• Off means no loopback or alarm is present.
Note: AIS = Alarm indication signal; LFA = loss of frame alignment; RAI = Remote alarm indication	

Interface cables and connection methods

For more information about T1 interface cables and connection methods, see "[T1 interface](#)."

ESM/VCPM/VPM

ESMs

Enhanced service module (ESM) is installed on a multi-service module (MSC). It supports IPsec and hardware encryption and decryption and hashing operation to provide high performance and reliability encryption features.

The encryption engine is optional. On a router installed with an encryption engine, the MPU routes IP packets and implements encryption-enabled VPN, while the encryption module encrypts packets.

- ESM-ANDE
- ESM-SNDE

ESM-ANDE

Introduction

When installed with an ESM-ANDE module, the main board of your router can implement VPN with encryption provided by the ESM-ANDE module in addition to IP packet forwarding.

Interface specifications

Table 222 Interface specifications

Item	Specification
Protocol supported	IPsec
IPsec concurrent tunnels	100 (implemented through software)
Hardware algorithm	key algorithm (DES, 3DES, AES, QC5, Blowfish, Cast-128 and SkipJack) Authentication algorithm (HMAC-MD5-96, HMAC-SHA-1-96)

Interface LEDs

The MPU on the router provides an ESM interface LED to indicate the status of the ESM-ANDE module.

Table 223 LED description

LED	Description
ESMx	<ul style="list-style-type: none">• Green: The ANDE module is in the slot and is operating correctly.• Yellow: The ANDE module is in the slot but cannot be accessed by the router.
Note: x means the number of the slot the ESM LED is in.	

Installing and removing an ESM-ANDE module

For more information about installing and removing an ESM-ANDE module, see the installation guides for the HPE MSR router models.

ESM-SNDE

Introduction

The ESM-SNDE supports IPsec and hardware expedited IP data packet encryption to provide encryption with high performance and reliability.

Installed with a standard network data encryption engine (SNDE) module, the MPU on your router can implement VPN with encryption provided by the ESM-SNDE module in addition to IP packet forwarding.

Interface specifications

Table 224 Interface specifications

Item	Specification
Protocol supported	IPsec
IPsec concurrent tunnels	100 (implemented through software)
Hardware algorithm	key algorithm (DES, 3DES, AES, QC5, Blowfish, Cast-128 and SkipJack) Authentication algorithm (HMAC-MD5-96, HMAC-SHA-1-96)

Interface LEDs

The MPU on the router provides an ESM interface LED to indicate the status of the ESM-SNDE module.

Table 225 LED description

LED	Description
ESMx	<ul style="list-style-type: none">Green: The SNDE module is in the slot and is operating correctly.Yellow: The SNDE module is in the slot but cannot be accessed by the router.
Note: x means the number of the slot the ESM LED is in.	

Installing and removing an ESM-SNDE module

For more information about installing and removing an ESM-SNDE module, see the installation guides for the HPE MSR router models.

VCPM/VPM

- VCPM
- VPM

VCPM/VPM purchase guide

- The main boards of the MSR20-40 and MSR30 series routers provide voice co-processing module (VCPM) and voice processing module (VPM) slots. They do not have VCPM and VPM modules installed when the router is shipped from the factory.
- The SIC-VE1/SIC-VT1 module does not provide any VCPM or VPM slot, and can only use the VCPM and VPM installed on the main board of the router.

- The MIM-1VE1/MIM-1VT1 module provides a VCPM and a VPM slot, and the MIM-2VE1/MIM-2VT1 module provides a VCPM and two VPM slots. Each MIM-VE1/MIM-VT1 module has a VCPM installed but has no VPM installed when it is shipped from the factory.
- The VCPM module used for the main board of the MSR20-40 and MSR30 series routers and the VCPM module that comes pre-installed on the MIM-VE1/VT1 module are different and cannot be used interchangeably.
- The VPM module used for the main board of an MSR20-40 or MSR30 series router is the same as the VPM module installed on the MIM-VE1/VT1 module.
- When you install a SIC-VE1/SIC-VT1 module on a compatible MSR20-40 and MSR30 series router, you also need to install a VCPM and VPM on the main board of the router. The number of VPMs needed depends on the number of calls. Installation should be performed by HPE Support or an authorized HPE partner.
- The MIM-VE1/VT1 module must be used with VPM installed. The number of VPMs needed depends on the number of calls.
- If you install more than one MIM-VE1/MIM-VT1 module (or one MIM-VE1/MIM-VT1 module and one SIC-VE1/SIC-VT1 module) on a compatible MSR30 series router, you need to add another VCPM on the main board of the router.
- If you install a single MIM-VE1/MIM-VT1 module on an MSR30 series router, no additional VCPM is required.
- When using an MSR router as the initiator of a three-party conference, the main board of the MSR router must have VPM installed. This is because the initiator of a three-party conference is responsible for audio mixing.
- Do not install a VCPM on the MSR20-12 router when installing a SIC-VE1/SIC-VT1 module on them. Each main board of the MSR20-12 routers provides only one VPM slot. The specifications and number of VPMs needed depend on the number of calls. Installation should be performed by HPE personnel or an authorized HPE partner.
- The multi-service module A (MSCA) of an MSR50 series router provides VCPM and VPM slots, but the multi-service module B (MSCB) provides only one VCPM slot. No VCPM and VPM slots are installed when MSR is shipped.
- Install VCPM and VPM modules on a MSCA when installing the SIC-VE1/SIC-VT1 on the MSR50 series routers. The specifications and number of VPM modules needed depend on the number of calls.
- The FIC-1VE1/FIC-1VT1 module provides one VCPM slot and one VPM slot and the FIC-2VE1/FIC-2VT1 module provides one VCPM and two VPM slots. The FIC-2VE1/FIC-2VT1 module has a VCPM installed when MSR is shipped.
- The VCPM module installed on the MSCA/MSCB of an MSR50 series router is different from the VCPM module installed on the FIC-VE1/FIC-VT1 module. Therefore, they cannot be used interchangeably.
- The FIC-VE1/FIC-VT1 is used with a VPM module installed. The specifications and number of VPM modules needed depend on the number of calls.
- The VPM modules installed on the MSCA of the MSR50 series routers are the same as the VPM modules installed on the FIC-VE1/FIC-VT1 modules.
- If you install more than two FIC-VE1/FIC-VT1 modules on an MSR50 series router, you need to add another VCPM module on the MSCA/MSCA.

VCPM

Introduction

The Voice co-processing module (VCPM) provides a transmission channel between DSP strip and system memory for voice data. This implements TDM HW exchange for each PCM data voice channel.

VCPM modules are required for voice communications of routers.

Interface specifications

Table 226 Interface specifications

Item	Specification
Connector	Double-edge connector
Interface type	PCI 2.2, EHPI
Data transmission rate	<ul style="list-style-type: none"> Operating rate for PCI bus: 33 MHz/66 MHz Maximum bandwidth: 264 Mbps BURST transmission: Up to 1 KB of data can be transmitted once and the maximum number of bytes transmitted can be configured.

Interface LEDs

The MPU on the router provides a VCPM interface LED to indicate the status of the VCPM module.

Table 227 LED description

LED	Description
VCPMx	<ul style="list-style-type: none"> Green: The VCPM module is in the slot and is operating correctly. Yellow: The VCPM module is in the slot but cannot be accessed by the router.
Note: X means the slot number VCPM module LED is on.	

Installing/removing a VCPM module

For more information about how to install or remove a VCPM module, see the installation guides for HPE MSR series routers.

VPM

Introduction

The Voice Processing Module (VPM) provides the following features:

- Encoding/decoding
- Echo cancellation (EC)
- Comfortable noise generation (CNG) of voices.

Interface specifications

Table 228 Interface specifications

Item	Specification
Number of calls supported	<ul style="list-style-type: none"> 8 16 24 32

Installing/removing a VPM module

For more information about how to install or remove a VPM module, see the installation guides for HPE MSR series routers.

Cables and connection methods

Ethernet interface

Ethernet cable appearance and applicable models

Table 229 Ethernet cable appearance and applicable models

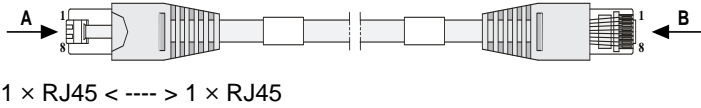
Cable	Appearance	Applicable models
Ethernet cable	 <p>1 x RJ45 < ---- > 1 x RJ45</p>	SIC-4FSW SIC-4FSW-PoE DSIC-9FSW DSIC-9FSW-PoE SIC-4GSW SIC-4GSW-PoE MIM-16FSW MIM-16FSW-PoE DMIM-24FSW DMIM-24FSW-PoE FIC-16FSW FIC-16FSW-PoE DFIC-24FSW DFIC-24FSW-PoE SIC-1FEA SIC-1GEC XMIM-16FSW XMIM-24FSW MIM-1FE MIM-2FE MIM-4FE MIM-1GBE MIM-2GBE FIC-16FSW FIC-16FSW-PoE FIC-1FE FIC-2FE FIC-4FE FIC-1GBE FIC-2GBE HMIM-8GSW HMIM-24GSW HMIM-24GSW-PoE

10/100 Mbps Ethernet uses category-5 twisted pair cables, and 1000 Mbps Ethernet uses category-5 enhanced or category-6 twisted pair cables. Twisted pair cables include straight-through cables and crossover cables.

Category-5 cables provide a transmission frequency of 100 MHz for voice and data transmission. They are typically used in 100Base-T and 10Base-T networks. Category-5 cables are common Ethernet cables, which can also be used to transmit 1000 Mbps Ethernet data.

Category-5 enhanced cables feature low attenuation and crosstalk, providing higher attenuation to crosstalk ratio (ACR), less delay error and higher performance than category-5 cables. Category-5 enhanced cables are mainly used in 1000 Mbps Ethernet networks.

Category-6 cables provide a transmission frequency of 1 MHz to 250 MHz, and improve the performance on crosstalk and return loss. A fine better return loss performance is extremely important for new-generation full-duplex high-speed networks. Category-6 cables have sufficient power sum ACR (PS-ACR) when working at 200 MHz. They provide a bandwidth two times than that of category-5 enhanced cables, thus featuring a higher transmission performance. Therefore, category-6 cables are suitable for applications requiring a transmission speed of more than 1 Gbps.

The 10/100 Mbps Ethernet uses two pairs of cables, orange/white, orange, green/white and green cables, to transmit and receive data. The 1000 Mbps Ethernet uses four pairs of cables to transmit and receive data.

For the pinouts of common twisted pair cables, see the following tables. (A and B represent the two ends of a cable.)

Table 230 Straight-through cable pinouts

Pinout No.	A	B
1	Orange/white	Orange/white
2	Orange	Orange
3	Green/white	Green/white
4	Blue	Blue
5	Blue/white	Blue/white
6	Green	Green
7	Brown/white	Brown/white
8	Brown	Brown

Table 231 Crossover cable pinouts

Pinout No.	A	B
1	Orange/white	Green/white
2	Orange	Green
3	Green/white	Orange/white
4	Blue	Blue
5	Blue/white	Blue/white
6	Green	Orange
7	Brown/white	Brown/white
8	Brown	Brown

ⓘ IMPORTANT:

To ensure communication quality, use the pinouts in the above tables when identifying or making the two types of Ethernet cables.

Connecting an Ethernet cable



1. Connect one end of an Ethernet cable to an Ethernet interface on the module and the other end to the Ethernet interface on the peer device. Because the Ethernet interface of the module supports MDI/MDIX auto-sensing, you can use a straight-through cable or crossover cable to connect the interface.
2. Check the status of the LED of the Ethernet interface after power-on. For the status of the LED, see the relevant part in this manual.

Fiber port

Appearances and applicable models of transceiver modules and optical fibers

Optical interfaces must work with SFP transceiver modules and optical fibers with LC connectors.

Table 232 Ethernet cable appearance and applicable models

Product number	Cable	Appearance	Applicable models
JD090A JD091A JD102B JD120B	SFP transceiver module		SIC-1FEF MIM-1POS FIC-1POS FIC-1CPOS HMIM-1POS HMIM-1CPOS MIM-1ATM-OC3 FIC-1ATM-OC3 HMIM-8GSWF SIC-4GSWF
JD100A JD101A	100-Mbps BIDI transceiver module		SIC-1FEF MIM-1POS FIC-1POS FIC-1CPOS HMIM-1POS HMIM-1CPOS MIM-1ATM-OC3 FIC-1ATM-OC3 HMIM-8GSWF SIC-4GSWF
JD118B JD119B JD061A JD062A JD063B JD103A JD098B JD099B	SFP transceiver module		SIC-1GEC FIC-1GEF FIC-2GEF HMIM-8GSWF SIC-4GSWF

Product number	Cable	Appearance	Applicable models
JD098B JD099B	1000-Mbps BIDI transceiver module		SIC-1GEC FIC-1GEF FIC-2GEF HMIM-8GSWF SIC-4GSWF

100-Mbps SFP transceiver module

A 100-Mbps SFP transceiver module uses LC connectors.

Table 233 Specifications for 100-Mbps SFP transceiver modules

Product code	Description	Center wavelength (nm)	Data rate (Mbps)	Fiber mode	Optical fiber diameter (μm)	Transmission distance	Interface specifications (dBm)		
							Output optical power	Receive sensitivity	Optical saturation
JD102B	HPE X115 100M SFP LC FX Transceiver	1310	155	MMF	50/125 62.5/125	2 km (1.24 miles)	-19 to -14	≤ -30	≤ -14
JD120B	HPE X110 100M SFP LC LX Transceiver	1310	155	SMF	9/125	15 km (9.32 miles)	-15 to -8	≤ -28	≤ -7
JD090A	HPE X110 100M SFP LC LH40 Transceiver	1310				40 km (24.86 miles)	-5 to 0	≤ -34	≤ -9
JD091A	HPE X110 100M SFP LC LH80 Transceiver	1550				80 km (49.71 miles)	-5 to 0	≤ -34	≤ -10

100-Mbps BIDI transceiver module

A 100-Mbps BIDI transceiver module uses LC connectors.

Table 234 Specifications for 100-Mbps BIDI transceiver modules

Product code	Description	Center wavelength (nm)	Data rate (Mbps)	Fiber mode	Optical fiber diameter (μm)	Transmission distance	Interface specifications (dBm)		
							Output optical power	Receive sensitivity	Optical saturation

Product code	Description	Center wavelength (nm)	Data rate (Mbps)	Fiber mode	Optical fiber diameter (μm)	Transmission distance	Interface specifications (dBm)		
							Output optical power	Receive sensitivity	Optical saturation
JD100A	HPE X110 100M SFP LC BX 10-U Transceiver	1310 (TX) 1550 (RX)	155	SMF	9/125	15 km (9.32 miles)	-15 to -8	≤ -31	≤ -3
JD101A	HPE X110 100M SFP LC BX 10-D Transceiver	1550 (TX) 1310 (RX)							

1000-Mbps SFP transceiver module

The 1000-Mbps SFP transceiver module uses LC connectors.

Table 235 Specifications for 1000-Mbps SFP transceiver modules

Product code	Description	Center wavelength (nm)	Fiber mode	Optical fiber diameter (μm)	Model bandwidth (MHz*km)	Transmission distance	Interface index (dBm)		
							Output optical power	Receive sensitivity	Optical saturation
JD118B	HPE X120 1G SFP LC SX Transceiver	850	MMF	50/125	500	550 m (180.446 ft)	-9.5 to 0	≤ -17	≤ -3
					400	500 m (164.042 ft)			
			MMF	62.5/125	200	275 m (902.23 ft)			
					160	220 m (721.78 ft)			
JD119B	HPE X120 1G SFP LC LX Transceiver	1310	SMF	9/125	N/A	10 km (6.21 miles)	-9.5 to -3	≤ -19	≤ -3
			MMF	50/125	500	550			

Product code	Description	Center wavelength (nm)	Fiber mode	Optical fiber diameter (μm)	Model bandwidth (MHz*km)	Transmission distance	Interface index (dBm)		
							Output optical power	Receive sensitivity	Optical saturation
					400	m (180 4.46 ft)			
			MMF	62.5/125	500	550 m (180 4.46 ft)			
JD061A	HPE X125 1G SFP LC LH40 1310nm Transceiver	1310	SMF	9/125	N/A	40 km (24.8 6 miles)	-2 to +5	≤ -22	≤ -3
JD062A	HPE X120 1G SFP LC LH40 1550nm Transceiver	1550	SMF	9/125	N/A	40 km (24.8 6 miles)	-4 to +1	≤ -21	≤ -3
JD063B	HPE X125 1G SFP LC LH70 Transceiver	1550	SMF	9/125	N/A	70 km (43.5 0 miles)	-4 to +2	≤ -22	≤ -3
JD103A	HPE X120 1G SFP LC LH100 Transceiver	1550	SMF	9/125	N/A	100 km (62.1 39 miles)	0 to +5	≤ -30	≤ -9
JD098B	HPE X120 1G SFP LC BX 10-U Transceiver	1310(TX) 1490(RX)	SMF	9/125	N/A	10 km (6.21 miles)	-9 to -3	≤ -18.7	≤ -3
JD099B	HPE X120 1G SFP LC BX 10-D Transceiver	1490(TX) 1310(RX)	SMF	9/125	N/A	10 km (6.21 miles)	-9 to -3	≤ -18.7	≤ -3

1000-Mbps BIDI transceiver module

A 1000-Mbps BIDI transceiver module uses LC connectors.

Table 236 Specifications for 1000-Mbps BIDI transceiver modules

Product code	Description	Center wavelength (nm)	Fiber mode	Optical fiber diameter (μm)	Transmission distance	Interface specifications (dBm)		
						Output optical power	Receive sensitivity	Optical saturation
JD098B	HPE X120 1G SFP LC BX 10-U Transceiver	1310 (TX) 1490 (RX)	SMF	9/125	10 km (6.21 miles)	-9 to -3	≤ -18.7	≤ -3
JD099B	HPE X120 1G SFP LC BX 10-D Transceiver	1490 (TX) 1310 (RX)						

Connecting an optical fiber

⚠ CAUTION:

- Never stare into an open optical Ethernet interface, because invisible rays might be emitted from the optical Ethernet interface.
- Cover the dust cover if no optical fiber connector is connected to the optical Ethernet interface.

To connect an optical fiber

1. Insert the SFP/XFP transceiver module to the SFP/XFP interface on the interface module or service module.
2. Identify the Rx and Tx ports on the SFP transceiver.
 - a. Plug the LC connector at one end of one fiber cable into the Rx port of the router and the LC connector at the other end into the Tx port of the peer device.
 - b. Plug the LC connector at one end of another fiber cable into the Tx port of the router and the LC connector at the other end to the Rx port of the peer device.
3. View the LINK LED after connection.
 - If the LED is on, the optical fiber link is present.
 - If the LED is off, no link is present. This might be because the TX and Rx port of the optical fiber are not connected correctly. In this case, connect the optical fiber again.



E1 interface

E1 cable appearance and applicable models

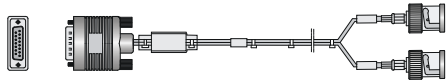
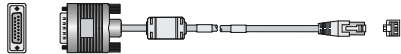
Table 237 E1 cable appearance and applicable models

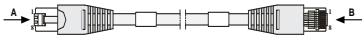
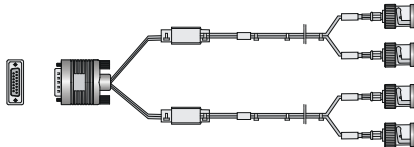
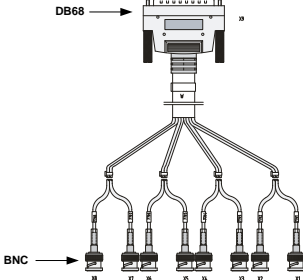
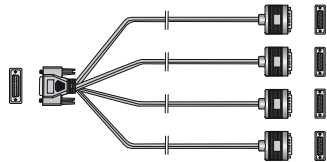
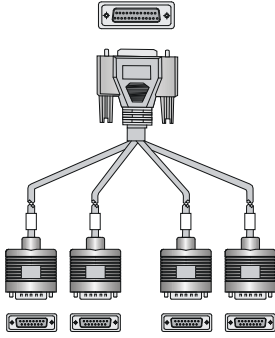
Product number	Description	Cable	Appearance	Applicable models
JD175A JD514A JD516A	HPE X260 E1 2*BNC 75 ohm 3m Router Cable HPE X260 E1 BNC 20m Router Cable HPE X260 E1/2 BNC 75 ohm 40m Router Cable	1-port E1 75-ohm cable	 1 × D15 < ---- > 2 × BNC	SIC-1E1-F SIC-1EPRI MIM-1E1 MIM-1E1-F MIM-2E1 MIM-2E1-F FIC-1E1 FIC-1E1-F FIC-2E1 FIC-2E1-F HMIM-2E1 SIC-1VE1 MIM-1VE1 MIM-2VE1 FIC-1VE1 FIC-2VE1 HMIM-1VE1 HMIM-2VE1
JD509A JD517A	HPE X260 E1 RJ45 3m Router Cable HPE X260 E1 RJ45 20m Router Cable	1-port E1 120-ohm cable	 1 × D15 < ---- > 1 × RJ45	MIM-1E1 MIM-1E1-F MIM-2E1 MIM-2E1-F FIC-1E1 FIC-1E1-F FIC-2E1 FIC-2E1-F HMIM-2E1 SIC-1VE1 MIM-1VE1 MIM-2VE1 FIC-1VE1 FIC-2VE1 HMIM-1VE1 HMIM-2VE1

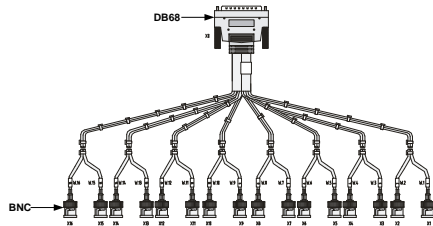
Product number	Description	Cable	Appearance	Applicable models
JC156A JC151A JC152A	HPE X260 E1 RJ45 120 ohm 2m Router Cable HPE X260 E1 RJ45 120 ohm 15m Router Cable HPE X260 E1 RJ45 120 ohm 30m Router Cable	1-port E1 120-ohm cable (2m,15m,30m) -RJ45	 <p>1 × RJ45 < ---- > 1 × RJ45</p>	HMIM-8E1T1 HMIM-8E1T1-F SIC-1VE1T1
JD643A	HPE X260 2E1 BNC 3m Router Cable	2-port E1 75-ohm cable	 <p>1 × D15 < ---- > 4 × BNC</p>	SIC-2E1-F
JD638A	HPE X260 E1 4-Port IMA Router Cable	4-port E1 75-ohm cable	 <p>1 × D68 < ---- > 8 × BNC</p>	MIM-IMA-4E1 FIC-IMA-4E1
-		4-port E1 75-ohm cable	 <p>1 × D25 < ---- > 4 × D15</p>	MIM-4E1 MIM-4E1-F FIC-4E1 FIC-4E1-F HMIM-4E1 HMIM-4E1-F
-		4-port E1 120-ohm cable	 <p>1 × D25 < ---- > 4 × D15</p>	MIM-4E1 MIM-4E1-F FIC-4E1 FIC-4E1-F HMIM-4E1 HMIM-4E1-F

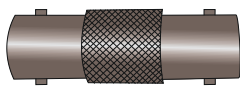
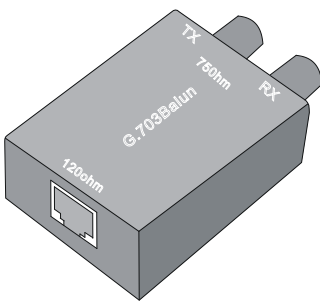
Product number	Description	Cable	Appearance	Applicable models
JD512A JD927A	HPE X260 8E1 BNC 75 ohm 3m Router Cable HPE CAB-75ohm 8E1-3m-BNC-IMA	8-port E1 75-ohm cable	 <p>1 x D68 < ---- > 16 x BNC</p>	MIM-8E1 MIM-8E1-F MIM-IMA-8E1 FIC-8E1 FIC-8E1-F FIC-IMA-8E1 HMIM-8E1
JH294A	HPE X260 E1 RJ45 to 2xBNC 75ohm 3m Router Cable	1-port E1 75-ohm RJ-45 cable		HMIM-8E1T1 HMIM-8E1T1-F SIC-1VE1T1
-		75-ohm adapter cable	 <p>1 x BNC < ---- > 1 x BNC</p>	Use as needed
-		Coaxial connector	 <p>1 x BNC < ---- > 1 x BNC</p>	Use as needed
JD511A	HPE X260 E1 RJ45 BNC 75-120 ohm Conversion Router Cable	Impedance converter	 <p>2 x BNC < ---- > 1 x RJ45</p>	Use as needed

Dual inline package switch

E1/E1-F/VE1 interface module provides a dual inline package (DIP) switch. The DIP switch setting defines the interface impedance and the grounding method.

Table 238 DIP switch-to-interface map

DIP switch	E1 interface	Applicable models
S1	Interface 0	MIM-2E1 MIM-4E1 MIM-4E1-F FIC-2E1 FIC-4E1 FIC-4E1-F HMIM-2E1 HMIM-4E1 HMIM-4E1-F SIC-1VE1 MIM-1VE1 MIM-2VE1 FIC-1VE1 FIC-2VE1 HMIM-1VE1 HMIM-2VE1
S2	Interface1	MIM-2E1 MIM-4E1 MIM-4E1-F FIC-2E1 FIC-4E1 FIC-4E1-F HMIM-2E1 HMIM-4E1 HMIM-4E1-F MIM-2VE1 FIC-2VE1 HMIM-2VE1
S3	Interface2	MIM-4E1 MIM-4E1-F FIC-4E1-F HMIM-4E1 HMIM-4E1-F
S4	Interface3	MIM-4E1 MIM-4E1-F FIC-4E1-F HMIM-4E1 HMIM-4E1-F

By default, all DIP switches are On, and the E1 interface impedance is 70 ohms, as shown in the following figure:

Figure 161 Default DIP switch settings

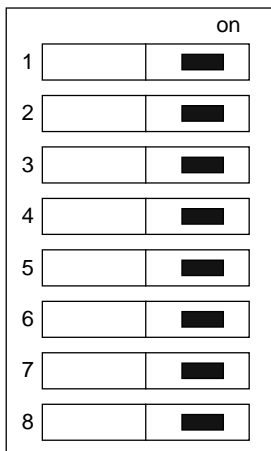

As a best practice, use the DIP switch as follows:

- When the interface is connected to a 70-ohm cable, turn on switches BIT1 through 8.
- When the interface is connected to a 120-ohm cable, turn off switches BIT1 through 8.

DIP switch settings descriptions are shown in the following table:

Table 239 Description for DIP switch settings

DIP	Description	Configuration of 75-ohm impedance	Configuration of 120-ohm impedance
1BIT	75-ohm/120-ohm selection switch	On	Off
2BIT		On	Off
3BIT		On	Off
4BIT		On	Off
5BIT		On	Off
6BIT	RxRing grounding mode selection switch	Off: RxRing is grounded via capacitance. On: RxRing is grounded directly.	—
7BIT	RxShield grounding mode selection switch	—	On: RxShield is grounded. Off: RxShield is not grounded.
8BIT	SxShield grounding mode selection switch	—	Off: RxShield is grounded via capacitance On: RxShield is grounded directly.

Connecting a 1/2/4/8-port E1 75-ohm cable (D15/D68 <----> BNC)

△ CAUTION:

Make sure you insert the cable into the right interface so as to avoid damages to the interface module or the chassis.

To connect the BNC connectors of the E1 75-ohm cable to the remote network device:

1. Connect the D15/D68 connector of the E1 75-ohm cable to the D15/D68 interface of the interface module and fasten the bolts to fix the cable.
2. The other end of the cable provides one pair or multiple pairs of 75-ohm BNC connectors. Connect the TX connectors and the RX connectors on this end to the RX connectors and the TX connectors on the remote device, respectively.

Figure 162 Connecting an E1 75-ohm cable

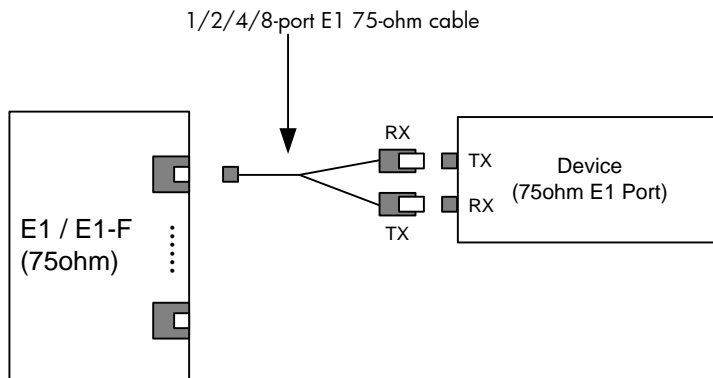

To extend the cable:

1. Connect each BNC connector of the E1 75-ohm cable to one end of a coaxial connector.
2. Connect the remote device to the other end of the coaxial connector through an E1 75-ohm trunk cable.

Figure 163 Connecting an E1 75-ohm cable

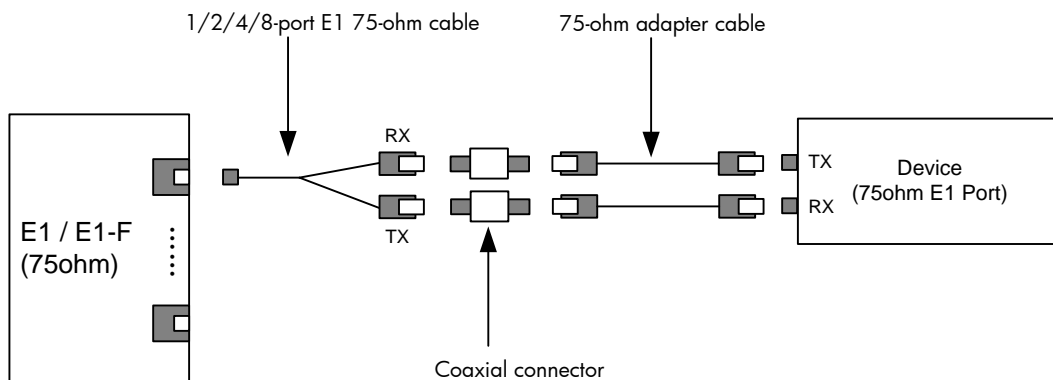

If the impedance of the E1 interface on the remote device is 120 ohms, you must use an impedance converter to adapt the impedance.

Figure 164 Connecting an impedance converter

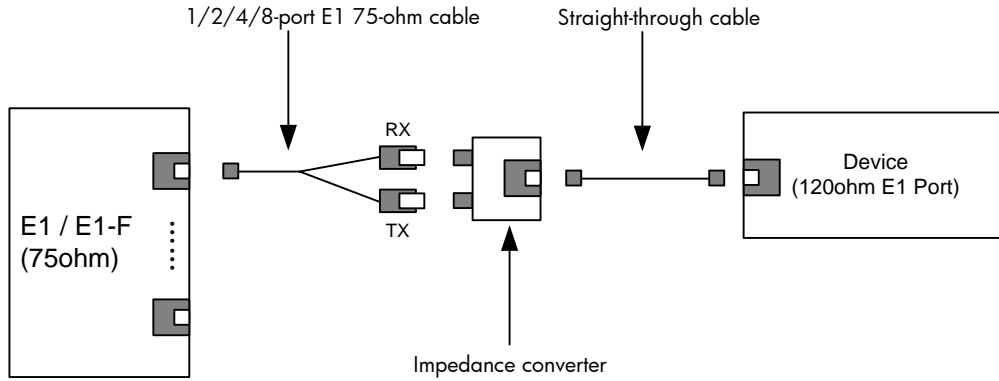

Connecting a 4-port E1 75-ohm cable (D25 <----> D15)

1. Connect the D25 connector of the 4-port E1 75-ohm cable to the D25 interface of the interface module and fasten the bolts to fix the cable.
2. The other end of the cable provides four D15 connectors. Connect them to the D15 interfaces on the remote device as needed.

Figure 165 Connecting an 4-port E1 75-ohm cable

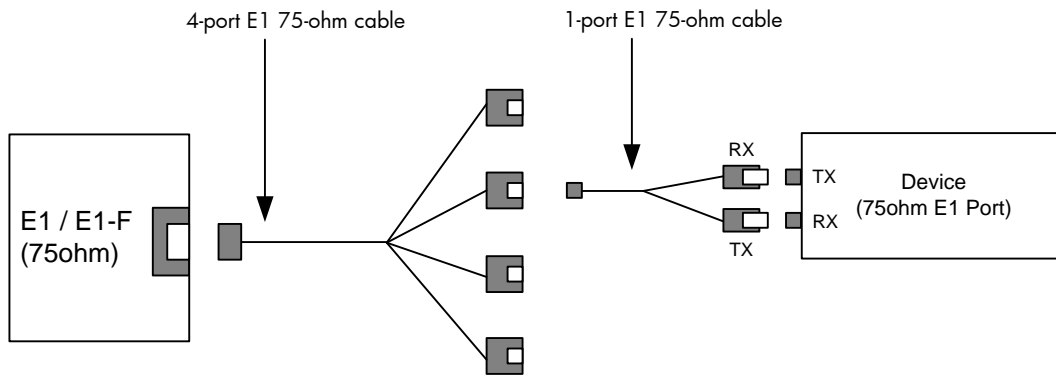

Connecting a 1-port E1 120-ohm cable (D15 <----> RJ45)

1. Connect the D15 connector of the E1 120-ohm cable to the D15 interface on the interface module and fasten the bolts to fix the cable.
2. The other end of the cable provides one or multiple RJ45 connectors. Connect them to the RJ45 interface on the remote device as needed.

Figure 166 Connecting an E1 120-ohm cable

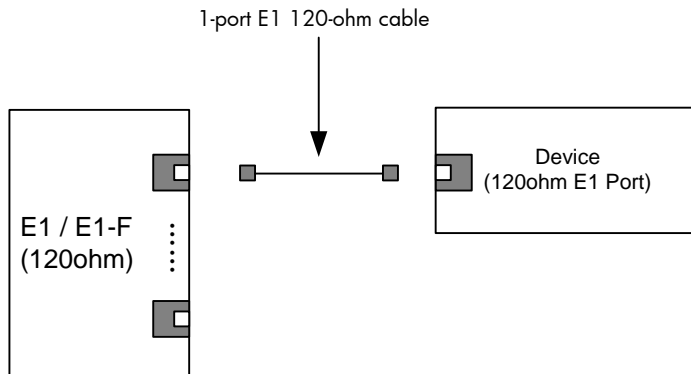

Connecting a 4-port E1 120-ohm cable (D25 <----> D15)

1. Connect the D25 connector of the 4-port E1 120-ohm cable to the D25 interface on the interface module and fasten the bolts to fix the cable.
2. The other end of the cable provides four D15 connectors. Connect them to the D15 interface on the remote device as needed.

Figure 167 Connecting an 4-port E1 120-ohm cable

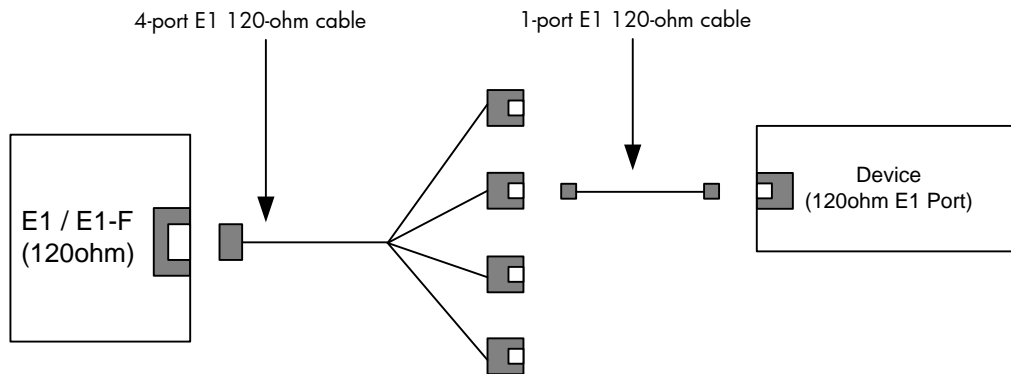

T1 interface

△ CAUTION:

To avoid damages to the interface module or the chassis, make sure you insert the cable into the correct interface.

T1 cable appearance and applicable models

Table 240 T1 cable appearance and applicable models

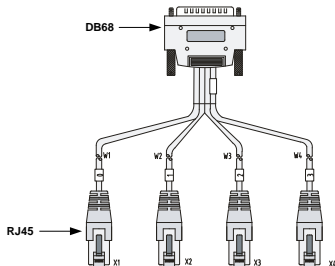
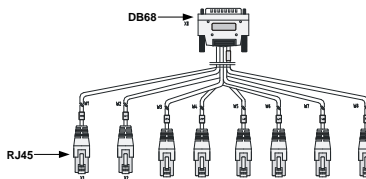
Product number	Description	Cable	Appearance	Applicable models
JD518 A	HPE X260 T1 Router Cable	1-port T1 cable (100-ohm standard shielded cable)	 <p>1 × RJ45 < ---- > 1 × RJ45</p>	SIC-1T1-F MIM-2T1 MIM-2T1-F MIM-4T1-F FIC-1T1 FIC-1T1-F FIC-2T1 FIC-2T1-F FIC-4T1 FIC-4T1-F HMIM-2T1 HMIM-4T1-F SIC-1VE1T1 SIC-1VE1T1 SIC-1VT1 MIM-1VT1 MIM-2VT1 FIC-1VT1 FIC-2VT1 HMIM-1VT1 HMIM-2VT1 HMIM-8E1T1 HMIM-8E1T1-F
JD640 A	HPE X260 T1 4-Port IMA Router Cable	4-port T1 cable	 <p>1 × D68 < ---- > 4 × RJ45</p>	MIM-IMA-4T1 FIC-IMA-4T1
JD639 A	HPE X260 8T1 RJ45 3m Router Cable	8-port T1 cable	 <p>1 × D68 < ---- > 8 × RJ45</p>	MIM-8T1 MIM-8T1-F FIC-8T1 FIC-8T1-F FIC-IMA-8T1

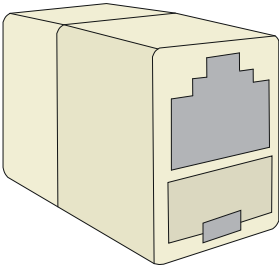
Product number	Description	Cable	Appearance	Applicable models
-		RJ45 connector	 1 x RJ45 < ---- > 1 x RJ45	Use as needed

Connecting a 1-port T1 cable

The two ends of the 1-port T1 cable are RJ45 connectors. Connect one end of the cable to the T1 connector (RJ45) of the interface module and the other end of the cable to the T1 connector (RJ45) on the remote device.

Connecting a 4/8-port T1 cable

1. Connect the D68 connector of the 4/8-port T1 cable to the D68 interface on the interface module and fasten the bolts to secure the cable.
2. Connect the other end to the RJ45 interface on the remote device as needed.

E3/T3 interface

E3/T3 cable appearance and applicable models

Table 241 E3/T3 cable appearance and applicable models

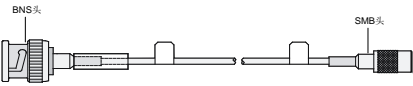
Product number	Description	Cable	Appearance	Applicable models
JD531A JD533A	HPE X260 T3/E3 Router Cable HPE X260 E3-30 E3/T3 Router Cable	E3/T3 interface cable	 1 x BNS < ---- > 1 x SMB	MIM-1CE3 MIM-1CT3 FIC-1CE3 FIC-1CT3 FIC-1AE3 FIC-1AT3 HMIM-1CE3 HMIM-1CT3 HMIM-1E3T3

Connecting the cable

1. Connect the SMB connector on one end of an E3/T3 cable to the Tx port on the interface module and the other end of the cable to the Rx port on the device to be connected.
2. Connect the SMB connector of another E3/T3 cable to the Rx port on the interface module and the other end of the cable to the Tx port on the device to be connected;
3. Check the LINK LED on the module panel. It is off when a fault has occurred on the link and the signal is out of synchronization. In this case, check the link.

Synchronous/asynchronous serial ports

Appearance and applicable models of synchronous/asynchronous serial port cables

Table 242 Appearance and applicable models of synchronous/asynchronous serial port cables

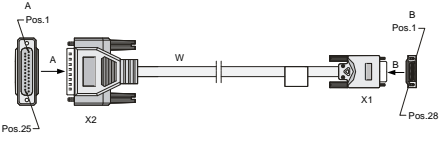
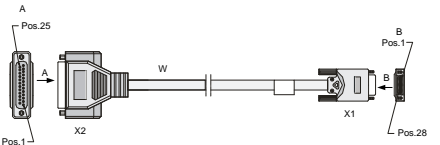
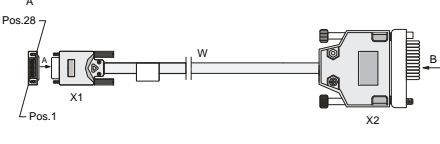
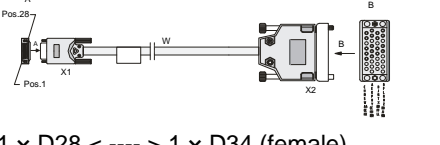
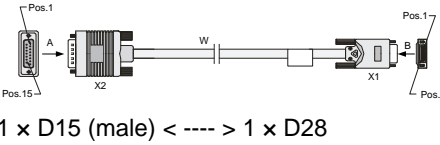
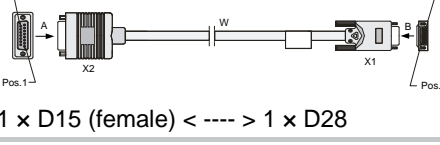
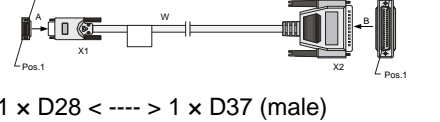
Product number	Description	Cable	Appearance	Applicable models
JD519A	HPE X200 V.24 DTE 3m Serial Port Cable	V.24 DTE cable	 <p>1 x D25 (male) < ---- > 1 x D28</p>	
JD521A	HPE X200 V.24 DCE 3m Serial Port Cable	V.24 DCE cable	 <p>1 x D25 (female) < ---- > 1 x D28</p>	
JD523A	HPE X200 V.35 DTE 3m Serial Port Cable	V.35 DTE cable	 <p>1 x D28 < ---- > 1 x D34 (male)</p>	SIC-1SAE SIC-2SAE SIC-4SAE MIM-2SAE MIM-4SAE MIM-8SAE FIC-2SAE FIC-4SAE FIC-8SAE
JD525A	HPE X200 V.35 DCE 3m Serial Port Cable	V.35 DCE cable	 <p>1 x D28 < ---- > 1 x D34 (female)</p>	HMIM-4SAE HMIM-8SAE
JD527A	HPE X200 X.21 DTE 3m Serial Port Cable	X.21 DTE cable	 <p>1 x D15 (male) < ---- > 1 x D28</p>	
JD529A	HPE X200 X.21 DCE 3m Serial Port Cable	X.21 DCE cable	 <p>1 x D15 (female) < ---- > 1 x D28</p>	
JF825A	HPE X260 RS449 3m DTE Serial Port Cable	RS-449 DTE cable	 <p>1 x D28 < ---- > 1 x D37 (male)</p>	

Product number	Description	Cable	Appearance	Applicable models
JF826A	HPE X260 RS449 3m DCE Serial Port Cable	RS-449 DCE cable	<p>1 x D28 < ---- > 1 x D37 (female)</p>	
JF827A	HPE X260 RS530 3m DTE Serial Port Cable	RS-530 DTE cable	<p>1 x D25 (male) < ---- > 1 x D28</p>	
JF828A	HPE X260 RS530 3m DCE Serial Port Cable	RS-530 DCE cable	<p>1 x D25 (female) < ---- > 1 x D28</p>	

Connecting the cable



1. Check the port type of the peer device and choose the correct synchronous serial interface cable.
2. Plug the D28 end of the synchronous serial interface cable into the D28 interface of the SAE interface module.
3. If the WAN uses a DDN line, connect the cable to the port of the CSU/DSU.
4. Check the LINK LED on the SAE panel.
 - If the LED is on, a link is present.
 - If the LED is off, a fault has occurred on the link and signal is out of synchronization. In this case, check the link.

Asynchronous serial ports

Appearance and applicable models of asynchronous serial port cables

Table 243 Appearance and applicable models of asynchronous serial port cables

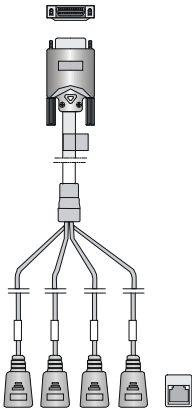
Product number	Description	Cable	Appearance	Applicable models
JD642A	HPE X260 SIC-8AS RJ45 0.28m Router Cable	8-port asynchronous serial port adapter cable	<p>1 x D60 < ---- > 8 x RJ45 (female)</p>	SIC-8AS

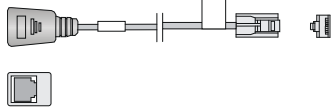
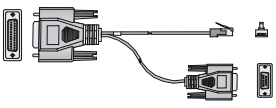
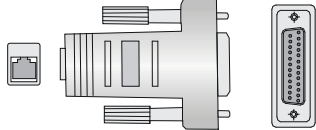
Product number	Description	Cable	Appearance	Applicable models
JG263A	HPE X260 mini D-28 to 4-RJ45 0.3m Router Cable	4-port asynchronous serial port adapter cable	 <p>1 x D28 < ---- > 4 x RJ45 (female)</p>	SIC-16AS
-		Straight-through cable	 <p>1 x RJ45 < ---- > 1 x RJ45</p>	MIM-8ASE MIM-16ASE FIC-8ASE FIC-16ASE HMIM-16ASE
JD641A	HPE X260 Transit RJ45 0.5m Single Cable	Dumb terminal adapter cable	 <p>1 x RJ45 (female) < ---- > 1 x RJ45 (male)</p>	MIM-8ASE MIM-16ASE FIC-8ASE FIC-16ASE HMIM-16ASE
JD508A	HPE X260 Auxiliary Router Cable	AUX cable	 <p>1 x D25 & 1 x D9 < ---- > 1 x RJ45</p>	MIM-8ASE MIM-16ASE FIC-8ASE FIC-16ASE HMIM-16ASE
JD636A	HPE X200 Transit Plug D25F Single Cable	Dumb terminal adapter	 <p>1 x D25 < ---- > 1 x RJ45</p>	MIM-8ASE MIM-16ASE FIC-8ASE FIC-16ASE HMIM-16ASE

Connecting a SIC-8AS/SIC-16AS interface module

- To connect the SIC-8AS interface module, connect the D60 connector of the 8-port asynchronous serial port adapter cable to the SIC-8AS interface module.
- To connect the SIC-16AS interface module, connect the D28 connector of the 4-port asynchronous serial port adapter cable to the SIC-16AS interface module, which allows up to four such cables.

Choose the cable connection type according to the remote device type:

- If the remote device connector is a RJ45 connector, connect it to the RJ45 interface of the asynchronous serial port adapter cable by a straight-through cable. The sequence is shown in the following figure:

Figure 168 Connecting a telecommunication device

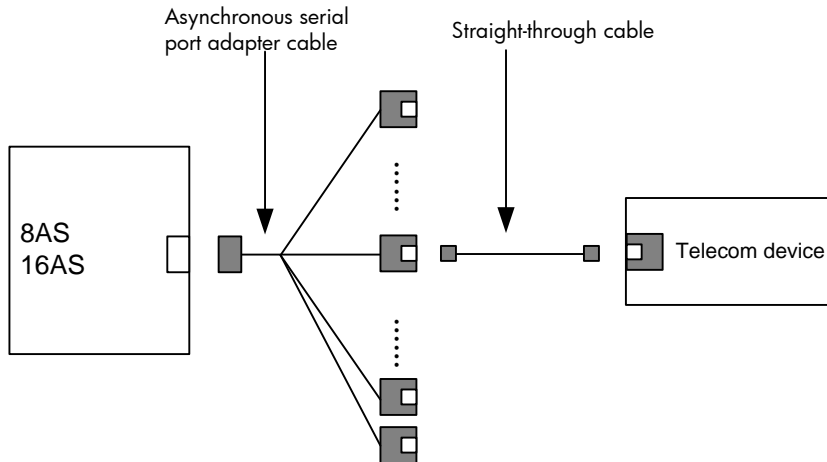

- If the remote device is a bank dumb terminal device:
- Connect the RJ45 connector (male) on one end of the dumb terminal cable to the RJ45 interface on the asynchronous serial port adapter cable.
- Connect the RJ45 connector (female) on the other end of the dumb terminal cable to the RJ45 interface on one end of the dumb terminal adapter by a straight-through cable.
- The other end of the dumb terminal adapter is a D25 interface and can be connected to the bank dumb terminal device. The sequence is shown in the following figure:

Figure 169 Connecting the dumb terminal device

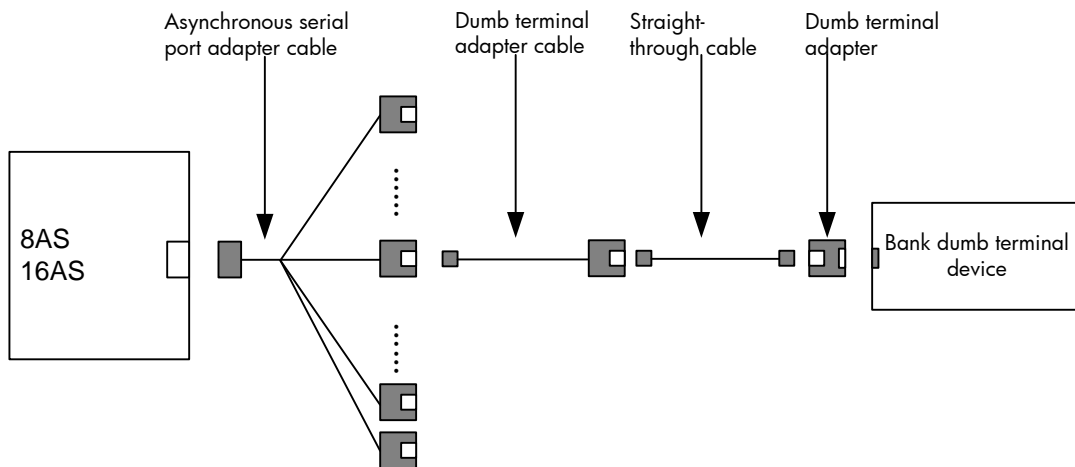

- If the interface of the remote device is a D25/D9 interface, use the AUX cable to connect the asynchronous serial port adapter cable to the interface:

Figure 170 Connecting a modem

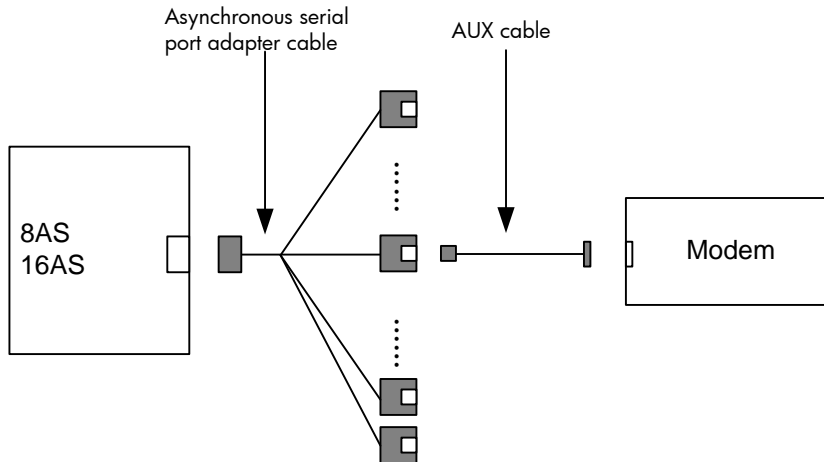

Connecting a MIM-8ASE/MIM-16ASE/FIC-8ASE/FIC-16ASE interface module

CAUTION:

- To avoid damage to the device and the ports, do not plug or unplug the MIM-8ASE/MIM-16ASE module interface cable when the router is powered on.
- To avoid damages to the interface module or the chassis, make sure you insert the cable into the right interface.

Choose the cable connection type according to the remote device type:

- If the remote device is a telecommunications device with an RJ45 interface, connect it with the RJ45 interface of the MIM-8ASE/MIM-16ASE/FIC-8ASE/FIC-16ASE interface module by a straight-through cable. The sequence is shown in the following figure:

Figure 171 Connecting a telecommunications device

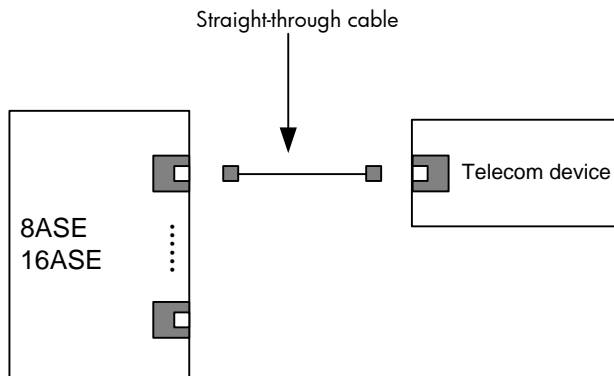

- If the remote device is a bank dumb terminal device, connect the RJ45 connector (male) on one end of the dumb terminal cable to the RJ45 interface on the MIM-8ASE/MIM-16ASE/FIC-8ASE/FIC-16ASE interface module. Connect the RJ45 connector (female) on the other end of the dumb terminal cable to the RJ45 interface on one end of the dumb terminal adapter by a straight-through cable. The other end of the dumb terminal adapter is a D25 interface and can be connected to the bank dumb terminal device. The sequence is shown in the following figure:

Figure 172 Connecting a bank dumb terminal device

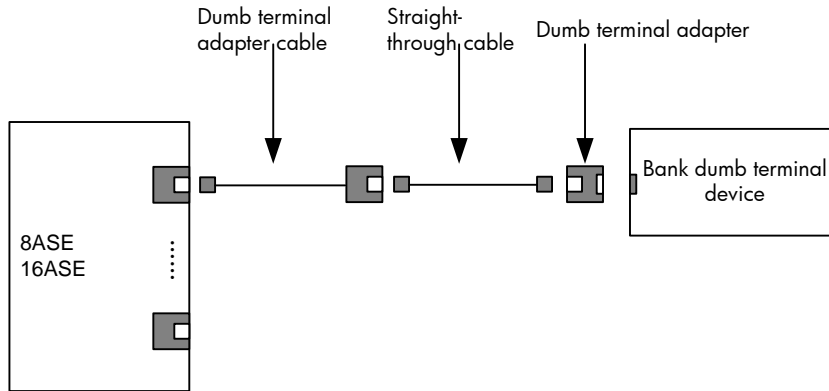

- If the interface of the remote device is a D25/D9 interface, use the AUX cable to connect the RJ45 interface on the MIM-8ASE/MIM-16ASE/FIC-8ASE/FIC-16ASE interface module. The sequence is shown in the following figure:

Figure 173 Connecting a modem

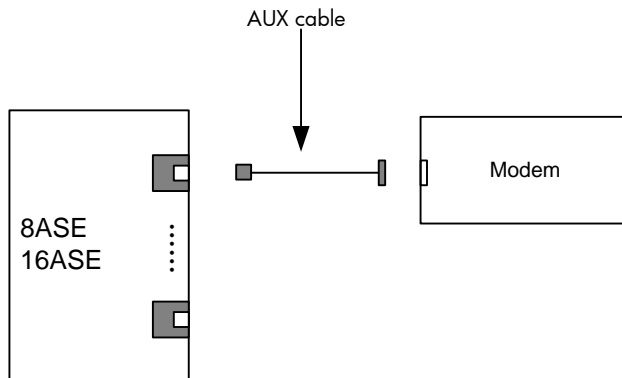

ADSL/BS/FXS/FXO/AM/FCM interface

Appearance and applicable models of the magnetic-core telephone cable

Table 244 Appearance and applicable models of magnetic-core telephone cable

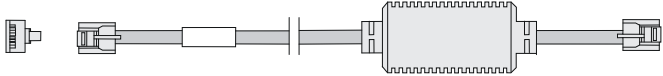
Cable	Appearance	Applicable models
Magnetic-core telephone cable	 <p data-bbox="501 886 778 914">1 × RJ11 < ---- > 1 × RJ11</p>	SIC-1ADSL SIC-1ADSL-I SIC-1BS SIC-1FXS SIC-1FXO SIC-2FXS SIC-2FXO SIC-2FXS1FXO DSIC-4FXS1FXO MIM-2FXS MIM-2FXO MIM-4FXS MIM-4FXO MIM-16FXS FIC-2FXS FIC-2FXO FIC-4FXS FIC-4FXO HMIM-4FXS HMIM-4FXO HMIM-16FXS

Connecting a ADSL/FXS/FXO interface module

1. Connect one end of the magnetic-core telephone cable to the RJ11 or RJ45 interface of the interface module.
2. Connect the other end of the magnetic-core telephone cable to the remote device interface.

Connecting a SIC-1BS interface module cable

1. If the service provider provides an ISDN U interface cable, you must use an NT1 device for adaptation.
 - a. Connect one end of the magnetic-core telephone cable to the RJ45 interface of the SIC-1BS interface module.
 - b. Connect the other end of the magnetic-core telephone cable to the S/T interface of the NT1 device.
 - c. Connect the ISDN U interface cable to the U interface on the NT1 device.

Figure 174 Connecting the U interface cable to the SIC-1BS interface module

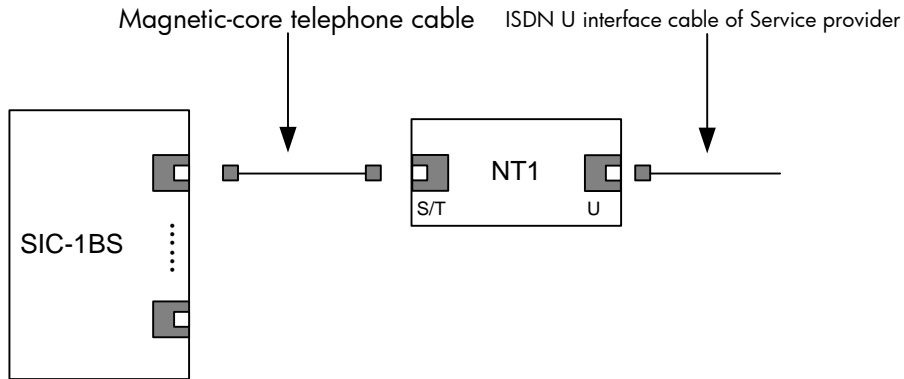

2. If the service provider provides an ISDN S/T interface cable, directly connect the cable to the RJ45 interface of the SIC-1BS interface module.

Figure 175 Connecting the S/T interface cable to the SIC-1BS interface module

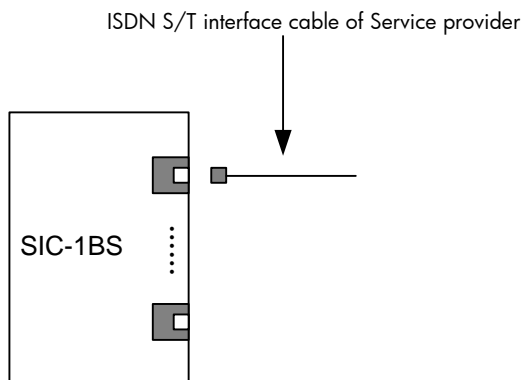

E&M interface

E&M interface appearance and the applicable model

MIM-4E&M/FIC-4E&M modules support Bell I, II, III, V switches, and 2-wire & 4-wire voice signals.

As a best practice, use Bell V 4-wire voice signal to communicate with the router.

The sequence of E&M RJ-45 pins is shown in the following figure, numbered 1 to 8 in order from PIN1:

Figure 176 Sequence of RJ-45 pins

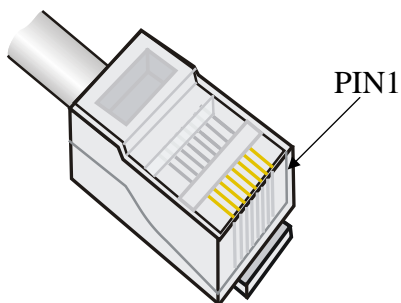

Table 245 Pinouts of E&M interface cable (Bell V 4-wire)

E&M interface		
RJ-45 Pin	Signal	Signal direction
1	—	—
2	E	IN
3	RING0	IN
4	RING1	OUT
5	TIP1	OUT
6	TIP0	IN
7	M	OUT
8	SG	Ground

NOTE:

The 4E&M modules cannot determine the interface types (Bell I/II/III/V), cable types (2-wire or 4-wire), and pinouts (E/M/Tx/Rx) of the peer switch. You must prepare the interface cables of the 4E&M modules according to the on-site conditions. To ensure the EMC of the router, install a ferrite core near the connector of the E&M module interface cable at the router side.

Connecting the cable

1. Connect one end of the magnetic-core telephone cable to the RJ11 or RJ45 interface of the interface module.
2. Connect the other end of the magnetic-core telephone cable to the remote device interface.

24FXS interface

24FXS interface cable appearance and the applicable model

Table 246 24FXS interface cable appearance and the applicable model

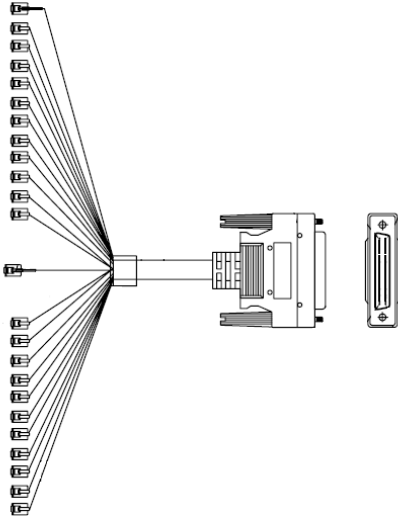
Product number	Description	Cable	Appearance	Applicable models
JG318A	HPE A-MSR 50 pin D-sub Male to 24 x RJ-11 Plug 15m Router Cable	24FXS interface cable	 <p>24 x RJ11 < ---- > 1 x D50</p>	FIC-24FXS

Connecting the cable

1. Connect the D50 interface (male) of the 24FXS interface cable to the FIC-24FXS interface module.
2. Connect the other end of the 24FXS interface cable to the RJ11 interface on the remote device.

BSV/BSE interface

BSV/BSE interface cable appearance and applicable models

Table 247 BSV/BSE interface cable appearance and applicable models

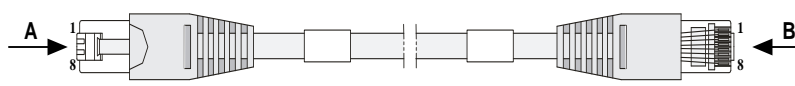
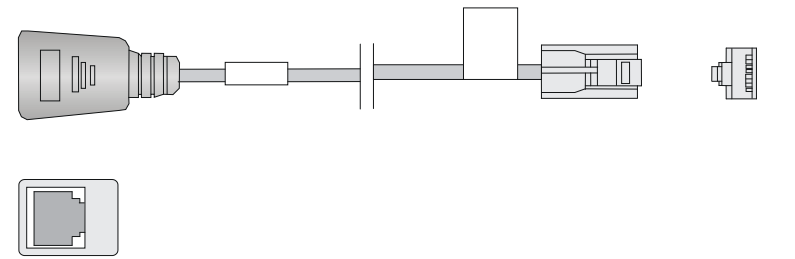
Cable	Appearance	Applicable models
ISDN S/T interface standard cable	 <p>1 x RJ45 < ---- > 1 x RJ45</p>	SIC-1BSV SIC-2BSV MIM-4BSV FIC-4BSE
ISDN S/T interface crossover cable	 <p>1 x RJ45 (female) < ---- > 1 x RJ45 (male)</p>	SIC-1BSV SIC-2BSV MIM-4BSV

Connecting a SIC-1BSV/SIC-2BSV/MIM-4BSV interface module cable

BSV interface supports the User and Network working modes. The BSV interface operates in User mode when connecting to an ISDN network, or operates in Network mode when connecting to TE devices such as the digital telephones or the BSV interfaces operating in User mode.

Choose the cable connection type according to the working mode:

- When the BSV interface operates in User mode, choose the connection method according to the type of the cable provided by the service provider:
 - If the service provider provides an ISDN U interface cable, you must use an NT1 device for adaptation.
 - a. Connect one end of the standard ISDN S/T interface cable to the RJ45 interface of the BSV interface module.
 - b. Connect the other end of the standard ISDN S/T interface cable to the S/T interface of the NT1 device.
 - c. Connect the ISDN U interface cable to the U interface on the NT1 device.

Figure 177 Connecting a service provider U interface cable to a BSV interface module

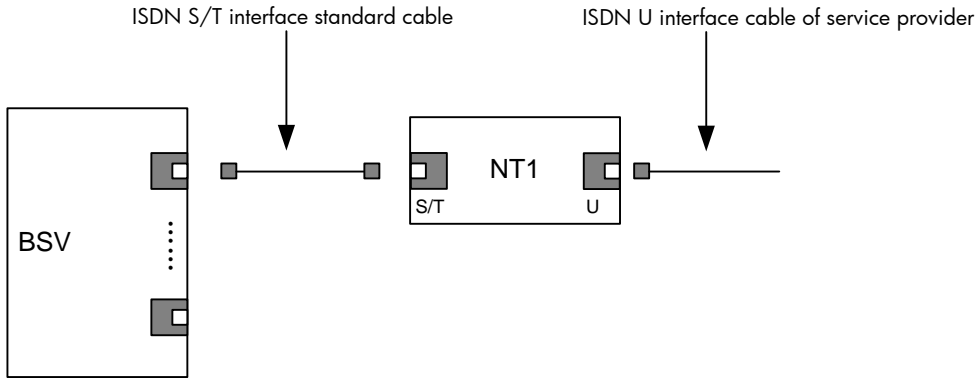

- If the service provider provides an ISDN S/T interface cable, directly connect the service provider cable to the BSV interface.

Figure 178 Connecting a service provider S/T interface cable to a BSV interface module

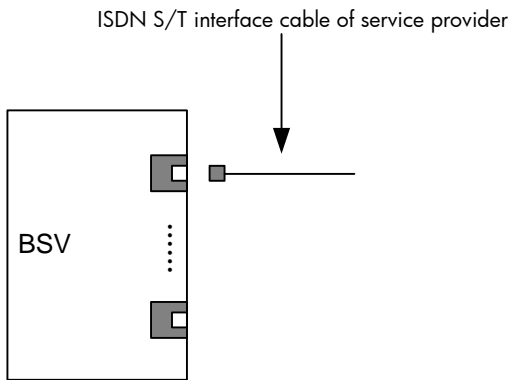

- When the BSV interface operates in Network mode, you must use an ISDN S/T interface crossover cable to connect the BSV interface to a TE device. For example, a digital telephone or a BSV interface operating in User mode.
 - a. Connect the RJ45 connector (male) of the ISDN S/T interface crossover cable to the RJ45 interface on the BSV interface module.
 - b. Connect the RJ45 interface (female) of the standard ISDN S/T interface cable to one end of the standard ISDN S/T interface cable.
 - c. Connect the S/T interface on the TE device to the other end of the standard ISDN S/T interface cable.

Figure 179 Connecting a TE device to a BSV interface module

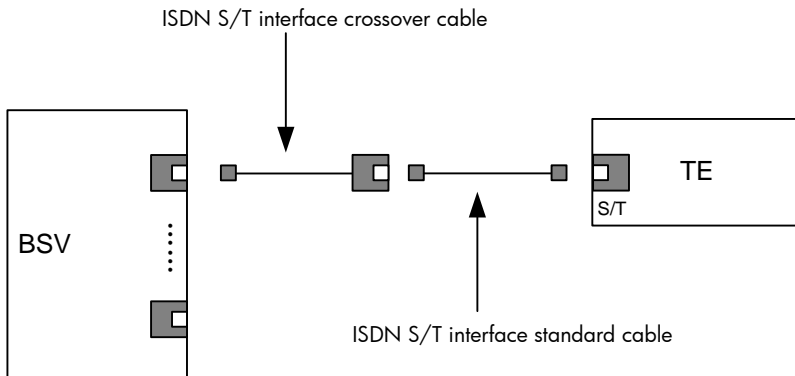

Connecting a FIC-4BSE interface module cable

Choose the cable connection type according to the service provider line type:

- If the service provider provides an ISDN U interface cable, you must use an NT1 device for adaptation.
 - a. Connect one end of the standard ISDN S/T interface cable to the RJ45 interface of the BSE interface module.
 - b. Connect the other end of the standard ISDN S/T interface cable to the S/T interface of the NT1 device.
 - c. Connect the ISDN U interface cable to the U interface on the NT1 device.

Figure 180 Connecting a service provider U interface cable to a BSE interface module

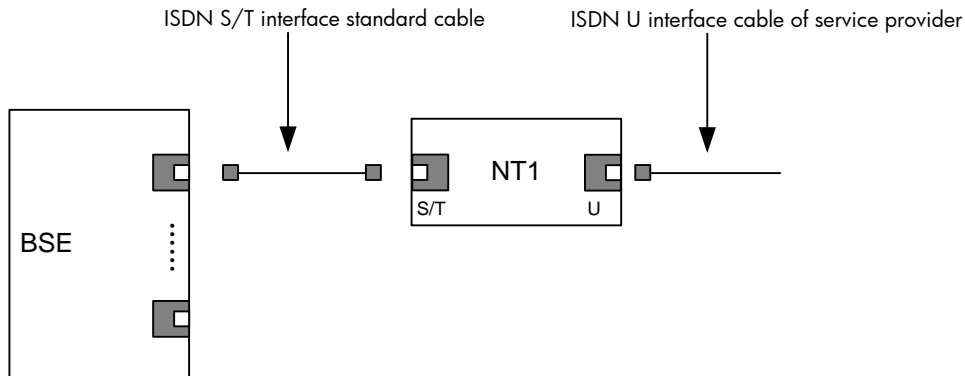

- If the service provider provides an ISDN S/T interface cable, directly connect the service provider cable to the RJ45 interface on the BSE interface module.

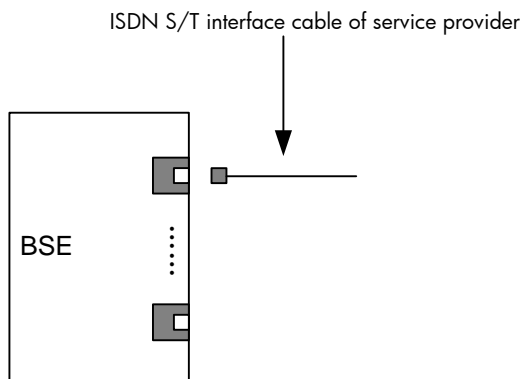
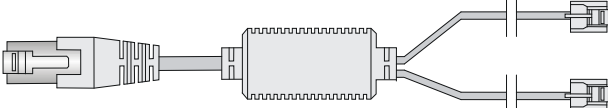
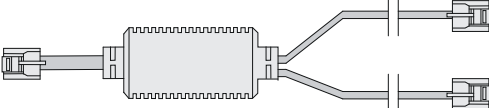

Figure 181 Connecting a service provider S/T interface cable to a BSE interface module



G.SHDSL interface

Appearance and applicable models of the G.SHDSL interface adapter cable

Table 248 Appearance and applicable models of the G.SHDSL interface adapter cable

Cable	Appearance	Applicable models
8-wire G.SHDSL interface cable	 <p>1 x RJ45 (8 wires) < ---- > 2 x RJ11 (4 wire)</p>	DSIC-1SHDSL-8W
4-wire Y type G.SHDSL interface cable	 <p>1 x RJ11 (4 wire) < ---- > 2 x RJ11 (2 wire)</p>	MIM-1SHL-4W
4-wire I type G.SHDSL interface cable	 <p>1 x RJ11 (4 wire) < ---- > 1 No RJ11 (4 wire)</p>	MIM-1SHL-4W

Connecting a DSIC-1SHDSL-8W interface module cable

1. Connect the RJ45 connector on one end of the 8-wire G.SHDSL interface cable to the RJ45 interface on the DSIC-1SHDSL-8W interface module
2. The other end of the cable provides two RJ11 connectors. They can be connected to two 4-core telephone cable.

Use correct wire pairs when the DSIC-1SHDSL-8W interface module cable is operating in different modes:

- When the interface module cable is operating in dual-wire mode, use Line 0.
- When the interface module cable is operating in four-wire mode, use Line 0 and Line 1.
- When the interface module cable is operating in six-wire mode, use Line 0, Line 1, and Line 2.

The sequence of the RJ-45 connector pins is shown in [Figure 174](#), numbered 1 to 8 in order from PIN1.

Figure 182 Sequence of RJ-45 pins

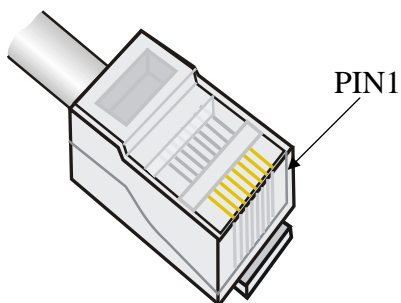

Table 249 Pinouts of DSIC-1SHDSL-8W interface module cable

Pin	Line	Signal
1	1	Ring
2	1	Tip
3	2	Ring
4	0	Ring
5	0	Tip
6	2	Tip
7	3	Ring
8	3	Tip

Connecting a MIM-1SHL-4W interface module cable

One end of the cable provides one RJ11 connector, the other end of the cable provides two RJ11 connectors that can be connected to two 2-core telephone cables.

To connect the 4-wire Y type G.SHDSL interface cable:

1. Connect the end with only one RJ11 connector of the cable to RJ11 interface on the MIM-1SHL-4W interface module
 2. Connect the other end of the cable to the network device.
- Connect the 4-wire I type G.SHDSL interface cable as follows:

Each end of the cable provides one RJ11 connector that can be connected to one 4-core telephone cable.

1. Connect one end of the cable to the RJ11 interface on the MIM-1SHL-4W interface module.
2. Connect the other end of the cable to the network device.

Use correct wire pairs when the MIM-1SHL-4W interface module cable is operating in different modes:

- When the interface module cable is operating in dual-wire mode, use Line 0.
- When the interface module cable is operating in four-wire mode, use Line 0 and Line 1.

Table 250 Pinouts of the MIM-1SHL-4W interface module cable

Pin	Line	Signal
1	1	Tip
2	0	Tip
3	0	Ring
4	1	Ring

WLAN interface

Appearance and applicable models of the WLAN interface module antenna

Table 251 Appearance and applicable models of the WLAN interface module antenna

Cable	Appearance	Applicable models
WLAN interface module antenna		SIC-WLAN-b/g/n SIC-WLAN-b/g/n(NA)

Connecting a WLAN interface module antenna

1. To install an antenna, adjust the angle of the antenna to 180°.
2. Fasten the antenna onto the antenna connector on the interface module. Avoid over-tightening. Make sure the antenna is vertical to the ground or ceiling to achieve the optimal coverage.

3G interface

Appearance and applicable models of the SIC-3G-GSM/SIC-3G-HSPA / SIC-3G-HSPA+ interface module antenna

Table 252 Appearance and applicable models of the SIC-3G-GSM/SIC-3G-HSPA / SIC-3G-HSPA+ interface module antenna

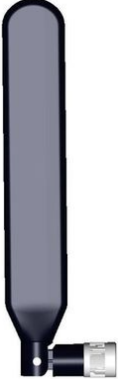
Product number	Description	Cable	Appearance	Applicable models
-		SIC-3G-GSM/SIC-3G-HSPA / SIC-3G-HSPA+ interface module antenna		SIC-3G-GSM SIC-3G-HSPA SIC-3G-HSPA+

Product number	Description	Cable	Appearance	Applicable models
JD508A	HPE X260 Auxiliary Router Cable	AUX cable	 1 x D25 & 1 x D9 < ---- > 1 x RJ45	

Table 253 Detailed specifications for the SIC-3G-GSM/SIC-3G-HSPA / SIC-3G-HSPA+ interface module antenna

Item	Description
Frequency scope	824-960 MHz/1710-2170 MHz
Voltage standing wave ratio	≤ 2
Input impedance	50 Ω
Gain	1.5 dBi
Polarization type	Vertical
Maximum input power	10 W
Interface	TNC-Male
Lightning protection	Direct current grounding
Height	153 mm (6.02 in)
Weight	26 g (0.92 oz)
Length	None
Color	Black
Operation temperature	-30 °C to 60 °C (-22°F to 140°F)

Connecting a SIC-3G-GSM/SIC-3G-HSPA / SIC-3G-HSPA+ interface module antenna

1. To install an antenna, adjust the angle of the antenna to 180°.
2. Fasten the antenna onto the antenna port that has a MAIN mark. Avoid over-tightening. Make sure the antenna is vertical to the ground or ceiling to achieve the optimal coverage.

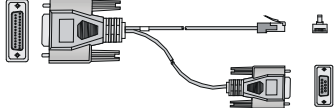
Connecting a SIC-3G-GSM/SIC-3G-HSPA / SIC-3G-HSPA+ interface debug antenna

1. Connect the RJ-45 interface of the AUX cable to the Diag Port interface.
2. Connect the D25/D9 connector to a peer device, which is typically a PC.

4G interface

Appearance and applicable models of the SIC-4G-LTE-V/SIC-4G-LTE-A/SIC-4G-LTE-G interface module antenna

Table 254 Appearance and applicable models of the 4G interface module antenna

Appearance	Applicable models
	SIC-4G-LTE-V SIC-4G-LTE-A SIC-4G-LTE-G

Table 255 Specifications

Item	Description
Frequency scope	698 to 960 MHz/1.71 to 2.7 GHz
Voltage standing wave ratio	2.5
Input impedance	50 ohms
Gain	2 dBi
Polarization type	Vertical
Maximum input power	5 W
Interface	TNC
Height	21.4 cm (8.43 in)
Weight	50.5 g (1.78 oz)
Color	Black
Operation temperature	-40°C to +85°C (-40°F to +185°F)

Installing a 4G interface module antenna

1. Change the angle of the antenna orientation from vertical to horizontal.
2. Fasten the antenna onto the antenna port that has a MAIN mark. Avoid over-tightening.
3. Change the antenna orientation to vertical to achieve better signal coverage.

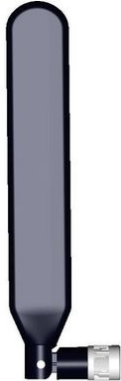
Installing a 4G interface debugging antenna

A 4G interface module has a Mini USB port to connect to the peer device through the USB console cable for third-party software to debug the 4G interface module. When the interface module is operating correctly, you do not need to connect the USB console cable.

To debug a 4G interface module:

1. Connect the port at one end of the USB console cable to the peer device (PC).

2. Connect the other end to the Mini USB port on the interface module.

Appendix A Interface module list

The full names and abbreviations of the interface modules are listed below. To simplify the descriptions in the guide, abbreviations are used to identify the interface modules.

Table 256 Interface module list

Product code	Full name	Abbreviation	Height
JD573B	RT-SIC-4FSW-H3	SIC-4FSW	0.5U
JD574B	RT-DSIC-9FSW-H3	DSIC-9FSW	0.5U
JD620A	RT-SIC-4FSW-POE-H3	SIC-4FSW-POE	0.5U
JD621A	RT-DSIC-9FSW-POE-H3	DSIC-9FSW-POE	0.5U
JF280A	RT-SIC-1FEF-H3	SIC-1FEF	0.5U
JD545B	RT-SIC-1FEA-H3	SIC-1FEA	0.5U
JD572A	RT-SIC-1GEC-H3	SIC-1GEC-H3	0.5U
JG738A	RT-SIC-1GEC-V2	SIC-1GEC-V2	0.5U
JD634B	RT-SIC-1E1-F-V3-H3	SIC-1E1-F	0.5U
JD538A	RT-SIC-1T1-F-V2-H3	SIC-1T1-F	0.5U
JF842A	RT-SIC-2E1-F-H3	SIC-2E1-F	0.5U
JF253B	RT-SIC-EPRI-H3	SIC-1EPRI	0.5U
JG604A	RT-SIC-1EPRI-V3	SIC-1EPRI	0.5U
JF281A	RT-SIC-8AS-H3	SIC-8AS	0.5U
JG186A	RT-SIC-16AS-H3	SIC-16AS	0.5U
JD557A	RT-SIC-1SAE-H3	SIC-1SAE	0.5U
JG736A	RT-SIC-2SAE	SIC-2SAE	0.5U
JG737A	RT-SIC-4SAE	SIC-4SAE	0.5U
JG191A	RT-DSIC-1SHDSL-8W-H3	DSIC-1SHDSL-8W	0.5U
JD537A	RT-SIC-1ADSL-H3	SIC-1ADSL	0.5U
JG056B	RT-SIC-1ADSL-I-H3	SIC-1ADSL-I	0.5U
JD571A	RT-SIC-1BS-V2-H3	SIC-1BS	0.5U
JD561A	RT-SIC-1FXS-V2-H3	SIC-1FXS	0.5U
JD560A	RT-SIC-2FXS-V2-H3	SIC-2FXS	0.5U
JD559A	RT-SIC-1FXO-V2-H3	SIC-1FXO	0.5U
JD558A	RT-SIC-2FXO-V2-H3	SIC-2FXO	0.5U
JD632A	RT-SIC-2FXS1FXO-H3	SIC-2FXS1FXO	0.5U
JG189A	RT-DSIC-4FXS1FXO-H3	DSIC-4FXS1FXO	0.5U
JD612B	RT-SIC-1BSV-H3	SIC-1BSV	0.5U
JF821A	RT-SIC-2BSV-H3	SIC-2BSV	0.5U
JD575B	RT-SIC-1VE1-V2-H3	SIC-1VE1	0.5U

Product code	Full name	Abbreviation	Height
JD576B	RT-SIC-1VT1-V2-H3	SIC-1VT1	0.5U
JH240A	RT-SIC-1VE1T1	SIC-1VE1T1	0.5U
JF819A	RT-SIC-AP-H3	SIC-WLAN-b/g/n	0.5U
JG211A	RT-SIC-AP-H3	SIC-WLAN-b/g/n (NA)	0.5U
JF820A	RT-SIC-3G-GSM-H3	SIC-3G-GSM	0.5U
JG187A	RT-SIC-3G-HSPA-H3	SIC-3G-HSPA	0.5U
JG929A	RT-SIC-3G-HSPA+-H3	SIC-3G-HSPA+	0.5U
JG739A	RT-SIC-4GSW	SIC-4GSW	0.5U
JH239A	RT-SIC-4GSWF	SIC-4GSWF	0.5U
JG740A	RT-SIC-4GSW-POE	SIC-4GSW-POE	0.5U
JG742A	RT-SIC-4G-LTE-V	SIC-4G-LTE-V	0.5U
JG742B	RT-SIC-4G-LTE-V	SIC-4G-LTE-V	0.5U
JG743A	RT-SIC-4G-LTE-A	SIC-4G-LTE-A	0.5U
JG743B	RT-SIC-4G-LTE-A	SIC-4G-LTE-A	0.5U
JG744A	RT-SIC-4G-LTE-G	SIC-4G-LTE-G	0.5U
JG744B	RT-SIC-4G-LTE-G	SIC-4G-LTE-G	0.5U
JD569A	RT-MIM-16FSW-H3	MIM-16FSW	1U
JD618A	RT-MIM-16FSW-POE-H3	MIM-16FSW-POE	1U
JF279A	RT-XMIM-16FSW-H3	XMIM-16FSW	1U
JF276A	RT-XMIM-24FSW-H3	XMIM-24FSW	1U
JD564A	RT-DMIM-24FSW-H3	DMIM-24FSW	1U
JD619A	RT-DMIM-24FSW-POE-H3	DMIM-24FSW-POE	1U
JD613A	RT-MIM-2FE-V2-H3	MIM-2FE	0.5U
JD551A	NS-MIM-4FE-H3	MIM-4FE	0.5U
JD548A	RT-MIM-2GBE-H3	MIM-2GBE	0.5U
JD624A	RT-MIM-1ATM-OC3-H3	MIM-1ATM-OC3	0.5U
JD555B	RT-MIM-IMA-8E1(75)-H3	MIM-IMA-8E1(75)	0.5U
JD556A	RT-MIM-IMA-4T1-V2-H3	MIM-IMA-4T1	0.5U
JG193A	RT-MIM-1POS-V2-H3	MIM-1POS	0.5U
JD544A	RT-MIM-2E1-V3-H3	MIM-2E1	0.5U
JD550A	RT-MIM-4E1-V3-H3	MIM-4E1	0.5U
JF257B	RT-MIM-4E1-F-V2-H3	MIM-4E1-F	0.5U
JD563A	RT-MIM-8E1(75)-H3	MIM-8E1(75)	0.5U
JF255A	RT-MIM-8E1(75)-F-H3	MIM-8E1(75)-F	0.5U
JD549A	RT-MIM-2T1-V2-H3	MIM-2T1	0.5U
JF254B	RT-MIM-4T1-F-V2-H3	MIM-4T1-F	0.5U
JC160A	RT-MIM-8T1-H3	MIM-8T1	0.5U

Product code	Full name	Abbreviation	Height
JC159A	RT-MIM-8T1-F-H3	MIM-8T1-F	0.5U
JD630A	RT-MIM-1CE3-V2-H3	MIM-1CE3	0.5U
JD628A	RT-MIM-1CT3-V2-H3	MIM-1CT3	0.5U
JD547A	RT-MIM-1SHL-4W-H3	MIM-1SHL-4W	0.5U
JD540A	RT-MIM-2SAE-H3	MIM-2SAE	0.5U
JD541A	RT-MIM-4SAE-H3	MIM-4SAE	0.5U
JD552A	RT-MIM-8SAE-H3	MIM-8SAE	0.5U
JF840A	RT-MIM-8ASE-H3	MIM-8ASE	0.5U
JF841A	RT-MIM-16ASE-H3	MIM-16ASE	1U
JD543A	RT-MIM-2FXO-V2-H3	MIM-2FXO	0.5U
JD553A	RT-MIM-4FXS-V2-H3	MIM-4FXS	0.5U
JD542A	RT-MIM-4FXO-V2-H3	MIM-4FXO	0.5U
JF822A	RT-MIM-16FXS-H3	MIM-16FXS	1U
JD539A	RT-MIM-4EM-H3	MIM-4E&M	0.5U
JF837A	RT-MIM-4BSV-H3	MIM-4BSV	0.5U
JD565A	RT-MIM-1VE1-V2-H3	MIM-1VE1	1U
JD566A	RT-MIM-1VT1-V2-H3	MIM-1VT1	1U
JD567A	RT-MIM-2VE1-V2-H3	MIM-2VE1	1U
JD568A	RT-MIM-2VT1-V2-H3	MIM-2VT1	1U
JG741A	RT-HMIM-8GSW	HMIM-8GSW	0.5U
JG426A	RT-HMIM-24GSW	HMIM-24GSW	1U
JG427A	RT-HMIM-24GSW-PoE	HMIM-24GSW-PoE	1U
JG420A	RT-HMIM-2GEE	HMIM-2GEE	0.5U
JG421A	RT-HMIM-4GEE	HMIM-4GEE	0.5U
JG422A	RT-HMIM-8GEE	HMIM-8GEE	0.5U
JG423A	RT-HMIM-2GEF	HMIM-2GEF	0.5U
JG424A	RT-HMIM-4GEF	HMIM-4GEF	0.5U
JG425A	RT-HMIM-8GEF	HMIM-8GEF	0.5U
JH238A	RT-HMIM-8GSWF	HMIM-8GSWF	0.5U
JG438A	RT-HMIM-1POS	HMIM-1POS	0.5U
JG428A	RT-HMIM-1CPOS	HMIM-1CPOS	0.5U
JG450A	RT-HMIM-2E1	HMIM-2E1	0.5U
JG451A	RT-HMIM-4E1	HMIM-4E1	0.5U
JG453A	RT-HMIM-4E1-F	HMIM-4E1-F	0.5U
JG452A	RT-HMIM-8E1	HMIM-8E1	0.5U
JG456A	RT-HMIM-2T1	HMIM-2T1	0.5U
JG457A	RT-HMIM-4T1-F	HMIM-4T1-F	0.5U

Product code	Full name	Abbreviation	Height
JH169A	RT-HMIM-8E1T1	HMIM-8E1T1	0.5U
JH172A	RT-HMIM-8E1T1-F	HMIM-8E1T1-F	0.5U
JG436A	RT-HMIM-1CE3	HMIM-1CE3	0.5U
JG435A	RT-HMIM-1CT3	HMIM-1CT3	0.5U
JH449A	RT-HMIM-1E3T3	HMIM-1E3T3	0.5U
JG442A	RT-HMIM-4SAE	HMIM-4SAE	0.5U
JG443A	RT-HMIM-8SAE	HMIM-8SAE	0.5U
JG445A	RT-HMIM-16ASE	HMIM-16ASE	1U
JG431A	RT-HMIM-2VE1	HMIM-2VE1	1U
JG429A	RT-HMIM-1VE1	HMIM-1VE1	1U
JG432A	RT-HMIM-2VT1	HMIM-1VT1	1U
JG430A	RT-HMIM-1VT1	HMIM-1VT1	1U
JG446A	RT-HMIM-4FXS	HMIM-4FXS	0.5U
JG447A	RT-HMIM-4FXO	HMIM-4FXO	0.5U
JG434A	RT-HMIM-16FXS	HMIM-16FXO	1U
JG448A	RT-HMIM-4E&M	HMIM-4E&M	0.5U
JD604A	RT-FIC-16FSW-H3	FIC-16FSW	1U
JD616A	RT-FIC-16FSW-POE-H3	FIC-16FSW-POE	1U
JD603A	RT-DFIC-24FSW-H3	FIC-24FSW	1U
JD617A	RT-DFIC-24FSW-POE-H3	FIC-24FSW-POE	1U
JD577A	RT-FIC-2FE-V2-H3	FIC-2FE	1U
JF824A	RT-FIC-4FE-H3	FIC-4FE	1U
JD583B	RT-FIC-1GBE-V2-H3	FIC-1GBE	1U
JF269B	RT-FIC-2GBE-V2-H3	FIC-2GBE	1U
JD582A	RT-FIC-1GEF-V2-H3	FIC-1GEF	1U
JF270B	RT-FIC-2GEF-V2-H3	FIC-2GEF	1U
JD622A	RT-FIC-IMA-4E1(75)-V3-H3	FIC-IMA-4E1(75)	1U
JF278B	RT-FIC-IMA-8E1(75)-V2-H3	FIC-IMA-8E1(75)	1U
JD596A	RT-FIC-1AE3-V3-H3	FIC-1AE3	1U
JD595A	RT-FIC-1AT3-V3-H3	FIC-1AT3	1U
JG200A	RT-FIC-IMA-8T1-V2-H3	FIC-IMA-8T1	1U
JD633A	RT-FIC-1ATM-OC3-H3	FIC-1ATM-OC3MM	1U
JD581C	RT-FIC-1POS-V4-H3	FIC-1POS	1U
JG201A	RT-FIC-1CPOS-H3	FIC-1CPOS	1U
JD578A	RT-FIC-2E1-V3-H3	FIC-2E1	1U
JD588A	RT-FIC-4E1-V4-H3	FIC-4E1	1U
JD591A	RT-FIC-4E1-F-V4-H3	FIC-4E1-F	1U

Product code	Full name	Abbreviation	Height
JD585A	RT-FIC-8E1(75)-V3-H3	FIC-8E1(75)	1U
JD586B	RT-FIC-8T1-V2-H3	FIC-8T1	1U
JD592A	RT-FIC-4T1-F-V3-H3	FIC-4T1-F	1U
JD625A	RT-FIC-1CE3-V3-H3	FIC-1CE3	1U
JD629A	RT-FIC-1CT3-V3-H3	FIC-1CT3	1U
JD589A	RT-FIC-4BSE-V2-H3	FIC-4BSE	1U
JD584A	RT-FIC-4SAE-V2-H3	FIC-4SAE	1U
JD580A	RT-FIC-8SAE-V2-H3	FIC-8SAE	1U
JF260B	RT-FIC-8ASE-V2-H3	FIC-8ASE	1U
JF265B	RT-FIC-16ASE-V2-H3	FIC-16ASE	1U
JD594A	RT-FIC-4FXS-V3-H3	FIC-4FXS	1U
JD593A	RT-FIC-4FXO-V3-H3	FIC-4FXO	1U
JG197A	RT-FIC-24FXS-H3	FIC-24FXS	1U
JD602A	RT-FIC-4EM-V2-H3	FIC-4E&M	1U
JD607A	RT-FIC-1VE1-V2-H3	FIC-1VE1	1U
JD605A	RT-FIC-1VT1-V2-H3	FIC-1VT1	1U
JD587A	RT-FIC-2VE1-V2-H3	FIC-2VE1	1U
JD606A	RT-FIC-2VT1-V2-H3	FIC-2VT1	1U
JD608A	RT-ESM-ANDE-H3	ESM-ANDE	-
JD609A	RT-ESM-SNDE-H3	ESM-SNDE	-
JD610A	RT-VCPM-H3	VCPM	-
JD598A	RT-VPM32-H3	VPM32	-
JD599A	RT-VPM24-H3	VPM24	-
JD600A	RT-VPM16-H3	VPM16	-
JD601A	RT-VPM8-H3	VPM8	-
JG417A	RT-VPM2-128	VPM2-128	-
JG418A	RT-VPM2-256	VPM2-256	-
JG419A	RT-VPM2-512	VPM2-512	-
JG415A	RT-HMIM-Adapter	HMIM-Adapter	0.5U
JG416A	RT-HMIM-Adapter-H	HMIM-Adapter-H	1U

Appendix B Purchase guide

This appendix introduces to you the types of interface modules that each model of HPE MSR routers can accommodate. In the tables, "Yes" means "Supported" and "No" means "Not supported".

SIC/DSIC purchase guide

NOTE:

- MSR50(MPU-G2), MSR4000, MSR900, and MSR930 routers do not support the installation of SIC/DSIC interface module.
- A PoE interface module provides PoE features only when it is installed on a PoE device.

Table 257 SIC/DSIC options

Product code	Type	20-1 X	20-20/20-21	20-40	30-10	30-11E /30-11 F	30-16	30-20/30-40/30-60	50-40 / 50-60 + MPU F
JD573B	SIC-4FS W	Yes	Yes	Yes in Slot 2 and Slot 4	Yes in Slot 2	Yes in Slot 2	Yes in Slot 2 and Slot 4	Yes in Slot 2 and Slot 4	Yes in Slot 2 and Slot 4
JD574B	DSIC-9F SW	Yes	No	Yes in Slot 2 and Slot 4	No	No	Yes in Slot 2 and Slot 4	Yes in Slot 2 and Slot 4	Yes in Slot 2 and Slot 4
JD620A	SIC-4FS W-POE	No	No	Yes in Slot 2 and Slot 4	No	No	Yes in Slot 2 and Slot 4	Yes in Slot 2 and Slot 4	Yes in Slot 2 and Slot 4
JD621A	DSIC-9F SW-POE	Yes	Yes	Yes in Slot 2 and Slot 4	No	No	Yes in Slot 2 and Slot 4	Yes in Slot 2 and Slot 4	Yes in Slot 2 and Slot 4
JG739A	SIC-4GS W								
JH239A	SIC-4GS WF	No	No	No	No	No	No	No	No
JF280A	SIC-1FEF	Yes	Yes	Yes in Slot 2 and Slot 4	Yes in Slot 2	Yes in Slot 2	Yes in Slot 2 and Slot 4	Yes in Slot 2 and Slot 4	Yes in Slot 2 and Slot 4
JD545B	SIC-1FE A	Yes	Yes	Yes in Slot 2 and Slot 4	Yes in Slot 2	Yes in Slot 2	Yes in Slot 2 and Slot 4	Yes in Slot 2 and Slot 4	Yes in Slot 2 and Slot 4

Product code	Type	20-1 X	20-20/20-21	20-40	30-10	30-11E /30-11 F	30-16	30-20/30-40/30-60	50-40 / 50-60 + MPU F
JD572A	SIC-1GE C-H3	Yes	Yes	Yes in Slot 2 and Slot 4	Yes in Slot 2	Yes in Slot 2	Yes in Slot 2 and Slot 4	Yes in Slot 2 and Slot 4	Yes in Slot 2 and Slot 4
JD634B	SIC-1E1-F	Yes	Yes	Yes	Yes	Yes	Yes	Yes	Yes
JD538A	SIC-1T1-F	Yes	Yes	Yes	Yes	Yes in Slot 1	Yes	Yes	Yes
JF842A	SIC-2E1-F	Yes	Yes	Yes	Yes	Yes	Yes	Yes	Yes
JF253B	SIC-EPRI	Yes	Yes	Yes	Yes	Yes in Slot 1	Yes	Yes	Yes
JF281A	SIC-8AS	Yes	Yes	Yes	Yes	Yes	Yes	Yes	Yes
JG186A	SIC-16AS	Yes	Yes	Yes	Yes	Yes	Yes	Yes	Yes
JD557A	SIC-1SA E	Yes	Yes	Yes	Yes	Yes	Yes	Yes	Yes
JG191A	DSIC-1S HDL-8 W	Yes	No	Yes	No	No	Yes	Yes	Yes
JD537A	SIC-1AD SL	Yes	Yes	Yes in Slot 2 and Slot 4	Yes in Slot 2	Yes in Slot 2	Yes in Slot 2 and Slot 4	Yes in Slot 2 and Slot 4	Yes
JG056B	SIC-1AD SL-I	Yes	Yes	Yes in Slot 2 and Slot 4	Yes in Slot 2	Yes in Slot 2	Yes in Slot 2 and Slot 4	Yes in Slot 2 and Slot 4	Yes in Slot 2 and Slot 4
JD571A	SIC-1BS	Yes	Yes	Yes	Yes	Yes in Slot 1	Yes	Yes	Yes
JD561A	SIC-1FX S	Yes	Yes	Yes	Yes	Yes	Yes	Yes	Yes
JD560A	SIC-2FX S	Yes	Yes	Yes	Yes	Yes	Yes	Yes	Yes
JD559A	SIC-1FX O	Yes	Yes	Yes	Yes	Yes	Yes	Yes	Yes
JD558A	SIC-2FX O	Yes	Yes	Yes	Yes	Yes	Yes	Yes	Yes
JD632A	SIC-2 FXS1FX O	Yes	Yes	Yes	Yes	Yes	Yes	Yes	Yes
JG189A	DSIC-4F XS1FXO	Yes	Yes	Yes	Yes	Yes	Yes	Yes	Yes
JF821A	SIC-2BS V	Yes	Yes	Yes	Yes	Yes in Slot 1	Yes	Yes	Yes

Product code	Type	20-1 X	20-20/20-21	20-40	30-10	30-11E /30-11 F	30-16	30-20/30-40/30-60	50-40 / 50-60 + MPU F
JD575B	SIC-1VE1	Yes	No	Yes	Yes in Slot 1	No	Yes	Yes	Yes
JD576B	SIC-1VT1	Yes	No	Yes	Yes in Slot 1	No	Yes	Yes	Yes
JH240A	SIC-1VE1 T1	No	No	No	No	No	No	No	No
JF820A	SIC-3G-G SM	Yes	Yes	Yes in Slot 2 and Slot 4	Yes in Slot 2	Yes in Slot 2	Yes in Slot 2 and Slot 4	Yes in Slot 2 and Slot 4	Yes in Slot 2 and Slot 4
JG187A	SIC-3G-H SPA	Yes	Yes	Yes in Slot 2 and Slot 4	Yes in Slot 2	Yes in Slot 2	Yes in Slot 2 and Slot 4	Yes in Slot 2 and Slot 4	Yes in Slot 2 and Slot 4
JG929A	SIC-3G-H SPA+	Yes	Yes	Yes in Slot 2 and Slot 4	Yes in Slot 2	Yes in Slot 2	Yes in Slot 2 and Slot 4	Yes in Slot 2 and Slot 4	Yes in Slot 2 and Slot 4
JF819A	SIC-WLAN-b/g/n	Yes	Yes	Yes in Slot 2 and Slot 4	Yes in Slot 2	Yes in Slot 2	Yes in Slot 2 and Slot 4	Yes in Slot 2 and Slot 4	Yes in Slot 2 and Slot 4

Product code	Type	1002-4	1003-8 /1003-8S	2003	2004-2 4/48	3012	3024	3044	3064
JF280A	SIC-1F EF	Yes in Slot 2	Yes in Slot 2 and Slot 3	Yes in Slot 2 and Slot 3	Yes in Slot 2 and Slot 4	Yes	Yes in Slot 2 and Slot 4	Yes in Slot 2 and Slot 4	Yes in Slot 2 and Slot 4
JG738A	SIC-1G EC-V2	Yes in Slot 2	Yes in Slot 2	Yes in Slot 2	Yes in Slot 2	Yes	Yes in Slot 2 and Slot 4	Yes in Slot 2 and Slot 4	Yes in Slot 2 and Slot 4
JD545B	SIC-1F EA	Yes in Slot 2	Yes in Slot 2 and Slot 3	Yes in Slot 2 and Slot 3	Yes in Slot 2 and Slot 4	Yes	Yes in Slot 2 and Slot 4	Yes in Slot 2 and Slot 4	Yes in Slot 2 and Slot 4
JD573B	SIC-4F SW	Yes in Slot 2	Yes in Slot 2 and Slot 3	Yes in Slot 2 and Slot 3	Yes in Slot 2 and Slot 4	Yes	Yes in Slot 2 and Slot 4	Yes in Slot 2 and Slot 4	Yes in Slot 2 and Slot 4
JD620A	DSIC-4 FSWP	Yes in Slot 2	Yes in Slot 2 and Slot 3	Yes in Slot 2 and Slot 3	Yes in Slot 2 and Slot 4	Yes	Yes in Slot 2 and Slot 4	Yes in Slot 2 and Slot 4	Yes in Slot 2 and Slot 4

Product code	Type	1002-4	1003-8 /1003-8S	2003	2004-2 4/48	3012	3024	3044	3064
JD574B	DSIC-9 FSW	Yes in Slot 2	Yes in Slot 2	Yes in Slot 2	No	No	Yes in Slot 2 and Slot 4	Yes in Slot 2 and Slot 4	Yes in Slot 2 and Slot 4
JD621A	DSIC-9 FSWP	Yes in Slot 2	Yes in Slot 2	Yes in Slot 2	No	No	Yes in Slot 2 and Slot 4	Yes in Slot 2 and Slot 4	Yes in Slot 2 and Slot 4
JD537A	SIC-1A DSL	Yes in Slot 2	Yes in Slot 2 and Slot 3	Yes in Slot 2 and Slot 3	Yes in Slot 2 and Slot 4	Yes	Yes in Slot 2 and Slot 4	Yes in Slot 2 and Slot 4	Yes in Slot 2 and Slot 4
JG056B	SIC-1A DSL-I	Yes in Slot 2	Yes in Slot 2 and Slot 3	Yes in Slot 2 and Slot 3	Yes in Slot 2 and Slot 4	Yes	Yes in Slot 2 and Slot 4	Yes in Slot 2 and Slot 4	Yes in Slot 2 and Slot 4
JG191A	DSIC-1 SHDSL -8W	Yes in Slot 2	Yes in Slot 2	Yes in Slot 2	No	No	Yes in Slot 2 and Slot 4	Yes in Slot 2 and Slot 4	Yes in Slot 2 and Slot 4
JD634B	SIC-1E 1-F	Yes	Yes	Yes	Yes	Yes	Yes	Yes	Yes
JF842A	SIC-2E 1-F	Yes	Yes	Yes	Yes	Yes	Yes	Yes	Yes
JD538A	SIC-1T 1-F	Yes	Yes	Yes	Yes	Yes	Yes	Yes	Yes
JG604A	SIC-1E PRI	Yes	Yes	Yes	Yes	Yes	Yes	Yes	Yes
JD557A	SIC-1S AE	Yes	Yes	Yes in Slot 2 and Slot 3	Yes	Yes	Yes	Yes	Yes
JG736A	SIC-2S AE	Yes	Yes	Yes in Slot 2 and Slot 3	Yes	Yes	Yes	Yes	Yes
JG737A	SIC-4S AE	Yes	Yes	Yes in Slot 2 and Slot 3	Yes	Yes	Yes	Yes	Yes
JF281A	SIC-8A S	Yes	Yes	Yes	Yes	Yes	Yes	Yes	Yes
JG186A	SIC-16 AS	Yes	Yes	Yes	Yes	Yes	Yes	Yes	Yes
JD571A	SIC-1B S	Yes	Yes	Yes	Yes	Yes	Yes	Yes	Yes
JD561A	SIC-1F XS	Yes	Yes	Yes	Yes	Yes	Yes	Yes	Yes

Product code	Type	1002-4	1003-8 /1003-8S	2003	2004-2 4/48	3012	3024	3044	3064
JD560A	SIC-2F XS	Yes	Yes	Yes	Yes	Yes	Yes	Yes	Yes
JD559A	SIC-1F XO	Yes	Yes	Yes	Yes	Yes	Yes	Yes	Yes
JD558A	SIC-2F XO	Yes	Yes	Yes	Yes	Yes	Yes	Yes	Yes
JD632A	SIC-2F XS1FXO	Yes	Yes	Yes	Yes	Yes	Yes	Yes	Yes
JG189A	DSIC-4 FXS1FXO	Yes in Slot 2	Yes in Slot 2	Yes in Slot 2	No	No	Yes in Slot 2 and Slot 4	Yes in Slot 2 and Slot 4	Yes in Slot 2 and Slot 4
JD612B	SIC-1B SV	Yes	Yes	Yes	Yes	Yes	Yes	Yes	Yes
JF821A	SIC-2B SV	Yes	Yes	Yes	Yes	Yes	Yes	Yes	Yes
JD575B	SIC-1V E1	No	No	No	No	Yes	Yes	Yes	Yes
JD576B	SIC-1V T1	No	No	No	No	Yes	Yes	Yes	Yes
JH240A	SIC-1V E1T1	No	No	No	No	Yes	Yes	Yes	Yes
JG187A	SIC-3G -HSPA	Yes in Slot 2	Yes in Slot 2 and Slot 3	Yes in Slot 2 and Slot 3	Yes in Slot 2 and Slot 4	Yes	Yes in Slot 2 and Slot 4	Yes in Slot 2 and Slot 4	Yes in Slot 2 and Slot 4
JG929A	SIC-3G -HSPA +	Yes in Slot 2	Yes in Slot 2 and Slot 3	Yes in Slot 2 and Slot 3	Yes in Slot 2 and Slot 4	Yes	Yes in Slot 2 and Slot 4	Yes in Slot 2 and Slot 4	Yes in Slot 2 and Slot 4
JG739A	SIC-4G SW	Yes in Slot 2	Yes in Slot 2	Yes in Slot 2	Yes in Slot 2	Yes	Yes in Slot 2 and Slot 4	Yes in Slot 2 and Slot 4	Yes in Slot 2 and Slot 4
JH239A	SIC-4G SWF	Yes in Slot 2	Yes in Slot 2	Yes in Slot 2	Yes in Slot 2	Yes	Yes in Slot 2 and Slot 4	Yes in Slot 2 and Slot 4	Yes in Slot 2 and Slot 4
JG740A	SIC-4G SWP	Yes in Slot 2	Yes in Slot 2	Yes in Slot 2	Yes in Slot 2	Yes	Yes in Slot 2 and Slot 4	Yes in Slot 2 and Slot 4	Yes in Slot 2 and Slot 4
JG743A	SIC 4G-LTE -A	Yes in Slot 2	Yes in Slot 2 and Slot 3	Yes in Slot 2 and Slot 3	Yes in Slot 2 and Slot 4	Yes	Yes in Slot 2 and Slot 4	Yes in Slot 2 and Slot 4	Yes in Slot 2 and Slot 4

Product code	Type	1002-4	1003-8 /1003-8S	2003	2004-24/48	3012	3024	3044	3064
JG743B	SIC 4G-LT E-A	Yes in Slot 2	Yes in Slot 2 and Slot 3	Yes in Slot 2 and Slot 3	Yes in Slot 2 and Slot 4	Yes	Yes in Slot 2 and Slot 4	Yes in Slot 2 and Slot 4	Yes in Slot 2 and Slot 4
JG742A	SIC 4G-LT E-V	Yes in Slot 2	Yes in Slot 2 and Slot 3	Yes in Slot 2 and Slot 3	Yes in Slot 2 and Slot 4	Yes	Yes in Slot 2 and Slot 4	Yes in Slot 2 and Slot 4	Yes in Slot 2 and Slot 4
JA742B	SIC 4G-LTE -V	Yes in Slot 2	Yes in Slot 2 and Slot 3	Yes in Slot 2 and Slot 3	Yes in Slot 2 and Slot 4	Yes	Yes in Slot 2 and Slot 4	Yes in Slot 2 and Slot 4	Yes in Slot 2 and Slot 4
JG744A	SIC 4G-LTE -G	Yes in Slot 2	Yes in Slot 2 and Slot 3	Yes in Slot 2 and Slot 3	Yes in Slot 2 and Slot 4	Yes	Yes in Slot 2 and Slot 4	Yes in Slot 2 and Slot 4	Yes in Slot 2 and Slot 4
JG744B	SIC 4G-LTE -G	Yes in Slot 2	Yes in Slot 2 and Slot 3	Yes in Slot 2 and Slot 3	Yes in Slot 2 and Slot 4	Yes	Yes in Slot 2 and Slot 4	Yes in Slot 2 and Slot 4	Yes in Slot 2 and Slot 4

MIM/XMIM/DMIM purchase guide

NOTE:

- Only MSR30 routers support the installation of the MIM/XMIM/DMIM interface modules.
- A PoE interface module provides PoE features only when it is installed on a PoE device.

Table 258 MIM/XMIM/DMIM options

Product code	Type	30-10	30-11E/30-11F/30-16	30-20	30-40/30-60
JD569A	MIM-16FSW	Yes	Yes	Yes	Yes
JD618A	MIM-16FSW-POE	Yes	Yes	Yes	Yes
JF279A	XMIM-16FSW	Yes	Yes	No	No
JF276A	XMIM-24FSW	Yes	Yes	No	No
JD564A	DMIM-24FSW	No	No	No	Yes
JD619A	DMIM-24FSW-POE	No	No	No	Yes
JD613A	MIM-2FE	Yes	Yes	Yes	Yes
JD551A	MIM-4FE	Yes	Yes	Yes	Yes
JD548A	MIM-2GBE	Yes	Yes	Yes	Yes
JD624A	MIM-1ATM-OC3	Yes	Yes	Yes	Yes

Product code	Type	30-10	30-11E/30-11F/ 30-16	30-20	30-40/ 30-60
JD555B	MIM-IMA-8E1(75)	Yes	Yes	Yes	Yes
JD556A	MIM-IMA-4T1	Yes	Yes	Yes	Yes
JG193A	MIM-1POS	Yes	Yes	Yes	Yes
JD544A	MIM-2E1	Yes	Yes	Yes	Yes
JD550A	MIM-4E1	Yes	Yes	Yes	Yes
JF257B	MIM-4E1-F	Yes	Yes	Yes	Yes
JD563A	MIM-8E1(75)	Yes	Yes	Yes	Yes
JF255A	MIM-8E1(75)-F	Yes	Yes	Yes	Yes
JD549A	MIM-2T1	Yes	Yes	Yes	Yes
JF254B	MIM-4T1-F	Yes	Yes	Yes	Yes
JC160A	MIM-8T1	Yes	Yes	Yes	Yes
JC159A	MIM-8T1-F	Yes	Yes	Yes	Yes
JD630A	MIM-1CE3	Yes	Yes	Yes	Yes
JD628A	MIM-1CT3	Yes	Yes	Yes	Yes
JD547A	MIM-1SHL-4W	Yes	Yes	Yes	Yes
JD540A	MIM-2SAE	Yes	Yes	Yes	Yes
JD541A	MIM-4SAE	Yes	Yes	Yes	Yes
JD552A	MIM-8SAE	Yes	Yes	Yes	Yes
JF840A	MIM-8ASE	Yes	Yes	Yes	Yes
JF841A	MIM-16ASE	Yes	Yes	Yes	Yes
JD543A	MIM-2FXO	Yes	Yes	Yes	Yes
JD553A	MIM-4FXS	Yes	Yes	Yes	Yes
JD542A	MIM-4FXO	Yes	Yes	Yes	Yes
JF822A	MIM-16FXS	Yes	Yes	Yes	Yes
JD539A	MIM-4E&M	Yes	Yes	Yes	Yes
JF837A	MIM-4BSV	Yes	Yes	Yes	Yes
JD565A	MIM-1VE1	Yes	Yes	Yes	Yes
JD566A	MIM-1VT1	Yes	Yes	Yes	Yes
JD567A	MIM-2VE1	Yes	Yes	Yes	Yes
JD568A	MIM-2VT1	Yes	Yes	Yes	Yes

HMIM purchase guide

NOTE:

- Only MSR3000, MSR4000 routers support the installation of the HMIM interface modules.
- A PoE interface module provides PoE features only when it is installed on a PoE device.

Table 259 HMIM options

Product code	Type	3012	3024	3044	3064	4060	4080
JG741A	HMIM-8GS W	Yes	Yes	Yes	Yes in Slot 5, Slot 6, Slot 8, Slot 9, and Slot 10	Yes	Yes in Slot 1, Slot 2, Slot 5, Slot 6, Slot 7, and Slot 8
JG426A	HMIM-24G SW	Yes	Yes	Yes	Yes	Yes	Yes
JG427A	HMIM-24G SW-POE	Yes	Yes	Yes	Yes	Yes	Yes
JG420A	HMIM-2GE E	Yes	Yes	Yes	Yes	Yes	Yes
JG421A	HMIM-4GE E	Yes	Yes	Yes	Yes	Yes	Yes
JG422A	HMIM-8GE E	Yes	Yes	Yes	Yes	Yes	Yes
JG423A	HMIM-2GE F	Yes	Yes	Yes	Yes	Yes	Yes
JG424A	HMIM-4GE F	Yes	Yes	Yes	Yes	Yes	Yes
JG425A	HMIM-8GE F	Yes	Yes	Yes	Yes	Yes	Yes
JH238A	HMIM-8GS WF	Yes	Yes	Yes	Yes in Slot 5, Slot 6, Slot 8, Slot 9, and Slot 10	Yes	Yes in Slot 1, Slot 2, Slot 5, Slot 6, Slot 7, and Slot 8
JG438A	HMIM-1PO S	Yes	Yes	Yes	Yes	Yes	Yes
JG428A	HMIM-1CP OS	Yes	Yes	Yes	Yes	Yes	Yes
JG450A	HMIM-2E1	Yes	Yes	Yes	Yes	Yes	Yes
JG451A	HMIM-4E1	Yes	Yes	Yes	Yes	Yes	Yes
JG453A	HMIM-4E1- F	Yes	Yes	Yes	Yes	Yes	Yes
JG452A	HMIM-8E1	Yes	Yes	Yes	Yes	Yes	Yes
JG456A	HMIM-2T1	Yes	Yes	Yes	Yes	Yes	Yes

Product code	Type	3012	3024	3044	3064	4060	4080
JG457A	HMIM-4T1-F	Yes	Yes	Yes	Yes	Yes	Yes
JH169A	HMIM-8E1 T1	Yes	Yes	Yes	Yes	Yes	Yes
JH172A	HMIM-8E1 T1-F	Yes	Yes	Yes	Yes	Yes	Yes
JG436A	HMIM-1CE3	Yes	Yes	Yes	Yes	Yes	Yes
JG435A	HMIM-1CT3	Yes	Yes	Yes	Yes	Yes	Yes
JH449A	HMIM-1E3 T3	Yes	Yes	Yes	Yes	Yes	Yes
JG442A	HMIM-4SA E	Yes	Yes	Yes	Yes	Yes	Yes
JG443A	HMIM-8SA E	Yes	Yes	Yes	Yes	Yes	Yes
JG445A	HMIM-16A SE	Yes	Yes	Yes	Yes	Yes	Yes
JG431A	HMIM-2VE1	Yes	Yes	Yes	Yes	Yes	Yes
JG429A	HMIM-1VE1	Yes	Yes	Yes	Yes	Yes	Yes
JG432A	HMIM-2VT1	Yes	Yes	Yes	Yes	Yes	Yes
JG430A	HMIM-1VT1	Yes	Yes	Yes	Yes	Yes	Yes
JG434A	HMIM-16F XS	Yes	Yes	Yes	Yes	Yes	Yes
JG446A	HMIM-4FX S	Yes	Yes	Yes	Yes	Yes	Yes
JG447A	HMIM-4FX O	Yes	Yes	Yes	Yes	Yes	Yes
JG448A	HMIM-4E&M	Yes	Yes	Yes	Yes	Yes	Yes

FIC/DFIC purchase guide

NOTE:

- Only MSR50 routers support the installation of the FIC/DFIC interface modules.
 - A PoE interface module provides PoE features only when it is installed on a PoE device.
-

Table 260 FIC/DFIC options

Product code	Type	50-40/ 50-60 MPUF	50-40/ 50-60 MPU-G2
JD604A	FIC-16FSW	Yes	Yes
JD616A	FIC-16FSW-POE	Yes	Yes
JD603A	DFIC-24FSW	Yes	Yes
JD617A	DFIC-24FSW-POE	Yes	Yes
JD577A	FIC-2FE	Yes	Yes
JF824A	FIC-4FE	Yes	Yes
JD583B	FIC-1GBE	Yes	Yes
JF269B	FIC-2GBE	Yes	Yes
JD582A	FIC-1GEF	Yes	Yes
JF270B	FIC-2GEF	Yes	Yes
JD622A	FIC-IMA-4E1(75)	Yes	Yes
JF278B	FIC-IMA-8E1(75)	Yes	Yes
JD596A	FIC-1AE3	Yes	Yes
JD595A	FIC-1AT3	Yes	Yes
JG200A	FIC-IMA-8T1	Yes	Yes
JD633A	FIC-1ATM-OC3MM	Yes	Yes
JD581C	FIC-1POS	Yes	Yes
JG201A	FIC-1CPOS	Yes	Yes
JD578A	FIC-2E1	Yes	Yes
JD588A	FIC-4E1	Yes	Yes
JD591A	FIC-4E1-F	Yes	Yes
JD585A	FIC-8E1(75)	Yes	Yes
JD586B	FIC-8T1	Yes	Yes
JD592A	FIC-4T1-F	Yes	Yes
JD625A	FIC-1CE3	Yes	Yes
JD629A	FIC-1CT3	Yes	Yes
JD589A	FIC-4BSE	Yes	Yes
JD584A	FIC-4SAE	Yes	Yes
JD580A	FIC-8SAE	Yes	Yes
JF260B	FIC-8ASE	Yes	Yes
JF265B	FIC-16ASE	Yes	Yes
JD594A	FIC-4FXS	Yes	Yes
JD593A	FIC-4FXO	Yes	Yes

Product code	Type	50-40/ 50-60 MPUF	50-40/ 50-60 MPU-G2
JD602A	FIC-4E&M	Yes	Yes
JD607A	FIC-1VE1	Yes	Yes
JD605A	FIC-1VT1	Yes	Yes
JD587A	FIC-2VE1	Yes	Yes
JD606A	FIC-2VT1	Yes	Yes

ESM/VPM/VCPM purchase guide

Table 261 ESM/VPM/VCPM options

Product code	Type	900	20-1 0/20 -11/ 20-1 3	20-1 2	20-2 0/ 20-2 1	20-4 0	30-1 1E/ 30-1 1F	30-1 0	30-1 6	30-2 0/30 -40/ 30-6 0	50-4 0/ 50-6 0 + MP UF + MS CA	50- 40/ 50- 60 + M PU -G 2 + M SC B
JD608A	ESM-AN DE	No	No	No	Yes	Yes	Yes	Yes	Yes	Yes	Yes	Yes
JD609A	ESM-SN DE	No	No	No	Yes	Yes	Yes	Yes	Yes	Yes	Yes	Yes
JD610A	VCPM	No	No	No	No	Yes	No	No	Yes	Yes	Yes	Yes
JD598A	VPM32	No	No	Yes	No	Yes	No	Yes	Yes	Yes	Yes	No
JD599A	VPM24	No	No	Yes	No	Yes	No	Yes	Yes	Yes	Yes	No
JD600A	VPM16	No	No	Yes	No	Yes	No	Yes	Yes	Yes	Yes	No
JD601A	VPM8	No	No	Yes	No	Yes	No	Yes	Yes	Yes	Yes	No

Product code	Type	930	2003	3012	3024	3044	3064	4060	4080
JG419A	VPM2 512	No	Yes	Yes	Yes	Yes	Yes	Yes	Yes
JG418A	VPM2 256	No	Yes	Yes	Yes	Yes	Yes	Yes	Yes
JG417A	VPM2 128	No	Yes	Yes	Yes	Yes	Yes	Yes	Yes

Index

Numerics

3G interface module

SIC-3G-GSM, 31

SIC-3G-HSPA, 32, 33

4G interface module

SIC-4G-LTE-A, 38, 40, 42, 44

SIC-4G-LTE-G, 38, 40, 42, 44

SIC-4G-LTE-V, 35, 37

A

antenna

SIC-3G-GSM, 32

SIC-3G-HSPA, 33, 35

SIC-4G-LTE-A, 40, 42, 43, 45

SIC-4G-LTE-V, 36, 38

asynchronous interface

FIC-4SAE, 126

FIC-8SAE, 126

ATM interface module

FIC-1AE3, 112

FIC-1AT3, 113

FIC-1ATM-OC3, 114

FIC-IMA-4E1, 110

FIC-IMA-8E1, 110

FIC-IMA-8T1, 111

MIM-1ATM-OC3, 52

MIM-IMA-4T1, 54

MIM-IMA-8E1, 53

C

cable

24FXS interface, 167

3G interface, 173

4G interface, 175

ADSL interface, 165

AM interface, 165

asynchronous serial port, 159

BS interface, 165

BSE interface, 168

BSV interface, 168

E&M interface, 166

E1 interface, 149

E3 interface, 158

Ethernet interface, 142

FCM interface, 165

fiber port, 144

FXO interface, 165

FXS interface, 165

G.SHDSL interface, 171

synchronous serial port, 159

T1 interface, 156

T3 interface, 158

WLAN interface, 173

connection method

24FXS interface, 167

3G interface, 173

4G interface, 175

ADSL interface, 165

AM interface, 165

asynchronous serial port, 159

BS interface, 165

BSE interface, 168

BSV interface, 168

DFIC-24FSW, 106

DFIC-24FSW-PoE, 106

DMIM-24FSW, 50

DMIM-24FSW-PoE, 50

DSIC-1SHDSL-8W, 17

DSIC-4FXS1FXO, 24

DSIC-9FSW, 2

DSIC-9FSW-PoE, 2

E&M interface, 166

E1 interface, 149

E3 interface, 158
Ethernet interface, 142
FCM interface, 165
fiber port, 144
FIC-16ASE, 129
FIC-16FSW, 106
FIC-16FSW-PoE, 106
FIC-1AE3, 113
FIC-1AT3, 113
FIC-1ATM-OC3, 114
FIC-1CE3, 122
FIC-1CPOS, 117
FIC-1CT3, 124
FIC-1GBE, 108
FIC-1GEF, 109
FIC-1POS, 115
FIC-1VE1, 135
FIC-1VT1, 137
FIC-24FXS, 132
FIC-2E1, 119
FIC-2FE, 107
FIC-2GBE, 108
FIC-2GEF, 109
FIC-2VE1, 133
FIC-2VT1, 134
FIC-4BSE, 126
FIC-4E&M, 131
FIC-4E1, 119
FIC-4E1-F, 119
FIC-4FE, 107
FIC-4FX, 131
FIC-4FXO, 131
FIC-4SAE, 128
FIC-4T1-F, 121
FIC-8ASE, 129
FIC-8E1, 120
FIC-8SAE, 128
FIC-IMA-4E1, 111
FIC-IMA-8E1, 111
FIC-IMA-8T1, 112
FXO interface, 165
FXS interface, 165
G.SHDSL interface, 171
HMIM-16ASE, 96
HMIM-16FXS, 98
HMIM-1CE3, 92
HMIM-1CPOS, 84
HMIM-1CT3, 93, 94
HMIM-1POS, 83
HMIM-1VE1, 101
HMIM-1VT1, 102
HMIM-24GSW, 79
HMIM-24GSW-PoE, 79
HMIM-2E1, 86
HMIM-2E1T1, 91
HMIM-2E1T1-F, 91
HMIM-2GEE, 81
HMIM-2GEF, 82
HMIM-2T1, 88
HMIM-2VE1, 99
HMIM-4E&M, 103
HMIM-4E1, 86
HMIM-4E1-F, 86
HMIM-4E1T1, 91
HMIM-4E1T1-F, 91
HMIM-4FXO, 102
HMIM-4FXS, 102
HMIM-4GEE, 81
HMIM-4GEF, 82
HMIM-4SAE, 96
HMIM-4T1-F, 88
HMIM-8E1, 87
HMIM-8E1T1, 91
HMIM-8E1T1-F, 91
HMIM-8GEE, 81
HMIM-8GEF, 82
HMIM-8GSW, 79
HMIM-8GSWF, 80

HMIM-8SAE, 96
MIM-16ASE, 68
MIM-16FSW, 50
MIM-16FSW-PoE, 50
MIM-16FXS, 69
MIM-1ATM-OC3, 53
MIM-1CE3, 63
MIM-1CT3, 64
MIM-1POS, 56
MIM-1SHL-4W, 65
MIM-1VE1, 74
MIM-1VT1, 75
MIM-2E1, 58
MIM-2FE, 51
MIM-2FXO, 72
MIM-2GBE, 52
MIM-2SAE, 67
MIM-2T1, 60
MIM-2VE1, 76
MIM-2VT1, 77
MIM-4BSV, 71
MIM-4E&M, 73
MIM-4E1, 58
MIM-4E1-F, 58
MIM-4FE, 51
MIM-4FXO, 72
MIM-4FXS, 72
MIM-4SAE, 67
MIM-4T1-F, 60
MIM-8ASE, 68
MIM-8E1, 59
MIM-8E1-F, 59
MIM-8SAE, 67
MIM-8T1, 62
MIM-8T1-F, 62
MIM-IMA-4T1, 55
MIM-IMA-8E1, 54
SIC-16AS, 14
SIC-1ADSL, 18

SIC-1ADSL-I, 19
SIC-1BS, 20
SIC-1BSV, 25
SIC-1E1-F, 9
SIC-1EPRI, 11
SIC-1FEA, 5
SIC-1FEF, 6
SIC-1FXO, 22
SIC-1FXS, 22
SIC-1GEC, 7
SIC-1SAE, 15
SIC-1T1-F, 12
SIC-1VE1, 27
SIC-1VT1, 28
SIC-2BSV, 25
SIC-2E1-F, 10
SIC-2FXO, 22
SIC-2FXS, 22
SIC-2FXS1FXO, 23
SIC-2SAE, 15
SIC-3G-GSM, 32
SIC-3G-HSPA, 33, 35
SIC-4FSW, 2
SIC-4FSW-PoE, 2
SIC-4GSW, 3
SIC-4GSW-POE, 3
SIC-4SAE, 15
SIC-8AS, 13
SIC-EPRI, 11
SIC-WLAN-b/g/n, 30
SIC-WLAN-b/g/n(NA), 30
synchronous serial port, 159
T1 interface, 156
T3 interface, 158
WLAN interface, 173
XMIM-16FSW, 48
XMIM-24FSW, 48
CPOS (SDH/SONET) interface module
FIC-1CPOS, 116

HMIM-1CPOS, 83

D

DCE

FIC-4SAE, 126

FIC-8SAE, 126

DFIC

Ethernet switching module, 104

DMIM

Ethernet switching module, 47

DSIC

Ethernet switching module, 1

voice interface module, 21

XDSL interface module, 16

DTE

FIC-4SAE, 126

FIC-8SAE, 126

E

E1 cable

applicable interface module, 149

E1/T1 interface module

FIC-2E1, 117

FIC-4E1, 117

FIC-4E1-F, 117

FIC-4T1-F, 120

FIC-8E1, 119

HMIM-2E1, 85

HMIM-2T1, 87

HMIM-4E1, 85

HMIM-4E1-F, 85

HMIM-4T1-F, 87

HMIM-8E1, 86

MIM-2E1, 56

MIM-2T1, 59

MIM-4E1, 56

MIM-4E1-F, 56

MIM-4T1-F, 59

MIM-8E1, 58

MIM-8E1-F, 58

MIM-8T1, 61

MIM-8T1-F, 61

SIC-1E1-F, 8

SIC-1EPRI, 10

SIC-1T1-F, 11

SIC-2E1-F, 9

SIC-EPRI, 10

E3/T3 interface module

FIC-1CE3, 121

FIC-1CT3, 122

HMIM-1CE3, 91

HMIM-1CT3, 92

HMIM-1E3T3, 93

MIM-1CE3, 62

MIM-1CT3, 63

ESM

ESM-ANDE, 138

ESM-SNDE, 139

Ethernet interface module

FIC-1GBE, 107

FIC-1GEF, 108

FIC-2FE, 106

FIC-2GBE, 107

FIC-2GEF, 108

FIC-4FE, 106

HMIM-2E1T1, 88

HMIM-2E1T1-F, 88

HMIM-2GEE, 80

HMIM-2GEF, 81

HMIM-4E1T1, 88

HMIM-4E1T1-F, 88

HMIM-4GEE, 80

HMIM-4GEF, 81

HMIM-8E1T1, 88

HMIM-8E1T1-F, 88

HMIM-8GEE, 80

HMIM-8GEF, 81

MIM-2FE, 50

MIM-2GBE, 51

MIM-4FE, 50

SIC-1FEA, 5

SIC-1FEF, 5

SIC-1GEC, 6

Ethernet interface switching module

HMIM-24GSW, 78

HMIM-24GSW-PoE, 78

HMIM-8GSW, 78

HMIM-8GSWF, 79

Ethernet switching module

DFIC-24FSW, 104

DFIC-24FSW-PoE, 104

DMIM-24FSW, 48

DMIM-24FSW-PoE, 48

DSIC-9FSW, 1

DSIC-9FSW-PoE, 1

FIC-16FSW, 104

FIC-16FSW-PoE, 104

MIM-16FSW, 48

MIM-16FSW-PoE, 48

SIC-4FSW, 1

SIC-4FSW-PoE, 1

SIC-4GSW, 2

SIC-4GSW-POE, 2

XMIM-16FSW, 47

XMIM-24FSW, 47

F

fiber port

FIC-1ATM-OC3, 114

FIC-1CPOS, 117

FIC-1GBE, 108

FIC-1GEF, 109

FIC-1POS, 115

FIC-2GBE, 108

FIC-2GEF, 109

HMIM-1CPOS, 84

HMIM-1POS, 83

HMIM-8GSWF, 80

MIM-1ATM-OC3, 53

MIM-1POS, 56

SIC-1FEF, 6

FIC

ATM interface module, 109

CPOS (SDH/SONET) interface module, 116

E1/T1 interface module, 117

E3/T3 interface module, 121

Ethernet interface module, 106

Ethernet switching module, 104

ISDN BRI interface module, 124

POS (SDH/SONET) interface module, 115

serial interface module, 126

voice interface module, 129

H

HMIM

CPOS (SDH/SONET) interface module, 83

E1/T1 interface module, 84

E3/T3 interface module, 91

Ethernet interface module, 80

Ethernet interface switching module, 78

POS (SDH/SONET) interface module, 82

serial interface module, 94

voice interface module, 97

I

installation

ESM-ANDE, 138

ESM-SNDE, 139

VCPM, 141, 141

installing a SIM card

SIC-3G-GSM, 32

SIC-3G-HSPA, 33, 35

SIC-4G-LTE-A, 40, 42, 44, 45

SIC-4G-LTE-G, 40, 42, 44, 45

SIC-4G-LTE-V, 36, 38

interface

DFIC-24FSW, 104

DFIC-24FSW-PoE, 104

DMIM-24FSW, 48
DMIM-24FSW-PoE, 48
DSIC-1SHDSL-8W, 16
DSIC-4FXS1FXO, 24
DSIC-9FSW, 1
DSIC-9FSW-PoE, 1
ESM-ANDE, 138
ESM-SNDE, 139
FIC-16ASE, 128
FIC-16FSW, 104
FIC-16FSW-PoE, 104
FIC-1AE3, 112
FIC-1AT3, 113
FIC-1ATM-OC3, 114
FIC-1CE3, 122
FIC-1CPOS, 116
FIC-1CT3, 123
FIC-1GBE, 108
FIC-1GEF, 109
FIC-1POS, 115
FIC-1VE1, 135
FIC-1VT1, 136
FIC-24FXS, 132
FIC-2E1, 118
FIC-2FE, 106
FIC-2GBE, 108
FIC-2GEF, 109
FIC-2VE1, 132
FIC-2VT1, 134
FIC-4BSE, 124
FIC-4E&M, 131
FIC-4E1, 118
FIC-4E1-F, 118
FIC-4FE, 106
FIC-4FX, 130
FIC-4FXO, 130
FIC-4SAE, 127
FIC-4T1-F, 120
FIC-8ASE, 128
FIC-8E1, 119
FIC-8SAE, 127
FIC-IMA-4E1, 110
FIC-IMA-8E1, 110
FIC-IMA-8T1, 111
HMIM-16ASE, 96
HMIM-16FXS, 97
HMIM-1CE3, 91
HMIM-1CPOS, 83
HMIM-1CT3, 92
HMIM-1E3T3, 93
HMIM-1POS, 82
HMIM-1VE1, 100
HMIM-1VT1, 101
HMIM-24GSW, 78
HMIM-24GSW-PoE, 78
HMIM-2E1, 85
HMIM-2E1T1, 90
HMIM-2E1T1-F, 90
HMIM-2GEE, 80
HMIM-2GEF, 81
HMIM-2T1, 87
HMIM-2VE1, 98
HMIM-4E&M, 103
HMIM-4E1, 85
HMIM-4E1-F, 85
HMIM-4E1T1, 90
HMIM-4E1T1-F, 90
HMIM-4FXO, 102
HMIM-4FXS, 102
HMIM-4GEE, 80
HMIM-4GEF, 81
HMIM-4SAE, 94
HMIM-4T1-F, 87
HMIM-8E1, 86
HMIM-8E1T1, 90
HMIM-8E1T1-F, 90
HMIM-8GEE, 80
HMIM-8GEF, 81

HMIM-8GSW, 78
HMIM-8GSWF, 79
HMIM-8SAE, 94
MIM-16ASE, 67
MIM-16FSW, 48
MIM-16FSW-PoE, 48
MIM-16FXS, 69
MIM-1ATM-OC3, 52
MIM-1CE3, 62
MIM-1CT3, 63
MIM-1POS, 55
MIM-1SHL-4W, 65
MIM-1VE1, 73
MIM-1VT1, 74
MIM-2E1, 57
MIM-2FE, 50
MIM-2FXO, 71
MIM-2GBE, 51
MIM-2SAE, 66
MIM-2T1, 60
MIM-2VE1, 75
MIM-2VT1, 76
MIM-4BSV, 70
MIM-4E&M, 72
MIM-4E1, 57
MIM-4E1-F, 57
MIM-4FE, 50
MIM-4FXO, 71
MIM-4FXS, 71
MIM-4SAE, 66
MIM-4T1-F, 60
MIM-8ASE, 67
MIM-8E1, 58
MIM-8E1-F, 58
MIM-8SAE, 66
MIM-8T1, 61
MIM-8T1-F, 61
MIM-IMA-4T1, 54
MIM-IMA-8E1, 53
SIC-16AS, 13
SIC-1ADSL, 17
SIC-1ADSL-I, 19
SIC-1BS, 20
SIC-1BSV, 25
SIC-1E1-F, 8
SIC-1EPRI, 10
SIC-1FEA, 5
SIC-1FEF, 5
SIC-1FXO, 21
SIC-1FXS, 21
SIC-1GEC, 6
SIC-1SAE, 14
SIC-1T1-F, 11
SIC-1VE1, 26
SIC-1VT1, 27
SIC-2BSV, 25
SIC-2E1-F, 9
SIC-2FXO, 21
SIC-2FXS, 21
SIC-2FXS1FXO, 23
SIC-2SAE, 14
SIC-3G-GSM, 31
SIC-3G-HSPA, 32, 34
SIC-4FSW, 1
SIC-4FSW-PoE, 1
SIC-4G-LTE-A, 39, 41, 42, 44
SIC-4G-LTE-G, 39, 41, 42, 44
SIC-4G-LTE-V, 35, 37
SIC-4GSW, 3
SIC-4GSW-POE, 3
SIC-4SAE, 14
SIC-8AS, 12
SIC-EPRI, 10
SIC-WLAN-b/g/n, 30
SIC-WLAN-b/g/n(NA), 30
VCPM, 141
VPM, 141
XMIM-16FSW, 47

XMIM-24FSW, 47

interface cable

- DFIC, 104
- DFIC-24FSW, 106
- DFIC-24FSW-PoE, 106
- DMIM-24FSW, 50
- DMIM-24FSW-PoE, 50
- DSIC-1SHDSL-8W, 17
- DSIC-4FXS1FXO, 24
- DSIC-9FSW, 2
- DSIC-9FSW-PoE, 2
- FIC, 104
- FIC-16ASE, 129
- FIC-16FSW, 106
- FIC-16FSW-PoE, 106
- FIC-1AE3, 113
- FIC-1AT3, 113
- FIC-1CE3, 122
- FIC-1CT3, 124
- FIC-1VE1, 135
- FIC-1VT1, 137
- FIC-24FXS, 132
- FIC-2E1, 119
- FIC-2FE, 107
- FIC-2VE1, 133
- FIC-2VT1, 134
- FIC-4BSE, 126
- FIC-4E&M, 131
- FIC-4E1, 119
- FIC-4E1-F, 119
- FIC-4FE, 107
- FIC-4FX, 131
- FIC-4FXO, 131
- FIC-4SAE, 128
- FIC-4T1-F, 121
- FIC-8ASE, 129
- FIC-8E1, 120
- FIC-8SAE, 128
- FIC-IMA-4E1, 111
- FIC-IMA-8E1, 111
- FIC-IMA-8T1, 112
- HMIM-16ASE, 96
- HMIM-16FXS, 98
- HMIM-1CE3, 92
- HMIM-1CT3, 93, 94
- HMIM-1VE1, 101
- HMIM-1VT1, 102
- HMIM-24GSW, 79
- HMIM-24GSW-PoE, 79
- HMIM-2E1, 86
- HMIM-2E1T1, 91
- HMIM-2E1T1-F, 91
- HMIM-2GEE, 81
- HMIM-2GEF, 82
- HMIM-2T1, 88
- HMIM-2VE1, 99
- HMIM-4E&M, 103
- HMIM-4E1, 86
- HMIM-4E1-F, 86
- HMIM-4E1T1, 91
- HMIM-4E1T1-F, 91
- HMIM-4FXO, 102
- HMIM-4FXS, 102
- HMIM-4GEE, 81
- HMIM-4GEF, 82
- HMIM-4SAE, 96
- HMIM-4T1-F, 88
- HMIM-8E1, 87
- HMIM-8E1T1, 91
- HMIM-8E1T1-F, 91
- HMIM-8GEE, 81
- HMIM-8GEF, 82
- HMIM-8GSW, 79
- HMIM-8SAE, 96
- MIM-16ASE, 68
- MIM-16FSW, 50
- MIM-16FSW-PoE, 50
- MIM-16FXS, 69

MIM-1CE3, 63
MIM-1CT3, 64
MIM-1SHL-4W, 65
MIM-1VE1, 74
MIM-1VT1, 75
MIM-2E1, 58
MIM-2FE, 51
MIM-2FXO, 72
MIM-2GBE, 52
MIM-2SAE, 67
MIM-2T1, 60
MIM-2VE1, 76
MIM-2VT1, 77
MIM-4BSV, 71
MIM-4E&M, 73
MIM-4E1, 58
MIM-4E1-F, 58
MIM-4FE, 51
MIM-4FXO, 72
MIM-4FXS, 72
MIM-4SAE, 67
MIM-4T1-F, 60
MIM-8ASE, 68
MIM-8E1, 59
MIM-8E1-F, 59
MIM-8SAE, 67
MIM-8T1, 62
MIM-8T1-F, 62
MIM-IMA-4T1, 55
MIM-IMA-8E1, 54
SIC-16AS, 14
SIC-1ADSL, 18
SIC-1ADSL-I, 19
SIC-1BS, 20
SIC-1BSV, 25
SIC-1E1-F, 9
SIC-1EPRI, 11
SIC-1FEA, 5
SIC-1FXO, 22

SIC-1FXS, 22
SIC-1GEC, 7
SIC-1SAE, 15
SIC-1T1-F, 12
SIC-1VE1, 27
SIC-1VT1, 28
SIC-2BSV, 25
SIC-2E1-F, 10
SIC-2FXO, 22
SIC-2FXS, 22
SIC-2FXS1FXO, 23
SIC-2SAE, 15
SIC-3G-GSM, 32
SIC-3G-HSPA, 33, 35
SIC-4FSW, 2
SIC-4FSW-PoE, 2
SIC-4G-LTE-G, 40, 42, 43, 45
SIC-4G-LTE-V, 36, 38
SIC-4GSW, 3
SIC-4GSW-POE, 3
SIC-4SAE, 15
SIC-8AS, 13
SIC-EPRI, 11
SIC-WLAN-b/g/n, 30
SIC-WLAN-b/g/n(NA), 30
XMIM-16FSW, 48
XMIM-24FSW, 48

interface mode switchover

FIC-1CPOS, 117

interface module

cable, 142

connection method, 142

DMIM, 47

DSIC, 1

ESM, 138, 138

HMIM, 78

list, 177

MIM, 47

SIC, 1

VCPM, 138, 139, 140
 VPM, 138, 139, 141
 XMIM, 47

introduction

DFIC-24FSW, 104
 DFIC-24FSW-PoE, 104
 DMIM-24FSW, 48
 DMIM-24FSW-PoE, 48
 DSIC-1SHDSL-8W, 16
 DSIC-4FXS1FXO, 23
 DSIC-9FSW, 1
 DSIC-9FSW-PoE, 1
 ESM-ANDE, 138
 ESM-SNDE, 139
 FIC-16ASE, 128
 FIC-16FSW, 104
 FIC-16FSW-PoE, 104
 FIC-1AE3, 112
 FIC-1AT3, 113
 FIC-1ATM-OC3, 114
 FIC-1CE3, 121
 FIC-1CPOS, 116
 FIC-1CT3, 122
 FIC-1GBE, 107
 FIC-1GEF, 108
 FIC-1POS, 115
 FIC-1VE1, 135
 FIC-1VT1, 136
 FIC-24FXS, 132
 FIC-2E1, 117
 FIC-2FE, 106
 FIC-2GBE, 107
 FIC-2GEF, 108
 FIC-2VE1, 132
 FIC-2VT1, 133
 FIC-4BSE, 124
 FIC-4E&M, 131
 FIC-4E1, 117
 FIC-4E1-F, 117
 FIC-4FE, 106
 FIC-4FX, 130
 FIC-4FXO, 130
 FIC-4SAE, 126
 FIC-4T1-F, 120
 FIC-8ASE, 128
 FIC-8E1, 119
 FIC-8SAE, 126
 FIC-IMA-4E1, 110
 FIC-IMA-8E1, 110
 FIC-IMA-8T1, 111
 HMIM-16ASE, 96
 HMIM-16FXS, 97
 HMIM-1CE3, 91
 HMIM-1CPOS, 83
 HMIM-1CT3, 92
 HMIM-1E3T3, 93
 HMIM-1POS, 82
 HMIM-1VE1, 100
 HMIM-1VT1, 101
 HMIM-24GSW, 78
 HMIM-24GSW-PoE, 78
 HMIM-2E1, 85
 HMIM-2E1T1, 88
 HMIM-2E1T1-F, 88
 HMIM-2GEE, 80
 HMIM-2GEF, 81
 HMIM-2T1, 87
 HMIM-2VE1, 98
 HMIM-4E&M, 103
 HMIM-4E1, 85
 HMIM-4E1-F, 85
 HMIM-4E1T1, 88
 HMIM-4E1T1-F, 88
 HMIM-4FXO, 102
 HMIM-4FXS, 102
 HMIM-4GEE, 80
 HMIM-4GEF, 81
 HMIM-4SAE, 94

HMIM-4T1-F, 87
HMIM-8E1, 86
HMIM-8E1T1, 88
HMIM-8E1T1-F, 88
HMIM-8GEE, 80
HMIM-8GEF, 81
HMIM-8GSW, 78
HMIM-8GSWF, 79
HMIM-8SAE, 94
MIM-16ASE, 67
MIM-16FSW, 48
MIM-16FSW-PoE, 48
MIM-16FXS, 69
MIM-1ATM-OC3, 52
MIM-1CE3, 62
MIM-1CT3, 63
MIM-1POS, 55
MIM-1SHL-4W, 64
MIM-1VE1, 73
MIM-1VT1, 74
MIM-2E1, 56
MIM-2FXO, 71
MIM-2GBE, 51
MIM-2SAE, 66
MIM-2T1, 59
MIM-2VE1, 75
MIM-2VT1, 76
MIM-4BSV, 70
MIM-4E&M, 72
MIM-4E1, 56
MIM-4E1-F, 56
MIM-4FXO, 71
MIM-4FXS, 71
MIM-4SAE, 66
MIM-4T1-F, 59
MIM-8ASE, 67
MIM-8E1, 58
MIM-8E1-F, 58
MIM-8SAE, 66
MIM-8T1, 61
MIM-8T1-F, 61
MIM-IMA-4T1, 54
MIM-IMA-8E1, 53
SIC-16AS, 13
SIC-1ADSL, 17
SIC-1ADSL-I, 18
SIC-1BS, 20
SIC-1BSV, 24
SIC-1E1-F, 8
SIC-1EPRI, 10
SIC-1FEA, 5
SIC-1FEF, 5
SIC-1FXO, 21
SIC-1FXS, 21
SIC-1GEC, 6
SIC-1SAE, 14
SIC-1T1-F, 11
SIC-1VE1, 26
SIC-1VT1, 27
SIC-2BSV, 24
SIC-2E1-F, 9
SIC-2FXO, 21
SIC-2FXS, 21
SIC-2FXS1FXO, 22
SIC-2SAE, 14
SIC-3G-GSM, 31
SIC-3G-HSPA, 32, 33
SIC-4FSW, 1
SIC-4FSW-PoE, 1
SIC-4GSW, 2
SIC-4GSW-POE, 2
SIC-4SAE, 14
SIC-8AS, 12
SIC-EPRI, 10
SIC-WLAN-b/g/n, 30
SIC-WLAN-b/g/n(NA), 30, 30
VCPM, 140
VPM, 141

XMIM-16FSW, [47](#)
 XMIM-24FSW, [47](#)
 ISDN BRI interface module
 FIC-4BSE, [124](#)
 SIC-1BS, [20](#)

J

jumper setting
 FIC-4BSE, [124](#)

L

LED

DMIM-24FSW, [49](#)
 DMIM-24FSW-PoE, [49](#)
 DSIC-1SHDSL-8W, [16](#)
 DSIC-4FXS1FXO, [24](#)
 ESM-ANDE, [138](#)
 ESM-SNDE, [139](#)
 FIC-16ASE, [129](#)
 FIC-1AE3, [112](#)
 FIC-1AT3, [113](#)
 FIC-1ATM-OC3, [114](#)
 FIC-1CE3, [122](#)
 FIC-1CPOS, [116](#)
 FIC-1CT3, [123](#)
 FIC-1GBE, [108](#)
 FIC-1GEF, [109](#)
 FIC-1POS, [115](#)
 FIC-1VE1, [135](#)
 FIC-1VT1, [136](#)
 FIC-24FXS, [132](#)
 FIC-2E1, [118](#)
 FIC-2FE, [107](#)
 FIC-2GBE, [108](#)
 FIC-2GEF, [109](#)
 FIC-2VE1, [133](#)
 FIC-2VT1, [134](#)
 FIC-4BSE, [125](#)
 FIC-4E&M, [131](#)
 FIC-4E1, [118](#)
 FIC-4E1-F, [118](#)
 FIC-4FE, [107](#)
 FIC-4FX, [130](#)
 FIC-4FXO, [130](#)
 FIC-4SAE, [128](#)
 FIC-4T1-F, [121](#)
 FIC-8ASE, [129](#)
 FIC-8E1, [120](#)
 FIC-8SAE, [128](#)
 FIC-IMA-4E1, [110](#)
 FIC-IMA-8E1, [110](#)
 FIC-IMA-8T1, [111](#)
 HMIM-16ASE, [96](#)
 HMIM-16FXS, [97](#)
 HMIM-1CE3, [91](#)
 HMIM-1CPOS, [84](#)
 HMIM-1CT3, [93](#)
 HMIM-1E3T3, [94](#)
 HMIM-1POS, [83](#)
 HMIM-1VE1, [100](#)
 HMIM-1VT1, [101](#)
 HMIM-24GSW, [78](#)
 HMIM-24GSW-PoE, [78](#)
 HMIM-2E1, [85](#)
 HMIM-2E1T1, [90](#)
 HMIM-2E1T1-F, [90](#)
 HMIM-2GEE, [80](#)
 HMIM-2GEF, [81](#)
 HMIM-2T1, [88](#)
 HMIM-2VE1, [98](#)
 HMIM-4E&M, [103](#)
 HMIM-4E1, [85](#)
 HMIM-4E1-F, [85](#)
 HMIM-4E1T1, [90](#)
 HMIM-4E1T1-F, [90](#)
 HMIM-4FXO, [102](#)
 HMIM-4FXS, [102](#)
 HMIM-4GEE, [80](#)
 HMIM-4GEF, [81](#)

HMIM-4SAE, 95
HMIM-4T1-F, 88
HMIM-8E1, 87
HMIM-8E1T1, 90
HMIM-8E1T1-F, 90
HMIM-8GEE, 80
HMIM-8GEF, 81
HMIM-8GSW, 78
HMIM-8GSWF, 79
HMIM-8SAE, 95
MIM-16ASE, 68
MIM-16FSW, 49
MIM-16FSW-PoE, 49
MIM-16FXS, 69
MIM-1ATM-OC3, 52
MIM-1CE3, 63
MIM-1CT3, 64
MIM-1POS, 56
MIM-1SHL-4W, 65
MIM-1VE1, 73
MIM-1VT1, 74
MIM-2E1, 57
MIM-2FE, 51
MIM-2FXO, 71
MIM-2GBE, 51
MIM-2SAE, 67
MIM-2T1, 60
MIM-2VE1, 75
MIM-2VT1, 77
MIM-4BSV, 70
MIM-4E&M, 72
MIM-4E1, 57
MIM-4E1-F, 57
MIM-4FE, 51
MIM-4FXO, 71
MIM-4FXS, 71
MIM-4SAE, 67
MIM-4T1-F, 60
MIM-8ASE, 68
MIM-8E1, 59
MIM-8E1-F, 59
MIM-8SAE, 67
MIM-8T1, 61
MIM-8T1-F, 61
MIM-IMA-4T1, 55
MIM-IMA-8E1, 54
SIC-16AS, 14
SIC-1ADSL, 18
SIC-1ADSL-I, 19
SIC-1BS, 20
SIC-1BSV, 25
SIC-1E1-F, 8
SIC-1EPRI, 10
SIC-1FEA, 5
SIC-1FEF, 6
SIC-1FXO, 22
SIC-1FXS, 22
SIC-1GEC, 7
SIC-1SAE, 15
SIC-1T1-F, 12
SIC-1VE1, 26
SIC-1VT1, 27
SIC-2BSV, 25
SIC-2E1-F, 9
SIC-2FXO, 22
SIC-2FXS, 22
SIC-2FXS1FXO, 23
SIC-2SAE, 15
SIC-3G-GSM, 31
SIC-3G-HSPA, 33, 34
SIC-4G-LTE-A, 39, 41, 43, 45
SIC-4G-LTE-G, 39, 41, 43, 45
SIC-4G-LTE-V, 36, 38
SIC-4GSW, 3
SIC-4GSW-POE, 3
SIC-4SAE, 15
SIC-8AS, 13
SIC-EPRI, 10

SIC-WLAN-b/g/n, 30

VCPM, 141

XMIM-16FSW, 47

XMIM-24FSW, 47

M

MIM

ATM interface module, 52

E1/T1 interface module, 56

E3/T3 interface module, 62

Ethernet interface module, 50

Ethernet switching module, 47

POS (SDH/SONET) interface module, 55

serial interface module, 65

voice interface module, 68

xDSL interface module, 64

O

optical fiber

FIC-1ATM-OC3, 114

FIC-1CPOS, 117

FIC-1GBE, 108

FIC-1GEF, 109

FIC-1POS, 115

FIC-2GBE, 108

FIC-2GEF, 109

HMIM-1CPOS, 84

HMIM-1POS, 83

HMIM-8GSWF, 80

MIM-1ATM-OC3, 53

MIM-1POS, 56

SIC-1FEF, 6

P

POS (SDH/SONET) interface module

FIC-1POS, 115

HMIM-1POS, 82

MIM-1POS, 55

purchase guide, 182

DFIC, 190

DMIM, 187

DSIC, 182

ESM, 192

FIC, 190

HMIM, 189

MIM, 187

SIC, 182

VCPM, 139, 192

VPM, 139, 192

XMIM, 187

R

removal

ESM-ANDE, 138

ESM-SNDE, 139

VCPM, 141, 141

S

serial interface module

FIC-16ASE, 128

FIC-4SAE, 126

FIC-8ASE, 128

FIC-8SAE, 126

HMIM-16ASE, 96

HMIM-4SAE, 94

HMIM-8SAE, 94

MIM-16ASE, 67

MIM-2SAE, 66

MIM-4SAE, 66

MIM-8ASE, 67

MIM-8SAE, 66

SIC-16AS, 13

SIC-1SAE, 14

SIC-2SAE, 14

SIC-4SAE, 14

SIC-8AS, 12

SIC

3G interface module, 30

4G interface module, 35

E1/T1 interface module, 7

- Ethernet interface module, 4
- Ethernet switching module, 1
- ISDN BRI interface module, 19
- serial interface module, 12
- voice interface module, 21
- WLAN interface module, 29
- XDSL interface module, 16

synchronous interface

- FIC-4SAE, 126
- FIC-8SAE, 126

V

voice interface module

- DSIC-4FXS1FXO, 23
- FIC-1VE1, 135
- FIC-1VT1, 136
- FIC-24FXS, 132
- FIC-2VE1, 132
- FIC-2VT1, 133
- FIC-4E&M, 131
- FIC-4FX, 130
- FIC-4FXO, 130
- HMIM-16FXS, 97
- HMIM-1VE1, 100
- HMIM-1VT1, 101
- HMIM-2VE1, 98
- HMIM-4E&M, 103
- HMIM-4FXO, 102
- HMIM-4FXS, 102
- MIM-16FXS, 69
- MIM-1VE1, 73
- MIM-1VT1, 74
- MIM-2FXO, 71
- MIM-2VE1, 75
- MIM-2VT1, 76
- MIM-4BSV, 70
- MIM-4E&M, 72
- MIM-4FXO, 71
- MIM-4FXS, 71

- SIC-1BSV, 24
- SIC-1FXO, 21
- SIC-1FXS, 21
- SIC-1VE1, 26
- SIC-1VT1, 27
- SIC-2BSV, 24
- SIC-2FXO, 21
- SIC-2FXS, 21
- SIC-2FXS1FXO, 22

W

WLAN interface module

- SIC-WLAN-b/g/n, 30
- SIC-WLAN-b/g/n(NA), 30

working mode

- HMIM-1CPOS, 84, 84, 84

X

XDSL interface module

- SIC-1ADSL, 17
- SIC-1ADSL-I, 18

xDSL interface module

- MIM-1SHL-4W, 64

XDSL interface module

- DSIC-1SHDSL-8W, 16

XMIM

- Ethernet switching module, 47