

# MC93XX

Mobile Computer

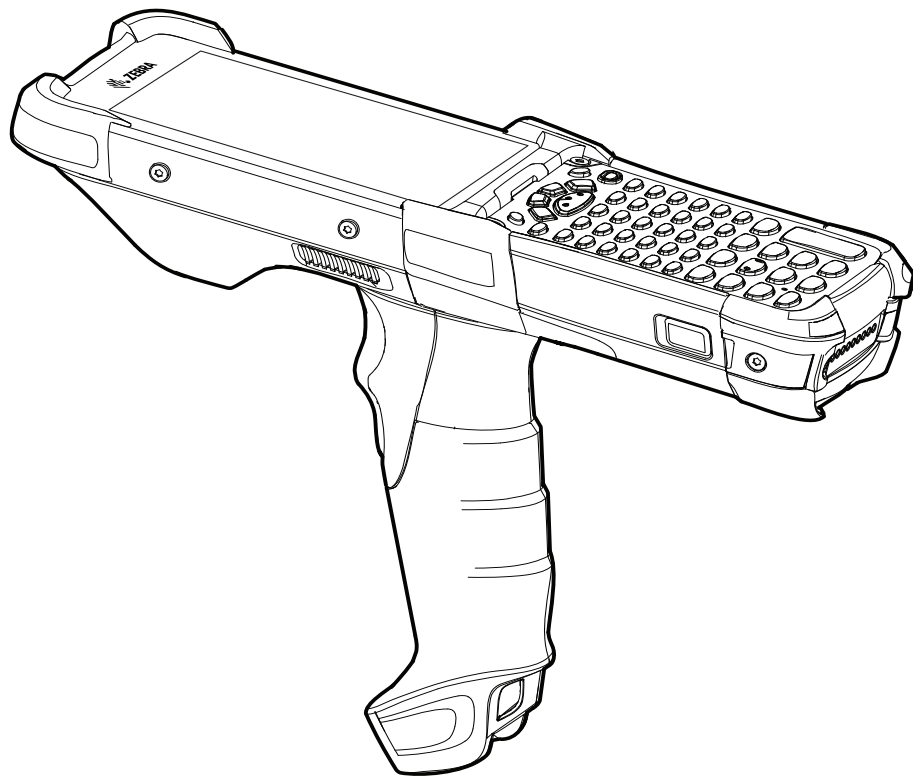

## Integrator Guide



**ZEBRA**

## Copyright

ZEBRA and the stylized Zebra head are trademarks of Zebra Technologies Corporation, registered in many jurisdictions worldwide. Google, Android, Google Play and other marks are trademarks of Google LLC; Oreo is a trademark of Mondelez International, Inc. group. All other trademarks are the property of their respective owners. ©2021 Zebra Technologies Corporation and/or its affiliates. All rights reserved.

COPYRIGHTS & TRADEMARKS: For complete copyright and trademark information, go to [www.zebra.com/copyright](http://www.zebra.com/copyright).

WARRANTY: For complete warranty information, go to [www.zebra.com/warranty](http://www.zebra.com/warranty).

END USER LICENSE AGREEMENT: For complete EULA information, go to [www.zebra.com/eula](http://www.zebra.com/eula).

## Terms of Use

- Proprietary Statement

This manual contains proprietary information of Zebra Technologies Corporation and its subsidiaries (“Zebra Technologies”). It is intended solely for the information and use of parties operating and maintaining the equipment described herein. Such proprietary information may not be used, reproduced, or disclosed to any other parties for any other purpose without the express, written permission of Zebra Technologies.

- Product Improvements

Continuous improvement of products is a policy of Zebra Technologies. All specifications and designs are subject to change without notice.

- Liability Disclaimer

Zebra Technologies takes steps to ensure that its published Engineering specifications and manuals are correct; however, errors do occur. Zebra Technologies reserves the right to correct any such errors and disclaims liability resulting therefrom.

- Limitation of Liability

In no event shall Zebra Technologies or anyone else involved in the creation, production, or delivery of the accompanying product (including hardware and software) be liable for any damages whatsoever (including, without limitation, consequential damages including loss of business profits, business interruption, or loss of business information) arising out of the use of, the results of use of, or inability to use such product, even if Zebra Technologies has been advised of the possibility of such damages. Some jurisdictions do not allow the exclusion or limitation of incidental or consequential damages, so the above limitation or exclusion may not apply to you.

## Revision History

Changes to the original guide are listed below:

Change	Date	Description
-01 Rev A	03/2019	Initial release.
-02 Rev A	07/2019	Updated to include MC93XX freezer configuration.
-03 Rev A	10/2019	Updated to include SE4750 Direct Part Marking (DPM)/Direct Part Marking - Wide (DPW), SE4770 scanner, and additional keypads.
-04 Rev A	02/2020	Updated <b>Installing a microSD Card</b> section with supported SD cards.
-05 Rev A	04/2020	Added Decode Zone specifications.
-06 Rev A	10/2021	Updated GMS Restricted topic.

# Table of Contents

Copyright .....	2
Terms of Use .....	2
Revision History .....	2
<b>About This Guide .....</b>	<b>11</b>
Introduction .....	11
Documentation Set .....	11
Configurations .....	12
Software Versions .....	12
Chapter Descriptions .....	13
Notational Conventions .....	13
Related Documents .....	14
Service Information .....	14
Provide Documentation Feedback .....	15
<b>Getting Started .....</b>	<b>16</b>
Introduction .....	16
Unpacking .....	16
Setting Up the Device .....	16
Installing a microSD Card .....	17
Charging the Device .....	22
Charging the Main Battery .....	23
Backup Power .....	24
Hot Swap Mode .....	24
Removing and Replacing Keypads .....	24
<b>Accessories .....</b>	<b>28</b>
Introduction .....	28
MC93XX Accessories .....	28
1-Slot USB Charge Cradle with Spare Battery Charger .....	32

## Table of Contents

Setup .....	32
Charging the Device .....	32
Charging Temperature .....	34
4-Slot Charge Only ShareCradle .....	35
Setup .....	35
Charging the Devices .....	35
Charging Temperature .....	36
4-Slot Ethernet ShareCradle .....	37
Setup .....	37
Charging the Devices .....	37
Daisy-chaining Ethernet ShareCradles .....	38
Ethernet Settings .....	39
Configuring Ethernet Proxy Settings .....	39
Configuring Ethernet Static IP Address .....	40
Establishing Ethernet Connection .....	41
LED Indicators .....	42
Charging Temperature .....	42
16-Slot Spare Battery Charger .....	43
Setup .....	43
Charging the Spare Batteries .....	43
Charging Temperature .....	44
USB Charge/Com Snap-on Cup .....	45
Connecting to the Device .....	45
Connecting the USB Charge/Com Snap-on Cup Cable to Host Computer .....	46
Charging the Device .....	47
Disconnecting the USB Charge/Com Snap-on Cup .....	47
MC93XX Charge Only Adapter .....	48
Charge Only Adapter Installation .....	49
Rubber Boot .....	52
Installing the Hand Strap .....	54
4-Slot Charge Only ShareCradle Rack Installation .....	55
Rack Mount Installation .....	59
Wall Installation .....	62
Bottom Tray Assembly .....	62
Bracket Wall Mounting .....	62
<b>Settings.....</b>	<b>64</b>
Introduction .....	64
WLAN Configuration .....	64
Configuring a Secure Wi-Fi Network .....	64
Manually Adding a Wi-Fi Network .....	65
Configuring for a Proxy Server .....	66



## Table of Contents

Configuring the Device to Use a Static IP Address .....	67
Wi-Fi Preferences .....	68
Additional Wi-Fi Settings .....	69
Wi-Fi Direct .....	69
WPS Push Button .....	70
WPS Pin Entry .....	71
Setting Screen Lock .....	71
Setting Screen Lock Using PIN .....	72
Setting Screen Unlock Using Password .....	72
Setting Screen Unlock Using Pattern .....	73
Showing Passwords .....	74
Remapping a Button .....	74
Accounts .....	75
Language Usage .....	76
Changing the Language Setting .....	76
Adding Words to the Dictionary .....	76
Keyboard Settings .....	76
PTT Express Configuration .....	76
RxLogger .....	76
RxLogger Configuration .....	77
RxLogger Settings .....	78
ANR Module .....	78
Kernel Module .....	78
Logcat Module .....	79
LTS Module .....	80
Ramoops Module .....	80
Resource Module .....	81
Snapshot Module .....	81
TCPDump Module .....	82
Tombstone Module .....	82
Configuration File .....	82
Enabling Logging .....	82
Disabling Logging .....	82
Extracting Log Files .....	83
RxLogger Utility .....	83
App View .....	83
Viewing Logs .....	83
Backup .....	85
Archive Data .....	85
Overlay View .....	85
Initiating the Main Chat Head .....	85
Removing the Main Chat Head .....	86
Viewing Logs .....	86

## Table of Contents

Removing a Sub Chat Head Icon .....	87
Backing Up In Overlay View .....	87
About Phone .....	87
<b>USB Communication .....</b>	<b>89</b>
Introduction .....	89
Transferring Files with a Host Computer via USB .....	89
Transferring Files .....	89
Transferring Photos .....	90
Disconnect from the Host Computer .....	90
<b>DataWedge .....</b>	<b>91</b>
Introduction .....	91
Basic Scanning .....	91
Barcode Capture with Imager .....	91
Profiles .....	92
Profile0 .....	92
Plug-ins .....	92
Input Plug-ins .....	93
Process Plug-ins .....	93
Output Plug-ins .....	93
Profiles Screen .....	93
Profile Context Menu .....	94
Options Menu .....	94
Disabling DataWedge .....	95
Creating a New Profile .....	95
Profile Configuration .....	95
Associating Applications .....	96
Data Capture Plus .....	98
Barcode Input .....	100
Enabled .....	100
Scanner Selection .....	100
Auto Switch to Default on Event .....	100
Configure Scanner Settings .....	101
Decoders .....	101
Decoder Params .....	104
UPC EAN Params .....	109
Reader Params .....	112
Scan Params .....	115
UDI Params .....	116
Multibarcodes params .....	116
Keep enabled on suspend .....	116

Voice Input .....	116
Keystroke Output .....	117
Intent Output .....	118
Intent Overview .....	119
IP Output .....	120
Usage .....	121
Using IP Output with IPWedge .....	122
Using IP Output without IPWedge .....	123
Generating Advanced Data Formatting Rules .....	124
Configuring ADF Plug-in .....	124
Creating a Rule .....	125
Defining a Rule .....	125
Defining Criteria .....	126
Defining an Action .....	127
Deleting a Rule .....	128
Order Rules List .....	128
Deleting an Action .....	129
ADF Example .....	129
DataWedge Settings .....	132
Importing a Configuration File .....	133
Exporting a Configuration File .....	134
Importing a Profile File .....	134
Exporting a Profile .....	134
Restoring DataWedge .....	134
Configuration and Profile File Management .....	135
Enterprise Folder .....	135
Auto Import .....	135
Programming Notes .....	135
Capture Data and Taking a Photo in the Same Application .....	135
Disable DataWedge on Device .....	136
Reporting .....	136
Soft Scan Trigger .....	136
Function Prototype .....	136
Parameters .....	136
Scanner Input Plugin .....	137
Function Prototype .....	137
Parameters .....	137
Return Values .....	137
Example .....	138
Comments .....	138
Enumerate Scanners .....	138
Function Prototype .....	138
Parameters .....	138
Return Values .....	139

## Table of Contents

Example .....	140
Comments .....	140
Set Default Profile .....	141
Default Profile Recap .....	141
Usage Scenario .....	141
Function Prototype .....	141
Parameters .....	141
Return Values .....	141
Example .....	142
Comments .....	142
Reset Default Profile .....	142
Function Prototype .....	143
Parameters .....	143
Return Values .....	143
Example .....	143
Comments .....	143
Switch To Profile .....	144
Profiles Recap .....	144
Usage Scenario .....	144
Function Prototype .....	144
Parameters .....	144
Return Values .....	145
Example .....	145
Comments .....	145
Notes .....	146
<b>Application Deployment.....</b>	<b>147</b>
Introduction .....	147
Security .....	147
Secure Certificates .....	147
Installing a Secure Certificate .....	147
Configuring Credential Storage Settings .....	148
Development Tools .....	148
Android Application Development .....	148
Development Workstation .....	148
Target Device .....	149
EMDK for Android .....	149
StageNow .....	149
GMS Restricted .....	149
ADB USB Setup .....	150
Enabling USB Debugging .....	150
Application Installation .....	150
Using Android Studio .....	151
Installing Applications Using the USB Connection .....	151

## Table of Contents

Installing Applications Using the Android Debug Bridge .....	152
Installing Applications Using a microSD Card .....	153
Uninstalling an Application .....	154
Performing a System Update .....	155
Downloading the System Update Package .....	155
Using microSD Card .....	155
Using ADB .....	156
Verify System Update Installation .....	157
Performing an Enterprise Reset .....	157
Downloading the Enterprise Reset Package .....	157
Using microSD Card .....	157
Using ADB .....	158
Performing a Factory Reset .....	159
Downloading the Factory Reset Package .....	159
Using microSD Card .....	159
Using ADB .....	160
Storage .....	160
Random Access Memory .....	161
Internal Storage .....	161
External Storage .....	162
Formatting a microSD Card as Portable Storage .....	163
Formatting a microSD Card as Internal Memory .....	164
Enterprise Folder .....	166
App Management .....	166
Viewing App Details .....	167
Managing Downloads .....	167
<b>Maintenance and Troubleshooting .....</b>	<b>169</b>
Introduction .....	169
Maintaining the Device .....	169
Battery Safety Guidelines .....	169
Cleaning Instructions .....	170
Approved Cleanser Active Ingredients .....	170
Harmful Ingredients .....	170
Device Cleaning Instructions .....	171
Special Cleaning Notes .....	171
Cleaning Materials Required .....	171
Cleaning Frequency .....	171
Cleaning the Device .....	171
Housing .....	171
Display .....	171

## Table of Contents

Exit Window .....	172
Cleaning Battery Connectors .....	172
Cleaning Cradle Connectors .....	172
Troubleshooting .....	173
MC93XX .....	173
1-Slot USB Charge Cradle .....	175
4-Slot Charge Only Cradle .....	176
4-Slot Ethernet ShareCradle Troubleshooting .....	177
4-Slot Spare Battery Charger Troubleshooting .....	178
16-Slot Spare Battery Charger Troubleshooting .....	178
USB Charge/Com Snap-on Cup Troubleshooting .....	179
<b>Specifications.....</b>	<b>180</b>
Introduction .....	180
MC93XX Technical Specifications .....	180
SE965 Decode Zone .....	183
SE4750-SR Decode Zone .....	185
SE4770-SR Decode Zone .....	185
SE4850-ER Decode Zone .....	186
I/O Connector Pin-Outs .....	187
MC93XX Accessory Specifications .....	187
1-Slot USB Charge Cradle with Spare Battery Charger Technical Specifications .....	187
4-Slot Charge Only ShareCradle Technical Specifications .....	188
4-Slot Ethernet ShareCradle Technical Specifications .....	188
4-Slot Spare Battery Charger Technical Specifications .....	189
16-Slot Spare Battery Charger Technical Specifications .....	190
USB Charge/Com Snap-on Cup Technical Specifications .....	190
<b>Index.....</b>	<b>191</b>

# About This Guide

## Introduction

This guide provides information about setting up and configuring the device and its accessories.



**NOTE:** Screens and windows pictured in this guide are samples and can differ from actual screens.

## Documentation Set

The documentation set provides information for specific user needs, and includes:

- MC93XX Quick Start Guide - describes how to get the device up and running.
- MC93XX User Guide - describes how to use the device.
- MC93XX Integrator Guide - describes how to set up the device and accessories.
- MC93XX Regulatory Guide - provides all regulatory, service, and EULA information for the device.

## Configurations

This guide covers the following configurations:

**Table 1** Configurations

Configuration	Radios	Display	Memory	Data Capture Options	Operating System
MC93XX–G Base	WLAN: IEEE 802.11 <i>a/b/g/n/ac/d/h/i/r/w</i> WPAN: Bluetooth v5.0 Low Energy	4.3" WVGA (800 x 480) LCD	4 GB RAM / 32 GB Flash	SE965 1D, SE4750-SR 2D, SE4850-ER 2D SE4750DPM SE4750DPW SE4770 2D	Android-based GMS 8.1.0
Package 1 MC93XX–G Base + NFC (Tap to Pair) + Vibrator Motor	WLAN: IEEE 802.11 <i>a/b/g/n/ac/d/h/i/r/w</i> WPAN: Bluetooth v5.0 Low Energy	4.3" WVGA (800 x 480) LCD	4 GB RAM / 32 GB Flash	SE965 1D, SE4750-SR 2D, SE4850-ER 2D SE4750DPM SE4750DPW SE4770 2D	Android-based GMS 8.1.0
Package 2 Package 1 + Front and Rear Facing Cameras	WLAN: IEEE 802.11 <i>a/b/g/n/ac/d/h/i/r/w</i> WPAN: Bluetooth v5.0 Low Energy	4.3" WVGA (800 x 480) LCD	4 GB RAM / 32 GB Flash	SE965 1D, SE4750-SR 2D, SE4850-ER 2D SE4770 2D	Android-based GMS 8.1.0
MC93XX-G Freezer + NFC (Tap to Pair) + Vibrator Motor	WLAN: IEEE 802.11 <i>a/b/g/n/ac/d/h/i/r/w</i> WPAN: Bluetooth v5.0 Low Energy	4.3" WVGA (800 x 480) LCD. Optically Bonded to the Touch Panel.	4 GB RAM / 32 GB Flash	SE965 1D, SE4750-SR 2D, SE4850-ER 2D SE4770 2D	Android-based GMS 8.1.0

## Software Versions

To determine the current software versions:

1. Swipe down from the Status bar to open the Quick Settings bar.
2. Touch  > **System**.
3. Touch **About phone**.



4. Scroll to view the following information:

- **Status**
- **Battery information**
- **SW components**
- **Legal information**
- **Model**
- **Android version**
- **Android security patch level**
- **Kernel version**
- **Build Fingerprint**
- **Build number.**

To determine the device serial number, touch **About phone > Status**.

- **Serial number**

## Chapter Descriptions

Topics covered in this guide are as follows:

- [Getting Started](#) provides information on getting the device up and running for the first time.
- [Accessories](#) describes the available accessories and how to use them with the device.
- [Settings](#) provides the settings for configuring the device.
- [USB Communication](#) describes how to connect the device to a host computer using USB.
- [DataWedge](#) describes how to use and configure the DataWedge application.
- [Application Deployment](#) provides information for developing and managing applications.
- [Maintenance and Troubleshooting](#) includes instructions on cleaning and storing the device, and provides troubleshooting solutions for potential problems during device operation.
- [Specifications](#) provides the technical specifications for the device.

## Notational Conventions

The following conventions are used in this document:

- **Bold** text is used to highlight the following:
  - Dialog box, window and screen names
  - Drop-down list and list box names
  - Check box and radio button names
  - Icons on a screen
  - Key names on a keypad
  - Button names on a screen.
- Bullets (•) indicate:
  - Action items
  - Lists of alternatives
  - Lists of required steps that are not necessarily sequential.
- Sequential lists (for example, those that describe step-by-step procedures) appear as numbered lists.

### Related Documents

- MC93XX Quick Start Guide, p/n MN-003413-xx.
- MC93XX Regulatory Guide, p/n MN-003409-xx.
- MC93XX User Guide, p/n MN-003228-xx.

For the latest version of this guide and all guides, go to: [www.zebra.com/support](http://www.zebra.com/support)

### Service Information

If you have a problem with your equipment, contact Customer Support for your region. Contact information is available at: [www.zebra.com/support](http://www.zebra.com/support).

When contacting support, please have the following information available:

- Serial number of the unit (found on manufacturing label)
- Model number or product name (found on manufacturing label)
- Software type and version number

Customer Support responds to calls by email or telephone within the time limits set forth in support agreements.

If the problem cannot be solved by Customer Support, you may need to return the equipment for servicing and will be given specific directions. We are not responsible for any damages incurred during shipment if the approved shipping container is not used. Shipping the units improperly can possibly void the warranty. Remove the microSD card from the device before shipping for service.

If the device was purchased from a business partner, contact that business partner for support.

If the manufacturing label is worn or missing, use an NFC enabled device to read the NFC tag under the battery compartment. You can download the NFC Reader application for free from the Google Play store.

**Figure 1** Manufacturing Label Location

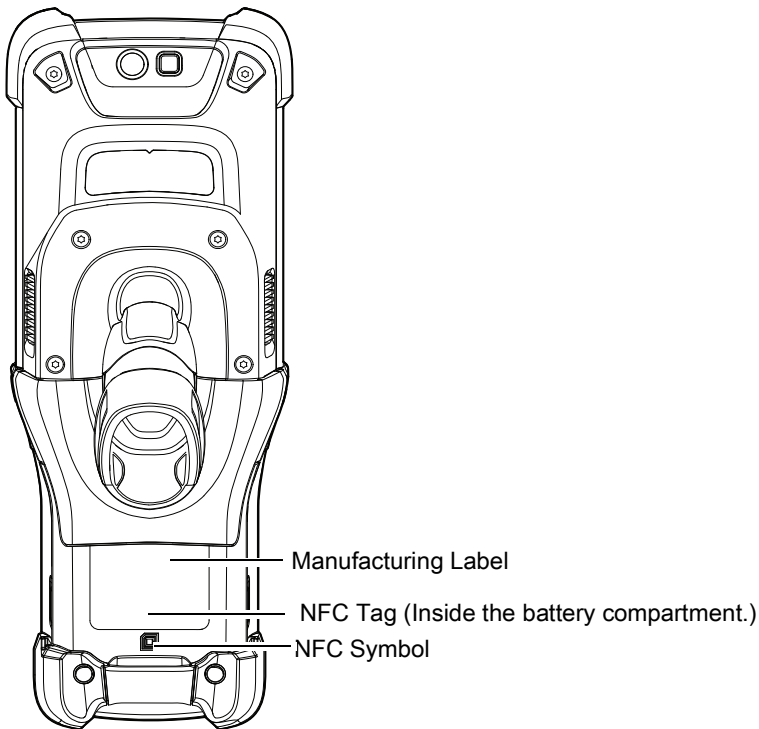

## Provide Documentation Feedback

If you have comments, questions, or suggestions about this guide, send an email to [EVM-Techdocs@zebra.com](mailto:EVM-Techdocs@zebra.com).

# Getting Started

## Introduction

This chapter provides information for getting the device up and running for the first time.

## Unpacking

Carefully remove all protective material from the device and save the shipping container for later storage and shipping.

Verify the following items are in the box:

- Device
- Lithium-ion battery
- Regulatory Guide.

Inspect the equipment for damage. If any equipment is missing or damaged, contact the Zebra Support Center immediately.

## Setting Up the Device

To start using the device for the first time:

1. Install a microSD card (optional)
2. Install the battery
3. Charge the device
4. Power on the device.

## Installing a microSD Card

The microSD card slot provides secondary non-volatile storage. The slot is located under the keypad module. Refer to the documentation provided with the card for more information, and follow the manufacturer's recommendations for use. It is strongly recommended that prior to use, you must format the microSD card on the device.



**NOTE:** The following microSD cards were tested and are validated for use with the MC93XX:

- SanDisk 16GB (SDSDQ-016G-A11M)
- SanDisk 32GB (SDSDQ-032G-A11M)
- SanDisk 64GB (SDSDQUA-064G-U46A)
- SanDisk 128GB (SDSDQUI-128G-A46)
- SanDisk 200GB (SDSDQUAN-200G-A4A).



**CAUTION:** Follow proper electrostatic discharge (ESD) precautions to avoid damaging the microSD card. Proper ESD precautions include, but are not limited to, working on an ESD mat and ensuring that the operator is properly grounded.

1. Power off the device.
2. Remove the battery.
3. Using a Torx T8 screwdriver with a large grip, remove the two keypad latch screws from inside the battery slot.

**Figure 2** Remove Keypad Latch Screws

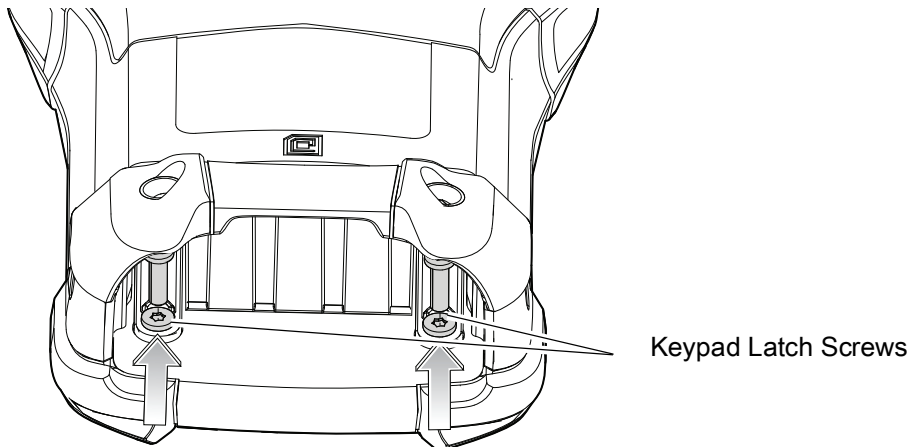

- Slide the keypad latches toward the bottom of the device.

**Figure 3** Release Keypad Latches

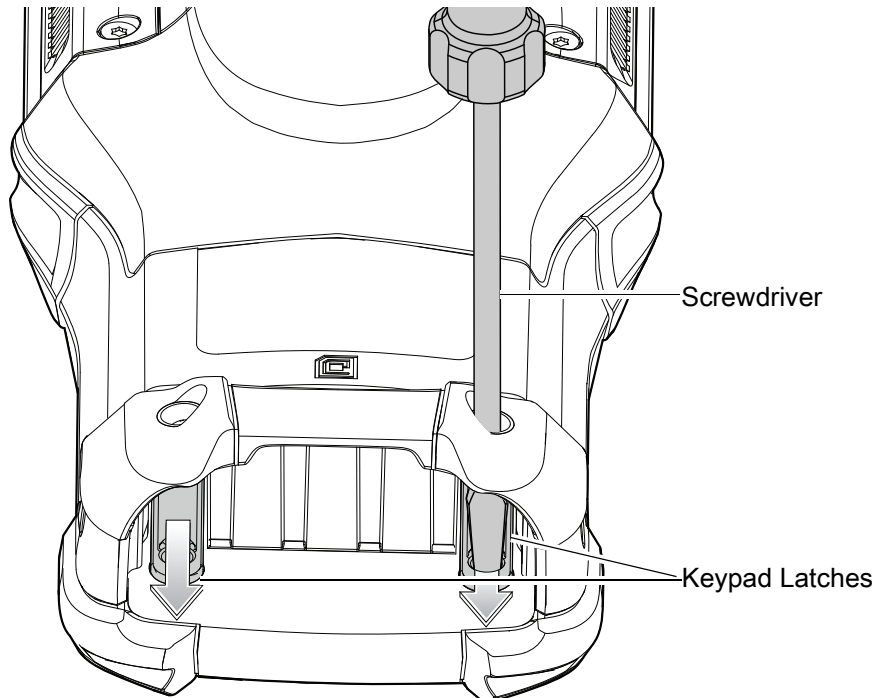

**NOTE:** If the keypad latches are hard to move, use a screwdriver to gently slide them towards the bottom of the device.

- Turn the device over so that the keypad is visible.
- Using a Torx T8 screwdriver with a large grip, remove the two keypad assembly screws from the top of the keypad.

**Figure 4** Remove Keypad

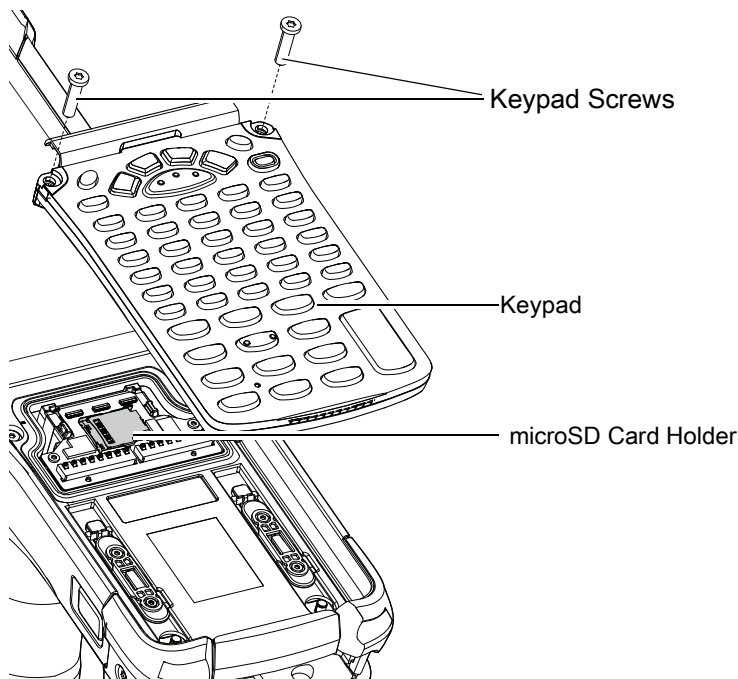

7. Lift the keypad from the device.
8. Slide the microSD card holder to the Open position.

**Figure 5** Open microSD Card Holder

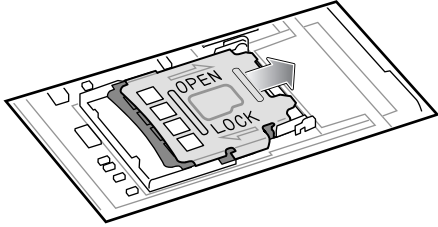

9. Lift the microSD card holder.

**Figure 6** Lift microSD Card Holder

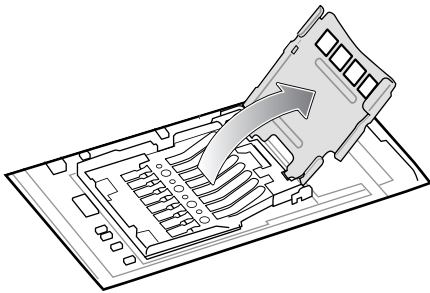

10. Insert the microSD card into the card holder door ensuring that the card slides into the holding tabs on each side of the door.

**Figure 7** Insert microSD Card into Holder

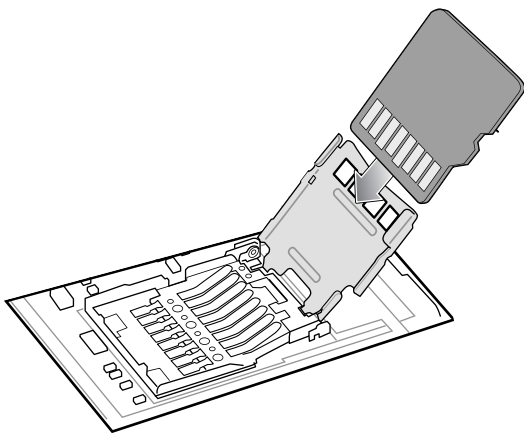

11. Close the microSD card holder door and slide the door to the Lock position.

**Figure 8** Close and Lock microSD Card in Holder

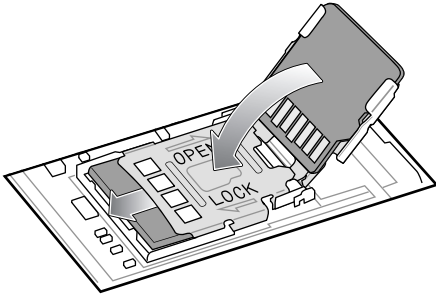

12. Align the keypad along the bottom ridge of the device, and then lay it flat.

**Figure 9** Replace Keypad

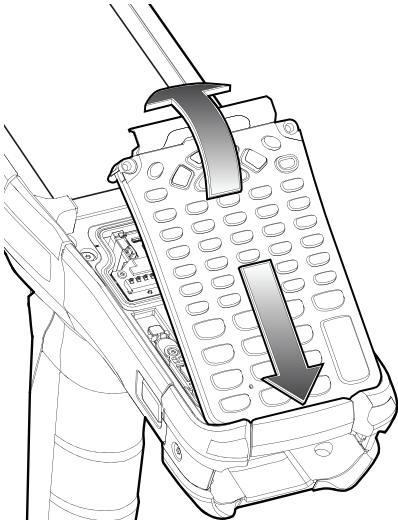



- Using a Torx T8 screwdriver with a large grip and a long shaft, secure the keypad to the device using the two screws. Torque screws to 5.8 kgf-cm or 5.0 lbf-in.

**Figure 10** Replace Keypad Screws

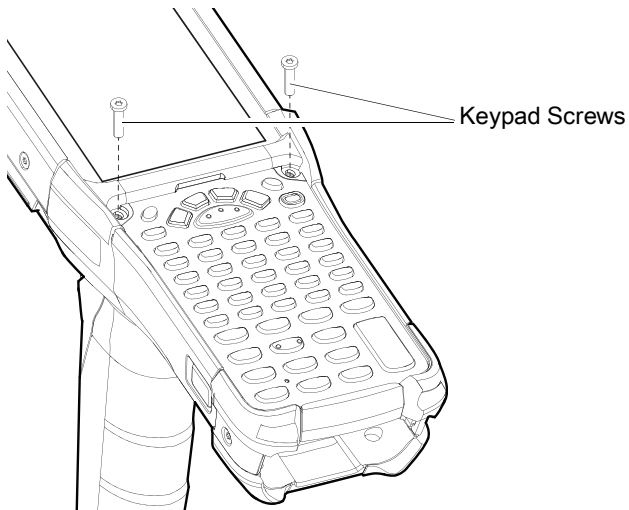

- Turn the device over so that the keypad latches are visible.

- Slide both the keypad latches toward the top of the device.

**Figure 11** Slide Keypad Latches

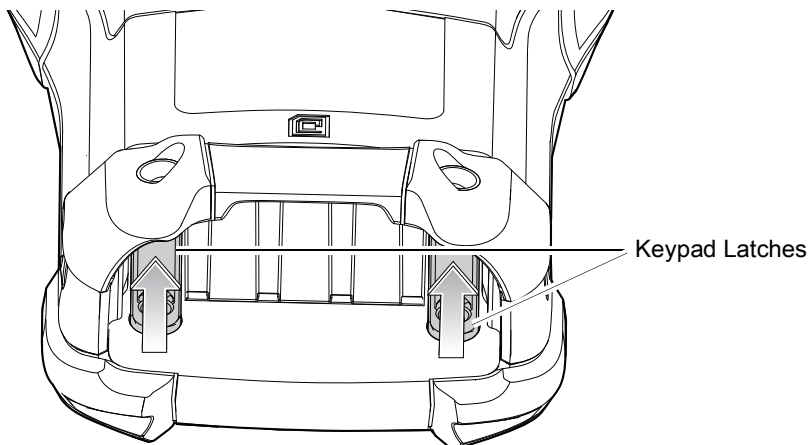

16. Using a Torx T8 screwdriver, replace the two keypad latch screws inside the battery slot and torque to 5.8 kgf-cm or 5.0 lbf-in.

**Figure 12** Replace Keypad Latch Screws

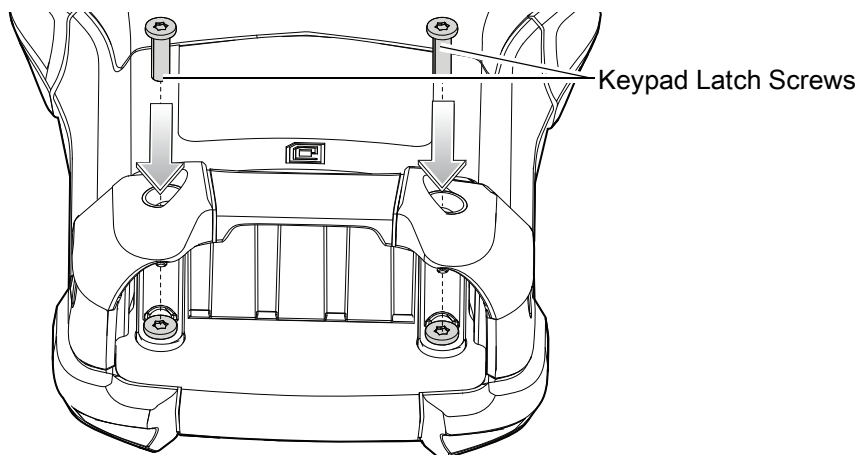

17. Insert the battery.

18. Press and hold the Power key to power on the device.

## Charging the Device

Use one of the following accessories to charge the battery.

**Table 2** Charging and Communication

Description	Part Number	Charging		Communication	
		Battery (In Device)	Spare Battery	USB	Ethernet
1-Slot USB Charge Cradle with Spare Battery Charger	CRD-MC93-2SUCHG-01	Yes	Yes	Yes	No
4-Slot Charge Only ShareCradle	CRD-MC93-4SCHG-01	Yes	No	No	No
4-Slot Spare Battery Charger	SAC-MC93-4SCHG-01	No	Yes	No	No
4-Slot Ethernet ShareCradle	CRD-MC93-4SETH-01	Yes	No	No	Yes
16-Slot Spare Battery Charger	SAC-MC93-16SCHG-01	No	Yes	No	No
USB Charge/Com Snap-on Cup <b>NOTE:</b> A separate USB cable and power supply is required to support fast charging. USB (Type-C) Cable is required to allow communication from the snap-on to the PC/laptop.	CBL-MC93-USBCHG-01	Yes	No	Yes	No
Charge Only Adapter	ADP-MC93-CRDCUP-01	Yes	NA	No	No

## Charging the Main Battery

To charge the main battery:

1. Connect the charging accessory to the appropriate power source.
2. Insert the device into a cradle or attach a cable.

The device starts to charge automatically. The Charge LED Indicator indicates the charge status. See the table below for charging indications.

**Table 3** LED Charge Indicators

Status	Indications
Off	<ul style="list-style-type: none"> <li>• The battery is not charging.</li> <li>• The device is not inserted correctly in the cradle or connected to a power source.</li> <li>• Cradle is not powered.</li> </ul>
Slow Blinking Amber Every 3 seconds	<ul style="list-style-type: none"> <li>• Battery is charging, but the battery is fully depleted and does not yet have sufficient charge to power the device.</li> <li>• After battery removal, indicates that the device is in hot swap mode with connectivity persistence.</li> </ul> <p><b>NOTE:</b> The SuperCap requires a minimum of 15 minutes to fully charge in order to provide adequate connectivity and memory session persistence.</p>
Solid Amber	<ul style="list-style-type: none"> <li>• Battery is charging.</li> </ul>
Solid Green	<ul style="list-style-type: none"> <li>• Battery charging is complete.</li> </ul>
Fast Blinking Red 2 blinks/second	Charging error. For example: <ul style="list-style-type: none"> <li>• Temperature is too low or too high.</li> <li>• Charging has gone on too long without completion (typically eight hours).</li> </ul>
Solid Red	<ul style="list-style-type: none"> <li>• Battery is charging and battery is at the end of useful life.</li> <li>• Charging complete and battery is at the end of useful life.</li> </ul>

The 7000mAh PowerPrecision+ standard battery charges from 0% to 90% in less than 3.5 hours at room temperature using a Zebra accessory.

The 5000mAh PowerPrecision+ freezer battery charges from 0% to 90% in less than 2.5 hours at room temperature using a Zebra accessory.

The 7000mAh PowerPrecision+ non-incendive battery charges from 0% to 90% in less than 3.5 hours at room temperature using a Zebra accessory.

Charge batteries in temperatures from 0°C to 40°C (32°F to 104°F). The device or cradle always performs battery charging in a safe and intelligent manner. At higher temperatures, for example at approximately +37°C (+98°F), the device or cradle may for small periods of time alternately enable and disable battery charging to keep the battery at acceptable temperatures. The device and cradle indicates when charging is disabled due to abnormal temperatures via its LED.

## Backup Power

The device is equipped with a super-capacitor (supercap) to provide backup power to the device when the main battery is removed. The supercap will retain random access memory (RAM) data in memory for approximately five minutes after the main battery is removed during Hot Swap.



**IMPORTANT:** The supercap is automatically charged from the main battery and requires approximately fifteen minutes to fully charge.

## Hot Swap Mode

The device provides a Hot Swap mode where you can replace the battery without powering off the device. When you remove the battery, the display turns off and the device enters the Hot Swap mode. WLAN and Bluetooth connectivity are retained for the first 30 seconds (indicated by a flashing amber LED). After 30 seconds, the device enters a critical suspend mode with RAM data persistence for approximately 5 minutes. In the critical suspend mode, WLAN and Bluetooth radios are disabled and will only resume if you insert a battery with sufficient charge into the device.



**CAUTION:** To prevent damage to the device, DO NOT perform a hot swap during a device boot up session.



**IMPORTANT:** The supercap requires time to recharge after performing a Hot Swap or after the main battery is fully depleted. It can take up to 15 minutes to fully charge the supercap. Hot Swap mode will not retain data unless the supercap is fully charged.

## Removing and Replacing Keypads

1. Power off the device.
2. Remove the battery.
3. Using a Torx T8 screwdriver with a large grip, remove the two keypad latch screws from inside the battery slot.

**Figure 13** Remove Keypad Latch Screws

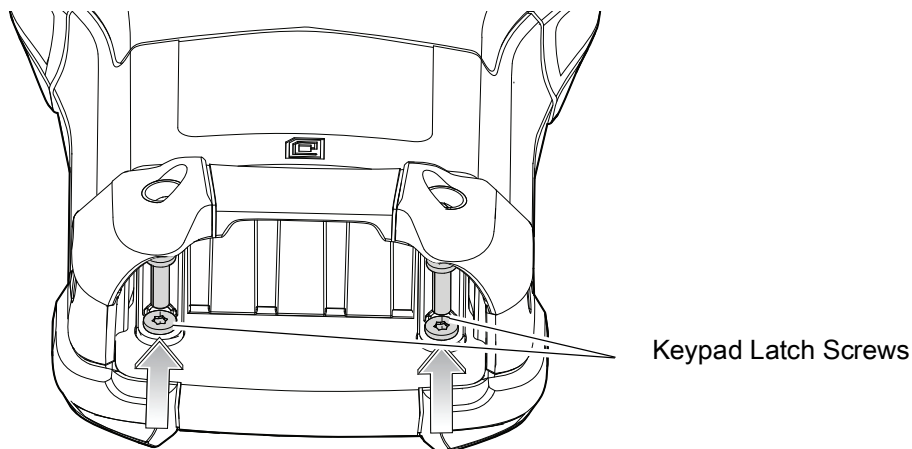

- Slide the keypad latches toward the bottom of the device.

**Figure 14** Release Keypad Latches

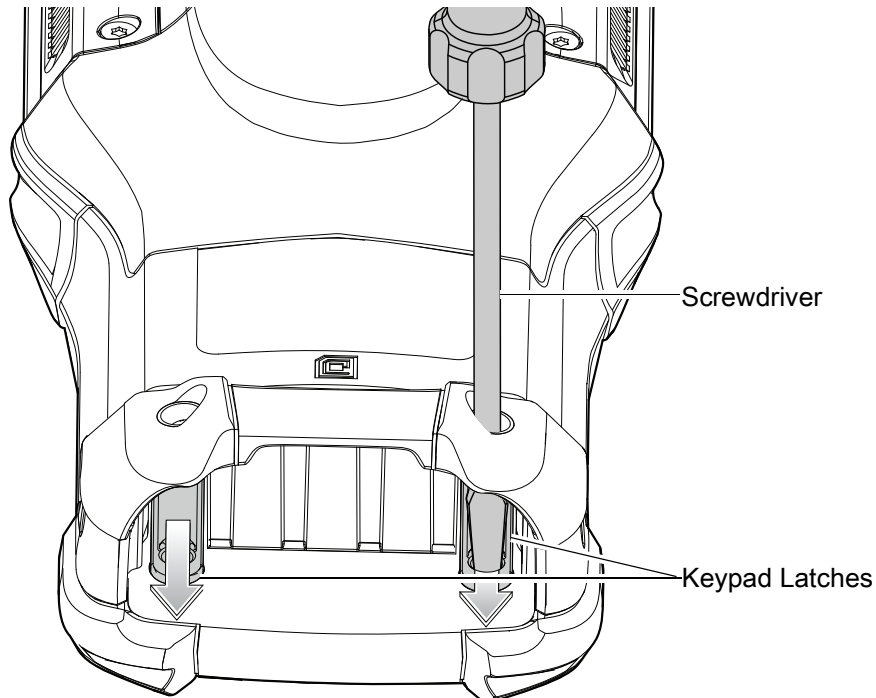

**NOTE:** If the keypad latches are hard to move, use a screwdriver to gently slide them towards the bottom of the device.

- Turn the device over so that the keypad is visible.
- Using a Torx T8 screwdriver with a large grip, remove the two keypad assembly screws from the top of the keypad.

**Figure 15** Remove Keypad

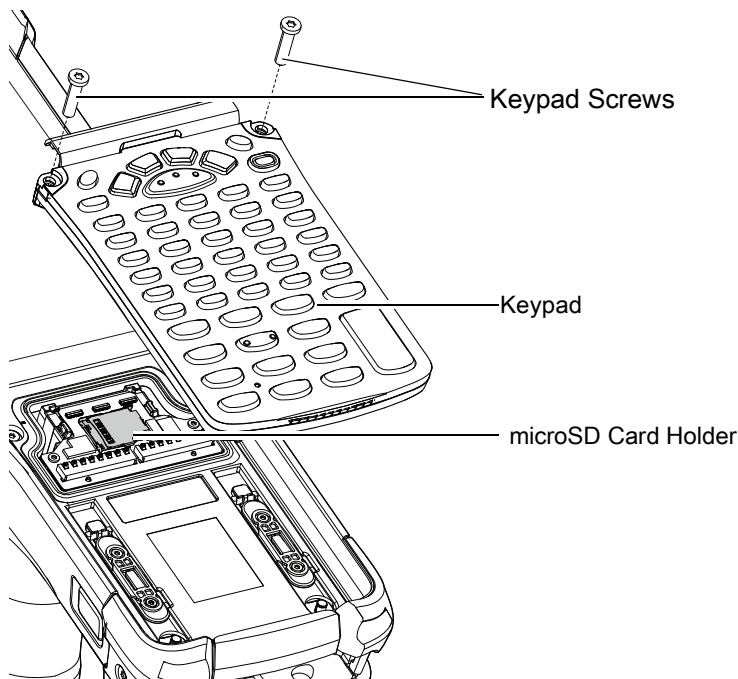

7. Lift the keypad from the device.
8. Align the keypad along the bottom ridge of the device, and then lay it flat.

**Figure 16** Replace Keypad

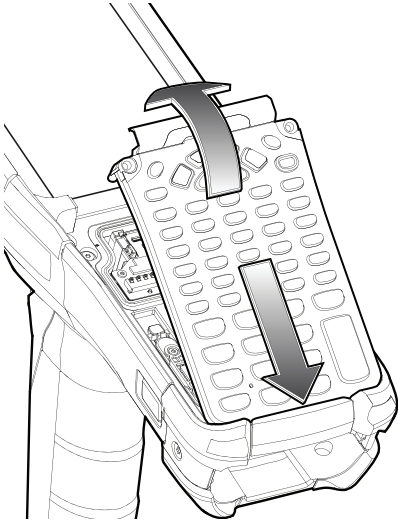

9. Using a Torx T8 screwdriver with a large grip and a long shaft, secure the keypad to the device using the two screws. Torque screws to 5.8 kgf-cm or 5.0 lbf-in.

**Figure 17** Replace Keypad Screws

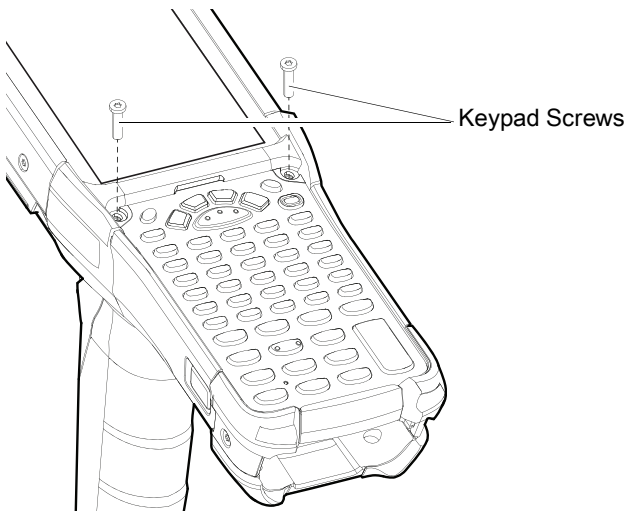

10. Turn the device over so that the keypad latches are visible.

11. Slide both the keypad latches toward the top of the device.

**Figure 18** Slide Keypad Latches

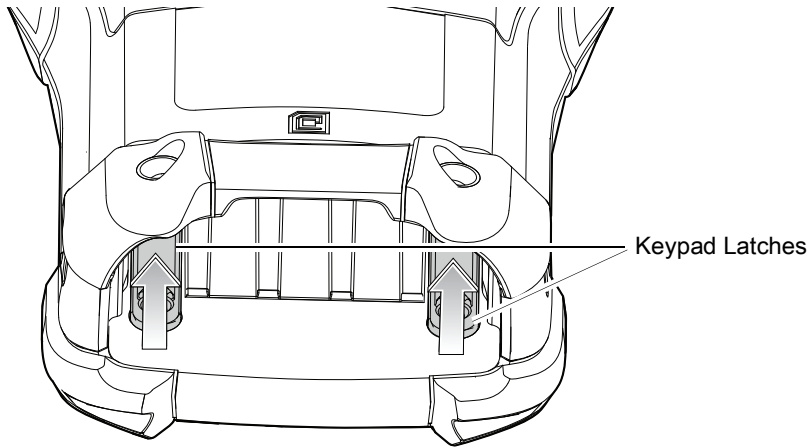

12. Using a Torx T8 screwdriver, replace the two keypad latch screws inside the battery slot and torque to 5.8 kgf-cm or 5.0 lbf-in.

**Figure 19** Replace Keypad Latch Screws

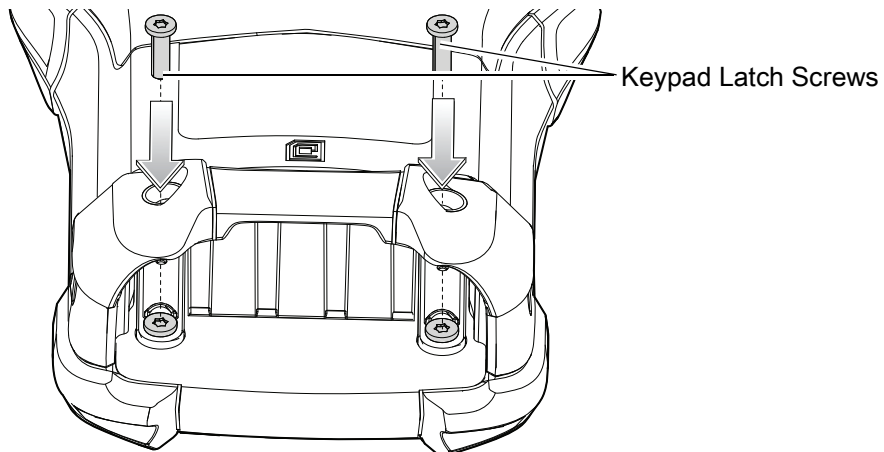

13. Insert the battery.

14. Press and hold the Power key to power on the device.

# Accessories

## Introduction

This chapter provides information for using the accessories for the device.

## MC93XX Accessories

The table below lists the accessories available for the device.

Table 4 MC93XX Accessories

Accessory	Part Number	Description
<b>Cradles</b>		
1-Slot USB Charge Cradle with Spare Battery Charger	CRD-MC93-2SUCHG-01	Charges the MC93XX main battery and a spare battery, and synchronizes the MC93XX with a host computer through a USB connection. Requires power supply (PWR-BGA12V50W0WW), DC line cord (CBL-DC-388A1-01) and a country specific grounded AC line cord.
4-Slot Charge Only ShareCradle	CRD-MC93-4SCHG-01	Charges up to four MC93XXs. Requires power supply (PWR-BGA12V108W0WW), DC line cord (CBL-DC-381A1-01) and a country specific grounded AC line cord.
4-Slot Ethernet ShareCradle	CRD-MC93-4SETH-01	Charges up to four MC93XXs through the main battery and synchronizes the devices with a host computer through an Ethernet connection. Requires power supply (PWR-BGA12V108W0WW), DC line cord (CBL-DC-381A1-01) and a country specific grounded AC line cord.
<b>Chargers</b>		
4-Slot Spare Battery Charger	SAC-MC93-4SCHG-01	Charges up to four MC93XX spare batteries. Requires power supply (PWR-BGA12V50W0WW), DC line cord (CBL-DC-388A1-01) and a country specific grounded AC line cord.



## Accessories

Table 4 MC93XX Accessories (Continued)

Accessory	Part Number	Description
16-Slot Spare Battery Charger	SAC-MC93-16SCHG-01	Charges up to 16 MC93XX spare batteries. Requires power supply (PWR-BGA12V108W0WW), DC line cord (CBL-DC-381A1-01) and a country specific grounded AC line cord.
Power Supply	PWR-BGA12V50W0WW	Provides 12 VDC, 4.16A power to the 1-Slot USB Charge Cradle and the 4-Slot Spare Battery Charger. Requires a DC line cord (CBL-DC-388A1-01) and a country specific grounded AC line cord.
Power Supply	PWR-BGA12V108W0WW	Provides 12 VDC, 9A power to the 4-Slot Charge Cradle with 4-Slot Battery Charger, and 16-Slot Battery Charger. Requires a DC line cord (CBL-DC-381A1-01) and a country specific grounded AC line cord.
Power Supply	PWR-WUA5V12W0US	Provides 5 VDC, 2.5A power to the USB Charge Cable. Includes plug adapter for use in the United States.
Power Supply	PWR-WUA5V12W0GB	Provides 5 VDC, 2.5A power to the USB Charge Cable. Includes plug adapter for use in the European Union.
Power Supply	PWR-WUA5V12W0EU	Provides 5 VDC, 2.5A power to the USB Charge Cable. Includes plug adapter for use in the United Kingdom.
Power Supply	PWR-WUA5V12W0AU	Provides 5 VDC, 2.5A power to the USB Charge Cable. Includes plug adapter for use in Australia.
Power Supply	PWR-WUA5V12W0CN	Provides 5 VDC, 2.5A power to the USB Charge Cable. Includes plug adapter for use in China.
Power Supply	PWR-WUA5V12W0IN	Provides 5 VDC, 2.5A power to the USB Charge Cable. Includes plug adapter for use in India.
US AC Line Cord	23844-00-00R	Provides power to 3-wire power supplies PWR-BGA12V50W0WW and PWR-BGA12V108W0WW.
DC Line Cord	CBL-DC-381A1-01	Provides power from the power supply (PWR-BGA12V108W0WW) to the 4-Slot Charge Only Cradle, 4-Slot Ethernet Cradle, and 16-Slot Battery Charger.
DC Line Cord	CBL-DC-388A1-01	Provides power from the power supply (PWR-BGA12V150W0WW) to the 1-Slot USB Charge Cradle and 4-Slot Battery Charger.

## Accessories

Table 4 MC93XX Accessories (Continued)

Accessory	Part Number	Description
<b>Cables</b>		
USB Charge/Com Snap-On Cup  <b>NOTE:</b> A separate USB cable and power supply is required to support fast charging. USB (Type-C) Cable is required to allow communication from the snap-on to the PC/laptop.	CBL-MC93-USBCHG-01	Provides power and/or communication over USB to the device. Requires wall adapter/power supply PWR-WUA5V12W0xx.
1-Slot Cradle USB Cable	CBL-TC2X-USBC-01	Provides USB communication through the 1-Slot USB cradle to the host computer.
<b>Miscellaneous</b>		
Cradle Adapter	ADP-MC93-CRDCUP-01	MC93XX Charge Only Adapter for backwards compatibility with MC9XX cradles. Works with MC9XX 1-Slot USB Cradle, and 4-Slot Charge Only Cradle.
7000mAh PowerPrecision+ standard battery	BTRY-MC93-STN-01	Replacement standard battery.
	BTRY-MC93-STN-10	Replacement standard battery (10-pack).
	BTRY-MC93-STN-IN	Replacement standard battery (India).
5000mAh PowerPrecision+ freezer battery	BTRY-MC93-FRZ-01	Replacement freezer battery.
	BTRY-MC93-FRZ-10	Replacement freezer battery (10-pack).
7000mAh PowerPrecision+ non-incendive battery	BTRY-MC93-NI-01	Replacement non-incendive battery.
	BTRY-MC93-NI-10	Replacement non-incendive battery (10-pack).
MC93XX Hand Strap	SG-MC93-HDSTPG-01	Replacement hand strap for the MC93XX Hand strap loop holds an optional stylus (SG-TC7X-STYLUS-03).
MC93 Soft Holster for Gun	SG-MC9X-SHLSTG-01	Provides a soft, clip on holster and a shoulder strap for the MC93XX.
MC93 Rubber Boot for Gun	SG-MC93-RBTG-01	Provides additional protection for wear and tear of the MC93XX.
Screen Protector	MISC-MC93-SCRN-01	Provides additional protection for display (5-pack).
Stylus and Tether	SG-TC7X-STYLUS-03	Conductive carbon-filled stylus for capacitive touch panel; includes coiled tether (3-pack).
Un-powered Forklift Mount	MNT-MC93-FLCH-01	Un-powered forklift mount. Allows installing the device on a roll bar or square surface of a forklift. Includes:  Forklift holder (MNT-MC93-FLCH-01), RAM double socket arm for 1" ball (MNT-RAM-B201U), and RAM forklift clamp 2.5" max width square rail base with 1" ball (MNT-RAM-B247U25).

## Accessories

Table 4 MC93XX Accessories (Continued)

Accessory	Part Number	Description
34-key Numeric Keypad	KYPD-MC9334FNR-01	34-key Numeric Keypad
43-key Shifted Alpha Keypad	KYPD-MC9343FN-01	43-key Shifted Alpha Keypad
53-key 3270 Emulator Keypad	KYPD-MC93533270-01	53-key 3270 Emulator Keypad
53-key Keypad (Alpha-Numeric)	KYPD-MC93535250-01	53-key Keypad (Alpha-Numeric)
53-key 5250 Emulator Keypad	KYPD-MC9353ANR-01	53-key 5250 Emulator Keypad
53-key VT Emulator Keypad	KYPD-MC9353VT-01	53-key VT Emulator Keypad
58-Keys OmniiXT15f Keypad	KYPD-MC9358ANR-01	58-Keys OmniiXT15f Keypad
29-Keys Shifted Alpha Keypad	KYPD-MC9329NMR-01	29-Keys Shifted Alpha Keypad
34-key Numeric Keypad (10 Pack)	KYPD-MC9334FNR-10	34-key Numeric Keypad (10 Pack)  <b>NOTE:</b> The 10 pack order includes a keypad installation tool.
43-key Shifted Alpha Keypad (10 Pack)	KYPD-MC9343FN-10	43-key Shifted Alpha Keypad (10 Pack)  <b>NOTE:</b> The 10 pack order includes a keypad installation tool.
53-key 5250 Emulator Keypad (10 Pack)	KYPD-MC93535250-10	53-key 5250 Emulator Keypad (10 Pack)  <b>NOTE:</b> The 10 pack order includes a keypad installation tool.
53-key VT Emulator Keypad (10 Pack)	KYPD-MC9353VT-10	53-key VT Emulator Keypad (10 Pack)  <b>NOTE:</b> The 10 pack order includes a keypad installation tool.
53-key Keypad (Alpha-Numeric) (10 Pack)	KYPD-MC9353ANR-10	53-key Keypad (Alpha-Numeric) (10 Pack)  <b>NOTE:</b> The 10 pack order includes a keypad installation tool.
58-Keys OmniiXT15f Keypad	KYPD-MC9358ANR-10	58-Keys OmniiXT15f Keypad (10 Pack)  <b>NOTE:</b> The 10 pack order includes a keypad installation tool.
29-Keys Shifted Alpha Keypad	KYPD-MC9329NMR-10	29-Keys Shifted Alpha Keypad (10 Pack)  <b>NOTE:</b> The 10 pack order includes a keypad installation tool.

## 1-Slot USB Charge Cradle with Spare Battery Charger

The 1-Slot USB Charge Cradle with spare battery:

- Provides 9 VDC power to operate the mobile computer and charge the battery.
- Provides 4.2 VDC power to charge the spare battery.
- Provides a USB port for data communication between the mobile computer and a host computer or other USB devices, for example, a printer.
- Synchronizes information between the mobile computer and a host computer. With customized or third party software, it can also synchronize the mobile computer with corporate databases.
- Compatible with the following batteries:
  - 7000mAh PowerPrecision+ standard battery
  - 5000mAh PowerPrecision+ freezer battery
  - 7000mAh PowerPrecision+ non-incendive battery.

### Setup

Figure 20 1-Slot USB Charge Cradle with Spare Battery Charger Setup

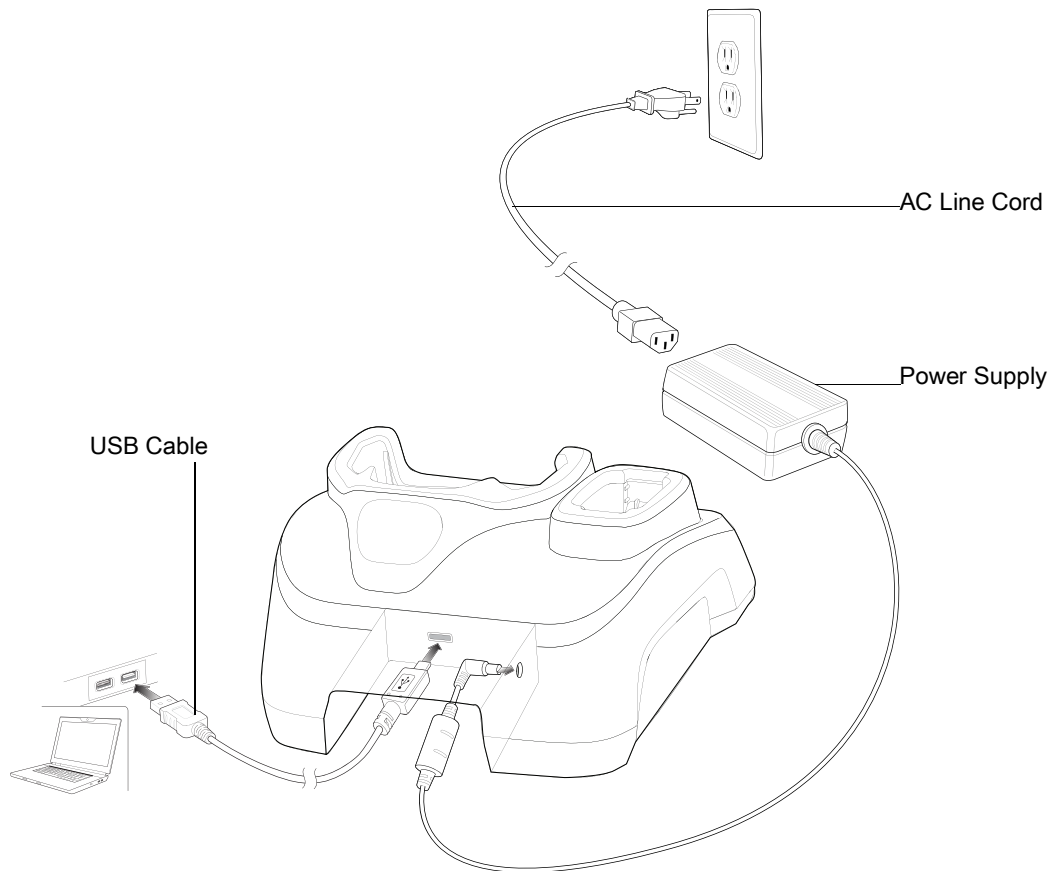

### Charging the Device

1. Connect the cradle to a power source.

Figure 21 1-Slot USB Charge Cradle with Spare Battery Charger

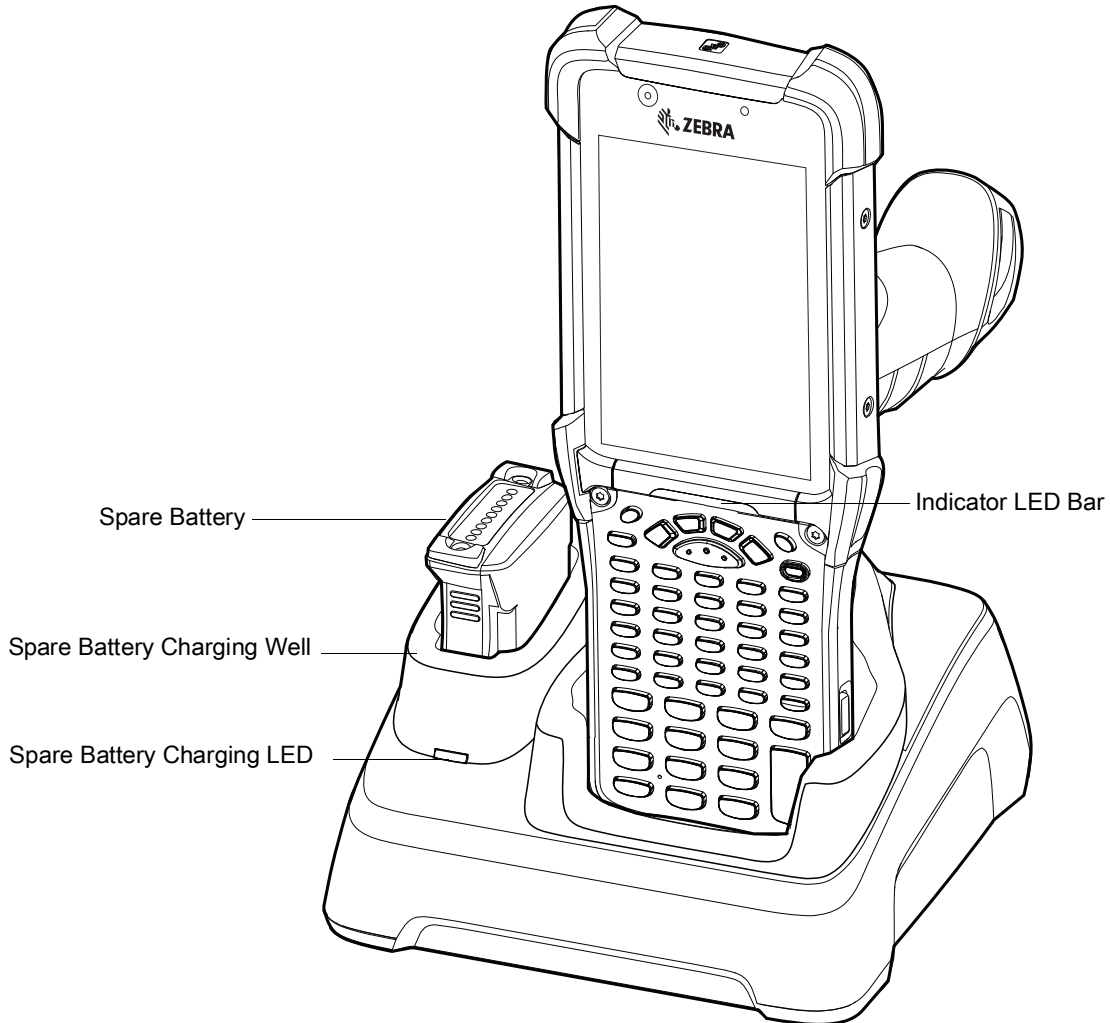

2. Slide the device into the slot in the cradle. The device Charge LED Indicator, indicates the battery charging status.
3. Gently press down on the device to ensure proper contact.
4. When charging is complete, remove the devices from the cradle slot.

The 1-Slot USB charge cradle charges the MC93XX's main battery and a spare battery simultaneously.

The MC93XX's Charge LED indicates the status of the battery charging in the device. See LED Charge Indicators for charging status indications.

**Table 5** LED Charge Indicators

Status	Indications
Off	<ul style="list-style-type: none"> <li>• The battery is not charging.</li> <li>• The device is not inserted correctly in the cradle or connected to a power source.</li> <li>• Cradle is not powered.</li> </ul>
Slow Blinking Amber Every 3 seconds	<ul style="list-style-type: none"> <li>• Battery is charging, but the battery is fully depleted and does not yet have sufficient charge to power the device.</li> </ul>
Solid Amber	<ul style="list-style-type: none"> <li>• Battery is charging.</li> </ul>
Solid Green	<ul style="list-style-type: none"> <li>• Battery charging is complete.</li> </ul>
Fast Blinking Red 2 blinks/second	Charging error. For example: <ul style="list-style-type: none"> <li>• Temperature is too low or too high.</li> <li>• Charging has gone on too long without completion (typically eight hours).</li> </ul>
Solid Red	<ul style="list-style-type: none"> <li>• Battery is charging and battery is at the end of useful life.</li> <li>• Charging complete and battery is at the end of useful life.</li> </ul>

The 7000mAh PowerPrecision+ standard battery charges from 0% to 90% in less than 3.5 hours at room temperature using a Zebra accessory.

The 5000mAh PowerPrecision+ freezer battery charges from 0% to 90% in less than 2.5 hours at room temperature using a Zebra accessory.

The 7000mAh PowerPrecision+ non-incendive battery charges from 0% to 90% in less than 3.5 hours at room temperature using a Zebra accessory.

## Charging Temperature

Charge batteries in temperatures from 0°C to 40°C (32°F to 104°F). The device or cradle always performs battery charging in a safe and intelligent manner. At higher temperatures, for example at approximately +37°C (+98°F), the device or cradle may for small periods of time alternately enable and disable battery charging to keep the battery at acceptable temperatures. The device and cradle indicates when charging is disabled due to abnormal temperatures via its LED.

## 4-Slot Charge Only ShareCradle



**CAUTION:** Ensure that you follow the guidelines for battery safety described in Battery Safety Guidelines.

The 4-Slot Charge Only ShareCradle:

- Provides 9 VDC power to operating the mobile computer and charge the battery.
- Simultaneously charges up to four mobile computers.

### Setup

**Figure 22** 4-Slot Charge Only ShareCradle Setup

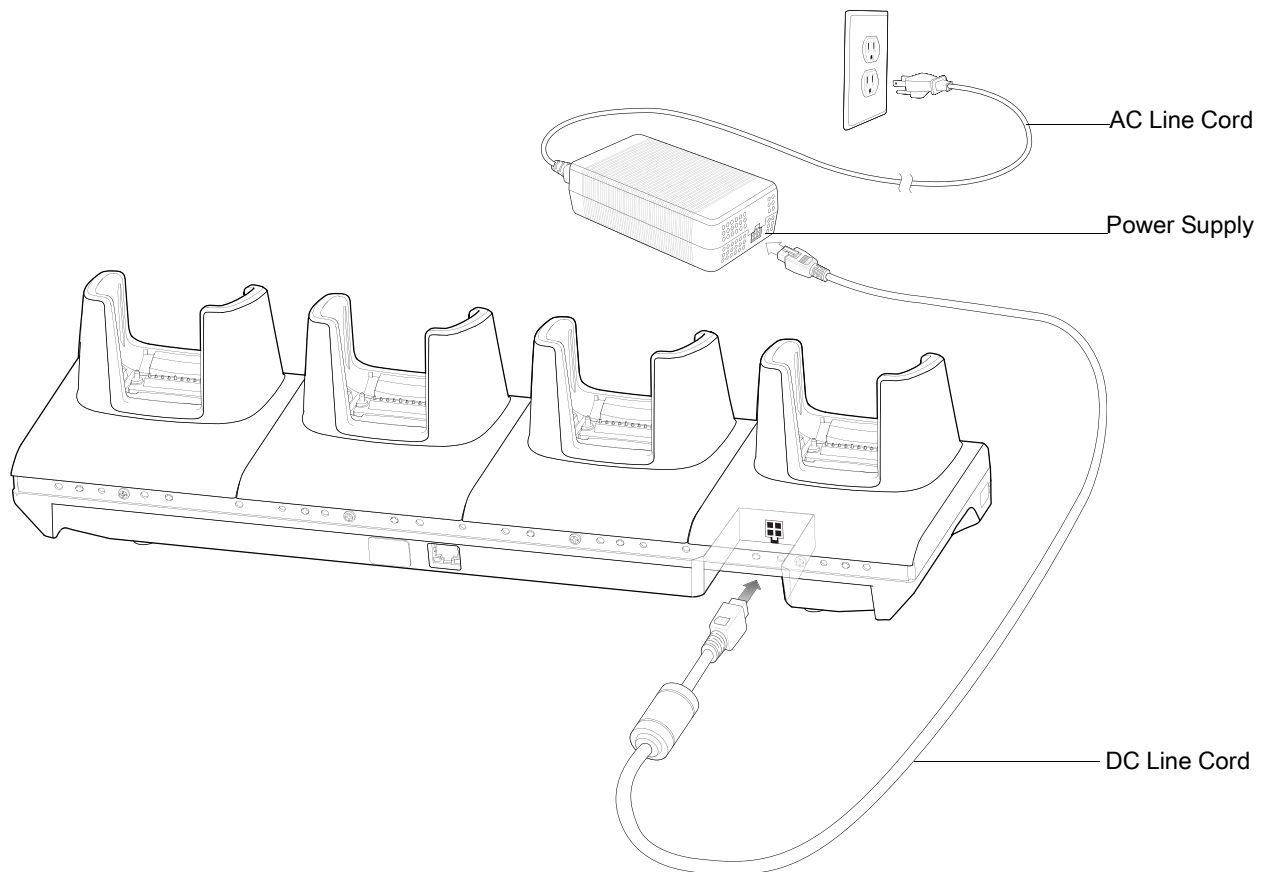

### Charging the Devices

1. Connect the cradle to a power source.
2. Slide the devices into the slot in the cradle. The devices Charge LED Indicator, indicates the battery charging status.

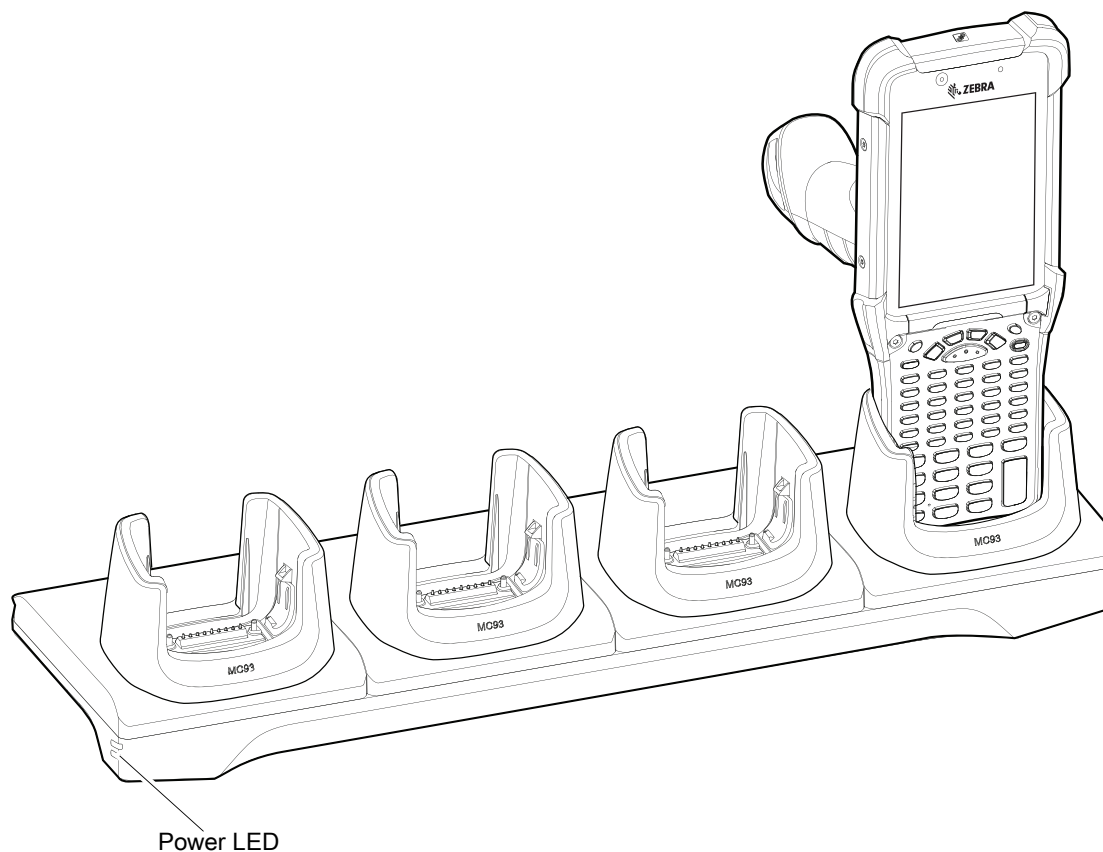
**Figure 23** 4-Slot Charge Only ShareCradle

3. Gently press down on the device to ensure proper contact.
4. When charging is complete, remove the devices from the cradle slot.

### Charging Temperature

Charge batteries in temperatures from 0°C to 40°C (32°F to 104°F). The device or cradle always performs battery charging in a safe and intelligent manner. At higher temperatures, for example at approximately +37°C (+98°F), the device or cradle may for small periods of time alternately enable and disable battery charging to keep the battery at acceptable temperatures. The device and cradle indicates when charging is disabled due to abnormal temperatures via its LED.



## 4-Slot Ethernet ShareCradle



**CAUTION:** Ensure that you follow the guidelines for battery safety described in Battery Safety Guidelines.

The 4-Slot Ethernet ShareCradle:

- Provides 9 VDC power to operating the mobile computer and charge the battery.
- Enables data communication between the MC93XX (up to four devices) and a host computer, over an Ethernet network (using a standard Ethernet cable).
- Synchronizes information between the MC93XX and a host computer. (With customized or third-party software, it can also be used to synchronize the MC93XX with corporate databases.)
- Simultaneously charges up to four devices.

### Setup

**Figure 24** 4-Slot Ethernet ShareCradle Setup

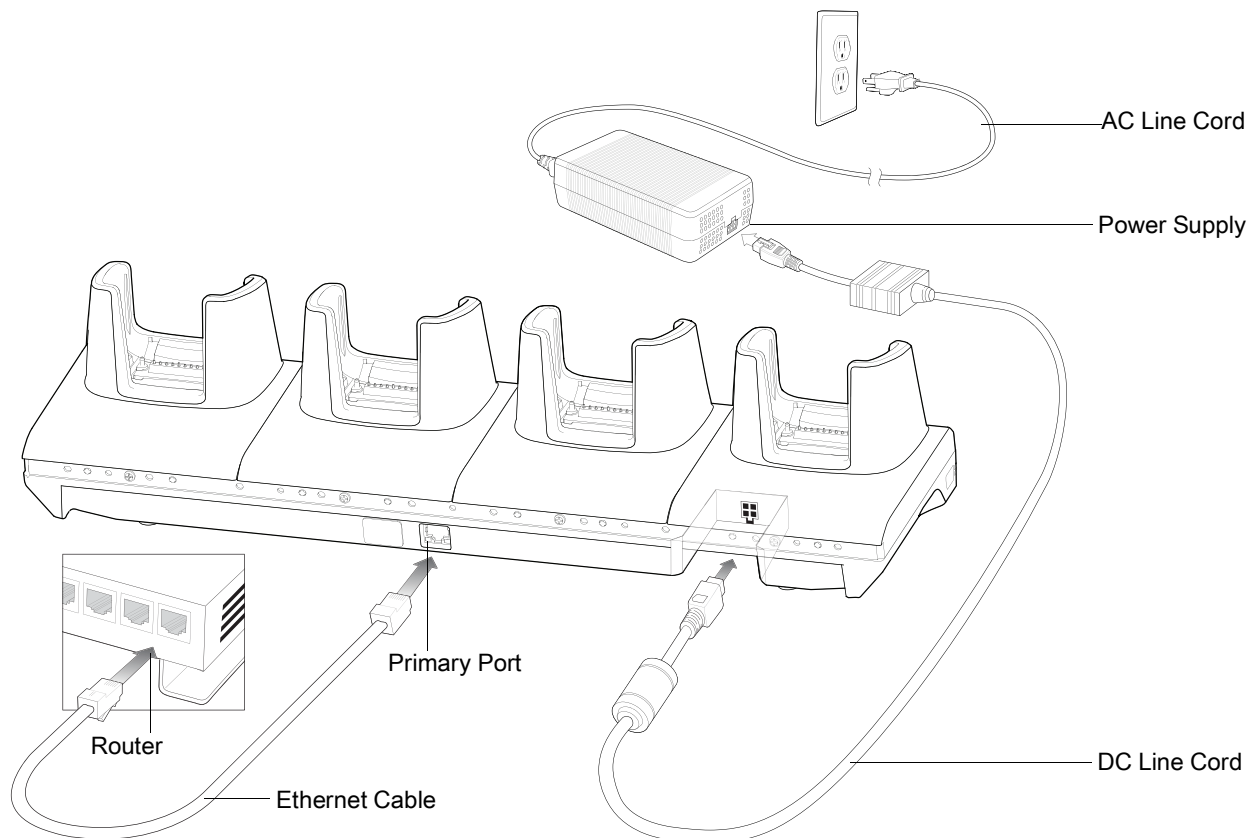

### Charging the Devices

1. Connect the cradle to a power source.
2. Slide the devices into the slot in the cradle. The devices Charge LED Indicator, indicates the battery charging status.

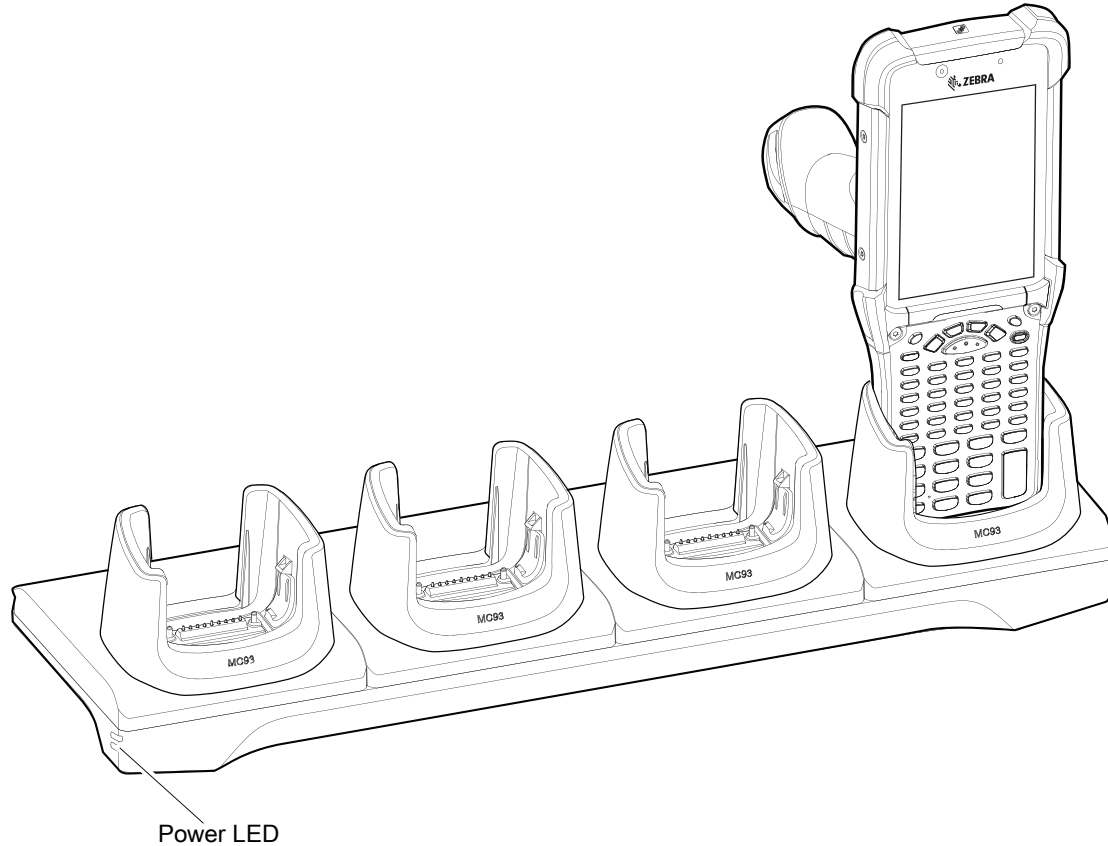
**Figure 25** 4-Slot Ethernet ShareCradle

3. Gently press down on the device to ensure proper contact.
4. When charging is complete, remove the devices from the cradle slot.

## Daisy-chaining Ethernet ShareCradles

Daisy-chain up to ten 4-Slot Ethernet ShareCradles to connect several cradles to an Ethernet network. Use either a straight or crossover cable. Daisy-chaining should not be attempted when the main Ethernet connection to the first cradle is 10 Mbps as throughput issues will almost certainly result.

To daisy-chain 4-Slot Ethernet ShareCradles:

1. Connect power to each 4-Slot Ethernet ShareCradle.
2. Connect an Ethernet cable to one of the ports on the switch and the other end to the Primary Port of the first cradle.
3. Connect an Ethernet cable to the Secondary port of the first cradle.
4. Connect the other end of the Ethernet cable to the Primary port of the next 4-Slot Ethernet ShareCradle.

Figure 26 Daisy-chaining 4-Slot Ethernet ShareCradles

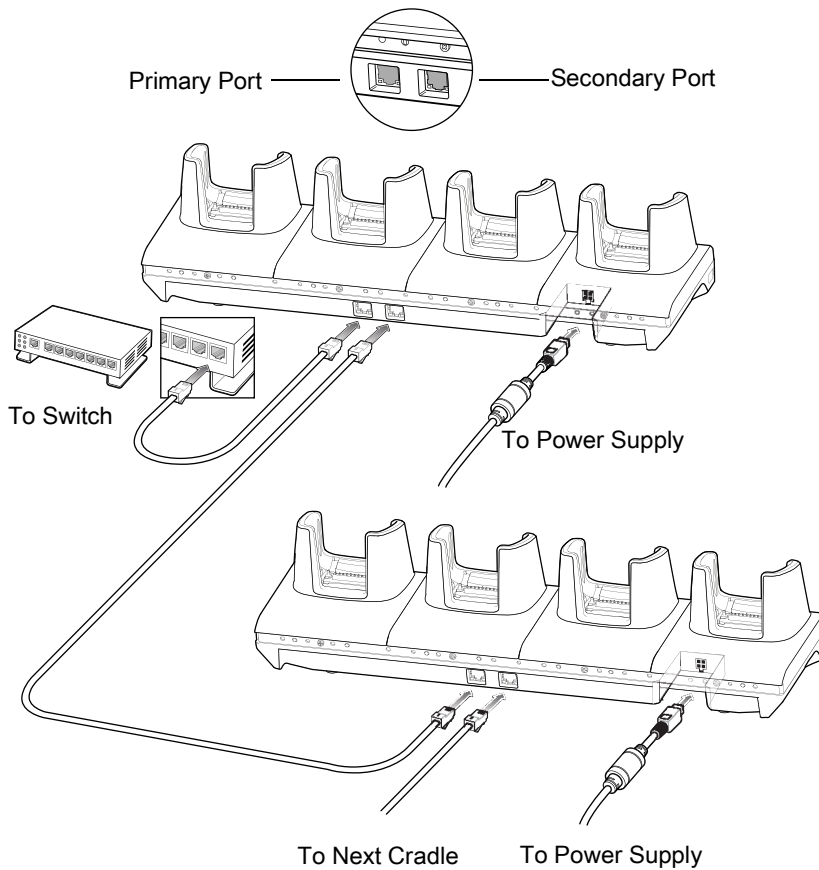

5. Connect additional cradles as described in step 3 and 4.

## Ethernet Settings

The following settings can be configured when using Ethernet communication:

- Proxy Settings
- Static IP.

## Configuring Ethernet Proxy Settings

The MC93XX includes Ethernet cradle drivers. After inserting the device, configure the Ethernet connection:

1. Swipe down from the status bar to open the quick access panel and then touch .
2. Touch **Network & Internet > Ethernet**.
3. Slide the switch to the **ON** position.
4. Place the device into the Ethernet cradle slot.
5. Touch and hold **eth0** until the menu appears.
6. Touch **Modify Proxy**.
7. Touch the **Proxy** drop-down list and select **Manual**.

Figure 27 Ethernet Proxy Settings

<...> **eth0**  
 Proxy  
**Manual** ▼  
 Proxy hostname  
 proxy.example.com  
 Proxy port  
 8080  
 Bypass proxy for  
 example.com,mycomp.test.c  
 CANCEL    MODIFY

8. In the **Proxy hostname** field, enter the proxy server address.
9. In the **Proxy port** field, enter the proxy server port number.



**NOTE:** When entering proxy addresses in the Bypass proxy for field, do not use spaces or carriage returns between addresses.

10. In the **Bypass proxy for** text box, enter addresses for web sites that do not require to go through the proxy server. Use the separator comma “,” between addresses.
11. Touch **MODIFY**.
12. Touch .

## Configuring Ethernet Static IP Address

The MC93XX includes Ethernet cradle drivers. After inserting the device, configure the Ethernet connection:





1. Swipe down from the status bar to open the quick access panel and then touch .
2. Touch **Network & Internet > Ethernet**.
3. Slide the switch to the **ON** position.
4. Place the device into the Ethernet cradle slot.
5. Touch **eth0**.
6. Touch **Disconnect**.
7. Touch **eth0**.
8. Touch the IP settings drop-down list and select **Static**.

Figure 28 Static IP Settings

<math>\langle \dots \rangle</math> **eth0**  
 Proxy  
 None ▼  
 IP settings  
 Static ▼  
 IP address  
 192.168.1.128  
 Gateway  
 192.168.1.1  
 Netmask  
 255.255.255.0  
 DNS 1  
 8.8.8.8  
 DNS 2  
 4.4.4.4  
 CANCEL CONNECT

9. In the **IP** address field, enter the proxy server address.
10. If required, in the **Gateway** field, enter a gateway address for the device.
11. If required, in the **Netmask** field, enter the network mask address
12. If required, in the **DNS** address fields, enter a Domain Name System (DNS) addresses.
13. Touch **CONNECT**.
14. Touch .

## Establishing Ethernet Connection

1. Swipe down from the status bar to open the quick access panel and then touch .
2. Touch **Network & Internet > Ethernet**.
3. Slide the Ethernet switch to the **ON** position.
4. Insert the device into a slot.
5. The  icon appears in the Status bar.
6. Touch **eth0** to view Ethernet connection details.

## LED Indicators

There are two green LEDs on the side of the cradle. These green LEDs light and blink to indicate the data transfer rate.

Table 6 LED Data Rate Indicators

Data Rate	1000 LED	100/10 LED
1 Gbps	On/Blink	Off
100 Mbps	Off	On/Blink
10 Mbps	Off	On/Blink

## Charging Temperature

Charge batteries in temperatures from 0°C to 40°C (32°F to 104°F). The device or cradle always performs battery charging in a safe and intelligent manner. At higher temperatures, for example at approximately +37°C (+98°F), the device or cradle may for small periods of time alternately enable and disable battery charging to keep the battery at acceptable temperatures. The device and cradle indicates when charging is disabled due to abnormal temperatures via its LED.

## 16-Slot Spare Battery Charger



**CAUTION:** Ensure that you follow the guidelines for battery safety described in Battery Safety Guidelines.

The 16-Slot Spare Battery Charger:

- Charges up to 16 spare batteries.
- Provides 4.2 VDC power to charge the spare battery.

### Setup

**Figure 29** 16-Slot Spare Battery Charger Setup

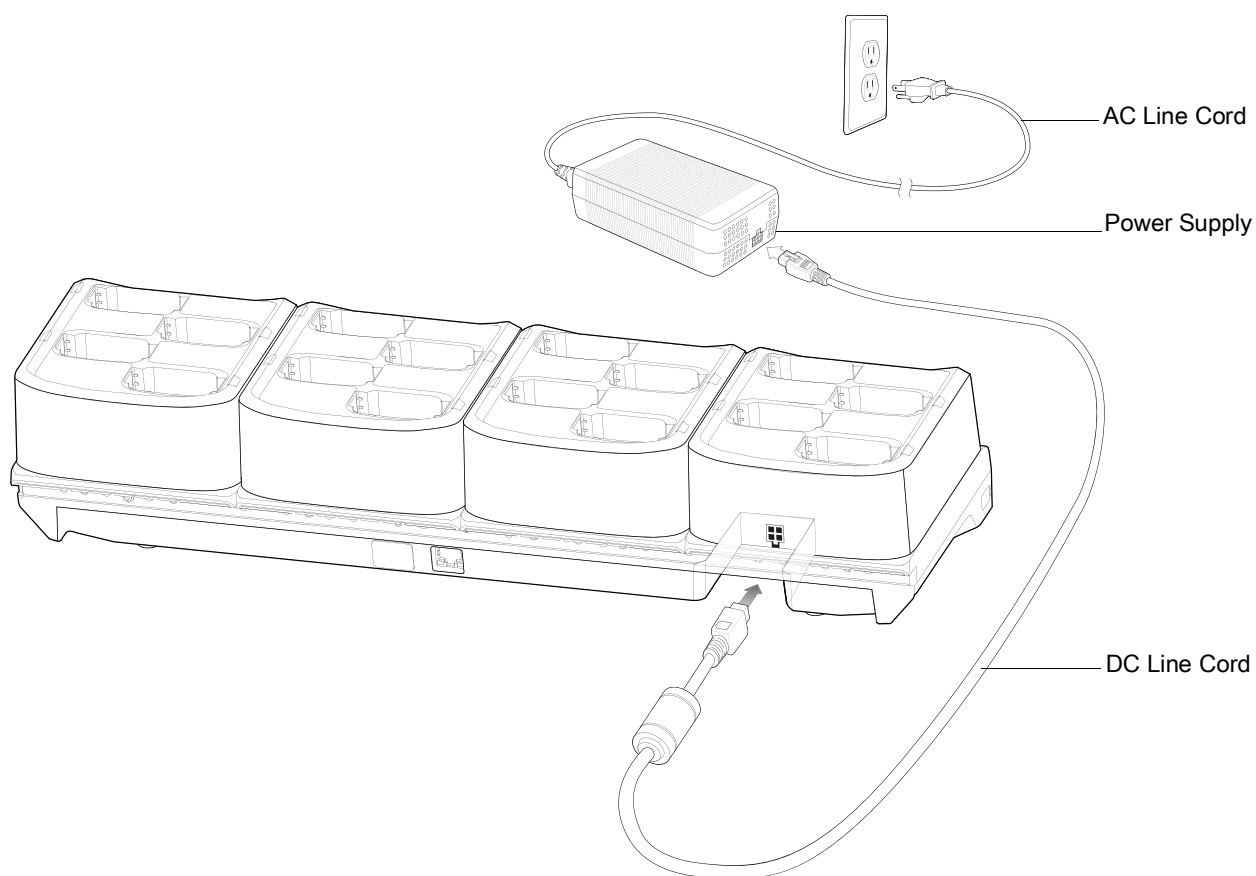

### Charging the Spare Batteries

1. Connect the charger to a power source.

**Figure 30** 16-Slot Spare Battery Charger

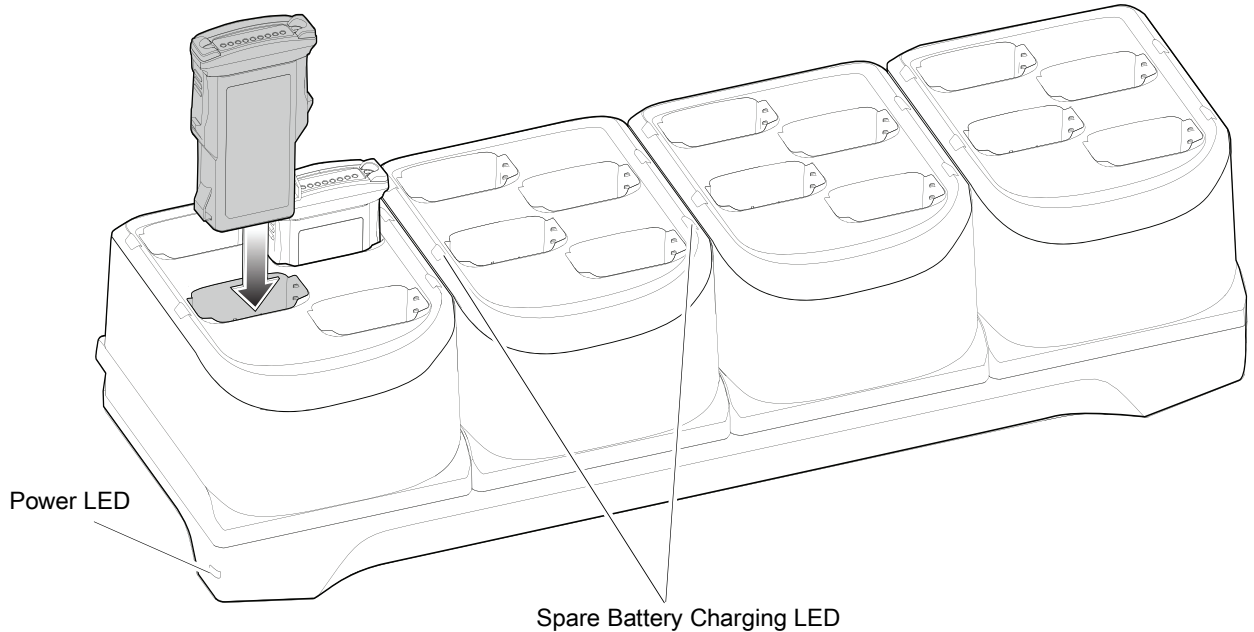

2. Insert the battery into a spare battery charging slot and gently press down on the battery to ensure proper contact.

The Spare Battery Charging LEDs on the front of the cradle indicates the spare battery charging status. The following table specifies charging indicators.

*Table 7 Spare Battery Charging LED Indicators*

State	Indication
Off	<ul style="list-style-type: none"> <li>• The battery is not charging.</li> <li>• The battery is not inserted correctly in the cradle.</li> <li>• Cradle is not powered.</li> </ul>
Solid Amber	<ul style="list-style-type: none"> <li>• Battery is charging.</li> </ul>
Solid Green	<ul style="list-style-type: none"> <li>• Battery charging is complete.</li> </ul>
Fast Blinking Red 2 blinks/second	Charging error. For example: <ul style="list-style-type: none"> <li>• Temperature is too low or too high.</li> <li>• Charging has gone on too long without completion (typically eight hours).</li> </ul>
Solid Red	<ul style="list-style-type: none"> <li>• Battery is charging and battery is at the end of useful life.</li> <li>• Charging complete and battery is at the end of useful life.</li> </ul>

## Charging Temperature

Charge batteries in temperatures from 0°C to 40°C (32°F to 104°F). The device or cradle always performs battery charging in a safe and intelligent manner. At higher temperatures, for example at approximately +37°C (+98°F), the device or cradle may for small periods of time alternately enable and disable battery charging to keep the battery at acceptable temperatures. The device and cradle indicates when charging is disabled due to abnormal temperatures via its LED.



## USB Charge/Com Snap-on Cup

The USB Charge/Com Snap-on Cup:

- Provides 5 VDC power to operate the device and to charge the battery.
- Provides power and/or communication with the host computer over USB to the device.

**Figure 31** USB Charge/Com Snap-on Cup

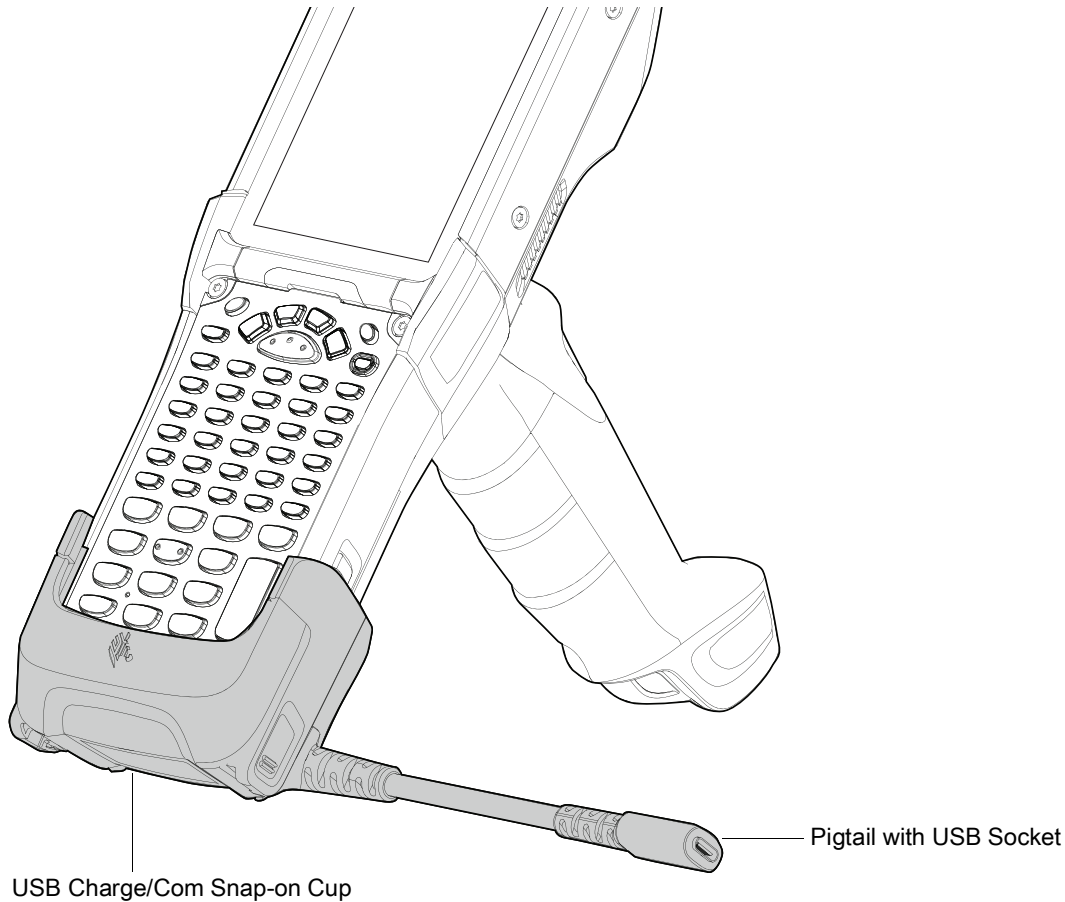

## Connecting to the Device



**NOTE:** To function properly, remove the lower part of the rubber boot or the entire rubber boot before placing the device in a charging cradle.

Insert the device straight onto the USB Charge/Com Snap-on Cup until the device touches the bottom of the cable cup.

Figure 32 Connecting the USB Charge/Com Snap-on Cup

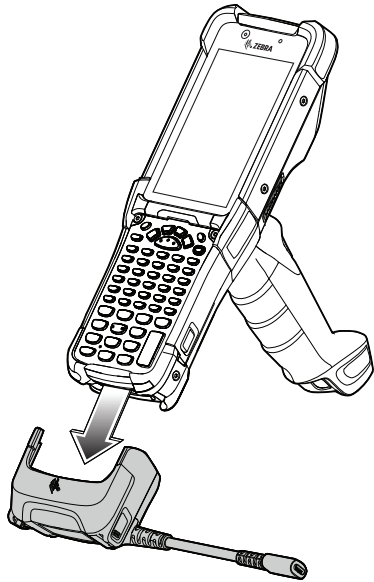

## Connecting the USB Charge/Com Snap-on Cup Cable to Host Computer

To connect the USB Charge/Com Snap-on Cup cable to a host computer:

1. Connect the USB Charge/Com Snap-on Cup to the device.
2. Connect the USB connector to a host computer.

Figure 33 Connecting USB Charge/Com Snap-on Cup to Host Computer

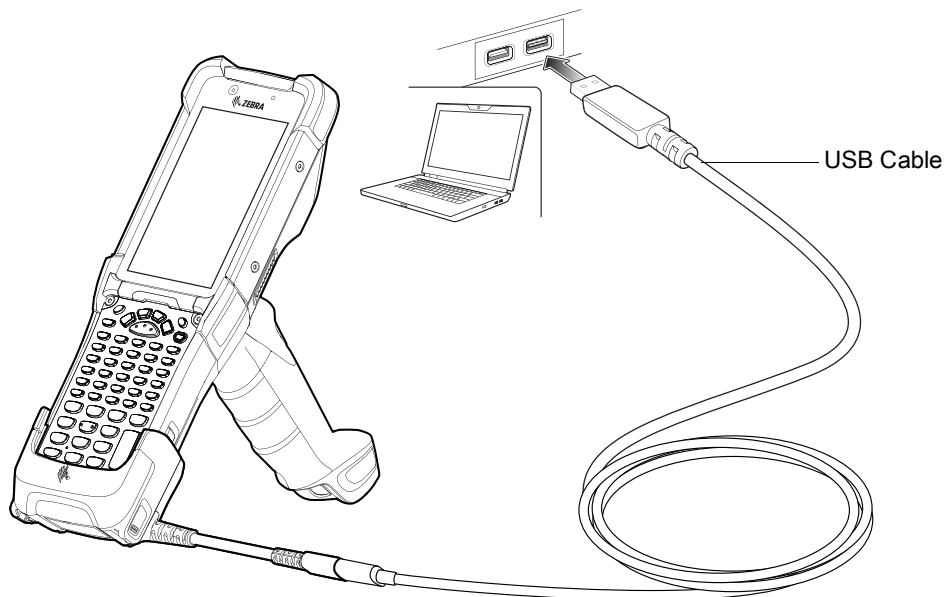

## Charging the Device

To charge the device using the USB Charge/Com Snap-on Cup:

1. Connect the USB Charge/Com Snap-on Cup to the device.
2. Connect the USB connector of the power supply.
3. Plug the power supply into a power outlet.

Figure 34 Charging the Device using the USB Charge Cable

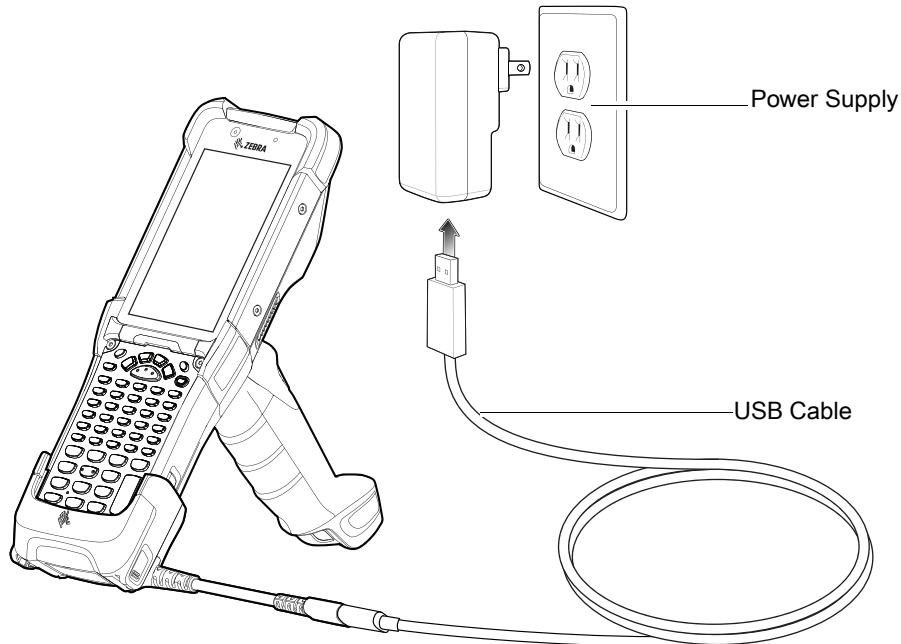

Refer to the Charging the Main Battery section for information on charging indicator statuses.

## Disconnecting the USB Charge/Com Snap-on Cup

To disconnect the USB Charge/Com Snap-on Cup from the device:

1. Depress the two latches on either side of the cup.
2. Pull the cup off the bottom of the device.

Figure 35 Disconnecting the USB Charge/Com Snap-on Cup

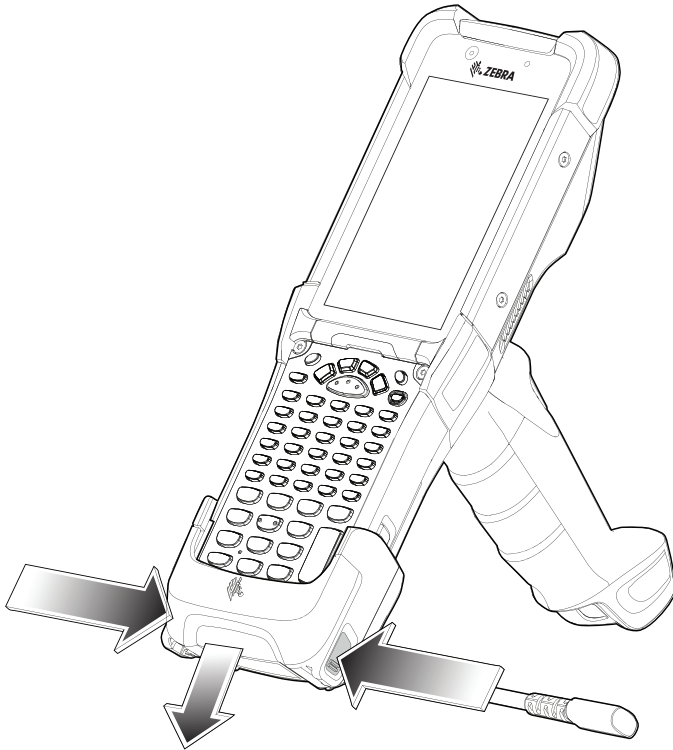

### MC93XX Charge Only Adapter

Use the Charge Only Adapter for backwards compatibility with the MC9XXX cradles and the MC93XX mobile computer.

- Charge Only Adapter supports terminal charging only for the MC9XXX 1-Slot Cradle and 4-Slot Cradle.
- Charge Only Adapter provides charge only and no communication when used with the MC9XXX cradles.

Figure 36 MC9X 1-Slot Cradle Charge Only Adapter

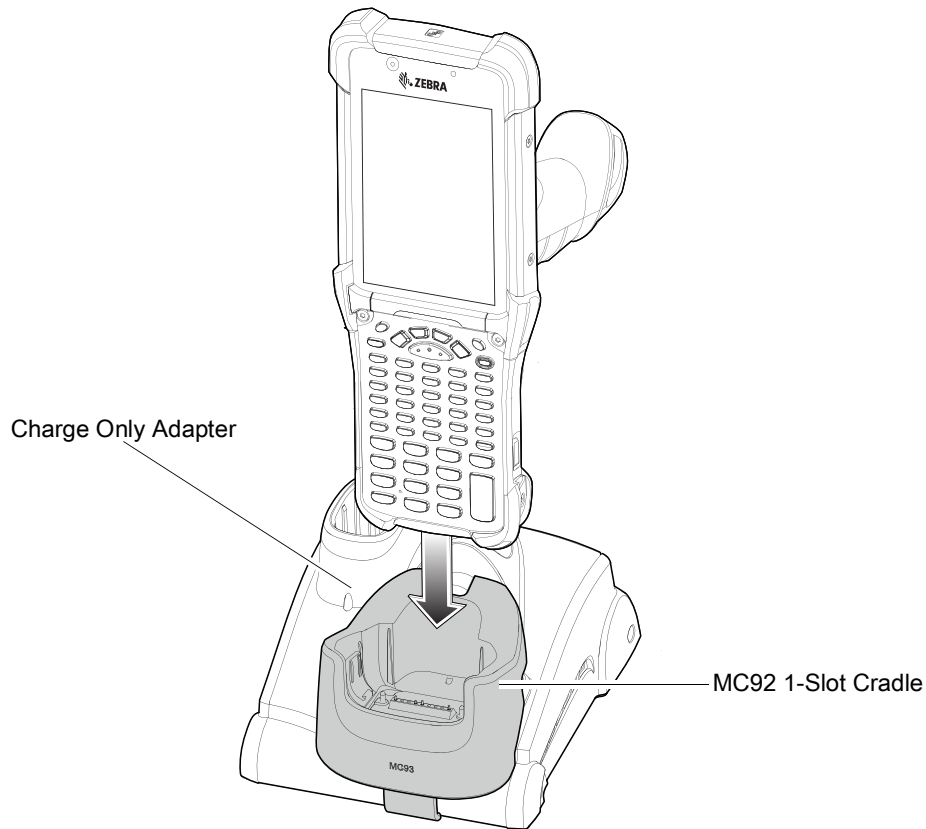
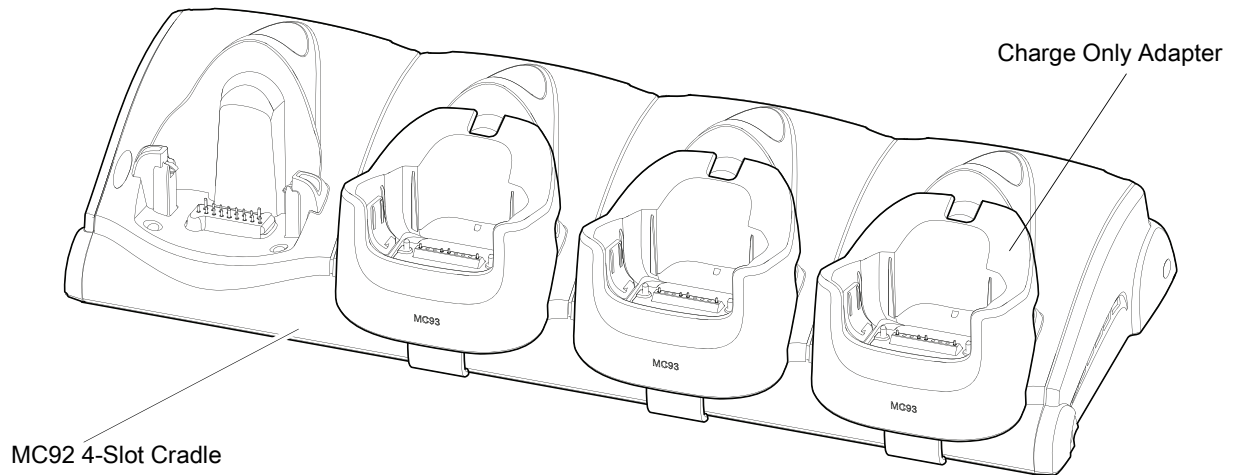

Figure 37 MC9X 4-Slot Cradle Charge Only Adapter



## Charge Only Adapter Installation

To install the Charge Only Adapter:

1. Clean the MC9XXX cradle and contacts surface as specified with an alcohol wipe, using a back and forth motion with your finger.  
For more information about cleaning, refer to the MC93XX Mobile Computer User Guide.

Figure 38 Clean MC9XXX Cradle Contacts and Surfaces

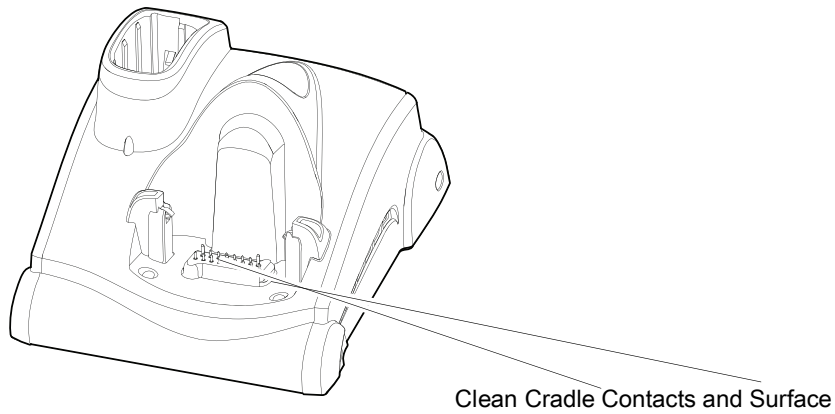

2. Peel and remove the adhesive from the back of the adapter.

Figure 39 Peel and Remove Adhesive

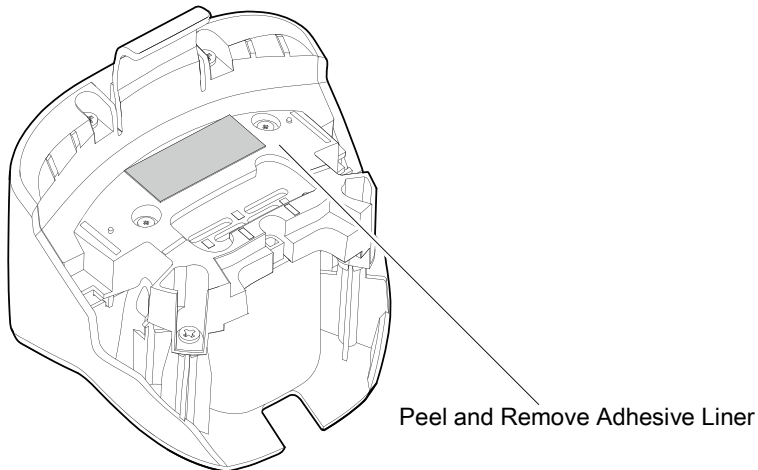

3. Insert the adapter into the MC9XXX cradle and adhere to the bottom of the cradle.

Figure 40 Insert Adapter into Cradle

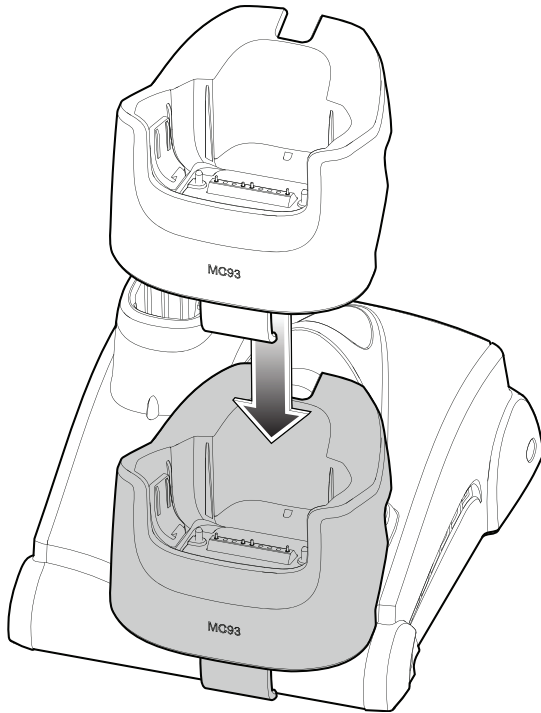

4. Insert the device into the cradle.

Figure 41 Insert Device into Cradle

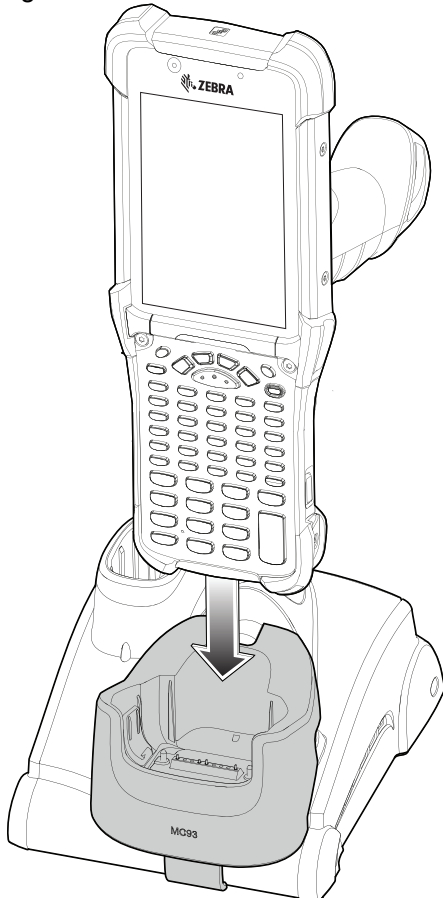

## Rubber Boot

To attach the rubber boot:

1. If using the rubber boot with a device with the SE965 laser scanner, retain the shim (default assembly). If using the rubber boot with a device with either the SE4750SR or the SE4850ER imager, you must snap-off the shim by pushing it through.

Figure 42 Remove the Shim

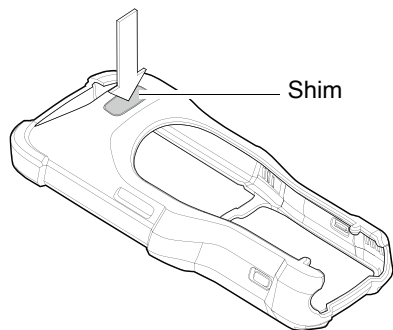

2. Slide the top of the device into the top of the rubber boot.

Figure 43 Slide the Rubber Boot

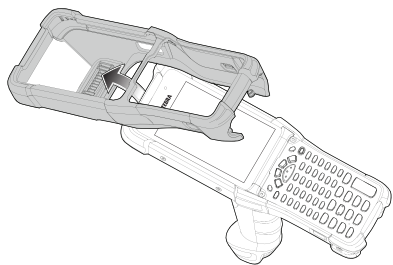

3. Grasp the bottom of the rubber boot and place over the bottom of the device.

Figure 44 Attach the Top of the Rubber Boot

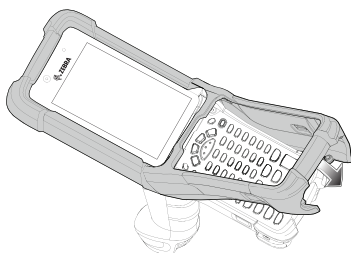

4. Turn the device over and ensure that the two alignment tabs completely fit into the two alignment slots on the device.



Figure 45 Align tabs

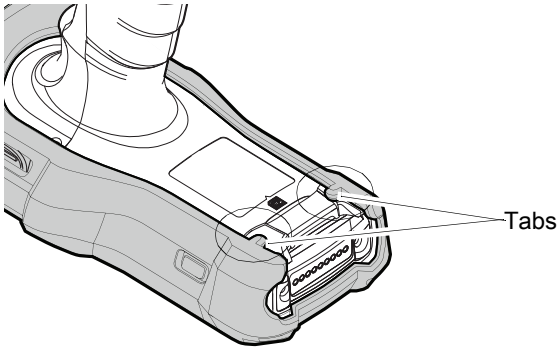

**NOTE:** To charge the device in a cradle, completely remove the rubber boot.

## Installing the Hand Strap

To install the hand strap:

1. Thread and pull-through the short section through the opening near the base of the trigger handle.

Figure 46 Insert Loop Through Handle Slot

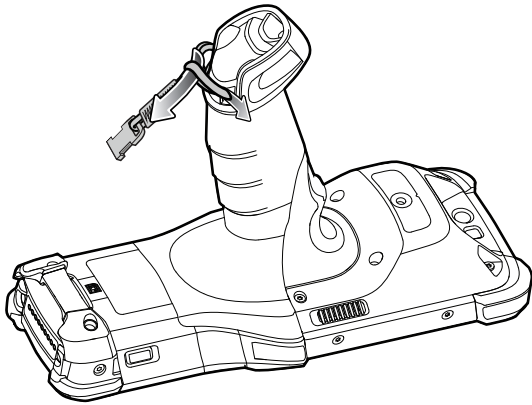

2. Thread and pull-through the longer section through the opening near the battery.

Figure 47 Pull-through Hand Strap Near Battery

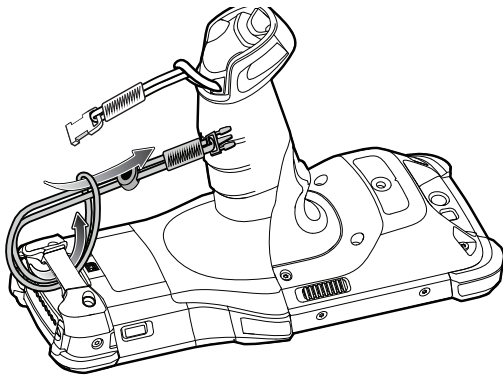

3. Attach the two plastic ends together.

Figure 48 Attach Plastic Ends Together

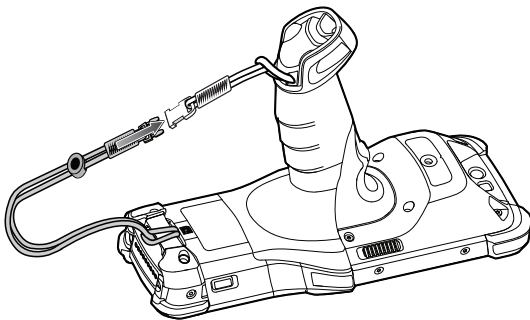

## 4-Slot Charge Only ShareCradle Rack Installation

Use the Rack/Wall Mount Bracket to mount a 4-slot charge only sharecradle on a rack. When installing on a rack, first assemble the bracket and cradles/chargers and then install the assembly on the rack.

1. Place the power supply in bottom tray.
2. Connect AC line cord to power supply.
3. Connect DC line cord to power supply.
4. Secure power supply and cables to bottom tray with tie wraps.



**NOTE:** Ensure tie wrap buckle is on side of power supply. Tie wrap buckle on top of power supply interferes with top tray.

5. Route cables through cable slots.

Figure 49 Power Supply in Bottom Tray

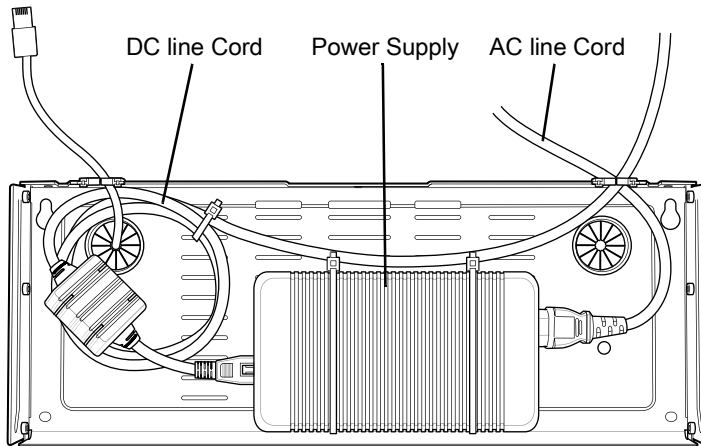

6. Secure four M2.5 studs to top tray as shown.

Figure 50 Install Studs

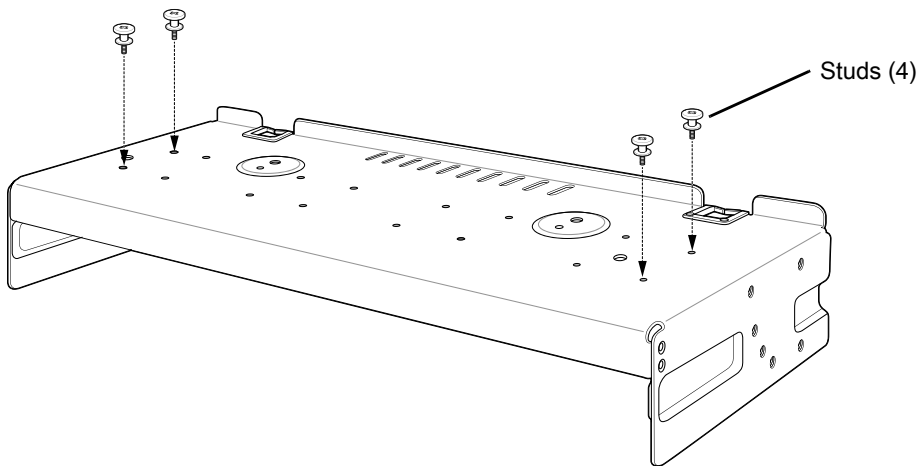

7. Align and install 4-Slot cradle onto studs of top tray.

Figure 51 Align Cradle on Studs

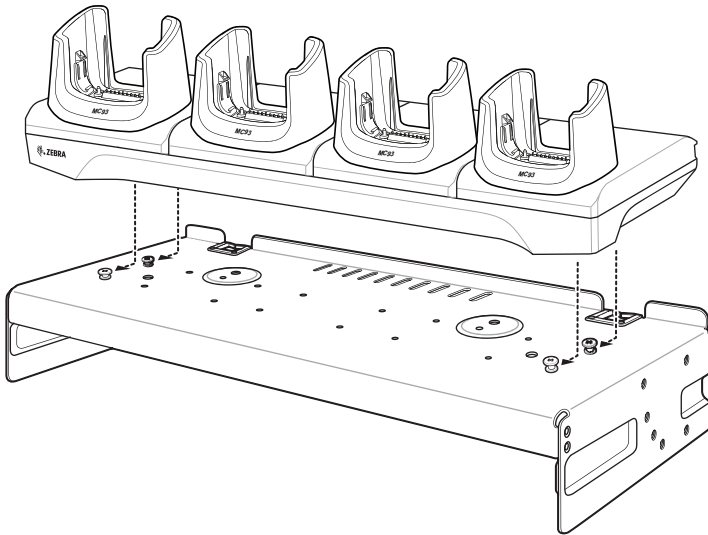

8. Secure cradle to top tray with two M2.5 safety screws.

Figure 52 Secure Cradle

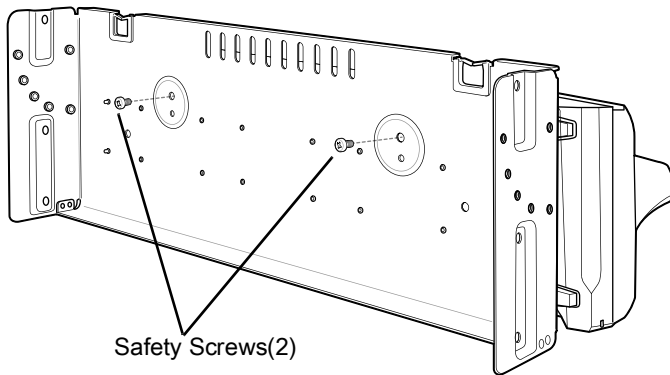

9. Slide top tray onto bottom tray.

Figure 53 Slide Top Tray onto Bottom Tray

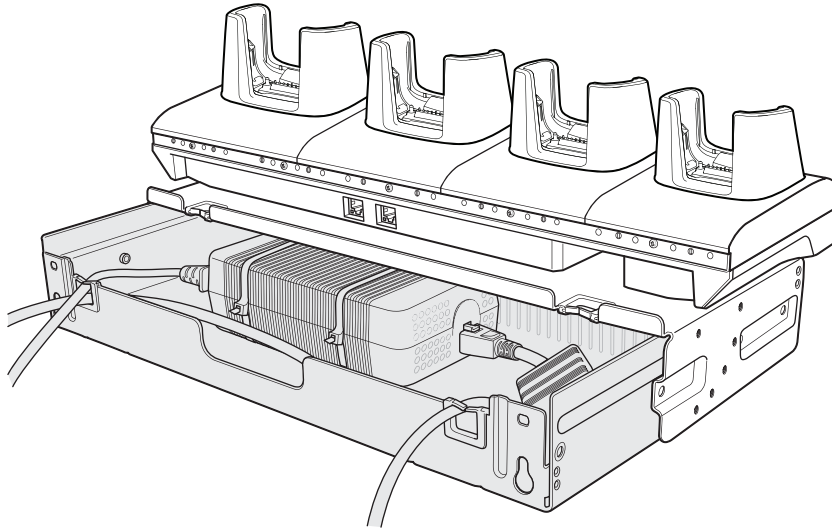

10. Connect cables to cradle.

Figure 54 Connect Cables

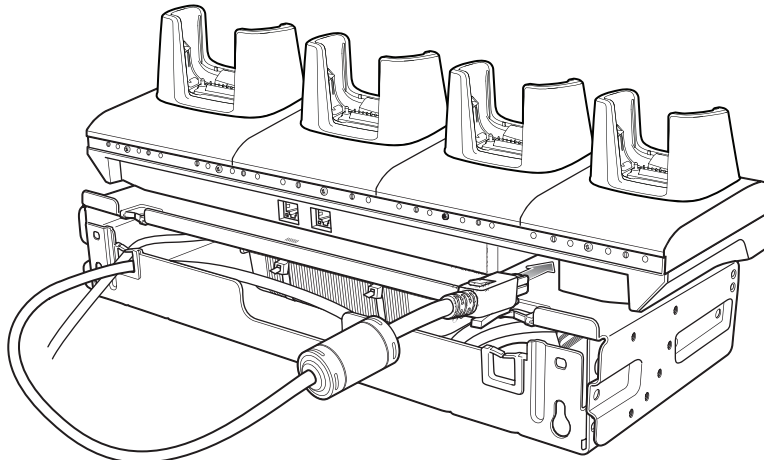

11. Secure top tray to bottom tray with 4 M5 screws (two on each side).

Figure 55 Secure Top and Bottom Tray

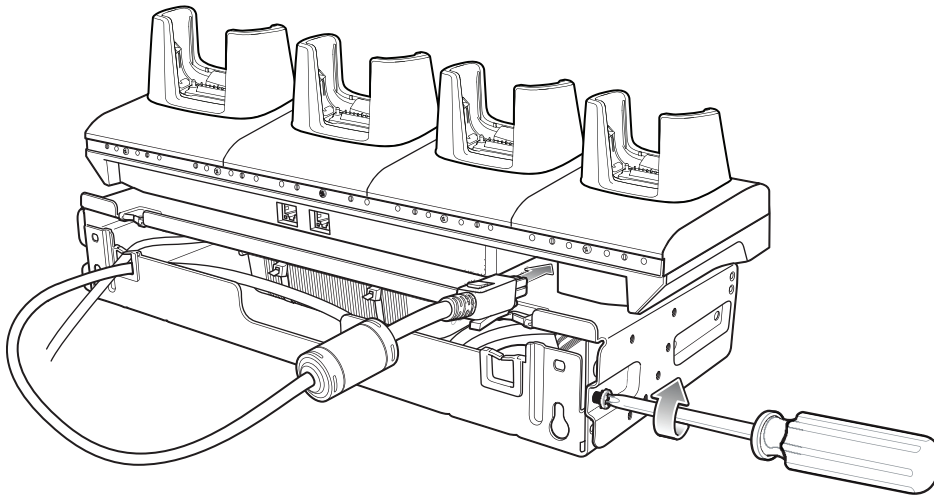

See [Rack Mount Installation on page 59](#) for installing the bracket assembly onto a rack.

## Rack Mount Installation



**NOTE:** Use screws provided with rack system. Refer to rack user documentation for instructions.

1. Secure mounting brackets to both sides of top tray with four M5 screws (two on each side). For 4-Slot cradles, position the flange for horizontal installation. For 4-Slot Battery Chargers, position the flange for 25° installation.

Figure 56 Flange Horizontal Position (4-Slot Cradles)

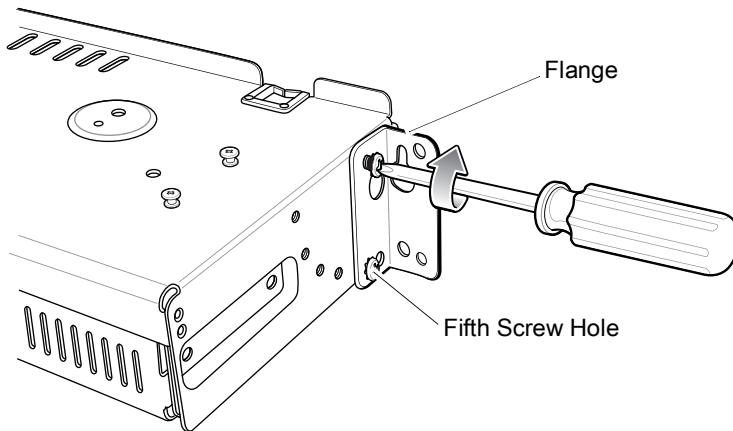
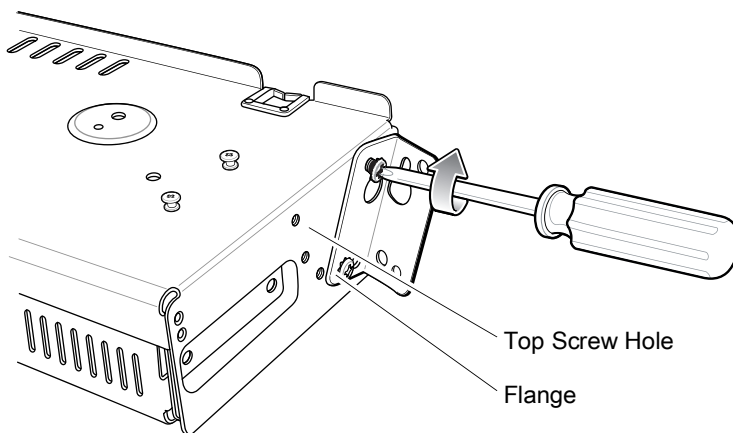

Figure 57 Flange 25° Position (4-Slot Battery Chargers)



**CAUTION:** Install mounting bracket with 4-Slot cradle at a maximum height of four feet from ground. Install mounting bracket with 4-Slot Battery Charger at a maximum height of three feet from ground.



**NOTE:** Distance between two horizontal mounted brackets should be at least 14" apart (from top of one flange to the top of the next flange).

Distance between a horizontal mounted bracket and a 25° mounted bracket should be at least 16.25" apart (from top of one flange to the top of the next flange).

There should be enough clearance (2.75") between the top of the device and the bottom of the mounting bracket above.

2. Install two rack system screws for top of mounting brackets. The screw heads should protrude half way from the rail.

Figure 58 Install Rack System Screws

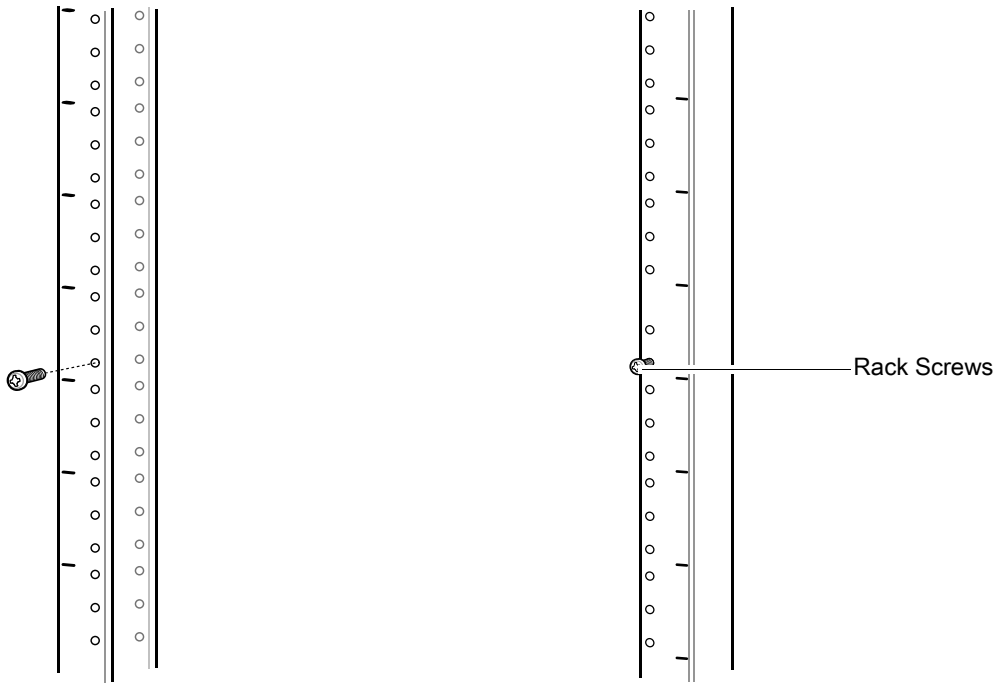

3. Align the mounting bracket's top mounting key holes with the screws.
4. Place the brackets on the screws.

Figure 59 Secure Bracket to Rack (Horizontal Position Shown)

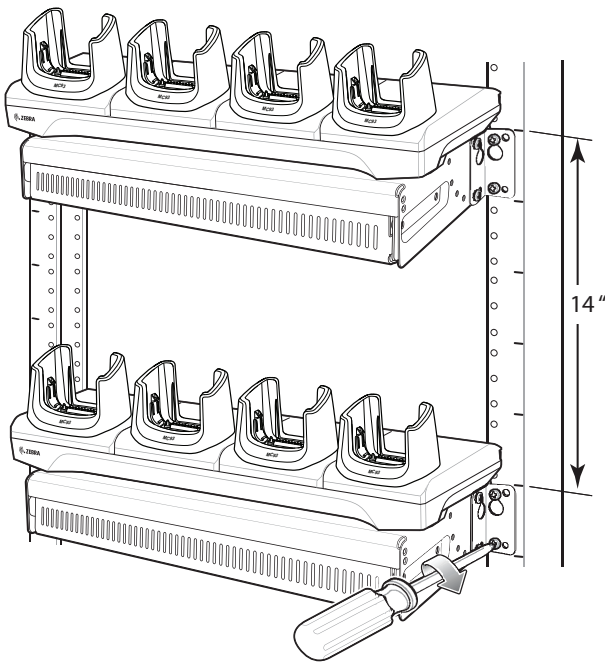



5. Secure the top screws.
6. Install bottom screws and tighten screws.
7. Route cables and connect to power source.



**CAUTION:** Installer should ensure that all building codes are followed when connecting the power supplies to an AC power source.

While installing the brackets, power supplies and cables:

- Use tie wraps to secure cables to the bracket and rails.
- Coil cables wherever possible.
- Route power cables along the rails.
- Route inter-cradle cables to the side rails and then from the rails to the bracket.

## Wall Installation

Use the Rack/Wall Mount Bracket to mount four 4-Slot Battery Chargers or a cradle on a wall. When installing on a wall, first assemble the bottom tray, install the bottom tray on the wall and then assemble the top tray.

Use mounting hardware (screws and/or anchors) appropriate for the type of wall mounting the bracket onto. The Mount Bracket mounting slots dimensions are 5 mm (0.2 in.). Fasteners must be able to hold a minimum of 20 Kg (44 lbs.)

For proper installation consult a professional installer. Failure to install the bracket properly can possibly result in damage to the hardware.



**CAUTION:** Install mounting bracket with 4-Slot cradle at a maximum height of four feet from ground. Install mounting bracket with 4-Slot Battery Charger at a maximum height of three feet from ground.

## Bottom Tray Assembly

See steps 1 through 5 in [4-Slot Charge Only ShareCradle Rack Installation on page 55](#) for instructions.

## Bracket Wall Mounting

1. Drill holes and install anchors according to the template supplied with the bracket.
2. Install two screws for bottom of bracket. The screw heads should protrude 2.5 mm (0.01") from the wall.

Figure 60 Horizontal Mounting Template

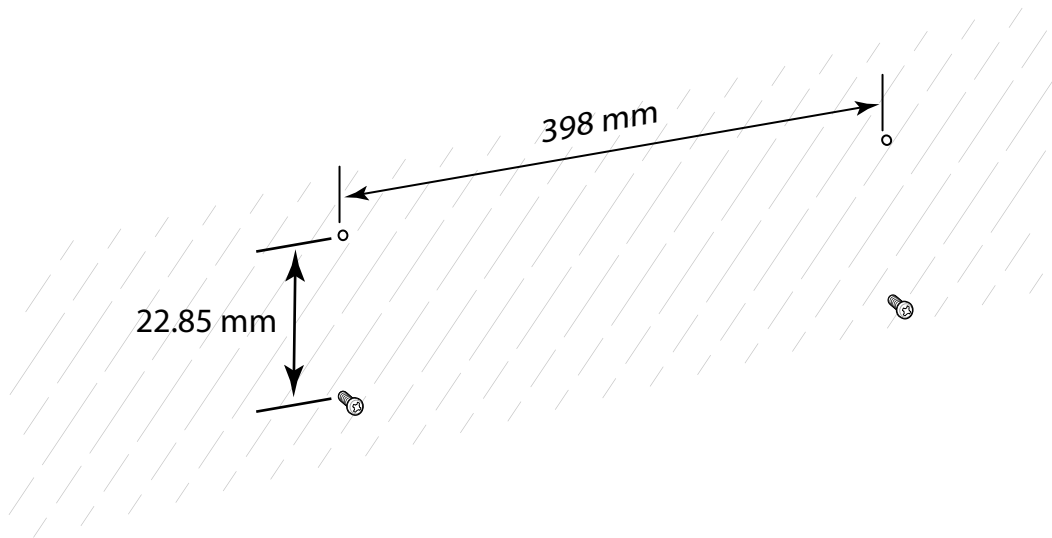

3. Align the mounting bracket's bottom mounting key holes with the screws.
4. Hang the bracket on the screws.

Figure 61 Horizontal Installation

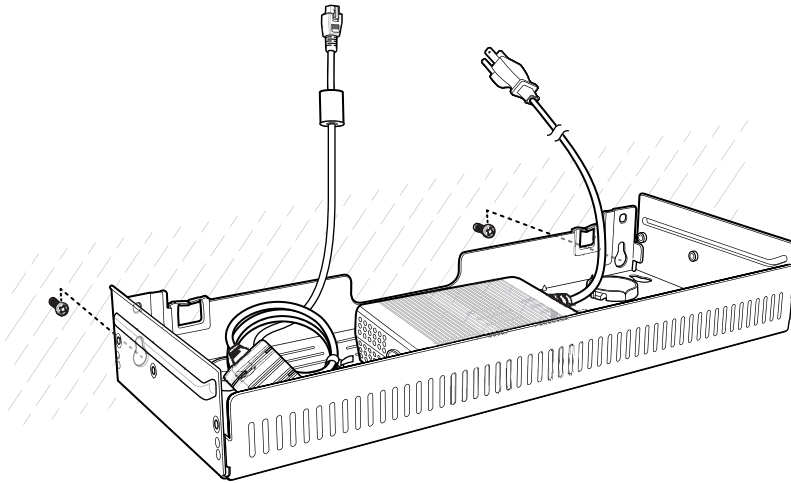

5. Install two top screws.
6. Tighten all screws.

Figure 62 Horizontal Installation - Tighten Screws

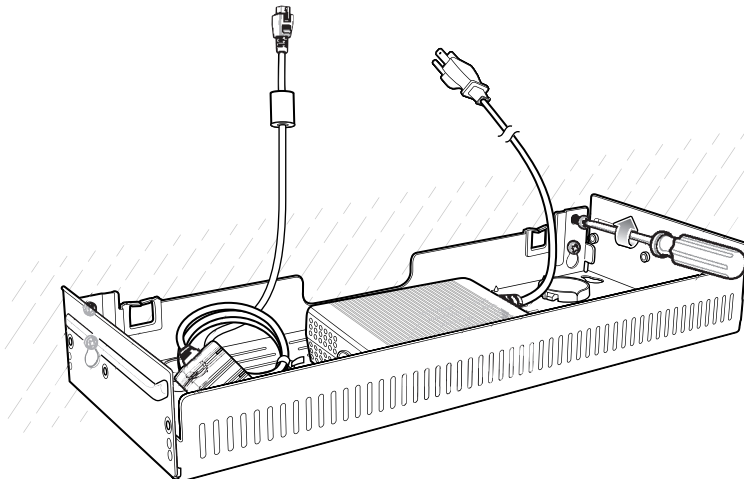

7. Assemble the four 4-Slot Battery Chargers or cradle onto the bracket. See steps 7 through 11 in [4-Slot Charge Only ShareCradle Rack Installation on page 55](#).
8. Route cables and connect to power source.



**CAUTION:** Installer should ensure that all building codes are followed when connecting the power supplies to an AC power source.

While installing the brackets, power supplies and cables:

- Use tie wraps to secure cables to the bracket and rails.
- Coil cables wherever possible.
- Route power cables along the rails.
- Route inter-cradle cables to the side rails and then from the rails to the bracket.

# Settings

## Introduction

This chapter describes settings available for configuring the device.

## WLAN Configuration

This section provides information on configuring Wi-Fi settings.

### Configuring a Secure Wi-Fi Network

To set up a Wi-Fi network:

1. Swipe down from the Status bar to open the Quick Access panel, and then touch .
2. Touch **Network & Internet > Wi-Fi**.
3. Slide the switch to the **ON** position.
4. The device searches for WLANs in the area and lists them on the screen.
5. Scroll through the list and select the desired WLAN network.
6. Touch the desired network. If the network security is **Open**, the device automatically connects to the network. For all other network security a dialog box appears.

Figure 63 WLAN WEP Network Security Dialog Box



**WLAN**  
Password

---

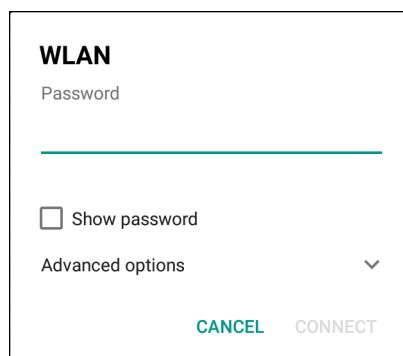
Show password

Advanced options 

CANCEL CONNECT

Figure 64 WLAN 802.11 EAP Network Security Dialog Box

7. If the network security is **WEP** or **WPA/WPS2 PSK**, enter the required password and then touch **Connect**.
8. If the network security is 802.1x EAP:
  - Touch the **EAP method** drop-down list and select **PEAP**, **TLS**, **TTLS**, or **LEAP**.
  - Touch the **Phase 2 authentication** drop-down list and select an authentication method.
  - If required, touch **CA certificate** and select a Certification Authority (CA) certificate. Note: Certificates are installed using the **Security** settings.
  - If required, touch **User certificate** and select a user certificate. Note: User certificates are installed using the Location & security settings.
  - If required, in the **Identity** text box, enter the username credentials.
  - If desired, in the **Anonymous identity** text box, enter an anonymous identity username.
  - If required, in the **Password** text box, enter the password for then given identity.



**NOTE:** By default, the network Proxy is set to **None** and the IP settings is set to **DHCP**. See Configuring for a Proxy Server for setting connection to a proxy server and see Configuring the Device to Use a Static IP Address for setting the device to use a static IP address.

9. Touch **Connect**.

10. Touch .

## Manually Adding a Wi-Fi Network

Manually add a Wi-Fi network if the network does not broadcast its name (SSID) or add a Wi-Fi network when out of range.

1. Swipe down from the Status bar to open the Quick Access panel, and then touch .

2. Touch **Network & Internet > Wi-Fi**.
3. Slide the Wi-Fi switch to the **On** position.
4. Scroll to the bottom of the list and select **Add network**.
5. In the **Network name** text box, enter the name of the Wi-Fi network.
6. In the **Security** drop-down list, set the type of security to:
  - **None**
  - **WEP**
  - **WPA/WPA2 PSK**
  - **802.1x EAP**.
7. If the network security is **None**, touch **Save**.
8. If the network security is **WEP** or **WPA/WPA2 PSK**, enter the required password, and then touch **Save**.
9. If the network security is **802.1x EAP**:
  - Touch the **EAP method** drop-down list and select **PEAP, TLS, TTLS, or LEAP**.
  - Touch the **Phase 2 authentication** drop-down list and select an authentication method.
  - If required, touch **CA certificate** and select a Certification Authority (CA) certificate. Note: Certificates are installed using the **Security** settings.
  - If required, touch **User certificate** and select a user certificate. Note: User certificates are installed using the **Security** settings.
  - If required, in the **Identity** text box, enter the username credentials.
  - If desired, in the **Anonymous** identity text box, enter an anonymous identity username.
  - If required, in the **Password** text box, enter the password for the given identity.



**NOTE:** By default, the network Proxy is set to **None** and the IP settings is set to **DHCP**. See Configuring for a Proxy Server for setting connection to a proxy server and see Configuring the Device to Use a Static IP Address for setting the device to use a static IP address.

10. Touch **Save**. To connect to the saved network, touch and hold on the saved network and select **Connect to network**.
11. Touch .

## Configuring for a Proxy Server

A proxy server is a server that acts as an intermediary for requests from clients seeking resources from other servers. A client connects to the proxy server and requests some service, such as a file, connection, web page, or other resource, available from a different server. The proxy server evaluates the request according to its filtering rules. For example, it may filter traffic by IP address or protocol. If the request is validated by the filter, the proxy provides the resource by connecting to the relevant server and requesting the service on behalf of the client.

It is important for enterprise customers to be able to set up secure computing environments within their companies, making proxy configuration essential. Proxy configuration acts as a security barrier ensuring that the proxy server monitors all traffic between the Internet and the intranet. This is normally an integral part of security enforcement in corporate firewalls within intranets.

To configure the device for a proxy server:

1. Swipe down from the Status bar to open the Quick Access panel, and then touch .
2. Touch **Network & Internet > Wi-Fi**.
3. Slide the Wi-Fi switch to the **On** position.
4. In the network dialog box, select and touch a network.
5. Touch **Advanced options**.
6. Touch **Proxy** and select **Manual**.

Figure 65 Proxy Settings



**WLAN**

Proxy  
Manual

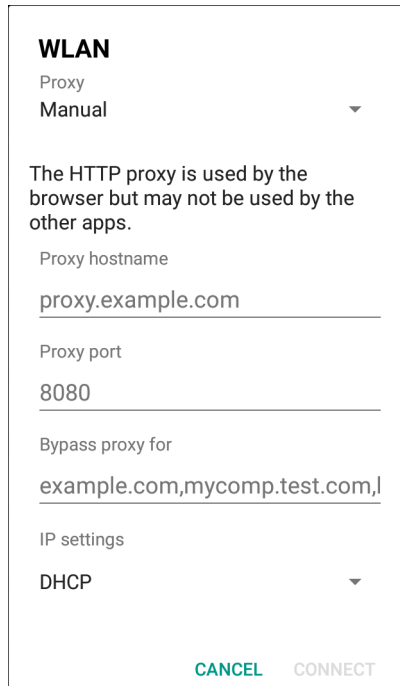
The HTTP proxy is used by the browser but may not be used by the other apps.

Proxy hostname  
proxy.example.com

Proxy port  
8080

Bypass proxy for  
example.com,mycomp.test.com,|

IP settings  
DHCP

CANCEL CONNECT

7. In the **Proxy hostname** text box, enter the address of the proxy server.
8. In the **Proxy port** text box, enter the port number for the proxy server.
9. In the **Bypass proxy for** text box, enter addresses for web sites that are not required to go through the proxy server. Use a comma “,” between addresses. Do not use spaces or carriage returns between addresses.
10. Touch **Connect**.
11. Touch .

## Configuring the Device to Use a Static IP Address

By default, the device is configured to use Dynamic Host Configuration Protocol (DHCP) to assign an Internet protocol (IP) address when connecting to a wireless network.

To configure the device to connect to a network using a static IP address:

1. Swipe down from the Status bar to open the Quick Access panel, and then touch .
2. Touch **Network & Internet > Wi-Fi**.

3. Slide the Wi-Fi switch to the **On** position.
4. In the network dialog box, select and touch a network.
5. Touch **Advanced options**.
6. Touch **IP settings** and select **Static**.

Figure 66 Static IP Settings

**WLAN**

IP settings  
Static

IP address  
192.168.1.128

Gateway  
192.168.1.1

Network prefix length  
24

DNS 1  
8.8.8.8

DNS 2  
8.8.4.4

CANCEL CONNECT

7. In the **IP address** text box, enter an IP address for the device.
8. If required, in the **Gateway** text box, enter a gateway address for the device.
9. If required, in the **Network prefix length** text box, enter the prefix length.
10. If required, in the **DNS 1** text box, enter a Domain Name System (DNS) address.
11. If required, in the **DNS 2** text box, enter a DNS address.
12. Touch **Connect**.
13. Touch .

## Wi-Fi Preferences

Use the **Wi-Fi preferences** to configure advanced Wi-Fi settings. From the Wi-Fi screen scroll down to the bottom of the screen and touch **Wi-Fi preferences**.

- **Open network notification** - When enabled, notifies the user when an open network is available.
- **Advanced - Touch to expand options.**
  - **Additional settings** - See Additional Settings.
  - **Install Certificates** – Touch to install certificates.
  - **Network rating provider** - Disabled (AOSP devices). To help determine what constitutes a good Wi-Fi network, Android supports external Network rating providers that provide information about the quality of



open Wi-Fi networks. Select one of the providers listed or **None**. If none are available or selected, the Connect to open networks feature is disabled.

- **MAC address** - Displays the Media Access Control (MAC) address of the device when connecting to Wi-Fi networks.
- **IP address** - Displays the IP address of the device when connecting to Wi-Fi networks.

## Additional Wi-Fi Settings



**NOTE:** Additional Wi-Fi settings are for the device, not for a specific wireless network.

Use the **Additional Settings** to configure additional Wi-Fi settings. To view the additional Wi-Fi settings, scroll to the bottom of the **Wi-Fi** screen and touch **Wi-Fi Preferences > Advanced > Additional settings**.

- **Regulatory**
  - **Country Selection** - Displays the acquired country code if 802.11d is enabled, else it displays the currently selected country code.
  - **Region code** - Displays the current region code.
- **Band and Channel Selection**
  - **Wi-Fi frequency band** - Set the frequency band to: **Auto** (default), **5 GHz only** or **2.4 GHz only**.
  - **Available channels (2.4 GHz)** - Touch to display the **Available channels** menu. Select specific channels and touch **OK**.
  - **Available channels (5 GHz)** - Touch to display the **Available channels** menu. Select specific channels and touch **OK**.
- **Logging**
  - **Advanced Logging** – Touch to enable advanced logging or change the log directory.
  - **Wireless logs** - Use to capture Wi-Fi log files.
    - **Fusion Logger** - Touch to open the **Fusion Logger** application. This application maintains a history of high level WLAN events which helps to understand the status of connectivity.
    - **Fusion Status** - Touch to display live status of WLAN state. Also provides information about the device and connected profile.
- **About**
  - **Version** - Displays the current Fusion information.

## Wi-Fi Direct

Wi-Fi Direct devices can connect to each other without having to go through an access point. Wi-Fi Direct devices establish their own ad-hoc network when required, letting you see which devices are available and choose which one you want to connect to.

1. Swipe down from the status bar and then touch .
2. Touch **Wi-Fi > Wi-Fi preferences > Advanced > Wi-Fi Direct**. The device begins searching for another Wi-Fi Direct device.

Figure 67 Wi-Fi Direct Screen

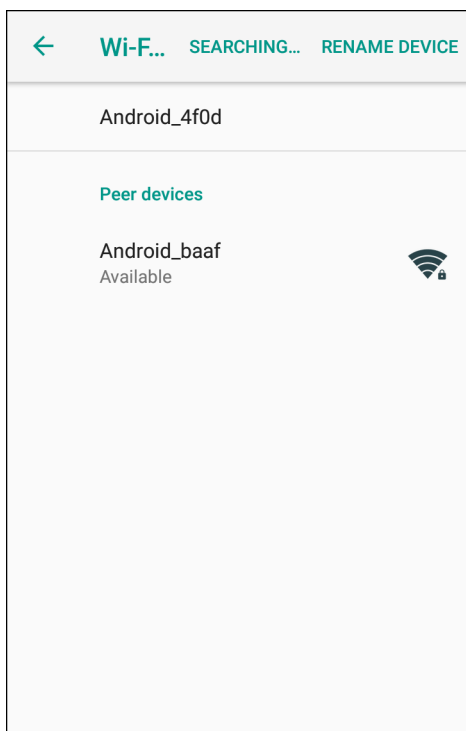

3. Under **Peer devices**, touch the other device name.
4. On the other device, select **Accept**.
5. **Connected** appears on the device. On both devices, in their respective Wi-Fi Direct screens, the other device name appears in the list.

## WPS Push Button

Wi-Fi Protected Setup (WPS) is a feature allowing devices to easily connect to Wi-Fi access points without typing a long password.

To use a wireless router WPS button:

1. On the device, swipe down from the status bar and then touch .
2. Touch **Wi-Fi > Wi-Fi preferences > Advanced > WPS Push Button**. A dialog box displays.

Figure 68 WPS Setup Dialog Box



3. On the wireless router, locate the WPS button. The device connects to the wireless router.

## WPS Pin Entry

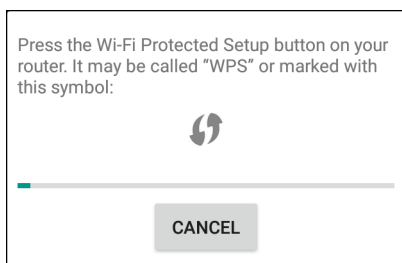
Wi-Fi Protected Setup (WPS) is a feature allowing devices to easily connect to Wi-Fi access points without typing a long password.

To use a PIN to connect to a wireless router:

1. Log in to the router.
2. Go to the Add WPS Client screen. Refer to the wireless router user documentation specific information.
3. On the device, swipe down from the status bar, and then touch .
4. Touch **Wi-Fi > Wi-Fi preferences > Advanced > WPS Pin Entry**. A dialog box displays with an Pin number.

Figure 69 Pin Entry Dialog Box



5. On the router, enter the Pin number. The device connects to the wireless router.

## Setting Screen Lock

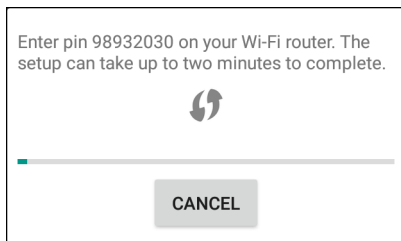
Use the **Device security** settings to set preferences for locking the screen.

1. Swipe down from the Status bar to open the Quick Access panel, and then touch .
2. Touch **Security & location**.



**NOTE:** Options vary depending upon the policy of some apps, such as email.

- **Screen lock** - Touch to configure the device to require a slide, pattern, PIN, or password to unlock the screen.
  - **None** - Disable screen unlock security.
  - **Swipe** - Slide the lock icon to unlock the screen.
  - **Pattern** - Draw a pattern to unlock screen. See Setting Screen Unlock Using Pattern for more information.
  - **PIN** - Enter a numeric PIN to unlock screen. See Setting Screen Lock Using PIN for more information.
  - **Password** - Enter a password to unlock screen. See Setting Screen Unlock Using Password for more information.

Lock the screen to protect access to data on the device. Some email accounts require locking the screen. The Locking feature functions differently in Single-user versus Multiple-user mode.

When locked, a slide, pattern, PIN or password is required to unlock the device. Press the Power button to lock the screen. The device also locks after a pre-defined time-out.

Press and release the Power button to wake the device. The Lock screen displays.

Slide the screen up to unlock. If the Pattern screen unlock feature is enabled, the Pattern screen appears instead of the Lock screen.

If the PIN or Password screen unlock feature is enabled, enter the PIN or password after unlocking the screen.

## Setting Screen Lock Using PIN

1. Swipe down from the Status bar to open the Quick Access panel, and then touch .
2. Touch **Security & location**.
3. Touch **Screen lock**.
4. Touch **PIN**.
5. To require a PIN upon device start up select **Yes**, or select **No** not to require a PIN.

**Figure 70** PIN Screen

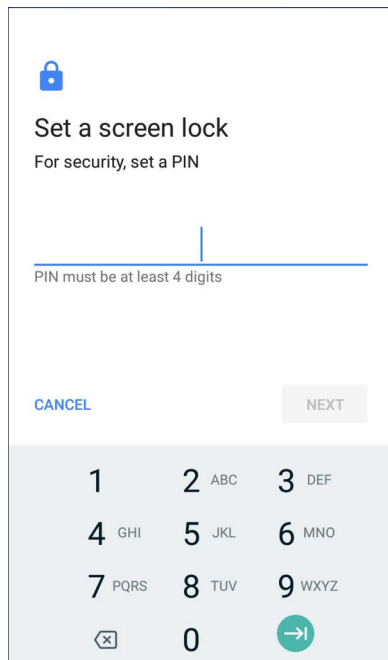

6. Touch in the text field.
7. Enter a PIN (4 numbers), and then touch **Next**.
8. Re-enter PIN and then touch **Next**.
9. Select the type of notifications that appear when the screen is locked and then touch **Done**.
10. Touch . The next time the device goes into suspend mode a PIN is required upon waking.

## Setting Screen Unlock Using Password

1. Swipe down from the Status bar to open the Quick Access panel, and then touch .

2. Touch **Security & location**.
3. Touch **Screen lock**.
4. Touch **Password**.
5. To require a password upon device start up select **Yes**, or select **No** not to require a password.
6. Touch in the text field.
7. Enter a password (between 4 and 16 characters), and then touch **Next**.

**Figure 71** Password Screen

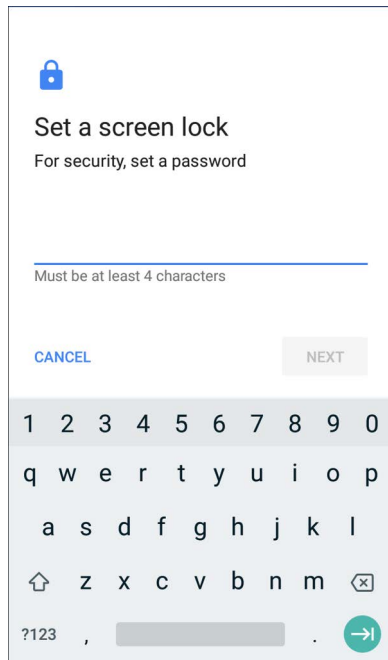

8. Re-enter the password and then touch **Next**.
9. Select the type of notifications that appear when the screen is locked and then touch **Done**.
10. Touch . The next time the device goes into suspend mode a password is required upon waking.

## Setting Screen Unlock Using Pattern

1. Swipe down from the Status bar to open the Quick Access panel, and then touch .
2. Touch **Security & location**.
3. Touch **Screen lock**.
4. Touch **Pattern**.
5. To require a pattern upon device start up select **Yes**, or select **No** not to require a pattern.

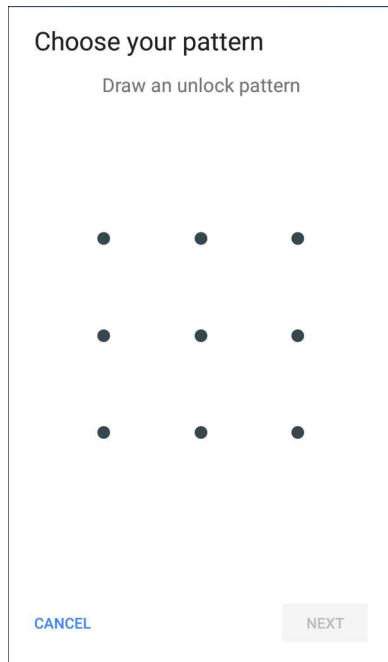
**Figure 72** Choose Your Pattern Screen

6. Draw a pattern connecting at least four dots.
7. Touch **Continue**.
8. Re-draw the pattern.
9. Touch **Confirm**.
10. Select the type of notifications that appear when the screen is locked, and then touch **Done**.
11. Touch . The next time the device goes into suspend mode a pattern is required upon waking.

## Showing Passwords

To set the device to briefly show password characters as the user types:

1. Swipe down from the Status bar to open the Quick Access panel and then touch .
2. Touch **Security & location**.
3. Slide the **Show passwords** switch to the ON position.

## Remapping a Button

Buttons on the device can be programmed to perform different functions or as shortcuts to installed apps.



**NOTE:** It is not recommended to remap the scan button.

1. Swipe down from the Status bar to open the Quick Access panel and then touch .
2. Touch **Key Programmer**. A list of programmable buttons displays.

Figure 73 Button Remap Program Screen



3. Select the button to remap.

Figure 74 KeyProgrammer Screen

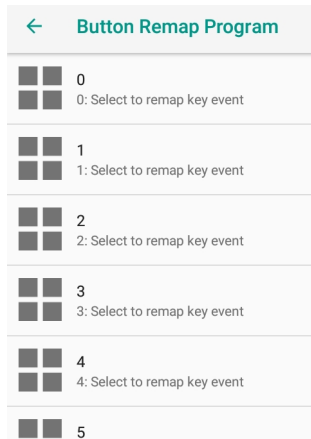
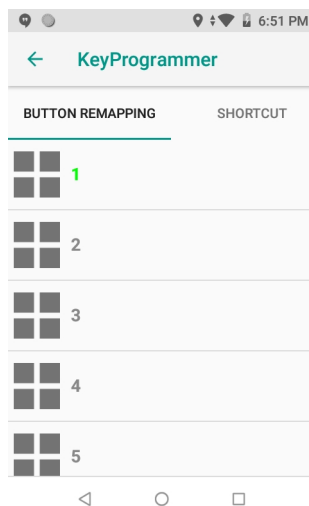

4. Touch the **BUTTON REMAPPING** tab or the **SHORTCUT** tab that lists the available functions and applications.
5. Touch a function or application shortcut to map to the button.



**NOTE:** If you select an application shortcut, the application icon appears next to the button on the Key Programmer screen.

6. Touch ○.

## Accounts



Use the **Accounts** settings to add, remove, and manage accounts. Use these settings to control how applications send, receive, and sync data on their own schedules, and whether applications can synchronize user data automatically.

Applications may also have their own settings to control how they synchronize data; see the documentation for those applications for details.



## Language Usage

Use the **Language & input** settings to change the device's language, including words added to the dictionary.

### Changing the Language Setting

1. Swipe down from the Status bar to open the Quick Access panel and then touch .
2. Touch **System > Languages & input**.
3. Touch **Languages**. A list of available languages displays.
4. If the desired language is not listed, touch **Add a language** and select a language from the list.
5. Touch and hold  to the right of the desired language, then drag it to the top of the list.
6. The operating system text changes to the selected language.

### Adding Words to the Dictionary

1. Swipe down from the Status bar to open the Quick Access panel and then touch .
2. Touch **System > Languages & input > Advanced > Personal dictionary**.
3. If prompted, select the language where this word or phrase is stored.
4. Touch **+** to add a new word or phrase to the dictionary.
5. Enter the word or phrase.
6. In the **Shortcut** text box, enter a shortcut for the word or phrase.
7. Touch .

### Keyboard Settings

Use the **Languages & input** settings to configure the on-screen keyboards. The device contains the following keyboard settings:

- Enterprise Keyboard
- Gboard - GMS devices only.
- Physical keyboard

## PTT Express Configuration

Refer to the PTT Express User Guide at [www.zebra.com/support](http://www.zebra.com/support) for information on configuring the PTT Express Client application.

## RxLogger

RxLogger is a comprehensive diagnostic tool that provides application and system metrics, allows for the creation of custom plug-ins, and diagnoses device and application issues. RxLogger logs the following information: CPU load, memory load, memory snapshots, battery consumption, power states, wireless logging,



cellular logging, TCP dumps, Bluetooth logging, GPS logging, logcat, FTP push/pull, ANR dumps, etc. All generated logs and files are saved onto flash storage on the device (internal or external).

**Figure 75** RxLogger

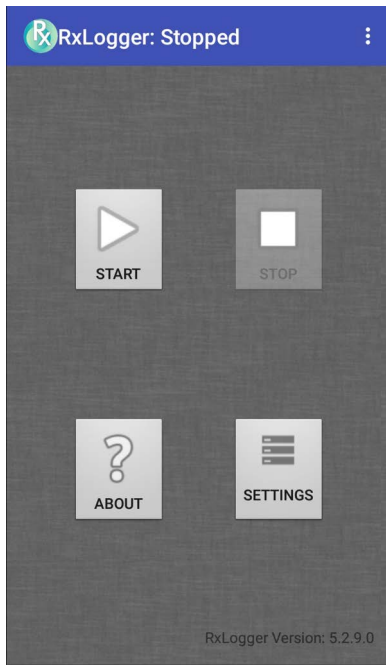

## RxLogger Configuration

RxLogger is built with an extensible plug-in architecture and comes packaged with a number of plug-ins already built-in. The included plug-ins are described below.

To open the configuration screen, from the RxLogger home screen touch **Settings**.

**Figure 76** RxLogger Configuration Screen

SAVE	CANCEL
RxLogger Settings	
ANRModule	
KernelModule	
LogcatModule	
LTSMModule	
RamoopsModule	
ResourceModule	
SnapshotModule	
TCPDumpModule	
TombstoneModule	

## RxLogger Settings

The RxLogger Settings module provides additional RxLogger settings.

- **Enable notifications** - Select to allow RxLogger notifications in the Status bar and Notification panel.
- **Enable debug logs** - Select to enable debug logs.

## ANR Module

Application Not Responsive (ANR) indicates that a running application's UI thread is not responding for a specified time period. RxLogger is able to detect this condition and trigger a copy of the call stack trace of the unresponsive application into the log directory. The event is also indicated in the high level CSV log.

- **Enable Module** - Enables logging for this module.
- **Log path** - Specifies the default log path to store the ANR log files.
- **Collect Historic ANRs** - Collects ANR trace files from the system.

## Kernel Module

The Kernel Module captures kmsg from the system.

- **Enable Module** - Enables logging for this kernel module.
- **Log path** - Specifies the high level log path for storage of all kernel logs. This setting applies globally to all kernel buffers.
- **Kernel Log filename** - Specifies the base log filename for this kernel buffer. The current file count is appended to this name.
- **Max Kernel log file size** - Specifies the maximum size, in megabytes, of an individual log file.
- **Kernel Log interval** - Sets the interval, in seconds, on which to flush the log buffer to the file.

- **Kernel Log file count** - Specifies the number of log files to keep and rotate through. Each log file is subject to the max log size option.
- **Enable System Timestamp in Kernel Log** - Enables system timestamps in kernel logs.
- **System Timestamp Interval** - Sets the interval, in seconds, between system timestamps.
- **Enable Logcat Integration override** - Enables logcat integration overrides.

### Logcat Module

Logcat is an essential debugging tool on Android devices. RxLogger provides the ability to record data from all four of the available logcat buffers. The Logcat plug-in can collect data from multiple logcat buffers provided by the system, which are the main, event, radio, and system buffers. Each of the settings are available for each buffer independently unless otherwise noted.

- **Enable Module** - Enables logging for this module.
- **Log path** - Specifies the high level log path for storage of all logcat logs. This setting applies globally to all logcat buffers.
- **Enable main logcat** - Enables logging for this logcat buffer.
  - **Main Log interval (sec)** - Sets the interval, in seconds, on which to flush the log buffer to the file.
  - **Main Log filename** - Specifies the base log filename for this logcat buffer. The current file count is appended to this name.
  - **Main Log file count** - Specifies the number of log files to keep and rotate through. Each log file is subject to the max log size option.
  - **Main log file size (MB)** - Specifies the maximum size, in megabytes, of an individual log file.
  - **Main log filter** - Custom logcat filter to run on the main buffer.
- **Enable event logcat** - Enables event logging for this logcat buffer.
  - **Event log interval (sec)** - Sets the interval, in seconds, on which to flush the log buffer to the file.
  - **Event log filename** - Specifies the base log filename for this logcat buffer. The current file count is appended to this name.
  - **Event log file count** - Specifies the number of log files to keep and rotate through. Each log file is subject to the max log size option.
  - **Event log file size (MB)** - Specifies the maximum size, in kilobytes, of an individual log file.
  - **Event log filter** - Custom logcat filter to run on the event buffer.
- **Enable radio logcat** - Enables logging for this logcat buffer.
  - **Radio log interval (sec)** - Sets the interval, in seconds, on which to flush the log buffer to the file.
  - **Radio log filename** - Specifies the base log filename for this logcat buffer. The current file count is appended to this name.
  - **Radio log file count** - Specifies the number of log files to keep and rotate through. Each log file is subject to the max log size option.
  - **Radio log file size (MB)** - Specifies the maximum size, in kilobytes, of an individual log file.
  - **Radio log filter** - Custom logcat filter to run on the radio buffer.

- **Enable system logcat** - Enables logging for this logcat buffer.
  - **System log interval (sec)** - Sets the interval, in seconds, on which to flush the log buffer to the file.
  - **System log filename** - Specifies the base log filename for this logcat buffer. The current file count is appended to this name.
  - **System log file count** - Specifies the number of log files to keep and rotate through. Each log file is subject to the max log size option.
  - **System log file size (MB)** - Specifies the maximum size, in kilobytes, of an individual log file.
  - **System log filter** - Custom logcat filter to run on the system buffer.
- **Enable crash logcat** - Enables logging for this crash logcat buffer.
  - **Crash log interval (sec)** - Sets the interval, in seconds, on which to flush the log buffer to the file.
  - **Crash log filename** - Specifies the base log filename for this logcat buffer. The current file count is appended to this name.
  - **Crash log file count** - Specifies the number of log files to keep and rotate through. Each log file is subject to the max log size option.
  - **Crash log file size (MB)** - Specifies the maximum size, in megabytes, of an individual log file.
  - **Crash log filter** - Custom logcat filter to run on the crash buffer.
- **Enable combined logcat** - Enables logging for this logcat buffer.
  - **Enable main buffer** - Enable or disable the addition of the main buffer into the combined logcat file.
  - **Enable event buffer** - Enable or disable the addition of the event buffer into the combined logcat file.
  - **Enable radio buffer** - Enable or disable the addition of the radio buffer into the combined logcat file.
  - **Enable system buffer** - Enable or disable the addition of the system buffer into the combined logcat file.
  - **Enable crash buffer** - Enable or disable the addition of the crash buffer into the combined logcat file.
  - **Combine log interval (sec)** - Sets the interval, in seconds, on which to flush the log buffer to the file.
  - **Combined log filename** - Specifies the base log filename for this logcat buffer. The current file count is appended to this name.
  - **Combined log file count** - Specifies the number of log files to keep and rotate through. Each log file is subject to the max log size option.
  - **Combined log file size (MB)** - Specifies the maximum size, in megabytes, of an individual log file.
  - **Combined log filter** - Custom logcat filter to run on the combined buffer.

### LTS Module

The LTS (Long Term Storage) Module captures data over a long duration of time without losing any data. Whenever a file is done being written, LTS saves it as a GZ file in an organized path for later use.

- **Enable Module** - Enables logging for this module.
- **Storage Directory** - Specifies the high level log path for storage of all logcat logs. This setting applies globally to all logcat buffers.

### Ramoops Module

The Ramoops Module captures the last kmsg from the device.

- **Enable Module** - Enables logging for this module.
- **Log path** - Specifies the high level log path for storage of all ramoops logs. This setting applies globally to all Ramoops buffers.
- **Base filename** - Specifies the base log filename for this kernel buffer. The current file count is appended to this name.

- **Ramoops file count** - Specifies the number of log files to keep and rotate through. Each log file is subject to the log size option.

### Resource Module

The Resource Module captures device information and system statistics at specified intervals. The data is used to determine the health of the device over a period of time.

- **Enable Module** - Enables logging for this module.
- **Log Path** - Specifies the high level log path for storage of all resource logs. This setting applies globally to all resource buffers.
- **Resource Log interval** - Sets the interval, in seconds, on which to flush the log buffer to the file.
- **Resource Log file size** - Specifies the maximum size, in megabytes, of an individual log file.
- **Resource Log file count** - Specifies the number of log files to keep and rotate through. Each log file is subject to the max log size option.
- **Power** - Enables or disables the collection of Battery statistics.
- **System Resource**- Enables or disables the collection of System Resource information.
- **Network** - Enables or disables the collection of Network status.
- **Bluetooth** - Enables or disables the collection of Bluetooth information.
- **Light** - Enables or disables the collection of ambient light level.
- **Heater** - Not supported.

### Snapshot Module

The Snapshot Module collects detailed device statistics at an interval to see detailed device information.

- **Enable Module** - Enables logging for this module.
- **Log Path** - Specifies the base path to use to store the snapshot files
- **Log filename** - Specifies the base filename for all the snapshot files. The current file count is appended to this name.
- **Log Interval (sec)** - Specifies the interval, in seconds, on which to invoke a detailed snapshot.
- **Snapshot file count** - The maximum number of Snapshot files to keep at any one time.
- **Top** - Enables or disables the running of the **top** command for data collection.
- **CPU Info** - Enables detailed per process CPU logging in the snapshot.
- **Memory Info** - Enables logging of detailed per process memory usage in the snapshot.
- **Battery Info** - Enables logging of detailed power information including battery life, on time, charging, and wake locks.
- **Wake Locks** - Enables or disables the collection of the sys/fs wake\_lock information.
- **Time in State** - Enables or disables the collection of the sys/fs cpufreq for each core.
- **Processes** - Enables dumping the complete process list in the snapshot.
- **Threads** - Enables dumping all processes and their threads in the snapshot.
- **Properties** - Enables dumping of all system properties on the device. This includes build/version information as well as state information.
- **Interfaces** - Enables or disables the running of the **netcfg** command for data collection.
- **IP Routing Table** - Enables or disables the collection of the net route for data collection.
- **Connectivity** - Enables or disables the running of the **dumpsys connectivity** command for data collection.
- **Wifi** - Enables or disables the running of the **dumpsys wifi** command for data collection.

- **File systems** - Enables dumping of the available volumes on the file system and the free storage space for each.
- **Usage stats** - Enables dumping of detailed usage information for each package on the device. This includes the number of starts and duration of each run.

### TCPDump Module

The TCPDump Module captures TCP data that happens over the device's networks.

- **Enable Module** - Enables logging for this module.
- **Log path** - Specifies the location to store the TCPDump output log files.
- **Base filename** - Specifies the base filename to use when storing the TCPDump files. The index number of the current log file is appended to the filename.
- **Tcpdump file size (MB)** - Specifies the maximum file size, in megabytes, for each log file created.
- **Tcpdump file count** - Specifies the number of log files to cycle through when storing the network traces.

### Tombstone Module

The Tombstone Module collects tombstone (Linux Native Crashes) logs from the device.

- **Enable Module** - Enables logging for this module.
- **Log path** - Specifies the location to store the Tombstone output log files.
- **Collect Historic tombstones** - Collects new and existing tombstone files.

## Configuration File

RxLogger configuration can be set using an XML file. The `config.xml` configuration file is located in the `RxLogger\config` folder. Copy the file from the device to a host computer using a USB connection. Edit the configuration file and then replace the XML file on the device. There is no need to stop and restart the RxLogger service since the file change is automatically detected.

## Enabling Logging

To enable logging:

1. Swipe the screen up and select .
2. Touch **Start**.
3. Touch .

## Disabling Logging

To disable logging:

1. Swipe the screen up and select .
2. Touch **Stop**.
3. Touch .

## Extracting Log Files

1. Connect the device to a host computer using an USB connection.
2. Using a file explorer, navigate to the **RxLogger** folder.
3. Copy the file from the device to the host computer.
4. Disconnect the device from the host computer.

## RxLogger Utility

RxLogger Utility is a data monitoring application for viewing logs in the device while RxLogger is running. Logs and RxLogger Utility features are accessed in the App View or the Overlay View.

### App View

In App View, the user views logs in the RxLogger Utility.

**Figure 77** App View

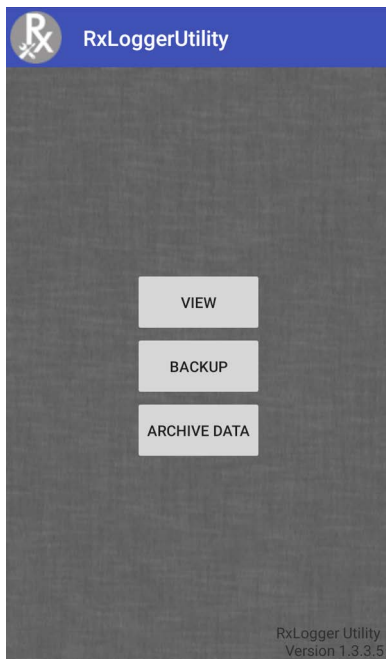

### Viewing Logs

To view logs:

1. Touch the Main Chat Head icon. The Overlay View screen appears.

**Figure 78** Overlay View Screen

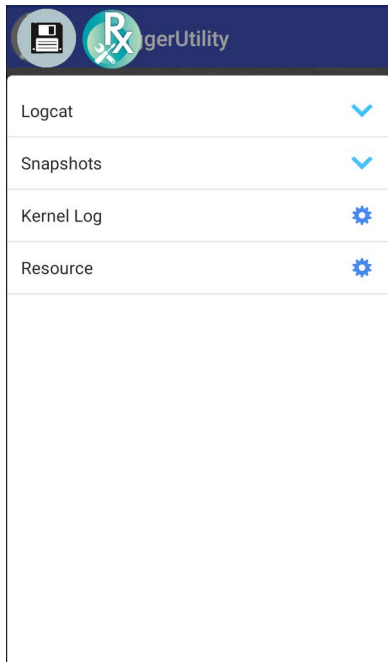

2. Touch a log to open it. The user can open many logs with each displaying a new sub Chat Head.
3. If necessary, scroll left or right to view additional Sub Chat Head icons.
4. Touch a Sub Chat Head to display the log contents.

**Figure 79** Log File

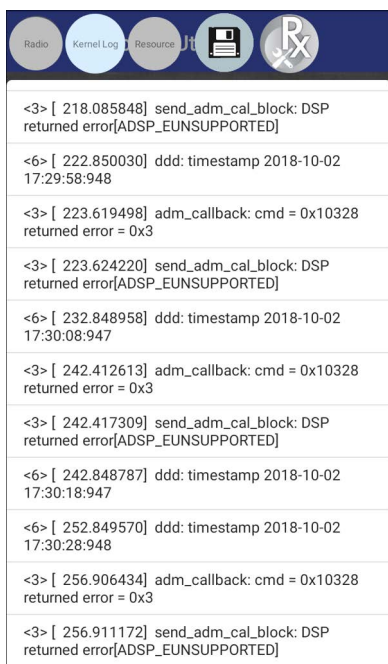



## Backup

RxLogger Utility allows the user to make a zip file of the **RxLogger** folder in the device, which by default contains all the RxLogger logs stored in the device.

To save the backup data, touch **BACKUP > Yes**.

**Figure 80** Backup Message

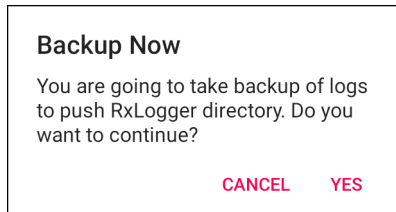

## Archive Data

View all the RxLogger logs stored in the default **RxLogger** directory. Logs viewed in the Archive window are not live.

**Figure 81** Archive

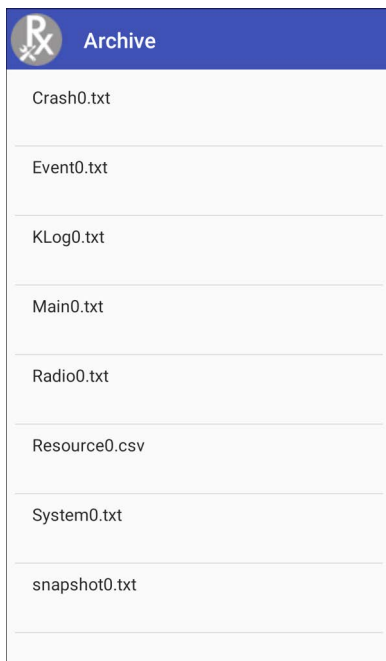

To view the log files, touch **ARCHIVE DATA** and then touch a log file.

## Overlay View

Use Overlay View to display RxLogger information while using other apps or on the home screen. Overlay View is accessed using the Main Chat Head.

## Initiating the Main Chat Head

To initiate the Main Chat Head:

1. Open **RxLogger**.
2. Touch **☰** > **Toggle Chat Head**. The Main Chat Head icon appears on the screen.
3. Touch and drag the Main Chat head icon to move it around the screen.

## Removing the Main Chat Head

To remove the Main Chat Head icon:

1. Touch and drag the icon. A circle with an X appears.
2. Move the icon over the circle and then release.

## Viewing Logs

To view logs:

1. Touch the Main Chat Head icon. The Overlay View screen appears.

**Figure 82** Overlay View Screen

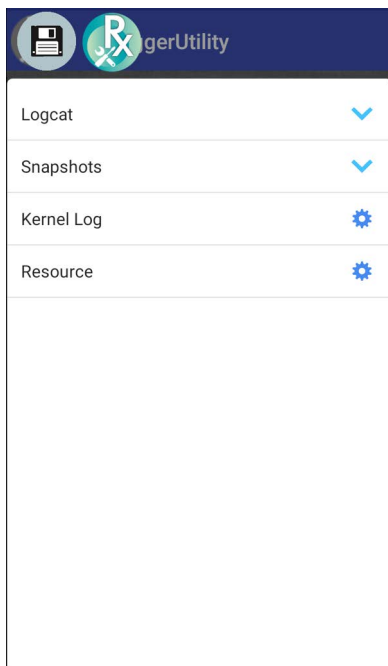

2. Touch a log to open it. The user can open many logs with each displaying a new sub Chat Head.
3. If necessary, scroll left or right to view additional Sub Chat Head icons.

4. Touch a Sub Chat Head to display the log contents.

**Figure 83** Log File

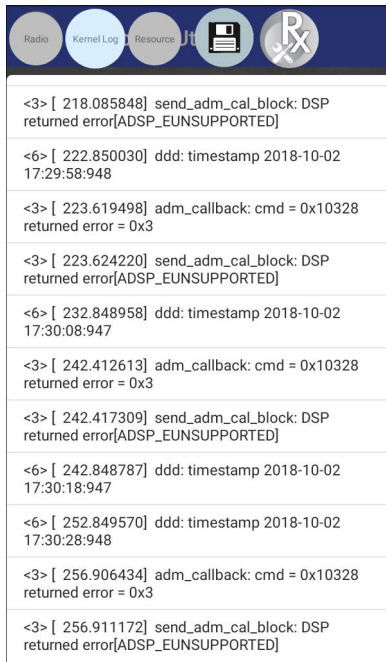

## Removing a Sub Chat Head Icon

To remove a sub chat Head icon, press and hold the icon until it disappears.

## Backing Up In Overlay View

RxLogger Utility allows the user to make a zip file of the RxLogger folder in the device, which by default contains all the RxLogger logs stored in the device.

The Backup icon is always available in Overlay View.

1. Touch . The Backup dialog box appears.
2. Touch **Yes** to create the back up.

## About Phone

Use About phone settings to view information about the device. Swipe down from the Status bar to open the Quick Access panel and then touch  > **System** > **About phone**.

- **Status** - Touch to display the following:
  - **Battery status** - Indicates if the battery is charging (on AC power) or discharging (on battery power).
  - **Battery level** - Indicates the battery charge level.
  - **IP address** - Displays the IP address of the device.
  - **Wi-Fi MAC address** - Displays the Wi-Fi radio MAC address.
  - **Ethernet MAC address** - Displays the Ethernet driver MAC address.
  - **Bluetooth address** - Displays the Bluetooth radio Bluetooth address.
  - **Serial number** - Displays the serial number of the device.
  - **Up time** - Displays the time that the device has been running since being turned on.
- **Battery Information** - Displays information about the battery.
- **SW components** - Lists filenames and versions for various software on the device.
- **Legal information** - Opens a screen to view legal information about the software included on the device.
- **Model** - Displays the devices model number.
- **Android version** - Displays the operating system version.
- **Android security patch level** - Displays the security patch level date.
- **Kernel version** - Displays the kernel version.
- **Build Fingerprint** - Defines Device Manufacturer, Model, Android version and Build version together in one location.
- **Build number** - Displays the software build number.

# USB Communication

## Introduction

This chapter provides information for transferring files between the device and a host computer.

## Transferring Files with a Host Computer via USB

Connect the device to a host computer using a USB cradle to transfer files between the device and the host computer.

When connecting the device to a host computer, follow the host computer's instructions for connecting and disconnecting USB devices, to avoid damaging or corrupting files.

## Transferring Files



**NOTE:** Use Transfer files to copy files between the device (internal memory) and the host computer.

1. Place the device into a USB cradle or into the USB snap on cup.
2. Pull down the Notification panel and touch **USB charging this device**.  
By default, **Charge this device** is selected.

Figure 84 Use USB to Dialog Box

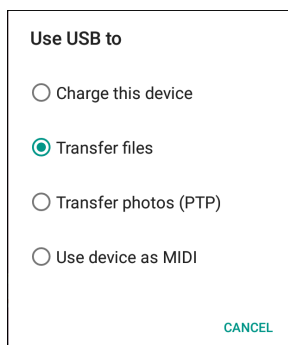

3. Touch **Transfer files**.
4. On the host computer, open a file explorer application.
5. Locate the **device** as a portable device.

6. Open the **Internal storage** folder.
7. Copy files to and from the device or delete files as required.

### Transferring Photos

To transfer photos using Photo Transfer Protocol:



**NOTE:** Use Photo Transfer Protocol (PTP) to copy photos from the internal memory to the host computer.

1. Place the device into a USB cradle.
2. Pull down the Notification panel and touch **USB charging this device**.
3. Touch **Transfer photos (PTP)**.
4. On the host computer, open a file explorer application.
5. Open the **Internal storage** folder.
6. Copy or delete photos as required.

### Disconnect from the Host Computer

To disconnect the device from the host computer:



**CAUTION:** Carefully follow the host computer's instructions to disconnect USB devices correctly to avoid losing information.

1. On the host computer, unmount the device.
2. Remove the device from the cradle.

# DataWedge

## Introduction

This chapter applies to DataWedge on Android devices. DataWedge is an application that reads data, processes the data and sends the data to an application.

## Basic Scanning

Scanning can be performed using the following:

### Barcode Capture with Imager

To capture barcode data:

1. Ensure that an application is open on the device and a text field is in focus (text cursor in text field).
2. Point the top of the device at a barcode.
3. Press and hold the Scan button or Trigger.

The red laser aiming pattern turns on to assist in aiming.

4. Ensure the barcode is within the area formed by the cross-hairs in the aiming pattern. The aiming dot is used for increased visibility in bright lighting conditions.

The Scan LEDs light green and a beep sounds, by default, to indicate the barcode was decoded successfully. Note that when the device is in Pick List Mode, the device does not decode the barcode until the center of the crosshair touches the barcode.

Figure 85 Data Capture

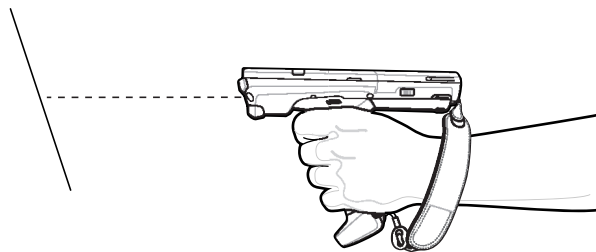

5. Release the scan button or Trigger.

- The barcode content data appears in the text field.

## Profiles

DataWedge is based on profiles and plug-ins. A profile contains information on how DataWedge should behave with different applications.

Profile information consists of:

- Associated application
- Input plug-in configurations
- Output plug-in configurations
- Process plug-in configurations.

Using profiles, each application can have a specific DataWedge configuration. For example, each user application can have a profile which outputs scanned data in the required format when that application comes to the foreground. DataWedge can be configured to process the same set of captured data differently based on the requirements of each application.

DataWedge includes the following pre-configured profiles which support specific built-in applications:

- Visible profiles:
  - **Profile0** - created automatically the first time DataWedge runs. Generic profile used when there are no user created profiles associated with an application.
  - **Launcher** - enables scanning when the Launcher is in foreground.
  - **DWDemo** - provides support for the DWDemo application.

Some Zebra applications are capable of capturing data by scanning. DataWedge is pre-loaded with private and hidden profiles for this purpose. There is no option to modify the private profiles.

## Profile0

**Profile0** can be edited but cannot be associated with an application. That is, **DataWedge** allows manipulation of plug-in settings for **Profile0** but it does not allow assignment of a foreground application. This configuration allows **DataWedge** to send output data to any foreground application other than applications associated with user-defined profiles when **Profile0** is enabled.

**Profile0** can be disabled to allow **DataWedge** to only send output data to those applications which are associated in user-defined profiles. For example, create a profile associating a specific application, disable **Profile0** and then scan. **DataWedge** only sends data to the application specified in the user-created profile. This adds additional security to **DataWedge** enabling the sending of data only to specified applications.

## Plug-ins

A plug-in is a software module utilized in DataWedge to extend its functionality to encompass technologies such as barcode scanning. The plug-ins can be categorized into three types based on their operations:

- Input Plug-ins
- Output Plug-ins
- Process Plug-ins.



## Input Plug-ins

An Input Plug-in supports an input device, such as a barcode scanner contained in, or attached to the device. **DataWedge** contains base plug-ins for these input devices.

**Barcode Scanner Input Plug-in** – The Barcode Scanner Input Plug-in is responsible for reading data from the integrated barcode scanner and supports different types of barcode readers including laser, imager and internal camera. Raw data read from the barcode scanner can be processed or formatted using Process Plug-ins as required. **DataWedge** has built-in feedback functionality for the barcode scanner to issue user alerts. The feedback settings can be configured according to user requirement.

## Process Plug-ins

Process Plug-ins are used in **DataWedge** to manipulate the received data according to the requirement, before sending to the foreground application via the Output Plug-in.

- **Basic Data Formatting Process Plug-in** – The Basic Data Formatting Plug-in allows **DataWedge** to add a prefix and/or a suffix to the captured data before passing it to an Output Plug-in.
- **Advanced Data Formatting Process Plug-in** – The Advanced Data Formatting Plug-in allows **DataWedge** to apply rules (actions to be performed based on defined criteria) to the data received via an input plug-in before passing it to an Output Plug-in.

## Output Plug-ins

Output Plug-ins are responsible for sending the data from Input Plug-ins to a foreground application on the device.

- **Keystroke Output Plug-in** – The Keystroke Output Plug-in collects and sends data received from the Input Plug-in to the foreground applications by emulating keystrokes.
- **Intent Output Plug-in** – The Intent Output Plug-in collects and sends data received from the Input Plug-ins to foreground applications using the Android Intent mechanism.
- **IP Output Plug-in** – The IP Output Plug-in collects and sends data received from the Input Plug-ins to a host computer via a network connection. Captured data can be sent over an IP network to a specified IP address and port using either TCP or UDP transport protocols.

## Profiles Screen

To launch DataWedge, swipe up from the bottom of the screen and touch . By default, the following profiles appear:

- **Profile0**
- **Launcher**
- **DWDemo**

Profile0 is the default profile and is used when no other profile can be applied.

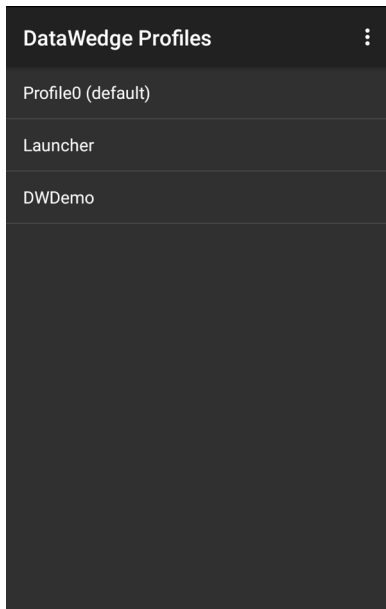
**Figure 86** DataWedge Profiles Screen

Profile names are color coded. Enabled profiles are white and disabled profiles are gray.

To configure a profile touch the profile name.

## Profile Context Menu

Touch and hold a profile to open a context menu that allows additional actions to be performed on the selected profile.

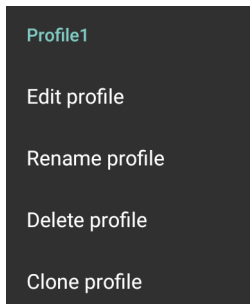
**Figure 87** Profile Context Menu

The profile context menu allows the profile to be edited (same as just tapping on a profile), renamed or deleted.

## Options Menu



Touch  to open the options menu.

Figure 88 DataWedge Options Menu

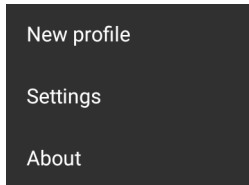

The menu provides options to create a new profile, access to general DataWedge settings and DataWedge version information.

## Disabling DataWedge

1. Swipe up from the bottom of the screen and touch .
2. Touch .
3. Touch **Settings**.
4. Touch **DataWedge enabled**.

The blue check disappears from the checkbox indicating that DataWedge is disabled.

## Creating a New Profile

To create a new profile:



1. Swipe up from the bottom of the screen and touch .
2. Touch .
3. Touch **New profile**.
4. In the **New profile** dialog box, enter a name for the new profile. It is recommended that profile names be unique and made up of only alpha-numeric characters (A-Z, a-z, 0-9).

Figure 89 New Profile Name Dialog Box



5. Touch **OK**.

The new profile name appears in the **DataWedge profile** screen.

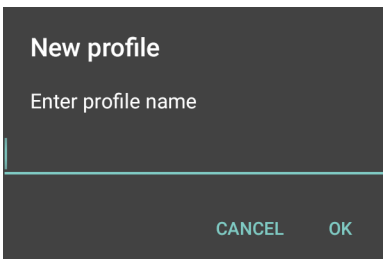
## Profile Configuration

To configure the Profile0 or a user-created profile, touch the profile name.

Figure 90 Profile Configuration Screen

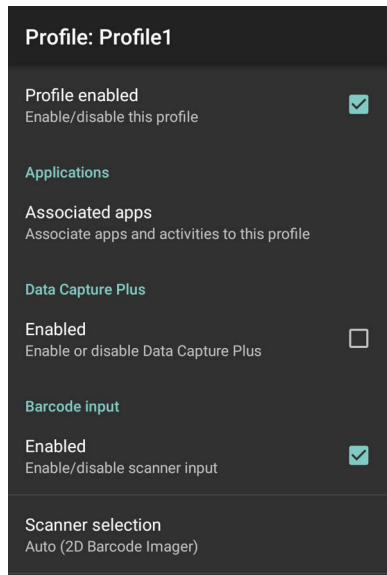

The configuration screen lists the following sections:

- Profile enabled
- Applications
- Data Capture Plus (DCP)
- Barcode Input
- Keystroke output
- Intent Output
- IP Output.

## Associating Applications

Use Applications option to associate applications with this profile. User created profiles should be associated with one or more applications and its activities.

1. Touch **Associated apps**. A list of applications/activities associated with the profile displays. Initially the list does not contain any applications/activities.

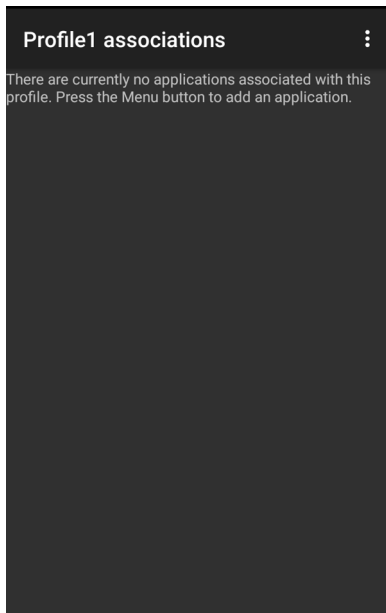
**Figure 91** Associated Apps Screen

2. Touch .
3. Touch **New app/activity**.

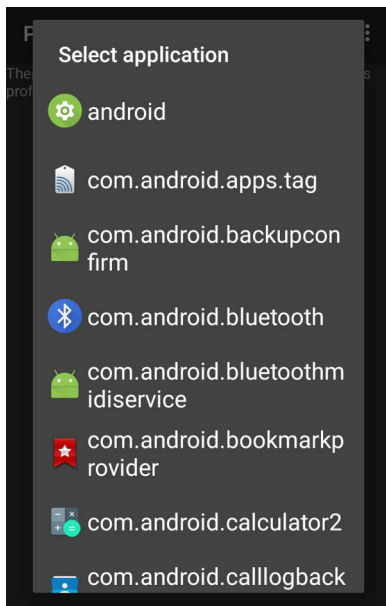
**Figure 92** Select Application Menu

4. In the **Select application** screen, select the desired application from the list.
5. In the **Select activity** menu, selecting the activity adds that application/activity combination to the associated application list for that profile. Selecting \* as the activity results in all activities within that application being associated to the profile. During operation, DataWedge tries to match the specific application/activity combinations with the foreground application/activity before trying to match the general application/\* combinations.
6. Touch .

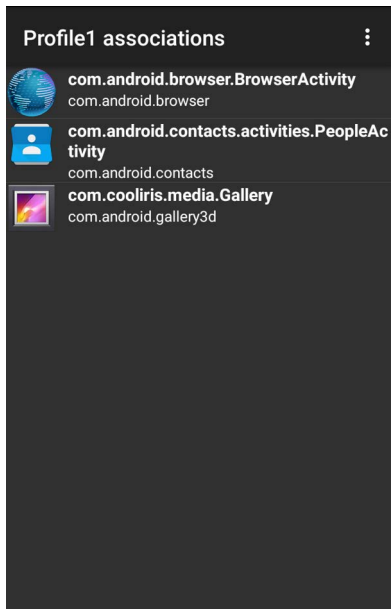
**Figure 93** Selected Application/Activity

## Data Capture Plus

Data Capture Plus (DCP) is a DataWedge feature that enables the user to initiate data capture by touching a designated part of the screen. A variable screen overlay acts like a scan button.

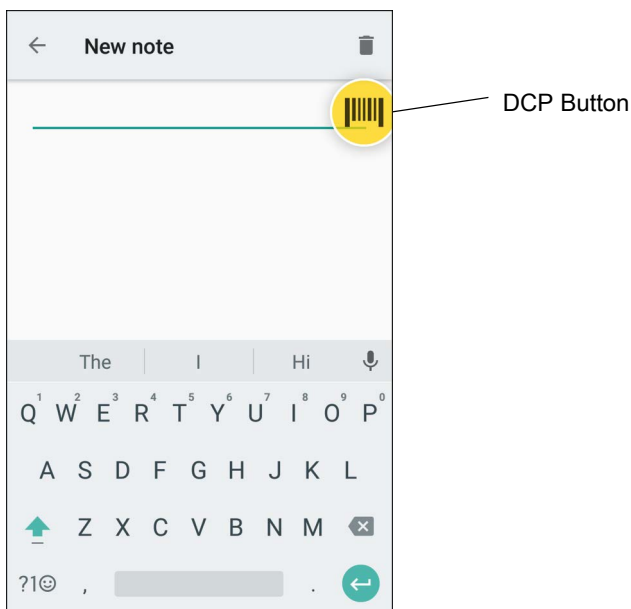
**Figure 94** Minimized Data Capture Panel

The DataWedge profile configuration screen allows the user to configure how the DCP appears on the screen once the particular profile is enabled. The DCP is hidden by default. Enabling DCP option displays seven additional configuration parameters.

Figure 95 Data Capture Panel Settings

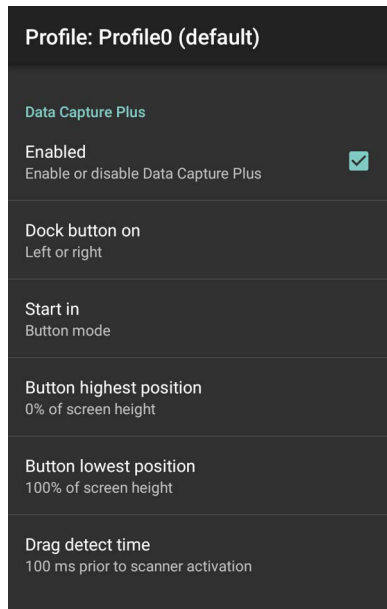

- **Enable** - Select to enable Data Capture Plus (default - disabled).
- **Dock button on** - Select position of the button.
  - **Left or right** - Allows user to place the button on either the right or left edge of the screen.
  - **Left only** - Places the button on left edge of the screen.
  - **Right only** - Places the button on the right edge of the screen.
- **Start in** - Select the initial DCP state.
  - **Fullscreen mode** - DCP covers the whole screen.
  - **Button mode** - DCP displays as a circular button on the screen and can be switched to fullscreen mode.
  - **Button only mode** - DCP displays as a circular button on the screen and cannot be switched to fullscreen mode.
- **Button highest position** - Select the top of the range the user is allowed to move the DCP, given as a percent of the screen height (default - 0).
- **Button lowest position** - Select the bottom of the range the user is allowed to move the DCP, given as a percent of the screen height (default - 100).
- **Drag detect time** - Select the time in milliseconds that the scanner waits before activating scanner. This allows the user to drag the button without initiating scanner (default - 100 ms, maximum 1000 ms).



**NOTE:** The DCP does not appear if the scanner is disabled in the profile even though the **Enabled** option is set.

In Button mode, the user can place DCP in full screen mode by dragging the button over **Fullscreen mode**. The overlay covers the screen.

Figure 96 Maximized DCP

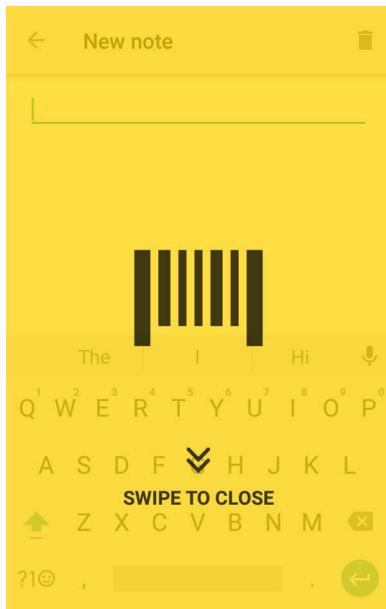

Swipe down to return to button mode.

## Barcode Input

Use the **Barcode Input** options to configure the Barcode Scanner Input Plug-in for the profile.

### Enabled

Enables or disables this plug-in. A check in the checkbox indicates that the plug-in is enabled.

### Scanner Selection

Configures which scanning device to use for barcode data capture when the profile is active. For Bluetooth scanners, if the device was not previously paired, a pairing barcode displays prior to automatic connection.

- **Auto (2D Barcode Imager)** - The software automatically determines the best scanning device.
- **Camera Scanner** - Scanning is performed with the rear-facing camera.
- **2D Barcode Imager** - Scanning is performed using the 2D Imager.
- **Bluetooth Scanner** - Scanning is performed using the optional Bluetooth scanner.
- **RS6000 Bluetooth Scanner** - Scanning is performed using the RS6000 Bluetooth scanner.
- **DS3678 Bluetooth Scanner** - Scanning is performed using the DS3678 Bluetooth scanner.
- **LI3678 Bluetooth Scanner** - Scanning is performed using the DS3678 Bluetooth scanner.
- **DS2278 Bluetooth Scanner** - Scanning is performed using the DS2278 Bluetooth scanner.
- **DS8178 Bluetooth Scanner** - Scanning is performed using the DS8178 Bluetooth scanner.

### Auto Switch to Default on Event

This feature configures DataWedge to select an external scanner as the default scanning device immediately upon connection and revert to a built-in scanner when the external scanner is disconnected. External scanners



include those connecting by Bluetooth, serial cable or snap-on module. Disabled by default. This is only available when **Scanner Selection** is set to **Auto**.

This helps reduce scanning workflow interruptions when a Bluetooth scanner is introduced and/or it becomes disconnected due to losing power or moving out of range.

- **Disabled** - No scanner switching occurs when an external scanner is connected or disconnected (default).
- **On connect** - Selects the external scanner as the default scanning device immediately upon connection.
- **On disconnect** - Reverts to a built-in scanner based on its position in an internally managed scanner list (which varies by host device). This is usually the scanner most recently used prior to the external connection (see notes below).
- **On connect/disconnect** - Selects an external scanner as the default scanning device immediately upon connection. Upon disconnection, reverts to the scanner set as the default prior to the external connection.



**NOTE:** The system selects the default scanner based on the connection state and the scanner's position in an internally managed scanner list. If the newly connected scanner is lower in the scanner list than the one currently selected as the default scanner, the newly connected scanner becomes the default scanner.

On devices with only one built-in scanner or imager, **On disconnect** reverts to that built-in scanner or imager.

## Configure Scanner Settings

Select Configure Scanner Settings to set the following:

- Select scanner to set parameters
- Decoders
- Decoder params
- UPC/EAN params
- Reader params
- Scan params
- UDI params
- Multibarcodes params
- Keep enabled on suspend

## Decoders

Configures which barcode decoders are enabled or disabled. For best performance disable all unnecessary decoders.

Touch **Decoders**. The **Barcode input** screen appears. A check in the checkbox indicates that the decoder is enabled. By default the most commonly used decoders are enabled (shown below with an asterisk). The supported decoders are:



**NOTE:** DataWedge supports the decoders listed below but not all are validated on this device.

Table 8 Supported Decoders

Decoders	Camera	Internal Laser Scanner SE965	Internal Imager SE4750-SR & SE4850-ER	Internal Imager SE4770	RS507/RS507X	RS6000	DS2278	DS3678	LI3678	DS8178
Australian Postal	O	--	O	O	O	O	O	O	--	O
Aztec	X	--	X	X	X	X	X	X	--	X
Canadian Postal	O	--	O	O	--	O	--	--	--	--
Chinese 2 of 5	O	O	O	O	O	O	O	O	O	O
Codabar	X	X	X	X	X	X	X	X	X	X
Code 11	O	O	O	O	O	O	O	O	O	O
Code 128	X	X	X	X	X	X	X	X	X	X
Code 39	X	X	X	X	X	X	X	X	X	X
Code 93	O	O	O	O	O	O	O	O	O	O
Composite AB	O	--	O	O	O	O	O	O	--	O
Composite C	O	--	O	O	O	O	O	O	--	O
Discrete 2 of 5	O	O	O	O	O	O	O	O	O	O
Datamatrix	X	--	X	X	X	X	X	X	--	X
Dutch Postal	O	--	O	O	O	O	O	O	--	O
DotCode	X	O	X	O	O	O	O	O	O	O
EAN13	X	X	X	X	X	X	X	X	X	X
EAN8	X	X	X	X	X	X	X	X	X	X
Grid Matrix	O	O	O	O	O	O	O	O	O	O
GS1 DataBar	X	X	X	X	X	X	X	X	X	X
GS1 DataBar Expanded	X	X	X	X	X	X	X	X	X	X
GS1 DataBar Limited	O	O	O	O	O	O	O	O	O	O
GS1 Datamatrix	O	--	O	O	--	O	O	O	--	O
GS1 QRCode	O	--	O	O	--	O	O	O	--	O
HAN XIN	O	--	O	O	--	O	O	O	--	O
Interleaved 2 of 5	O	O	O	O	O	O	O	O	O	O

Table 8 Supported Decoders (Continued)

Decoders	Camera	Internal Laser Scanner SE965	Internal Imager SE4750-SR & SE4850-ER	Internal Imager SE4770	RS507/RS507X	RS6000	DS2278	DS3678	LI3678	DS8178
Japanese Postal	O	--	O	O	O	O	O	O	--	O
Korean 3 of 5	O	O	O	O	O	O	O	O	O	O
MAIL MARK	X	--	X	X	--	X	X	X	--	X
Matrix 2 of 5	O	O	O	O	O	O	O	O	O	O
Maxicode	X	--	X	X	X	X	X	X	--	X
MicroPDF	O	--	O	O	O	O	O	O	--	O
MicroQR	O	--	O	O	O	O	O	O	--	O
MSI	O	O	O	O	O	O	O	O	O	O
PDF417	X	--	X	X	X	X	X	X	--	X
QR Code	X	--	X	X	X	X	X	X	--	X
Decoder Signature	O	--	O	O	O	O	O	--	--	--
TLC 39	O	O	O	O	O	O	O	O	O	O
Trioptic 39	O	O	O	O	O	O	O	O	O	O
UK Postal	O	--	O	O	O	O	O	O	--	O
UPCA	X	X	X	X	X	X	X	X	X	X
UPCE0	X	X	X	X	X	X	X	X	X	X
UPCE1	O	O	O	O	O	O	O	O	O	O
US4state	O	--	O	O	O	O	O	O	--	O
US4state FICS	O	--	O	O	O	O	O	O	--	O
US Planet	O	--	O	O	O	O	O	O	--	O
US Postnet	O	--	O	O	O	O	O	O	--	O

**Key**

X = Enabled  
O = Disabled  
-- = Not Supported

Touch  to return to the previous screen.

## Decoder Params

Use **Decode Params** to configure individual decoder parameters.



**NOTE:** Not all parameter options are available with all scanners. See the DataWedge app on each device for the available scanners and parameter options.

**NOTE:**

### Codabar

- **CLSI Editing** - Enable this parameter to strip the start and stop characters and insert a space after the first, fifth, and tenth characters of a 14-character Codabar symbol. Enable this feature if the host system requires this data format (default - disabled).
- **Length1** - Use to set decode lengths (default - 6). See Decode Lengths for more information.
- **Length2** - Use to set decode lengths (default - 55). See Decode Lengths for more information.
- **NOTIS Editing** - Enable this parameter to strip the start and stop characters from a decoded Codabar symbol. Enable this feature if the host system requires this data format (default - disabled).
- **Redundancy** - Sets the reader to read the barcode twice before accepting data. A check in the checkbox indicates that redundancy is enabled (default - enabled).

### Code 11

- **Length1** - Use to set decode lengths (default - 4). See Decode Lengths for more information.
- **Length2** - Use to set decode lengths (default - 55). See Decode Lengths for more information.
- **Redundancy** - Sets the reader to read the barcode twice before accepting data. A check in the checkbox indicates that redundancy is enabled (default - enabled).
- **Report Check Digit** - Transmit Code 11 data with or without the check digit. A check in the checkbox indicates to send Code 11 data with check digit (default - disabled).
- **Verify Check Digit** - Check the integrity of all Code 11 symbols to verify that the data complies with the specified check digit algorithm. This selects the check digit mechanism for the decoded Code 11 barcode.
  - **No Check Digit** - Do not verify check digit.
  - **1 Check Digit** - Barcode contains one check digit (default).
  - **2 Check Digits** - Barcode contains two check digits.

### Code128

- **Code128 Reduced Quiet Zone** - Enables decoding of margin-less Code 128 barcodes (default - disabled).
- **Ignore Code128 FNC4** - When enabled, and a Code 128 barcode has an embedded FNC4 character, it will be removed from the data and the following characters will not be changed. When the feature is disabled, the FNC4 character will not be transmitted but the following character will have 128 added to it (default - disabled).
- **Check ISBT Table** - The ISBT specification includes a table that lists several types of ISBT barcodes that are commonly used in pairs. If ISBT128 Concat Mode is set, enable Check ISBT Table to concatenate only those pairs found in this table. Other types of ISBT codes are not concatenated. A check in the checkbox indicates that redundancy is enabled (default - disabled).
- **Enable GS1-128** - Set the GS1 128 subtype. A check in the checkbox indicates that the option is enabled (default - enabled).
- **Enable ISBT128** - Set the ISBT128 subtype. A check in the checkbox indicates that the option is enabled (default - enabled).

- **Enable Plain Code128** - Set the Plain Code128 subtype. Enables other (non-EAN or ISBT) Code 128 subtypes. A check in the checkbox indicates that the option is enabled (default - enabled).
- **ISBT128 Concatenation Mode** - Select an option for concatenating pairs of ISBT code types:
  - **Concat Mode Never** - Do not concatenate pairs of ISBT codes encountered (default).
  - **Concat Mode Always** - There must be two ISBT codes in order to decode and perform concatenation. Does not decode single ISBT symbols.
  - **Concat Mode Auto** - Decodes and concatenates pairs of ISBT codes immediately. If only a single ISBT symbol is present, the device must decode the symbol the number of times set via DataWedge Configuration 4 - 11 Redundancy - Code128 before transmitting its data to confirm that there is no additional ISBT symbol.
- **Length1** - Use to set decode lengths (default - 0). See Decode Lengths for more information.
- **Length2** - Use to set decode lengths (default - 55). See Decode Lengths for more information.
- **Redundancy** - Sets the reader to read the barcode twice before accepting data. A check in the checkbox indicates that redundancy is enabled (default - disabled).
- **Security Level** - The scanner offers four levels of decode security for Code 128 barcodes. Select increasing levels of security for decreasing levels of barcode quality. There is an inverse relationship between security and scanner aggressiveness, so choose only that level of security necessary for any given application.
  - **Security Level 0** - This setting allows the scanner to operate in its most aggressive state, while providing sufficient security in decoding most “in-spec” barcodes.
  - **Security Level 1** - This setting eliminates most misdecodes (default).
  - **Security Level 2** - Select this option if Security level 1 fails to eliminate misdecodes.
  - **Security Level 3** - If Security Level 2 is selected and misdecodes still occur, select this security level. Be advised, selecting this option is an extreme measure against mis-decoding severely out of spec barcodes. Selecting this level of security significantly impairs the decoding ability of the scanner. If this level of security is needed, try to improve the quality of the barcodes.

## Code39

- **Code39 Reduced Quiet Zone** - Enables decoding of margin-less Code 39 barcodes (default - disabled).
- **Convert Code39 To Code32** - Code 32 is a variant of Code 39 used by the Italian pharmaceutical industry. Scan the appropriate barcode below to enable or disable converting Code 39 to Code 32 (default - disabled).
- **Full ASCII**- Code 39 Full ASCII is a variant of Code 39 that pairs characters to encode the full ASCII character set. To enable or disable Code 39 Full ASCII (default - disabled),
- **Length1** - Use to set decode lengths (default - 0). See Decode Lengths for more information.
- **Length2** - Use to set decode lengths 4 (default - 55). See Decode Lengths for more information.
- **Redundancy** - Sets the reader to read the barcode twice before accepting data. A check in the checkbox indicates that redundancy is enabled (default - disabled).
- **Report Check Digit** - Transmit Code 39 data with or without the check digit. A check in the checkbox indicates to send Code 39 data with check digit (default - disabled).
- **Report Code32 Prefix** - Scan the appropriate barcode to enable or disable adding the prefix character “A” to all Code 32 barcodes (default - disabled).

- **Security Level** - Options: **Security level 0**, **Security Level 1**, **Security Level 2** and **Security Level 3** (default - Security level 1).
  - **Security Level 0** - This setting allows the scanner to operate in its most aggressive state, while providing sufficient security in decoding most “in-spec” barcodes.
  - **Security Level 1** - This setting eliminates most misdecodes (default).
  - **Security Level 2** - Select this option if Security level 1 fails to eliminate misdecodes.
  - **Security Level 3** - If Security Level 2 is selected and misdecodes still occur, select this security level. Be advised, selecting this option is an extreme measure against mis-decoding severely out of spec barcodes. Selecting this level of security significantly impairs the decoding ability of the scanner. If this level of security is needed, try to improve the quality of the barcodes.
- **Verify Check Digit** - Enable this feature to check the integrity of all Code 39 symbols to verify that the data complies with a specified check digit algorithm. The digital scanner decodes only those Code 39 symbols that include a modulo 43 check digit. Enable this feature only if the Code 39 symbols contain a modulo 43 check digit (default - disabled).

### Code93

- **Length1** - Use to set decode lengths (default - 0). See Decode Lengths for more information.
- **Length2** - Use to set decode lengths (default - 55). See Decode Lengths for more information.
- **Redundancy** - Sets the reader to read the barcode twice before accepting data. A check in the checkbox indicates that redundancy is enabled (default - disabled).

### Composite AB

- **UCC Link Mode**
  - **Link Flag ignored** - 1D component is transmitted regardless of whether a 2D component is detected.
  - **Always Linked** - 1D and the 2D components are transmitted. If 2D is not present, the 1D component is not transmitted.
  - **Auto Discriminate** - the digital scanner determines if there is a 2D portion, then transmits the 1D component, as well as the 2D portion if present. (default).

### Discrete 2 of 5

- **Length1** - Use to set decode lengths (default - 0). See Decode Lengths for more information.
- **Length2** - Use to set decode lengths (default - 14). See Decode Lengths for more information.
- **Redundancy** - Sets the reader to read the barcode twice before accepting data. A check in the checkbox indicates that redundancy is enabled (default - enabled).

### DotCode

- **Inverse** - Specify the reflectance for decoding DotCode barcodes.
  - **Disabled (0)** - Decode DotCode barcodes with normal reflectance only.
  - **Enabled (1)** - Decode DotCode barcodes with inverse reflectance only.
  - **Auto (2)** - Decodes both normal and inverse reflectance DotCode barcodes. (default - enabled).
- **Mirror** - Specify whether mirrored DotCode barcodes are decoded.
  - **Disabled (0)** - Decode non-mirrored DotCode barcodes only.
  - **Enabled (1)** - Decode mirrored DotCode barcodes only.
  - **Auto (2)** - Decodes both mirrored and non-mirrored DotCode barcodes. (default - enabled).

**GS1 DataBar Limited**

- **GS1 Limited Security Level**

- **GS1 Security Level 1** - This setting allows the scanner to operate in its most aggressive state, while providing sufficient security in decoding most “in-spec” barcodes.
- **GS1 Security Level 2** - This setting eliminates most misdecodes (default).
- **GS1 Security Level 3** - Select this option if Security level 2 fails to eliminate misdecodes.
- **GS1 Security Level 4** - If Security Level 3 is selected and misdecodes still occur, select this security level. Be advised, selecting this option is an extreme measure against mis-decoding severely out of spec barcodes. Selecting this level of security significantly impairs the decoding ability of the scanner. If this level of security is needed, try to improve the quality of the barcodes.

**HAN XIN**

- **HAN XIN Inverse**

- **Disable** - Disables decoding of HAN XIN inverse barcodes (default).
- **Enable** - Enables decoding of HAN XIN inverse barcodes.
- **Auto** - Decodes both HAN XIN regular and inverse barcodes.

**Interleaved 2 of 5**

- **Check Digit**

- **No Check Digit** - A check digit is not used. (default)
- **USS Check Digit** - Select to check the integrity of all Interleaved 2 of 5 symbols to verify the data complies with either the Uniform Symbology Specification (USS) check digit algorithm.
- **OPCC Check Digit** - Select to check the integrity of all Interleaved 2 of 5 symbols to verify the data complies with either the Optical Product Code Council (OPCC) check digit algorithm.
- **Length1** - Use to set decode lengths (default - 14). See Decode Lengths for more information.
- **Length2** - Use to set decode lengths (default - 10). See Decode Lengths for more information.
- **Redundancy** - Sets the reader to read the barcode twice before accepting data. A check in the checkbox indicates that redundancy is enabled (default - enabled).
- **Report Check Digit** - Transmit Interleaved 2 of 5 data with or without the check digit. A check in the checkbox indicates to send Interleaved 2 of 5 data with check digit (default - disabled).
- **I2of5 Security Level** - Options: **I2of5 Security level 0**, **I2of5 Security Level 1**, **I2of5 Security Level 2** and **I2of5 Security Level 3** (default - I2of5 Security level 1).
- **Convert ITF-14 To EAN13** - Convert 14-character Interleaved 2 of 5 barcodes to EAN-13, and transmit as EAN-13. The Interleaved 2 of 5 barcode must be enabled and must have a leading zero and a valid EAN-13 check digit. A check in the checkbox indicates that the option is enabled (default - disabled).
- **I2of5 Reduced Quiet Zone** - Enables decoding of margin-less I2of5 barcodes (default - disabled).

**Matrix 2 of 5**

- **Length1** - Use to set decode lengths (default - 10). See Decode Lengths for more information.
- **Length2** - Use to set decode lengths (default - 0). See Decode Lengths for more information.
- **Redundancy** - Sets the reader to read the barcode twice before accepting data. A check in the checkbox indicates that redundancy is enabled (default - disabled).
- **Report Check Digit** - Transmit Matrix 2 of 5 data with or without the check digit. A check in the checkbox indicates to send Matrix 2 of 5 data with check digit (default - enabled).
- **Verify Check Digit** - Enable this feature to check the integrity of all Matrix 2 of 5 symbols to verify that the data complies with a specified check digit algorithm (default - enabled).

**MSI**

- **Check Digit** - With MSI symbols, one check digit is mandatory and always verified by the reader. The second check digit is optional.
  - **One Check Digit** - Verify one check digit (default).
  - **Two Check Digits** - Verify two check digits.
- **Check Digit Scheme** - Two algorithms are possible for the verification of the second MSI check digit. Select the algorithm used to encode the check digit.
  - **Mod-11-10** - First check digit is MOD 11 and second check digit is MOD 10 (default).
  - **Mod-10-10** - Both check digits are MOD 10.
- **Length 1** - Use to set decode lengths (default - 4). See Decode Lengths for more information.
- **Length 2** - Use to set decode lengths (default - 55). See Decode Lengths for more information.
- **Redundancy** - Sets the reader to read the barcode twice before accepting data. A check in the checkbox indicates that redundancy is enabled (default - enabled).
- **Report Check Digit** - Transmit MSI data with or without the check digit. A check in the checkbox indicates to send MSI data with check digit (default - disabled).

**Trioptic 39**

- **Redundancy** - Sets the reader to read the bar code twice before accepting data. A check in the checkbox indicates that redundancy is enabled (default - disabled).

**UK Postal**

- **Report Check Digit** - Transmit UK Postal data with or without the check digit. A check in the checkbox indicates to send UK Postal data with check digit (default - disabled).

**UPCA**

- **Preamble** - Preamble characters are part of the UPC symbol consisting of Country Code and System Character. Select the appropriate option to match the host system.  
There are three options for transmitting a UPCA preamble:
  - **Preamble None** - Transmit no preamble.
  - **Preamble Sys Char** - Transmit System Character only (default).
  - **Preamble Country and Sys Char** - Transmit System Character and Country Code ("0" for USA). Select the appropriate option to match the host system.
- **Report Check Digit** - The check digit is the last character of the symbol used to verify the integrity of the data. Enables or disables this option. A check in the checkbox indicates that the option is enabled (default - enabled).

**UPCE0**

- **Convert UPCE0 To UPCA** - Enable to convert UPCE0 (zero suppressed) decoded data to UPC-A format before transmission. After conversion, the data follows UPC-A format and is affected by UPC-A programming selections. Disable to transmit UPCE0 decoded data as UPCE0 data, without conversion (default - disabled).



- **Preamble** - Preamble characters are part of the UPC symbol consisting of Country Code and System Character. Select the appropriate option to match the host system.  
There are three options for transmitting a UPCE0 preamble:
  - **Preamble None** - Transmit no preamble (default).
  - **Preamble Sys Char** - Transmit System Character only.
  - **Preamble Country and Sys Char** - Transmit System Character and Country Code (“0” for USA).
- **Report Check Digit** - The check digit is the last character of the symbol used to verify the integrity of the data. Enables or disables this option. A check in the checkbox indicates that the option is enabled (default - disabled).

### UPCE1

- **Convert UPCE1 To UPCA** - Enable this to convert UPCE1 decoded data to UPC-A format before transmission. After conversion, the data follows UPC-A format and is affected by UPC-A programming selections. Disable this to transmit UPCE1 decoded data as UPCE1 data, without conversion (default - disabled).
- **Preamble** - Preamble characters are part of the UPC symbol consisting of Country Code and System Character. Select the appropriate option to match the host system.  
There are three options for transmitting a UPCE1 preamble:
  - **Preamble None** - Transmit no preamble (default).
  - **Preamble Sys Char** - Transmit System Character only.
  - **Preamble Country and Sys Char** - Transmit System Character and Country Code (“0” for USA).
- **Report Check Digit** - The check digit is the last character of the symbol used to verify the integrity of the data. Enables or disables this option. A check in the checkbox indicates that the option is enabled (default - disabled).

### US Planet

- **Report Check Digit** - The check digit is the last character of the symbol used to verify the integrity of the data. Enables or disables this option. A check in the checkbox indicates that the option is enabled (default - disabled).

### Decode Lengths

The allowable decode lengths are specified by options **Length1** and **Length2** as follows:

- Variable length: Decode symbols containing any number of characters.
  - Set both **Length1** and **Length2** to 0.
- Range: Decode a symbol with a specific length range (from *a* to *b*, including *a* and *b*).
  - Set **Length1** to *a* and set **Length2** to *b*.
- Two Discrete Lengths: Decode only symbols containing either of two selected lengths.
  - Set both **Length1** or **Length2** to the specific lengths. **Length1** must be greater than **Length2**.
- One Discrete Length: Decode only symbols containing a specific length.
  - Set both **Length1** and **Length2** to the specific length.

### UPC EAN Params

Allows the configuration of the parameters that apply to more than one UPC or EAN decoder.



**NOTE:** Not all parameter options are available with all scanners. See the DataWedge app on each device for the available scanners and parameter options.

- **Convert DataBar To UPC EAN** - If this is set it converts DataBar barcodes to UPC/EAN format. For this setting to work UPC/EAN symbologies must be enabled. A check in the checkbox indicates that the option is enabled. (default - disabled).
- **UPC Reduced Quiet Zone** - Enables decoding of margin-less UPC barcodes. (default - disabled)
- **Bookland** - Enable Bookland decoding. A check in the checkbox indicates that the option is enabled. (default - disabled).
- **Bookland Format** - If Bookland EAN is enabled, select one of the following formats for Bookland data:
  - **Format ISBN-10** - The decoder reports Bookland data starting with 978 in traditional 10-digit format with the special Bookland check digit for backward-compatibility. Data starting with 979 is not considered Bookland in this mode. (default)
  - **Format ISBN-13** - The decoder reports Bookland data (starting with either 978 or 979) as EAN-13 in 13-digit format to meet the 2007 ISBN-13 protocol.
- **Coupon** - Enables Coupon code decoding. Note that in order to successfully decode Coupon codes, all of the correct decoders must be enabled. A check in the checkbox indicates that the option is enabled. (default - disabled).
- **Coupon Report Mode** - Traditional coupon symbols are composed of two barcode: UPC/EAN and Code 128. A new coupon symbol is composed of a single Data Expanded barcode. The new format offers more options for purchase values (up to \$999.999) and supports complex discount offers as a second purchase requirement. An interim coupon symbol also exists that contain both types of barcodes: UPC/EAN and Databar Expanded. This format accommodates both retailers that do not recognize or use the additional information included in the new coupon symbol, as well as those who can process new coupon symbols.
  - **Old Coupon Report Mode** - Scanning an old coupon symbol reports both UPC and Code 128, scanning an interim coupon symbol reports UPC, and scanning a new coupon symbol reports nothing (no decode).
  - **New Coupon Report Mode** - Scanning an old coupon symbol reports either UPC or Code 128, and scanning an interim coupon symbol or a new coupon symbol reports Databar Expanded.
  - **Both Coupon Report Modes** - Scanning an old coupon symbol reports both UPC and Code 128, and scanning an interim coupon symbol or a new coupon symbol reports Databar Expanded. (default)
- **Ean Zero Extend** – Enable this parameter to add five leading zeros to decoded EAN-8 symbols to make them compatible in format to EAN-13 symbols. Disable this to transmit EAN-8 symbols as is. Default – disabled.
- **Linear Decode** - This option applies to code types containing two adjacent blocks, for example, UPC-A, EAN-8, EAN-13. Enable this parameter to transmit a bar code only when both the left and right blocks are successfully decoded within one laser scan. Enable this option when bar codes are in proximity to each other (default - enabled).
- **Retry Count** - Retry count for auto-discriminating for supplementals. Possible values are 2 to 20 inclusive. Note that this flag is only considered if Supplemental Mode - UPC EAN is set to one of the following values: **Supplementals Auto, Supplementals Smart, Supplementals 378-379, Supplementals 978-979, Supplementals 977** or **Supplementals 414-419-434-439** (2 to 20, default 10).

- **Security Level** - The scanner offers four levels of decode security for UPC/EAN barcodes. Select higher security levels for lower quality barcodes. There is an inverse relationship between security and decode speed, so be sure to choose only that level of security necessary for the application.
  - **Level 0** - This default setting allows the scanner to operate fastest, while providing sufficient security in decoding “in-spec” UPC/EAN barcodes.
  - **Level 1** - As barcode quality levels diminish, certain characters become prone to misdecodes before others (i.e., 1, 2, 7, 8). If the scanner is misdecoding poorly printed barcodes, and the misdecodes are limited to these characters, select this security level. (default).
  - **Level 2** - If the scanner is misdecoding poorly printed barcodes, and the misdecodes are not limited to characters 1, 2, 7, and 8, select this security level.
  - **Level 3** - If the scanner is still misdecoding, select this security level. Be advised, selecting this option is an extreme measure against misdecoding severely out of spec barcodes. Selecting this level of security can significantly impair the decoding ability of the scanner. If this level of security is necessary, try to improve the quality of the barcodes.
- **Supplemental2** - Enables or disables this option. A check in the checkbox indicates that the option is enabled.
- **Supplemental5** - Enables or disables this option. A check in the checkbox indicates that the option is enabled.
- **Supplemental Mode**
  - **No Supplementals** - the scanner is presented with a UPC/EAN plus supplemental symbol, the scanner decodes UPC/EAN and ignores the supplemental characters (default).
  - **Supplemental Always** - the scanner only decodes UPC/EAN symbols with supplemental characters, and ignores symbols without supplementals.
  - **Supplementals Auto** - the scanner decodes UPC/EAN symbols with supplemental characters immediately. If the symbol does not have a supplemental, the scanner must decode the barcode the number of times set via UPC/EAN Supplemental Redundancy before transmitting its data to confirm that there is no supplemental.
  - **Supplemental Smart** - Enables smart supplementals. In this mode the decoder returns the decoded value of the main block right away if it does not belong to one of the following supplemental types: 378, 379, 977, 978, 979, 414, 419, 434 or 439. If the barcode starts with one of the prefixes it searches the image more aggressively for a supplemental. Tries to scan the supplemental if it is present. If the supplemental scanning failed, then the main barcode is returned.
  - **Supplemental 378-379** - Enables (auto-discriminate) supplemental for UPC/EAN codes starting with 378 or 379. Disables reading of supplementals for any other UPC/EAN barcode not starting with 378 or 379. Tries to scan the supplemental if it is present. If the supplemental scanning failed, then the main barcode is returned.
  - **Supplemental 978-979** - Enables (auto-discriminate) supplemental for UPC/EAN codes starting with 978 or 979. Disables reading of supplementals for another UPC/EAN barcode not starting with 978 or 979. Tries to scan the supplemental if it is present. If the supplemental scanning failed, then the main barcode is returned.
  - **Supplemental 414-419-434-439** - Enables (auto-discriminate) supplemental for UPC/EAN codes starting with 414, 419, 434 or 439. Disables reading of supplementals for another UPC/EAN barcode 4 - 16 not starting with 414, 419, 434 or 439. Tries to scan the supplemental if it is present. If the supplemental scanning failed, then the main barcode is returned.
  - **Supplemental 977** - Enables (auto-discriminate) supplemental for UPC/EAN codes starting with 977. Disables reading of supplementals for another UPC/EAN barcode not starting with 977. Tries to scan the supplemental if it is present. If the supplemental scanning failed, then the main barcode is returned.

## Reader Params

Allows the configuration of parameters specific to the selected barcode reader.



**NOTE:** Not all parameter options are available with all scanners. See the DataWedge app on each device for the available scanners and parameter options.

- **Character Set Configuration** - Used to support the GB2312 Chinese characters encoding.
  - **Character Set Selection** - Allows the user to convert the barcode data if different from default encoding type.
    - **Auto Character Set Selection (Best Effort)** - Automatic character convert option. Tries to decode data from the Preferred selection. The first correct decodable character set is used to convert the data and is sent.
    - **ISO-8859-1** - Part of the ISO/IEC 8859 series of ASCII-based standard character encodings. It is generally intended for Western European languages.
    - **Shift\_JIS** - Shift Japanese Industrial Standards (JIS) is a character encoding for the Japanese language.
    - **GB18030** - Chinese coded character set that defines the required language and character support necessary for software in China.
    - **UTF-8** - A character encoding capable of encoding all possible characters, or code points, defined by Unicode (default).
  - **Auto Character Set Preferred Order** - In **Auto Character Set Selection** mode, the system will try to decode the data in a preference order of character sets. The algorithm used is a best effort one. That is, there could be cases where the data can be decoded from more than one character set. The first character set from the preferred list which can decode the data successfully will be chosen to decode the data and sent to the user. Any other character set that is in the list but lower in the preferred order, would not be considered, even if the data could be successfully decoded using such character set.
 

The preferred character set and its preference order is configurable to the user through the **Auto Character Set Preferred Order** menu. Users can change the order by dragging the icon for that menu item. To delete an item, long press on an item and the **Delete** option will appear. To add a new item, tap the menu icon at top right corner and options to add UTF-8 and GB2312 will appear.

    - **UTF-8** - A character encoding capable of encoding all possible characters, or code points, defined by Unicode (default).
    - **GB2312** - Character set of the People's Republic of China, used for simplified Chinese characters.
  - **Auto Character Set Failure Option** - If the system cannot find a character set from the preferred list that can be used to successfully decode the data, the character set selected in **Auto Character Set Failure Option** is used to decode the data and send to the user. If **NONE** is used, Null data is returned as string data.
    - **NONE**
    - **UTF-8** - A character encoding capable of encoding all possible characters, or code points, defined by Unicode (default).
    - **ISO-8859-1** - Part of the ISO/IEC 8859 series of ASCII-based standard character encodings. It is generally intended for Western European languages.
    - **Shift\_JIS** - Shift Japanese Industrial Standards (JIS) is a character encoding for the Japanese language.
    - **GB18030** - Chinese coded character set that defines the required language and character support necessary for software in China.
  - **1D Quiet Zone Level** - Sets the level of aggressiveness in decoding barcodes with a reduced quiet zone (the area in front of and at the end of a barcode), and applies to symbologies enabled by a Reduced Quiet Zone parameter. Because higher levels increase the decoding time and risk of misdecodes, Zebra strongly

recommends enabling only the symbologies which require higher quiet zone levels, and leaving Reduced Quiet Zone disabled for all other symbologies.

Options are:

- **0** - The scanner performs normally in terms of quiet zone.
- **1** - The scanner performs more aggressively in terms of quiet zone (default).
- **2** - The scanner only requires one side EB (end of barcode) for decoding.
- **3** - The scanner decodes anything in terms of quiet zone or end of barcode.
- **Adaptive Scanning** - When adaptive scanning is enabled, the scan engine toggles between wide and narrow, allowing the scan engine to decode barcodes based on the distance.
  - **Disable**
  - **Enable** (default).
- **Beam Width** - Beam Width is applicable only with linear scanners.
  - **Narrow**
  - **Normal** (default)
  - **Wide**
- **Aim mode** - Turns the scanner cross-hairs on or off.
  - **On** - Cross-hair is on (default).
  - **Off** - Cross-hair is off.
- **Aim Timer** - Sets the maximum amount of time that aiming remains on (0 - 60,000 ms in increments of 100 ms). A value of 0 sets the aim to stay on indefinitely (default - 500).
- **Aim Type** - Set the aiming usage.
  - **Trigger** - A trigger event activates decode processing, which continues until the trigger event ends or a valid decode occurs (default).
  - **Timed Hold** - A trigger pull and hold activates the laser for aiming, which continues until the trigger is released, a valid decode, or the decode session time-out is expired.
  - **Timed Release** - A trigger pull activates the laser for aiming, which continues until a valid decode or the remaining decode session time has expired.
  - **Press and Release** - A trigger pull and release activates the laser for aiming, which continues until a trigger is pressed again, a valid decode, or the decode session time-out is expired.
  - **Presentation** - Automatically activates the scanner and starts scanning immediately when a barcode is presented in its field of view, without any trigger press. (Only supported on SE4750SR.)
  - **Continuous Read** - A trigger pull activates a decode session which continues until the Beam Timer expires or the trigger is released. Barcodes are continuously decoded while the session is active.
  - **Press and Sustain** - A trigger pull activates decode processing which continues until the Beam Timer expires or a barcode is decoded.
- **Beam Timer** - Sets the maximum amount of time that the reader remains on (0 - 60,000 ms in increments of 100 ms). A value of 0 sets the reader to stay on indefinitely (default -5000).
- **Time Delay to Low Power** - Sets the time the decoder remains active after decoding. After a scan session, the decoder waits this amount of time before entering Low Power Mode. Options: **1 Second** (default), **30 Seconds**, **1 Minute** or **5 Minutes**.
- **Different Symbol Timeout** - Controls the time the scanner is inactive between decoding different symbols. Programmable in 500 msec increments from 0 to 5 seconds. The default is 500 msec.

- **DPM External Illumination** - Controls illumination for DPM barcodes.
  - **Direct** - Scanner uses only direct (white) illumination. Recommended for use with dot peen barcodes - tilt the part 30 degrees for optimal decoding.
  - **Indirect** - Scanner uses only red illumination. Recommended for use with laser etched barcodes on cylinders or curved, rough, grainy, highly reflective, or visibly machined surfaces.
  - **Cycle** (default)- Scanner cycles alternately between direct and indirect illumination. The scanner starts with the illumination used during the last successful decode.
- **DPM Mode** - Mode to optimize DPM barcode decoding performance based on barcode size (Default value is Mode 2).
  - **Disabled** - No special processing.
  - **Mode 1**- Optimizes decoding performance for smaller DPM barcodes, typically found on electronics and medical instruments, especially on smooth surfaces. These barcodes tend to be laser etched or direct printed.
  - **Mode 2** (default) - Optimizes decoding performance for larger DPM barcodes, typically found on industrial parts, especially on rough, grainy or visibly machined surface. These barcodes tend to be dot peen or laser etched.
- **Digimarc Decoding** - Enables/disables support for Digimarc, which encodes and invisibly integrates traditional barcode data onto product packaging. Supported with internal imager only. (default - Enabled).
- **Illumination Brightness** - Sets the brightness of the illumination by altering LED power. The default is 10, which is maximum LED brightness. For values from 1 to 10, LED brightness varies from lowest to highest level of brightness.
- **Illumination mode** - Turns imager illumination on and off. This option is only available when **Bluetooth Scanner** is selected in the **Barcode input, Scanner selection** option.
  - **Off** - Illumination is off.
  - **On** - Illumination is on (default).
- **Inverse 1D Mode** - This parameter allows the user to select decoding on inverse 1D barcodes.
  - **Disable** - Disables decoding of inverse 1D barcodes (default).
  - **Enable** - Enables decoding of only inverse 1D barcodes.
  - **Auto** - Allows decoding of both twice positive and inverse 1D barcodes.
- **Keep Pairing Info After Reboot**
  - **Disable** - Disables the ability to keep pairing info after reboot.
  - **Enable** - Enables the ability to keep pairing info after reboot. (default).
- **LCD Mode** - Enables or disables LCD mode. LCD mode enhances the ability of the imager to read barcodes from LCD displays such as cellphones.
  - **Disable** - Disables the LCD mode (default).
  - **Enable** - Enables LCD mode.
- **Linear Security Level** - Sets the number of times a barcode is read to confirm an accurate decode.
  - **Security Short or Codabar** - Two times read redundancy if short barcode or Codabar (default).
  - **Security All Twice** - Two times read redundancy for all barcodes.
  - **Security Long and Short** - Two times read redundancy for long barcodes, three times for short barcodes.
  - **Security All Thrice** - Three times read redundancy for all barcodes.
- **HW Engine Low Power Timeout** - Time (0 - 1,000 ms in increments of 50 ms) of inactivity before scanner enters low-power mode from (default - 250).



- **Picklist** - Allows the imager to decode only the barcode that is directly under the cross-hair/reticle (+) part of the pattern. This feature is useful in applications where multiple barcodes may appear in the field of view during a decode session and only one of them is targeted for decode.
  - **Disabled** – Disables Picklist mode. Any barcode within the field of view can be decoded (default).
  - **Enabled** – Enables Picklist mode so that only the barcode under the projected reticle can be decoded.
- **Poor Quality Decode Effort** - Enable poor quality barcode decoding enhancement feature.
- **Same Symbol Timeout** - Controls the time the scanner is inactive between decoding same symbols. Programmable in 500 msec increments from 0 to 5 seconds. The default is 500 msec.
- **Scanning Modes** - Scanning options available on the device.
  - **Single** - Set to scan general barcodes (default).
  - **UDI** - Set to scan healthcare specific barcodes.
  - **MultiBarcode** - Set to scan multiple barcodes. When this option is selected, the **Multibarcodes params** can be set to read from 2 to 10 barcodes on a single scan.

## Scan Params

Allows the configuration of Code ID and decode feedback options.



**NOTE:** Not all parameter options are available with all scanners. See the DataWedge app on each device for the available scanners and parameter options.

- **Code ID Type** - A Code ID character identifies the code type of a scanned barcode. This is useful when the reader is decoding more than one code type. Select a code ID character to insert between the prefix and the decoded symbol.
  - **Code ID Type None** - No prefix (default)
  - **Code ID Type AIM** - Insert AIM Character prefix.
  - **Code ID Type Symbol** - Insert Symbol character prefix.
- **Engine Decode LED** - Use to turn on scanner red LED when the scan beam is emitting either by scanner trigger or using soft scan button.
- **BT Disconnect On Exit** - Bluetooth connection is disconnected when data capture application is closed .
- **Connection Idle Time** - Set connection idle time. The Bluetooth connection disconnects after being idle for set time.
- **Display BT Address Barcode** - Enable or disable displaying Bluetooth Address bar code if there is no Bluetooth scanner being paired when application tries to enable the Bluetooth scanner.
- **Establish Connection Time** - The timeout which the device will try to enable or reconnect to the Bluetooth scanner when the Bluetooth scanner is not in the vicinity or not paired.
- **Audio Feedback Mode** - Select good decode audio indication.
  - **Local Audio Feedback** - Good decode audio indication on device only.
  - **Remote Audio Feedback** - Good decode audio indication.
  - **Both** - Good decode audio indication on device and scanner (default).
  - **Disable** - No good decode audio indication on either device or scanner.
- **LED Feedback Mode** - Select good decode LED indication.
  - **Local LED Feedback** - Good decode LED indication on device only.
  - **Remote LED Feedback** - Good decode LED indication on scanner.
  - **Both** - Good decode LED indication on device and scanner (default).
  - **Disable** - No good decode LED indication on either device or scanner.
- **Decode Audio Feedback** - Select an audio tone to sound upon a good decode (default optimized-beep).

- **Decoding LED Notification** - Enable the device to light the red Data Capture LED when data capture is in progress. (default - disabled).
- **Decode Feedback LED Timer** - Set the amount of time (in milliseconds) that the green Data Capture LED stays lit after a good decode. (default - 75 msec.)
- **Beep Volume Control** - Set the good decode beep to a system or other sound. This allows for independent control of the good beep volume.



**NOTE:** Not all ringtones are fully supported as decode tones and those of longer length may be truncated when used as a decode tone. The recommendation is to test the selected tone for operation before deployment to a customer site.

- **Ringer** - Uses Ringer audio stream to play the decode beep.
- **Music and Media** - Uses Media audio stream to play the decode beep.
- **Alarms** - Uses Alarms audio stream to play the decode beep.
- **Notifications** - Uses Notifications audio stream to play the decode beep. (default)

## UDI Params

Allows the configuration of parameters specific to healthcare barcodes.

- **Enable UDI-GSI** - Enable UDI using GS1 standards (default - enabled).
- **Enable UDI-HIBCC** - Enable UDI using HIBCC standards (default - enabled).
- **Enable UDI-ICCBBA** - Enable UDI using ICCBBA standards (default - enabled).

## Multibarcodes params

Set the number of barcodes that the device can read on a single scan from 2 to 10. Must also enable **Reader Params > Scanning Modes > MultiBarcode** option.

## Keep enabled on suspend

Keep Bluetooth scanner enabled after suspend (default-disabled).

## Voice Input

Zebra GMS devices have a built in Google speech recognition engine. By making use of the speech engine capabilities, DataWedge has extended automated data capturing to user applications through voice. Currently, DataWedge does not capture data for Voice Input.

Voice data capturing starts after you speak the predefined start phrase and it stops after you speak the data or speak the end phrase, if one was defined.



### IMPORTANT:

- Simultaneous use of Voice Input in DataWedge and Google Voice is not supported.
- Voice Input is not supported if the Enterprise Home Screen (EHS) is in restricted mode. However, enabling all of the privilege settings in EHS reinstates Voice Input.
- Voice Input is not supported if the device language is changed to another language, for example Chinese.

Use **Voice Input** to configure the Voice Input Plug-in.

- **Enabled** - Enables or disables this plug-in. A check in the checkbox indicates that the plug-in is enabled.



- **Data capture start phrase** - Starts data capture with the phrase entered in this field. This field is mandatory. (Default - **start**).  
Providing numbers and other special characters as the data capture start phrase is not supported.
- **Data capture end phrase** - Ends data capture with the phrase entered in this field or keep it blank if not required. This field is not mandatory. (Default - Blank).
- **Tab command** - Enables the Tab command, which sends a tab key when the user speaks the command **send tab**. The commands are supported only when the device is at the **waiting for start phrase** state.
- **Enter command** - Enables the Enter command, which sends an enter key when the user speaks the command **send enter**. The commands are supported only when the device is at the **waiting for start phrase** state.
- **Data type** - Allows the user to configure the data type. Set the data type to limit the data capture according to the preferences specified. Available options:
  - **Any** - Scanning a barcode of ABC123, returns ABC123.
  - **Alpha** - Scanning a barcode of ABC123, returns ABC only.
  - **Numeric** - Scanning a barcode of ABC, returns 123 only.
- **Start phrase waiting tone** - Enables or disables this option. Enables audio feedback for **waiting for start**. This option notifies the user that the device is waiting to start the speech engine if you miss the toast message and the **waiting for start** state changes.
- **Data capture waiting tone** - Enables or disables this option. Enables audio feedback for **waiting for data**. This option notifies the user that the device is waiting to capture data if you miss the toast message.
- **Validation window** - Enables or disables the **Validate captured data** window. Enable this option to validate the result that you speak. The window displays the data spoken and the data can be edited on the same screen if any modification is needed. This is very useful when used with the offline mode, since the results receive at this moment might not be accurate.
- **Offline speech recognition** - Enables or disables speech recognition. Enable this option to use Voice Input when you do not have access to the Internet. This option uses an offline recognition speech engine to detect the data you speak.

## Keystroke Output

DataWedge supports Keystroke Output.

Use to configure the Keystroke Output Plug-in for the profile.

- **Enabled** — Enables or disables this plug-in. A check in the checkbox indicates that the plug-in is enabled (default - enabled).
- **Action key character** - Enables decoding of a special character embedded within a barcode data for use in native Android applications. This feature is helpful when populating or executing a form.
  - **None** - Action key character feature is disabled (default).
  - **Tab** - Tab character code in a barcode is processed. When DataWedge detects this character code in a barcode, move the focus to the next field.
  - **Line feed** - Line feed character code in a barcode is processed. When DataWedge detects this character code in a barcode, move the focus to the next field.
  - **Carriage return** - Carriage return character code in a barcode is processed. When DataWedge detects this character code in a barcode, move the focus to the next field.
- **Inter character delay** - Set the delay between keystrokes (in milliseconds).
- **Delay Multibyte characters only** - If Inter character delay is set, enable Delay Multibyte characters only to delay only the multibyte characters.

- **Key event delay** - Set the amount of time (in milliseconds) of the wait time for control characters. (default - 0.)
- **Data formatting and ordering** - Allows formatting and ordering of UDI and Multibarcodes data.
  - **UDI specific** - Allows the output order of acquired UDI data to be adjusted and the optional insertion of a tab, line feed, or carriage return character between tokens.
    - **Send tokens** - Set to select the output format for UDI data. (default - disabled)
    - **Token separator** - Set to select a separator character. If no separator character is selected when Send tokens is set to Barcodes and tokens, two instances of the same data are sent. (default - none)
    - **Token order** - Set to include or exclude Tokens from the output and adjust their output order.
  - **Multibarcodes specific** - Allows the optional insertion of a tab, line feed, or carriage return between each barcode.
    - **Barcode separator** - Set to select a separator character. If no separator character is selected, the data set is sent as a single string.
- **Advanced data formatting** - is a way to customizing data before transmission. Use advanced data formatting (ADF) to edit scan data to suit requirements.
  - **Enable** - Enables or disables ADF. A check in the checkbox indicates that ADF is enabled (default - disabled).
  - **Rules** - ADF uses rules to customize data. These rules perform detailed actions when the data meets certain criteria. One rule may consist of single or multiple criteria applied to single or multiple actions. See Generating Advanced Data Formatting Rules for more information.
- **Basic data formatting** - Allows the configuration of any data formatting for the related Output Plug-in. When the plug-in is disabled, any data is passed on without modification.
  - **Enabled** - Enables or disables Basic Data Formatting. A check in the checkbox indicates that it is enabled (default - enabled).
  - **Prefix to data** - Add characters to the beginning of the data when sent.
  - **Suffix to data** - Add characters to the end of the data when sent.
  - **Send data** - Set to transfer the captured data to the foreground application. Disabling this option prevents the actual data from being transmitted. However, the prefix and suffix strings, if present, are still transmitted even when this option is disabled (default - enabled).
  - **Send as hex** - Set to send the data in hexadecimal format. A check in the checkbox indicates that the plug-in is enabled (default - disabled).
  - **Send TAB key** - Set to append a tab character to the end of the processed data. A check in the checkbox indicates that the plug-in is enabled (default - disabled).
  - **Send ENTER key** - Set to append an Enter character to the end of the processed data. A check in the checkbox indicates that the plug-in is enabled (default - disabled).

## Intent Output

Allows configuration of the Intent Output Plug-in for the profile. The Intent Output Plug-in allows the captured data to be sent to an application in the form of an implicit Intent. Refer to the Android Developer web site for more information, [developer.android.com](http://developer.android.com).

- **Enabled** - Enables or disables this plug-in. A check in the checkbox indicates that the plug-in is enabled (default - disabled).
- **Intent action** - Enter the Intent Action name (required).
- **Intent category** - Enter the Intent Category name (required).

- **Intent delivery** - Select the method by which the intent is delivered:
  - Send via StartActivity
  - Send via startService (default)
  - Broadcast intent
- **Receiver foreground flag** - Set Broadcast intent flag in Intent delivery. (DS3678).
- **Advanced data formatting** - is a way to customizing data before transmission. Use advanced data formatting (ADF) to edit scan data to suit requirements.
  - **Enable** - Enables or disables ADF. A check in the checkbox indicates that ADF is enabled (default - disabled).
  - **Rules** - ADF uses rules to customize data. These rules perform detailed actions when the data meets certain criteria. One rule may consist of single or multiple criteria applied to single or multiple actions. See Generating Advanced Data Formatting Rules for more information.
- **Basic data formatting** - Allows configuration of any data formatting for the related Output Plug-in. When the plug-in is disabled any data is passed on without modification.
  - **Enabled** - Enables or disables Basic Data Formatting. A check in the checkbox indicates that it is enabled (default - enabled).
  - **Prefix to data** - Add characters to the beginning of the data when sent.
  - **Suffix to data** - Add characters to the end of the data when sent.
  - **Send data** - Set to transfer the captured data to the foreground application. Disabling this option prevents the actual data from being transmitted. However, the prefix and suffix strings, if present, are still transmitted even when this option is disabled (default - enabled).
  - **Send as hex** - Set to send the data in hexadecimal format. A check in the checkbox indicates that the plug-in is enabled (default - disabled).
  - **Send TAB key** - Set to append a tab character to the end of the processed data. A check in the checkbox indicates that the plug-in is enabled (default - disabled).
  - **Send ENTER key** - Set to append an Enter character to the end of the processed data. A check in the checkbox indicates that the plug-in is enabled (default - disabled).

## Intent Overview

The core components of an Android application (its activities, services, and broadcast receivers) are activated by intents. An intent is a bundle of information (an Intent object) describing a desired action - including the data to be acted upon, the category of component that should perform the action, and other pertinent instructions. Android locates an appropriate component to respond to the intent, launches a new instance of the component if one is needed, and passes it the Intent object.

Components advertise their capabilities, the kinds of intents they can respond to, through intent filters. Since the system must learn which intents a component can handle before it launches the component, intent filters are specified in the manifest as <intent-filter>elements. A component may have any number of filters, each one describing a different capability. For example, if the manifest contains the following:

```
<intent-filter . . . >
<action android:name="android.intent.action.DEFAULT" />
<category android:name="android.intent.category.MAIN" />
</intent-filter>
```

In the Intent output plug-in configuration, the **Intent action** would be:

```
android.intent.action.DEFAULT
and the Intent category would be:
android.intent.category.MAIN.
```

The **Intent delivery** option allows the method by which the intent is delivered to be specified. The delivery mechanisms are **Send via startActivity**, **Send via startService** or **Broadcast intent**.

The decode related data added to the Intent's bundle can be retrieved using the `Intent.getStringExtra()` and `Intent.getSerializableExtra()` calls, using the following String tags:

- String LABEL\_TYPE\_TAG = "com.symbol.emdk.datawedge.label\_type";
  - String contains the label type of the barcode.
- String DATA\_STRING\_TAG = "com.symbol.datawedge.data\_string";
  - String contains the output data as a String. In the case of concatenated barcodes, the decode data is concatenated and sent out as a single string.
- String DECODE\_DATA\_TAG = "com.symbol.datawedge.decode\_data";
  - Decode data is returned as a list of byte arrays. In most cases there will be one byte array per decode. For barcode symbologies that support concatenation, for example, Codabar, Code128, MicroPDF, etc., the decoded data is stored in multiple byte arrays (one byte array per barcode). Clients can get data in each byte array by passing an index.

Most scanning applications might want the user to be able to decode data and for that decode data to be sent to the **\*current\*** activity but not necessarily displayed. If this is the case, then the activity needs to be marked as 'singleTop' in its AndroidManifest.xml file. If your activity is not defined as singleTop, then on every decode, the system will create another copy of your Activity and send the decode data to this second copy.

Finally there will be a configuration option for each process plug-in so that the process plug-in can be configured specifically for the intent output, which in this case is the basic data formatting process plug-in.

## IP Output



**NOTE:** IPWedge application is required on a host computer. Download the IPWedge application from the Support Central web site: [www.zebra.com/support](http://www.zebra.com/support).

IP Output allows DataWedge to send captured data to a host computer via a network connection. Captured data can be sent over an IP network to a specified IP address and port using either TCP or UDP transport protocols.

- **Enabled** - Enables or disables this plug-in. A check in the checkbox indicates that the plug-in is enabled (default - disabled).
- **Remote Wedge** - Enable or disable the Remote Wedge option (default - enabled). Remote Wedge is used with the IPWedge application.
- **Protocol** - Select the protocol used by the remote application. Options: **TCP** (default) or **UDP**.
- **IP address** - Enter the IP address used by the remote application (default - 0.0.0.0).
- **Port** - Enter the port number used by the remote application (default - 58627).
- **Data formatting and ordering** - Allows formatting and ordering of UDI and Multibarcodes data.
  - **UDI specific** - Allows the output order of acquired UDI data to be adjusted and the optional insertion of a tab, line feed, or carriage return character between tokens.
    - **Send tokens** - Set to select the output format for UDI data. (default - disabled)

- **Token separator** - Set to select a separator character. If no separator character is selected when Send tokens is set to Barcodes and tokens, two instances of the same data are sent. (default - none)
- **Token order** - Set to include or exclude Tokens from the output and adjust their output order.
- **Advanced data formatting** - is a way of customizing data before transmission. Use advanced data formatting (ADF) to edit scan data to suit requirements.
  - **Enable** - Enables or disables ADF. A check in the checkbox indicates that ADF is enabled (default - disabled).
  - **Rules** - ADF uses rules to customize data. These rules perform detailed actions when the data meets certain criteria. One rule may consist of single or multiple criteria applied to single or multiple actions. See Generating Advanced Data Formatting Rules for more information.
- **Basic data formatting** - Allows configuration of any data formatting for the related Output Plug-in. When the plug-in is disabled any data is passed on without modification.
  - **Enabled** - Enables or disables Basic Data Formatting. A check in the checkbox indicates that it is enabled (default - enabled).
  - **Prefix to data** - Add characters to the beginning of the data when sent.
  - **Suffix to data** - Add characters to the end of the data when sent.
  - **Send data** - Set to transfer the captured data to the foreground application. Disabling this option prevents the actual data from being transmitted. However, the prefix and suffix strings, if present, are still transmitted even when this option is disabled (default - enabled).
  - **Send as hex** - Set to send the data in hexadecimal format. A check in the checkbox indicates that the plug-in is enabled (default - disabled).
  - **Send TAB key** - Set to append a tab character to the end of the processed data. A check in the checkbox indicates that the plug-in is enabled (default - disabled).
  - **Send ENTER key** - Set to append an Enter character to the end of the processed data. A check in the checkbox indicates that the plug-in is enabled (default - disabled).

## Usage

This section provides information on how to configure IP Output using the DataWedge configuration user interface. To use IP Output in a particular DataWedge profile (for example: **Profile0**), scroll downward on **IP Output**.

Figure 97 IP Output Screen

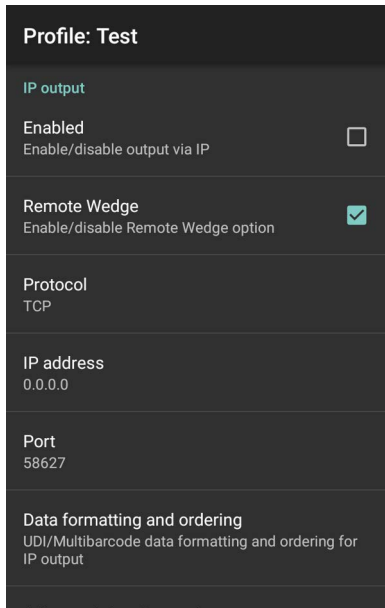

## Using IP Output with IPWedge

IPWedge is a computer application that can be easily configured to retrieve data sent over network by DataWedge IP Output. Refer to the IPWedge User Manual on how to install and configure in a host computer. To enable IP Output to send captured data to a remote computer that is installed with IPWedge:

1. In **IP Output**, touch **Enabled**.  
A check appears in the checkbox.
2. Ensure **Remote Wedge** option is enabled.
3. Touch **Protocol**.
4. In the **Choose protocol** dialog box, touch the same protocol selected for the IPWedge computer application. (TCP is the default).

Figure 98 Protocol Selection

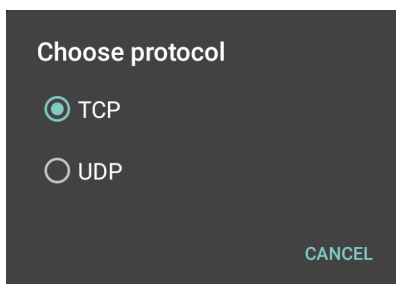

5. Touch **IP Address**.
6. In the **Enter IP Address** dialog box, enter the IP address of host computer to send data to.

Figure 99 IP Address Entry

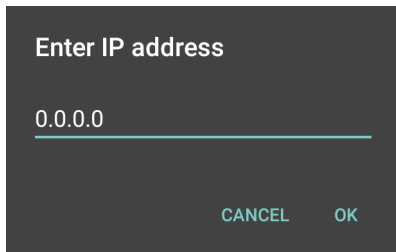

7. Touch **Port**.

8. In the **Enter port number** dialog box, enter same port number selected for IPWedge computer application.

Figure 100 Port Number Entry

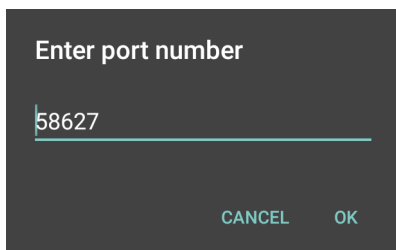

9. Configure **Advanced data formatting** and **Basic data formatting** Plug-in if any required modification to be done to captured data before sending to remote computer.

## Using IP Output without IPWedge

IP Output Plug-in can be used to send captured data from DataWedge to a remote device or host computer without using IPWedge. At the data receiving end, the host computer or mobile device should have an application, that listens to TCP or UDP data coming from a configured port and IP address in the IP Output plug-in. To enable IP Output to send captured data to a remote computer:

1. In **IP Output**, touch **Enabled**.  
A check appears in the checkbox.
2. Ensure **Remote Wedge** option is disabled.
3. Touch **Protocol**.
4. In the **Choose protocol** dialog box, touch the same protocol selected in the client application. (TCP is the default).

Figure 101 Protocol Selection

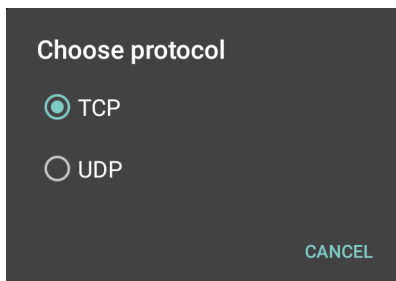

5. Touch **IP Address**.

- In the **Enter IP address** dialog box, enter the IP address of host computer to send data to.

Figure 102 IP Address Entry

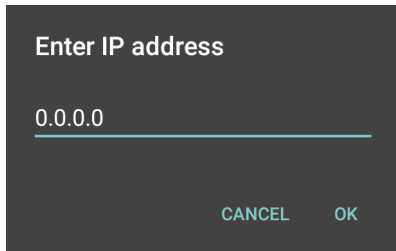

- Touch **Port**.
- In the **Enter port number** dialog box, enter the port number that the host computer application is listening on.

Figure 103 Port Number Entry

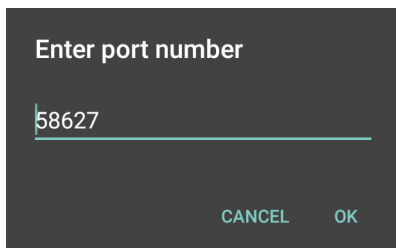

- Configure **Advanced Data Formatting** and **Basic Data Formatting** Plug-in if any required modification to be done to captured data before sending to remote computer.

## Generating Advanced Data Formatting Rules

The ADF plug-in applies rules (actions to be performed based on defined criteria) to the data received via an input plug-in before sending it to the output plug-in.

- Rules** - The ADF process plug-in consists of one or more rules. DataWedge formats the output data according to the first matching rule. A rule is a combination of criteria and a set of actions to be performed, upon fulfillment of the criteria set in the rule.
- Criteria** - Criteria can be set according to Input plug-in, symbology, matching string within the data (at the specified position) and/or data length. Received data must match the defined criteria in order for the data to be processed.
- Actions** - A set of procedures defined to format data. There are four types of actions which are for formatting cursor movement, data modification, data sending and delay specifications. An action can be defined to send the first number of characters to the Output plug-in, pad the output data with spaces or zeros, remove spaces in data, etc.

## Configuring ADF Plug-in

Configuring the ADF plug-in consists of creating a rule, defining the criteria and defining the actions.

- Swipe up from the bottom of the screen and touch .
- Touch a DataWedge profile.



3. In **Keystroke Output**, touch **Advanced data formatting**.

Figure 104 Advanced Data Formatting Screen

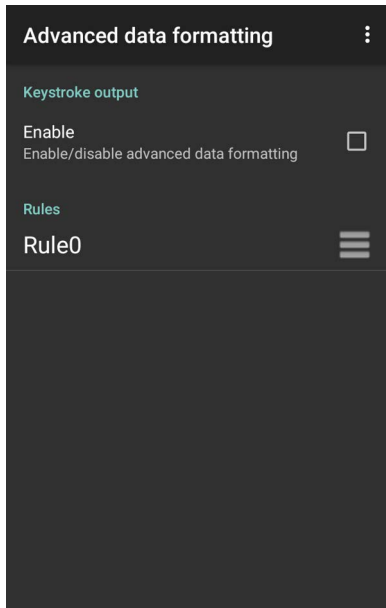

4. Touch the **Enable** checkbox to enable ADF.

## Creating a Rule



**NOTE:** By default, **Rule0**, is the only rule in the Rules list.

1. Touch **⋮**.
2. Touch **New rule**.
3. Touch the **Enter rule name** text box.
4. In the text box, enter a name for the new rule.
5. Touch **OK**.

## Defining a Rule

1. Touch the newly created rule in the **Rules** list.

Figure 105 Rule List Screen

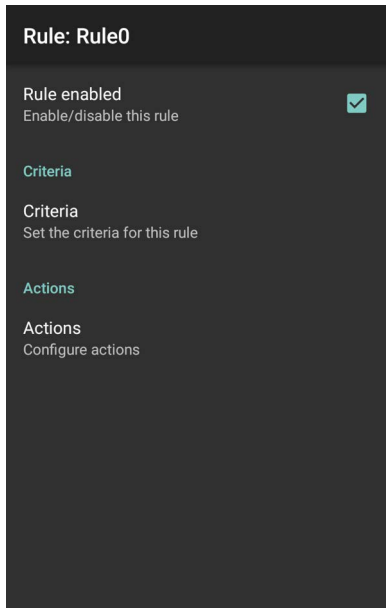

2. Touch the **Rule enabled** check box to enable the current rule.

## Defining Criteria

1. Touch **Criteria**.

Figure 106 Criteria Screen

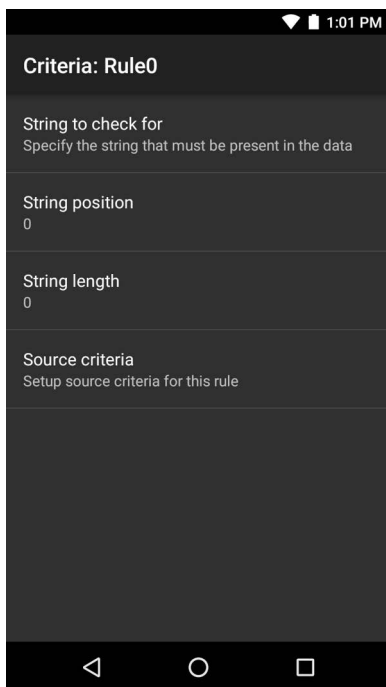

2. Touch **String to check for** option to specify the string that must be present in the data.
3. In the **Enter the string to check for** dialog box, enter the string
4. Touch **OK**.

5. Touch **String position** option to specify the position of the string specified in the **String to check for** option. The ADF rule is only applied if the specific string in **String to check for** is found at the specified **String position** location (zero for the start of the string).
6. Touch the **+** or **-** to change the value.
7. Touch **OK**.
8. Touch **String length option** to specify a length for the received data. The ADF rule only applies to the barcode data with that specified length.
9. Touch the **+** or **-** to change the value.
10. Touch **OK**.
11. Touch **Source criteria** option to associate an input device to an ADF rule. The ADF rule only applies to data received from associated input devices.
12. Touch **Barcode input**. Options vary depending upon the device configuration.
13. Touch the **Source enabled** checkbox to accept data from this source.

Figure 107 Barcode Input Screen

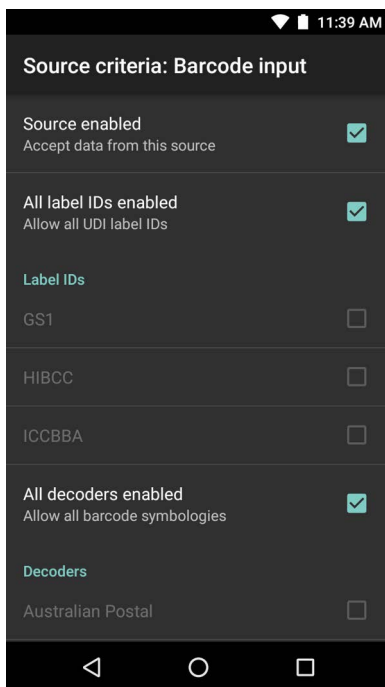



14. For general barcode inputs, touch the **All decoders enabled** checkbox to select all bar code symbologies. Deselect the **All decoders enabled** checkbox to individually select the symbologies.
15. Touch **<** until the **Rule** screen appears.
16. If required, repeat steps to create another rule.
17. Touch **<** until the Rule screen appears.

## Defining an Action



**NOTE:** By default the **Send remaining** action is in the **Actions** list.

1. Touch .
2. Touch **New action**.
3. In the **New action** menu, select an action to add to the **Actions** list. See the ADF Supported Actions table for a list of supported ADF actions.
4. Some Actions require additional information. Touch the Action to display additional information fields.
5. Repeat steps to create more actions.
6. Touch .
7. Touch .

## Deleting a Rule

1. Touch and hold on a rule until the context menu appears.
2. Touch **Delete rule** to delete the rule from the **Rules** list.



**NOTE:** When there is no rule available for ADF plug-in or all rules are disabled, DataWedge passes decoded data to the output plug-in without processing the data.

## Order Rules List



**NOTE:** When there are no rules defined, ADF passes the captured data through as is. In contrast, when rules are defined but all are disabled, ADF does not pass any captured data through.

Rules are processed in top-down order. The rules that are on top of the list are processed first. Use the icon next to the rule to move it to another position in the list.

Table 9 ADF Supported Actions

Type	Actions	Description
Cursor Movement	Skip ahead	Moves the cursor forward by a specified number of characters. Enter the number of characters to move the cursor ahead.
	Skip back	Moves the cursor back by a specified number of characters. Enter the number of characters to move the cursor back.
	Skip to start	Moves the cursor to the beginning of the data.
	Move to	Moves the cursor forward until the specified string is found. Enter the string in the data field.
	Move past a	Moves the cursor forward past the specified string. Enter the string in the data field.

Table 9 ADF Supported Actions (Continued)

Type	Actions	Description
Data Modification	Crunch spaces	Remove spaces between words to one and remove all spaces at the beginning and end of the data.
	Stop space crunch	Stops space crunching. This disables the last <b>Crunch spaces</b> action.
	Remove all spaces	Remove all spaces in the data.
	Stop space removal	Stop removing spaces. This disables the last <b>Remove all spaces</b> action.
	Remove leading zeros	Remove all zeros at the beginning of data.
	Stop zero removal	Stop removing zeros at the beginning of data. This disables the previous <b>Remove leading zeros</b> action.
	Pad with zeros	Left pad data with zeros to meet the specified length. Enter the number zeros to pad.
	Stop pad zeros	Stop padding with zeros. This disables the previous <b>Pad with zeros</b> action.
	Pad with spaces	Left pad data with spaces to meet the specified length. Enter the number spaces to pad.
	Stop pad spaces	Stop padding with spaces. This disables the previous <b>Pad with spaces</b> action.
	Replace string	Replaces a specified string with a new string. Enter the string to replace and the string to replace it with.
	Stop all replace string	Stop all <b>Replace string</b> actions.
	Data Sending	Send next
Send remaining		Sends all data that remains from the current cursor position.
Send up to		Sends all data up to a specified string. Enter the string.
Send pause		Pauses the specified number of milliseconds before continuing the next action. Enter the amount of time in milliseconds.
Send string		Sends a specified string. Enter the string to send.
Send char		Sends a specified ASCII/ Unicode character. Enter a character value. The maximum Unicode character value can be entered is U-10FFFF (= 1114111 in decimal).

## Deleting an Action

1. Touch and hold the action name.
2. Select **Delete action** from the context menu.

## ADF Example

The following illustrates an example of creating Advanced Data Formatting:

When a user scans a barcode with the following criteria:



- Code 39 barcode.
- length of 12 characters.

- contains 129 at the start position.

Modify the data as follows:

- Pad all sends with zeros to length 8.
- send all data up to character X.
- send a space character.

To create an ADF rule for the above example:

1. Swipe up from the bottom of the screen and touch .
2. Touch **Profile0**.
3. Under **Keystroke Output**, touch **Advanced data formatting**.
4. Touch **Enable**.
5. Touch **Rule0**.
6. Touch **Criteria**.
7. Touch **String to check for**.
8. In the **Enter the string to check for** text box, enter 129 and then touch **OK**.
9. Touch **String position**.
10. Change the value to 0.
11. Touch **OK**.
12. Touch **String length**.
13. Change value to 12.
14. Touch **OK**.
15. Touch **Source criteria**.
16. Touch **Barcode input**.
17. Touch **All decoders enabled** to disable all decoders.
18. Touch **Code 39**.
19. Press  three times.
20. Touch **Actions**.
21. Touch and hold on the **Send remaining rule** until a menu appears.
22. Touch **Delete action**.
23. Touch .
24. Touch **New action**.
25. Select **Pad with zeros**.
26. Touch the **Pad with zeros** rule.
27. Touch **How many**.

28. Change value to 8 and then touch **OK**.
29. Press ◀.
30. Touch ⋮.
31. Touch **New action**.
32. Select **Send up to**.
33. Touch **Send up to** rule.
34. Touch **String**.
35. In the **Enter a string** text box, enter x.
36. Touch **OK**.
37. Touch ◀.
38. Touch ⋮.
39. Touch **New action**.
40. Select **Send char**.
41. Touch **Send char** rule.
42. Touch **Character code**.
43. In the **Enter character code** text box, enter 32.
44. Touch **OK**.
45. Touch ◀.

Figure 108 ADF Sample Screen

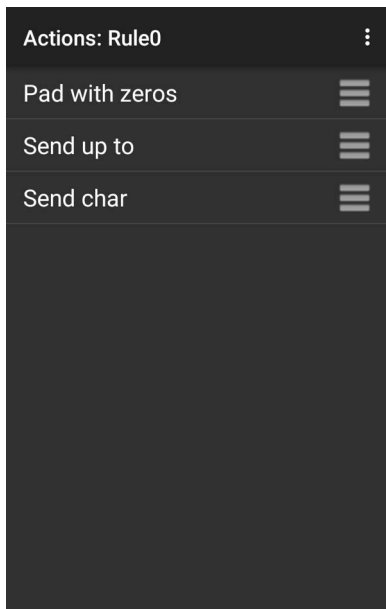

46. Ensure that an application is open on the device and a text field is in focus (text cursor in text field).
47. Aim the exit window at the barcode.

Figure 109 Sample Barcode



48. Press and hold the scan button.

The red laser aiming pattern turns on to assist in aiming. Ensure that the barcode is within the area formed by the aiming pattern. The LED light red to indicate that data capture is in process.

49. The LED lights green, a beep sounds and the device vibrates, by default, to indicate the barcode was decoded successfully. The LED lights green and a beep sounds, by default, to indicate the barcode was decoded successfully. The formatted data 000129X<space>appears in the text field.

Scanning a Code 39 barcode of 1299X15598 does not transmit data (rule is ignored) because the barcode data did not meet the length criteria.

Figure 110 Formatted Data

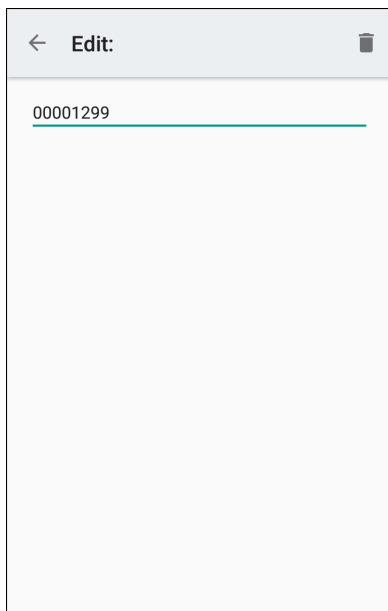

## DataWedge Settings

The DataWedge Settings screen provides access to general, non-profile related options. Touch **⋮** > **Settings**.



Figure 111 DataWedge Settings Window

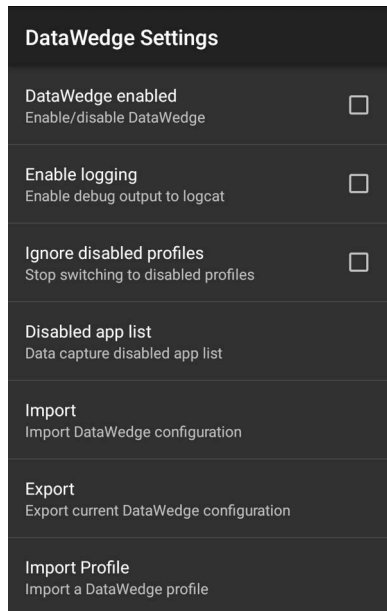

- **DataWedge enabled** - Enables or disables DataWedge. To disable DataWedge uncheck this option (default - enabled).
- **Enable logging** - Enables or disables debug output file to logcat. To enable logging check this option (default - disabled).
- **Ignore disabled profiles** - Prevents DataWedge from switching to a Profile that is not enabled. In such instances, the Profile switch is ignored and the current Profile remains active Profile0 must be disabled to use this feature (default - disabled).
- **Disable app list** - Disables scanning functions for selected applications or activities.
- **Import** - Allows import of a DataWedge configuration file. The imported configuration replaces the current configuration.
- **Export** - Allows export of the current DataWedge configuration.
- **Import Profile** - Allows import of a DataWedge profile file.
- **Export Profile** - Allows export of a DataWedge profile.
- **Restore** - Return the current configuration back to factory defaults.
- **Reporting** - Configures reporting options.

## Importing a Configuration File

1. Copy the configuration file to the microSD card `/Android/data/com.symbol.datawedge/files` folder.
2. Touch **⋮**.
3. Touch **Settings**.
4. Touch **Import**.
5. Touch **filename to import**.

The configuration file (datawedge.db) is imported and replaces the current configuration.

## Exporting a Configuration File

1. Touch **⋮**.
2. Touch **Settings**.
3. Touch **Export**.
4. In the **Export to** dialog box, select the location to save the file.
5. Touch **Export**. The configuration file (datawedge.db) is saved to the selected location.

## Importing a Profile File



**NOTE:** Do not change the filename of the of the profile file. If the filename is changed, the file will not be imported.

1. Copy the profile file to the On Device Storage `/Android/data/com.symbol.datawedge/files` folder.
2. Touch **⋮**.
3. Touch **Settings**.
4. Touch **Import Profile**.
5. Touch the profile file to import.
6. Touch **Import**. The profile file (**dwprofile\_x.db**, where x = the name of the profile) is imported and appears in the profile list.

## Exporting a Profile

1. Touch **⋮**.
2. Touch **Settings**.
3. Touch **Export Profile**.
4. Touch the profile to export.
5. Touch **Export**.  
The profile file (dwprofile\_x.db, where x = name of the profile) is saved to the root of the On-device Storage.

## Restoring DataWedge

To restore DataWedge to the factory default configuration:

1. Touch **⋮**.
2. Touch **Settings**.
3. Touch **Restore**.
4. Touch **Yes**.

## Configuration and Profile File Management

The configuration or profile settings for DataWedge can be saved to a file for distribution to other devices.

After making configuration or profile changes, export the new configuration or profile to the root of the On-device Storage. The configuration file created is automatically named `datawedge.db`. The profile file created is automatically named `dwprofile_x.db`, where `x` is the profile name. The files can then be copied to the On-device Storage of other devices and imported into DataWedge on those devices. Importing a configuration or profile replaces the existing settings.

### Enterprise Folder

Internal storage contains the Enterprise folder (`/enterprise`). The Enterprise folder is persistent and maintains data after an Enterprise reset. After an Enterprise Reset, DataWedge checks folder `/enterprise/device/settings/datawedge/enterpriseset/` for a configuration file, `datawedge.db` or a profile file, `dwprofile_x.db`. If the file is found, it imports the file to replace any existing configuration or profile.



**NOTE:** A Factory Reset deletes all files in the Enterprise folder.

### Auto Import

DataWedge supports remote deployment of a configuration to a device, using tools such as commercially available third-party Mobile Device Management (MDM) systems. DataWedge monitors the `/enterprise/device/settings/datawedge/autoimport` folder for the DataWedge configuration file (`datawedge.db`) or a profile file (`dwprofile_x.db`). If a configuration or profile file is found, it imports the file to replace any existing configuration or profile. Once the file has been imported it is deleted from the folder. DataWedge begins using the imported configuration immediately.



**NOTE:** A Factory Reset deletes all files in the `/enterprise` folder.

It is strongly recommended that the user exits DataWedge before remotely deploying any configuration or profile. It is required that the file permissions are set to 666.

The `/enterprise` folder cannot be seen with **Files** app or other user-level tools. Moving configuration files to and from the `/autoimport` or `/enterpriseset` folders must be done programmatically, or with a staging client app or MDM.

## Programming Notes

The following paragraphs provide specific programming information when using DataWedge.

### Capture Data and Taking a Photo in the Same Application

To be able to capture bar code data and take a photo in the same application:

- Create a Datawedge profile pertaining to the picture taking Activity in your application that disables scanning and use standard Android SDK APIs to control the Camera.
- The default Datawedge profile takes care of the scanning in the application. You might want to create another DataWedge profile that caters to any specific scanning needs, associated to your Application's Activity pertaining to scanning.

## Disable DataWedge on Device

To disable DataWedge:

1. Swipe up from the bottom of the Home screen and touch **DataWedge**.
2. Touch .
3. Touch **Settings**.
4. Unselect the **DataWedge enabled** check box.

### DataWedge APIs

DataWedge APIs operate primarily through Android intents - specific commands that can be used by other applications to control data capture without the need to directly access the DataWedge UI. For more information see, <http://techdocs.zebra.com/datawedge/7-2/guide/api/>.

## Reporting

DataWedge 6.6 (and higher) can report the results of the importation of device Profiles. These HTML reports display settings differences between the originating (source) database and the target (destination) device. This allows administrators to easily identify differences and make adjustments to compensate for disparities in hardware or software capabilities from one device to another. Reports always use the destination device as the basis against which to compare incoming settings files.

## Soft Scan Trigger

DataWedge allows a native Android application to programmatically start, stop, or toggle the scan trigger state. The application can issue an Android Broadcast Intent, to control the scanner, without requiring the scan key to be pressed. The active DataWedge profile is required to control all the parameters during a scan operation.

### Function Prototype

```
Intent i = new Intent();
i.setAction("com.symbol.datawedge.api.ACTION");
i.putExtra("com.symbol.datawedge.api.SOFT_SCAN_TRIGGER", "<parameter>");
```

## Parameters

The structure of the broadcast intent that resolves to the soft scan is:

**ACTION** [String]: "com.symbol.datawedge.api.ACTION"

**EXTRA\_DATA** [String]: "com.symbol.datawedge.api.SOFT\_SCAN\_TRIGGER"

**<parameter>**: The parameter as a string, using any of the following:

- **START\_SCANNING** - starts scanning when triggered

- STOP\_SCANNING - stops or interrupts scanning when triggered
- TOGGLE\_SCANNING - toggles between START\_SCANNING and STOP\_SCANNING when triggered.

## Scanner Input Plugin

The ScannerInputPlugin API command can be used to enable/disable the scanner plug-in being used by the currently active Profile. Disabling the scanner plug-in effectively disables scanning in that Profile, regardless of whether the Profile is associated or unassociated. Valid only when Barcode Input is enabled in the active Profile.



**NOTE:** Use of this API changes only the runtime status of the scanner; it does not make persistent changes to the Profile.

### Function Prototype

```
Intent i = new Intent();
i.setAction("com.symbol.datawedge.api.ACTION");
i.putExtra("com.symbol.datawedge.api.SCANNER_INPUT_PLUGIN", "<parameter>");
```

### Parameters

**action:** String "com.symbol.datawedge.api.ACTION"

**extra\_data:** String "com.symbol.datawedge.api.SCANNER\_INPUT\_PLUGIN"

**<parameter>:** The parameter as a string, using either of the following:

- SUSPEND\_PLUGIN - suspends the scanner so it is temporarily inactive when switching from the WAITING or SCANNING state. SCANNER\_STATUS notification broadcasts IDLE state.
- RESUME\_PLUGIN - resumes the scanner when changing from the SUSPEND\_PLUGIN suspended state. SCANNER\_STATUS notification broadcasts WAITING and SCANNING states, rotating between each depending on whether scanning is taking place. In the WAITING state it is expecting an action from the user such as a trigger press. In the SCANNING state it is actively performing a scan resulting from an action such as a trigger press.
- "ENABLE\_PLUGIN" - enables the plug-in the scanner becomes active.
- "DISABLE\_PLUGIN" - disables the plug-in the scanner becomes inactive.

### Return Values

None.

Error and debug messages will be logged to the Android logging system which then can be viewed and filtered by the logcat command. You can use logcat from an ADB shell to view the log messages, for example:

```
$ adb logcat -s DWAPI
```

Error messages will be logged for invalid actions and parameters.

## Example

```
// define action and data strings
String scannerInputPlugin = "com.symbol.datawedge.api.ACTION_SCANNERINPUTPLUGIN";
String extraData = "com.symbol.datawedge.api.EXTRA_PARAMETER";

public void onResume() {
    // create the intent
    Intent i = new Intent();
    // set the action to perform
    i.setAction(scannerInputPlugin);
    // add additional info
    i.putExtra(extraData, "DISABLE_PLUGIN");
    // send the intent to DataWedge
    context.sendBroadcast(i);
}
```

## Comments

This intent API allows the scanner plug-in for the current Profile to be enabled or disabled. For example, activity A launches and uses the intent API to switch to ProfileA in which the scanner plug-in is enabled, then at some point it uses the Data Capture API to disable the scanner plug-in. Activity B is launched. In DataWedge, ProfileB is associated with activity B. DataWedge switches to ProfileB. When activity A comes back to the foreground, in the `onResume` method, activity A needs to use the intent API to switch back to ProfileA, then use the intent API again to disable the scanner plug-in, to return back to the state it was in.



**NOTE:** Use of this API changes only the runtime status of the scanner; it does not make persistent changes to the Profile. The above assumes that ProfileA is not associated with any applications/activities, therefore when focus switches back to activity A, DataWedge will not automatically switch to ProfileA therefore activity A must switch back to ProfileA in its `onResume` method. Because DataWedge will automatically switch Profile when an activity is paused, it is recommended that this API function be called from the `onResume` method of the activity.

## Enumerate Scanners

Use the `enumerateScanners` API command to get a list of scanners available on the device.

### Function Prototype

```
Intent i = new Intent();
i.setAction("com.symbol.datawedge.api.ACTION");
i.putExtra("com.symbol.datawedge.api.ENUMERATE_SCANNERS", "");
```

### Parameters

**ACTION** [String]: "com.symbol.datawedge.api.ENUMERATE\_SCANNERS"

## Return Values

The enumerated list of scanners will be returned via the broadcast Intent "com.symbol.datawedge.api.ACTION\_ENUMERATEDSCANNERLIST". The list of scanners is returned as a string array (see the example below).

Error and debug messages are logged to the Android logging system which then can be viewed and filtered by the logcat command. You can use logcat from an ADB shell to view the log messages. For example:

```
$ adb logcat -s DWAPI
```

Error messages are logged for invalid actions and parameters.

## Example

```

//
// Call before sending the enumeration query
//
public void registerReceiver(){
    IntentFilter filter = new IntentFilter();
    filter.addAction("com.symbol.datawedge.api.RESULT_ACTION");//RESULT_ACTION
    filter.addCategory(Intent.CATEGORY_DEFAULT);
    registerReceiver(enumeratingBroadcastReceiver, filter);
}
//
// Send the enumeration command to DataWedge
//
public void enumerateScanners(){
    Intent i = new Intent();
    i.setAction("com.symbol.datawedge.api.ACTION");
    i.putExtra("com.symbol.datawedge.api.ENUMERATE_SCANNERS", "");
    this.sendBroadcast(i);
}

public void unRegisterReceiver(){
    unregisterReceiver(enumeratingBroadcastReceiver);
}

//
// Create broadcast receiver to receive the enumeration result
//
private BroadcastReceiver enumeratingBroadcastReceiver = new BroadcastReceiver() {
    @Override
    public void onReceive(Context context, Intent intent) {
        String action = intent.getAction();
        Log.d(TAG, "Action: " + action);
        if(action.equals("com.symbol.datawedge.api.RESULT_ACTION")){
            //
            // enumerate scanners
            //
            if(intent.hasExtra("com.symbol.datawedge.api.RESULT_ENUMERATE_SCANNERS")) {
                ArrayList<Bundle> scannerList = (ArrayList<Bundle>)
intent.getSerializableExtra("com.symbol.datawedge.api.RESULT_ENUMERATE_SCANNERS");
                if((scannerList != null) && (scannerList.size() > 0)) {
                    for (Bundle bunb : scannerList){
                        String[] entry = new String[4];
                        entry[0] = bunb.getString("SCANNER_NAME");
                        entry[1] = bunb.getBoolean("SCANNER_CONNECTION_STATE")+"";
                        entry[2] = bunb.getInt("SCANNER_INDEX")+"";

                        entry[3] = bunb.getString("SCANNER_IDENTIFIER");

                        Log.d(TAG, "Scanner:" + entry[0] + " Connection:" + entry[1] + " Index:" + entry[2] + " ID:" + entry[3]);
                    }
                }
            }
        }
    }
};

```

## Comments

The scanner and its parameters are set based on the currently active Profile.



## Set Default Profile

Use the `setDefaultProfile` API function to set the specified Profile as the default Profile.

### Default Profile Recap

Profile0 is the generic Profile used when there are no user created Profiles associated with an application.

Profile0 can be edited but cannot be associated with an application. That is, DataWedge allows manipulation of plug-in settings for Profile0 but it does not allow assignment of a foreground application. This configuration allows DataWedge to send output data to any foreground application other than applications associated with user-defined Profiles when Profile0 is enabled.

Profile0 can be disabled to allow DataWedge to only send output data to those applications which are associated in user-defined Profiles. For example, create a Profile associating a specific application, disable Profile0 and then scan. DataWedge only sends data to the application specified in the user-created Profile. This adds additional security to DataWedge enabling the sending of data only to specified applications.

### Usage Scenario

A launcher application has a list of apps that a user can launch and that none of the listed apps has an associated DataWedge Profile. Once the user has selected an app, the launcher needs to set the appropriate DataWedge Profile for the selected app. This could be done by using `setDefaultProfile` to set the default Profile to the required Profile. Then when the user launches the selected app, DataWedge auto Profile switching switches to the default Profile (which is now the required Profile for that app).

If, for some reason, the launched app has an associated DataWedge Profile then that will override the set default Profile.

When control is returned to the launcher application, `resetDefaultProfile` can be used to reset the default Profile.

### Function Prototype

```
Intent i = new Intent();
i.setAction("com.symbol.datawedge.api.ACTION");
i.putExtra("com.symbol.datawedge.api.SET_DEFAULT_PROFILE", "<profile name>");
```

### Parameters

**ACTION** [String]: "com.symbol.datawedge.api.ACTION"

**EXTRA\_DATA** [String]: "com.symbol.datawedge.api.SET\_DEFAULT\_PROFILE"

**<profile name>**: The Profile name (a case-sensitive string) to set as the default Profile.

### Return Values

None.

Error and debug messages are logged to the Android logging system which then can be viewed and filtered by the `logcat` command. You can use `logcat` from an ADB shell to view the log messages. For example:

```
$ adb logcat -s DWAPI
```

Error messages are logged for invalid actions, parameters and failures, for example, Profile not found or associated with an application.

## Example

```
// define action and data strings
String setDefaultProfile = "com.symbol.datawedge.api.ACTION";
String extraData = "com.symbol.datawedge.api.SET_DEFAULT_PROFILE";

public void onResume() {
    // create the intent
    Intent i = new Intent();

    // set the action to perform
    i.setAction(setDefaultProfile);

    // add additional info (a name)
    i.putExtra(extraData, "myProfile");

    // send the intent to DataWedge
    this.sendBroadcast(i);
}
```

## Comments

The API command has no effect if the specified Profile does not exist or if the specified Profile is already associated with an application. DataWedge automatically switches Profiles when the activity is paused, so it is recommended that this API function is called from the onResume method of the activity.

Zebra recommends that this Profile is created to cater to all applications/activities that would otherwise default to using Profile0. This ensures that these applications/activities continue to work with a consistent configuration.

## Reset Default Profile

Use the resetDefaultProfile API function to reset the default Profile back to Profile0.

## Function Prototype

```
Intent i = new Intent();
i.setAction("com.symbol.datawedge.api.ACTION");
i.putExtra("com.symbol.datawedge.api.RESET_DEFAULT_PROFILE", "");
```

## Parameters

**ACTION** [String]: "com.symbol.datawedge.api.ACTION"

**EXTRA\_DATA** [String]: "com.symbol.datawedge.api.RESET\_DEFAULT\_PROFILE".

## Return Values

None.

Error and debug messages are logged to the Android logging system which then can be viewed and filtered by the logcat command. You can use logcat from an ADB shell to view the log messages. For example:

```
$ adb logcat -s DWAPI
```

Error messages are logged for invalid actions, parameters and failures, for example, Profile not found or associated with an application.

## Example

```
// define action string
String action = "com.symbol.datawedge.api.ACTION";
String extraData = "com.symbol.datawedge.api.RESET_DEFAULT_PROFILE";

public void onResume() {
    // create the intent
    Intent i = new Intent();

    // set the action to perform
    i.setAction(action);
    i.putExtra(extraData, ""); // empty since a name is not required
    this.sendBroadcast;
}
```

## Comments

None.

## Switch To Profile

Use the SwitchToProfile API action to switch to the specified Profile.

### Profiles Recap

DataWedge is based on Profiles and plug-ins. A Profile contains information on how DataWedge should behave with different applications.

Profile information consists of:

- Associated application
- Input plug-in configurations
- Output plug-in configurations
- Process plug-in configurations

DataWedge includes a default Profile, Profile0, that is created automatically the first time DataWedge runs.

Using Profiles, each application can have a specific DataWedge configuration. For example, each user application can have a Profile which outputs scanned data in the required format when that application comes to the foreground. DataWedge can be configured to process the same set of captured data differently based on the requirements of each application.



**NOTE:** Use of this API changes only the runtime status of the scanner; it does not make persistent changes to the Profile. A single Profile may be associated with one or many activities/apps, however, given an activity, only one Profile may be associated with it.

### Usage Scenario

An application has two activities. Activity A only requires EAN13 bar codes to be scanned. Activity B only requires Code 128 bar codes to be scanned. Profile EAN13 is configured to only scan EAN13 bar codes and is left unassociated. Profile Code128 is configured to scan Code 128 and is left unassociated. When Activity A launches it uses SwitchToProfile to activate Profile EAN13. Similarly, when Activity B launches it uses switchToProfile to activate Profile Code128.

If another activity/app comes to the foreground, DataWedge auto Profile switching sets the DataWedge Profile accordingly either to the default Profile or to an associated Profile.

When Activity A (or Activity B) comes back to the foreground it uses switchToProfile to reset the Profile back to Profile B (or Profile M).

### Function Prototype

```
Intent i = new Intent();
i.setAction("com.symbol.datawedge.api.ACTION");
i.putExtra("com.symbol.datawedge.api.SWITCH_TO_PROFILE", "<profile name>");
```

### Parameters

**ACTION** [String]: "com.symbol.datawedge.api.ACTION"

**EXTRA\_DATA** [String]: "com.symbol.datawedge.api.SWITCH\_TO\_PROFILE"

**<profile name>**: The Profile name (a case-sensitive string) to set as the active Profile.

## Return Values

None.

Error and debug messages are logged to the Android logging system which then can be viewed and filtered by the logcat command. You can use logcat from an ADB shell to view the log messages. For example:

```
$ adb logcat -s DWAPI
```

Error messages are logged for invalid actions, parameters and failures, for example, Profile not found or associated with an application.

## Example

```
// define action and data strings
String switchToProfile = "com.symbol.datawedge.api.ACTION";
String extraData = "com.symbol.datawedge.api.SWITCH_TO_PROFILE";

public void onResume() {
    super.onResume();

    // create the intent
    Intent i = new Intent();

    // set the action to perform
    i.setAction(switchToProfile);

    // add additional info
    i.putExtra(extraData, "myProfile");

    // send the intent to DataWedge
    this.sendBroadcast(i);
}
```

## Comments

This API function has no effect if the specified Profile does not exist or is already associated with an application.

DataWedge has a one-to-one relationship between Profiles and activities; a Profile can be associated only with a single activity. When a Profile is first created, it's not associated with any application, and is not activated until associated. This makes it possible to create multiple unassociated Profiles.

This API function activates such Profiles.

For example, Profile A is unassociated and Profile B is associated with activity B. If activity A is launched and uses **SwitchToProfile** function to switch to Profile A, then Profile A is active whenever activity A is in the foreground. When activity B comes to the foreground, DataWedge automatically switches to Profile B.

When activity A returns to the foreground, the app must use **SwitchToProfile** again to switch back to Profile A. This would be done in the **onResume** method of activity A.



**NOTE:** Use of this API changes only the runtime status of the scanner; it does not make persistent changes to the Profile.

## Notes

Because DataWedge automatically switches Profile when the activity is paused, Zebra recommends that this API function is called from the **onResume** method of the activity.

After switching to a Profile, this unassociated Profile does not get assigned to the application/activity and is available to use in the future with a different app/activity.

For backward compatibility, DataWedge's automatic Profile switching is not affected by the above API commands. This why the commands work only with unassociated Profiles and apps.

DataWedge auto Profile switching works as follows:

Every second...

- Sets `newProfileId` to the associated Profile ID of the current foreground activity.
- If no associated Profile is found, sets `newProfileId` to the associated Profile ID of the current foreground app.
- If no associated Profile is found, sets `newProfileId` to the current default Profile (which MAY NOT be Profile0).
- Checks the `newProfileId` against the `currentProfileId`. If they are different:
  - deactivates current Profile
  - activates new Profile (`newProfileId`)
  - sets `currentProfileId` = `newProfileId`

# Application Deployment

## Introduction

This chapter describes features in Android including new security features, how to package applications, and procedures for deploying applications onto the device.

## Security

The device implements a set of security policies that determine whether an application is allowed to run and, if allowed, with what level of trust. To develop an application, you must know the security configuration of the device, and how to sign an application with the appropriate certificate to allow the application to run (and to run with the needed level of trust).



**NOTE:** Ensure the date is set correctly before installing certificates or when accessing secure web sites.

## Secure Certificates

If the VPN or Wi-Fi networks rely on secure certificates, obtain the certificates and store them in the device's secure credential storage, before configuring access to the VPN or Wi-Fi networks.

If downloading the certificates from a web site, set a password for the credential storage. The device supports X.509 certificates saved in PKCS#12 key store files with a .p12 extension (if key store has a .pfx or other extension, change to .p12).

The device also installs any accompanying private key or certificate authority certificates contained in the key store.

## Installing a Secure Certificate

To install a secure certificate:

1. Copy the certificate from the host computer to the root of the device's internal memory. See USB Communication for information about connecting the device to a host computer and copying files.
2. Swipe down from the Status bar to open the Quick Access panel and then touch .
3. Touch **Security & location > Advanced > Encryption & credentials**.
4. Touch **Install from storage**.
5. Navigate to the location of the certificate file.

6. Touch the filename of the certificate to install.
7. If prompted, enter the password for credential storage. If a password has not been set for the credential storage, enter a password for it twice and then touch **OK**.
8. If prompted, enter the certificate's password and touch **OK**.
9. Enter a name for the certificate and in the Credential use drop-down, select **VPN and apps** or **Wi-Fi**.

**Figure 112** Name the Certificate Dialog Box

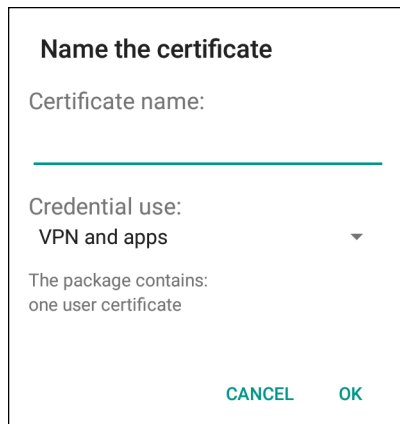

**Name the certificate**

Certificate name:

\_\_\_\_\_

Credential use:  
VPN and apps ▼

The package contains:  
one user certificate

CANCEL OK

10. Touch **OK**.

The certificate can now be used when connecting to a secure network. For security, the certificate is deleted from the internal memory.

## Configuring Credential Storage Settings

1. Swipe down from the Status bar to open the Quick Access panel and then touch .
2. Touch **Security & location > Encryption & credentials**.
  - **Trusted credentials** - Touch to display the trusted system and user credentials.
  - **Install from storage** - Touch to install a secure certificate from the internal storage.
  - **Clear credentials** - Deletes all secure certificates and related credentials.

## Development Tools

### Android Application Development

#### Development Workstation

Android development tools are available at [developer.android.com](http://developer.android.com).

To start developing applications for the device, download Android Studio. Development can take place on a Microsoft® Windows®, Mac® OS X®, or Linux® operating system.

Applications are written in the Java language, but compiled and executed in the Dalvik virtual machine. Once the Java code is compiled cleanly, the developer tools make sure the application is packaged properly, including the AndroidManifest.xml file.



Android Studio contains a full featured IDE as well as SDK components required to develop Android applications.

### Target Device

Open the **Developer options** screen to set development related settings.

By default, the Developer Options are hidden. To un-hide the developer options, swipe down from the Status bar to open the Quick Access panel and then touch .

Touch **System > About device**. Scroll down to **Build number**. Tap **Build number** seven times until **You are now a developer appears**.

Touch **System > Developer options**. Slide the switch to the **ON** position to enable developer options.

### EMDK for Android

EMDK for Android provides developers with a comprehensive set of tools to easily create powerful line-of-business applications for enterprise mobile computing devices. It's designed for Google's Android SDK and Android Studio, and includes class libraries, sample applications with source code, and all associated documentation to help your applications take full advantage of what Zebra devices have to offer.

The kit also delivers Profile Manager, a GUI-based device configuration tool providing exclusive access to the Zebra MX device management framework. This allows developers to configure Zebra devices from within their applications in less time, with fewer lines of code and with fewer errors.

For more information go to: [techdocs.zebra.com](http://techdocs.zebra.com).

### StageNow

StageNow is Zebra's next-generation Android Staging Solution built on the MX platform. It allows quick and easy creation of device profiles, and can deploy to devices simply by scanning a bar code, reading a tag, or playing an audio file.

The StageNow Staging Solution includes the following components:

- The StageNow Workstation tool installs on the staging workstation (host computer) and lets the administrator easily create staging profiles for configuring device components, and perform other staging actions such as checking the condition of a target device to determine suitability for software upgrades or other activities. The StageNow Workstation stores profiles and other created content for later use.
- The StageNow Client resides on the device and provides a user interface for the staging operator to initiate staging. The operator uses one or more of the desired staging methods (print and scan a bar code, read an NFC tag or play an audio file) to deliver staging material to the device.

For more information go to: [techdocs.zebra.com](http://techdocs.zebra.com).

### GMS Restricted

GMS Restricted mode deactivates Google Mobile Services (GMS). All GMS apps are disabled on the device and communication with Google (analytics data collection and location services) is disabled.

Use StageNow to disable or enable GMS Restricted mode. After a device is in GMS Restricted mode, enable and disable individual GMS apps and services using StageNow. To ensure GMS Restricted mode persists

after an Enterprise Reset, use the Persist Manager option in StageNow. For more information on StageNow, refer to [techdocs.zebra.com](http://techdocs.zebra.com).



### ADB USB Setup

To use the ADB, install the USB driver. This assumes that the development SDK has been installed on the host computer. Go to [developer.android.com/sdk/index.html](http://developer.android.com/sdk/index.html) for details on setting up the development SDK.

ADB driver for Windows and Linux are available on the Zebra Support Central web site at [www.zebra.com/support](http://www.zebra.com/support). Download the ADB and USB Driver Setup package. Follow the instructions with the package to install the ADB and USB drivers for Windows and Linux.

### Enabling USB Debugging

By default, USB debugging is disabled. To enable USB debugging:

1. Swipe down from the Status bar to open the Quick Access panel, and then touch .
2. Touch **System > About phone**.
3. Scroll down to **Build number**.
4. Tap **Build number** seven times. The message **You are now a developer!** appears.
5. Touch .
6. Touch **Developer options**.
7. Slide the **USB debugging** switch to the **ON** position.
8. Touch **OK**.
9. Connect the device to the host computer using the Rugged Charge/USB Cable.  
The **Allow USB debugging?** dialog box appears on the device.
10. On the device, touch **OK**.
11. On the host computer, navigate to the `platform-tools` folder.
12. Type `adb devices`.  
The following displays:  
**List of devices attached**  
`XXXXXXXXXXXXXXXXX device` (where XXXXXXXXXXXXXXXXXXXX is the device number).



**NOTE:** If device number does not appear, ensure that ADB drivers are installed properly.

13. Touch .

### Application Installation

After an application is developed, install the application onto the device using one of the following methods:

- USB connection, see Installing Applications Using the USB Connection.
- Android Debug Bridge, see Installing Applications Using the Android Debug Bridge.
- microSD Card, see Installing Applications Using a microSD Card.

- Mobile device management (MDM) platforms that have application provisioning. Refer to the MDM software documentation for details.

## Using Android Studio

While developing a custom application Android Studio can build, download, install, and run your application with a single command.

### Installing Applications Using the USB Connection

1. Connect the device to a host computer using the Rugged Charge/USB cable.
2. Pull down the Notification panel and touch **USB for Charging**.

**Figure 113** Use USB Dialog Box

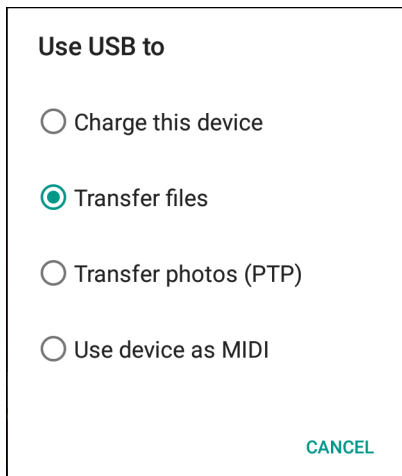

3. Touch **Transfer files**.
4. On the host computer, open a **Files** application.
5. On the host computer, copy the application .apk file from the host computer to the device.
6. Disconnect the device from the host computer.
7. Swipe the screen up and select  to view files on the Internal Storage.
8. Locate the application .apk file.
9. Touch the application file.

**Figure 114** Install App Permission Dialog Box

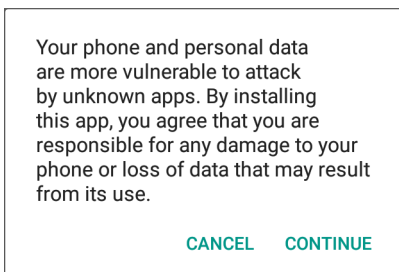

10. Touch **Continue** to install the app or **Cancel** to stop the installation.

Figure 115 Accept Installation Screen

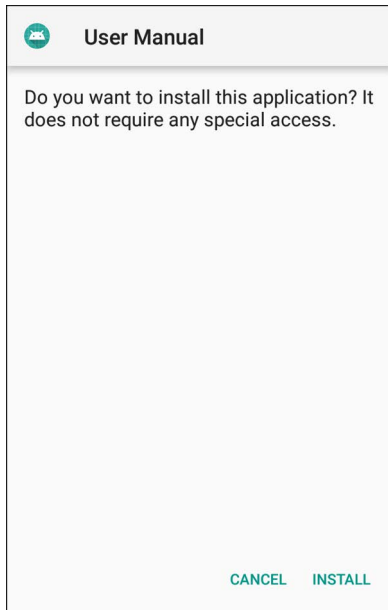

11. To confirm installation and accept what the application affects, touch **Install** otherwise touch **Cancel**.

12. Touch **Open** to open the application or **Done** to exit the installation process. The application appears in the App list.

## Installing Applications Using the Android Debug Bridge

Use ADB commands to install application onto the device.

Ensure that the ADB drivers are installed on the host computer. See ADB USB Setup.

1. Connect the device to a host computer using USB. See USB Communication.
2. Swipe down from the Status bar to open the Quick Access panel and then touch .
3. Touch **System > Developer options**.
4. Slide the switch to the **ON** position.
5. Touch **USB Debugging**. A check appears in the check box. The **Allow USB debugging?** dialog box appears.
6. Touch **OK**.
7. On the host computer, open a command prompt window and use the adb command:  
`adb install <application>`  
 where: <application> = the path and filename of the apk file.
8. Disconnect the device from the host computer. See USB Communication.

## Installing Applications Using a microSD Card



**CAUTION:** When connecting the device to a host computer and mounting its microSD card, follow the host computer's instructions for connecting and disconnecting USB devices, to avoid damaging or corrupting files.



1. Connect the device to a host computer using USB. See USB Communication.
2. Copy the application APK file from the host computer to the microSD card.
3. Remove the microSD card from the host computer.
4. Press and hold the Power button on the device until the menu appears.
5. Touch **Power off**.
6. Remove the battery from the device.
7. Remove the keypad.
8. Slide the microSD card holder to the Open position.
9. Lift the microSD card holder.
10. Insert the microSD card into the card holder door ensuring that the card slides into the holding tabs on each side of the door.
11. Close the microSD card holder door and slide the door to the Lock position.
12. Replace the keypad.
13. Insert the battery.
14. Press and hold the Power button to turn on the device.
15. Swipe the screen up and select  to view files on the microSD card.
16. Touch  > **SD card**.
17. Locate the application .apk file.
18. Touch the application file.

Figure 116 Install App Permission Dialog Box



19. Touch **Continue** to install the app or **Cancel** to stop the installation.

Figure 117 Accept Installation Screen

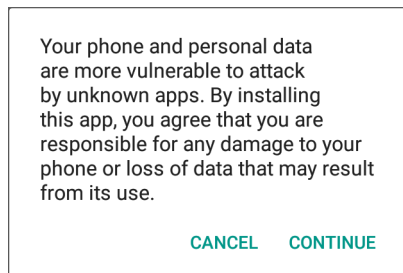
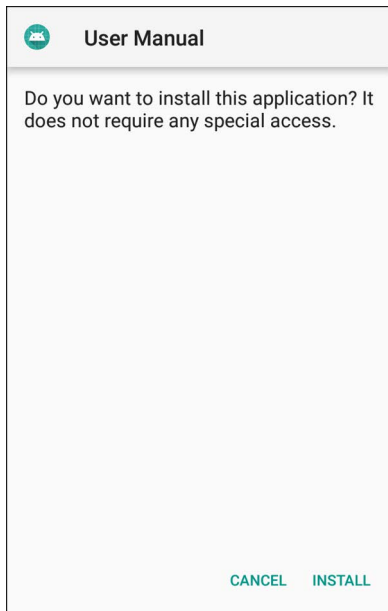

20. To confirm installation and accept what the application affects, touch **Install** otherwise touch **Cancel**.

21. Touch **Open** to open the application or **Done** to exit the installation process. The application appears in the App list.

## Uninstalling an Application

To uninstall an application:

1. Swipe down from the Status bar to open the Quick Access panel and then touch .
2. Touch **Apps & notifications**.
3. Touch **See all apps** to view all apps in the list.
4. Scroll through the list to the app.

5. Touch the app. The **App info** screen appears.

**Figure 118** App Info Screen

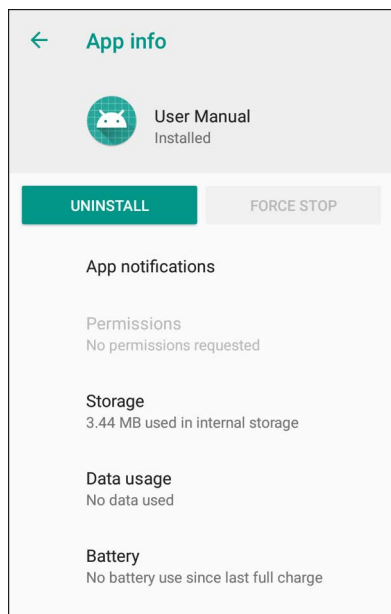

6. Touch **Uninstall**.
7. Touch **OK** to confirm.

## Performing a System Update

System Update packages can contain either partial or complete updates for the operating system. Zebra distributes the System Update packages on the Zebra Support & Downloads web site. Perform system update using either a microSD card or using ADB.

### Downloading the System Update Package

To download the system update package:

1. Go to the Zebra Support & Downloads web site, [www.zebra.com/support](http://www.zebra.com/support).
2. Download the appropriate System Update package to a host computer.

### Using microSD Card

It is strongly recommended that prior to use, you must format the microSD card on the device.

1. Copy the System Update zip file to the root of the microSD card.
  - Copy the zip file to a microSD card using a host computer (see USB Communication for more information), and then installing the microSD card into the device (see Replacing the microSD Card for more information).
  - Connect the device with a microSD card already installed to the host computer, and copy zip file to the microSD card. See USB Communication for more information. Disconnect the device from the host computer.

2. Press and hold the Power button until the menu appears.
3. Touch **Restart**.
4. Touch **OK**. The device resets.
5. Press and hold the Trigger button until the device vibrates. The System Recovery screen appears.
6. Press the Up and Down buttons to navigate to **apply from sdcard**.
7. Press the Enter button.
8. Use the Up and Down buttons to navigate to **Full OTA Package** or **Diff OTA Package**.
9. Press the Enter button.
10. Use the Up and Down buttons to navigate to the System Update file.
11. Press the Power button. The System Update installs and then the device returns to the Recovery screen.
12. Press the Power button to reboot the device.



**NOTE:** If installing GMS software on a device that had Non-GMS software or Non-GMS software on a device that had GMS software, perform a Factory or Enterprise reset (retains enterprise data).

### Using ADB

To update the system using ADB:

1. On the device, swipe down from the Status bar to open the Quick Access panel and then touch .
2. Touch **System > Developer options**.
3. Slide the switch to the **ON** position.
4. Touch **USB Debugging**. A check appears in the check box. The **Allow USB debugging?** dialog box appears.
5. Touch **OK**.
6. On the host computer, open a command prompt window and use the adb command:  
`adb devices`  
 The following displays:  
**List of devices attached**  
 XXXXXXXXXXXXXXXX device (where XXXXXXXXXXXXXXXX is the device number).



**NOTE:** If device number does not appear, ensure that ADB drivers are installed properly.

7. Type:  
`adb reboot recovery`
8. Press Enter. The System Recovery screen appears.
9. Press the Up and Down buttons to navigate to **apply from adb**.
10. Press Enter.
11. Use the Up and Down buttons to navigate to **Full OTA Package** or **Diff OTA Package**.



12. Press the Enter button.

13. On the host computer command prompt window type:

```
adb sideload <file>
```

where: <file> = the path and filename of the zip file.

14. Press Enter. The System Update installs (progress appears as percentage in the Command Prompt window) and then the Recovery screen appears.

15. Press the Power button to reboot the device.



**NOTE:** If installing GMS software on a device that had Non-GMS software or Non-GMS software on a device that had GMS software, perform a Factory or Enterprise reset (retains enterprise data).

### Verify System Update Installation

To check that the system update installed properly:

1. On the device, swipe down from the Status bar to open the Quick Access panel and then touch .
2. Touch **System > About phone**.
3. Scroll down to **Build number**.
4. Ensure that the build number matches the new system update package file number.

### Performing an Enterprise Reset

An Enterprise Reset erases all user data in the /data partition, including data in the primary storage locations (/sdcard and emulated storage).

Before performing an Enterprise Reset, provision all necessary configuration files and restore after the reset.

Perform Enterprise Reset using ADB.

### Downloading the Enterprise Reset Package

To download the system update package:

1. Go to the Zebra Support & Downloads web site, [www.zebra.com/support](http://www.zebra.com/support).
2. Download the Enterprise Reset file to a host computer.

### Using microSD Card

It is strongly recommended that prior to use, you must format the microSD card on the device.

1. Copy the Enterprise Reset zip file to the root of the microSD card.
  - Copy the zip file to a microSD card using a host computer (see USB Communication for more information) and then installing the microSD card into the device (see Replacing the microSD Card for more information).
  - Connect the device with a microSD card already installed to the host computer and copy zip file to the microSD card. See USB Communication for more information. Disconnect the device from the host computer.

2. Press and hold the Power button until the menu appears.
3. Touch **Reboot**.
4. Touch **OK**. The device resets.
5. Press and hold the Trigger button until the device vibrates. The System Recovery screen appears.
6. Press the Up and Down buttons to navigate to **apply from sdcard**.
7. Press the Enter button.
8. Press the Up and Down buttons to navigate to **apply from adb**.
9. Press Enter.
10. Use the Up and Down buttons to navigate to **Full OTA Package** or **Diff OTA Package**.
11. Press the Enter button.
12. Use the Up and Down buttons to navigate to the Enterprise Reset file.
13. Press the Power button. The Enterprise Reset occurs and then the device returns to the Recovery screen.
14. Press the Power button.

## Using ADB

To perform an Enterprise Reset using ADB:

1. On the device, swipe down from the Status bar to open the Quick Access panel and then touch .
2. Touch **System > Developer options**.
3. Slide the switch to the **ON** position.
4. Touch **USB Debugging**. A check appears in the check box. The **Allow USB debugging?** dialog box appears.
5. Touch **OK**.
6. On the host computer, open a command prompt window and type:

```
adb devices.
```

The following displays:

```
List of devices attached
```

```
XXXXXXXXXXXXXXXXX device (where XXXXXXXXXXXXXXXXXXXX is the device number).
```



**NOTE:** If device number does not appear, ensure that ADB drivers are installed properly.

7. Type:  

```
adb reboot recovery
```
8. Press Enter. The System Recovery screen appears.
9. Press the Up and Down buttons to navigate to **apply from adb**.
10. Press Enter.
11. Use the Up and Down buttons to navigate to **Full OTA Package** or **Diff OTA Package**.
12. Press Enter.

13. On the host computer command prompt window type:

```
adb sideload <file>
```

where: <file> = the path and filename of the zip file.

14. Press Enter. The Enterprise Reset package installs and then the Recovery screen appears.

15. Press the Enter button to reboot the device.

## Performing a Factory Reset

A Factory Reset erases all data in the `/data` and `/enterprise` partitions in internal storage and clears all device settings. A Factory Reset returns the device to the last installed operating system image. To revert to a previous operating system version, re-install that operating system image. See [Performing a System Update](#) for more information.

## Downloading the Factory Reset Package

To download the Factory Reset package:

1. Go to the Zebra Support & Downloads web site, [www.zebra.com/support](http://www.zebra.com/support).
2. Download the appropriate Factory Reset file to a host computer.

## Using microSD Card

1. Copy the Factory Reset zip file to the root of the microSD card.
  - Copy the zip file to a microSD card using a host computer (see [USB Communication](#) for more information) and then installing the microSD card into the device (see [Replacing the microSD Card](#) for more information).
  - Connect the device with a microSD card already installed to the host computer and copy zip file to the microSD card. See [USB Communication](#) for more information. Disconnect the device from the host computer.
2. Press and hold the Power button until the menu appears.
3. Touch **Reboot**.
4. Touch **OK**. The device resets.
5. Press and hold the Trigger button until the device vibrates. The System Recovery screen appears.
6. Press the Up and Down buttons to navigate to **apply from sdcard**.
7. Press the Enter button.
8. Use the Up and Down buttons to navigate to **Full OTA Package** or **Diff OTA Package**.
9. Press the Enter button.
10. Use the Up and Down buttons to navigate to the Factory Reset file.
11. Press the Power button. The Factory Reset occurs and then the device returns to the Recovery screen.
12. Press the Power button.

## Using ADB

To perform an Factory Reset using ADB:

1. On the device, swipe down from the Status bar to open the Quick Access panel and then touch .
2. Touch **System > Developer options**.
3. Slide the switch to the **ON** position.
4. Touch **USB Debugging**. A check appears in the check box. The **Allow USB debugging?** dialog box appears.
5. Touch **OK**.
6. On the host computer, open a command prompt window and use the adb command:

```
adb devices.
```

The following displays:

```
List of devices attached
```

```
XXXXXXXXXXXXXXXX device (where XXXXXXXXXXXXXXXXXXXX is the device number).
```



**NOTE:** If device number does not appear, ensure that ADB drivers are installed properly.

7. Type:
 

```
adb reboot recovery
```
8. Press Enter. The System Recovery screen appears.
9. Press the Up and Down buttons to navigate to **apply from adb**.
10. Press Enter.
11. Use the Up and Down buttons to navigate to **Full OTA Package** or **Diff OTA Package**.
12. Press Enter.
13. On the host computer command prompt window type:
 

```
adb sideload <file>
```

 where: <file> = the path and filename of the zip file.
14. Press Enter. The Factory Reset package installs and then the Recovery screen appears.
15. Press the Enter button to reboot the device.

## Storage

The device contains the following types of file storage:

- Random Access Memory (RAM)
- Internal storage
- Enterprise folder.

## Random Access Memory

Executing programs use RAM to store data. Data stored in RAM is lost upon a reset. The operating system manages how applications use RAM. It only allows applications and component processes and services to use RAM when required. It may cache recently used processes in RAM, so they restart more quickly when opened again, but it will erase the cache if it needs the RAM for new activities.

1. To view the amount of free and used memory, swipe down from the Status bar to open the Quick Access panel and then touch .
2. Touch **System > Developer options > Memory**.

**Figure 119** Memory Screen

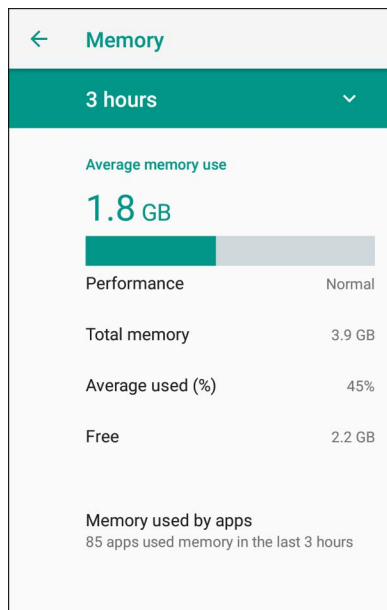

The screen displays the amount of used and free RAM.

- **Performance** - Indicates memory performance.
- **Total memory** - Indicates the total amount of RAM available.
- **Average used (%)** - Indicates the average amount of memory (as a percentage) used during the period of time selected (default - 3 hours).
- **Free** - Indicates the total amount of unused RAM.
- **Memory used by apps** - Touch to view RAM usage by individual apps.

## Internal Storage

The device has internal storage. The internal storage content can be viewed and files copied to and from when the device is connected to a host computer. Some applications are designed to be stored on the internal storage rather than in internal memory.

To view the used and available space on the internal storage:

1. Swipe down from the Status bar to open the Quick Access panel and then touch .
2. Touch **Storage**.

Figure 120 Storage Screen



## External Storage

The device can have a removable microSD card. The microSD card content can be viewed and files copied to and from when the device is connected to a host computer.

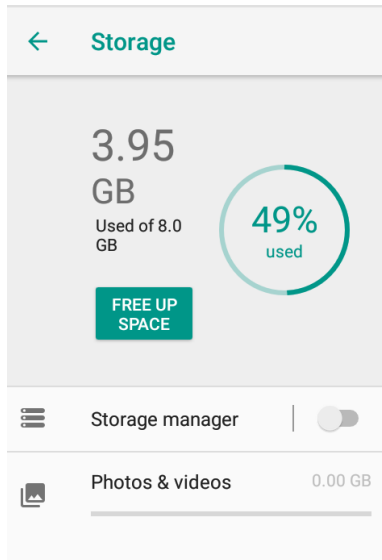
To view the used and available space on the microSD card:

1. Swipe down from the Status bar to open the Quick Access panel and then touch .
2. Touch **Storage**.

Figure 121 External Storage Screen



Portable storage displays the total amount of space on the installed and the amount used.

To unmount the microSD card, touch .

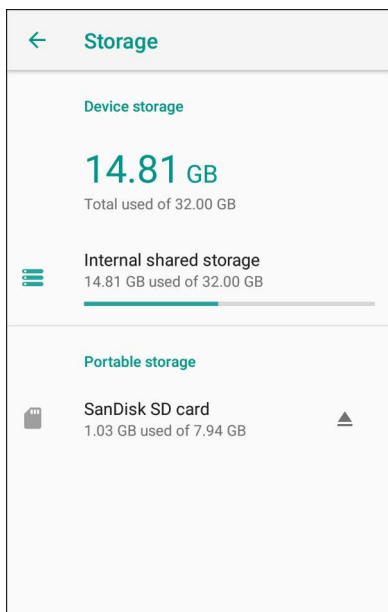
Touch **SD card** to view the contents of the card.

## Formatting a microSD Card as Portable Storage

To format an installed microSD card as portable storage:

1. Touch **SD card**.
2. Touch  > **Storage settings**.

**Figure 122** SD Card Settings Screen

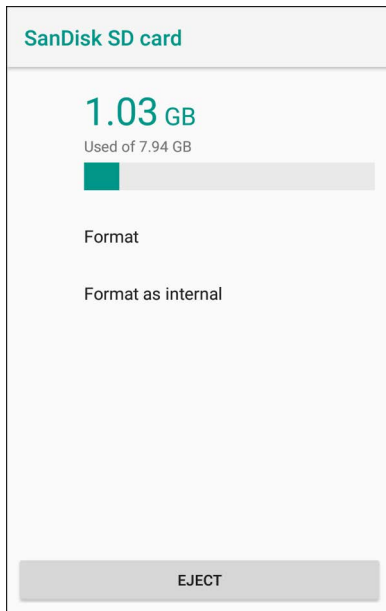

3. Touch **Format**.

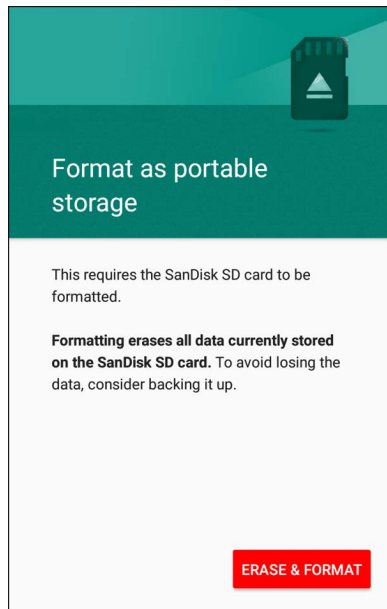
**Figure 123** Format Screen

4. Touch **ERASE & FORMAT**.
5. Touch **DONE**.

### Formatting a microSD Card as Internal Memory

You can format a microSD card as internal memory to increase the actual amount of the device's internal memory. Once formatted, the microSD card can only be read by this device. To format an installed microSD card as internal memory:

1. Touch **SD card**.



2. Touch **:** > **Storage settings**.

**Figure 124** SD Card Settings Screen

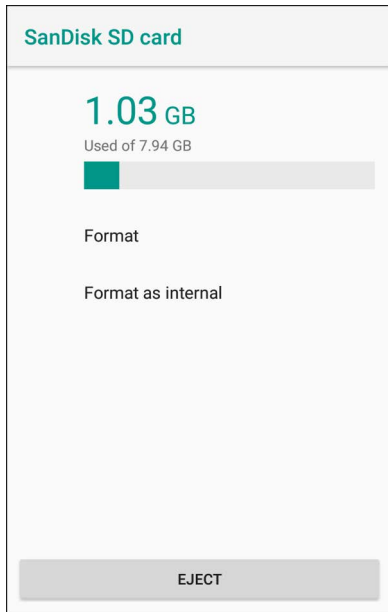

3. Touch **Format as internal**.

**Figure 125** Format Screen

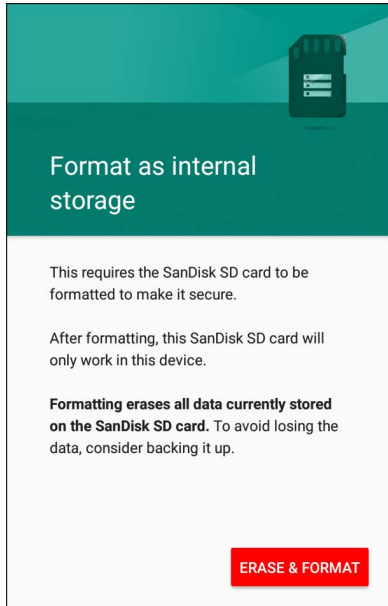

4. Touch **ERASE & FORMAT**.
5. Touch **DONE**.

## Enterprise Folder

The Enterprise folder (within internal flash) is a super-persistent storage that is persistent after a reset and an Enterprise Reset. The Enterprise folder is erased during a Factory Reset. The Enterprise folder is used for deployment and device-unique data. The Enterprise folder is approximately 128 MB (formatted). Applications can persist data after an Enterprise Reset by saving data to the enterprise/user folder. The folder is ext4 formatted and is only accessible from a host computer using ADB or from an MDM.

## App Management

Apps use two kinds of memory: storage memory and RAM. Apps use storage memory for themselves and any files, settings, and other data they use. They also use RAM when they are running.

1. Swipe down from the Status bar to open the Quick Access panel and then touch .
2. Touch **Apps & notifications**.

**Figure 126** Apps & Notifications Screen

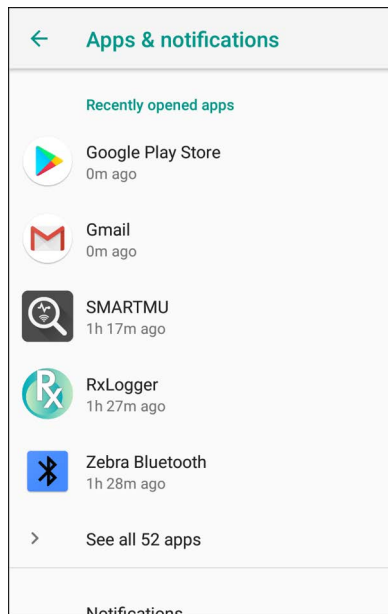

3. Touch **See all XX apps** to view all apps on the device.

Figure 127 App Info Screen

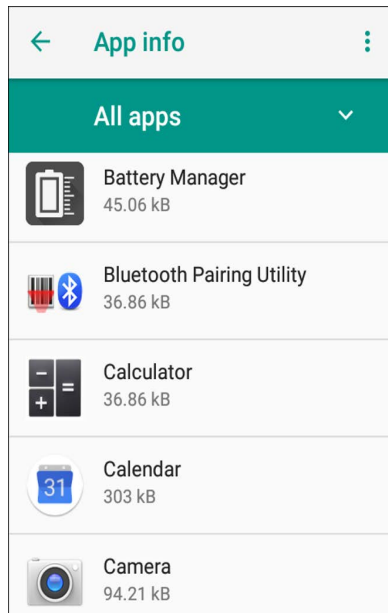

4. Touch **Show system** to include system processes in the list.
5. Touch an app, process, or service in the list to open a screen to view its details. Depending on the item, you can change its settings, permissions, notifications, and force stop or uninstall the item.

## Viewing App Details

Apps have different kinds of information and controls, but commonly include:

- **Force stop** - stop an app.
- **Disable** - disable an app.
- **Uninstall** - remove the app and all of its data and settings from the device. See [Uninstalling an Application](#) for information about uninstalling apps.
- **Storage** - lists how much information is stored, and includes a button for clearing it.
- **Data usage** - provides information about data (Wi-Fi) consumed by an app.
- **Permissions** - lists the areas on the device that the app has access to.
- **Notifications** - set the app notification settings.
- **Open by default** - clears If you have configured an app to launch certain file types by default, you can clear that setting here.
- **Battery** - lists the amount of computing power used by the app.
- **Memory** - lists the average app memory usage.
- Advanced
  - **Draw over other apps** - allows an app to display on top of other apps.

## Managing Downloads

Files and apps downloaded using the Browser or Email are stored on the Internal storage in the Download directory. Use the Downloads app to view, open, or delete downloaded items.





1. Swipe the screen up and touch .
2. Touch  > **Downloads**.

Figure 128 Files - Downloads Screen

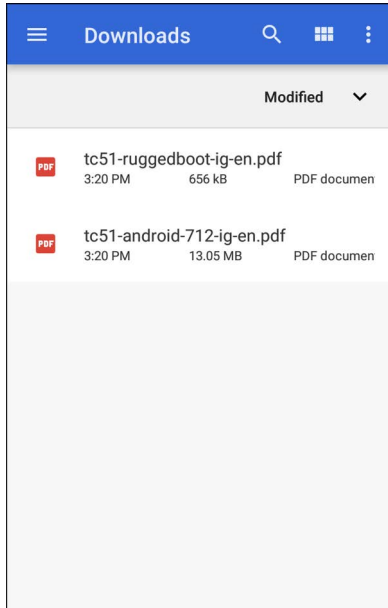

3. Touch and hold an item, select items to delete and touch . The item is deleted from the device.

# Maintenance and Troubleshooting

## Introduction

This chapter includes instructions on cleaning and storing the device, and provides troubleshooting solutions for potential problems during operation.

## Maintaining the Device

For trouble-free service, observe the following tips when using the device:

- To avoid scratching the screen, use a Zebra approved capacitive touch panel compatible stylus intended for use with a touch-sensitive screen. Never use an actual pen or pencil or other sharp object on the surface of the device screen.
- The touch-sensitive screen of the device is glass. Do not drop the device or subject it to strong impact.
- Protect the device from temperature extremes. Do not leave it on the dashboard of a car on a hot day, and keep it away from heat sources.
- Do not store the device in any location that is dusty, damp, or wet.
- Use a soft lens cloth to clean the device. If the surface of the device screen becomes soiled, clean it with a soft cloth moistened with an approved cleanser. For a list of approved cleansers, see Approved Cleanser Active Ingredients.
- Periodically replace the rechargeable battery to ensure maximum battery life and product performance. Battery life depends on individual usage patterns.

## Battery Safety Guidelines

- The area in which the units are charged should be clear of debris and combustible materials or chemicals. Particular care should be taken where the device is charged in a non commercial environment.
- Follow battery usage, storage, and charging guidelines found in this guide.
- Improper battery use may result in a fire, explosion, or other hazard.
- To charge the mobile device battery, the ambient battery and charger temperatures must be between +32°F and +104°F (0°C and +40°C).
- Do not use incompatible batteries and chargers, including non-Zebra batteries and chargers. Use of an incompatible battery or charger may present a risk of fire, explosion, leakage, or other hazard. If you have any questions about the compatibility of a battery or a charger, contact the Global Customer Support Center.
- For devices that utilize a USB port as a charging source, the device shall only be connected to products that bear the USB-IF logo or have completed the USB-IF compliance program.
- Do not disassemble or open, crush, bend or deform, puncture, or shred the battery.

- Severe impact from dropping any battery-operated device on a hard surface could cause the battery to overheat.
- Do not short circuit a battery or allow metallic or conductive objects to contact the battery terminals.
- Do not modify or remanufacture, attempt to insert foreign objects into the battery, immerse or expose to water or other liquids, or expose to fire, explosion, or other hazard.
- Do not leave or store the equipment in or near areas that might get very hot, such as in a parked vehicle or near a radiator or other heat source. Do not place battery into a microwave oven or dryer.
- Battery usage by children should be supervised.
- Please follow local regulations to properly dispose of used re-chargeable batteries.
- Do not dispose of batteries in fire.
- In the event of a battery leak, do not allow the liquid to come in contact with the skin or eyes. If contact has been made, wash the affected area with water for 15 minutes, and seek medical advice.
- If you suspect damage to your equipment or battery, contact Customer Support to arrange for inspection.

## Cleaning Instructions



**CAUTION:** Always wear eye protection.

Read warning label on alcohol product before using.

If you have to use any other solution for medical reasons please contact the Global Customer Support Center for more information.



**WARNING:** Avoid exposing this product to contact with hot oil or other flammable liquids. If such exposure occurs, unplug the device and clean the product immediately in accordance with these guidelines.

## Approved Cleanser Active Ingredients

100% of the active ingredients in any cleaner must consist of one or some combination of the following: isopropyl alcohol, bleach/sodium hypochlorite<sup>1</sup> (see important note below), or mild dish soap.



**IMPORTANT:** Use pre-moistened wipes and do not allow liquid cleaner to pool.

<sup>1</sup>When using sodium hypochlorite (bleach) based products, always follow the manufacturer's recommended instructions: use gloves during application and remove the residue afterwards with a damp alcohol cloth or a cotton swab to avoid prolonged skin contact while handling the device.

Due to the powerful oxidizing nature of sodium hypochlorite, the metal surfaces on the device are prone to oxidation (corrosion) when exposed to this chemical in the liquid form (including wipes). In the event that these type of disinfectants come in contact with metal on the device, prompt removal with an alcohol-dampened cloth or cotton swab after the cleaning step is critical.

## Harmful Ingredients

The following chemicals are known to damage the plastics on the device and should not come in contact with the device: acetone; ketones; ethers; aromatic and chlorinated hydrocarbons; aqueous or alcoholic alkaline solutions; ethanolamine; toluene; trichloroethylene; benzene; carbolic acid and TB-lysoform.

Many vinyl gloves contain phthalate additives, which are often not recommended for medical use and are known to be harmful to the housing of the device.

### Device Cleaning Instructions

Do not apply liquid directly to the device. Dampen a soft cloth or use pre-moistened wipes. Do not wrap the device in the cloth or wipe, instead gently wipe the unit. Be careful not to let liquid pool around the display window or other places. Before use, allow the unit to air dry.



**NOTE:** For thorough cleaning, it is recommended to first remove all accessory attachments, such as hand straps or cradle cups, from the mobile device and to clean them separately.

### Special Cleaning Notes

The device should not be handled while wearing vinyl gloves containing phthalates, or before hands are washed to remove contaminant residue after gloves are removed.

If products containing any of the harmful ingredients listed above are used prior to handling the device, such as hand sanitizer that contain ethanolamine, hands must be completely dry before handling the device to prevent damage to the device.



**IMPORTANT:** If the battery connectors are exposed to cleaning agents, thoroughly wipe off as much of the chemical as possible and clean with an alcohol wipe. It is also recommended to install the battery in the terminal prior to cleaning and disinfecting the device to help minimize buildup on the connectors.

When using cleaning/disinfectant agents on the device, it is important to follow the directions prescribed by the cleaning/disinfectant agent manufacturer.

### Cleaning Materials Required

- Alcohol wipes
- Lens tissue
- Cotton-tipped applicators
- Isopropyl alcohol
- Can of compressed air with a tube.

### Cleaning Frequency

The cleaning frequency is at the customer's discretion due to the varied environments in which the mobile devices are used and may be cleaned as frequently as required. When dirt is visible, it is recommended to clean the mobile device to avoid build up of particles which make the device more difficult to clean later on.

### Cleaning the Device

#### Housing

Thoroughly wipe the housing, including all buttons and triggers, using an approved alcohol wipe.

#### Display

The display can be wiped down with an approved alcohol wipe, but care should be taken not to allow any pooling of liquid around the edges of the display. Immediately dry the display with a soft, non-abrasive cloth to prevent streaking.

### Exit Window

Wipe the exit window periodically with a lens tissue or other material suitable for cleaning optical material such as eyeglasses.

### Cleaning Battery Connectors

To clean the battery connectors:

1. Remove the main battery from the mobile computer.
2. Dip the cotton portion of the cotton-tipped applicator in isopropyl alcohol.
3. To remove any grease or dirt, rub the cotton portion of the cotton-tipped applicator back-and-forth across the connectors on the battery and terminal sides. Do not leave any cotton residue on the connectors.
4. Repeat at least three times.
5. Use a dry cotton-tipped applicator and repeat steps 3 and 4. Do not leave any cotton residue on the connectors.
6. Inspect the area for any grease or dirt and repeat the cleaning process if necessary.



**CAUTION:** After cleaning the battery connectors with bleach-based chemicals, follow the Battery Connector Cleaning instructions to remove bleach from the connectors.

### Cleaning Cradle Connectors

To clean the connectors on a cradle:

1. Remove the DC power cable from the cradle.
2. Dip the cotton portion of the cotton-tipped applicator in isopropyl alcohol.
3. Rub the cotton portion of the cotton-tipped applicator along the pins of the connector. Slowly move the applicator back-and-forth from one side of the connector to the other. Do not leave any cotton residue on the connector.
4. All sides of the connector should also be rubbed with the cotton-tipped applicator.
5. Remove any lint left by the cotton-tipped applicator.
6. If grease and other dirt can be found on other areas of the cradle, use a lint-free cloth and alcohol to remove.
7. Allow at least 10 to 30 minutes (depending on ambient temperature and humidity) for the alcohol to air dry before applying power to cradle.

If the temperature is low and humidity is high, longer drying time is required. Warm temperature and low humidity requires less drying time.



**CAUTION:** After cleaning the cradle connectors with bleach-based chemicals, follow the Cleaning Cradle Connectors instructions to remove bleach from the connectors.



## Troubleshooting

### MC93XX

The following tables provides typical problems that might arise and the solution for correcting the problem.

Table 10 Troubleshooting the MC93XX

Problem	Cause	Solution
When pressing the power button the device does not turn on.	Battery not charged.	Charge or replace the battery in the device.
	Battery not installed properly.	Install the battery properly.
	System crash.	Perform a reset.
When pressing the power button the device does not turn on but LED bar blinks.	Battery charge is at a level where data is maintained but battery should be re-charged.	Charge or replace the battery in the device.
Battery did not charge.	Battery failed.	Replace battery. If the device still does not operate, perform a reset.
	Device removed from cradle while battery was charging.	Insert device in cradle. The 7,000 mAh battery fully charges in less than five hours at room temperature.
	Extreme battery temperature.	Battery does not charge if ambient temperature is below 0°C (32°F) or above 40°C (104°F).
Cannot see characters on display.	Device not powered on.	Press the Power button.
During data communication with a host computer, no data transmitted, or transmitted data was incomplete.	Device removed from cradle or disconnected from host computer during communication.	Replace the device in the cradle, or reattach the communication cable and re-transmit.
	Incorrect cable configuration.	See the system administrator.
	Communication software was incorrectly installed or configured.	Perform setup.
During data communication over Wi-Fi, no data transmitted, or transmitted data was incomplete.	Wi-Fi radio is not on.	Turn on the Wi-Fi radio.
	You moved out of range of an access point.	Move closer to an access point.

Table 10 Troubleshooting the MC93XX

Problem	Cause	Solution
During data communication over Bluetooth, no data transmitted, or transmitted data was incomplete.	Bluetooth radio is not on.	Turn on the Bluetooth radio.
	You moved out of range of another Bluetooth device.	Move within 10 meters (32.8 feet) of the other device.
No sound.	Volume setting is low or turned off.	Adjust the volume.
Device shuts off.	Device is inactive.	The display turns off after a period of inactivity. Set this period to 15 seconds, 30 seconds, 1, 2, 5, 10 or 30 minutes.
	Battery is depleted.	Replace the battery.
Tapping the window buttons or icons does not activate the corresponding feature.	The device is not responding.	Reset the device.
A message appears stating that the device memory is full.	Too many files stored on the device.	Delete unused memos and records. If necessary, save these records on the host computer (or use an SD card for additional memory).
	Too many applications installed on the device.	Remove user-installed applications on the device to recover memory. Select <b>⚙ &gt; Storage &gt; FREE UP SPACE &gt; REVIEW RECENT ITEMS</b> . Select the unused program(s) and tap <b>FREE UP</b> .
The device does not decode with reading bar code.	Scanning application is not loaded.	Load a scanning application on the device or enable DataWedge. See the system administrator.
	Unreadable bar code.	Ensure the symbol is not defaced.
	Distance between exit window and bar code is incorrect.	Place the device within proper scanning range.
	Device is not programmed for the bar code.	Program the device to accept the type of bar code being scanned. Refer to the EMDK or DataWedge application.
	Device is not programmed to generate a beep.	If the device does not beep on a good decode, set the application to generate a beep on good decode.
	Battery is low.	If the scanner stops emitting a laser beam upon a trigger press, check the battery level. When the battery is low, the scanner shuts off before the device low battery condition notification. Note: If the scanner is still not reading symbols, contact the distributor or the Global Customer Support Center.

Table 10 Troubleshooting the MC93XX

Problem	Cause	Solution
Device cannot find any Bluetooth devices nearby.	Too far from other Bluetooth devices.	Move closer to the other Bluetooth device(s), within a range of 10 meters (32.8 feet).
	The Bluetooth device(s) nearby are not turned on.	Turn on the Bluetooth device(s) to find.
	The Bluetooth device(s) are not in discoverable mode.	Set the Bluetooth device(s) to discoverable mode. If needed, refer to the device's user documentation for help.
Cannot unlock device.	User enters incorrect password.	If you enter an incorrect password eight times, you are requested to enter a code before trying again. If you forgot the password, contact your system administrator.
Battery pack communication error.	The battery is not inserted properly.	Remove and reinsert the battery into the device.
	The battery is properly inserted, however, when the terminal is in an active vibration environment or has fallen from a high vantage point (more than 8 ft), it might interrupt battery communication.	Remove and reinsert the battery into the device.
	The battery communication pin is damaged.	Remove the battery and insert a new battery into the device.

## 1-Slot USB Charge Cradle

Table 11 Troubleshooting the 1-Slot USB Charge Cradle

Symptom	Possible Cause	Action
LEDs do not light when device or spare battery is inserted.	Cradle is not receiving power.	Ensure the power cable is connected securely to both the cradle and to AC power.
	Device is not seated firmly in the cradle.	Remove and re-insert the device into the cradle, ensuring it is firmly seated.
	Spare battery is not seated firmly in the cradle.	Remove and re-insert the spare battery into the charging slot, ensuring it is firmly seated.

Table 11 Troubleshooting the 1-Slot USB Charge Cradle (Continued)

Symptom	Possible Cause	Action
Device battery is not charging.	Device was removed from cradle or cradle was unplugged from AC power too soon.	Ensure cradle is receiving power. Ensure device is seated correctly. Confirm main battery is charging.
	Battery is faulty.	Verify that other batteries charge properly. If so, replace the faulty battery.
	The device is not fully seated in the cradle.	Remove and re-insert the device into the cradle, ensuring it is firmly seated.
	Extreme battery temperature.	Battery does not charge if ambient temperature is below 0 °C (32 °F) or above 40 °C (104 °F).
Spare battery is not charging.	Battery not fully seated in charging slot.	Remove and re-insert the spare battery in the cradle, ensuring it is firmly seated. The 4,620 mAh battery fully charges in less than five hours.
	Battery inserted incorrectly.	Re-insert the battery so the charging contacts on the battery align with the contacts on the cradle.
	Battery is faulty.	Verify that other batteries charge properly. If so, replace the faulty battery.

## 4-Slot Charge Only Cradle

Table 12 Troubleshooting the 4-Slot Charge only Cradle

Symptom	Possible Cause	Action
LEDs do not light when device or spare battery is inserted.	Cradle is not receiving power.	Ensure the power cable is connected securely to both the cradle and to AC power.
	Device is not seated firmly in the cradle.	Remove and re-insert the device into the cradle, ensuring it is firmly seated.
	Spare battery is not seated firmly in the cradle.	Remove and re-insert the spare battery into the charging slot, ensuring it is firmly seated.
Device battery is not charging.	Device was removed from cradle or cradle was unplugged from AC power too soon.	Ensure cradle is receiving power. Ensure device is seated correctly. Confirm main battery is charging.
	Battery is faulty.	Verify that other batteries charge properly. If so, replace the faulty battery.
	The device is not fully seated in the cradle.	Remove and re-insert the device into the cradle, ensuring it is firmly seated.
	Extreme battery temperature.	Battery does not charge if ambient temperature is below 0 °C (32 °F) or above 40 °C (104 °F).

Table 12 Troubleshooting the 4-Slot Charge only Cradle (Continued)

Symptom	Possible Cause	Action
Spare battery is not charging.	Battery not fully seated in charging slot.	Remove and re-insert the spare battery in the cradle, ensuring it is firmly seated. The 4,620 mAh battery fully charges in less than five hours.
	Battery inserted incorrectly.	Re-insert the battery so the charging contacts on the battery align with the contacts on the cradle.
	Battery is faulty.	Verify that other batteries charge properly. If so, replace the faulty battery.
Jamming of the device.	Incorrect placement of the device into the cradle.	Remove and re-insert the device properly into the cradle slot.

## 4-Slot Ethernet ShareCradle Troubleshooting

Table 13 Troubleshooting the 4-Slot Ethernet ShareCradle

Symptom	Possible Cause	Action
During data communication, no data was transmitted, or transmitted data was incomplete.	Device removed from cradle during communication.	Replace the device in the cradle and retransmit.
	Incorrect cable configuration.	See the system administrator.
	Communication software is not installed or configured properly.	See the system administrator.
No data or communication of Device with network	Ethernet Setting is not turned ON or Incorrect IP setting (Static/Dynamic) or Incorrect Proxy Setting	Check the network connectivity (LED indicator or Cradle), or <-> icon in notifications.  Turn Ethernet ON or Add correct IP setting (Static/Dynamic). or Enter correct proxy settings.

## 4-Slot Spare Battery Charger Troubleshooting

Table 14 Troubleshooting the 4-Slot Battery Charger

Problem	Cause	Solution
Spare Battery Charging LED does not light when spare battery is inserted.	Spare battery is not correctly seated.	Remove and re-insert the spare battery into the charging slot, ensuring it is correctly seated.
Spare Battery not charging.	Charger is not receiving power.	Ensure the power cable is connected securely to both the charger and to AC power.
	Spare battery is not correctly seated.	Remove and re-insert the battery into the battery adapter, ensuring it is correctly seated.
	Battery adapter is not seated properly.	Remove and re-insert the battery adapter into the charger, ensuring it is correctly seated.
	Battery was removed from the charger or charger was unplugged from AC power too soon.	Ensure charger is receiving power. Ensure the spare battery is seated correctly. If a battery is fully depleted, it can take up to five hours to fully recharge a Standard Battery and it can take up to eight hours to fully recharge an Extended Life Battery.
	Battery is faulty.	Verify that other batteries charge properly. If so, replace the faulty battery.

## 16-Slot Spare Battery Charger Troubleshooting

Table 15 Troubleshooting the 16-Slot Battery Charger

Problem	Cause	Solution
Spare Battery Charging LED does not light when spare battery is inserted.	Spare battery is not correctly seated.	Remove and re-insert the spare battery into the charging slot, ensuring it is correctly seated.

Table 15 Troubleshooting the 16-Slot Battery Charger (Continued)

Problem	Cause	Solution
Spare Battery not charging.	Charger is not receiving power.	Ensure the power cable is connected securely to both the charger and to AC power.
	Spare battery is not correctly seated.	Remove and re-insert the battery into the battery adapter, ensuring it is correctly seated.
	Battery adapter is not seated properly.	Remove and re-insert the battery adapter into the charger, ensuring it is correctly seated.
	Battery was removed from the charger or charger was unplugged from AC power too soon.	Ensure charger is receiving power. Ensure the spare battery is seated correctly. If a battery is fully depleted, it can take up to five hours to fully recharge a Standard Battery and it can take up to eight hours to fully recharge an Extended Life Battery.
	Battery is faulty.	Verify that other batteries charge properly. If so, replace the faulty battery.

## USB Charge/Com Snap-on Cup Troubleshooting

Table 16 Troubleshooting the USB Charge/Com Snap-on Cup

Problem	Cause	Solution
USB connection to Pig Tail.	Improper Pogo connection from the USB Charge/Com Snap-on Cup to the device.	Ensure the side latches are intact so that the device correctly contacts with the Pogo pins of the USB Charge/Com Snap-on Cup.
USB connection from PC/Laptop to USB cable on the Pig Tail.	Improper connection from the PC/Laptop to the USB cable on the Pig Tail.	Ensure proper connection between PC/Laptop and the USB receptacle of the Pig Tail.

# Specifications

## Introduction

The following sections provide technical specification for the device.

## MC93XX Technical Specifications

The following table summarizes the MC93XX's intended operating environment and technical hardware specifications.

Table 17 MC93XX Technical Specifications

Item	Description
<b>Physical Characteristics</b>	
Dimensions	9.4 in L x 3.45 in W x 7.4 in H 240 mm L x 88 mm W x 189 mm H
Weight	26.9 oz./765g with battery
Display	4.3" WVGA (800 x 480), color display
Imager Window	Corning® Gorilla® Glass
Touch Panel	Dual mode capacitive touch with finger, gloved finger or stylus input (conductive stylus sold separately), Screen Protector, Corning® Gorilla® Glass touch panel with air gap (standard model) or optically bonded (freezer model).
Backlight	LED backlight display
Battery	7000mAh PowerPrecision+ standard battery 5000mAh PowerPrecision+ freezer battery 7000mAh PowerPrecision+ non-incendive battery
Expansion Slot	User accessible microSD slot. Supports up to 32 GB microSDHC and up to 256 GB microSDXC.
Network Connections	USB 2.0 High Speed (Host & Client), WLAN and WPAN (Bluetooth)
Notification	Audible tone; Multi-color LED bar (between keyboard and display), and haptic feedback.
Keypad Options	53 Key Standard, 53 Key Terminal Emulation (VT, 5250, and 3270), 43 Key Shifted Alpha, 34 Key Numeric, 58-Keys OmniiXT15f, and 29-Keys Shifted Alpha.



## Specifications

Table 17 MC93XX Technical Specifications (Continued)

Item	Description
Voice	Speaker, Microphone, PTT Voice (Internal Speaker and Bluetooth Wireless Headset Support).
Audio	Speaker
<b>Performance Characteristics</b>	
CPU	Qualcomm Snapdragon™ 660 octa-core, 2.2 GHz
Operating System	Android 8.1 Oreo with Zebra's Restricted Mode for control over GMS and other services.
Memory	4 GB RAM/32 GB Flash pSLC.
Output Power (USB)	USB: 5 VDC @ 500 mA max.
<b>User Environment</b>	
Operating Temperature	Standard: -4°F to 122°F/-20°C to +50°C Freezer: -22°F to 122°F/-30°C to +50°C
Storage Temperature	-40°F to 158°F/-40°C to 70°C
Charging Temperature	0°C to 40°C (32°F to 104°F)
Humidity	Standard: 5% to 95%, non-condensing Freezer: 5% to 95%, condensing
Drop Specification	<b>Standard:</b> 8 ft. (2.4m) drops to concrete across temperature per MIL-STD-810G. <b>Freezer:</b> 7 ft. (2.1m) drops to concrete across temperature per MIL-STD-810G.
Tumble Specification	4,000 3.3 ft. (1m) tumbles; meets and exceeds IEC tumble specification.
Sealing	IP67 and IP65 per IEC sealing specification.
Vibration	4 g's PK Sine (5 Hz to 2 kHz); 0.04 g 2/Hz Random (20 Hz to 2 kHz); 60 minute duration per axis, 3 axis
Thermal Shock	-40°C to 70°C (-40°F to 158°F) rapid transition.
Electrostatic Discharge (ESD)	+/-15kVdc air discharge +/-8kVdc direct discharge +/-8kVdc indirect discharge
<b>Interactive Sensor Technology (IST)</b>	
Ambient Light Sensor	Ambient light sensor used to auto adjust display and keyboard back light brightness.
Motion Sensor	3-axis accelerometer provides motion-sensing for dynamic screen orientation.
<b>Wireless LAN Data Communications</b>	
Radio	IEEE 802.11 a/b/g/n/ac/d/h/i/r/k/w; Wi-Fi certified; IPv4, IPv6, 2x2 MU-MIMO
Data Rates	<b>5GHz:</b> 802.11a/n/ac — up to 866.7 Mbps <b>2.4GHz:</b> 802.11b/g/n — up to 300 Mbps

## Specifications

Table 17 MC93XX Technical Specifications (Continued)

Item	Description
Operating Channels	Channel 1-13 (2412-2472 MHz); Chan 36-165 (5180-5825 MHz) Channel Bandwidth: 20, 40, 80 MHz Actual operating channels/ frequencies and bandwidths depend on regulatory rules and certification agency.
Security and Encryption	WEP (40 or 104 bit); WPA/WPA2 Personal (TKIP and AES); WPA/WPA2 Enterprise (TKIP and AES) - EAP-TTLS (PAP, MSCHAP, MSCHAPv2), EAP-TLS, PEAPv0-MSCHAPv2, PEAPv1-EAP-GTC and LEAP, EAP-PWD Data in Motion: FIPS 140-2 Level 1 Data at Rest: FIPS 140-2 Level 1
Certifications	WFA (802.11n, WMM-PS, 802.11ac, PMF, WMM-AC, Voice Enterprise, WiFi Direct and WPS 2.0)
Fast Roam	PMKID caching; Cisco CCKM; 802.11r; OKC
<b>Wireless PAN Data</b>	
Bluetooth	Class II, Bluetooth V5.0 with BR/EDR and Bluetooth Low Energy (BLE) Support
<b>Communication and Messaging</b>	
Workforce Connect PTT Express (included) provides instant push-to-talk small group communications across Wi-Fi networks. Workforce Connect PTT Pro (supported) provides a scalable network agnostic push-to-talk solution which also includes messaging, location services and two-way radio integration. Workforce Connect Voice client (supported) enables the MC9300 to function as a full featured mobile telephone with multi-line capability across Wi-Fi networks.	
<b>Device Approvals and Compliance</b>	
TAA (Optional on select configurations)	Trade Agreement Act optional on select configurations Complaint, FIPS 140-2 (DIM & DAR) support; FIPS 140-2 Level 1: Data in Motion and Data at Rest
Non-Incendive (NI) (Optional on select configurations)	Suitable for use in Class I, II, III Div 2 Safety: cULus Listing - ISA/ANSA 12.12.01 Gases: Class I - Groups A, B, C, D Dusts: Class II - Groups F, G Fibers & Flyings: Class III -20°C ≤ Ta ≤ +50°C T6
<b>Peripherals and Accessories</b>	
Cradles	Single slot USB/Charge, Four-slot charger only.
Battery Chargers	4-slot battery charger and 16-slot battery charger.
Other Accessories	USB/charge snap-on cup, forklift holder, soft holster, screen protector, hand strap, stylus

## Specifications

Table 17 MC93XX Technical Specifications (Continued)

Item	Description
<b>Data Capture</b>	
Scanning	<p><b>SE965:</b> 1D standard range scan engine.</p> <p><b>SE4750-SR:</b> Standard Range omnidirectional 1D/2D imaging engine reads 1D and 2D symbols. (Premium only).</p> <p><b>SE4850-ER:</b> Extended range omnidirectional 1D/2D imaging engine reads 1D and 2D symbols.</p> <p><b>SE4750DPM:</b> Omnidirectional 1D and 2D imaging engine reads Direct Part Marking.</p> <p><b>SE4750DPW:</b> Omnidirectional 1D and 2D imaging engine reads wide 1D and Direct Part Marking.</p> <p><b>SE4770-SR:</b> Standard range next generation omnidirectional 1D/2D imaging engine.</p>
Camera	<p><b>Front:</b> 5MP fixed focus and 2.0 aperture.</p> <p><b>Rear:</b> 13MP autofocus, 2.2 aperture, flash LED generates balanced white light, support torch mode, and supports rear camera barcode scanning.</p>
Near Field Communications (NFC)	Tap to Pair, ISO 14443 Type A and B, FeliCa cards in Reader Mode, ISO 15693 cards, P2P mode and Card Emulation via Host (HCE) support.
<b>Data Capture Options</b>	
Laser Decode Capability	Code 39, Code 128, Code 93, Codabar, Code 11, Discrete 2 of 5, Interleaved 2 of 5, EAN-8, EAN-13, MSI, UPCA, UPCE, UPC/EAN supplementals, Coupon Code, Trioptic 39, Webcode, RSS-14, RSS Limited, RSS Expanded, Chinese 2 of 5
Imaging Decode Capability	Code 39, Code 128, Code 93, Codabar, Code 11, Interleaved 2 of 5, Discrete 2 of 5, MSI, EAN-8, EAN-13, UPCA, UPCE, UPC/EAN supplementals, Coupon Code, Trioptic 39, Webcode, TLC39, Composite AB, Composite C, Micro PDF-417, PDF-417, Macro PDF-417, (Macro) Micro PDF-417, QR Code, RSS Expanded, RSS Limited, RSS-14, Data Matrix, Maxi Code, US Postnet, US Planet, UK 4-state, Australian 4-state, Canadian 4-state, Japanese 4-state, Dutch Kix, Chinese 2 of 5, USPS 4-state (US4CB), Aztec, microQR, Dotcode

### SE965 Decode Zone

The following table lists the typical distances for selected barcode densities. The minimum element width (or “symbol density”) is the width in mils of the narrowest element (bar or space) in the symbol.

*Table 18 SE965 Decode Distances*

Symbol Density/ Barcode Type	Typical Working Ranges	
	Near	Far
5.0 mil Code 128	1.2 in 3.05 cm	7.7 in 19.56 cm
5.0 mil Code 39	1.2 in 3.05 cm	12.5 in 31.75 cm
7.5 mil Code 39	1.1 in 2.79 cm	18.5 in 46.99 cm
10 mil Code 128	1.2 in * 3.05 cm	19.0 in 48.26 cm
13 mil 100% UPC	1.6 in 4.06 cm	27.0 in 68.58 cm
15 mil Code 128	1.0 in * 2.54 cm	29.5 in 74.93 cm
20 mil Code 39	1.4 in * 3.56 cm	52.0 in 132.08 cm
55 mil Code 39	3.4 in * 8.63 cm	100.0 in 254.00 cm
100 mil Code 39	2.0 ft * 60.96 cm	17 ft 518.16 cm
<p><b>NOTE:</b>                      * Dependent upon width of barcode.                      Working range specifications at temperature = 23°C, pitch=18°, roll=0°, skew=0°, photographic quality, ambient light ~150 ft-c, humidity 45-70% RH.                      Distances measured from front edge of scan engine chassis.</p>		

## SE4750-SR Decode Zone

The following table lists the typical distances for selected barcode densities. The minimum element width (or “symbol density”) is the width in mils of the narrowest element (bar or space) in the symbol.

Table 19 SE4750-SR Decode Distances

Symbol Density/ Barcode Type	Typical Working Ranges	
	Near	Far
3.0 mil Code 39	2.8 in 7.11 cm	6.2 in 15.74 cm
5.0 mil Code 128	2.3 in 5.84 cm	8.6 in 21.84 cm
5.0 mil PDF417	3.0 in 7.62 cm	8.1 in 20.57 cm
6.67 mil PDF417	2.2 in 5.58 cm	10.6 in 26.92 cm
10. mil Data Matrix	2.4 in 6.09 cm	10.6 in 26.92 cm
100% UPCA	1.6 in * 4.06 cm	23.0 in 58.42 cm
15 mil Code 128	2.4 in * 6.09 cm	25.2 in 64.00 cm
20 mil Code 39	1.6 in * 4.06 cm	36.6 in 92.96 cm
<b>NOTE:</b> *Limited by width of barcode in field of view.		

## SE4770-SR Decode Zone

The following table lists the typical distances for selected bar code densities.

Table 20 SE4770-SR Decode Distances

Symbol Density/ Barcode Type	Typical Working Ranges	
	Near	Far
3 mil Code 39	3.0 in 7.62 cm	5.8 in 14.73 cm
5 mil Code 128	2.3 in 5.84 cm	9.8 in 24.89 cm
5 mil PDF417	3.0 in 7.62 cm	7.9 in 20.06 cm
6.67 mil PDF 417	2.5 in 6.35 cm	10.1 in 25.65 cm
10 mil DataMatrix	2.1 in 5.33 cm	11.0 in 27.94 cm
100% UPCA	1.6 in * 4.06 cm	24.9 in 63.24 cm
15 mil Code 128	2.4 in * 6.09 cm	27.8 in 70.61 cm

Table 20 SE4770-SR Decode Distances (Continued)

Symbol Density/ Barcode Type	Typical Working Ranges	
	Near	Far
20 mil Code 39	1.6 in * 4.06 cm	36.1 in 91.69 cm
20 mil QR	1.1 in 2.79 cm	17.5 in 44.45 cm
<p><b>NOTE:</b> * Limited by width of bar code in field of view. Photographic quality bar code at 18° tilt pitch angle under 30 fcd ambient illumination. Distances measured from front edge of scan engine chassis.</p>		

## SE4850-ER Decode Zone

The following table lists the typical distances for selected barcode densities. The minimum element width (or “symbol density”) is the width in mils of the narrowest element (bar or space) in the symbol.

Table 21 SE4850-ER Decode Distances

Symbol Density/ Barcode Type	Typical Working Ranges	
	Near	Far
10 mil Code 39	3.0 in * 7.2 cm	85.0 in 215.90 cm
13 100% UPC	3.5 in 8.89 cm	90.0 in 228.60 cm
15 mil Code 128	6.0 in * 15.24 cm	100.0 in 254.00 cm
20 mil Code 39	4.0 in * 10.16 cm	172.0 in 436.88 cm
40 mil Code 39	6.0 in * 15.24 cm	340.0 in ** 863.60 cm
55 mil Code 39	7.0* in * 17.78* cm	430.0 in ** 1092.20 cm
100 mil Code 39 (paper)	20.0* in * 50.80* cm	700.0 in ** 1778.00 cm
100 mil Code 39 (reflective)	30.0 in * 66.20 cm	700.0 in 1778.00 cm
DataMatrix 10	5.0 in 12.70 cm	45.0 in 114.30 cm
DataMatrix 55	5.0 in 12.70 cm	250.0 in 635.00 cm
15 mil Code 128 (4 in. wide)	8.0 in * 20.32 cm	100.0 in 254.00 cm
<p><b>NOTE:</b> * Depends on the width of the bar code (shorter bar codes can be read even closer, and wider bar codes farther). ** Range is reduced under low ambient light level.</p>		

## I/O Connector Pin-Outs

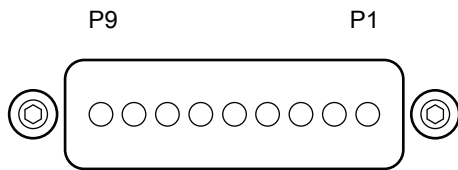

Table 22 I/O Connector Pin-Outs

Pin	Signal	Description
1	Ground	Ground pin connected to the Cradle or USB Charge Cable ground.
2	USB D-	USB OTG data signal negative.
3	USB D+	USB OTG data signal positive.
4	USB PWR	Power supply from USB Charging Cable.
5	Batt_Det_C	Connected with 1k $\Omega$ resistor to Ground in the battery pack.
6	Cradle_PWR	DC Power supply from the Cradle.
7	USB_CC2	Used by USB_CC2 following USB type-C specification for USB 2.0.
8	USB_CC1	Used by USB_CC1 following USB type-C specification for USB 2.0.
9	GND	Ground pin connected to the Cradle or USB Charge Cable ground.

## MC93XX Accessory Specifications

### 1-Slot USB Charge Cradle with Spare Battery Charger Technical Specifications

Table 23 1-Slot USB Charge Cradle with Spare Battery Charger Technical Specifications

Item	Description
Dimensions	Height: 87.9 mm (3.46 in) Width: 152.4 mm (6.00 in) Depth: 159.4 mm (6.28 in)
Weight	522 g (18.41 oz)
Input Voltage	12 VDC
Power Consumption	28 watts
Operating Temperature	0°C to 40°C (32°F to 104°F)
Storage Temperature	-40°C to 70°C (-40°F to 158°F)
Charging Temperature	0°C to 40°C (32°F to 104°F)

## Specifications

Table 23 1-Slot USB Charge Cradle with Spare Battery Charger Technical Specifications (Continued)

Item	Description
Humidity	5% to 95% non-condensing
Drop	75 cm (30 in.) to concrete; 2 drops/side for a total of 12 drops at room temperature (23°C).
Electrostatic Discharge (ESD)	+/- 15 kV air +/- 8 kV contact +/- 8 kV indirect discharge

### 4-Slot Charge Only ShareCradle Technical Specifications

Table 24 4-Slot Charge Only ShareCradle Technical Specifications

Item	Description
Dimensions	Height: 116.5 mm (4.59 in) Width: 152.4 mm (6.00 in) Depth: 132.7 mm (5.22 in)
Weight	1879 g (66.28 oz)
Input Voltage	12 VDC
Power Consumption	63 watts
Operating Temperature	0°C to 40°C (32°F to 104°F)
Storage Temperature	-40°C to 70°C (-40°F to 158°F)
Charging Temperature	0°C to 40°C (32°F to 104°F)
Humidity	5% to 95% non-condensing
Drop	75 cm (30 in.) to concrete; 2 drops/side for a total of 12 drops at room temperature (23°C).
Electrostatic Discharge (ESD)	+/- 15 kV air +/- 8 kV contact +/- 8 kV indirect discharge

### 4-Slot Ethernet ShareCradle Technical Specifications

Table 25 4-Slot Ethernet ShareCradle Technical Specifications

Item	Description
Dimensions	Height: 116.5 mm (4.59 in) Width: 489.0 mm (19.25 in.) Depth: 132.7 mm (5.22 in)
Weight	2070 g (37.67 oz)
Input Voltage	12 VDC
Power Consumption	80 watts



## Specifications

Table 25 4-Slot Ethernet ShareCradle Technical Specifications (Continued)

Item	Description
Operating Temperature	0°C to 40°C (32°F to 104°F)
Storage Temperature	-40°C to 70°C (-40°F to 158°F)
Charging Temperature	0°C to 40°C (32°F to 104°F)
Humidity	5% to 95% non-condensing
Drop	75 cm (30 in.) to concrete; 2 drops/side for a total of 12 drops at room temperature (23°C).
Electrostatic Discharge (ESD)	+/- 15 kV air +/- 8 kV contact +/- 8 kV indirect discharge

### 4-Slot Spare Battery Charger Technical Specifications

Table 26 4-Slot Spare Battery Charger Technical Specifications

Item	Description
Dimensions	Height: 104.4 mm (4.11 in.) Width: 121.9 mm (4.80 in.) Depth: 142.4 mm (5.61 in.)
Weight	619.3 g (21.85 oz)
Input Voltage	12 VDC
Power Consumption	30 watts
Operating Temperature	0°C to 40°C (32°F to 104°F)
Storage Temperature	-40°C to 70°C (-40°F to 158°F)
Charging Temperature	0°C to 40°C (32°F to 104°F)
Humidity	5% to 95% non-condensing
Drop	75 cm (30 in.) to concrete; 2 drops/side for a total of 12 drops at room temperature (23°C).
Electrostatic Discharge (ESD)	+/- 15 kV air +/- 8 kV contact +/- 8 kV indirect discharge

## 16-Slot Spare Battery Charger Technical Specifications

Table 27 16-Slot Spare Battery Charger Technical Specifications

Item	Description
Dimensions	Height: 104.9 mm (4.13 in.) Width: 489.0 mm (19.25 in.) Depth: 142.4 mm (5.61 in.)
Weight	2480 g (87.48 oz)
Input Voltage	12 VDC
Power Consumption	106 watts
Operating Temperature	0°C to 40°C (32°F to 104°F)
Storage Temperature	-40°C to 70°C (-40°F to 158°F)
Charging Temperature	0°C to 40°C (32°F to 104°F)
Humidity	5% to 95% non-condensing
Drop	75 cm (30 in.) to concrete; 2 drops/side for a total of 12 drops at room temperature (23°C).
Electrostatic Discharge (ESD)	+/- 15 kV air +/- 8 kV contact +/- 8 kV indirect discharge

## USB Charge/Com Snap-on Cup Technical Specifications

Table 28 USB Charge Cable Technical Specifications

Item	Description
Dimensions	Height: 55.8 mm (2.19 in.) Width (with cable): 199.5 mm (7.85 in.) Depth 52.8mm (2.07 in.)
Weight	76.1 g (2.68 oz)
Input Voltage	5 VDC
Power Consumption	12 watts
Operating Temperature	0°C to 50°C (32°F to 104°F)
Storage Temperature	-40°C to 70°C (-40°F to 158°F)
Charging Temperature	0°C to 40°C (32°F to 104°F)
Humidity	5% to 95% non-condensing
Drop	75 cm (30 in.) to concrete; 2 drops/side for a total of 12 drops at room temperature (23°C).
Electrostatic Discharge (ESD)	+/- 15 kV air +/- 8 kV contact +/- 8 kV indirect discharge

# Index

## A

accessories	28
advanced data formatting rules	124
approved cleanser	170
approved cleanser active ingredients	170
apps	
RxLogger	76
RxLogger Utility	83

## B

backup power	24
barcode input	100
enabled	100
battery safety guidelines	169

## C

charge only adapter	48
cleaning	170, 171
battery connectors	172
camera and exit window	172
cradle connectors	172
display	171
frequency	171
housing	171
instructions	170
materials	171
cleaning instructions	171
cradle	
connector cleaning	172

## D

data capture plus	98
datawedge	
advanced data formatting rules	124
APIs	136
associating applications	96
auto import	135
auto switch to default on event	100

barcode input	100
basic scanning	91
configuration and profile file management	135
configuring ADF plug-in	124
creating a new profile	95
data capture plus	98
decoders	101
disabling	95
enterprise folder	135
exporting a configuration file	134
importing a configuration file	133
input plugins	93
intent output	118
intent overview	119
introduction	91
IP output	120
keep enabled on suspend	116
keystroke output	117
multibarcodes params	116
options menu	94
output plug-ins	93
plug-ins	92
process plug-ins	93
profile configuration	95
profile context menu	94
profile0	92
profiles	92
profiles screen	93
programming notes	135
reader params	112
reporting	136
scan params	115
scanner selection	100
settings	132
UDI params	116
UPC EAN params	109
voice input	116
decode zones	185
decoder params	
Codabar	104
Code 11	104
Code 128	104

- Code 39 ..... 105
  - Code 93 ..... 106
  - Composite AB ..... 106
  - decode lengths ..... 109
  - Discrete 2 of 5 ..... 106
  - DotCode ..... 106
  - GS1 DataBar Limited ..... 107
  - HAN XIN ..... 107
  - Interleaved 2 of 5 ..... 107
  - Matrix 2 of 5 ..... 107
  - MSI ..... 108
  - Trioptic 39 ..... 108
  - UK Postal ..... 108
  - UPCA ..... 108
  - UPCE0 ..... 108
  - UPCE1 ..... 109
  - US Planet ..... 109
  - decoders ..... 101
  - disconnect host computer ..... 90
- F**
- file transfer ..... 89
- H**
- hand strap ..... 54
  - harmful ingredients ..... 170
  - hot swap mode ..... 24
- I**
- install microSD card ..... 17
- M**
- maintenance ..... 169
    - approved cleanser active ingredients ..... 170
    - battery safety guidelines ..... 169
    - clean battery connectors ..... 172
    - clean camera and exit window ..... 172
    - clean cradle connectors ..... 172
    - clean display ..... 171
    - clean housing ..... 171
    - cleaning frequency ..... 171
    - cleaning instructions ..... 170
    - cleaning materials required ..... 171
    - device cleaning instructions ..... 171
    - harmful ingredients ..... 170
    - maintaining the device ..... 169
    - special cleaning notes ..... 171
  - multibarcodes params ..... 116
- N**
- notational conventions ..... 13
- P**
- photo transfer ..... 90
- R**
- reader params ..... 112
  - rubber boot ..... 52
  - RxLogger ..... 76
    - configuration ..... 77
    - configuration file ..... 82
    - disable logging ..... 82
    - enable logging ..... 82
    - extract log files ..... 83
  - RxLogger Utility ..... 83
- S**
- scan params ..... 115
  - sensors ..... 181
  - settings
    - datawedge ..... 132
  - setup ..... 16
  - software version ..... 13
  - software versions ..... 12
- T**
- transferring files using USB ..... 89
  - troubleshooting ..... 173
- U**
- UDI params ..... 116
  - UPC EAN params ..... 109
  - USB ..... 89
- V**
- voice input ..... 116
- W**
- Wi-Fi direct ..... 69
  - WPS pin entry ..... 71
  - WPS push button ..... 70

