



by Schneider Electric

Installation Guide Smart-UPS™ On-Line SRT3000/SRT2200 UXI-LI/UXI-NCLI

Important Safety Messages

SAVE THESE INSTRUCTIONS - This manual contains important instructions that should be followed during installation and maintenance of the Smart-UPS.

Read the instructions carefully to become familiar with the equipment before attempting to install, operate, service or maintain the UPS. The following special messages may appear throughout this manual or on the equipment to warn of potential hazards or to call attention to information that clarifies or simplifies a procedure.



The addition of this symbol either to a “Danger” or “Warning” safety label indicates that an electrical hazard exists which will result in personal injury if the instructions are not followed.



This is the safety alert symbol. It is used to alert you to potential personal injury hazards. Obey all safety messages that follow this symbol to avoid possible injury or death.

DANGER

DANGER indicates a hazardous situation which, if not avoided, will result in death or serious injury.

WARNING

WARNING indicates a hazardous situation which, if not avoided, could result in death or serious injury.

CAUTION

CAUTION indicates a hazardous situation which, if not avoided, could result in minor or moderate injury.

NOTICE

NOTICE is used to address practices not related to physical injury.

Product Handling Guidelines



<18 kg
<40 lb



18-32 kg
40-70 lb



32-55 kg
70-120 lb



>55 kg
>120 lb



Safety and General Information

- Adhere to all national and local electrical codes.
- All wiring must be performed by a qualified electrician.
- Changes and modifications to this unit not expressly approved by APC could void the warranty.
- This UPS is intended for indoor use only.
- Do not operate this UPS in direct sunlight, in contact with fluids, or where there is excessive dust or humidity.
- Be sure the air vents on the UPS are not blocked. Allow adequate space for proper ventilation.
- For a UPS with a factory installed power cord, connect the UPS power cable directly to a wall outlet. Do not use surge protectors or extension cords.
- The battery typically lasts for five to eight years. Environmental factors impact battery life. Elevated ambient temperatures, poor quality mains power, and frequent short duration discharges will shorten battery life.
- Replace the battery immediately when the UPS indicates battery replacement is necessary.
- The equipment is heavy. Always practice safe lifting techniques adequate for the weight of the equipment.
- Always install XLBPs at the bottom in rack-mount configurations. The UPS must be installed above the XLBPs.
- Always install peripheral equipment above the UPS in rack-mount configurations.
- Additional safety information can be found in the Safety Guide supplied with this unit.

Deenergizing safety

- Battery packs connected to the UPS may present a shock hazard even when disconnected from the main branch circuit (mains).
- Before installing or servicing the equipment check that the:
 - Mains circuit breaker is in the **OFF** position. The UPS is disconnected from the mains or wall outlet.
 - Battery packs are disconnected.

Electrical safety

- In order to maintain compliance with the EMC directive for products sold in Europe, output cords attached to the UPS must not exceed 10 meters in length.
- The protective earth conductor for the UPS carries the leakage current from the load devices (computer equipment). An insulated ground conductor is to be installed as part of the branch circuit that supplies the UPS. The conductor must have the same size and insulation material as the grounded and ungrounded branch circuit supply conductors. The conductor will typically be green and with or without a yellow stripe.
- The UPS input ground conductor must be properly bonded to protective earth at the service panel.
- If the UPS input power is supplied by a separately derived system, the ground conductor must be properly bonded at the supply transformer or motor generator set.

Battery safety





- Schneider Electric uses Lithium Ion (NMC) batteries. Under normal use and handling, there is no contact with the internal components of the battery.
- **CAUTION:** Before installing or replacing the batteries, remove jewelry such as wristwatches and rings. High short circuit current through conductive materials could cause severe burns.
- **CAUTION:** Do not dispose of batteries in a fire. The batteries may explode.
- **CAUTION:** Do not open or mutilate battery pack enclosure. Doing so will expose the cell terminals which pose an energy hazard.

General information

- The UPS will recognize as many as 10 external battery packs connected to the UPS.
Note: For each battery pack added, increased recharge time will be required.
- The model and serial numbers are located on a small, rear panel label. For some models, an additional label is located on the chassis under the front bezel.
- Always recycle used batteries.
- Recycle the package materials or save them for reuse.

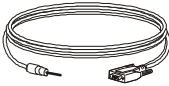
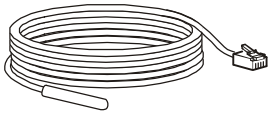
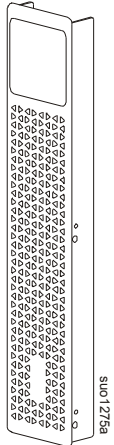
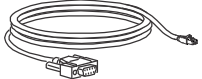
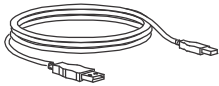
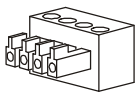
Package Contents

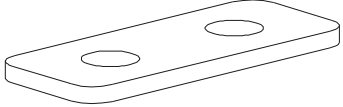
Inspect the contents upon receipt. Notify the carrier and dealer if the unit is damaged.

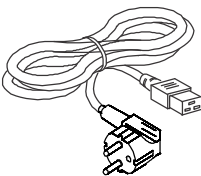
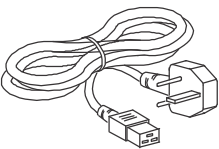
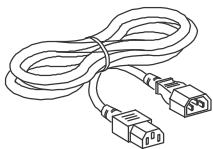
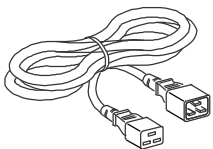
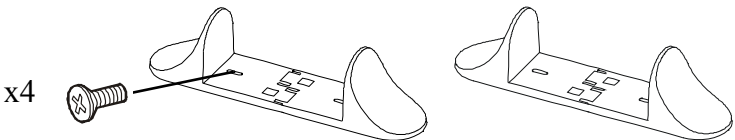
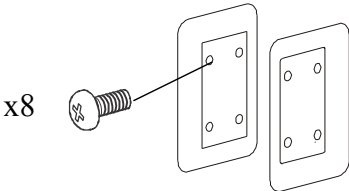
SRT3000/SRT2200 UXI-NCLI models only			
Network Management Utility CD 	Serial configuration cable 	Temperature sensor probe 	
All models			
Front bezel 	RJ45 to DB9 cable  USB cable  EPO Terminal block 	User Documentation CD.  PCBE Software CD 	2 tie brackets  4 flat head screws to secure tie brackets 
2 input power cords		1 output IEC jumper cable	1 output IEC jumper cable
			
<ul style="list-style-type: none"> • 1 pair stabilizer brackets • 4 flat head screws to secure tower stabilizer brackets to the UPS 		<ul style="list-style-type: none"> • 1 pair cleats • 8 pan head screws 	

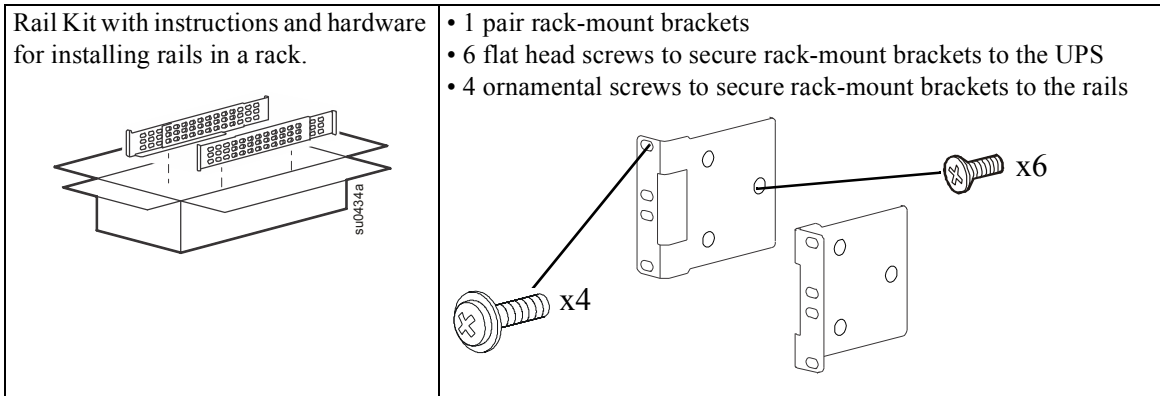

Specifications

For additional specifications refer to the APC by Schneider Electric web site, www.apc.com.

Environmental

Temperature	Operating	0° to 40° C (32° to 104° F)
	Storage	-15° to 45° C (5° to 113° F)
Elevation	Operating	0 - 3,000 m (0 - 10,000 ft)
	Storage	0 - 15,000 m (50,000 ft)
Humidity	0% to 95% relative humidity, non-condensing	
Protection Class	IP 20 rating	

Physical

The UPS is heavy. Follow all lifting guidelines.

Unit weight, without packaging	17.5 kg (38.5 lb)
Unit weight, with packaging	25 kg (55 lb)
Unit dimensions without packaging Height x Width x Depth	85 (2U) mm x 432 mm x 611 mm 3.35 (2U) in x 17 in x 24 in
Unit dimensions with packaging Height x Width x Depth	245 mm x 600 mm x 870 mm 9.7 in x 23.6 in x 34.3 in

The model and serial numbers are on a small label located on the rear panel.

Battery

WARNING

RISK OF CHEMICAL HAZARD AND EXCESSIVE HEAT

- Replace the battery pack at least every 8 years.
- Replace the battery pack immediately when the UPS indicates battery replacement is necessary.
- Replace battery pack at the end of its service life.
- Replace battery packs with the same type of batteries as originally installed in the equipment.
- Replace the battery packs immediately when the UPS indicates a battery over-temperature condition. Power off the UPS, unplug it from the AC input, and disconnect the battery packs. Do not operate the UPS until the battery packs have been replaced.

Failure to follow these instructions can result in minor or moderate injury

Battery type	Lithium Ion NMC chemistry
Typical energy capacity	600 watt-hours
Maximum continuous discharge rate	3 kW
Maximum charge rate Note: Battery pack will disconnect to protect cells if charge current exceeds 12 A. Note: Around 0° C, battery pack will automatically limit charge current to approximately 400 mA to protect the cells.	12 A
Battery capacity	12 Ah
Charge voltage for full capacity	58.1 VDC
Replacement battery pack Refer to the appropriate replacement battery user manual for installation instructions. Contact your dealer or go to the APC by Schneider Electric web site, www.apc.com for information on replacement battery pack.	XBP48RM1U2-LI Note: The UPS does not support any other type/make of battery packs.
Applicable UPS models	SRT3000UXI-NCLI SRT2200UXI-NCLI SRT3000UXI-LI SRT2200UXI-LI
Battery power cable length	600 mm (23.6 in)
Battery communication cable length	300 mm (11.8 in)

Electrical

CAUTION*: To reduce the risk of fire, connect the UPS only to a circuit provided with recommended maximum branch circuit overcurrent protection

Models	Rating	Building Circuit Breaker (CB) Current Rating
SRT3000 models	3000 VA / 2700 W	20 A
SRT2200 models	2200 VA / 1980 W	16 A

Output	
Output Frequency	50 Hz / 60 Hz
Nominal Output Voltage	220 V, 230 V, 240 V

Input	
Input Frequency	40 Hz - 70 Hz
Nominal Input Voltage	220 V, 230 V, 240 V
Input current rating	SRT3000 models: 16 A SRT2200 models: 13 A

Rack-Mount Installation

Refer to the Rail Kit Installation Guide for instructions on rail installation.

CAUTION

RISK OF FALLING EQUIPMENT

- The equipment is heavy. Always practice safe lifting techniques adequate for the weight of the equipment.
- Always use the recommended number of screws to secure brackets to the UPS.
- Always use the recommended number of screws to secure the UPS to the rack.
- Always install the UPS at the bottom of the rack.
- Always install the XLBP below the UPS in the rack.

Failure to follow these instructions can result in minor or moderate injury

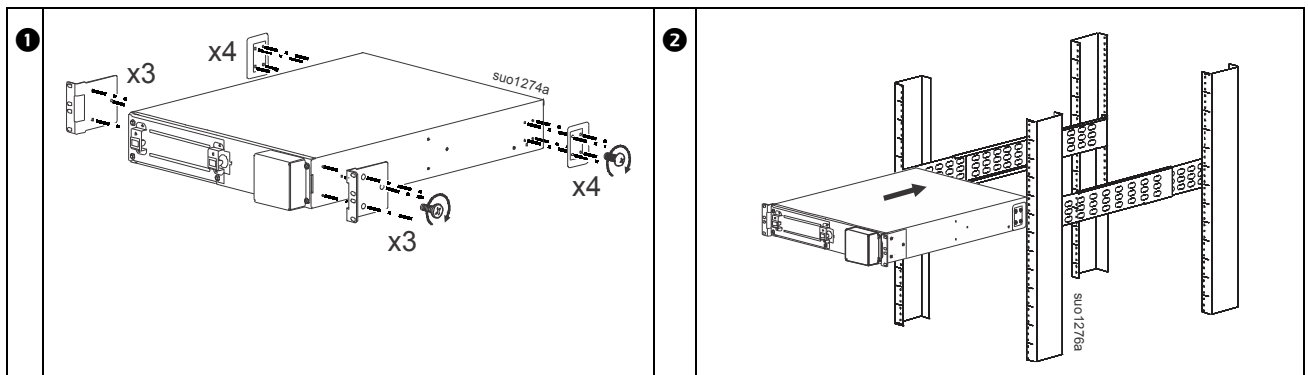

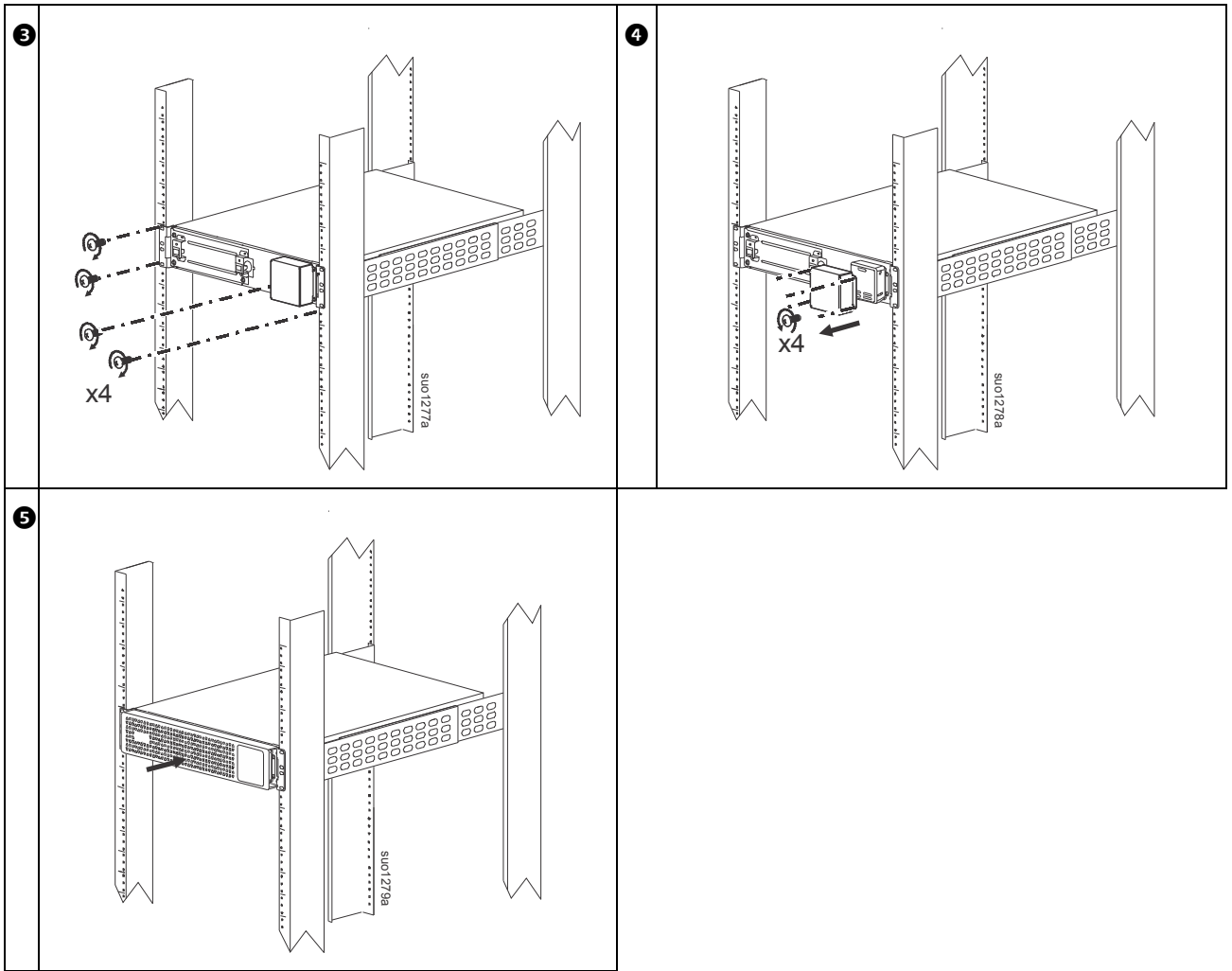

Tower Installation (limited to one battery pack)

⚠ CAUTION

RISK OF FALLING EQUIPMENT

- In the tower configuration, always mate one XLBP to the UPS.
- The equipment is heavy.
- Always practice safe lifting techniques adequate for the weight of the equipment.

Failure to follow these instructions can result in minor or moderate injury

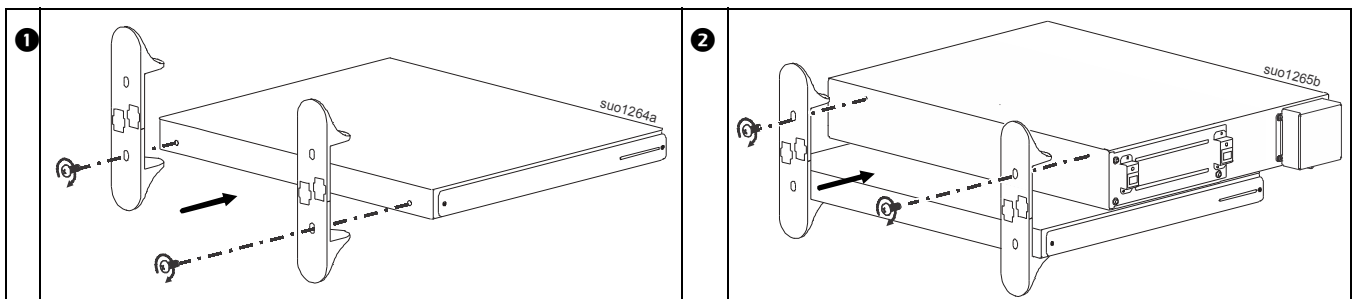

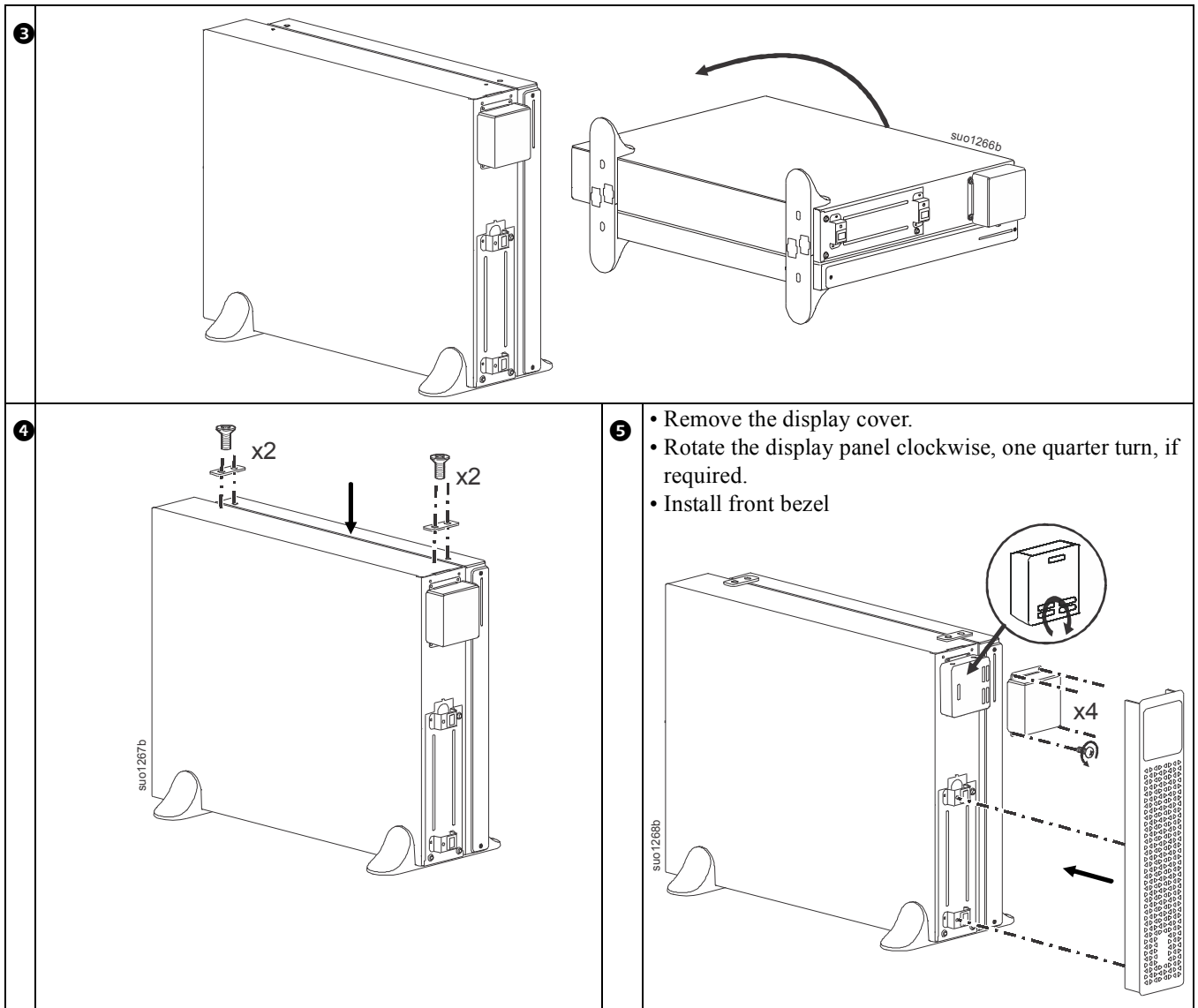

Note: Refer to the XLBP manual (990-91127x) for connections between the UPS and XLBP.

Rear Panel Features

Note: Refer to the table “Key to identify rear panel features” on page 9, that provides a key to the callout numbers for the rear panel graphics depicted in this manual.

SRT3000UXI-LI/SRT2200UXI-LI

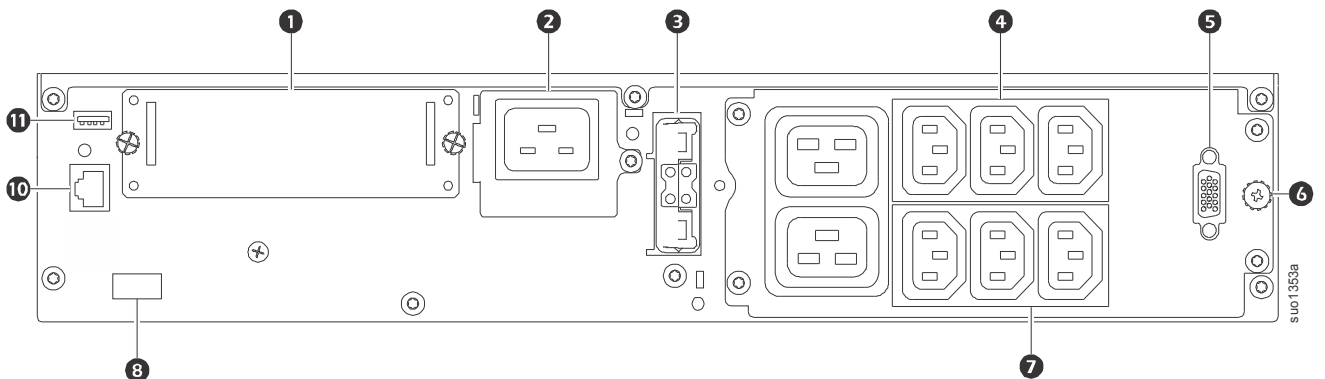

SRT3000UXI-NCLI/SRT2200UXI-NCLI

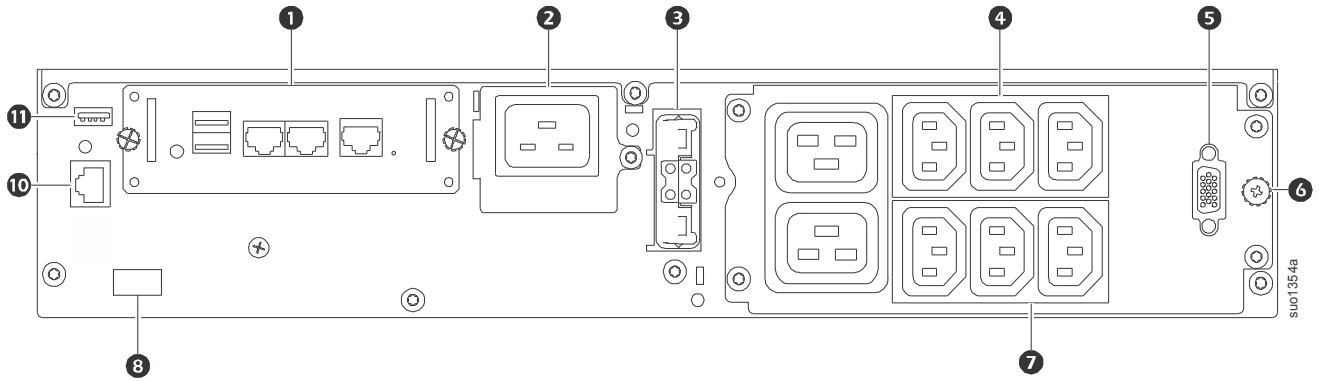

Key to identify rear panel features

①	SmartSlot	The SmartSlot can be used to connect optional management accessories. Note: SRT2200/SRT3000 UXI-NCLI models are pre-installed with network management card.
②	AC inlet	Connect the UPS to utility power supply..
③	Battery power and signal connector	Use the external battery cable on the XLBP to connect the UPS and XLBP. XLBPs provide extended runtime during power outages. The UPS will automatically recognize up to 10 external battery packs.
④	Controllable outlet group 1	Connect electronic devices to these outlets.
⑤	Battery communication port (DB15)	Connect the battery connection cable from the XLBP. This enables the communication between the XLBP and the UPS.
⑥	Chassis ground screws	The UPS and XLBPs have ground screws for connecting the ground leads. Prior to connecting a ground lead, disconnect the UPS from mains power.
⑦	Controllable outlet group 2	Connect electronic devices to these outlets.
⑧	EPO terminal	The Emergency Power Off (EPO) terminal allows the user to connect the UPS to a central EPO system.
⑩	Serial Com	The Serial Com port is used to communicate with the UPS. Use only interface kits supplied or approved by APC by Schneider Electric. Any other serial interface cable will be incompatible with the UPS connector.
⑪	USB port	The USB port is used to connect either a server for native operating system communications, or for software to communicate with the UPS.

UPS Configuration

Connect Emergency Power Off feature

For instructions on how to connect the Emergency Power Off (EPO) switch, refer to the Operation and Maintenance manual on the User Documentation CD (supplied).

Configure controllable outlet groups

The outlets on the UPS are grouped. To configure the controlled outlet features, use the **Advanced** menus on the display interface and navigate to: **Main Menu > Configuration > Outlets > Outlet Group**.

UPS Display Interface

<p>1 POWER ON/OFF button</p> <p>Button illumination indications:</p> <ul style="list-style-type: none"> -No illumination, the UPS and the output power are off -White illumination, the UPS and the output power are on -Red illumination, the UPS is on and the output power is off 	<p style="text-align: right;">su0870b</p>
<p>2 Load icon Disable/mute audible alarm icon</p>	
<p>3 UPS status information</p>	
<p>4 Operation mode icons</p>	
<p>5 ESCAPE button</p>	
<p>6 OK button</p>	
<p>7 UP/DOWN buttons</p>	
<p>8 Controllable outlet group status icons</p>	
<p>9 Battery status icons</p>	

Display interface operation

Use the UP/DOWN buttons to scroll through the options. Press the OK button to accept the selected option. Press the ESC button to return to the previous menu.

<p>The icons on the LCD display interface screen may vary depending on the installed firmware version.</p>	
	<p>Load icon: The approximate load capacity percentage is indicated by the number of load bar sections illuminated. Each bar represents 16% of the load capacity.</p>
	<p>Mute icon: Indicates the audible alarm is disabled/mute.</p>

UPS Status Information

The status information field provides key information on the status of the UPS.











The **Standard** menu will allow the user to select one of the five screens listed below. Use the UP/DOWN buttons to scroll through the screens.

The **Advanced** menu will scroll through the five screens automatically.

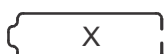
- **Input Voltage**
- **Output Voltage**
- **Output Frequency**
- **Load**
- **Runtime**

In the case of a UPS event, status updates will be displayed defining the event or condition that has occurred.

The display screen illuminates amber to indicate a Message and red to indicate an Alert depending on the severity of the event or condition.

Operation Mode Icons	
	On-Line mode: The UPS is supplying conditioned mains power to connected equipment.
	Bypass mode: The UPS is in Bypass mode and the connected equipment will receive mains power as long as the input voltage and frequency are within the configured limits.
	Green mode: When in Green mode mains power is sent directly to the load. In the event of a mains power outage, there will be an interruption in power to the load of up to 10 ms while the UPS switches to On-Line or Battery mode. When enabling Green mode consideration should be given to devices that may be sensitive to power fluctuations.
UPS Status Icon	
	Battery mode: The UPS is supplying battery power to connected equipment.
	The UPS has detected an internal fault with the battery. Follow the instructions on the screen.
	The UPS has detected a critical fault with the battery. The battery is at the end of its life and has to be replaced.
	Indicates a UPS alert that requires attention.
Controllable Outlet Group Icons	
	Controllable Outlet Group Power Available: The number next to the icon identifies the specific outlet groups that have available power. Flashing icon indicates the outlet group is turning from OFF to ON with delay.
	
	Controllable Outlet Group Power Not Available: The number next to the icon identifies specific outlet groups that do not have available power. Flashing icon indicates the outlet group is turning from ON to OFF with delay.
	
Battery Status Icons	
	Battery Charge Status: Indicates the battery charge status.

	<p>Battery Charge In Progress: Indicates the battery is charging.</p>
---	--

Menu overview

The display interface has **Standard** and **Advanced** menu screens. The preference for **Standard** or **Advanced** menu selections is made during initial installation and can be changed at any time through the **Configuration** menu.

The **Standard** menus include the most commonly used options.

The **Advanced** menus provide additional options.

Note: Actual menu screens may differ by model and firmware version.

Refer to the UPS Operation Manual for menu configuration details.

LCD display interface angle adjustment

The angle of the LCD display interface can be adjusted for ease in viewing the displayed messages.

1. Remove the front bezel.
2. Locate the button on the bottom of the display interface panel.
3. Press the button and slide the bottom of the LCD display interface screen out. An audible click will be heard when the screen reaches the maximum angle.

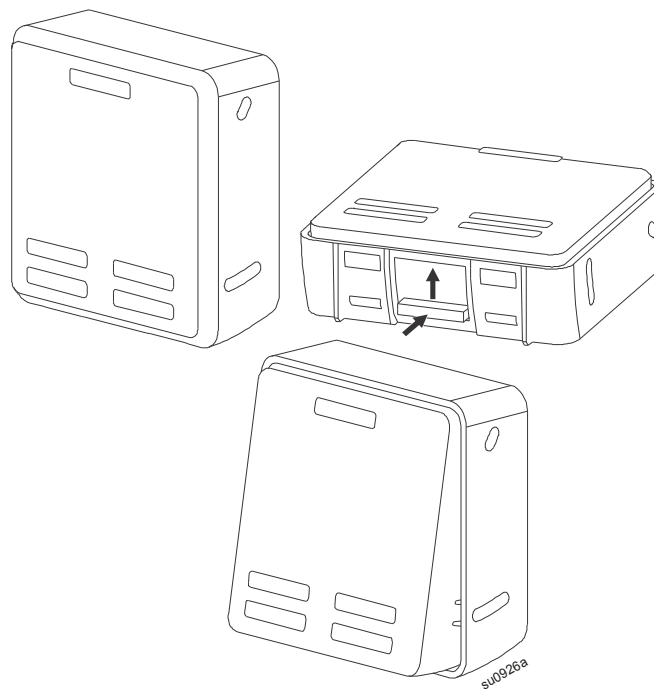

Customer support and warranty information are available on the APC by Schneider Electric web site, www.apc.com.

© 2018 APC by Schneider Electric. APC, the APC logo, and Smart-UPS are owned by Schneider Electric Industries S.A.S. or their affiliated companies. All other trademarks are property of their respective owners.

EN 990-91128
10/2018