



Cisco Aironet Series 2800/3800 Access Point Deployment Guide

First Published: 2016-05-11

Americas Headquarters

Cisco Systems, Inc.
170 West Tasman Drive
San Jose, CA 95134-1706
USA
<http://www.cisco.com>
Tel: 408 526-4000
800 553-NETS (6387)
Fax: 408 527-0883

THE SPECIFICATIONS AND INFORMATION REGARDING THE PRODUCTS IN THIS MANUAL ARE SUBJECT TO CHANGE WITHOUT NOTICE. ALL STATEMENTS, INFORMATION, AND RECOMMENDATIONS IN THIS MANUAL ARE BELIEVED TO BE ACCURATE BUT ARE PRESENTED WITHOUT WARRANTY OF ANY KIND, EXPRESS OR IMPLIED. USERS MUST TAKE FULL RESPONSIBILITY FOR THEIR APPLICATION OF ANY PRODUCTS.

THE SOFTWARE LICENSE AND LIMITED WARRANTY FOR THE ACCOMPANYING PRODUCT ARE SET FORTH IN THE INFORMATION PACKET THAT SHIPPED WITH THE PRODUCT AND ARE INCORPORATED HEREIN BY THIS REFERENCE. IF YOU ARE UNABLE TO LOCATE THE SOFTWARE LICENSE OR LIMITED WARRANTY, CONTACT YOUR CISCO REPRESENTATIVE FOR A COPY.

The Cisco implementation of TCP header compression is an adaptation of a program developed by the University of California, Berkeley (UCB) as part of UCB's public domain version of the UNIX operating system. All rights reserved. Copyright © 1981, Regents of the University of California.

NOTWITHSTANDING ANY OTHER WARRANTY HEREIN, ALL DOCUMENT FILES AND SOFTWARE OF THESE SUPPLIERS ARE PROVIDED "AS IS" WITH ALL FAULTS. CISCO AND THE ABOVE-NAMED SUPPLIERS DISCLAIM ALL WARRANTIES, EXPRESSED OR IMPLIED, INCLUDING, WITHOUT LIMITATION, THOSE OF MERCHANTABILITY, FITNESS FOR A PARTICULAR PURPOSE AND NONINFRINGEMENT OR ARISING FROM A COURSE OF DEALING, USAGE, OR TRADE PRACTICE.

IN NO EVENT SHALL CISCO OR ITS SUPPLIERS BE LIABLE FOR ANY INDIRECT, SPECIAL, CONSEQUENTIAL, OR INCIDENTAL DAMAGES, INCLUDING, WITHOUT LIMITATION, LOST PROFITS OR LOSS OR DAMAGE TO DATA ARISING OUT OF THE USE OR INABILITY TO USE THIS MANUAL, EVEN IF CISCO OR ITS SUPPLIERS HAVE BEEN ADVISED OF THE POSSIBILITY OF SUCH DAMAGES.

Any Internet Protocol (IP) addresses and phone numbers used in this document are not intended to be actual addresses and phone numbers. Any examples, command display output, network topology diagrams, and other figures included in the document are shown for illustrative purposes only. Any use of actual IP addresses or phone numbers in illustrative content is unintentional and coincidental.

Cisco and the Cisco logo are trademarks or registered trademarks of Cisco and/or its affiliates in the U.S. and other countries. To view a list of Cisco trademarks, go to this URL: <https://www.cisco.com/go/trademarks>. Third-party trademarks mentioned are the property of their respective owners. The use of the word partner does not imply a partnership relationship between Cisco and any other company. (1721R)

© 2016 Cisco Systems, Inc. All rights reserved.



CONTENTS

CHAPTER 1

Overview 1

CHAPTER 2

Choosing the Right Access Point 3

Models 3

Part Numbers and Descriptions 4

Supported Code Versions Compatible with AP 2800 and AP 3800 5

Differences between the AP 2800 and AP 3800 Access Points 5

Feature Differences 8

Ports on the AP 2800 and AP 3800 9

Modularity and Smart Antenna Connector Ports 10

CHAPTER 3

Physical Hardware and Mounting Options 13

Access Point Physical Hardware and Mounting Options 13

Channel Rail Adapters 14

Mounting an AP Directly into the Tile Using Optional AIR-AP-BRACKET-3 16

Using an In-tile Mount from Oberon Wireless 18

Wall-mounting the AP 18

Changing the Color of an AP 21

Clean Rooms (Healthcare) 22

Above the Ceiling Tiles 22

CHAPTER 4

Understanding Flexible Radio Assignment (software overview) 25

Understanding Flexible Radio Assignment (Software Overview) 25

Flexible Radio Architecture (FRA) System 26

CHAPTER 5

Client Roaming in a Micro and Macro Cell 27

Understanding Macro and Micro Cells 27

Client Roaming from a Macro to Micro Cell 29

Client Roaming from a Micro to Macro Cell 29
 Micro and Macro cells on “I” Series Access Points 30
 RF Operations on “E/P” Series Access Points 33

CHAPTER 6 **Approved Antennas for Use with Access Points 2800 and 3800 39**

CHAPTER 7 **AP 2800 and AP 3800 Powering Options 41**

CHAPTER 8 **AP 3800 and Multigigabit Ethernet (mGig) 47**

CHAPTER 9 **New-B Regulatory Domain for US Theater 51**

CHAPTER 10 **Stadium and Harsh Environments 53**

CHAPTER 11 **Areas with High Vibration 55**

CHAPTER 12 **Related References 57**
 Previous Deployment Guides 57

CHAPTER 13 **Frequently Asked Questions (FAQ's) 59**



Overview

This document covers the Cisco 2800/3800 Series Access Points theory of operation and installation as part of a Cisco wireless LAN (WLAN) solution. Subjects related include:

- Choosing the right access point, part numbers and descriptions
- Supported code versions
- Differences between AP 2800 and AP 3800
- Physicals / Hardware details, mounting options, bracket choices
- Third party mounting options including hospital and cleanroom environments
- Understanding Flexible Radio Assignment (FRA) and architecture
- Understanding Macro and Microcells
- Looking at roaming between cells
- Hardware differences in FRA between I, E and P versions
- Approved antennas and new FCC regulatory –B domain
- AP 2800 and AP 3800 powering options and requirements
- AP 3800 and Multigigabit Ethernet (mGig)



Choosing the Right Access Point

- [Models, page 3](#)
- [Part Numbers and Descriptions , page 4](#)
- [Supported Code Versions Compatible with AP 2800 and AP 3800 , page 5](#)
- [Differences between the AP 2800 and AP 3800 Access Points, page 5](#)
- [Feature Differences, page 8](#)
- [Ports on the AP 2800 and AP 3800 , page 9](#)
- [Modularity and Smart Antenna Connector Ports , page 10](#)

Models

The Cisco 2800 and 3800 Series Access Points target customers requiring support for mission-critical and best in class applications. The 2800/3800 embodies ClientLink 4.0, an innovative antenna technology comprising four transmit radios and four receive radios called 4x4 in a Multiple Input Multiple Output (MIMO) configuration and supporting three spatial streams (3SS), together referenced as **4x4:3**. Using this type of antenna system along with additional Modulation Coding Scheme (MCS) rates supporting up to 256 QAM and up to 160 MHz channel bonding, rates of up to 5 Gbps can be supported.

ClientLink 4.0 uses these features along with an additional antenna (N+1) to allow for beam-forming for all 802.11a/g/n/ac and now ac Wave-2 clients including those supporting 3 spatial streams.

Figure 1: Access Point Portfolio Placement



Access points are available in three models:

- Internal antennas version labeled “i” that has captured antennas (part of the housing and not removable). The “i” series is designed for indoor Enterprise installations where office aesthetics are a primary concern.
- External antennas version labeled “e” that is more rugged and designed for industrial use in locations such as hospitals, factories, and warehouses, anywhere a need exists for external antennas and/or extended operating temperatures. The “e” version also supports mounting inside NEMA enclosures for use in the most demanding environments.
- Access points for professional install are labeled “p” series and may be used in outdoor applications.

Part Numbers and Descriptions

SKU	Description
AIR-AP3802I-x-K9	Single Unit; Internal Antenna Model
AIR-AP3802I-xK910	10 pack; Internal Antenna Model
AIR-AP3802E-x-K9	Single Unit; External Antenna Model
AIR-AP3802E-xK910	10 pack; External Antenna Model
AIR-AP3802I-x-K9C	Single Unit; Internal Antenna Model; Configurable
AIR-AP3802I-xK910C	10 pack; Internal Antenna Model; Configurable

SKU	Description
AIR-AP3802E-x-K9C	Single Unit; External Antenna Model; Configurable
AIR-AP3802E-xK910C	10 pack; External Antenna Model; Configurable

Supported Code Versions Compatible with AP 2800 and AP 3800

The minimum versions supporting the AP 2800 and 3800 are:

- Wireless LAN Controller (WLC) AirOS release 8.2MR1
- Polaris release 16.3
- Prime release 3.1MR1
- MSE or CMX 10.2.2
- ISE 2.0

Differences between the AP 2800 and AP 3800 Access Points

The mechanical front of the AP 2800 and AP 3800 are nearly identical in physical appearance.

Figure 2: AP 2800 and AP 3800 (I and E) versions



The AP 3800 is also available in a "P" version. The external antenna "E" versions permit antenna gains up to 6 dBi, "P" version up to 13 dBi.

Figure 3: AP 2800/3800

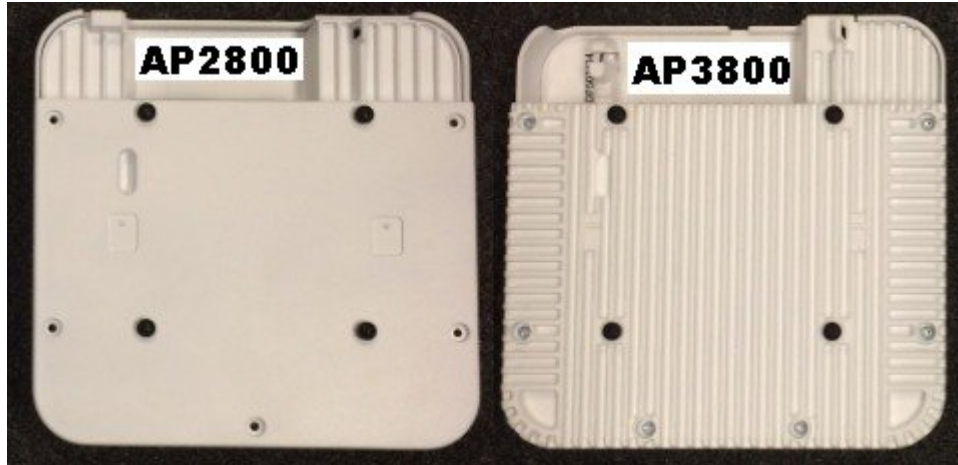

There are slight differences in the weight and thickness of the 2800 and 3800. The AP 3800 is a bit more robust as it has support for mGig (NBASE-T) and optional module support. AP 2800 on left is smooth and does not have heat fins.

Figure 4: AP 2800/3800 Dimensions

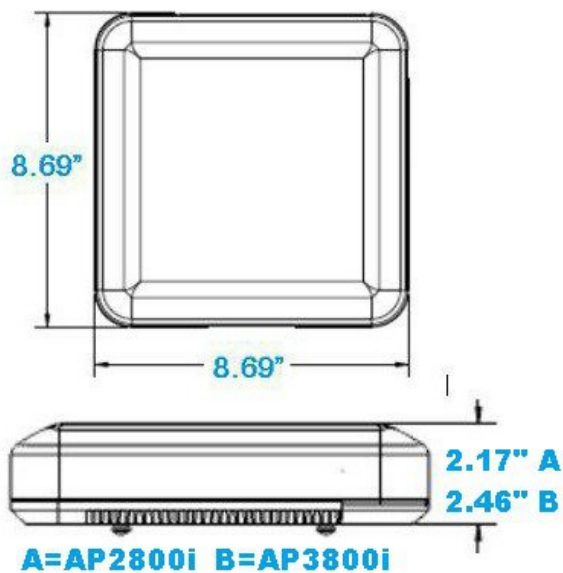

Depending on the model the thickness changes slightly.

Figure 5: AP 2800 and AP 3800 dimensions

Product ID	Length	Width	Height
AIR-AP3802I-X-K9	8.66" - 22cm	8.68" - 22cm	2.46" - 6.25cm
AIR-AP3802E-X-K9	8.67" - 22cm	8.68" - 22cm	2.62" - 6.7cm
AIR-AP3802P-X-K9	8.67" - 22cm	8.68" - 22cm	2.62" - 6.7cm
AIR-AP2802I-X-K9	8.66" - 22cm	8.68" - 22cm	2.17" - 5.5cm
AIR-AP2802E-X-K9	8.66" - 22cm	8.77" - 22cm	2.50" - 6.4cm



Note

The weight is slightly different between the models. AP 3800 both "E" and "P" versions as well as the 2800e is 2.1 kg. AP 3800i is 2.0 kg. AP 2800i is 1.6 kg.

Both products use the same brackets as 2700/3700 2700/3700 Series Access Points—AIR-AP-BRACKET1 and AIR-AP-BRACKET-2.

Feature Differences

Here is a basic feature comparison:

Figure 6: Feature comparisons of 2800 and 3800 series

	 Cisco Aironet 2800	 Cisco Aironet 3800
	Appliance & Virtualized Control	
MAX DATARATE	5Gbps.	5Gbps.
ANTENNAS: SPATIAL STREAMS.	4X4:3SS - 160MHz.	4X4:3SS - 160MHz.
GIGABIT - MULTIGIGABIT PORTS	2x1Gig	1Gig & 1MGig (1Gig, 2.5Gig, 5Gig)
USB 2.0 PORT	1	1
Spectrum Analysis	●	●
TX Beam Forming	●	●
CleanAir / ClientLink	●	●
Dual 5GHz Radios	●	●
Optimized Roaming	●	●
Flexible Radio Assignment "FRA"	●	●
Smart Antenna Connector "E&P" Series	●	●
Slide Mount Modularity		●

Ports on the AP 2800 and AP 3800

The AP 2800 is similar to the AP 3800 but lacks a local power supply input and mGig PoE port. Additionally, the USB port is mounted sideways.

Figure 7: Ports on 2800 series

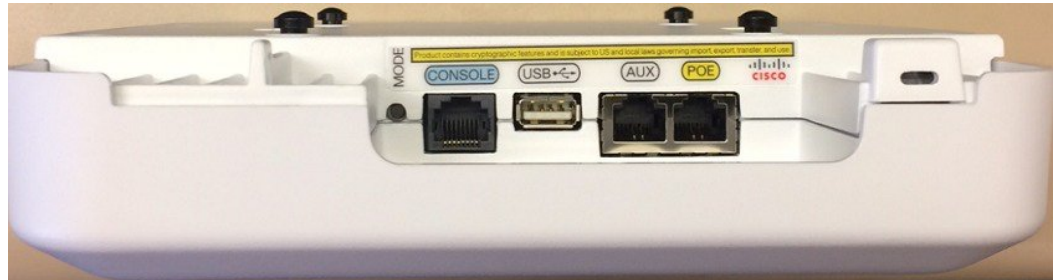
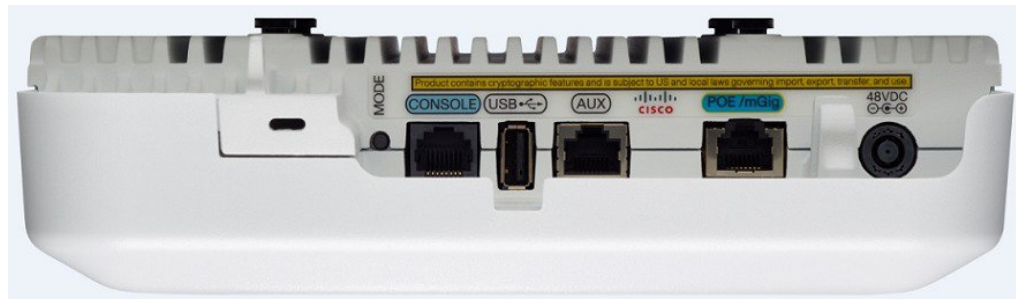

Figure 8: Ports on 3800 series



The AP 3800 has a local power supply jack on the right; This is a new style connector and is not compatible with the older AIR-PWR-B power supplies used with the AP 2700 and AP 3700 series. For more on this connector, see the [AP 2800 and AP 3800 Powering Options](#) for details.

In addition there is an mGig port as well as a port for external modules on the AP 3800.

Figure 9: External module port on the 3800 series



Modularity and Smart Antenna Connector Ports

The AP 3800 has modularity support that is a bit different from the original module design on the prior AP 3600 and AP 3700 series. This module design allows for installation onto the side of the access point. This allows for larger antenna arrays and does not constrict the development of Cisco and potentially third party modules as they are no longer limited by the physical size of the access point. Additionally, filtering is installed on the AP 3800 for cellular and other radio coexistence.

The external antenna connectors on the "E" and "P" series are identical to the antenna connectors on previous access points. There is no difference in operation when the access point is used in dual band (2.4 and 5 GHz) operation, which is the default mode. RF coverage and cell sizes are similar to the previous AP 2700 and 3700 series so there is no need to do a new site survey.

Unlike the prior external antenna versions, the new 2800 and 3800 series Access Points now support the capability of dual 5-GHz operation. When in this mode, a smart antenna connector must be used on the external antenna models, as the additional 5-GHz radio cannot use the same top antennas on the access point that are being used by the primary 5-GHz radio.

When a smart antenna connector is installed, the XOR radio (the radio that is defined in software as Radio 0) now has its RF switched to the smart antenna connector.

Figure 10: External connector ports on AP 2800e and 3800e





Physical Hardware and Mounting Options

- [Access Point Physical Hardware and Mounting Options, page 13](#)

Access Point Physical Hardware and Mounting Options

AP 2800 and AP 3800 have similar physical dimensions with only slight differences in physical appearance mostly to accommodate the different features like modularity and Multigigabit support resulting in slight differences in width.

There are many different installation options available depending upon the business requirements. Brackets are available from Cisco as well as third-party companies. During the ordering process, the customer may choose one of two brackets (but not both). Each bracket is a zero-dollar (\$0) option at the time of configuration. If the customer does not choose a bracket, the selection default is AIR-AP-BRACKET-1, which is the most popular for ceiling installations. The other choice is a universal bracket that carries part number AIR-AP-BRACKET-2.



Note

The AP 2800 and AP 3800 is noticeably heavier than the AP 2700 and AP 3700. This is due to the powerful design of the components used, which include a dual core processor, 12 radio transceivers, additional memory and processor power as well as additional Ethernet capability including mGig on the AP 3800 and optional module support.

The mounting brackets and ceiling rails easily handle the extra weight and the intent was to make a very robust Access Point without the need for vent holes and to allow the product to be used in industrial and manufacturing areas as well as commercial enterprise environments.

Figure 11: Access Point Bracket Choices

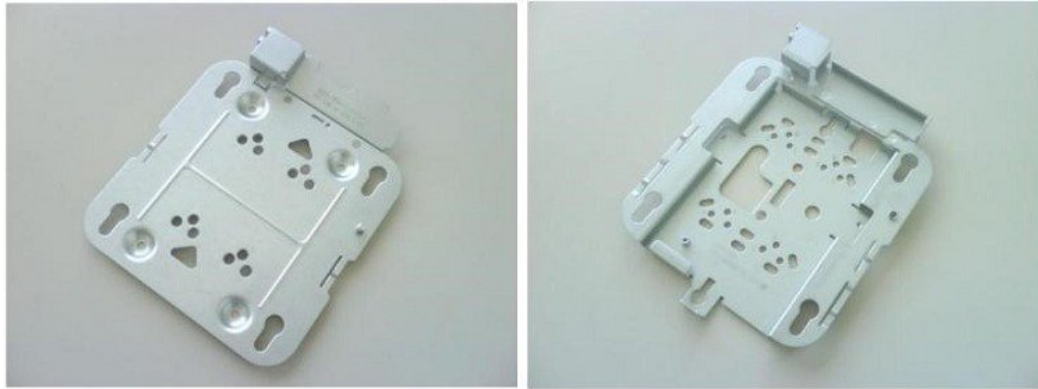

AIR-AP-BRACKET-1
AP Bracket: Low-Profile

AIR-AP-BRACKET-2
AP Bracket: Universal

If the AP will be mounted directly to a ceiling on the gridwork, then AIR-AP-BRACKET-1 mounts flush and has the lowest profile. However, if the AP will be mounted to an electrical box or other wiring fixture, or inside a NEMA enclosure or perhaps wall mounted, then AIR-AP-BRACKET-2 is a much better choice. The extra space in the bracket allows for wiring, and the extra holes line up with many popular electrical boxes. When mounting the bracket to the ceiling gridwork, some ceiling tiles are recessed. For this reason, two different styles of ceiling clips, recessed and flush rails, are available.

For new installations AIR-BRACKET-2 is recommended as it provides a little extra room and accommodates earlier access points with modules, so it truly is a universal bracket.

Figure 12: Different clips are available for attaching to ceiling grid work



AIR-AP-T-RAIL-R
Ceiling Grid Clip (Recessed)



AIR-AP-T-RAIL-F
Ceiling Grid Clip (Flush)

Channel Rail Adapters

When mounting APs to ceiling channel rails such as the ones shown in Figure 14, an optional channel adapter is used: AIR-CHNL-ADAPTER. It comes in a two-pack and attaches to the ceiling grid clip above.

Thin rail or sometimes referred to as recessed ceiling rails often look like as shown.

Figure 13: Example of a recessed ceiling rail system



Figure 14: Example of Channel Rails used on thin rail (recessed rail) ceilings

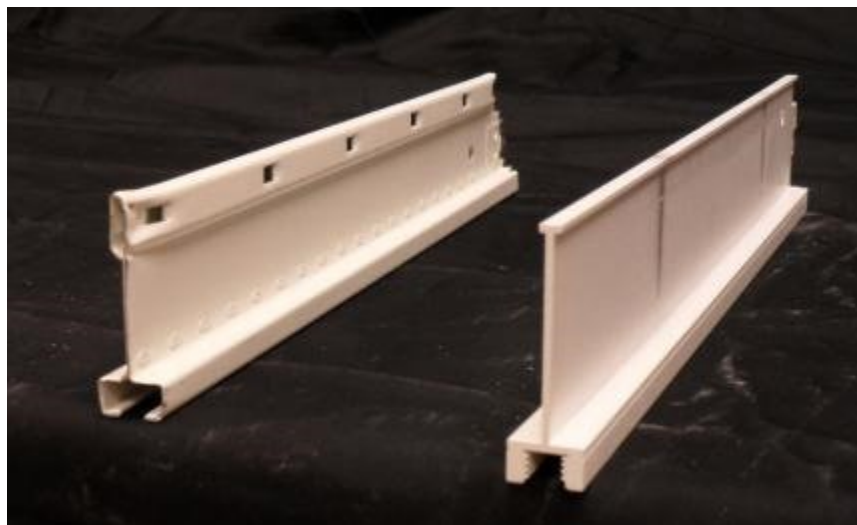

Figure 15: AIR-CHNL-ADAPTER (left) Slides onto the Rails

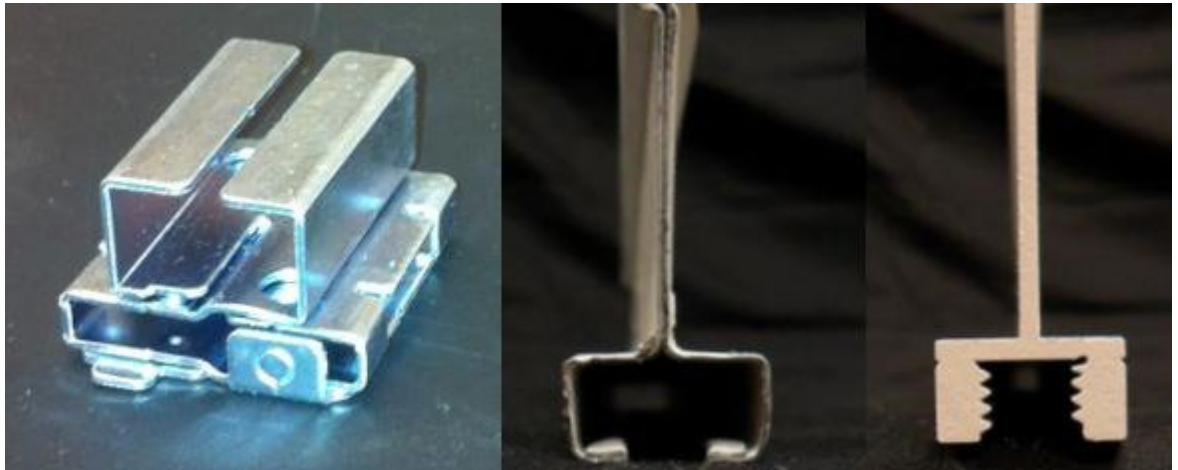

Figure 16: AIR-CHNL-ADAPTER Mounted to Rail Clip (left) and Finished Installation (right)



Note When ordered, part numbers are replacement numbers so they end with an "=".

AIR-AP-T-RAIL-R=Ceiling Grid Clip–Recessed

AIR-AP-T-RAIL-F=Ceiling Grid Clip–Flush

AIR-AP-BRACKET-1=AP Bracket–Low Profile

AIR-AP-BRACKET-2=AP Bracket –Universal

AIR-CHNL-ADAPTER=Additional Adapter for Channel–Rail Ceiling Grid profile

Mounting an AP Directly into the Tile Using Optional AIR-AP-BRACKET-3



Note This bracket is not compatible with the AP 2800 and AP 3800 Series.

If you have this bracket currently installed and are migrating to the newer AP 2800 and AP 3800 series, you may be able to still use the existing tile and leverage the new in-tile mount available from Oberon Wireless (a Cisco partner).

For completeness, here is an overview of the existing AIR-BRACKET-3 so you may understand it better should you encounter it within your deployments. Many hospitals and other carpeted Enterprise environments prefer a more streamlined look and wish to install the AP directly into the tile. This can be done on prior Cisco AP products using the optional Cisco AIR-AP-BRACKET-3.

When using this bracket, the "beauty ring" is used as the template to cut the tile which can be cut using a carpet knife or electric tool such as a rotary cutting tool, e.g., Dremel or Rotozip. Cisco does not offer custom cut tiles as there are simply too many different styles and the tiles are easy to cut.

The AP is fully supported above the tile with a metal rail that extends the length of the tile. This supports the AP should the tile become wet or otherwise fail. A mechanical set screw pulls the AP tight to the ceiling and locks it into the bracket. Additionally, physical security of the AP can be maintained by the use of a Kensington style lock, but once installed it is difficult to remove the AP without removing the tile as the AP will not slide out from the front side of the tile.

Figure 17: Optional AIR-AP-BRACKET-3 to install the AP directly into the tile

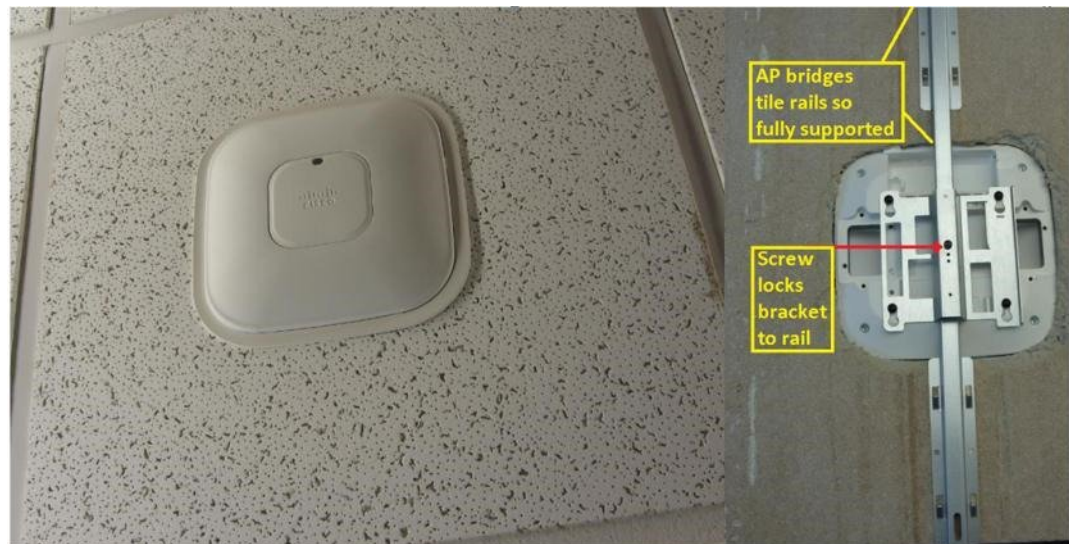

Note

This bracket fits the AP-1040, 1140, 1260, 1600, 2600, 3500, 3600 and 3700 Series Access Points; however, it is not compatible with the 2800 and 3800 series.

Using an In-tile Mount from Oberon Wireless

Figure 18: Oberon in tile and above tile mounting solutions

Third Party options to integrate into & above ceiling



Model 1045- Above ceiling hanger kit- this includes a hanger bar and wire, and a light pipe that can be pressed through the ceiling tile so you can see the status LED from below, without lifting ceiling tile

Recessed ceiling (in tile) mount for suspended ceilings being developed.

www.oberonwireless.com Phone (814) 867-2312

Additionally, Oberon offers a metal locking cabinet that allows the Access Point to be mounted flush to the ceiling, which is often used in hospital infection control areas or places where higher physical security is required.

Wall-mounting the AP

When wall mounting is desired, the installer should understand that walls can be a physical obstacle to the wireless signal; therefore, maintaining 360-degree coverage may be compromised by the wall. If the wall is an outside wall and/or the goal is to send the signal in a 180-degree pattern instead, a directional antenna often

referred to as a "patch" antenna may be a better choice assuming the AP 2800e or AP 3800e is used. Instead, use the AP 2800e or AP 3800e (with dipoles pointing vertical).

Figure 19: Correct orientation of dipole antennas when mounted on a vertical surface



Figure 20: Avoid wall mounting units with internal antennas



**Note**

Wall mounting units with internal antennas in the orientation shown in [Figure 20: Avoid wall mounting units with internal antennas](#) should be avoided. AP 2800i & AP 3800i should use the Oberon mounting bracket unless roaming is not an issue, example: hotspot, kiosk, or very small venue areas where large uniform coverage is not needed.

Figure 21: Third Party options to Wall Mount

Third Party options to Wall Mount



Oberon Model **1008-CCOAP** black right angle bracket with black vanity cover



Oberon has one that is similar to a “wedge”

Allows for hiding of Electrical box or cabling

www.oberonwireless.com Phone (814) 867-2312

Changing the Color of an AP

If there is a desire to change the color of an AP, rather than painting the AP which would void the warranty, consider using colored vinyl tape or using a colored plastic cover from Oberon.

Figure 22: Third-party option for changing AP color, adding custom Logo, or hiding the LED

Third Party options to change color



Oberon Model **1008-CCOAP** black right angle bracket with black vanity cover



Specifications:

- Fabricated from textured ABS plastic
- The skin is virtually transparent to access point radio frequency transmission.
- Attaches to access point with Velcro tabs (included)
- Available in five standard colors: Black, Dark Grey, Light Grey, Tan, Navy Blue
- Custom colors are available on request.

www.oberonwireless.com Phone (814) 867-2312

Clean Rooms (Healthcare)

Many hospitals and factories have requirements to wipe down or gently spray the environment with a chemical (often diluted liquid that has cleaning / disinfectant properties). The Cisco AP 2800 and AP 3800 are designed with a purpose-build Wi-Fi chipset using Enterprise and industrial class components. This enables the AP enclosure to have a Plenum rating and is vent-less, so the unit is ideal for these types of applications.



Note

The plastic material used on the AP 2800 and AP 3800 series is Lexan 945. This material was tested for clean room use with a Steris chemical, trademark name SPOR-KLENZ. See <http://www.sterislifesciences.com/Products/Surface-Disinfectants-Cleaners-and-Alcohols/Sporicides-Sterilant/Spor-Klenz-Ready-To-Use-Cold-Sterilant.aspx>

Figure 23: Third Party Locking Ceiling Mount



Above the Ceiling Tiles

The AP 2800 and 3800 are rated for installation in the Plenum area (UL-2043). Many customers prefer to locate the AP so that nothing can be visible on the ceiling. In some cases this is preferred for aesthetic reasons, so customers may install the AP above a drop ceiling. This also may be preferred in high theft areas such as classrooms or in areas where policy dictates that nothing can be visible on the ceiling.

When this is a hard requirement, optional T-Bar hanger accessories from third-party companies such as Erico and Cooper can be used. The Erico Caddy 512a or the Cooper B-Line BA50a or similar T-Bar Grid T-Bar hangers can be used.

Figure 24: Example of How to Hang an AP above the Ceiling Tiles

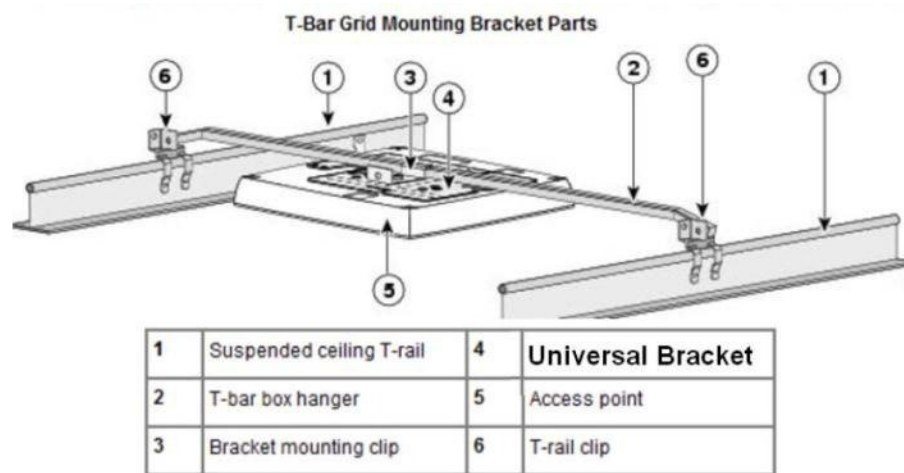

For more information see:

<http://www.erico.com/>

<http://www.cooperindustries.com/>

Additionally, Oberon also offers above tile solutions.

Figure 25: Oberon Model 1045- Above ceiling hanger kit - this includes a hanger bar and wire, and a light pipe that can be pressed through the ceiling tile so you can see the status LED from below, without lifting ceiling tile



**Note**

Installing APs above the ceiling tiles should only be done when mounting below the ceiling is not an option. The tiles must not be conductive; such installations can certainly degrade advanced RF features such as voice and location, so verify coverage and performance. Always try to mount the AP as close to the inside middle of the tile as possible, and avoid areas with obstructions.

Figure 26: Installing AP above ceiling tiles: Pick an area clear of obstructions, avoid ceiling clutter





Understanding Flexible Radio Assignment (software overview)

- [Understanding Flexible Radio Assignment \(Software Overview\)](#), page 25

Understanding Flexible Radio Assignment (Software Overview)

The AP 2800 and 3800 contain a Flexible Radio Architecture; In a sense the AP is a tri-band radio as it contains a dedicated 5-GHz radio to serve clients and another Flexible Radio (known as an XOR radio) that can be assigned different functions within the network.

The flexible radio is similar to the previous XOR radio used in the Cisco WSSI/WSM modules for the AP 3700, but this new flexible radio module is able to be configured to serve clients in either 2.4-GHz or 5-GHz or serially scan both 2.4-GHz and 5-GHz on the flexible radio while the main 5-GHz radio serves clients.

Figure 27: Flexible Radio Assignment

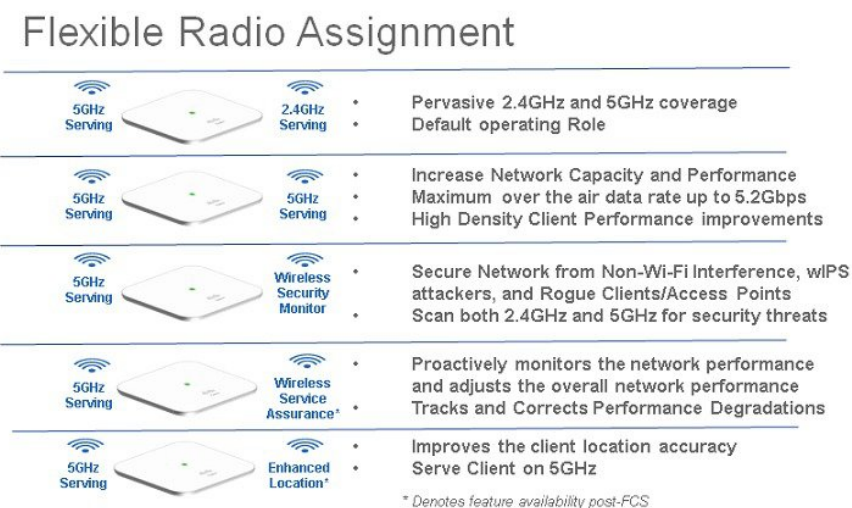

Flexible Radio Architecture (FRA) System

In addition to the dedicated 5-GHz radio, FRA enabled APs like the AP2800 and AP 3800 contain an additional integrated 2.4/5-GHz XOR "selectable radio" for additional flexibility.

An FRA system uses a special XOR radio that consists of the following:

- 2.4-GHz and 5-GHz on the same silicon
- Allows selection of 2.4-GHz or 5-GHz for serving clients (default is 2.4-GHz)
- Allows serial scanning of all 2.4-GHz and 5-GHz channels (in monitor "WSM" mode)
- Role selection is manual or Automatic-RRM
- Previous WSSI or WSM modules for 3700 were XOR in design
- This feature is now integrated into AP 2800 and AP 3800

The benefits of an FRA system are many and address the following issues:

- Solves the problem of 2.4-GHz over-coverage
- Creating 2 diverse 5-GHz cells doubles the airtime available
- Permits one AP with one Ethernet drop to function like two 5-GHz APs
- Introduces concept of Macro/Micro cells for airtime efficiency
- Allows more bandwidth to be applied to an area within a larger coverage cell
- Can be used to address non-linear traffic
- Enhances the High Density Experience(HDX) with one AP
- XOR radio can be user selected in either band servicing clients or in monitor mode

When using FRA with the internal antenna ("I" series models), two 5-GHz radios may be used in a Micro/Macro cell mode. When using FRA with external antenna ("E/P" models) the antennas may be placed to enable the creation of two completely separate Macro (wide area cells) or two Micro cells (small cells) for HDX or any combination.



Client Roaming in a Micro and Macro Cell

- [Understanding Macro and Micro Cells, page 27](#)

Understanding Macro and Micro Cells

In areas where the AP traditionally has a wide-area coverage clients connected close to the AP are the most spectrum efficient since they are in the near field and negotiate typically at the highest data rates while clients farther away compete at lower data rates. The lower rate clients that are farther away tend to take more airtime than the closer clients running at faster rates. This results in non-linear traffic and increases the overall channel utilization as clients compete for "airtime".

Figure 28: Single 5 GHz and 2.4 GHz cell (default mode) Channel Utilization at 60%

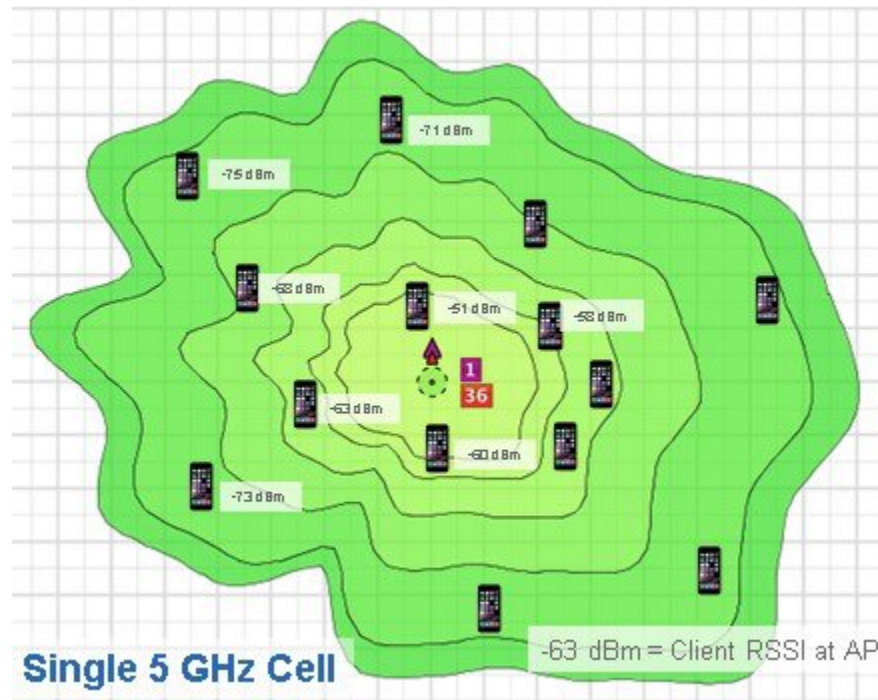

In the figure above, clients farther away are on the air more (sending longer, slower rate packets). The 2.4-GHz channels (channel 1) will typically propagate farther than 5-GHz so often the 2.4-GHz radio is redundant and in some cases is even turned off. So now the AP is covering a single 5-GHz cell in a Macro or large cell mode.

Using FRA, you can either automatically enable an additional 5-GHz cell using Radio Resource Management or you can manually decide that you would like to turn the XOR radio from its default 2.4-GHz to an additional 5-GHz cell.

Figure 29: Enabling the FRA XOR radio as a dual 5 GHz AP creating Micro (yellow) and Macro (green cell)

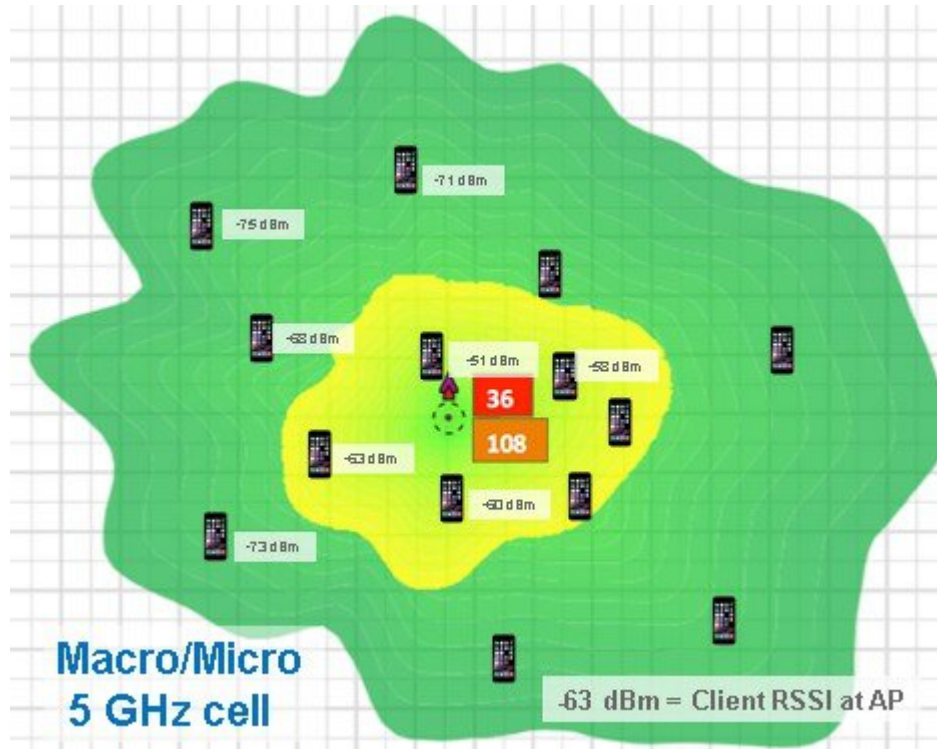

By optimizing the FRA to enable the access point to have two 5-GHz radios, this solves the problem of too much 2.4-GHz coverage while creating two completely RF diverse 5-GHz cells. This not only doubles the air time available to the 5-GHz clients, it also optimizes the client throughput by keeping like clients together for better spectrum efficiency.

Now instead of 60% channel utilization with the clients in near field competing for airtime from the slower farther away clients, like clients are now grouped with similar data rate characteristics.

Net result, channel utilization is now reduced to 20% on channel 36 and 24% on channel 108.

Currently both Macro (green) and Micro (yellow) cells use the same SSID by design; later releases will likely allow for different SSIDs.

Client Roaming from a Macro to Micro Cell

The most likely scenario is that a client will associate to the Macro cell first as it will have the bigger footprint and transmitting at a greater RF power. So in the figure below, any client that has RSSI at the AP above the Micro cell threshold of -55 dBm will be moved into the Micro cell.



Note

Note: -55 dBm is the default but configurable using the command line interface (CLI). For more on configuring these options *see* the RRM guide and other resources at <http://www.cisco.com/c/en/us/support/wireless/wireless-lan-controller-software/products-technical-reference-list.html>

In addition to the threshold, if the client supports 802.11v, on association the AP will send an .11v BSS transition request with the Micro cell BSSID and the only candidate. If a non .11v client, it will send an .11k neighbor list and a disassociate packet. Other methods and optimizations are being investigated.

Figure 30: Intra-cell roaming Macro cell to Micro cell



Client Roaming from a Micro to Macro Cell

When a client initially associate to the Micro cell first, while less likely but certainly possible based on device scan and channels heard. In this case, a client that has RSSI at the AP below the Macro cell threshold of -65 dBm will be moved into the Micro cell -65 dBm by default. This is also configurable by user CLI.

If the client supports 802.11v - on association, the AP will send an 11v BSS Transition request with the Macro cell BSSID as the only candidate.

For a non .11V client, the system sends an 11K neighbor list and a disassociate packet.

Figure 31: Intra-cell roaming Micro to Macro cell

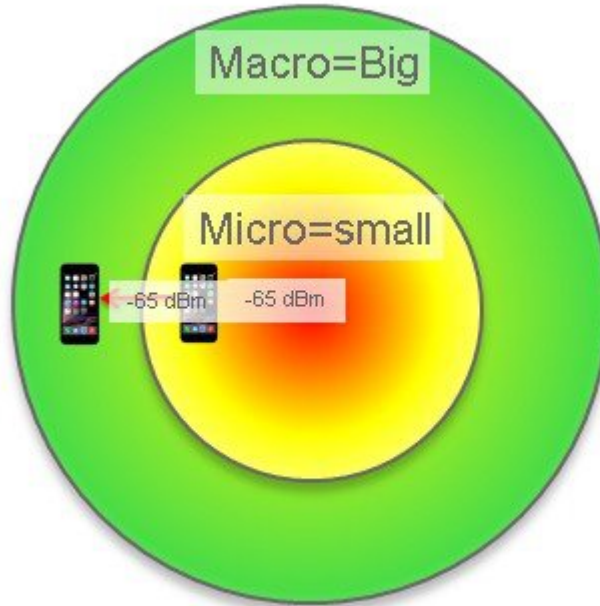

Micro and Macro cells on "I" Series Access Points

The AP 2800i and AP 3800i have integrated antennas and as such, when FRA is enabled and dual 5-GHz operation is selected, only the non-FRA radio can perform the role of a Macro cell or Micro cell. The XOR FRA radio when enabled for 5-GHz must operate using a much lower power and therefore must function as a Micro cell.



Note

The "E/P" Series with external antennas can operate in any combination of Micro or macro cells.

Prior to FRA technology, access points like the AP 2700 and AP 3700 defined the dedicated radios in software as Radio 0 (2.4-GHz) and Radio 1 (5-GHz); if an additional radio like the WSM module was installed in the AP 3700 the third radio was defined as Radio 2, sometimes called "Slot 2".

Now with FRA, Radio 0 is the 2.4-GHz radio *OR* it can be a 5-GHz radio; hence the term XOR.

By default the FRA functions as a 2.4-GHz radio, so out of the box the AP behaves the same as a conventional AP 2700 and AP 3700 operating off the dual band Macro cell (large brass colored) antennas on the four corners in the figure below. Additionally, the non-FRA 5-GHz radio also shares the Macro cell antennas.

If you enable the FRA radio from 2.4-GHz to 5-GHz, the FRA radio can no longer use the Macro cell antenna on 2.4-GHz and automatically switches to another set of four Micro cell antennas. This is done because two 5-GHz radios cannot share the same antennas.

The Micro cell 5-GHz antennas are designed to co-exist in the near field of the Macro cell antennas with the following caveats.

- 1 Channels must not be closer than 100-MHz (RRM prevents this).
- 2 The Micro cell antennas are horizontal polarity and higher gain to create a smaller cell foot print.
- 3 RF output power on the Micro cell is significantly reduced.

4 SSIDs must be the same (this may change in later releases).

Figure 32: Picture of the embedded antenna system and 3D antenna heat maps

Macro & Micro antenna design allows for RF co-existence

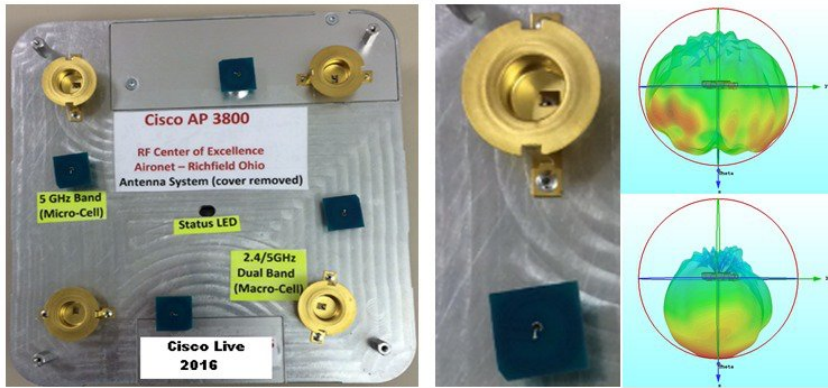

Figure 33: Smith chart comparing radiation patterns of Macro and Micro cell antennas

2800/3800i Antenna Patterns 5 GHz

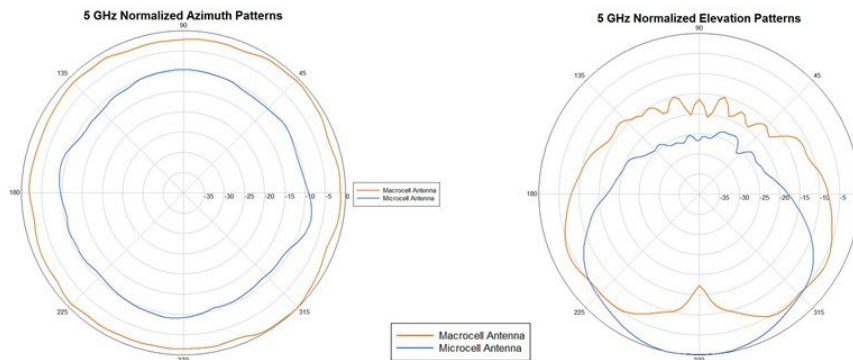
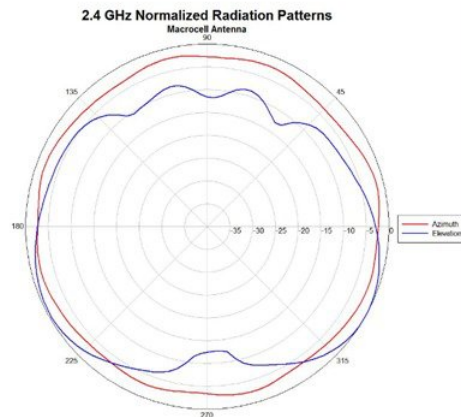

Figure 34: Smith chart radiation pattern of 2.4 GHz 4 dBi Macro cell antenna

2800/3800i Antenna Patterns 2.4 GHz



RF Operations on "E/P" Series Access Points

Unlike the integrated antenna models, the external antenna model units have four primary RP-TNC connectors on top of the device and an additional four RF connectors as well as digital via a new smart antenna connector.

Figure 35: Smart antenna connector is an integrated feature of the "E/P" series products

3802e, 3802p and 2802e



When the smart antenna connector is not used, the AP 2800 and AP 3800 "E/P" series function much like an AP 3700 where both the 2.4-GHz FRA radio and the integrated 5-GHz radio share the top RP-TNC connectors in a dual band mode.

**Note**

This is sometimes referred to as Dual Radiating Element (DRE) or dual band mode.

However, once the smart antenna connector is inserted, the access point senses the presence of the new connector/antenna and automatically switches the FRA (XOR radio) from the top connector that was previously in 2.4 GHz/5 GHz DRE mode to the smart connector port. This allows the top connectors for the 5 GHz radio serving clients and the FRA radio is now free (regardless of mode) to use the smart connector for RF communications.

The flexibility to do this allows many different types of modes, from discrete single band operation (SRE) to DRE operation. The ability to change the antenna controls (sending different bands 2.4 GHz and 5 GHz out of different ports in SRE and/or DRE mode) is sometimes referred to as Cisco "Flexport" and was first introduced in the AP-1530 series.

Figure 36: Antenna control (default) and with smart antenna connector installed



The role of the XOR radio is selected in software, and the modes are Band, Client Serving or Monitor mode. This can be set manually or automatically if RRM control is desired.

Figure 37: FRA (XOR) radio defaults to 2.4 GHz Client serving but is selectable in software

Radio Role Assignment

Auto Manual

Client Serving Monitor

Band

RF Channel Assignment

Current Channel	1 *
Channel Width	<input type="text" value="20 MHz"/>
Assignment Method	<input checked="" type="radio"/> Global <input type="radio"/> Custom

Tx Power Level Assignment

Current Tx Power Level	1
Assignment Method	<input checked="" type="radio"/> Global <input type="radio"/> Custom

If you change the band from 2.4 GHz to 5 GHz then you must have 100-MHz separation.

Figure 38: Error when channels are set too close

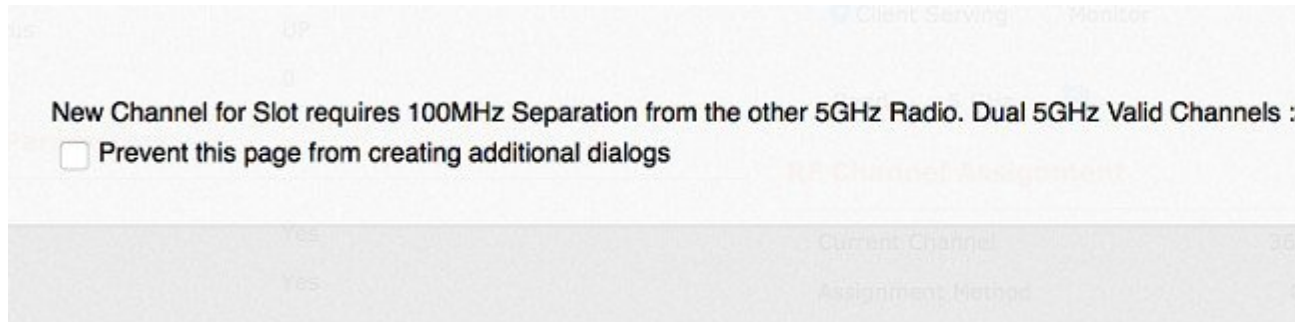

If the antenna has a smart antenna connector it allows the AP to sense what type of antenna is installed and configure the AP accordingly.

Using the smart antenna connector to RP-TNC adapter AIR-CAB002-DART-R the FRA (XOR) radio can now be used in many applications as the RF system on the FRA (XOR) radio will now use the four external RP-TNC connectors for a wide variety of application deployments.

Figure 39: Cisco Smart Antenna Adapter AIR-CAB002-DART-R

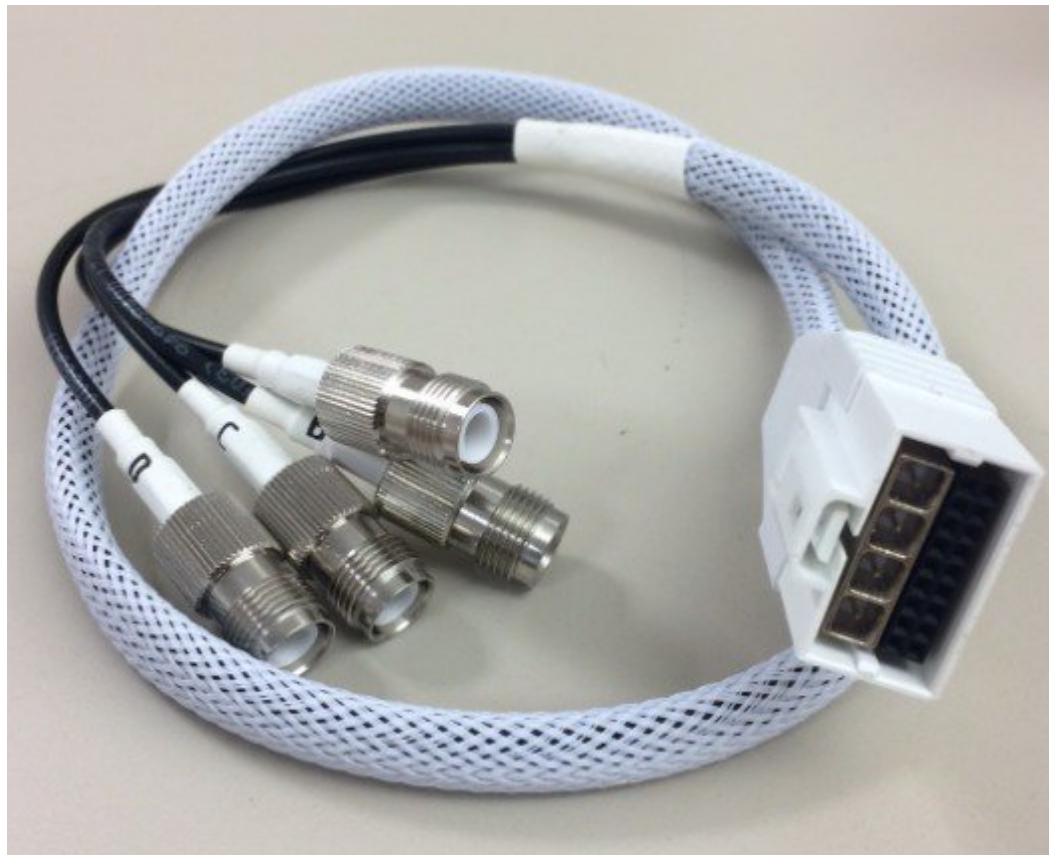

The smart RF antenna connector sometimes referred to as a DART carries the digital signals (18 mins) as well as the four analog RF ports from the XOR radio.

**Note**

The term DART is an Amphenol trademark name for this type of connector.

Unlike the internal models, the smart connector allows both antenna systems to be located away from each other enabling deployments that cannot be done with the internal model. For example, the creation of two 5-GHz Macro cells is now possible in addition to separating the 5-GHz cells into different areas (think inside/outside) or different coverage areas in a factory or stadium.

Sometimes unique customer requirements dictate that 2.4-GHz RF operation be on one set of antennas and 5 GHz on a completely different set of antennas, and that is also possible.

Figure 40: Smart antenna cable adapter and the Cisco external Omni antenna



Since both sets of antennae can be physically spaced apart, many new RF design opportunities become available allowing for many different types of new and unique installations.

Some deployment options include:

- 1 Omni and directional deployments (think hospital room and a long hallway) with one AP
- 2 Any combination of Micro and Macro cell deployments
- 3 Using stadium antennas, two different 5-GHz coverage cells can be done with 1 AP

- 4 High ceilings (factory and warehouse deployments) can use back to back 6 dBi Patch antennas
- 5 AP using 2x 5-GHz radio can double the coverage with the addition of one antenna
- 6 Conference centers and other locations can double capacity on existing Ethernet cable plan
- 7 One access point can support both indoor and outdoor deployments
- 8 Access point can serve 5-GHz clients while performing full 2.4 & 5-GHz wireless monitor radio

When using the smart antenna connector and dual 5-GHz mode the caveats are:

- 1 Channels must not be closer than 100-MHz
- 2 Antennas should not be mounted so that energy from one antenna is directed into another
- 3 Ideally if one antenna is Omni then 6 ft or 2 meter physical separation
- 4 Antennas may be closer if used in Micro cell (very low power) is used
- 5 Any combination of Micro/Macro can be used as long as physical isolation exists
- 6 SSIDs must be the same (this may change in later releases)

Figure 41: Example using "E/P" version to create two macro cells can be supported

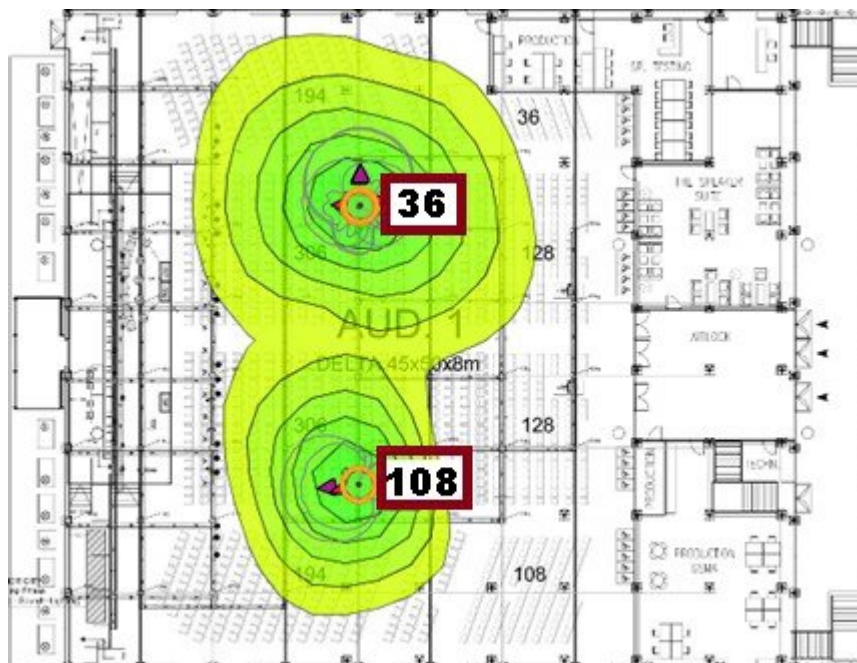



CHAPTER 6

Approved Antennas for Use with Access Points 2800 and 3800

Figure 42: Approved list of external antenna for use with 2800E/3800E/3800P

Frequency	Part Number	Antenna Type	Antenna Gain (dBi)	Model	Antenna Gain >30 degrees (dBi)	2.4G Location Antenna Gain (dBi)	5G Location Antenna Gain (dBi)
2.4 GHz	AIR-ANT24020V-R	Omni	2	3800E/3800P	NA		
	AIR-ANT2452V-R	Diversity Omni-directional	5.2	3800E/3800P	NA		
	AIR-ANT2430V-R	MIMO 3-Element Omni	3	3800E/3800P	NA		
	AIR-ANT2440NV-R	MIMO Wall-Mount Omni Antenna	4	3800E/3800P	NA		
	AIR-ANT2460NP-R	MIMO 3-Element Patch	6	3800E/3800P	NA		
5 GHz	Internal	Directional (5G XOR)	6	2800/3800I	Indoor Only		
	AIR-ANT5140V-R	MIMO 3-Element Omni	4	3800E/3800P	Indoor Only		
	AIR-ANT5140NV-R	MIMO Wall-Mount Omni Antenna	4	3800E/3800P	-8		
	AIR-ANT5145V-R	Diversity Omni-directional	4.5	3800E/3800P	Indoor Only		
	AIR-ANT5160NP-R	MIMO 3-Element Patch	6	3800E/3800P	3		
2.4 / 5 GHz	Internal	Omni (2.4G XOR / 5G Dedicated)	4 / 5	2800/3800I	Indoor Only		
	AIR-ANT2451V-R	Omni	2 / 3	3800E/3800P	Indoor Only		
	AIR-ANT2451NV-R	Omni	3 / 4	3800E/3800P	Indoor Only		
	AIR-ANT2524DB-R	Dual-resonant black dipole	2 / 4	2800E/3800E/3800P	Indoor Only		
	AIR-ANT2524DW-R	Dual-resonant white dipole	2 / 4	2800E/3800E/3800P	Indoor Only		
	AIR-ANT2524DG-R	Dual-resonant gray dipole	2 / 4	2800E/3800E/3800P	Indoor Only		
	AIR-ANT2524VC-R	Dual-resonant ceiling mount omni (4-pack)	2 / 4	2800E/3800E/3800P	Indoor Only		
	AIR-ANT2535SDW-R	Dual-resonant "stubby" monopole	3 / 5	2800E/3800E/3800P	Indoor Only		
	AIR-ANT2544V4M-R	Dual-resonant omni (4-pack)	4 / 4	2800E/3800E/3800P	Indoor Only		
	AIR-ANT2566P4W-R	Dual-resonant "directional" antenna (4-pack)	6 / 6	2800E/3800E/3800P	3		
	AIR-ANT2566D4M-R	Dual-Band Polarization-Diverse Directional Array	6 / 6	3800P	3		
	AIR-ANT2513P4M-N	Dual-resonant cross-pol "directional" antenna (4-pack)	13 / 13	3800P	-7		

The above list is the approved antennas for use in the US Theater using the FCC –B domain. The new –B products allow for outdoor use provided the correct antenna is used. Customers should avoid using UNII-1 band outdoors in the US unless the –P version is used.



CHAPTER

7

AP 2800 and AP 3800 Powering Options

With each advance in wireless technology, access points are increasing in the number of radios, processing power and memory. In 2001 the AP-350 Access Point had one 2.4 GHz radio and processor requiring only 6 Watts of power. These early PoE access points would fully function using the earlier 802.3af (15.4W) powering systems developed in 2000-2003.

Figure 43: Early AP-350 used 6 Watts-Newer AP 3800 requires 802.3at or PoE+

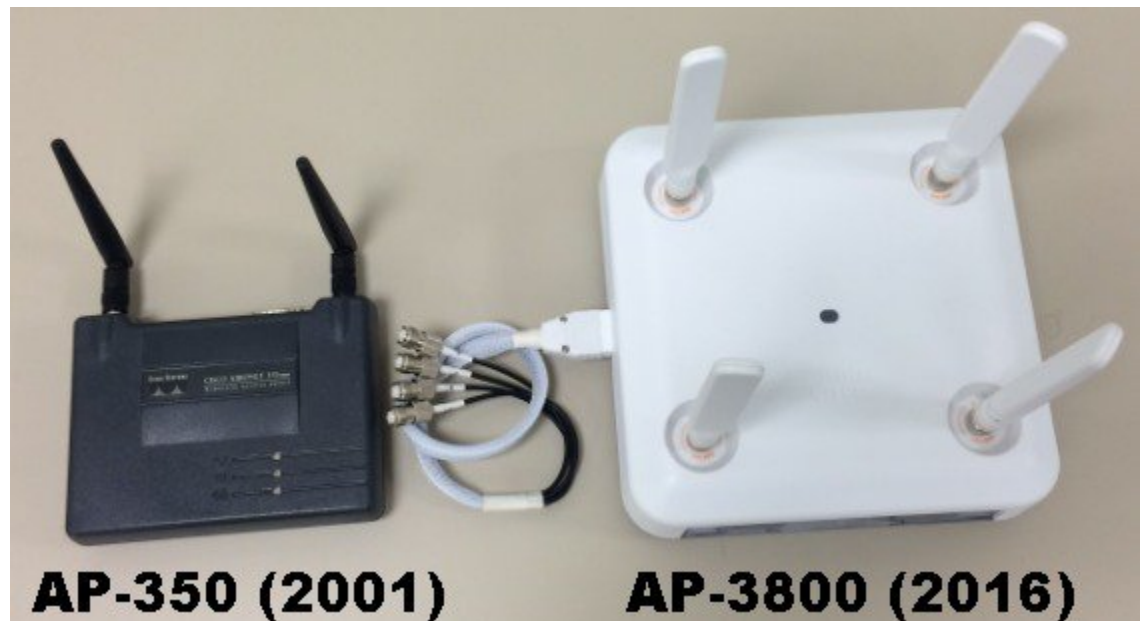

Later PoE standards have since emerged with 802.3at providing up to 30 Watts at the Power Sourcing Equipment (PSE). Many of Cisco's previous access points such as the AP-1850 and AP-3700 worked best with the higher power sources 802.3at and PoE+ but would function with "reduced functionality" if powered by the older 802.3af 15.4W powering systems.

With the introduction of the XOR radio along with more advanced features, it simply is not feasible to run these higher performance access points on the older legacy 802.3af (15.4W) powering systems. Customers who have such older systems should upgrade to 802.3at (30W) PoE equipment or systems that support uPoE for best performance or use a different power source such as a mid-span injector or local power supply. Note:

If the AP2800 and AP 3800 are powered from an 802.3af power source the LED will cycle though the colors and the radios will be disabled.

Performance requires power as the AP 2800 and AP 3800 have much more advanced features such as:

- 1 Dedicated microprocessor and memory for each radio band
- 2 Dual core processor to manage access point and Ethernet functionality
- 3 Additional XOR radio and antenna switching circuitry, pushing transceiver count to 12 radios
- 4 Cisco CleanAir silicon for complete spectrum analysis and interference detection
- 5 Cisco ClientLink powerful (legacy .11a/g/n and .11ac Wave 1 beamforming)–improving older client connectivity and performance; IEEE specification is limited to only TxBF on 802.11ac Wave-2 clients
- 6 Additional (auxiliary) Ethernet port, USB and advanced radio functions such as 160 MHz / Dual XOR
- 7 Support for smart antenna functionality (WSM monitor mode and enhanced location)
- 8 802.3bz (NBASE-T) mGig Ethernet support (AP 3800)
- 9 Future hardware expandability using modular technology (AP 3800)

Understanding different types of PoE powering standards:

- Cisco Pre-standard PoE - Original implementation 6-7 Watts (2000-2001)*
- Cisco Pre-standard PoE - upgraded to negotiate up to 10-15 Watts via CDP (2001-2003)
- IEEE 802.3af PoE mechanism that supplies power up to 15.4W (July 2003)*
- IEEE 802.3at PoE mechanism that supplies up to 30W (2009)*
- UPoE Cisco method of Universal Power over Ethernet that supplies power up to 60W (2014)*



Note

The * indicates these are approximate dates and PoE is defined as the maximum power required at the source.

Cisco AP 2800 and AP 3800 easily function with 802.3at powering systems and for advanced features like module support (AP 3800) Cisco UPoE can be used.

Figure 44: AP 2800 and AP 3800 requires an 802.3at or better PoE source

AP 2800 & AP 3800 - Power Requirements

		Description	AP Functionality	PoE Budget @ PSE (Watts)	802.3af or PWRINJ5	802.3at PoE+ PWRINJ6	802.3bt uPoE
2800	PoE 802.3at	2800 – Out of the Box (8.2.x.x)	All Features Enabled*	26W	X	✓	✓
3800	PoE 802.3at	3800 – Out of the Box (8.2.x.x)	All Features Enabled* Except Module support	30W	X	✓	✓
	PoE 802.3bt (uPoE)	3800 – Out of the Box (8.2.x.x)	All Features Enabled* Including Module support	52W	X	X	✓

* USB support not available at FCS may increase power up to 3W

If an 802.3at or better power source is not available, the following Cisco mid-span injectors may be used.

Figure 45: Low cost 802.3at GbE injector for AP 2800 and AP 3800 (if mGig is not required)

30 Watt GbE Injector - Cisco AIR-PWRINJ6



802.3at Midspan, 30W injector

No. of Ports	1	Weight	44 lbs (200 g)	Reliability	MTBF: 100,000 hrs. @25°C
Data Rates	10/100/1000 Mbps	Indicators	AC Power (Yellow) Channel Power (Green)	Thermal Rating	20 BTU/HR (@240VAC)
Power over Ethernet Output	Pin Assignment and Polarity: 4/5 (+), 7/8 (-) Output Power Voltage: 55Vdc	Connectors	Shielded RJ-45, EIA 568 A and 568 B	Warranty	1-year
User Port Power	30 Watts (Guaranteed)	Environmental Conditions	Operating Ambient Temperature: -4° to 104°F (-20 to 40°C) @ 30 W -4° to 122°F (-20 to 50°C) @ 25 W Operating Humidity: Maximum 90%, Non-condensing Storage Temperature: -4° to 158°F (-20° to 70°C)	Regulatory Compliance	IEEE 802.3at (PoE), RoHS Compliant, WEEE Compliant, CE
Input Power Requirements	AC Input Voltage: 100 to 240Vac AC Input Current: 0.67A @ 100-240Vac AC Frequency: 50 to 60Hz			Electromagnetic Emission & Immunity	FCC Part 15, Class B EN 55022 Class B (Emissions) EN 55024 (Immunity) VCCI
				Safety	UL 60950-1 IEC/EN 60950-1

PID (Product ID) is AIR-PWRINJ6= CPN (Cisco Part Number) 341-100456-01

An additional mid-span injector capable of 802.3bz (known as mGig / N-BASE-T).

Figure 46: Planned Mid-Span Injector

30 Watt Multigigabit PoE+ Injector Cisco MA-INJ-5-xx up to 10Gbps





Note

The Cisco AP 2800 does not support a local power supply; however the AP 3800 does have a new high wattage supply that can be used in applications where a PoE source is unavailable.

Figure 47: White power supply and cord

Local Power Supply - Cisco PID = AIR-PWR-50

AIR (Aironet) PWR (Power) 50 (50 Watt)



Figure 48: AIR-PWR-50 mechanicals - Spare part # AIR-PWR-50=

AIR-PWR-50 (Mechanicals)

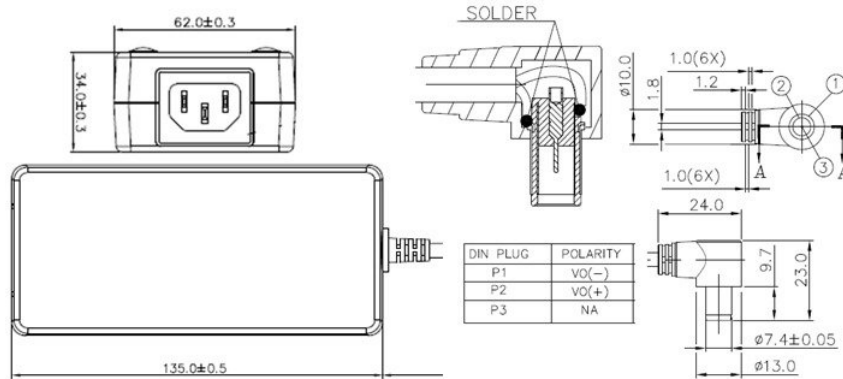

Note

The following Mid-Span devices are not compatible with the AP 2800 AP 3800:

- Mid-Span Injectors–AIR-PWRINJ, AIR-PWRINJ2, AIR-PWRINJ3, AIR-PWRINJ4 and AIR-PWRINJ5
- Local power supplies–AIR-PWR-A, AIR-PWR-B and AIR-PWR-C



CHAPTER

8

AP 3800 and Multigigabit Ethernet (mGig)

Multigigabit Ethernet (mGig), N-BASET and 802.11bz are all methods by which faster speeds can be realized (faster than 1G) using existing infrastructure wiring such as CAT-5e. The goal is to deliver up to 5 times the speed in the Enterprise without replacing existing cable structure.



Note

Although the AP 2800 does not directly support mGig, these are ideal switches for providing the power required by the AP 2800 as well.

Here are the recommended mGig switches and PoE solutions for the AP 3800 .





		
4500E	3850	3560CX
<ul style="list-style-type: none">• Best In Class Modular Access• New 48 Ports Line Card• 12 Ports of Multigigabit per slot• Up to 96 multigigabit ports per system	<ul style="list-style-type: none">• Industry leading Fixed Access• 24 & 48 Port Stackable Switches• 24 & 12 Multigigabit Ports• New Uplinks	<ul style="list-style-type: none">• NG Workspace switch• Multigigabit in smallest form factor• POE/POE+• Instant Access support

Figure 49: Cisco line of mGig capable switches

	
48-port Catalyst 3850 Multigigabit Switch	24-port Catalyst 3850 Multigigabit Switch
<p>Downlinks: 36 x 1G LineRate 10/100/1000BASE-T, PoE/PoE+/UPoE, EEE, MACSec 12 x GE/mGig/10GT – LineRate, 100M/1GE/mGIG/10GBASE-T, PoE/PoE+, PoE/PoE+/UPoE, EEE, MACSec</p> <p>Uplinks: 4x10GE SFP+, 2 x 40G (NEW), 8x10G (NEW)</p>	<p>Downlinks: • 24 x GE/mGig/10GT • EEE, MACSec • PoE/PoE+/UPOE</p> <p>Uplinks: 4x10GE SFP+, 2 x 40G (NEW), 8x10G (NEW)</p>

Ideally a switch supporting IEEE 802.3bz (mGig, which is also referred to as N-BASET) will deliver the fastest Ethernet using older cable systems such as CAT-5 and deliver +30W for newer PoE devices.

Figure 50: Cisco Multigigabit enables speeds over 1G on conventional CAT5e cable systems

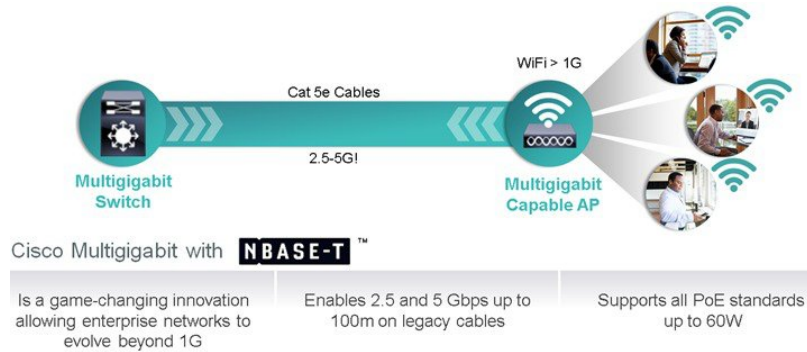

In regards to cabling structure and Cisco Multigigabit Ethernet:

- 1 Data rates up to 1G requires 62.5–MHz bandwidth (Cat 5e is 100 MHz)
- 2 Data rates up to 2.5G requires 100MHz bandwidth (Cat 5e is 100 MHz)
- 3 Data rates up to 5G requires 200MHz bandwidth, which is more than the specified Cat 5e 100MHz bandwidth, but within the Cat 6 cable

The main point is that 5G operations over Cat 5e may have issues using certain cable configurations due to the fact we are using Cat 5e cable beyond the specification.

Figure 51: Cisco Multigigabit cable support at rates up to 5G

Cable Type	FE	1G	2.5G	5G
Cat5e	●	●	●	●* 30-70m
Cat6	●	●	●	●
Cat6a	●	●	●	●

*Watch for cross-talk issues in bundles or when cables are in same pipe. Keep lengths of CAT-5e between 30-50m or below when using dense cable bundles; for example, cables in a dense area like a pipe or places where five or more cables are tied in a bundle.

Figure 52: Cisco Multigigabit distance limitations

UTP Cable	IEEE 10G Spec
CAT 5/5e	N/A
CAT 6	55 meters
CAT 6A	100 meters
CAT 7	100 meters



Figure 53: Cisco Multigigabit distance limitations

Troubleshooting mGig (N-Base-T)

Cable Type	Port Speed	Total Cable Length	6-a-1 Bundled Cable Length	Patch Panel Cable and 3 Connectors	Mitigation Plan to improve performance
Cat 5e	10GE	N/A	N/A	N/A	Upgrade cable to Cat 6a
	5GE	100m	>30m	10m (2x5)	1) Use "Downshift" 2) Reduce number of connectors 3) Change patch cable to solid core cable 4) Reduce bundled cable length to be <30m 5) Use Cable Diagnostic or Cable Tester to determine end-to-end Cable quality
	5GE	100m	<30m		5GE
	5GE	55m	Fully bundled	10m	5GE
	2.5G	100m	Fully bundled	10m	2.5GE

Downshift
Option that permits system to detect and lower speeds when noise occurs rather than maintaining a fixed value



CHAPTER

9

New-B Regulatory Domain for US Theater

Recent changes in United States FCC rules requires shifting products from -A domain to -B domain effective June 2, 2016. Access Points using -A domain can continue to operate in the US after the June deadline but all new access points being manufactured or sold after June 2 must be -B domain.

Following is a summary of new FCC rules (FCC Order 14-30) require:

- U-NII 1 band (5150-5250 MHz) is now allowed for outdoor use. (+4 channels)
- In the U-NII 1 band (5150-5250 MHz) the allowed TX power level is increased to 1W (for indoor, outdoor, point to point) with extreme restrictions on EIRP above 30-degree horizon when used outdoors
- The Terminal Doppler Weather Radar (TDWR) bands (channels 120, 124, 128) are re-opened with new test requirements for Dynamic Frequency Selection (DFS) protection. (+3 channels)
- New power spectral density and above/below band edge emissions requirements for U-NII3 (5.725-5.85 GHz)

Figure 54: Spectrum chart depicting new channels in the -B domain

-B Changes: 5 GHz Spectrum (FCC)

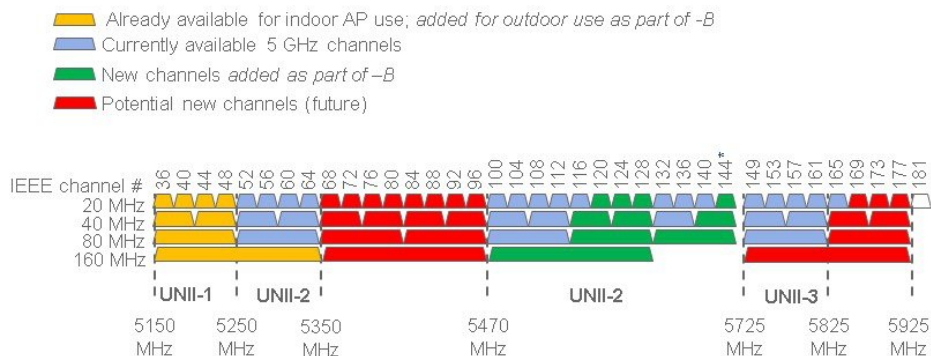

*Channel 144 was allowed for use prior to the FCC 14-30 order but not supported until -B introduced

Cisco is aggressively implementing this new FCC order:

- Cisco WLAN products will comply with new FCC rules

- Orderability Plans for -B domain SKU's
 - Recent new AP series already support -B and are orderable; all new AP series going forward will support -B at FCS; many AP series already have -B orderable as well
 - Sales of -A and UX SKU's to US will start to be restricted starting May 1, 2016
- Software upgrade is required to support -B domain AP's
 - US customers who do not plan to deploy -B AP's are not required to upgrade software; however, they will need to upgrade when they plan to deploy -B AP's after the June FCC deadline
 - -A and -B domain AP's can coexist in the same network without issues
- RMA's after June deadline of a -A unit will get a -A in return

General thoughts concerning compliance as it relates to the AP 2800 and AP 3800:

- For US customers the "-B" domain is now used for AP 3800. US customers should not order the -A domain for US based customers. Other countries that use "-A" are unchanged. This change only applies to the US. This new "-B" domain supports the new channels and transmit powers allowed in the US.
- Customers are responsible for verifying approval for use in their individual countries. To verify approval that corresponds to a particular country or the regulatory domain used in a specific country, visit <http://www.cisco.com/go/aironet/compliance>
- Not all regulatory domains have been approved. As they are approved, the part numbers will be available on the Global Price List.



Stadium and Harsh Environments

Customers wishing to install the AP in harsh environments where it may be exposed to weather, such as stadiums, sporting areas, open garden areas or warehouse freezers, may wish to use a NEMA type enclosure.

**Note**

Some access points may not be certified for outdoor deployments in a NEMA enclosure. This varies around the world; for example, some regulatory agencies permit AP outdoor NEMA enclosures if the AP is indoors, such as a freezer or garden area, but may prohibit its use outdoors. This seems to vary with regard to weather radar compliance and often UNII-1 compliance. Check with your Cisco account team or the communications regulatory agency that has jurisdiction in your part of the world.

Figure 55: Example of NEMA Enclosure with pressure vent on bottom

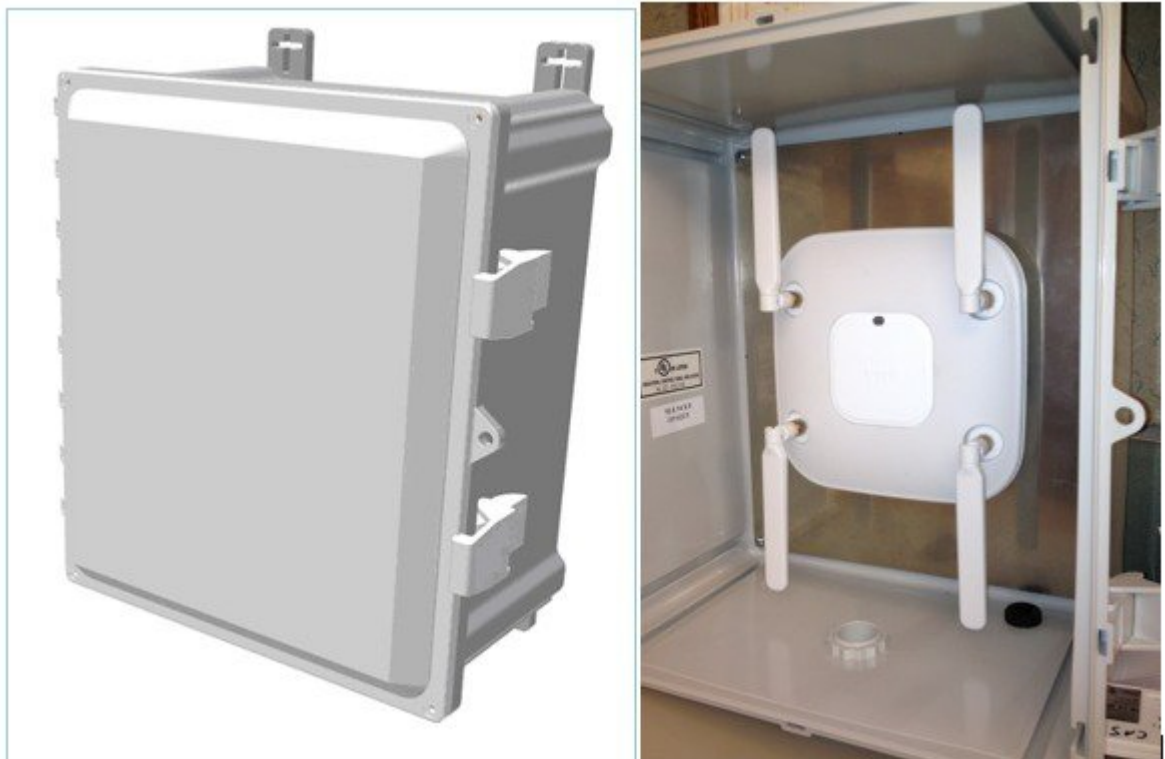

Third-party sources for NEMA type enclosures include:

<http://www.oberonwireless.com/>

<http://www.sparcotech.com/>

<http://www.terra-wave.com/>

When using a NEMA type enclosure, try to have the cables exit out of the bottom of the enclosure so that rain and moisture do not run down the cable into the enclosure. Also, the color of the enclosure may affect the heat rating; for example, a black enclosure gets much hotter in the sun than a white one. You may also want to use a pressure vent to prevent moisture accumulation.



CHAPTER

11

Areas with High Vibration

If the access point is installed using a "side arm" type mount or other mounting locations where there is a likelihood of high vibration, it is recommended that a padlock or metal pin be used to prevent the AP from vibrating loose from the bracket.

Bracket-1 & Bracket 2 (3700 and 3800)

AP-3800 Ethernet cable not quite as secure using Bracket-1



AP-3800 is thicker so Bracket-1 rises a little higher to allow for USB compatibility within the bracket and to support locking hasp on left.



AP-3700 cable is a bit more secure – as it is a thinner AP.

Note: This is unlikely to be an issue due height / cables out of view

If cable security is a hard customer requirement – use 3rd party box

CISCO

Partner Training

Figure 56: Metallic Parts

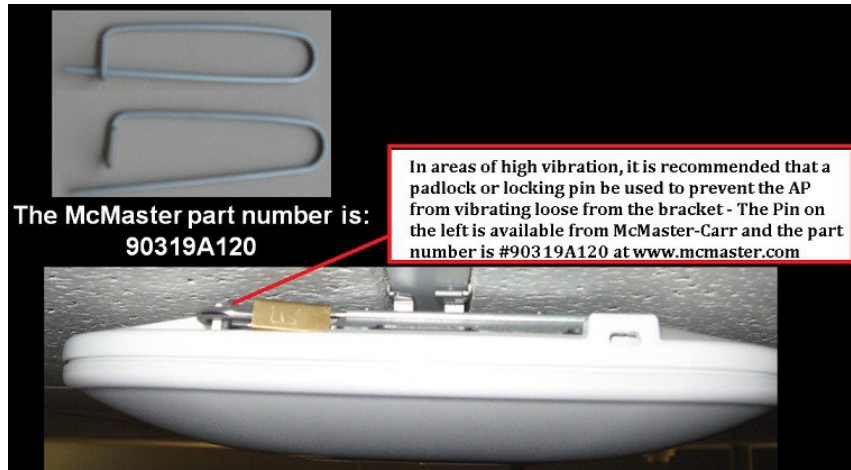



Related References

In addition to the URLs already provided in this document, below are links to related information:

- AP 2800 Datasheet: <http://www.cisco.com/c/en/us/products/wireless/aironet-2800-series-access-points/index.html>
- AP-3800 Datasheet: <http://www.cisco.com/c/en/us/products/collateral/wireless/aironet-3800-series-access-points/datasheet-c78-736498.html>
- [Previous Deployment Guides](#), page 57

Previous Deployment Guides

- Understanding LAG and MU-MIMO: http://www.cisco.com/c/en/us/td/docs/wireless/controller/technotes/8-1/1850_DG/b_Cisco_Aironet_Series_1850_Access_Point_Deployment_Guide.html
- Understanding Stadium, Warehouse, Factory and other RF theory such as Spatial Streams Data rates: http://www.cisco.com/c/en/us/td/docs/wireless/technology/apdeploy/8-0/Cisco_Aironet_3700AP.html
- Understanding mGig:
 - <http://blogs.cisco.com/enterprise/introducing-cisco-catalyst-multigigabit-technology-to-future-proof-your-network-for-802-11ac-wave-2>
 - <http://www.cisco.com/c/en/us/solutions/enterprise-networks/catalyst-multigigabit-switching/index.html>
 - <http://www.cisco.com/c/dam/en/us/products/collateral/switches/catalyst-4500-series-switches/at-a-glance-c45-733656.pdf>
- **mGig FAQ**: <http://www.cisco.com/c/dam/en/us/solutions/collateral/enterprise-networks/catalyst-multigigabit-switching/multigigabit-ethernet-technology.pdf>



Frequently Asked Questions (FAQ's)

1 What are the differences between the AP 2800 and AP 3800?

The AP 3800 has the following features that are not available on the AP 2800:

- mGig
- Option module support
- RF filters and cellular coexistence and module RF isolation
- Local DC power connector
- Available as optional 3800P version for outdoor and stadium applications

2 What are the benefits of a Flexible Radio Architecture?

Most sites have plenty of 2.4-GHz coverage, so using FRA means fewer physical APs need to be deployed as the dual 5-GHz radios can replace installations that previously required two APs.

• Flexible Radio Assignment

- Allows for the additional XOR radio (if desired) to function similarly to a WSM module (off channel scanning) while primary 5-GHz radio services clients
- Reduces installation costs as a single AP can now support two 5-GHz radios (fewer APs, better aesthetics). This can provide flexibility in architectural designs and can reduce the number of needed Ethernet drops
- Can increase accuracy of location based devices, and client can roam from Micro to Macro cell on same AP
- Primary 5GHz radio can service clients, while the secondary 5-GHz radio can be used to enable testing of wider 160 MHz and/or newer channels as they become available – allowing new features without limited performance
- Allows for RF network separation (example: guest access on one radio, corporate access on the other)

• Flexible radio, antenna, and options using integrated antenna “I” series models

- One radio can be set up for HDX Micro cell and second radio setup for a Macro cell
- Both radios can be configured for HDX type coverage (Micro / Micro) cell

- Flexible Radio / Antenna Options using external antenna “e” series models
 - Both radios can be setup in HDX mode for Micro cells with external antenna models
 - Both radios can be set up in Macro cell mode with external antenna to provide two wide area cells
 - Different antennas can be used on each 5G radio for different coverage patterns (Omni and Directional); or one radio can serve one coverage cell while the other radio is used for a different classroom or outdoor coverage
 - Permits greater RF flexibility allowing XOR to combine with dedicated 5–GHz in DRE mode (default) OR SRE mode for a 5G/5G or separate 2.4/5G or DRE 2.4 & 5G (dual band mode)

3 What is a SMART antenna connector?

The Cisco Aironet AP-3802E, AP-3802P, and AP-2802E contain a SMART antenna connector, which is connected directly to the flexible radio. Without a Smart antenna, the flexible radio must stay in 2.4GHz only mode. Once a Smart antenna is connected, the flexible radio can be used in the full flexible radio Assignment mode, allowing dual 5–GHz, wireless security monitoring, and future modes.

The Smart antenna connector can be used to connect to AIR-CAB002-DART-R= which allow any RP-TNC based Aironet antenna to connect to the Smart Antenna port. In addition, future Smart Antennas will be released at future times.

4 What is the Extension module slot used for?

The module slot on the AP 3802I, AP 3802E, and AP 3802P can be used to insert future modules.

Some of the proposed modules are:

- 3G and LTE Small Cell Offload
- Bluetooth Beaconing (BLE)
- Future Wi-Fi upgrades to meet new IEEE standards
- Video Surveillance
- Custom Applications using Linux

5 Why is the Extension module slot on the side?

The sidecar module architecture allows Network Engineers the ability to add/swap modules without dismounting the access point from the mounting bracket. Additionally, it frees the optional module from the constraints of being inside the AP.

6 What kind of plastic is AP 2800 and AP 3800 made of and is it suitable for use in hospital cleanroom environments?

The plastic material used on the AP 2800 and AP 3800 series is Lexan 945. This material was tested for clean room use with a Steris Chemical (trademark name SPOR-KLENZ) <http://www.sterislifesciences.com/Products/Surface-Disinfectants-Cleaners-and-Alcohols/Sporicides-Sterilant/Spor-Klenz-Ready-To-Use-Cold-Sterilant.aspx>

7 Looking at the specification sheets, I noticed the Cisco AP 1850 supports 4x4:4 and the AP 2800/3800 supports 4x4:3. Why does the AP 1850 support one more spatial stream? How does this help me?

When designing the AP 2800 and AP 3800 Cisco wanted to bring the very best technology into the device. A trade-off was made to support dual 5-GHz 160 MHz rather than the extra spatial stream, as the additional spatial stream provides little real benefit.

In order to maintain a good 4-SS link, one needs $n+1$ antennas (meaning you cannot beam-form a 4-ss client when the maximum number of antennas is 4. Additionally, there are few, if any, 4-SS clients because the battery requirements of such a client are prohibited or limited to devices such as PCI card or other "plugged in devices".

So while it may seem like MU-MIMO 4 spatial streams is an advantage, MU-MIMO 4 Spatial streams seems like an advantage, MU-MIMO operation is for the most part limited to three 1-SS users or 1-SS and one 2-SS user. The benefit is only there when you have a single 4-SS client, which is a very small benefit.

Cisco has for years developed products using 3-SS as we use our 4th antenna to beam-form using ClientLink to maintain a robust 3-SS signal over a greater distance than what could be reasonably maintained without transmit beam-forming (TxBF).

Cost sensitive customers who don't require advanced features such as Cisco ClientLink, CleanAir, 160 MHz operation, FRA, mGig can certainly use the AP 1850 and gain 4-SS, but it will not outperform the AP 2800 and AP 3800.

8 How Does AUTO-Link Aggregation (LAG) work with the AP 2800 and AP 3800?

Both the 2800 and 3800 support LAG across their primary ethernet interfaces and AUX ports. This would provide 2Gbps of uplink to the access point. When operating in LAG, the 3800's multigigabit port will operate as a single GE port.

The following Cisco switching series support LAG with the APs:

- Catalyst 3850 / all models (non-Converged Access mode)
- Catalyst 3650 / all models (non-Converged Access mode)
- Catalyst 4500/Sup-8E
- Catalyst 6500/Sup 720 or newer

9 What is ClientLink 4.0? How is it different from IEEE 802.11ac Wave-2 beam-forming?

ClientLink 4.0 is a beamforming capability built into Cisco Aironet® wireless LAN access points. When the access point (AP) concentrates signals toward the receiving client, that client is better able to "hear" the AP's transmission, so throughput is greater. ClientLink also enhances performance in the uplink (client-to-AP) direction, so that the AP can also better hear the client communications. The result improves performance in both directions.

By comparison, many competing 802.11ac-capable APs offer uplink-only enhancements, from client to access point. Many 802.11ac-capable AP suppliers also base their downlink enhancements on the optional transmit beamforming (TxBF) feature in 802.11ac, which requires TxCBF support in the client device to operate.

Cisco ClientLink technology is unique in offering both uplink and downlink performance improvements, and it does not require any special capabilities in the client device to work.

ClientLink works with all client technologies. It makes sure each client type always operates at the best possible rate, as determined by the 802.11 access technology supported, network conditions, and the distance of the client from the Wi-Fi AP. ClientLink helps to maintain maximum client rates.

10 I noticed that we can't run 3800 with mGig and gigE ports in lag mode (without downgrading mGig).

Correct, if you have mGig there is no need to use LAG

11 The internal antennas on the AP 2800i and AP 3800i what is the gain in dBi?

The 5 GHz Macro cell antenna is 5 dBi, the 2.4 GHz Macro Cell is 4 dBi and the XOR radio (when in dual 5 GHz mode) uses a 6 dBi integrated antenna.

12 Is PoE only accepted on the primary port? or can I also power the device using the secondary ethernet port?

Only the primary Ethernet port negotiates Power over Ethernet.

13 Can you advise how much system memory this access point has?

1024 MB DRAM and 256MB flash

14 I would like to understand more about FRA and how RRM works ?

Please refer the RRM guide at http://www.cisco.com/c/en/us/td/docs/wireless/controller/technotes/8-2/b_RRM_White_Paper.html

15 Does this product support TKIP?

Customers should be discouraged from running legacy TKIP as that feature has been deprecated by the Wi-Fi Alliance. Cisco understands there are healthcare customers using legacy equipment with a need for TKIP support. The 1830, 1850, 2800 and 3800 does not currently support TKIP but there are plans to support it in the 8.3MR1 release.