



Operation Manual

Smart-UPS™ On-Line SRT Uninterruptible Power Supply

SRT1000UXI-LI
SRT1000UXI-NCLI
SRT1500UXI-LI
SRT1500UXI-NCLI

220/230/240 Vac
Tower/Rack-Mount 2U

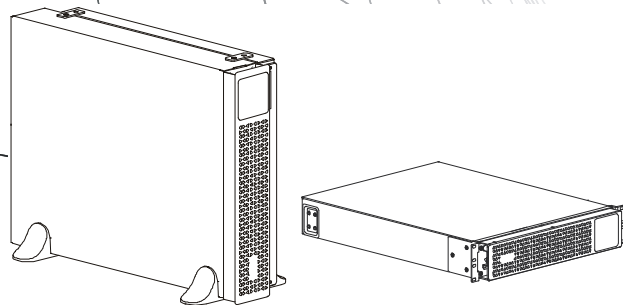

For Professional Business Applications – Not For Consumer Use

General Information

Important Safety Messages

Read the instructions carefully to become familiar with the equipment before attempting to install, operate, service or maintain the UPS. The following special messages may appear throughout this manual or on the equipment to warn of potential hazards or to call attention to information that clarifies or simplifies a procedure.



The addition of this symbol to a Danger or Warning product safety label indicates that an electrical hazard exists which will result in personal injury if the instructions are not followed.



The addition of this symbol to a Warning or Caution product safety label indicates that a hazard exists that can result in injury and product damage if the instructions are not followed.

 DANGER
DANGER indicates a hazardous situation which, if not avoided, will result in death or serious injury.
 WARNING
WARNING indicates a hazardous situation which, if not avoided, could result in death or serious injury.
 CAUTION
CAUTION indicates a hazardous situation which, if not avoided, could result in minor or moderate injury.
NOTICE
NOTICE is used to address practices not related to physical injury.

Product Handling Guidelines

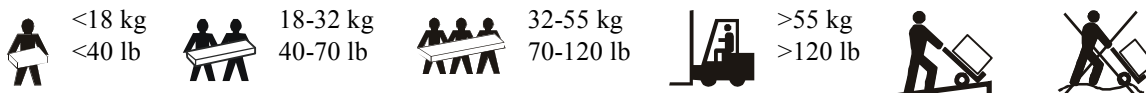

Safety and General Information

- Adhere to all national and local electrical codes.
- All wiring must be performed by a qualified electrician.
- Changes and modifications to this unit not expressly approved by APC could void the warranty.
- This UPS is intended for indoor use only.
- Do not operate this UPS in direct sunlight, in contact with fluids, or where there is excessive dust or humidity.

- Be sure the air vents on the UPS are not blocked. Allow adequate space for proper ventilation.
- For a UPS with a factory installed power cord, connect the UPS power cable directly to a wall outlet. Do not use surge protectors or extension cords.
- The battery typically lasts for five to eight years. Environmental factors impact battery life. Elevated ambient temperatures, poor quality mains power, and frequent short duration discharges will shorten battery life.
- Replace the battery immediately when the UPS indicates battery replacement is necessary.
- The equipment is heavy. Always practice safe lifting techniques adequate for the weight of the equipment.
- Always install XLBPs at the bottom in rack-mount configurations. The UPS must be installed above the XLBPs.
- Always install peripheral equipment above the UPS in rack-mount configurations.
- Additional safety information can be found in the Safety Guide supplied with this unit.

Deenergizing safety

Battery packs connected to the UPS may present a shock hazard even when disconnected from the branch circuit (mains). Before installing or servicing the equipment verify the following:

- Mains circuit breaker is in the **OFF** position. The UPS is disconnected from mains or wall outlet.
- Battery packs are disconnected.

Electrical safety

- In order to maintain compliance with the EMC directive for products sold in Europe, output cords attached to the UPS must not exceed 10 meters in length.
- The protective earth conductor for the UPS carries the leakage current from the load devices (computer equipment). An insulated ground conductor is to be installed as part of the branch circuit that supplies the UPS. The conductor must have the same size and insulation material as the grounded and ungrounded branch circuit supply conductors. The conductor will typically be green and with or without a yellow stripe.
- The UPS input ground conductor must be properly bonded to protective earth at the service panel.
- If the UPS input power is supplied by a separately derived system, the ground conductor must be properly bonded at the supply transformer or motor generator set.

Battery safety

- Schneider Electric uses Lithium Ion (NMC) batteries. Under normal use and handling, there is no contact with the internal components of the battery.
- **CAUTION:** Before installing or replacing the batteries, remove conductive jewelry such as chains, wrist watches and rings. High energy through conductive materials could cause severe burns.
- **CAUTION:** Do not dispose of batteries in a fire. The batteries may explode.
- **CAUTION:** Do not open the battery pack enclosure. Doing so will expose the cell terminals which pose an energy hazard.

General information

- The UPS will recognize as many as 5 battery packs connected to the UPS.
Note: For each battery pack added, increased recharge time will be required.
- The model and serial numbers are located on a small, rear panel label. For some models, an additional label is located on the chassis under the front bezel.
- Always recycle used batteries.
- Recycle the package materials or save them for reuse.

Product Description

The APC by Schneider Electric Smart-UPS™ On-Line SRT is a high performance uninterruptible power supply (UPS). The UPS helps to provide protection for electronic equipment from utility power blackouts, brownouts, sags, surges, small utility power fluctuations and large disturbances. The UPS also provides battery backup power for connected equipment until utility power returns to acceptable levels or the batteries are completely discharged.

This user manual is available on the enclosed Documentation CD and on the APC by Schneider Electric web site, www.apc.com.

Product Overview

Specifications

For additional specifications refer to the APC by Schneider Electric web site, www.apc.com.

Environmental

Temperature	Operating	0° to 40° C (32° to 104° F)
	Storage	-15° to 45° C (5° to 113° F)
Elevation	Operating	0 - 3,000 m (0 - 10,000 ft)
	Storage	0 - 15,000 m (50,000 ft)
Humidity	0% to 95% relative humidity, non-condensing	
Protection Class	IP 20 rating	

Physical

The UPS is heavy. Follow all lifting guidelines.

Unit weight, without packaging	13.7 kg (30.2 lb)
Unit weight, with packaging	21 kg (46.3 lb)
Unit dimensions without packaging Height x Width x Depth	85 (2U) mm x 432 mm x 560mm 3.35 (2U) in x 17 in x 22 in
Unit dimensions with packaging Height x Width x Depth	245 mm x 600 mm x 810 mm 9.7 in x 23.6 in x 31.9 in
The model and serial numbers are on a small label located on the rear panel.	

Battery

Battery type	Lithium Ion NMC chemistry
Typical energy capacity	600 watt-hours
Maximum continuous discharge rate	2 kW
Maximum charge rate Note: Battery pack will disconnect to protect cells if charge current exceeds 12 A. Note: Around 0° C, battery pack will automatically limit charge current to approximately 400 mA to protect the cells.	12 A
Battery capacity	12 Ah
Charge voltage for full capacity	58.1 VDC
Replacement battery module Refer to the appropriate replacement battery user manual for installation instructions. Contact your dealer or go the APC by Schneider Electric web site, www.apc.com for information on replacement battery module.	XBP48RM1U-LI Note: The UPS does not support any other type/make of battery packs.
Battery power cable length	600 mm (23.6 in)
Battery communication cable length	300 mm (11.8 in)

Electrical

CAUTION: To reduce the risk of fire, connect the UPS only to a circuit provided with recommended maximum branch circuit overcurrent protection.

Models	Rating	Building Circuit Breaker (CB) Current Rating
SRT1000 models	1000 VA / 900 W	16 A
SRT1500 models	1500 VA / 1350 W	

Output	
Output Frequency	50 Hz / 60 Hz
Nominal Output Voltage	220 V, 230 V, 240 V
Input	
Input Frequency	40 Hz - 70 Hz
Nominal Input Voltage	220 V, 230 V, 240 V
Input current rating	SRT1000 models: 5.5 A SRT1500 models: 8 A

Front Panel Features

- ❶ Display interface panel
- ❷ Bezel

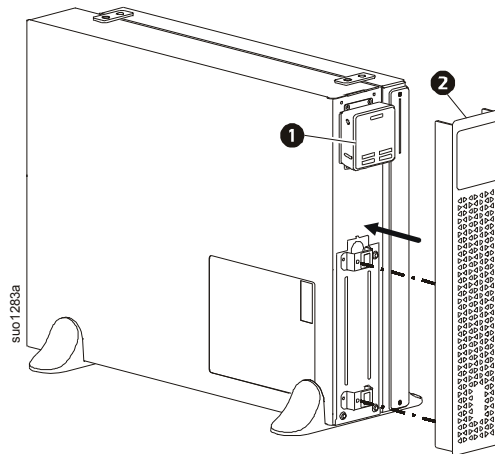

Rear Panel Features

Note: Refer to the table “Key to identify rear panel features” on page 6, that provides a key to the callout numbers for the rear panel graphics depicted in this manual.

SRT1000/1500 UXI-LI

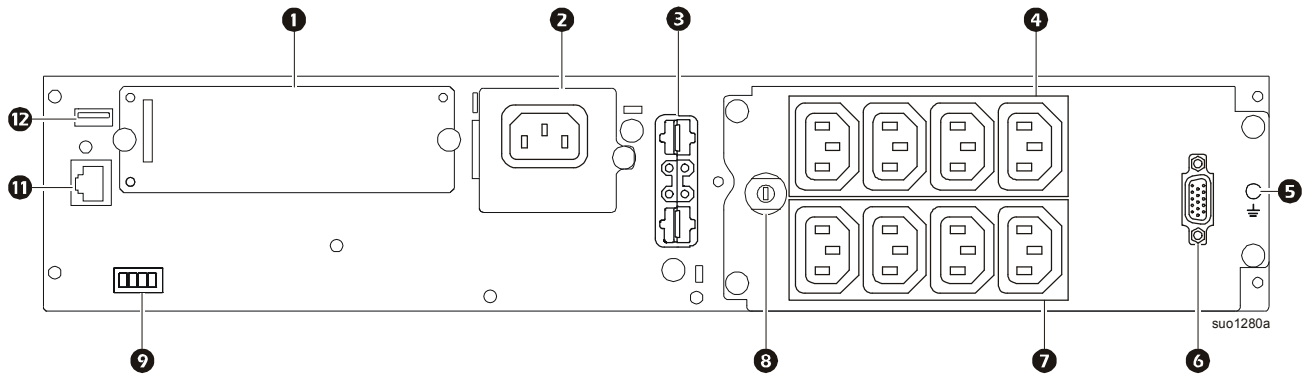

SRT1000/SRT1500 UXI-NCLI

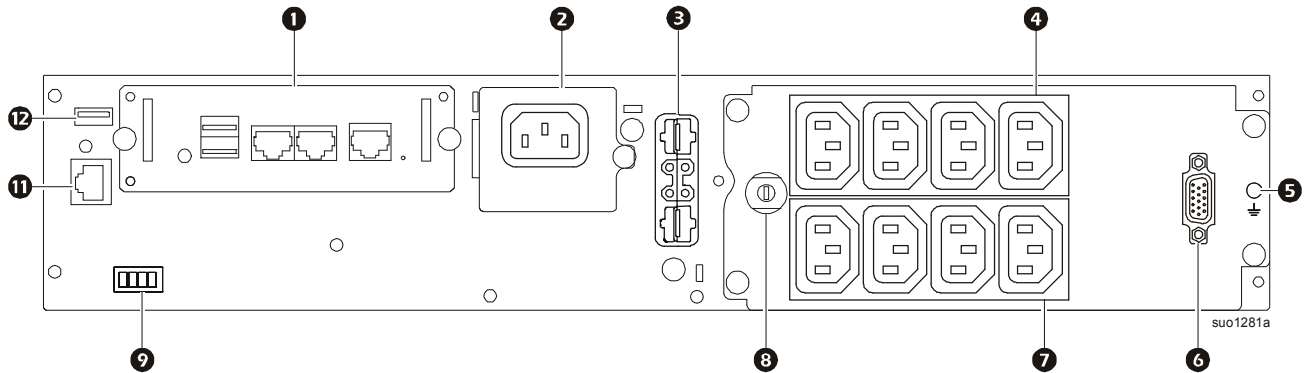

Key to identify rear panel features

❶	SmartSlot	The SmartSlot can be used to connect optional management accessories. SRT1000/SRT1500 UXI-NCLI: The UPS is pre-installed with network management card.
❷	AC inlet	Connect the UPS to utility power supply.
❸	Battery power and signal connector	Connect battery pack cable to connect the UPS and battery pack. Battery packs provide extended runtime during power outages. The UPS will automatically recognize up to 5 battery packs.
❹	Controllable outlet group 1	Connect electronic devices to these outlets.
❺	Chassis ground screws	The UPS and XLBPs have ground screws for connecting the ground leads. Prior to connecting a ground lead, disconnect the UPS from mains power.
❻	Battery communication port (DB15)	Connect the battery communication cable from the XLBP. This enables the communication between the XLBP and the UPS.
❼	Controllable outlet group 2	Connect electronic devices to these outlets.
❽	Input thermal circuit breaker	The circuit breaker protects the UPS from excessive load. It trips when excessive load is connected to the UPS.
❾	EPO terminal	The Emergency Power Off (EPO) terminal allows the user to connect the UPS to a central EPO system.
❿	Serial Com	The Serial Com port is used to communicate with the UPS. Use only interface kits supplied or approved by APC by Schneider Electric. Any other serial interface cable will be incompatible with the UPS connector.
⓫	USB port	The USB port is used to connect either a server for native operating system communications, or for software to communicate with the UPS.

Operation

Connect Equipment



CAUTION

RISK OF ELECTRIC SHOCK

- Disconnect the mains input circuit breaker before installing or servicing the UPS or connected equipment.
- Disconnect external batteries before installing or servicing the UPS or connected equipment.
- UPS AC hardwired and pluggable outlets may be energized by remote or automatic control at any time.
- Disconnect equipment from the UPS before servicing any equipment.

Failure to follow these instructions can result in minor or moderate injury.

Note: The XLBP will charge to 90% capacity in the first ten hours of normal operation. **Do not expect full battery runtime capability during this initial charge period.**

1. Connect the XLBP. See Installation manual for details.
2. Connect equipment to the outlets on the rear panel of the UPS.
Refer to “Controllable Outlet Groups” on page 16.
3. Connect the UPS to the building utility power.

Turn the UPS On/Off

The first time the UPS is turned on the **Setup Wizard** screen will run. Follow the prompts to configure UPS settings. Refer to “Configuration” on page 11.

To turn on the UPS and all connected equipment, press the POWER ON/OFF button on the display panel. Follow the prompts to either turn the UPS on immediately or after a delay, then press OK.

NOTE: When there is no input power and the UPS is off, the cold start feature can be used to turn on the UPS and connected equipment using battery power.

To perform a cold start press and hold the POWER ON/OFF button until a beep is heard.

The display panel will illuminate and the POWER ON/OFF button will illuminate red.

To turn on the output power press the POWER ON/OFF button again. Select the prompt **Turn ON with NO AC** and press OK.

To turn output power off, press the POWER ON/OFF button. Follow the prompts to either turn the UPS off immediately or after a delay, then press OK.

NOTE: Once the UPS output power has been turned off and the AC input has been removed, the UPS will continue to use the battery for internal power for 10 minutes. To remove power completely press the POWER ON/OFF button. Follow the prompt to select **Internal Power Off**, then press OK.

UPS Display Interface

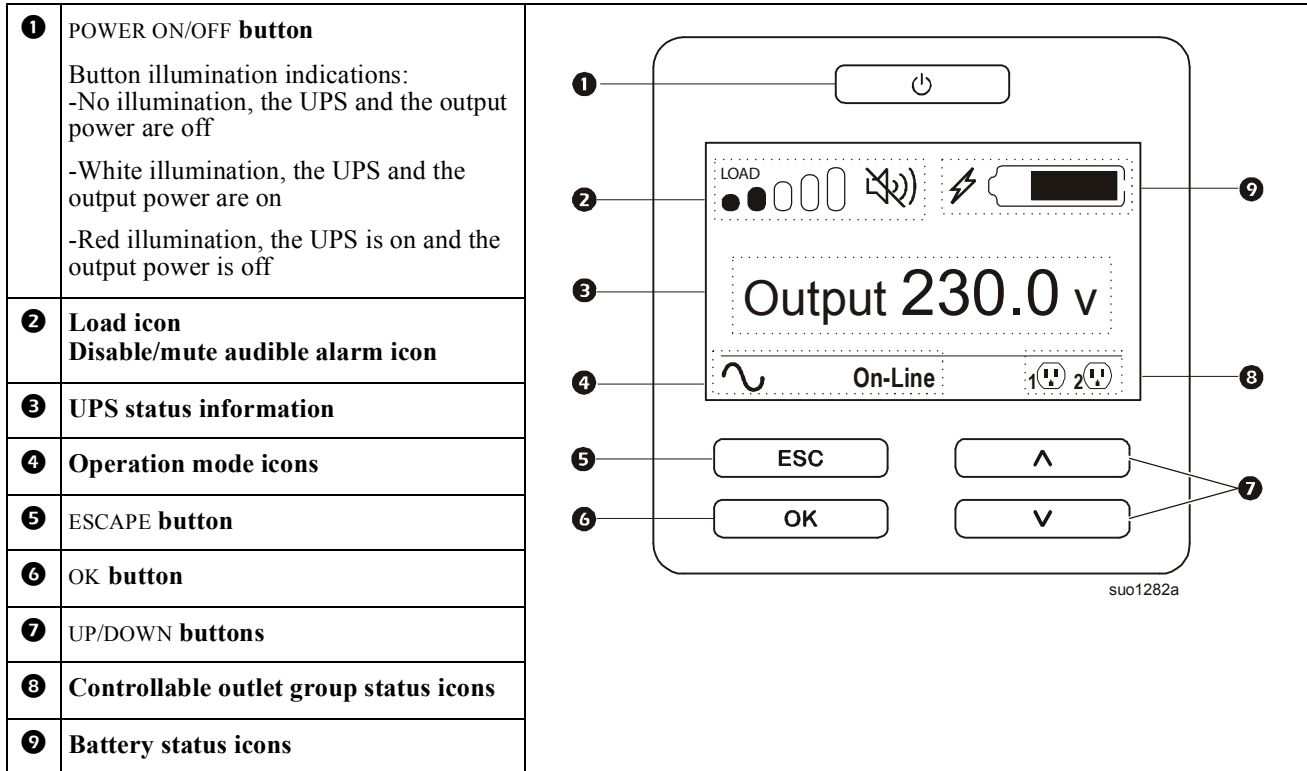

UPS Display Interface operation

Use the UP/DOWN buttons to scroll through the options. Press the OK button to accept the selected option. Press the ESC button to return to the previous menu.

The icons on the LCD display interface screen may vary depending on the installed firmware versions and specific UPS models.

	<p>Load icon: The approximate load capacity percentage is indicated by the number of load bar sections illuminated. Each bar represents 16% of the load capacity.</p>
	<p>Mute icon: Indicates the audible alarm is disabled/mute.</p>











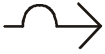

UPS Status Information

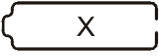
The status information field provides key information on the status of the UPS. The **Standard** menu will allow the user to select one of the five screens listed below. Use the UP/DOWN buttons to scroll through the screens.

The **Advanced** menu will scroll through the five screens automatically.

- **Input Voltage**
- **Output Voltage**
- **Output Frequency**
- **Load**
- **Runtime**

In the case of a UPS event, status updates will be displayed defining the event or condition that has occurred. The display screen illuminates amber to indicate a Message and red to indicate an Alert depending on the severity of the event or condition.

Operation Mode Icons	
	On-Line mode: The UPS is supplying conditioned mains power to connected equipment.
	Bypass mode: The UPS is in Bypass mode and the connected equipment will receive mains power as long as the input voltage and frequency are within the configured limits.
	Green mode: When in Green mode mains power is sent directly to the load. In the event of a mains power outage, there will be an interruption in power to the load of up to 10 ms while the UPS switches to On-Line or Battery mode. When enabling Green mode consideration should be given to devices that may be sensitive to power fluctuations.
UPS Status Icon	
	Battery mode: The UPS is supplying battery power to connected equipment.
	The UPS has detected an internal fault with the battery. Follow the instructions on the screen.
	The UPS has detected a critical fault with the battery. The battery is at the end of its life and has to be replaced.
	Indicates a UPS alert that requires attention.
Controllable Outlet Group Icons	
	Controllable Outlet Group Power Available: The number next to the icon identifies the specific outlet groups that have available power. Flashing icon indicates the outlet group is turning from OFF to ON with delay.
	
	Controllable Outlet Group Power Not Available: The number next to the icon identifies specific outlet groups that do not have available power. Flashing icon indicates the outlet group is turning from ON to OFF with delay.
	
Battery Status Icons	
	Battery Charge Status: Indicates the battery charge status.
	Battery Charge In Progress: Indicates the battery is charging.

LCD display interface angle adjustment

The angle of the LCD display interface can be adjusted for ease in viewing the displayed messages.

1. Remove the front bezel.
2. Locate the button on the bottom of the display interface panel.
3. Press the button and slide the bottom of the LCD display interface screen out. An audible click will be heard when the screen reaches the maximum angle.

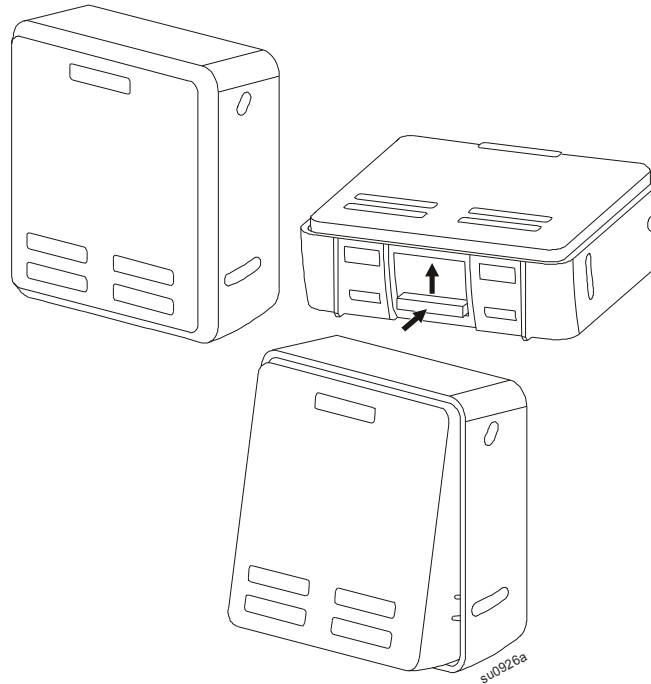

Menu overview

The UPS Display Interface has **Standard** and **Advanced** menu screens. The preference for **Standard** or **Advanced** menu selections is made during initial installation and can be changed at any time through the **Configuration** menu.

The **Standard** menus include the most commonly used options.

The **Advanced** menus provide additional options.

Note: Actual menu screens may differ by model and firmware version.

UPS Menu Overview

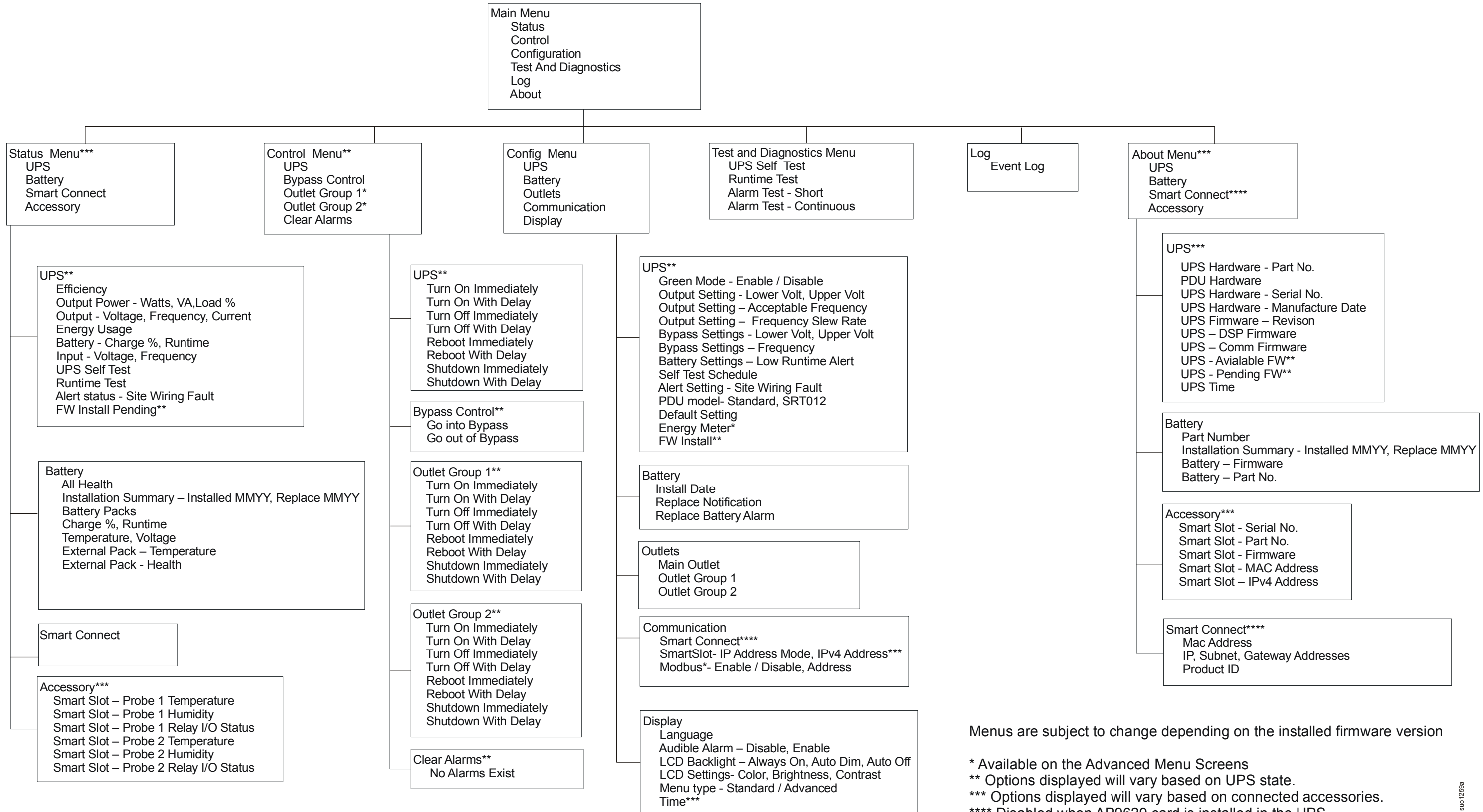

Menus are subject to change depending on the installed firmware version

- * Available on the Advanced Menu Screens
- ** Options displayed will vary based on UPS state.
- *** Options displayed will vary based on connected accessories.
- **** Disabled when AP9629 card is installed in the UPS.

Configuration

UPS Settings

There are three ways to select UPS configuration options.

1. The first time the UPS is turned on the **Setup Wizard** screen will open. On each menu screen select the desired settings. Press OK after each UPS setting is selected.

Note: The UPS will not turn on until all of the settings have been configured.

2. **Main Menu/Configuration/UPS/Default Setting.** This screen allows the user to reset the UPS to factory default settings. Press OK after the UPS setting is selected.
Refer to “Configuration” on page 11 and “UPS Menu Overview” .
3. Configure settings using an external interface, such as the Network Management Web interface.

Startup configuration

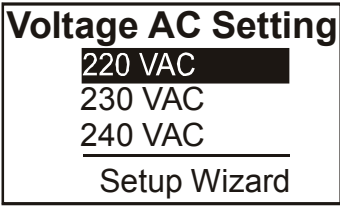
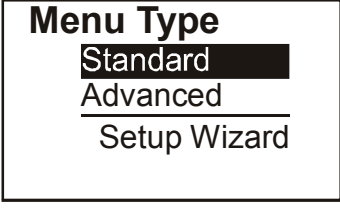
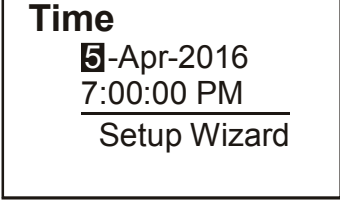
Function	Description
	<p>Select the language required for the display interface. Language options will vary by model and firmware version.</p> <p>Options:</p> <ul style="list-style-type: none"> • English • Francais • Italiano • Deutsch • Espanol • Portugues • Japanese • Russian
	<p>Select the output voltage. Options will vary by model.</p> <p>Options:</p> <ul style="list-style-type: none"> • 220 Vac • 230 Vac • 240 Vac
	<p>The Standard menu options are the most commonly used options. The Advanced menu options will be used by IT professionals who need detailed configuration and reporting information.</p>
	<p>The time menu option allows the user to set the date and time.</p>

General settings

Configure these settings at any time, using the display interface, or the Network Management Web Interface.

	Parameters	Default Value	Options	Description
Config Menu UPS	Green Mode	Disabled	Disable Enable	Disable or enable Green mode operation
	AC Setting	NA (see description)	220 V, 230 V, 240 V	Set the output voltage for the UPS. This setting can only be changed when the UPS output is off. These settings may vary depending on the UPS model. Default Value: The value selected by the user during initial startup. Reset to factory default does not change the selected value.
	Output Lower Acceptable Voltage	198 V for 220 V output 207 V for 230 V output 216 V for 240 V output	220 V - 186 to 198 V 230 V - 195 to 207 V 240 V - 204 to 216 V	If the UPS input voltage is between the lower acceptable voltage and the higher acceptable voltage, the UPS will operate in Green mode when enabled. If the output voltage goes outside the acceptable range the UPS will switch from Green mode to On-Line mode or to Battery mode.
	Output Upper Acceptable Voltage	242 V for 220 V output 253 V for 230 V output 264 V for 240 V output	220 V - 242 to 253 V 230 V - 253 to 265 V 240 V - 264 to 270 V	
	Output Frequency	Auto 50/60 ± 3Hz	Auto 50/60 ± 3 Hz 50 ± 0.1 Hz 50 ± 3.0 Hz 60 ± 0.1 Hz 60 ± 3.0 Hz	Set the output frequency for the UPS.
	Output Frequency Slew Rate	1 Hz/Sec	0.5 Hz/Sec 1 Hz/Sec 2 Hz/Sec 4 Hz/Sec	Select the rate of change for output frequency in Hertz per second.
	Bypass Lower Acceptable Voltage	160 V	220 V - 160 to 198 V 230 V - 160 to 207 V 240 V - 160 to 216 V	If the UPS input voltage is between the lower acceptable voltage and the higher acceptable voltage, the UPS can enter Bypass mode when enabled.
	Bypass Upper Acceptable Voltage	255 V for 220 V output 265 V for 230 V output 270 V for 240 V output	220 V - 242 to 264 V 230 V - 253 to 270 V 240 V - 264 to 270 V	
	Bypass Setting Acceptable Frequency	Wider Frequency 47 - 63 Hz	<ul style="list-style-type: none"> • Wider Frequency 47 - 63 Hz • Use Output Frequency Setting 	The setting Wider Frequency , enables Bypass mode operation for an input frequency range of 47-63 Hz.
	Low Runtime Alert	150 seconds	0 to 1800 seconds	The UPS will emit an audible alarm when the remaining runtime has reached this threshold.
Self Test Schedule	Startup + every 14 days since last test	<ul style="list-style-type: none"> • Never • Startup • Startup + 7 days • Startup + 14 days 	This is the interval at which the UPS will execute a Self Test .	

	Parameters	Default Value	Options	Description
Config Menu UPS	Site Wiring Fault	User Can Acknowledge	<ul style="list-style-type: none"> • Disable • Enable • User Can Acknowledge 	<p>Allows the user to configure the behavior of the UPS in response to the site wiring fault alert which is generated due to wrong input AC mains connection with input phase and neutral reversed.</p> <p>Disable: The UPS never indicates site wiring fault to the user.</p> <p>Enable: UPS alerts the user about site wiring fault, when detected. The alert cannot be reset until the site wiring fault is corrected.</p> <p>User Can Acknowledge: UPS alerts the user about site wiring fault, when detected. The alert is active till the user acknowledges it by pressing OK.</p>
	Default Setting	No	Yes/No	Allows the user to restore the UPS factory default settings.
	Reset Energy Meter	No	Yes/No	<p>The Energy Meter stores information on UPS output energy usage.</p> <p>The Reset feature allows the user to reset the Energy Meter to 0 kWh.</p>
	FW Install	Don't Install	<ul style="list-style-type: none"> • Don't Install • Now • Next Off 	<p>The message shows when the output is ON and the new firmware is available to install in the UPS. Select the option to install firmware update in the UPS.</p> <p>Note: If Now option is selected, the connected load will not be protected from input power outages and other input power disturbances during the duration of the FW update.</p>
Config Menu Battery	Install Date	Battery Installation Date	Month-Year	Enter the installation date of the battery pack.
	Replacement Notification Time	180 days	<ul style="list-style-type: none"> • 0-360 days • -1 	<p>To set the Near End of Life audible alarm, select the number of days before the estimated battery end of life.</p> <p>When this date is reached the UPS will emit an audible alarm and a message will appear on the display interface screen.</p> <p>Example: Using the default value, the Near End of Life audible alarm will occur 183 days before the estimated end of life date.</p> <p>To disable the notifications select -1.</p>
	Replacement Battery Alarm Time	14 days	<ul style="list-style-type: none"> • 0-180 days • -1 	<p>The Near End of Life audible alarm can be muted.</p> <p>Enter the number of days between the time a Near End of Life audible alarm is acknowledged and the next Near End of Life audible alarm occurs.</p> <p>To disable the notifications select -1.</p>

	Parameters	Default Value	Options	Description
Config Menu Display	Language	English	English Francais Italiano Deutsch Espanol Portugues Japanese Russian	Select the language required for the display interface. Language options will vary by model and firmware version.
	Audible alarm	Enable	• Disable • Enable	When audible alarms are disabled, the UPS will never emit an audible alarm.
	LCD Back Light	Auto Dim	Always On Auto Dim Auto Off	To conserve energy, the LCD back light illumination dims or turns off when no events are active. Full display interface illumination returns when the UPS changes status as a result of an event or when any button on the display interface is pressed.
	LCD Setting	Optimal Values	Color Brightness Contrast	Adjust the brightness and contrast individually for each LCD back light color.
	Menu Type	User Choice	Standard Advanced	The Standard menus include the most commonly used options. The Advanced menu options include all parameters.
	Time	UTC time Universal Time Coordinated (UTC) is a coordinated time scale, maintained by the Bureau International des Poids et Mesures (BIPM)]	DD-MMM-YYYY HH:MM:SS am/pm	Scroll through the fields to set the time.

	Parameters	Default Value	Options	Description
Config Menu Outlets	Power On Delay	0 seconds	0-1800 seconds	Select the amount of time the controllable outlet groups will wait between receiving the command to turn on and actual startup.
	Power Off Delay	90 seconds	0-32767 seconds	Select the amount of time the controllable outlet groups will wait between receiving the command to shutdown and actual shutdown.
	Reboot Duration	8 seconds	4-300 seconds	Select the amount of time the controllable outlet groups will remain off before the UPS will restart.
	Minimum Return Runtime	0 seconds	0-32767 seconds	Select the amount of battery runtime that must be available before the controllable outlet groups will turn on using battery power, after a shutdown.
	Loadshed Time On Battery	Disable	Disable Enable	To conserve battery power the UPS can disconnect power from controllable outlet groups not in use. To configure the disconnect delay time for this feature use the Loadshed Time On Battery setting.
	Loadshed Time On Battery	5 seconds	5-32767 seconds	Select the amount of time the controllable outlet groups will be allowed to function on battery power before shutdown.
	Loadshed On Runtime	Disable	Disable Enable	To conserve battery power the UPS can disconnect power from controllable outlet groups when the Loadshed Runtime threshold is reached.
	Loadshed Runtime	0 seconds	0-3600 seconds	When the selected runtime threshold is reached the UPS will shutdown the controllable outlet groups.
	Loadshed Overload	Disable	Disable Enable	To conserve energy in the event of an overload condition greater than 105% output, the controllable outlet groups will immediately turn off. The controllable outlet groups will only turn on again with a manual restart command once the overload condition has been corrected.
Config Menu Network Manage (for NC models only)	IP Address Mode		Manual, DHCP, BOOTP	Refer to the Network Management Utility CD.
	IP Address		Program IP, Subnet, Gateway	
Config Menu Communication Modbus	Modbus	Disable	Disable Enable	Allows the user to enable or disable the UPS Modbus functionality
	Modbus Address	1	1 - 223	Allows the user to select the Modbus address

Controllable Outlet Groups

Controllable Outlet Groups provide battery backup power to connected equipment.

Overview

The controllable outlet groups can be configured using the **Advanced** menu options. Refer to “General settings” on page 12.

The controllable outlet groups can be configured to independently **turn off, turn on, shutdown, switch to sleep mode, and reboot connected equipment.**

- **Turn Off:** Disconnect output power to connected equipment either immediately using the **Turn Off Immediately** feature or after a configured delay using the **Turn Off With Delay** feature.
NOTE: Controllable outlet groups can be turned on only using the **Turn On** feature.
- **Turn On:** Connect output power to connected equipment either immediately using the **Turn On Immediately** feature or after a configured delay using the **Turn On With Delay** feature.
- **Shutdown:** Disconnects the power to connected equipment either immediately or after a configured delay. Equipment reconnects after a configured delay when mains power becomes available and other configured conditions are met.
Each controllable outlet group can be configured separately to allow power sequencing for equipment connected to any controllable outlet group.
- **Reboot:** Disconnect the power to connected equipment either immediately or after a configured delay. Reconnect equipment after a configured delay when either mains or battery power becomes available and other configured conditions are met.
Each controllable outlet group can be configured separately to allow power sequencing for loads connected to any controllable outlet group.
- **Sleep:** This mode is a reboot with an extended duration where a outlet(s) remain turned off. Disconnect the power to connected equipment either immediately or after a configured delay. Reconnect equipment after a configured delay when either mains or battery power becomes available and other configured conditions are met.
Each controllable outlet group can be configured separately to allow power sequencing for equipment connected to any controllable outlet group.
To configure Sleep mode use an external interface, such as the Network Management Web interface.
- **Automatically turn off or shutdown** when certain conditions occur, based on user configurations set using the Config Menu Outlets menus. Refer to “Configuration” on page 11

Connect controllable outlet groups

- Connect critical equipment to one controllable outlet group.
- Connect peripheral equipment to the other controllable outlet groups.
 - To conserve battery runtime during a power outage, nonessential equipment can be configured to shut down. Use **Loadshed Time on Battery Enable/Disable** and **Loadshed Time on Battery Setting** defined in the General Settings section. Refer to “General settings” on page 12.
 - If equipment has dependent peripherals that must restart or shut down in a specific sequence, such as an ethernet switch that must restart before a connected server can be restarted, connect the devices to different outlet groups. Each controllable outlet group can be configured independently of the other groups.
- Use the **Configuration** menus to configure how the controllable outlet groups will react in the event of a power outage.

Emergency Power Off

Overview

The Emergency Power Off (EPO) option is a feature that will immediately disconnect all connected equipment from mains power. The UPS will immediately shut down and will not switch to battery power. Connect each UPS to the EPO switch. If multiple units are to be controlled with an EPO switch, each UPS must be connected separately to the EPO switch.

The UPS must be restarted for power to return to connected equipment. Press the ON/OFF button on the front panel of the UPS.

CAUTION

RISK OF ELECTRIC SHOCK

- Adhere to all national and local electrical codes.
- Wiring must be performed by a qualified electrician.
- Always connect the UPS to a grounded outlet.

Failure to follow these instructions can result in minor or moderate injury.

Normally open contacts

1. If the EPO switch or relay contacts are normally open, insert the wires from the switch or contacts at pins 1 and 2 of the EPO terminal block. Use 16-28 AWG wire.
2. Secure the wires by tightening the screws.

If the contacts are closed, the UPS will turn OFF and power will be removed from the load.

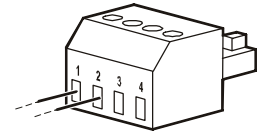

Normally closed contacts

1. If the EPO switch or relay contacts are normally closed, insert the wires from the switch or contacts at pins 2 and 3 of the EPO terminal block. Use 16-28 AWG wire.
2. Insert a wire jumper between pins 1 and 2. Secure the wires by tightening the three screws at positions 1, 2, and 3.

If the contacts are opened, the UPS will turn OFF and power will be removed from the load.

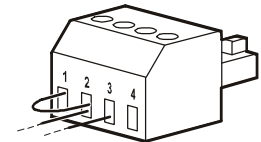

Note: Pin 1 is the power source for the EPO circuit, it provides a few milliamperes of 24 V power.

If the normally closed (NC) EPO configuration is used, the EPO switch or relay should be rated for “dry” circuit applications, the rating should be for low voltage and low current applications. This normally implies the contacts are gold plated.

The EPO interface is a Safety Extra Low Voltage (SELV) circuit. Connect the EPO interface only to other SELV circuits. The EPO interface monitors circuits that have no determined voltage potential. SELV circuits are controlled by a switch or relay properly isolated from mains power. To avoid damage to the UPS, do not connect the EPO interface to any circuit other than a SELV circuit.

Use one of the following cable types to connect the UPS to the EPO switch.

- CL2: Class 2 cable for general use.
- CL2P: Plenum cable for use in ducts, plenums, and other spaces used for environmental air.
- CL2R: Riser cable for use in a vertical run in a floor to floor shaft.
- CLEX: Limited use cable for use in dwellings and for use in raceways.
- Installation in Canada: Use only CSA certified, type ELC, (extra low voltage control cable).
- Installation in countries other than Canada and the USA: Use standard low voltage cable in accordance with national and local regulations.

Smart Battery Management

Definitions

- **Smart External Battery Pack (XLBP):** An enclosure that contains cells and battery management electronics. Replacement XLBP can be ordered from the APC by Schneider Electric web site, www.apc.com.
- **User Interface (UI):** Any interface by which a user can interact with the system. This includes a UPS display interface.

NOTE: Do not use a battery that is not APC by Schneider Electric approved.

The system will not detect the presence of a non APC by Schneider Electric approved battery and may adversely affect the operation of the system.

Use of a non APC by Schneider Electric approved battery will void the manufacturer warranty.

Maintenance

- **Battery health monitoring:** The battery energy output and voltage are monitored to assess the health of the installed batteries when the UPS is operating on battery. Battery health monitoring is done during a **UPS Self Test**, a **Runtime Calibration Test**, and when the UPS is operating on battery power. The UPS can be configured to perform periodic, automatic **Self Tests**.

End of useful life

- **Near end of life notification:** A message will appear on the UPS display interface screen when each XLBP is approaching the end of its useful life. For configuration details refer to **Replacement Notification Time** and **Replacement Battery Alarm Time** in the UPS Operation Manual.
- **Needs replacement notification:** The UPS display interface screen shows when XLBP replacement is required. The XLBP must be replaced as soon as possible.
- Recycle the XLBP. Do not disassemble.

Recommended actions after installing new XLBPs

Refer to the UPS Operation Manual for details on **Test and Diagnostics Menu** options for the following tests:

- Self Test
- Runtime Test
- Visible Alarm Test

The following actions should be performed after installing a new XLBP:

- Verify that the UPS is connected to input power and output power is turned on.
- When a new XLBP is installed, verify that the XLBP is detected by the system.
 - Perform a **UPS Visible Alarm Test**.
 - Check that the LED on all installed XLBPs is lit.
 - Allow the XLBP to charge for at least 24 hours.
- Verify that the UPS load is greater than 400 watts. This can be verified through the UPS display interface.
- Perform a **UPS Self Test**.
- If at the time of XLBP installation UPS input power is not available, turn on the UPS output from battery power for 30 seconds. This will allow the UPS to detect all installed XLBPs. Refer to the UPS Operation Manual for instructions on how to turn the UPS on and off.
- Verify on the UPS display interface that the installation dates for the replaced XLBPs are set to the current date.

The installation dates can be changed manually on the UPS display interface.
For configuration details refer to **Battery Install Date** in the UPS Operation Manual.

- Allow the system to charge for 24 hours to ensure full runtime capability.
- Initiate a **Runtime Calibration Test** through the UI.

XLBP installation and replacement

Refer to the External Battery Pack Installation Guide for installation and replacement instructions.

Troubleshooting

Use the table below to solve minor installation and operation problems.

Refer to the APC by Schneider Electric web site, www.apc.com for assistance with complex UPS problems. The UPS features firmware that can be upgraded.

Go to the APC by Schneider Electric web site, www.apc.com/Support, or contact your local Customer Care Center for more information.

Problem and Possible Cause	Solution
UPS is not turning on or there is no output	
The UPS is not connected to mains power.	Be sure the power cable is securely connected to the mains power supply.
The UPS display interface screen shows very low or no mains power.	Check the mains power supply to verify acceptable power quality.
There is an internal UPS alert or message.	The UPS Display Interface screen will show a message to identify the alert or message and corrective action.
UPS emits an audible alarm	
Normal UPS operation when running on battery power.	The UPS is operating on battery power. Refer to the status of the UPS as shown on the UPS Display Interface screen. Press any key to mute all audible alarms.
The UPS emits an audible alarm and has a red or amber back light on the UPS Display Interface screen.	The UPS has detected a fault. Refer to the display interface screen for information.

Problem and Possible Cause	Solution
UPS does not provide expected backup time	
The UPS batteries are weak due to a recent power outage or they are near the end of service life.	Charge the batteries. Batteries require recharging after extended outages and wear out faster when put into service often or when operated at elevated temperatures. If the batteries are near the end of service life, consider replacing the batteries even if the Replace Battery message is not displayed.
The UPS is experiencing an overload condition.	<p>The connected equipment exceeds the specified maximum load. Refer to the APC by Schneider Electric web site, www.apc.com for product specifications.</p> <p>The UPS will emit a sustained audible alarm until the overload condition is corrected.</p> <p>Disconnect nonessential equipment from the UPS to correct the overload condition.</p>
UPS operates on battery power while connected to mains power	
The input thermal circuit breaker has tripped.	Reduce the load on the UPS. Disconnect nonessential equipment and reset the circuit breaker by pressing the plunger in.
The building circuit breaker has tripped.	Reduce the load on the UPS. Disconnect nonessential equipment and reset the circuit breaker. Check the circuit breaker rating for the connected equipment.
There is very high, very low, or distorted input line voltage.	<p>Navigate to the UPS Display Interface screen that shows input voltage. Verify that the input voltage is within specified operating limits.</p> <p>If no input voltage is indicated on the UPS Display Interface screen, contact Customer Support through the APC by Schneider Electric web site, www.apc.com.</p>
The UPS Display Interface screen shows the message Waiting for Minimum Runtime .	The UPS has been configured to operate for a specified period of runtime. The setting can be changed through the Config/UPS menus.
UPS Display Interface Status screen shows Overload and the UPS emits a sustained audible alarm	
The UPS is experiencing an overload condition.	<p>The connected equipment exceeds the maximum load rating for the UPS.</p> <p>The UPS will emit a sustained audible alarm until the overload condition is corrected.</p> <p>Disconnect nonessential equipment from the UPS to correct the overload condition.</p>
UPS Display Interface Status screen shows UPS is operating in Bypass mode	
The UPS received a command to operate in Bypass mode	No action is required.
The UPS has automatically switched to Bypass mode due to an internal UPS alert or message.	The UPS Display Interface screen will show a message to identify the alert or detected error and corrective action.

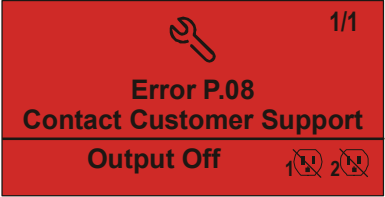
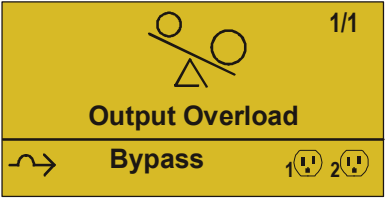
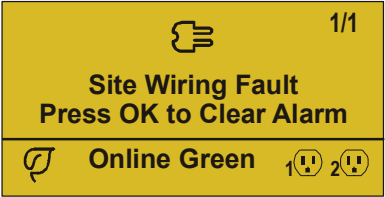
Problem and Possible Cause	Solution
<p>UPS Display Interface is red or amber and shows an alert or message The UPS emits a sustained audible alarm</p>	
<p>The UPS has detected a problem during normal operation.</p>	<p>Follow the instructions on the UPS Display Interface screen. Press any key to mute all audible alarms.</p>
<p>The UPS Display Interface screen shows the message Disconnected Battery.</p>	<p>Be sure the battery cables are securely connected. Perform a UPS Self Test to be sure the UPS detects all connected batteries. To perform a UPS Self Test use the UPS Display Interface menu option Test and Diagnostics.</p>
<p>The UPS Display Interface screen shows the message Replace Battery.</p>	<p>Replace all of the batteries. Contact APC by Schneider Electric customer support.</p>
<p>The UPS display turns red or amber, displays an alert message, and emits a sustained audible alarm. Red illumination indicates a UPS alarm that requires immediate attention. Amber illumination indicates a UPS alarm that requires attention.</p>	
<p>There is an internal UPS alert or message..</p> 	<p>Do not attempt to use the UPS. Turn the UPS off and have it serviced immediately.</p>
<p>The UPS is experiencing an overload condition.</p> 	<p>Reduce the load on the UPS. Disconnect nonessential equipment.</p>
<p>The UPS has detected a Site Wiring Fault.</p> 	<p>Correct the building site wiring fault or ignore this message. See Config Menu UPS in “General settings” on page 12.</p>

Problem and Possible Cause	Solution
The Replace Battery alert is displayed	
The battery has a weak charge.	Allow the battery to recharge for at least ten hours. Then, perform a UPS Self Test . If the problem persists after recharging, replace the battery.
The replacement battery is not properly connected.	Be sure the battery cable is securely connected.

Transport

1. Shut down and disconnect all connected equipment.
2. Disconnect the unit from mains power.
3. Disconnect all internal and external batteries (if applicable).
4. Follow the shipping instructions outlined in the *Service* section of this manual.

Service

If the unit requires service, do not return it to the dealer. Follow these steps:

1. Review the *Troubleshooting* section of the manual to eliminate common problems.
2. If the problem persists, contact APC by Schneider Electric Customer Support through the APC by Schneider Electric web site, **www.apc.com**.
 - a. Note the model number and serial number and the date of purchase. The model and serial numbers are located on the rear panel of the unit and are available through the LCD display on select models.
 - b. Call Customer Support. A technician will attempt to solve the problem over the phone. If this is not possible, the technician will issue a Returned Material Authorization Number (RMA#).
 - c. If the unit is under warranty, the repairs are free.
 - d. Service procedures and returns may vary internationally. For country specific instructions refer to the APC by Schneider Electric web site, **www.apc.com**.
3. Pack the unit properly to avoid damage in transit. Never use foam beads for packaging. Damage sustained in transit is not covered under warranty.
Note: Before shipping, always disconnect battery modules in the external battery pack. The disconnected internal batteries may remain inside the UPS or external battery pack.
4. Write the RMA# provided by Customer Support on the outside of the package.
5. Return the unit by insured, prepaid carrier to the address provided by Customer Support.

Limited Factory Warranty

Schneider Electric IT Corporation (SEIT), warrants its products to be free from defects in materials and workmanship for a period of five (5) years from the date of purchase. The SEIT obligation under this warranty is limited to repairing or replacing, at its own sole option, any such defective products. Repair or replacement of a defective product or part thereof does not extend the original warranty period.

This warranty applies only to the original purchaser who must have properly registered the product within 10 days of purchase. Products may be registered online at warranty.apc.com.

SEIT shall not be liable under the warranty if its testing and examination disclose that the alleged defect in the product does not exist or was caused by end user or any third person misuse, negligence, improper installation, testing, operation or use of the product contrary to SEIT recommendations of specifications. Further, SEIT shall not be liable for defects resulting from: 1) unauthorized attempts to repair or modify the product, 2) incorrect or inadequate electrical voltage or connection, 3) inappropriate on site operation conditions, 4) Acts of God, 5) exposure to the elements, or 6) theft. In no event shall SEIT have any liability under this warranty for any product where the serial number has been altered, defaced, or removed.

EXCEPT AS SET FORTH ABOVE, THERE ARE NO WARRANTIES, EXPRESS OR IMPLIED, BY OPERATION OF LAW OR OTHERWISE, APPLICABLE TO PRODUCTS SOLD, SERVICED OR FURNISHED UNDER THIS AGREEMENT OR IN CONNECTION HERewith.

SEIT DISCLAIMS ALL IMPLIED WARRANTIES OF MERCHANTABILITY, SATISFACTION AND FITNESS FOR A PARTICULAR PURPOSE.

SEIT EXPRESS WARRANTIES WILL NOT BE ENLARGED, DIMINISHED, OR AFFECTED BY AND NO OBLIGATION OR LIABILITY WILL ARISE OUT OF, SEIT RENDERING OF TECHNICAL OR OTHER ADVICE OR SERVICE IN CONNECTION WITH THE PRODUCTS.

THE FOREGOING WARRANTIES AND REMEDIES ARE EXCLUSIVE AND IN LIEU OF ALL OTHER WARRANTIES AND REMEDIES. THE WARRANTIES SET FORTH ABOVE CONSTITUTE SEIT'S SOLE LIABILITY AND PURCHASER EXCLUSIVE REMEDY FOR ANY BREACH OF SUCH WARRANTIES. SEIT WARRANTIES EXTEND ONLY TO ORIGINAL PURCHASER AND ARE NOT EXTENDED TO ANY THIRD PARTIES.

IN NO EVENT SHALL SEIT, ITS OFFICERS, DIRECTORS, AFFILIATES OR EMPLOYEES BE LIABLE FOR ANY FORM OF INDIRECT, SPECIAL, CONSEQUENTIAL OR PUNITIVE DAMAGES, ARISING OUT OF THE USE, SERVICE OR INSTALLATION OF THE PRODUCTS, WHETHER SUCH DAMAGES ARISE IN CONTRACT OR TORT, IRRESPECTIVE OF FAULT, NEGLIGENCE OR STRICT LIABILITY OR WHETHER SEIT HAS BEEN ADVISED IN ADVANCE OF THE POSSIBILITY OF SUCH DAMAGES. SPECIFICALLY, SEIT IS NOT LIABLE FOR ANY COSTS, SUCH AS LOST PROFITS OR REVENUE, WHETHER DIRECT OR INDIRECT, LOSS OF EQUIPMENT, LOSS OF USE OF EQUIPMENT, LOSS OF SOFTWARE, LOSS OF DATA, COSTS OF SUBSTITUANTS, CLAIMS BY THIRD PARTIES, OR OTHERWISE.

NOTHING IN THIS LIMITED WARRANTY SHALL SEEK TO EXCLUDE OR LIMIT SEIT LIABILITY FOR DEATH OR PERSONAL INJURY RESULTING FROM ITS NEGLIGENCE OR ITS FRAUDULENT MISREPRESENTATION OF TO THE EXTENT THAT IT CANNOT BE EXCLUDED OR LIMITED BY APPLICABLE LAW.

To obtain service under warranty you must obtain a Returned Material Authorization (RMA) number from customer support. Customers with warranty claims issues may access the SEIT worldwide customer support network through the APC by Schneider Electric web site: www.apc.com. Select your country from the country selection drop down menu. Open the Support tab at the top of the web page to obtain information for customer support in your region. Products must be returned with transportation charges prepaid and must be accompanied by a brief description of the problem encountered and proof of date and place of purchase.

APC by Schneider Electric Worldwide Customer Support

Customer support for this or any other APC by Schneider Electric product is available at no charge in any of the following ways:

- Visit the APC by Schneider Electric web site to access documents in the APC by Schneider Electric Knowledge Base and to submit customer support requests.
 - **www.apc.com** (Corporate Headquarters)
Connect to localized APC by Schneider Electric web sites for specific countries, each of which provides customer support information.
 - **www.apc.com/support/**
Global support searching APC by Schneider Electric Knowledge Base and using e-support.
- Contact the APC by Schneider Electric Customer Support Center by telephone or e-mail.
 - Local, country specific centers: go to **www.apc.com/support/contact** for contact information.
 - For information on how to obtain local customer support, contact the APC by Schneider Electric representative or other distributor from whom you purchased your APC by Schneider Electric product.

© 2021 APC by Schneider Electric. APC, the APC logo, and Smart-UPS are owned by Schneider Electric Industries S.A.S. or their affiliated companies. All other trademarks are property of their respective owners.