

# MC3400/MC3450

Mobile Computer



**ZEBRA**

## **Quick Start Guide**

2024/07/31

ZEBRA and the stylized Zebra head are trademarks of Zebra Technologies Corporation, registered in many jurisdictions worldwide. All other trademarks are the property of their respective owners. ©2024 Zebra Technologies Corporation and/or its affiliates. All rights reserved.

Information in this document is subject to change without notice. The software described in this document is furnished under a license agreement or nondisclosure agreement. The software may be used or copied only in accordance with the terms of those agreements.

For further information regarding legal and proprietary statements, please go to:

SOFTWARE: [zebra.com/informationpolicy](https://zebra.com/informationpolicy).

COPYRIGHTS: [zebra.com/copyright](https://zebra.com/copyright).

PATENTS: [ip.zebra.com](https://ip.zebra.com).

WARRANTY: [zebra.com/warranty](https://zebra.com/warranty).

END USER LICENSE AGREEMENT: [zebra.com/eula](https://zebra.com/eula).

## Terms of Use

### Proprietary Statement

This manual contains proprietary information of Zebra Technologies Corporation and its subsidiaries ("Zebra Technologies"). It is intended solely for the information and use of parties operating and maintaining the equipment described herein. Such proprietary information may not be used, reproduced, or disclosed to any other parties for any other purpose without the express, written permission of Zebra Technologies.

### Product Improvements

Continuous improvement of products is a policy of Zebra Technologies. All specifications and designs are subject to change without notice.

### Liability Disclaimer

Zebra Technologies takes steps to ensure that its published Engineering specifications and manuals are correct; however, errors do occur. Zebra Technologies reserves the right to correct any such errors and disclaims liability resulting therefrom.

### Limitation of Liability

In no event shall Zebra Technologies or anyone else involved in the creation, production, or delivery of the accompanying product (including hardware and software) be liable for any damages whatsoever (including, without limitation, consequential damages including loss of business profits, business interruption, or loss of business information) arising out of the use of, the results of use of, or inability to use such product, even if Zebra Technologies has been advised of the possibility of such damages. Some jurisdictions do not allow the exclusion or limitation of incidental or consequential damages, so the above limitation or exclusion may not apply to you.

## Unpacking the Device

Follow these steps when unpacking the device for the first time.

1. Carefully remove all protective material from the device and save the shipping container for later storage and shipping.
2. Verify that the following items are in the box:
  - Mobile computer
  - Hand-strap (only with Straight Shooter configuration)
  - Lithium-ion battery
  - Regulatory guide
3. Inspect the equipment for damage. If any equipment is missing or damaged, contact the Global Customer Support Center immediately.
4. Before using the device for the first time, remove the protective shipping films that cover the scan window, display, and camera window.

## Features

This section lists the features of the MC3400/MC3450 mobile computer.

### Gun Configuration

This section lists the features of the MC34 gun configuration.



**NOTE:** The front/rear camera and camera flash are available only in Full Featured configurations, and the ambient light sensor is available only in Expanded and Full Featured configurations.

**Figure 1** Top View

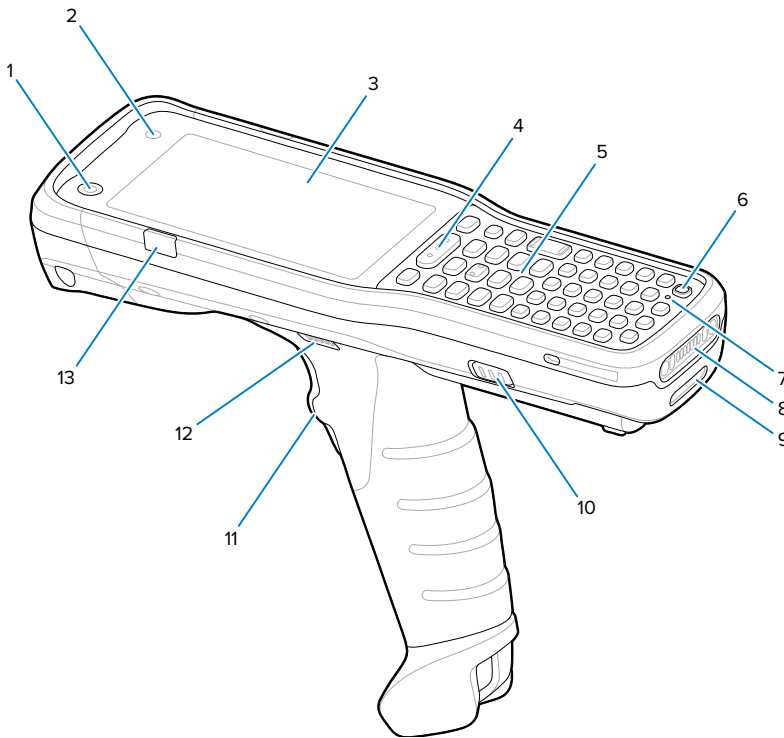

Number	Item	Description
1	5 MP front-facing camera	Take photos and videos. It is also used with Identity Guardian for facial biometrics authentication for Single Sign On (SSO).
2	Ambient light sensor	Determines ambient light for controlling display backlight intensity.
3	Display	Displays all information needed to operate the device.
4	Scan button	Initiates data capture when a scan application is enabled.
5	Keypad	Use to enter data and navigate on screen functions.
6	Power key	Press to turn on/off the display. Press and hold to select one of these options: <ul style="list-style-type: none"> <li>• <b>Power off</b> - Turn off the device.</li> <li>• <b>Restart</b> - Restart the device when the software stops responding.</li> </ul>
7	Microphone	Use for voice communications.
8	Charging I/O	Power/ground for charging and communication.
9	Hand strap slot	Attachment point for the hand strap.
10	Battery release latches	Releases the battery from the device.
11	Trigger	Initiates data capture when a scan application is enabled.
12	Speaker	Provides audio output for video and music playback.

Number	Item	Description
13	Charge/ Application notification LED or scan/decode status	Indicates the battery charge state while charging, an application notification was received, or the scan/decode status.

**Figure 2** Bottom View

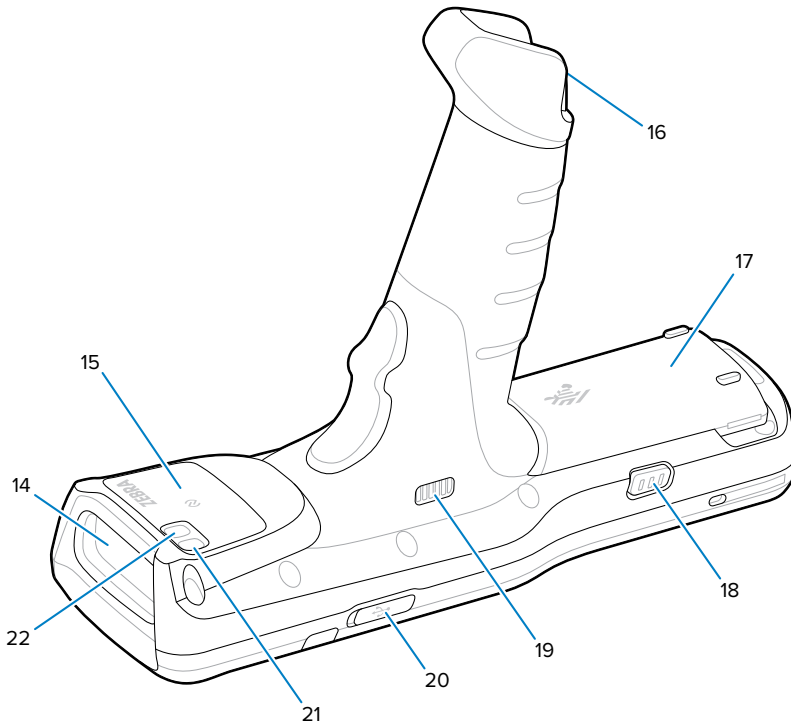

Number	Item	Description
14	Scanner exit window	Provides data capture using integrated imager option.
15	NFC antenna	Provides communication with other NFC-enabled devices.
16	Hand strap slot	Attachment point for the hand strap.
17	Battery	Provides power for operating the device.
18	Battery release latch	Releases the battery from the device.
19	Speacker	Provides audio output for video and music playback.
20	USB-C cover/ connector	Provides power and communications to the device using an I/O USB-C interface.
21	13 MP rear-facing camera	Take photos and videos.
22	Camera flash	Provides illumination for the camera.

## Straight Shooter Configuration

This section lists the features of the MC34 straight shooter configuration.



**NOTE:** The front/rear camera and camera flash are available only in Full Featured configurations, and the ambient light sensor is available only in Expanded and Full Featured configurations.

**Figure 3** Top View

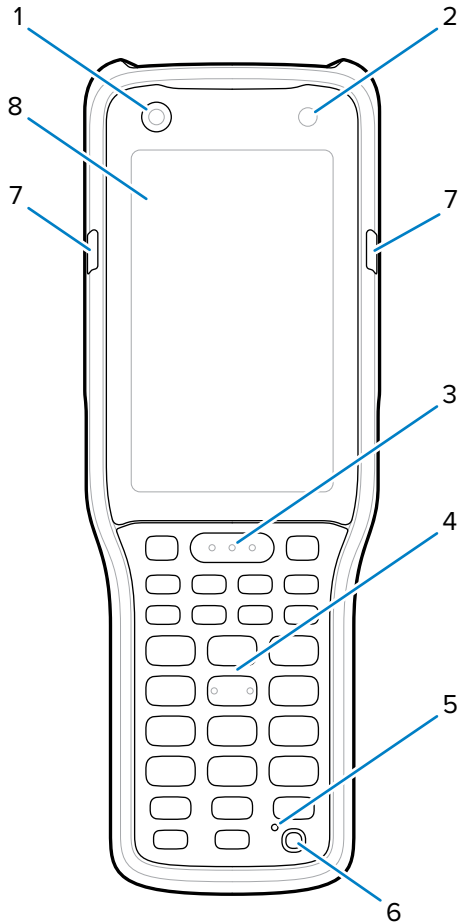

Number	Item	Description
1	5 MP front-facing camera	Take photos and videos. It is also used with Identity Guardian for facial biometrics authentication for Single Sign On (SSO).
2	Ambient light sensor	Determines ambient light for controlling display backlight intensity.
3	Scan button	Initiates data capture when a scan application is enabled.
4	Keypad	Use to enter data and navigate on screen functions.
5	Microphone	Use for voice communications.

Number	Item	Description
6	Power key	Press to turn on/off the device. Press and hold to select one of these options: <ul style="list-style-type: none"> <li>• <b>Power off</b> - Turn off the device.</li> <li>• <b>Restart</b> - Restart the device when the software stops responding.</li> </ul>
7	Charge/ Application notification LED or scan/decode status	Indicates the battery charge state while charging, an application notification was received, or the scan/decode status.
8	Display	Displays all information needed to operate the device.

**Figure 4** Bottom View

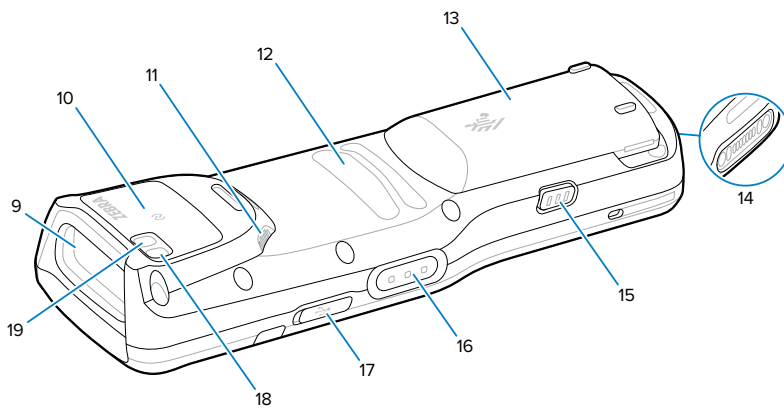

Number	Item	Description
9	Scanner exit window	Provides data capture using integrated imager option.
10	NFC antenna	Provides communication with other NFC-enabled devices.
11	Speaker	Provides audio output for video and music playback.
12	Finger perch	Provides grip of fingers on the device.
13	Battery	Provides power for operating the device.
14	Charging I/O	Power/ground for charging and communication.
15	Battery release latches	Releases the battery from the device.
16	Side key scan button	Initiates data capture when a scan application is enabled.
17	USB-C cover/ connector	Provides power and communications to the device using an I/O USB-C interface.
18	13 MP rear-facing camera	Take photos and videos.
19	Camera flash	Provides illumination for the camera.

## Installing a microSD Card

The microSD card slot (located under the battery pack) provides secondary, non-volatile storage. For more information, refer to the documentation provided with the microSD card and follow the manufacturer's recommendations for use. It is strongly recommended that you format the microSD card on the device before use.



**CAUTION:** Follow proper electrostatic discharge (ESD) precautions to avoid damaging the microSD card. Proper ESD precautions include, but are not limited to, working on an ESD mat and ensuring that the operator is properly grounded.

1. Remove the battery:
  - a) Push in the two battery release buttons.

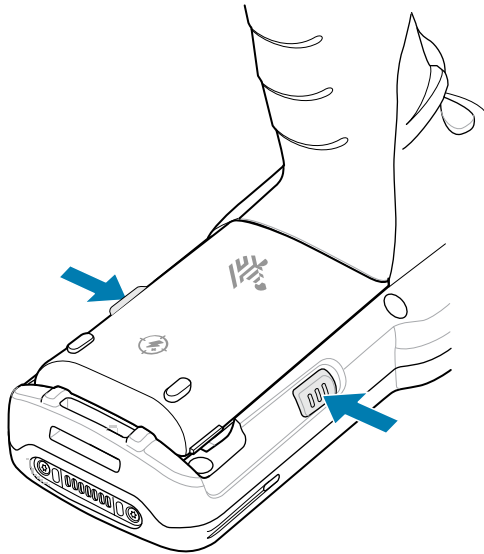

The battery ejects slightly.

- b) Remove the battery from the compartment.

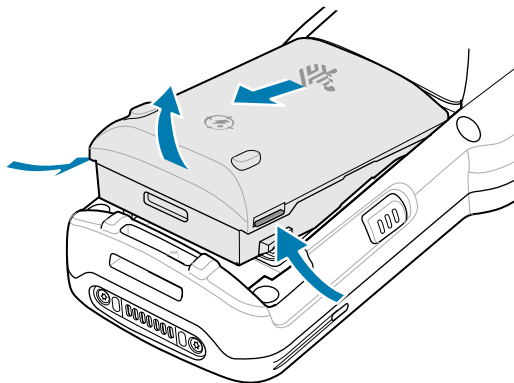



2. Using a coin or finger, remove the access cover.

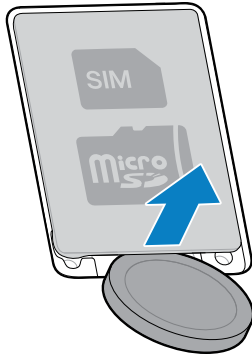

3. Slide the microSD card holder to the Open position.

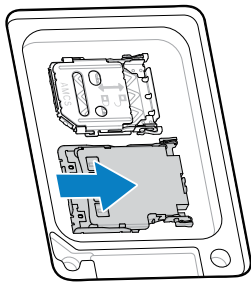

4. Lift the microSD card holder.

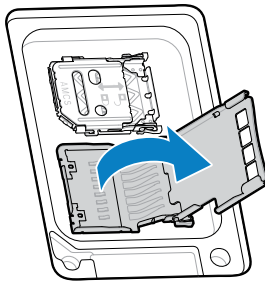

5. Insert the microSD card into the contact area with the contacts facing down.

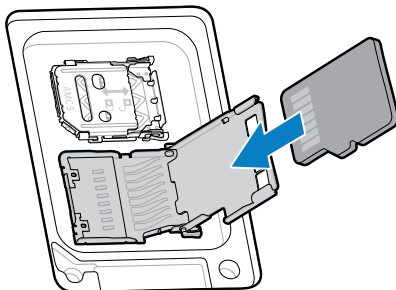

6. Close and slide the microSD card holder to the Lock position.

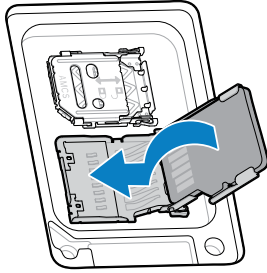

7. Re-install the access cover.

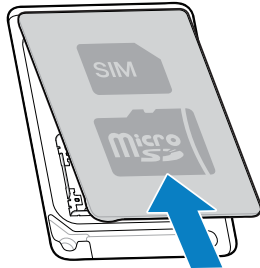

8. Re-install the battery.

## Installing a SIM Card

A SIM card or eSIM is required to make calls and transfer data over a cellular network with the MC3450. The SIM card slot is located under the battery pack.

The device also offers Dual SIM/Dual Standby (DSDS), which allows users to use both an eSIM and SIM card and remain on standby at any time.



**CAUTION:** Follow proper electrostatic discharge (ESD) precautions to avoid damaging the SIM card. Proper ESD precautions include but are not limited to, working on an ESD mat and ensuring the operator is properly grounded.

**1. Remove the battery:**

- a)** Push in the two battery release buttons.

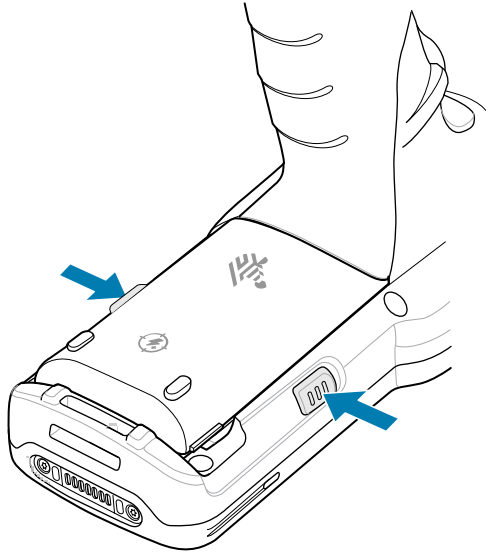

The battery ejects slightly.

- b)** Remove the battery from the compartment.

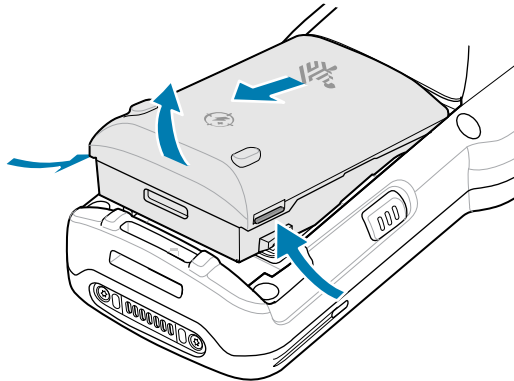

**2. Using a coin or finger, remove the access cover.**

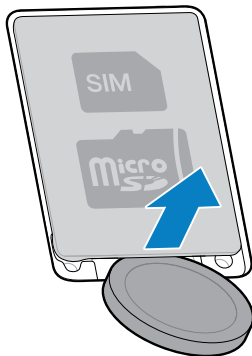

3. Slide the SIM cardholder to the right to unlock it.

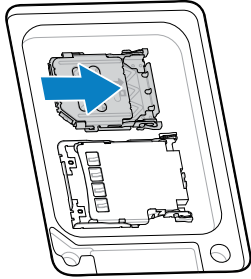

4. Lift the SIM card holder door.

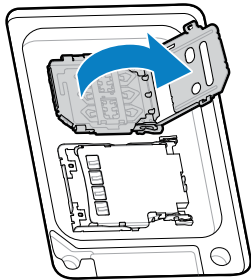

5. Place the SIM card into the cardholder with the contacts facing down.

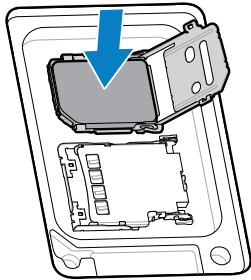

6. Close the SIM card holder door.

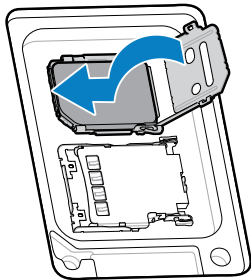

7. Slide the SIM card holder to the left to lock it.

8. Re-install the access cover.

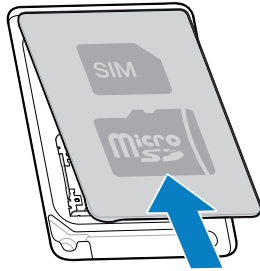

9. Re-install the battery.

## Activating an eSIM

Use an eSIM on the MC3450. Before using it, activate the eSIM.



**NOTE:** Before adding an eSIM, contact your carrier to obtain the eSIM service and its activation or QR code.

1. On the device, establish an internet connection via Wi-Fi or cellular data with an installed SIM card.
2. Go to **Settings**.
3. Touch **Network & internet > Mobile Networks**.
4. Touch + next to **SIMs** if a SIM card is already installed, or touch **SIMs** if there is no SIM card installed.  
The **Mobile network** screen displays.
5. Select:
  - **MANUAL CODE ENTRY** to enter the activation code, or
  - **SCAN** to scan the QR code to download the eSIM profile.
 The **Confirmation!!!** dialog box displays.
6. Touch **OK**.
7. Enter the activation code or scan the QR Code.
8. Touch **NEXT**.  
The **Confirmation!!!** dialog box displays.
9. Touch **ACTIVATE**.
10. Touch **Done**.  
The eSIM is now active

## Deactivating an eSIM

Turn off an eSIM temporarily and re-activate it later.

1. On the device, establish an internet connection via Wi-Fi or cellular data with an installed SIM card.
2. Touch **Network & internet > SIMs**.
3. In the **Downloaded SIM** section, touch the name of the eSIM to deactivate.
4. Touch **Use SIM** switch to turn off the eSIM.

5. Touch **Yes**.

The eSIM is deactivated.

## Erasing an eSIM Profile

Erasing an eSIM profile removes it completely from the MC3450.



**NOTE:** After erasing an eSIM from the device, you cannot use it again.

1. On the device, establish an internet connection via Wi-Fi or cellular data with an installed SIM card.
2. Touch **Network & internet > SIMs**.
3. In the **Downloaded SIM** section, touch the name of the eSIM to erase.
4. Touch **Erase**.  
The **Erase this downloaded SIM?** message displays.
5. Touch **Erase**.  
The eSIM profile is erased from the device.

## Installing the Battery

This section describes installing the battery for both gun and straight shooter configurations.

The device will not turn on if the battery voltage drops below 3.45 volts. To check the current battery voltage, refer to the Battery Manager section in the Product Reference Guide.

### Installing the Gun Battery

The device is shipped with the 7,000 mAh PowerPrecision+ battery. The MC34 rechargeable Li-Ion battery with BLE beacon is available as an option.

1. Loosen the hand strap, if needed.

2. Align the battery into the battery compartment.

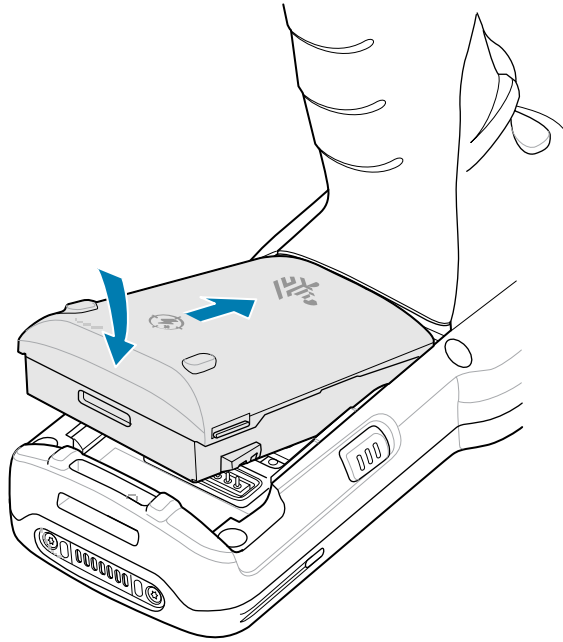

3. Slide the front of the battery into the battery compartment.
4. Press the battery down firmly. Ensure that both battery release buttons on the sides of the device return to the home position.

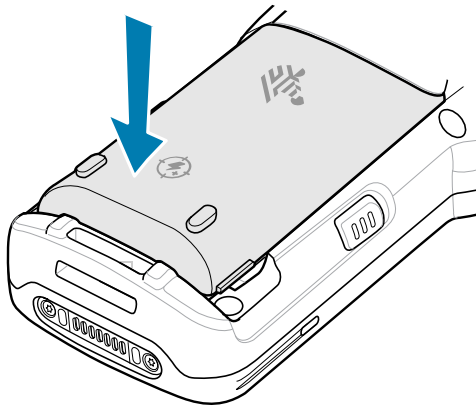

5. Tighten the hand strap if installed.
6. Press and hold the Power key (until you see a Zebra splash screen) to turn on the device.

## Installing the Straight Shooter Battery

The device is shipped with the 7,000 mAh PowerPrecision+ battery. The MC34 rechargeable Li-Ion battery with BLE beacon is available as an option.

1. Loosen the hand strap if needed.

2. Align the top of the battery into the battery compartment.

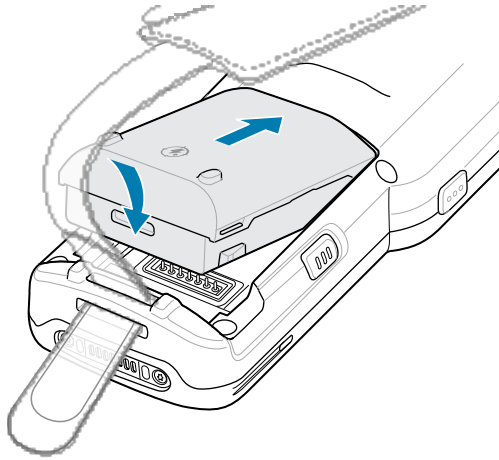

3. Slide the front of the battery into the battery compartment.
4. Press the battery down firmly.

Ensure that both battery release buttons on the sides return to the home position.

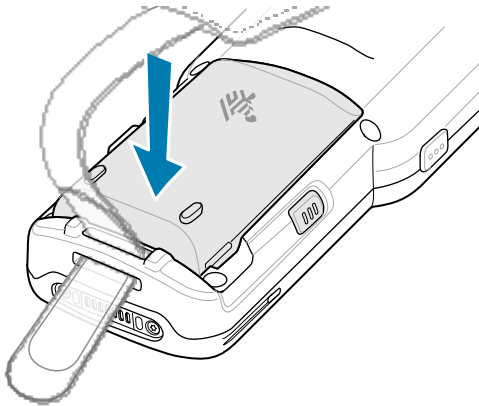

5. Tighten the hand strap if needed.
6. Press and hold the Power key (until you see a Zebra splash screen) to turn on the device.

## Battery Compatibility

The MC3400 and MC3450 use rechargeable Lithium-ion (Li-ion) batteries as their main power source.

MC34 devices are compatible with:

- MC34 7,000 mAh PowerPrecision+ extended-capacity Li-Ion battery (Battery P/N: BT-000375-0810/OA10)
- MC34 7,000 mAh PowerPrecision+ extended-capacity Li-Ion battery with BLE beacon (Battery P/N: BT-000375-081B/OA1B)



**NOTE:** MC34 batteries are also compatible with MC3300 and MC3300ax.



MC34 devices are also compatible with MC33 legacy batteries but with reduced ingress protection (IP) sealing:

- MC33 7,000 mAh PowerPrecision+ extended-capacity Li-Ion battery (Battery P/N: BT-000375-10/12/60)
- MC33 7,000 mAh PowerPrecision+ extended capacity Li-Ion battery with BLE Beacon (Battery P/N: BT-000444-10/12/60)
- MC33 5,200 mAh PowerPrecision+ high-capacity Li-Ion battery (Battery P/N: BT-000337-00/01/02)

## Rechargeable Li-Ion Battery with BLE Beacon

The rechargeable Li-Ion battery with BLE beacon is a 7,000 mAh PowerPrecision+ battery with a BLE beacon that allows users to track lost and powered-off devices. The device ships with a 7,000 mAh PowerPrecision+ battery. A rechargeable Li-Ion battery with BLE beacon is an available option.



**NOTE:** The Secondary BLE beaconing functions only if the rechargeable Li-Ion battery with BLE beacon is in the device before it is powered off.

**Figure 5** Rechargeable Li-Ion Battery with BLE Beacon with a Bluetooth Logo



The Secondary BLE settings are controlled by the operating system of the device. For more information on configuring the Secondary BLE settings, see [techdocs.zebra.com/emdk-for-android/13-0/mx/beaconmgr/](http://techdocs.zebra.com/emdk-for-android/13-0/mx/beaconmgr/).



**IMPORTANT:** Power on the device after installing the rechargeable Li-Ion battery with BLE beacon to ensure the operating system transfers the Secondary BLE settings to the battery.

For the rechargeable Li-Ion battery with BLE to work properly:

- It transmits a Bluetooth signal (beacon) only when the device is powered off or in Airplane mode (disabled by default).
- It must be in the device for the rechargeable Li-Ion battery with BLE beacon to transmit a signal (beacon).
- It transmits a BLE signal for at least seven days after the device is powered off due to battery depletion.

## Replacing the Battery

This section describes replacing the battery for both gun and straight shooter configurations.

### Replacing the Gun Battery

This section describes replacing the battery in the gun configuration.

1. Loosen the hand strap if needed.

2. Push in the two battery release buttons.

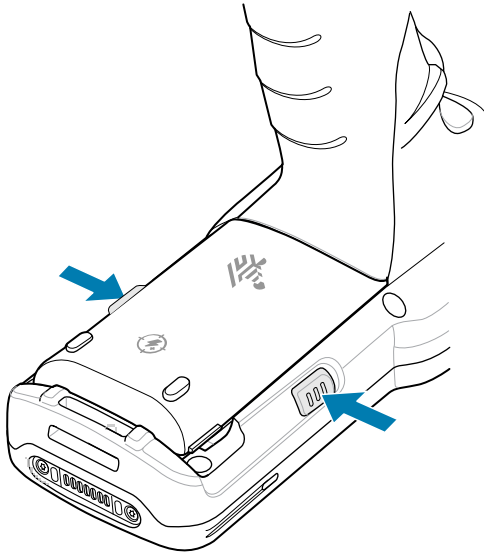

The battery ejects slightly.



**NOTE:** With Hot Swap mode, when you remove the battery, the display turns off, and the device enters a low-power state. The MC34 supports wireless connectivity persistence for 30 seconds (indicated by flashing amber LEDs), followed by RAM data persistence for approximately five minutes. Replace the battery within five minutes to preserve memory persistence.

3. Remove the battery from the battery compartment.

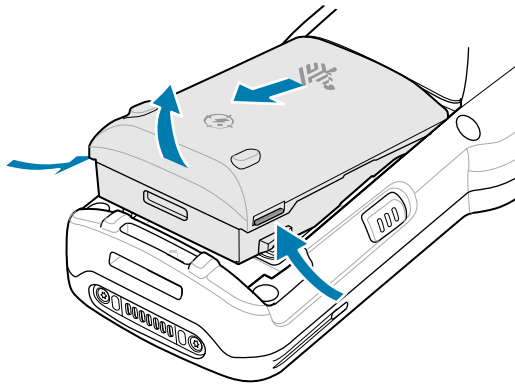

4. To install the battery, align the battery into the battery compartment.

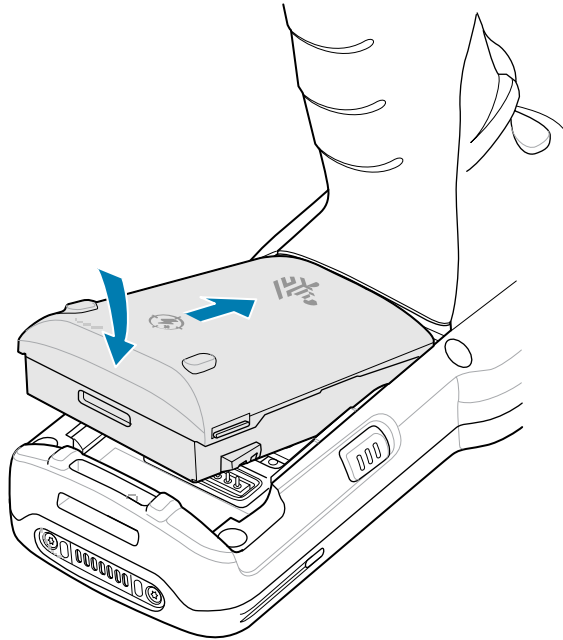

5. Slide the front of the battery into the battery compartment.

6. Press the battery down firmly.

Ensure that both the buttons on the sides of the device return to the home position.

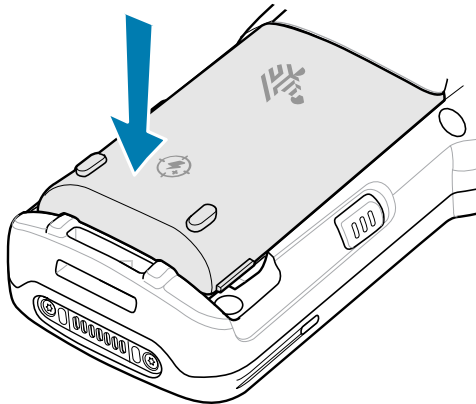

The device automatically resumes after battery removal and installation (in a Hot Swap change). The only time the Power key needs to be pressed is if the device has been powered off or left for a prolonged duration without a battery pack.

## Replacing the Straight Shooter Battery

This section describes replacing the battery in the straight shooter configuration.

1. Loosen the hand strap if needed.

2. Push in the two battery release buttons.

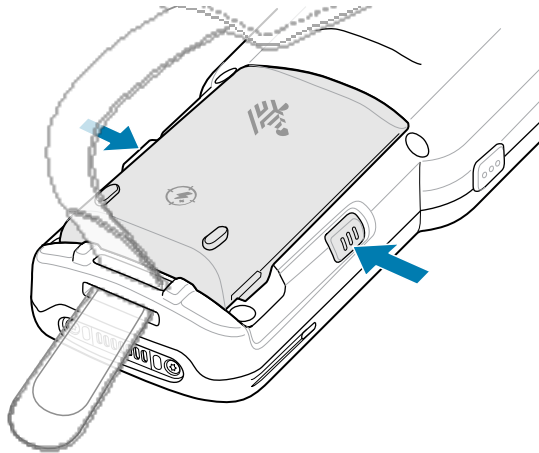

The battery ejects slightly.



**NOTE:** With Hot Swap mode, when you remove the battery, the display turns off, and the device enters a low-power state. The MC34 supports wireless connectivity persistence for 30 seconds (indicated by flashing amber LEDs), followed by RAM data persistence for approximately five minutes. Replace the battery within five minutes to preserve memory persistence.

3. Remove the battery from the battery compartment.

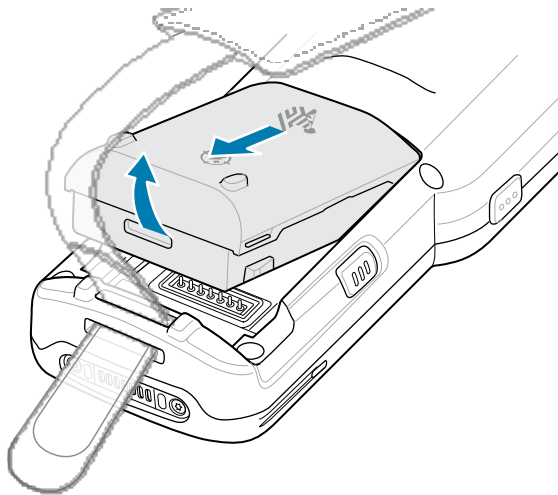

4. To install the battery, align the battery into the battery compartment.

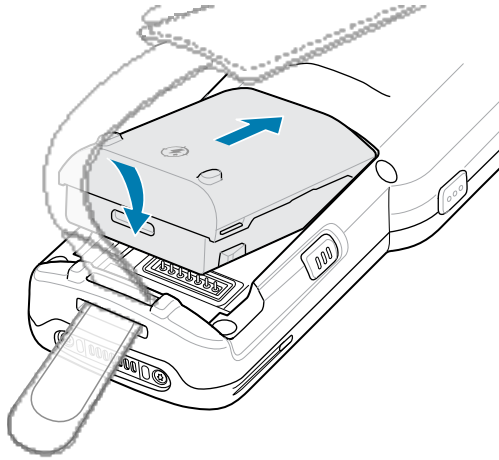

5. Slide the front of the battery into the battery compartment.
6. Press the battery down firmly.

Ensure that both the buttons on the sides of the device return to the home position.

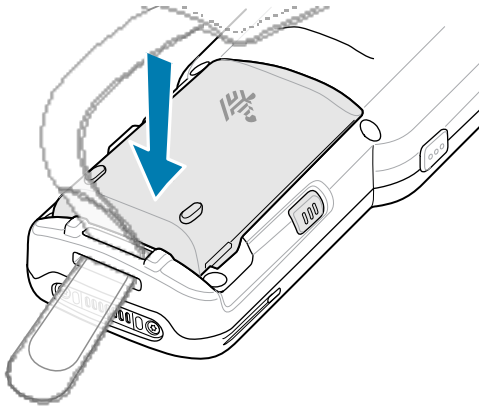

The device automatically resumes after battery removal and installation (in a Hot Swap change). The only time the Power key needs to be pressed is if the device has been powered off or left for a prolonged duration without a battery pack.

## Charging the Device

To achieve optimal charging results, use only Zebra charging accessories and batteries and charge batteries at room temperature.

A standard battery charges from fully depleted to 90% in approximately four hours and from fully depleted to 100% in approximately five hours. In many cases, a 90% charge provides enough charge for daily use. Depending on the usage profile, a full 100% charge may last for approximately 20 hours of use.



**NOTE:** Ensure that you follow the guidelines for battery safety in the Product Reference Guide.

The device or accessory always performs battery charging in a safe and intelligent manner and indicates when charging is disabled due to abnormal temperatures via its LED, and a notification appears on the device display.

Temperature	Battery Charging Behavior
0°C to 45°C (32°F to 113°F)	Optimal charging range.
Below 0°C (32°F) Above 45°C (113°F)	Charging stops.
Above 58°C (136°F)	The device shuts down.

To charge the main battery:

1. Connect the charging accessory to the appropriate power source.
2. Insert the device into a charging cradle slot or connect a USB-C cable to the power source.  
The device turns on and begins charging. The charging/notification LED indicates the battery charging status.
3. When charging is complete, remove the device from the cradle slot or unplug the USB-C cable.

## Charging the Spare Battery

To achieve optimal charging results, use only Zebra charging accessories and batteries.

1. Connect the charger to a power source.
2. Insert the battery into a spare battery charging slot and gently press down on the battery to ensure proper contact.  
The spare battery charging LEDs on the front of the cradle indicate the spare battery charging status.
3. Remove the battery from the charging slot when charging is complete.

## Charging Indicators

The Charge LED Indicator indicates the charge status.

**Table 1** LED Charge Indicators

Status	Indications
Off	<ul style="list-style-type: none"> <li>• The battery is not charging.</li> <li>• The device is not inserted correctly in the cradle or connected to a power source.</li> <li>• The device is not powered.</li> </ul>
Blinking Amber	Active wireless connectivity session during battery hot swap.
Solid Amber	Battery is charging.
Solid Green	Battery charging is complete.

**Table 1** LED Charge Indicators (Continued)

Status	Indications
Fast Blinking Red / 2 blinks per second	Charging error. For example: <ul style="list-style-type: none"> <li>Temperature is too low or too high.</li> <li>Charging has gone on too long without completion (typically 8 hours).</li> </ul>
Solid Red	<ul style="list-style-type: none"> <li>Spare battery is charging and at the end of its useful life.</li> <li>Charging is complete, and the battery is at the end of its useful life.</li> </ul>
Blinking Blue	Indicates an application notification is received.

## Accessories for Charging

Use one of the following accessories to charge the device and/or spare battery.

### Charging and Communication

Description	Part Number	Charging		Communication	
		Battery (In device)	Spare Battery	USB	Ethernet
1-Slot USB Charge Cradle with Spare Battery Charger	CRD-MC33-2SUCHG-01	Yes	Yes	Yes	No
5-Slot Charge Only ShareCradle	CRD-MC33-5SCHG-01	Yes	No	No	No
5-Slot Ethernet ShareCradle	CRD-MC33-5SETH-01	Yes	No	No	Yes
5-Slot Charge ShareCradle with 4-Slot Battery Charger	CRD-MC33-4SC4BC-01	Yes	Yes	No	No
5-Slot Ethernet ShareCradle with 4-Slot Battery Charger	CRD-MC33-4SE4BC-01	Yes	Yes	No	Yes
4-Slot Spare Battery Charger	SAC-MC33-4SCHG-01	No	Yes	No	No
20-Slot Spare Battery Charger	SAC-MC33-20SCHG-01	No	Yes	No	No
USB Charge Cable	CBL-MC33-USBCHG-01	Yes	No	Yes	No



**NOTE:** The recommended charging method for the MC34 devices is using a charging cradle, as it is faster than other charging options

### 1-Slot USB Charge Cradle with Spare Battery Charger

The 1-Slot USB Charge Cradle simultaneously charges the main and spare battery.



**CAUTION:** Ensure that you follow the guidelines for battery safety described in the Product Reference Guide.

The 1-Slot USB Charge Cradle:

- Provides 9 VDC power for charging the mobile computer and the battery.
- Provides 4.2 VDC power to charge the spare battery.
- Provides a USB port for data communication between the mobile computer and a host computer or other USB devices (for example, a laptop or printer).
- Synchronizes information between the mobile computer and a host computer. With customized or third-party software, it can also synchronize the mobile computer with corporate databases.
- Compatible with the following batteries:
  - 7,000 mAh PowerPrecision+ battery with a BLE beacon
  - 7,000 mAh PowerPrecision+ battery
  - 5,200 mAh PowerPrecision+ battery

**Figure 6** 1-Slot USB Charge Cradle with Spare Battery Charger

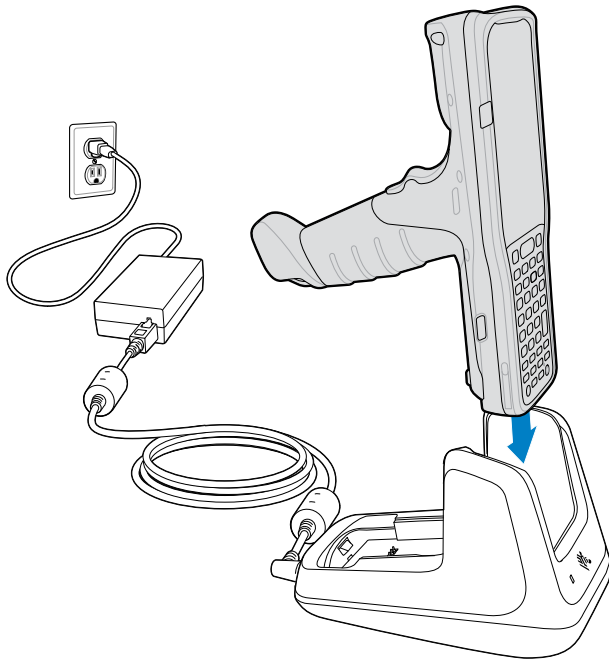

**Figure 7** Spare Battery Charging

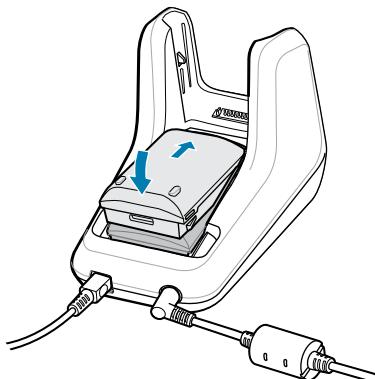



## 5-Slot Charge Only ShareCradle

The 5-Slot Charge Only ShareCradle simultaneously charges up to five devices.



**CAUTION:** Ensure that you follow the guidelines for battery safety described in the Product Reference Guide.

The 5-Slot Charge Only Cradle provides 9 VDC power for charging the mobile computer and battery.

**Figure 8** 5-Slot Charge Only ShareCradle

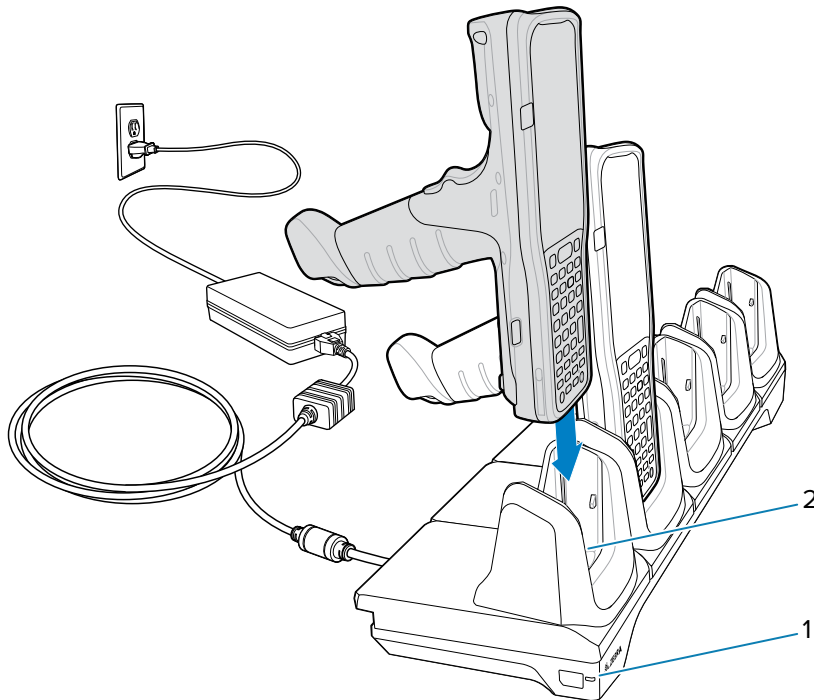

1	Power LED
2	Charging Slot

## 5-Slot Ethernet ShareCradle

The 5-Slot Ethernet ShareCradle simultaneously charges up to five devices and provides Ethernet communication.



**CAUTION:** Ensure that you follow the guidelines for battery safety described in the Product Reference Guide.

The 5-Slot Ethernet ShareCradle provides 9 VDC power for charging the mobile computer and battery.

**Figure 9** 5-Slot Ethernet ShareCradle

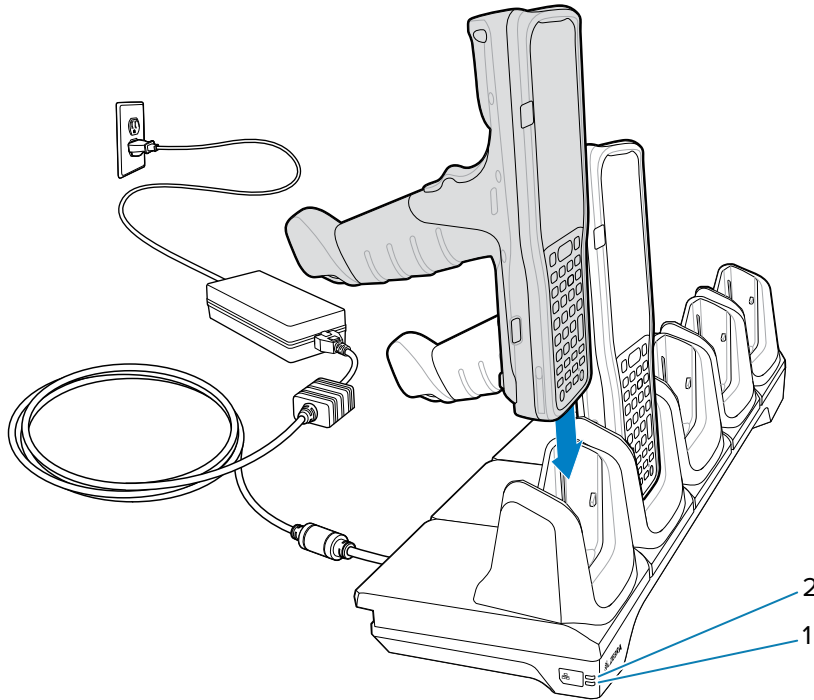

1	1000 LED
2	10/100 LED

## 5-Slot ShareCradle with 4-Slot Battery Charger

The 5-Slot ShareCradle with 4-Slot Battery Charger charges up to four devices and up to four spare batteries on the same cradle.



**CAUTION:** Ensure that you follow the guidelines for battery safety described in the Product Reference Guide.

The 5-Slot ShareCradle with 4-Slot Battery Charger:

- Provides 9 VDC power for charging the mobile computer and the battery.
- Provides 4.2 VDC power to charge the spare battery.
- Compatible with the following batteries:
  - 7,000 mAh PowerPrecision+ battery with a BLE beacon
  - 7,000 mAh PowerPrecision+ battery
  - 5,200 mAh PowerPrecision+ battery

**Figure 10** 5-Slot Charge ShareCradle with 4-Slots for Batteries

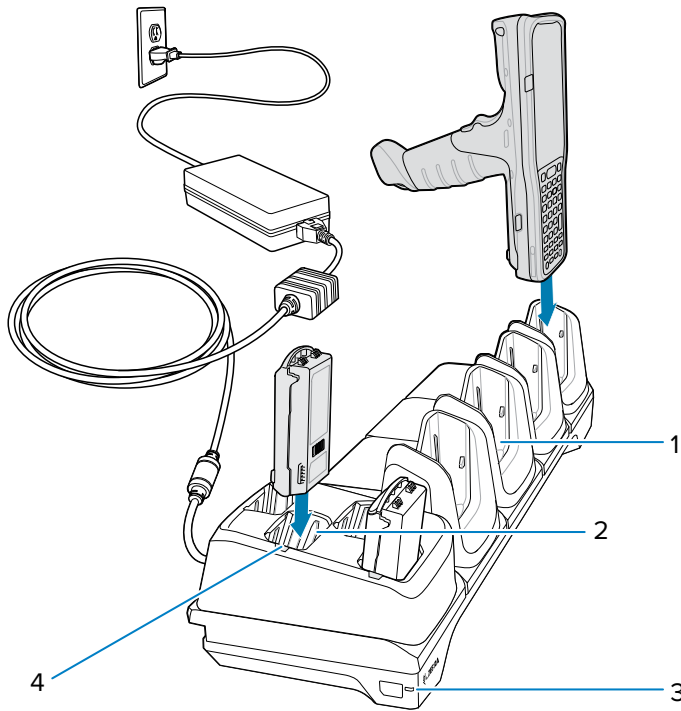

1	Charging slot
2	Spare battery slot
3	Power LED
4	Spare battery charging LED

## 5-Slot Ethernet ShareCradle with 4-Slot Battery Charger

The 5-Slot Ethernet ShareCradle with 4-Slot Battery Charger charges up to four devices and up to four spare batteries on the same cradle and provides Ethernet communication.



**CAUTION:** Ensure that you follow the guidelines for battery safety described in the Product Reference Guide.

The 5-Slot Ethernet ShareCradle with 4-Slot Battery Charger:

- Provides 9 VDC power for charging the mobile computer and charging the battery.
- Provides 4.2 VDC power to charge the spare battery.
- Compatible with the following batteries:
  - 7,000 mAh PowerPrecision+ battery with a BLE beacon
  - 7,000 mAh PowerPrecision+ battery
  - 5,200 mAh PowerPrecision+ battery

**Figure 11** 5-Slot Ethernet ShareCradle with 4-Slots for Batteries

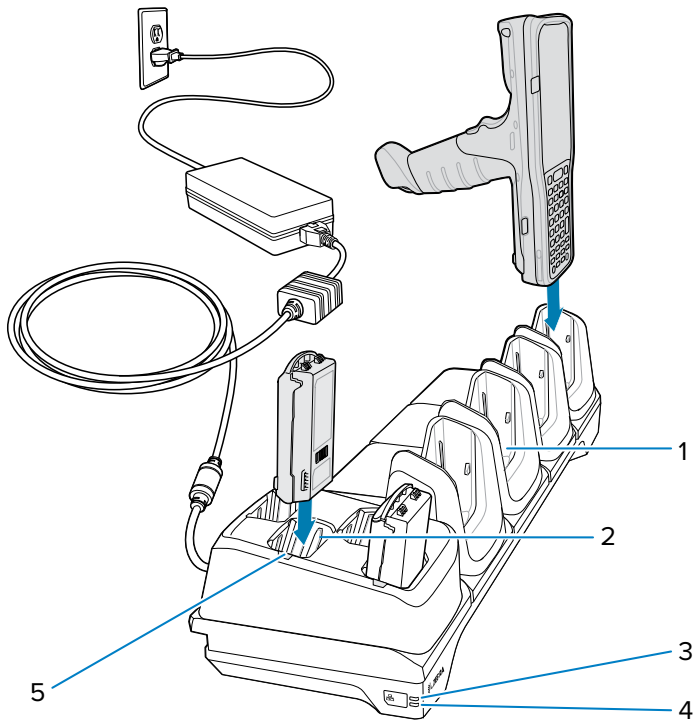

1	Charging slot
2	Spare battery slot
3	1000 LED
4	10/100 LED
5	Spare battery charging LED

## 4-Slot Spare Battery Charger

The 4-Slot Spare Battery Charger simultaneously charges up to four batteries.



**CAUTION:** Ensure that you follow the guidelines for battery safety described in the Product Reference Guide.

The 4-Slot Spare Battery Charger:

- Provides 4.2 VDC power to charge the spare battery.
- Compatible with the following batteries:
  - 7,000 mAh PowerPrecision+ battery with a BLE beacon
  - 7,000 mAh PowerPrecision+ battery
  - 5,200 mAh PowerPrecision+ battery

**Figure 12** 4-Slot Spare Battery Charger

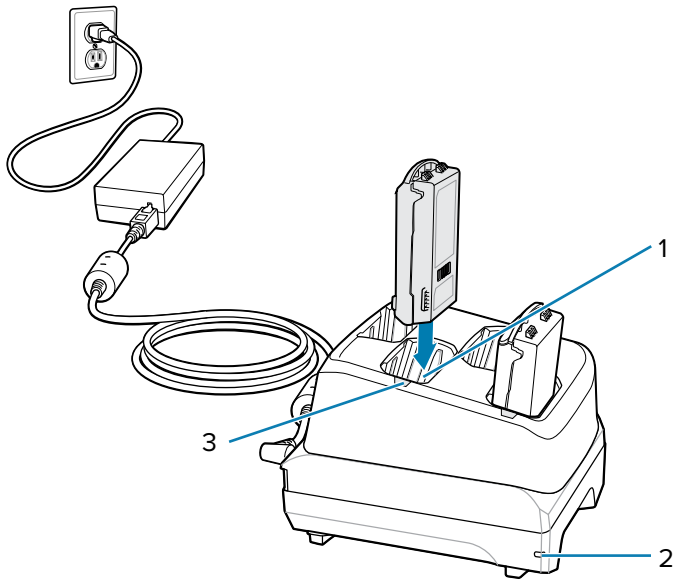

1	Spare battery charging slot
2	Power LED
3	Spare battery charging LED

## 20-Slot Spare Battery Charger

The 20-Slot Spare Battery Charger simultaneously charges up to 20 spare batteries.



**CAUTION:** Ensure that you follow the guidelines for battery safety described in the Product Reference Guide.

The 4-Slot Spare Battery Charger:

- Provides 4.2 VDC power to charge the spare battery.
- Compatible with the following batteries:
  - 7,000 mAh PowerPrecision+ battery with a BLE beacon
  - 7,000 mAh PowerPrecision+ battery
  - 5,200 mAh PowerPrecision+ battery

**Figure 13** 20-Slot Spare Battery Charger

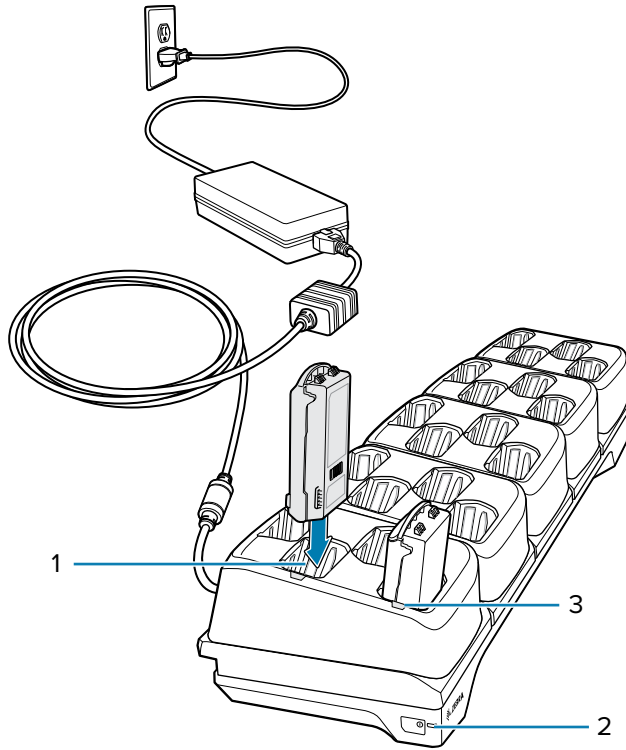

1	Spare battery charging slot
2	Power LED
3	Spare battery charging LED

## USB Connection

There are two methods for USB connection: The USB cradle via the bottom connector and the USB-C port on the side of the device.

- The device is designed for only one USB connection at any given time, either using the bottom USB connector via a charging/communication cradle or the side USB-C connector.
- Simultaneous connections via both bottom and side USB connections are not supported.
- If you attempt to connect via both the bottom and side USB-C at the same time, the bottom USB host will establish the connection, and the side USB-C will not.
- However, if the device is in a charge-only cradle via the bottom connector, the USB-C is still available for connection.

## USB Charging Cable

The USB Cradle provides charging when using a PowerPrecision+ battery and a wall adapter. It also allows USB communication to the device when connected to a laptop/PC.



**CAUTION:** Ensure that you follow the guidelines for battery safety described in the Product Reference Guide.

The USB Charge Cable:

- Provides 5 VDC power to charge the spare battery.
- Provides power and/or communication with the host computer over USB to the device.
- Compatible with the following batteries:
  - 7,000 mAh PowerPrecision+ extended capacity battery with a BLE beacon
  - 7,000 mAh PowerPrecision+ extended capacity battery
  - 5,200 mAh PowerPrecision+ high-capacity battery

**Figure 14** USB Charge Cable Connecting to Device

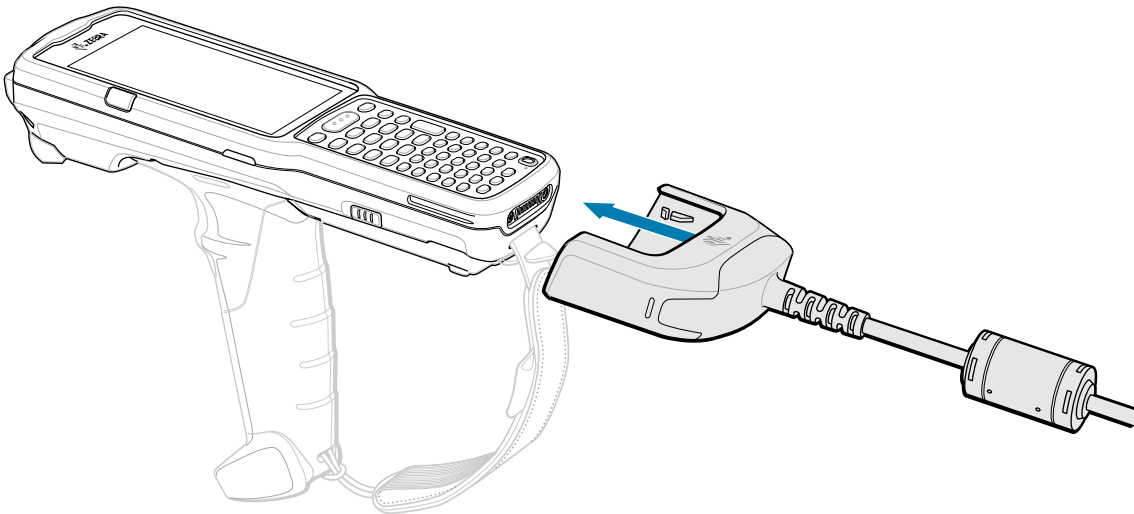

## USB-C Cable

The USB-C Cable connects to the left side of the device, provides communication with the host computer, and is removed easily when not in use.

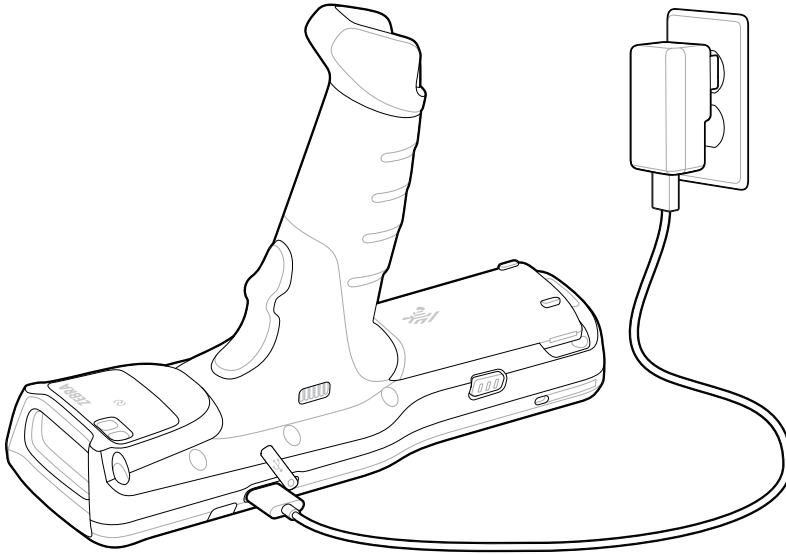

**NOTE:** The recommended charging method for the MC34 devices is using a charging cradle, as it is faster than other charging options. If you charge the device using the USB-C cable, ensure the bottom connector is not connected to any charging accessories.

**Figure 15** USB Charging

## Scanning

The MC3400 and MC3450 have internal imagers to capture data.

The following are the data capture options (based on the configuration):

- SE4710
- SE4770
- SE55
- SE58

Refer to the Product Reference Guide for other scanning options.

### Scanning with the Internal Imager

To read a barcode, a scan-enabled application is required. The device contains the DataWedge Demonstration (DWDemo) app, which enables the imager, decodes the barcode/QR code data, and displays barcode content.

1. Ensure that an application is open on the device, and a text field is in focus (the text cursor is in the text field).
2. Point the exit window on the top of the device at a barcode or QR code.



3. Press and hold the scan button.

The device projects the aiming pattern.

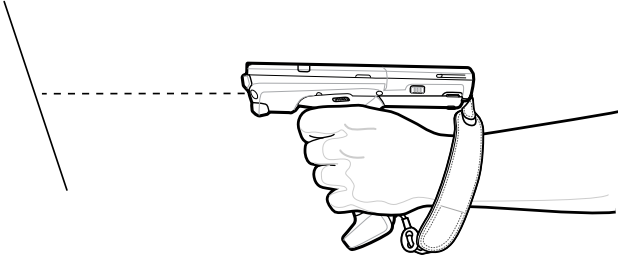

**NOTE:** Imager decoding usually occurs automatically. When the device is in Picklist mode, the imager does not decode the barcode until the red or green crosshair touches the barcode.

4. Ensure that the barcode is within the area formed in the aiming pattern.

**Figure 16** Aiming Patterns

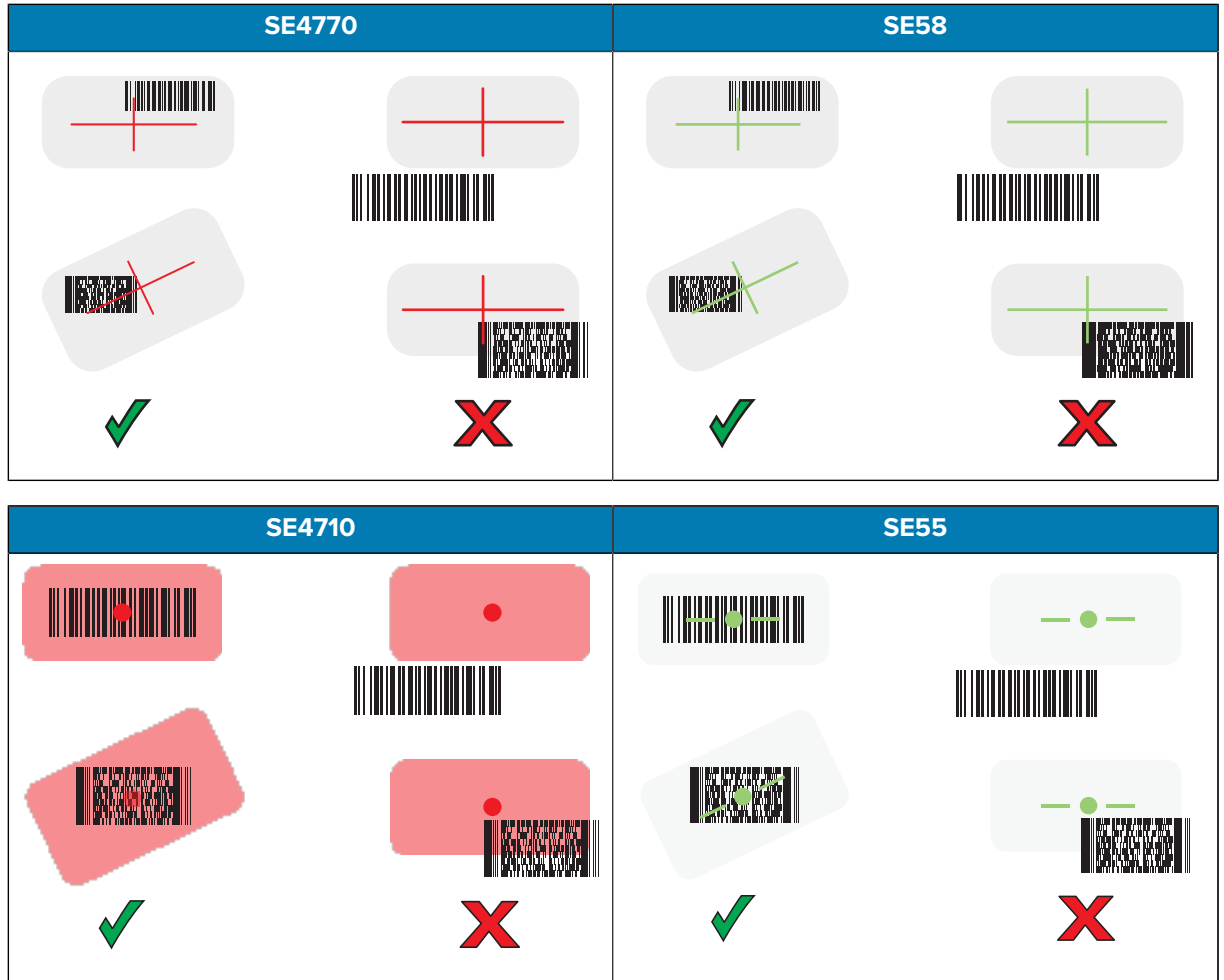

**Figure 17** Picklist Mode with Multiple Barcodes in Aiming Pattern

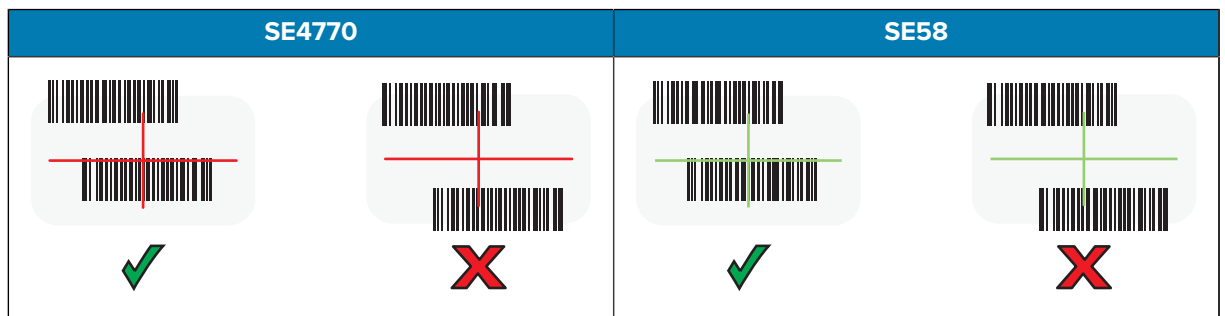

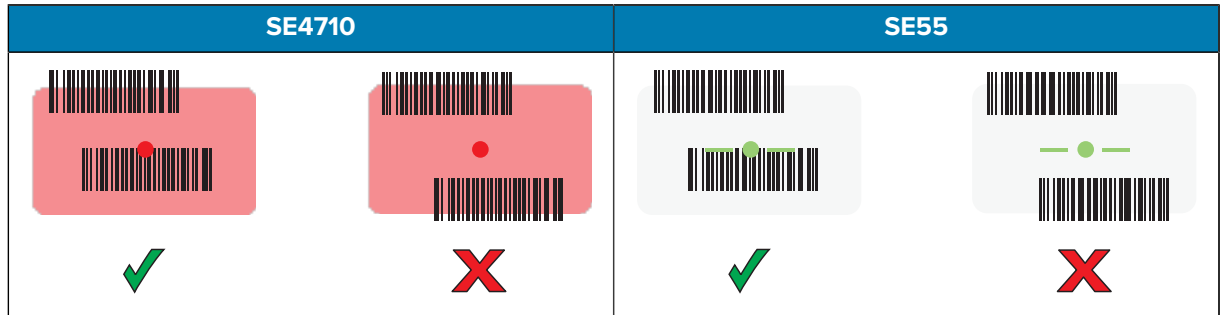

The Data Capture LED lights up, and the device beeps, by default, to indicate that the barcode was decoded successfully.



**NOTE:** The device repeats the steps required to take a digital picture (image) of a poor or difficult barcode as long as the scan button remains pressed.

5. Release the scan button.

The device displays the barcode data in the text field.

## Ergonomic Considerations

Taking breaks and task rotation are recommended.

### Optimum Body Posture

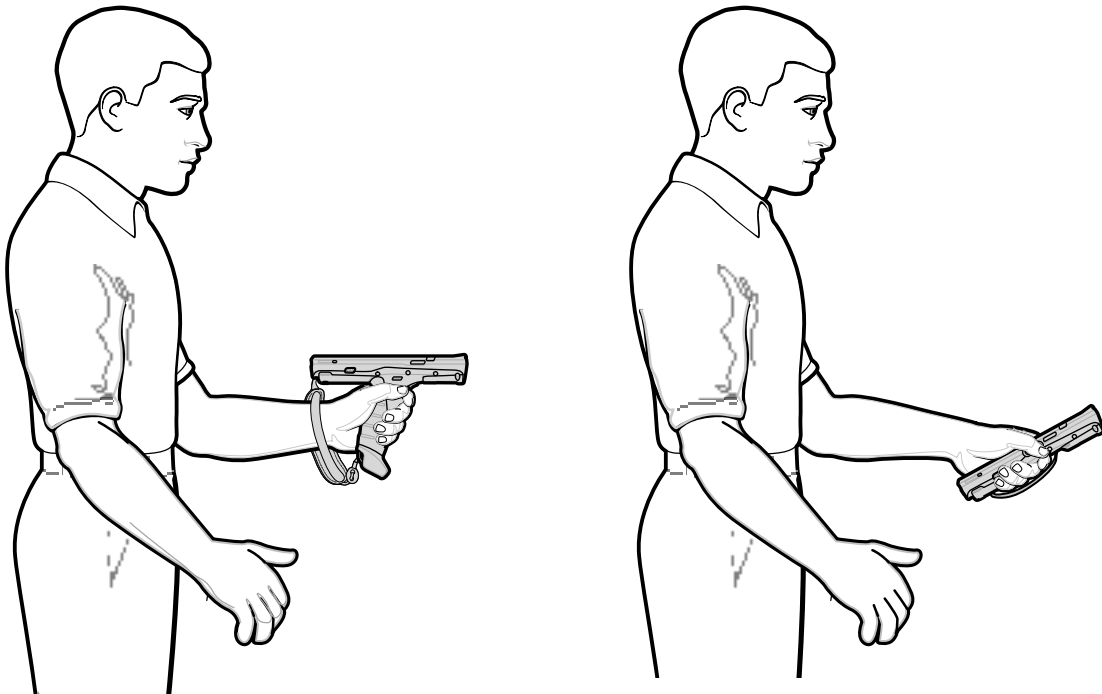

**Optimize Body Posture for High-Scanning**

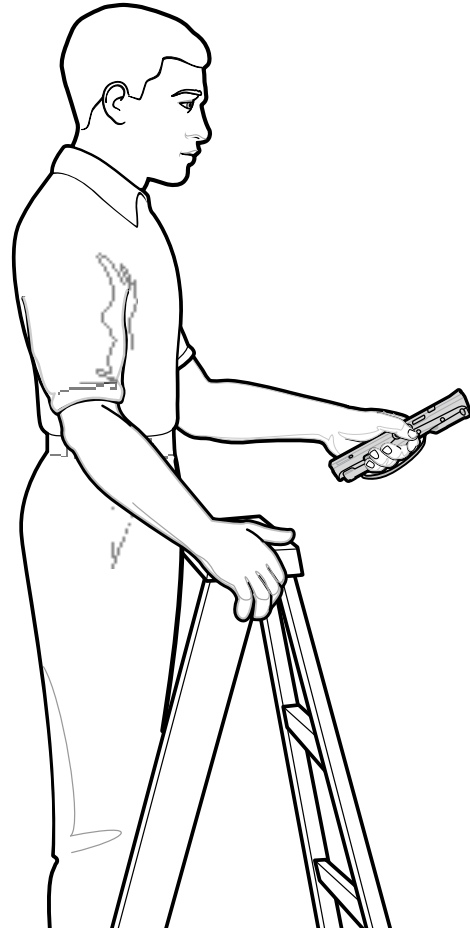

**Avoid Bending**



**Avoid Reaching**



**Avoid Extreme Wrist Angles**

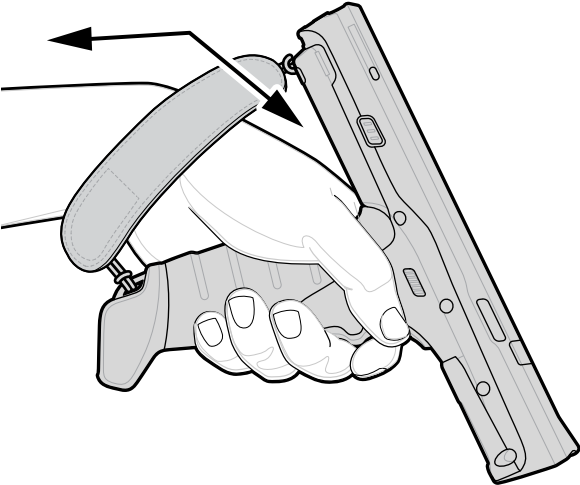
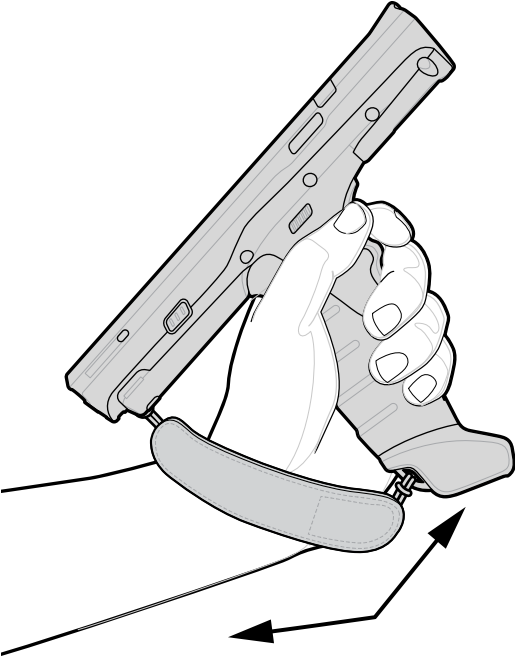

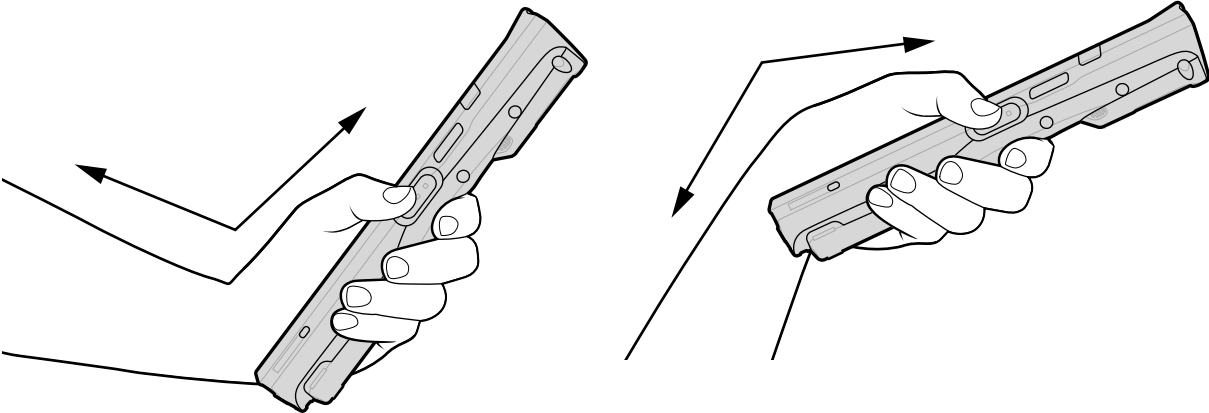

**Service Information**

Repair services using Zebra-qualified parts are available for at least five years after the end of production and can be requested at [zebra.com/support](http://zebra.com/support).

